

# 2010 HUMMER H3/H3T Owner Manual

<b>In Brief</b> .....	1-1	<b>Storage</b> .....	4-1	<b>Driving and Operating</b> .....	9-1
Instrument Panel .....	1-2	Storage Compartments .....	4-1	Driving Information .....	9-2
Initial Drive Information .....	1-3	Additional Storage Features .....	4-2	Starting and Operating .....	9-33
Vehicle Features .....	1-13	Roof Rack System .....	4-4	Engine Exhaust .....	9-40
Performance and Maintenance .....	1-16	<b>Instruments and Controls</b> .....	5-1	Automatic Transmission .....	9-41
<b>Keys, Doors and Windows</b> .....	2-1	Controls .....	5-2	Manual Transmission .....	9-44
Keys and Locks .....	2-2	Warning Lights, Gauges, and Indicators .....	5-6	Drive Systems .....	9-46
Doors .....	2-7	Information Displays .....	5-18	Brakes .....	9-50
Vehicle Security .....	2-9	Vehicle Messages .....	5-21	Ride Control Systems .....	9-52
Exterior Mirrors .....	2-13	Universal Remote System .....	5-26	Cruise Control .....	9-57
Interior Mirrors .....	2-14	<b>Lighting</b> .....	6-1	Object Detection Systems .....	9-60
Windows .....	2-15	Exterior Lighting .....	6-1	Fuel .....	9-64
Roof .....	2-17	Interior Lighting .....	6-7	Towing .....	9-70
<b>Seats and Restraints</b> .....	3-1	Lighting Features .....	6-8	Conversions and Add-Ons .....	9-81
Head Restraints .....	3-2	<b>Infotainment System</b> .....	7-1	<b>Vehicle Care</b> .....	10-1
Front Seats .....	3-3	Introduction .....	7-1	General Information .....	10-2
Rear Seats .....	3-7	Radio .....	7-5	Vehicle Checks .....	10-4
Safety Belts .....	3-10	Audio Players .....	7-10	Headlamp Aiming .....	10-33
Airbag System .....	3-27	Phone .....	7-15	Bulb Replacement .....	10-35
Child Restraints .....	3-42	<b>Climate Controls</b> .....	8-1	Electrical System .....	10-38
		Climate Control Systems .....	8-1	Wheels and Tires .....	10-44
		Air Vents .....	8-4	Jump Starting .....	10-86
				Towing .....	10-90
				Appearance Care .....	10-92

# 2010 HUMMER H3/H3T Owner Manual

---

<b>Service and Maintenance</b> . . .	11-1
General Information . . . . .	11-1
Scheduled Maintenance . . . . .	11-2
Recommended Fluids, Lubricants, and Parts . . . . .	11-8
Maintenance Records . . . . .	11-11
<b>Technical Data</b> . . . . .	12-1
Vehicle Identification . . . . .	12-1
Vehicle Data . . . . .	12-2
<b>Customer Information</b> . . . . .	13-1
Customer Information . . . . .	13-1
Reporting Safety Defects . . . . .	13-13
Vehicle Data Recording and Privacy . . . . .	13-15
<b>Index</b> . . . . .	i-1

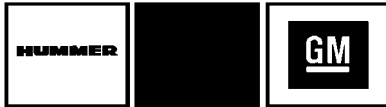

HUMMER, the HUMMER Emblem, H3 and H3T are trademarks of HUMMER LLC.

This manual describes features that may or may not be on your specific vehicle either because they are options that you did not purchase or due to changes subsequent to the printing of this owner manual. Please refer to the purchase documentation relating to your specific vehicle to confirm each of the features found on your vehicle. For vehicles first sold in Canada, substitute the name "General Motors of Canada Limited" for HUMMER wherever it appears in this manual.

Litho in U.S.A.  
Part No. 20935347 A First Printing

Keep this manual in the vehicle for quick reference.

## Canadian Vehicle Owners

### Propriétaires Canadiens

A French language copy of this manual can be obtained from your dealer or from:

On peut obtenir un exemplaire de ce guide en français auprès du concessionnaire ou à l'adresse suivante:

Helm, Incorporated  
P.O. Box 07130  
Detroit, MI 48207

1-800-551-4123  
Numéro de poste 6438 de  
langue française  
[www.helminc.com](http://www.helminc.com)

## Using this Manual

To quickly locate information about the vehicle use the Index in the back of the manual. It is an alphabetical list of what is in the manual and the page number where it can be found.

## Danger, Warnings, and Cautions

Warning messages found on vehicle labels and in this manual describe hazards and what to do to avoid or reduce them.

**Danger** indicates a hazard with a high level of risk which will result in serious injury or death.

**Warning** or **Caution** indicates a hazard that could result in injury or death.

### **WARNING**

These mean there is something that could hurt you or other people.

**Notice:** This means there is something that could result in property or vehicle damage. This would not be covered by the vehicle's warranty.





A circle with a slash through it is a safety symbol which means "Do Not," "Do not do this" or "Do not let this happen."

## Symbols

The vehicle has components and labels that use symbols instead of text. Symbols are shown along with

the text describing the operation or information relating to a specific component, control, message, gauge, or indicator.

 : This symbol is shown when you need to see your owner manual for additional instructions or information.

 : This symbol is shown when you need to see a service manual for additional instructions or information.

### Vehicle Symbol Chart

Here are some additional symbols that may be found on the vehicle and what they mean. For more information on the symbol, refer to the index.

 : Airbag Readiness Light

 : Air Conditioning

 : Antilock Brake System (ABS)

 : Audio Steering Wheel Controls or OnStar<sup>®</sup>

 : Brake System Warning Light

 : Charging System

 : Cruise Control

 : Engine Coolant Temperature

 : Exterior Lamps

 : Fog Lamps

 : Fuel Gauge

 : Fuses

 : Headlamp High/Low-Beam Changer

 : LATCH System Child Restraints

 : Malfunction Indicator Lamp

 : Oil Pressure

 : Power

 : Remote Vehicle Start

 : Safety Belt Reminders

 : Tire Pressure Monitor

 : Traction Control/StabiliTrak

 : Windshield Washer Fluid

## In Brief

### Instrument Panel

Instrument Panel ..... 1-2

### Initial Drive Information

Initial Drive Information ..... 1-3

Remote Keyless Entry (RKE)

System ..... 1-4

Door Locks ..... 1-4

Tailgate ..... 1-5

Windows ..... 1-6

Seat Adjustment ..... 1-7

Heated Seats ..... 1-8

Head Restraint Adjustment .... 1-8

Safety Belt ..... 1-8

Sensing System for Passenger

Airbag ..... 1-9

Mirror Adjustment ..... 1-9

Steering Wheel

Adjustment ..... 1-10

Interior Lighting ..... 1-10

Exterior Lighting ..... 1-11

Washer and Wiper

Systems ..... 1-11

Climate Controls ..... 1-12

Transmission ..... 1-12

### Vehicle Features

Radio(s) ..... 1-13

Satellite Radio ..... 1-14

Bluetooth® ..... 1-15

Navigation System ..... 1-15

Cruise Control ..... 1-15

Storage Compartments ..... 1-15

Power Outlets ..... 1-16

Sunroof ..... 1-16

### Performance and Maintenance

Traction Control

System (TCS) ..... 1-16

StabiliTrak® ..... 1-17

Tire Pressure Monitor ..... 1-17

Engine Oil Life System ..... 1-18

Fuel E85 (85% Ethanol) ..... 1-18

Driving for Better Fuel

Economy ..... 1-18

Roadside Service ..... 1-19

OnStar® ..... 1-19

## Instrument Panel

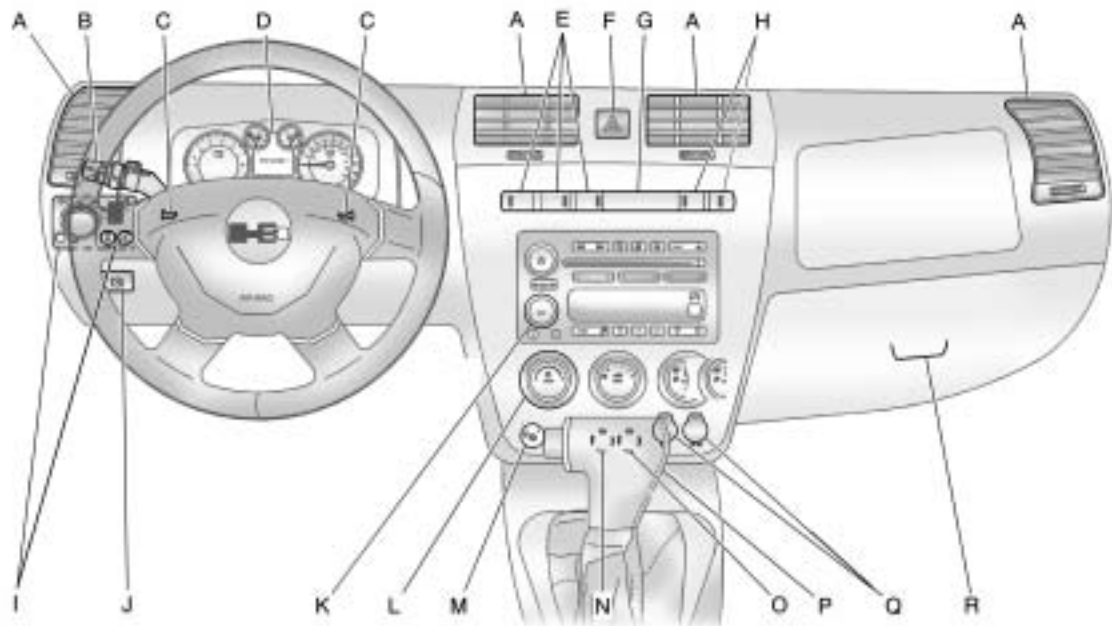

Automatic Transmission shown, Manual Transmission similar

- A. *Air Vents on page 8-4.*
- B. *Turn and Lane-Change Signals on page 6-5. Windshield Wiper/Washer on page 5-2. Cruise Control on page 9-57.*
- C. *Horn on page 5-2.*
- D. *Instrument Cluster on page 5-7.*
- E. *Four-Wheel Drive on page 9-46.*
- F. *Hazard Warning Flashers on page 6-5.*
- G. *Passenger Airbag Status Indicator on page 5-11.*
- H. *Locking Rear Axle on page 9-54. Locking Front Axle (If Equipped) or Traction Control System (TCS) on page 9-52.*
- I. *Exterior Lamp Controls on page 6-1. Dome Lamp Override. See Dome Lamps on page 6-7. Instrument Panel Illumination Control on page 6-7. Fog Lamps on page 6-6.*
- J. *Parking Brake on page 9-51.*
- K. *AM-FM Radio on page 7-5.*
- L. *Climate Control Systems on page 8-1.*
- M. *Rear Window Wiper/Washer on page 5-3 (If Equipped).*
- N. *Traction Control System (TCS) on page 9-52 (For vehicles with Locking Front Axle).*
- O. *Off-Road Lamps on page 6-6.*
- P. *Shift Lever. See Automatic Transmission on page 9-41 or Manual Transmission on page 9-44.*
- Q. *Power Outlets on page 5-5.*
- R. *Glove Box on page 4-1.*

## Initial Drive Information

This section provides a brief overview about some of the important features that may or may not be on your specific vehicle.

For more detailed information, refer to each of the features which can be found later in this owner manual.

## Remote Keyless Entry (RKE) System



The RKE transmitter is used to remotely lock and unlock the doors from up to 9 m (30 feet) away from the vehicle.



Press UNLOCK to unlock the driver door. Press again within three seconds to unlock all remaining doors.

Press LOCK to lock all doors.

Lock and unlock feedback can be personalized.

Press  to sound the horn and to flash the exterior lamps for 30 seconds. Press  again to cancel the panic alarm.

See *Remote Keyless Entry (RKE) System Operation* on page 2-3.

## Door Locks

Unlock the doors from outside the vehicle by using the key in the door, or by pressing the UNLOCK button on the Remote Keyless Entry (RKE) transmitter.

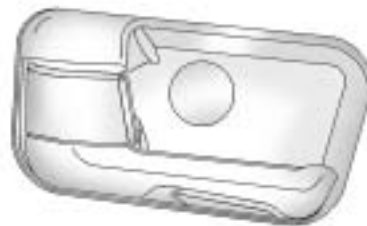

From inside, use the manual lock lever, or the power door lock switch.



## Power Door Locks



Press L (Lock) to lock the doors.

Press U (Unlock) to unlock the doors.

For more information, see:

- *Remote Keyless Entry (RKE) System Operation on page 2-3.*
- *Door Locks on page 2-4.*
- *Power Door Locks on page 2-5.*

## Tailgate

### Tailgate (H3T)



Open the tailgate by pulling up on the outside handle while pulling the tailgate down.

## Removing the Tailgate

To remove the tailgate:



1. Open the tailgate fully and remove the retainer clip from the driver's side hinge.

## 1-6 In Brief

- Lift up slightly on the entire tailgate assembly.

Remove the retaining cables from both sides of the pickup box by pulling the clips away from the bolt heads while pushing the cable bracket forward. When the larger part of the hole on the bracket is over the bolt, slide the bracket off of the bolt.

- With the tailgate partially down, lift up on the passenger's side and pull the tailgate toward you, then move the tailgate to the right to release the driver's side.

### Swing-gate (H3)

To lock or unlock the swing-gate, use the power door lock switch or the Remote Keyless Entry (RKE) transmitter.

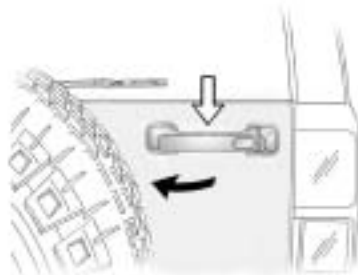

To open the swing-gate, use the door handle to pull the swing-gate rearward slightly so it opens automatically.

See *Tailgate* on page 2-7.

### Windows

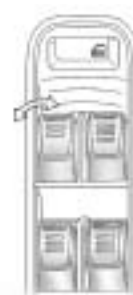

On vehicles with power windows, the switches are on the driver door armrest. The passenger door has a switch that controls only that window.

Press the front of the switch to open the window. Pull the switch up to close it.

For more information, see *Power Windows* on page 2-16.

## Seat Adjustment



1. Lift the handle under the seat to unlock the seat.
2. Slide the seat to the desired position and release the handle.
3. Try to move the seat to be sure it is locked in place.

See *Seat Adjustment* on page 3-3.



Move the seat forward or rearward by moving the control forward or rearward

Raise or lower the seat by moving the control up or down.

See *Power Seat Adjustment* on page 3-3.

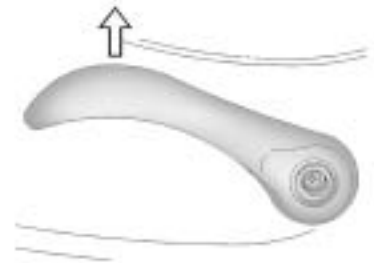

To recline the seatback lift the lever and move the seatback. To raise the seatback lift the lever without applying pressure to the seatback.

See *Reclining Seatbacks* on page 3-4.



Press the front or rear of the power lumbar control to increase or decrease lumbar support.

See *Lumbar Adjustment* on page 3-4.

## Heated Seats

### Heated Front Seats

The heated seat controls are located on the center console. The engine must be running to operate them.

 : Press to turn on the heated seatback.

 : Press to turn on or off the heated seat and seatback.

For more information see *Heated Front Seats* on page 3-6.

### Head Restraint Adjustment

Do not drive until the head restraints for all occupants are installed and adjusted properly.

For more information, see *Head Restraints* on page 3-2.

## Safety Belt



Refer to the following sections for important information on how to use safety belts properly.

- *Safety Belts* on page 3-10.
- *How to Wear Safety Belts Properly* on page 3-15.
- *Lap-Shoulder Belt* on page 3-20.
- *Lower Anchors and Tethers for Children (LATCH System)* on page 3-51.

## Sensing System for Passenger Airbag

PASSENGER AIR BAG  
 (ON)  OFF

United States



Canada

The passenger sensing system will turn off the right front passenger frontal airbag under certain conditions. The driver airbag and roof-rail airbags (if equipped) are not affected by the passenger sensing system. See *Passenger Airbag Status Indicator* on page 5-11 for more information.

The passenger airbag status indicator will be visible on the instrument panel when the vehicle is started.

## Mirror Adjustment

### Exterior Mirrors

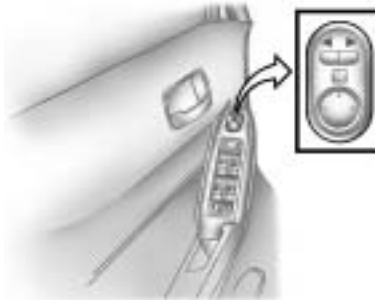

H3 shown, H3T similar

Controls for the outside power mirrors are located on the driver door.

To adjust the power mirrors:

1. Press the left or right side of the selector switch to choose the driver or passenger side mirror.
2. Press the round, four-way control pad to adjust the mirror.

### Interior Mirror

The vehicle has an automatic dimming rearview mirror with a compass and temperature display. Automatic dimming reduces the glare from the headlamps of the vehicle behind you. The dimming feature comes on and the indicator light illuminates each time the ignition is turned to start.

 : Press to turn the dimming feature and/or compass display on or off.

For more information, see

- *Automatic Dimming Rearview Mirror* on page 2-14.
- *Driver Information Center (DIC)* on page 5-18.

## Steering Wheel Adjustment

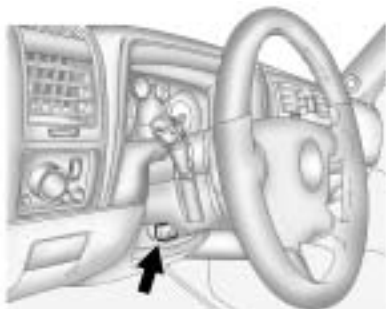

1. Hold the steering wheel and pull the lever towards you.
2. Move the steering wheel up or down into a comfortable position.
3. Release the lever to lock the steering wheel in place.

See *Steering Wheel Adjustment* on page 5-2.

## Interior Lighting

### Dome Lamps

The dome lamps are located in the front area of the vehicle. There is also a dome lamp in the cargo area of the H3 model only.

Turn the thumbwheel, located next to the exterior lamps control, all the way up to turn the dome and footwell lamps on.

The dome lamp in the cargo area automatically turns off when:

- The shift lever is shifted out of P (Park) (automatic transmissions).
- The parking brake is released (manual transmissions).

### Dome Lamp Override

✱ **(Dome Lamp Override):** The dome lamp override button is located below the exterior lamps control.

### Reading Lamps

Press the lens on the lamps to turn each reading lamp on or off.

These lamps will not come on with the dome lamps.

For more information, see:

- *Dome Lamps* on page 6-7.
- *Instrument Panel Illumination Control* on page 6-7.
- *Exit Lighting* on page 6-8.

## Exterior Lighting



○ : Turns off all exterior lamps including the Daytime Running Lamps (DRL).

**AUTO:** Automatic operation of the headlamps and other exterior lamps.

☸ : Manual operation of the parking lamps and other exterior lamps, except headlamps.

☾ : Manual operation of the headlamps and other exterior lamps.

For more information, see:

- *Exterior Lamp Controls on page 6-1.*
- *Daytime Running Lamps (DRL) on page 6-3.*
- *Fog Lamps on page 6-6.*
- *Automatic Headlamp System on page 6-4.*
- *Off-Road Lamps on page 6-6.*

## Washer and Wiper Systems



☾ : Use for a single wiping cycle.

! : Delays wiping cycle. Move the band to adjust the frequency of wipes.

▬ : Slow wipes.

● : Fast wipes.

○ : Turns the wipers off.

**Windshield Washer:** Push the paddle on top of the turn signal/lane change lever to spray washer fluid on the windshield.

See *Windshield Wiper/Washer on page 5-2* and *Rear Window Wiper/Washer on page 5-3*.

## Climate Controls

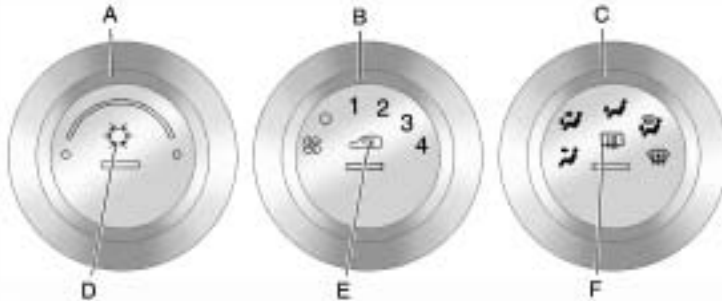

- A. Temperature Control
- B. Fan Control
- C. Air Delivery Mode Control
- D. Air Conditioning
- E. Air Recirculation
- F. Rear Window Defogger

See *Climate Control Systems* on page 8-1.

## Transmission

Full-Time Four-Wheel Drive sends engine power to all four wheels for extra traction.

## Transfer Case Buttons



The transfer case buttons are located to the right of the instrument panel cluster. Use these switches to shift into and out of the different Full-Time Four-Wheel Drive modes.

**4 ↑ (Four-Wheel High):** For driving in most street and highway situations.

**N (Neutral):** Shift the transfer case to Neutral only when towing the vehicle. See *Driving Characteristics and Towing Tips* on page 9-70.



**4 ↑ (Four-Wheel-High Lock):**

When extra traction is needed in most off-road situations.

**4 ↓ (Four-Wheel-Low Lock):**

Delivers extra torque to all four wheels. Used for extreme off-road conditions. See *Four-Wheel Drive* on page 9-46.

## Vehicle Features

### Radio(s)



**Six-Disc CD Radio**

For more information about these and other radio features, see *Operation* on page 7-2.

#### **Control Buttons**

**⏻ (Power/Volume):** Press to turn the system on and off.

Turn to increase or to decrease the volume.

**BAND:** Press to select FM1, FM2, AM, XM1, if equipped, or XM2, if equipped.

**DISP:** Turn to select a radio station.

**1-6 (Preset Pushbuttons):** Press to select preset stations.

**◀ SEEK ▶:** Press and release to go to the previous or next station and stay there. Press and hold to scan stations or preset stations.

### Setting the Clock

The clock can be set with the ignition on or off.

To set the clock:

1. Press and hold H until the correct hour and AM or PM displays.
2. Press and hold M until the correct minute displays.

Press DISP (Display) to display the time while the ignition is turned off.

### Setting Preset Stations

Up to 30 stations (six FM1, six FM2, and six AM, six XM1, if equipped, and six XM2, if equipped) can be programmed.

To program presets:

1. Turn the radio on.
2. Press BAND to select FM1, FM2, AM, or XM1 or XM2.
3. Tune in the desired station.
4. Press and hold one of the six numbered pushbuttons until the radio beeps once.
5. Repeat the steps for each pushbutton.

### Satellite Radio

Vehicles with an XM™ Satellite Radio tuner and a valid XM Satellite Radio subscription can receive XM programming.

### XM Satellite Radio Service

XM is a satellite radio service that is based in the 48 contiguous United States and 10 Canadian provinces. XM Satellite Radio has a wide variety of programming and commercial-free music, coast-to-coast, and in digital-quality sound. A fee is required to receive the XM service.

For more information refer to:

- [www.xmradio.com](http://www.xmradio.com) or call 1-800-929-2100 (U.S.).
- [www.xmradio.ca](http://www.xmradio.ca) or call 1-877-438-9677 (Canada).

See *Satellite Radio* on page 7-6.

## Bluetooth®

The in-vehicle Bluetooth system allows users with a Bluetooth-enabled cell phone to make and receive hands-free calls using the vehicle's audio system, microphone and controls.

The Bluetooth-enabled cell phone must be paired with the in-vehicle Bluetooth system before it can be used in the vehicle. Not all phones will support all functions.

See *Bluetooth* on page 7-15.

## Navigation System

The vehicle's navigation system provides detailed maps of most major freeways and roads throughout the United States and Canada. After a destination has been set, the system provides turn-by-turn instructions for reaching the destination. In addition, the system can help locate a variety of

points of interest (POI), such as banks, airports, restaurants, and more.

See the vehicle's Navigation System manual for more information.

## Cruise Control



The cruise controls are located at the end of the multifunction lever.

○: Turns the system off.

|: Turns the system on.

**+ (Resume/Accelerate):** Use to accelerate or resume speed.

**▶ (Set):** Press the button at the end of the lever to set the speed.

For more information, see *Cruise Control* on page 9-57.

## Storage Compartments

The vehicle comes with a cargo management system located in the rear of the vehicle. The system has three rails located on the front and sides of the bed.

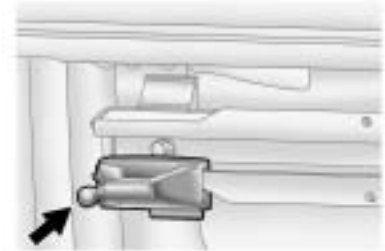

There are four adjustable cargo tie-downs, that can be placed on the upper and lower slides of the rail.

The cargo management system can be removed and re-installed into the vehicle.

For more information, see *Cargo Management System* on page 4-2.

## Power Outlets

The accessory power outlets can be used to connect auxiliary electrical equipment, such as a cellular phone.

There are two accessory power outlets located under the climate control system. There is also one accessory power outlet located in the rear cargo area (H3 model only).

To use the outlet, open the cover.

See *Power Outlets* on page 5-5 and *Cigarette Lighter* on page 5-5.

## Sunroof

### Sunroof

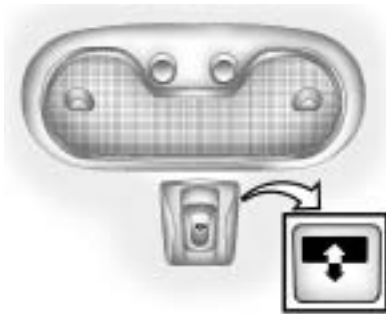



To open or close the sunroof, press the front or rear of the switch.

For more information see *Sunroof* on page 2-17.

## Performance and Maintenance

### Traction Control System (TCS)



The traction control system limits wheel spin. The system turns on automatically every time the vehicle is started.

- To turn off traction control, press and release the  button located on the Instrument panel.  illuminates and the appropriate DIC message is displayed. See *Vehicle Messages* on page 5-21.
- Press the button again to turn traction control back on.

For more information, see *Traction Control System (TCS)* on page 9-52.

## StabiliTrak®

Electronic stability control system assists with directional control of the vehicle in difficult driving conditions. The system turns on automatically every time the vehicle is started.

- To turn off both traction control and electronic stability control, press and hold  until  illuminates and the appropriate DIC message is displayed. See *Vehicle Messages on page 5-21*.
- Press the button again to turn on both systems.

For more information, see *StabiliTrak System on page 9-53*.

## Tire Pressure Monitor

This vehicle may have a Tire Pressure Monitor System (TPMS).



The Tire Pressure Monitor System alerts you when a significant reduction in pressure occurs in one or more of your vehicle's tires by illuminating the low tire pressure warning light on the instrument cluster. If the warning light comes on, stop as soon as possible and inflate the tires to the recommended pressure shown on the tire loading information label located on the driver side center pillar (B pillar). See *Vehicle Load Limits on page 9-27*. The warning light will remain on until the tire pressure is corrected.

You may notice during cooler conditions that the low tire pressure warning light will appear when the vehicle is first started and then turn off as you drive. This may be an early indicator that your tire pressures are getting low and the tires need to be inflated to the proper pressure.

The Tire Pressure Monitor System can alert you about low tire pressure, but it does not replace normal monthly tire maintenance. It is the driver's responsibility to maintain correct tire pressures.

See *Tire Pressure Monitor System on page 10-52* and *Tire Pressure Monitor Operation on page 10-53*.

### Engine Oil Life System

The engine oil life system calculates engine oil life based on vehicle use and displays a DIC message when it is necessary to change the engine oil and filter.

#### Resetting the Oil Life System

1. Turn the ignition to ON/RUN, with the engine off.
2. Press and release the stem in the lower center of the instrument cluster until the "Oil Life" message is displayed.
3. Once the alternating "Oil Life" and "Reset" messages appear, press and hold the stem until several beeps sound. This confirms that the oil life system has been reset.
4. Turn the key to LOCK/OFF.

See *Engine Oil Life System* on page 10-11.

### Fuel E85 (85% Ethanol)

Vehicles that have the 5.3L V8 engine (Code P) have a yellow fuel cap and can use either unleaded gasoline or ethanol fuel containing up to 85% ethanol (E85). See *Fuel E85 (85% Ethanol)* on page 9-66. In all other engines, use only the unleaded gasoline described under *Recommended Fuel* on page 9-64.

### Driving for Better Fuel Economy

Driving habits can affect fuel mileage. Here are some driving tips to get the best fuel economy possible.

- Avoid fast starts and accelerate smoothly.
- Brake gradually and avoid abrupt stops.

- Avoid idling the engine for long periods of time.
- When road and weather conditions are appropriate, use cruise control, if equipped.
- Always follow posted speed limits or drive more slowly when conditions require.
- Keep vehicle tires properly inflated.
- Combine several trips into a single trip.
- Replace the vehicle's tires with the same TPC Spec number molded into the tire's sidewall near the size.
- Follow recommended scheduled maintenance.

## Roadside Service

U.S.: **1-866-HUMMER6 (486-6376)**

TTY Users: **1-888-889-2438**

Canada: **1-800-268-6800**

As the owner of a new HUMMER, you are automatically enrolled in the Roadside Service program. This program provides technically trained advisors who are available 24 hours a day, 365 days a year, minor repair information or towing arrangements.

### Roadside Service and OnStar

If you have a current OnStar subscription, press the OnStar button and the current GPS location will be sent to an OnStar Advisor who will assess your problem, contact Roadside Assistance, and relay exact location to get you the help you need.

## Online Owner Center

The Owner Center is a complimentary service that includes online service reminders, vehicle maintenance tips, online owner manual, special privileges and more.

Sign up today at:  
**[www.gmownercenter.com/hummer](http://www.gmownercenter.com/hummer)** (U.S.).

## OnStar®





OnStar® uses several innovative technologies and live advisors to provide a wide range of safety, security, navigation, diagnostics, and calling services.

## Automatic Crash Response

In a crash, built in sensors can automatically alert an OnStar advisor who is immediately connected to the vehicle to see if you need help.

### How OnStar Service Works

 : This blue button connects you to a specially trained OnStar advisor to verify your account information and to answer questions.

 : Push this red emergency button to get priority help from specially trained OnStar emergency advisors.



 : Push this button for hands-free, voice-activated calling and to give voice commands for turn-by-turn navigation.

Crisis Assist, Stolen Vehicle Assistance, Vehicle Diagnostics, Remote Door Unlock, Roadside Assistance, Turn-by-Turn Navigation and Hands-Free Calling are available on most vehicles. Not all OnStar services are available on all vehicles. For more information see the OnStar Owner's Guide or visit [www.onstar.com](http://www.onstar.com) (U.S.) or [www.onstar.ca](http://www.onstar.ca) (Canada), contact OnStar at 1-888-4-ONSTAR (1-888-466-7827) or TTY 1-877-248-2080, or press  to speak with an OnStar advisor 24 hours a day, 7 days a week.

For a full description of OnStar services and system limitations, see the OnStar Owner's Guide in the glove box.

OnStar service is subject to the OnStar terms and conditions included in the OnStar Subscriber Information.

OnStar service cannot work unless the vehicle is in a place where OnStar has an agreement with a wireless service provider for service in that area. OnStar service also cannot work unless the vehicle is in a place where the wireless service provider OnStar has hired for that area has coverage, network capacity and reception when the service is needed, and technology that is compatible with the OnStar service. Not all services are available everywhere, particularly in remote or enclosed areas, or at all times.

The OnStar system can record and transmit vehicle information. This information is automatically sent to an OnStar call center when  is pressed,  is pressed, or if the airbags or ACR system deploy. This information usually includes the vehicle's GPS location and, in the event of a crash, additional information regarding the crash that the vehicle was involved in (e.g. the direction from which the vehicle was hit). When the virtual advisor feature of OnStar hands-free calling is used, the vehicle also sends OnStar the vehicle's GPS location so they can provide services where it is located.

Location information about the vehicle is only available if the GPS satellite signals are unobstructed and available.



The vehicle must have a working electrical system, including adequate battery power, for the OnStar equipment to operate. There are other problems OnStar cannot control that may prevent OnStar from providing OnStar service at any particular time or place. Some examples are damage to important parts of the vehicle in a crash, hills, tall buildings, tunnels, weather or wireless phone network congestion.

### Additional OnStar Controls



The vehicle may have a button, located on the driver side of the instrument panel near the headlamp controls, that can be used to interact with OnStar.

Use this button to dial numbers into voicemail systems or to dial phone number extensions. See the OnStar Owner's Guide for more information.

### Your Responsibility

Increase the volume of the radio if the OnStar advisor cannot be heard.

If the light next to the OnStar buttons is red, the system may not be functioning properly.

Press  and request a vehicle diagnostic. If the light appears clear (no light is appearing), your OnStar subscription has expired and all services have been deactivated.

Press  to confirm that the OnStar equipment is active.

 **NOTES**

---

---

---

---

---

---

---

---

---

---

---

---

---

---

---

---

## Keys, Doors and Windows

### Keys and Locks

Keys .....	2-2
Remote Keyless Entry (RKE) System .....	2-2
Remote Keyless Entry (RKE) System Operation .....	2-3
Door Locks .....	2-4
Power Door Locks .....	2-5
Automatic Door Locks .....	2-6
Lockout Protection .....	2-6
Safety Locks .....	2-6

### Doors

Tailgate .....	2-7
----------------	-----

### Vehicle Security

Vehicle Security .....	2-9
Anti-Theft Alarm System .....	2-9
Immobilizer .....	2-10
Immobilizer Operation (U.S.) .....	2-10
Immobilizer Operation (Canada) .....	2-11

### Exterior Mirrors

Convex Mirrors .....	2-13
Power Mirrors .....	2-13
Folding Mirrors .....	2-13

### Interior Mirrors

Automatic Dimming Rearview Mirror .....	2-14
--	------

### Windows

Windows .....	2-15
Power Windows .....	2-16
Sun Visors .....	2-17

### Roof

Sunroof .....	2-17
---------------	------

### Keys and Locks

#### Keys

 **WARNING**

Leaving children in a vehicle with the ignition key is dangerous for many reasons, children or others could be badly injured or even killed. They could operate the power windows or other controls or even make the vehicle move. The windows will function with the keys in the ignition and children could be seriously injured or killed if caught in the path of a closing window. Do not leave the keys in a vehicle with children.



The key is used for the ignition and driver's door lock.

The vehicle has two identical keys and a key code number.

Give the key code to your dealer or qualified locksmith if a new key needs to be made.

**Notice:** If you ever lock your keys in the vehicle, you may have to damage the vehicle to get in. Be sure you have spare keys.

In an emergency, contact Roadside Assistance. See *Roadside Service* on page 13-5.

#### Remote Keyless Entry (RKE) System

See *Radio Frequency Statement* on page 13-16 for information regarding Part 15 of the Federal Communications Commission (FCC) Rules and RSS-210/211 of Industry Canada.

Changes or modifications to this system by other than an authorized service facility could void authorization to use this equipment.

If there is a decrease in the RKE operating range:

- Check the distance. The transmitter may be too far from the vehicle.
- Check the location. Other vehicles or objects may be blocking the signal.
- Check the transmitter's battery. See "Battery Replacement" later in this section.
- If the transmitter is still not working correctly, see your dealer or a qualified technician for service.

## Remote Keyless Entry (RKE) System Operation

The Remote Keyless Entry (RKE) transmitter functions work up to 9 m (30 feet) away from the vehicle.

There are other conditions which can affect the performance of the transmitter. See *Remote Keyless Entry (RKE) System* on page 2-2.



**LOCK:** Press to lock all the doors. The parking lamps may flash and the horn may chirp.

If a door is open or ajar when LOCK is pressed, the doors lock, but the theft-deterrent system does not arm until the open door is closed.

Pressing LOCK may arm the content theft-deterrent system. See *Anti-Theft Alarm System* on page 2-9 for additional information.

**UNLOCK:** Press to unlock only the driver's door. The interior lamps come on, the parking lamps may flash, and the horn may sound.

Press UNLOCK again within three seconds to unlock all the doors.

Pressing UNLOCK may disarm the content theft-deterrent system. See *Anti-Theft Alarm System* on page 2-9 for additional information.

Different feedback choices can be programmed through the Driver Information Center (DIC). See "Remote Keyless Entry Feedback" under *Driver Information Center (DIC)* on page 5-18.

**⚡ (Panic):** Press to activate the alarm. The horn sounds and the headlamps and taillamps flash for up to 30 seconds. To turn the alarm off press ⚡ again, start the vehicle or wait 30 seconds.

## 2-4 Keys, Doors and Windows

### Programming Transmitters to the Vehicle

Only RKE transmitters programmed to this vehicle will work. If a transmitter is lost or stolen, a replacement can be purchased and programmed through your dealer. When the replacement transmitter is programmed to this vehicle, all remaining transmitters must also be reprogrammed. Any lost or stolen transmitters will no longer work once the new transmitter is programmed. Each vehicle can have up to four transmitters programmed to it.

### Battery Replacement

The battery in the transmitter is weak and should be changed if it does not work at the normal range in any location.

**Notice:** When replacing the battery, do not touch any of the circuitry on the transmitter. Static from your body could damage the transmitter.

To replace the battery:



1. Separate the transmitter with a flat, thin object inserted into the notch on the side.
2. Remove the old battery. Do not use a metal object.
3. Insert the new battery. Replace with a CR2032 or equivalent battery.
4. Snap the transmitter back together.

### Door Locks

#### **WARNING**

Unlocked doors can be dangerous.

- Passengers, especially children, can easily open the doors and fall out of a moving vehicle. When a door is locked, the handle will not open it. The chance of being thrown out of the vehicle in a crash is increased if the doors are not locked. So, all passengers should wear safety belts properly and the doors should be locked whenever the vehicle is driven.

(Continued)

**WARNING (Continued)**

- Young children who get into unlocked vehicles may be unable to get out. A child can be overcome by extreme heat and can suffer permanent injuries or even death from heat stroke. Always lock the vehicle whenever leaving it.
- Outsiders can easily enter through an unlocked door when you slow down or stop your vehicle. Locking your doors can help prevent this from happening.

There are several ways to lock and unlock the vehicle.

From the outside, use the key in the driver's door or use the Remote Keyless Entry (RKE) transmitter.

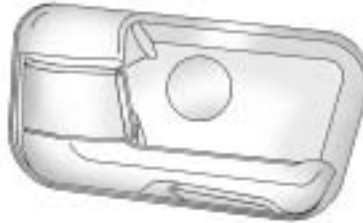

From the inside, use the manual lock levers or power door lock switch.

**Power Door Locks**



**Driver side shown**

The power door lock switches are located on the driver and the front passenger doors.

Press L (Lock) to lock all the doors at once. To unlock all the doors, press U (Unlock).

## 2-6 Keys, Doors and Windows

### Automatic Door Locks

With an automatic transmission, the vehicle is pre-programmed to automatically lock the doors when shifted out of P (Park). All doors unlock when the vehicle is shifted back into P (Park).

With a manual transmission, the vehicle is pre-programmed to automatically lock the doors when the vehicle speed reached 15 mph (24 km/h). Removing the key from the ignition unlocks the doors.

To program the automatic door locks, see "Automatic Door Locks" under *Driver Information Center (DIC)* on page 5-18.

### Lockout Protection

This feature protects against locking the key in the vehicle when it is in the ignition.

A chime sounds as an alert to indicate that the key has been left in the ignition. When the power door lock switch is pressed, a door is open, and the key is in the ignition all of the doors lock and then the driver's door unlocks.

### Safety Locks

Each rear door can be locked so it cannot be opened from the inside.



The rear door security lock is located on the inside edge of each rear door.

To engage a security lock:

1. Open one of the rear doors.
2. Use the ignition key to turn the lock toward the front of the vehicle.
3. Close the door.
4. Repeat these steps on the other rear door.

To open a rear door when the security lock is set, unlock the door and open the door from the outside.

To disengage a security lock:

1. Open one of the rear doors.
2. Use the ignition key to turn the lock to the vertical position.
3. Close the door.
4. Repeat these steps on the other rear door.



## Doors

### Tailgate

#### Tailgate (H3T)

**⚠ WARNING**

It is extremely dangerous to ride on the tailgate, even when the vehicle is operated at low speeds. People riding on the tailgate can easily lose their balance and fall in response to vehicle maneuvers. Falling from a moving vehicle may result in serious injuries or death. Do not allow people to ride on the tailgate. Be sure everyone in your vehicle is in a seat and using a safety belt properly.

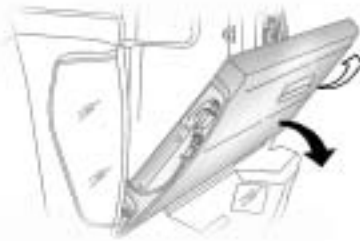

Open the tailgate by pulling up on the outside handle while pulling the tailgate down.

When putting the tailgate up, be sure it latches securely.

### Removing the Tailgate

To remove the tailgate:



1. Open the tailgate fully and remove the retainer clip from the driver's side hinge.

It is recommended that the retainer clip be stored in a safe place, like the glove box.

## 2-8 Keys, Doors and Windows

2. Lift up slightly on the entire tailgate assembly.

Remove the retaining cables from both sides of the pickup box by pulling the clips away from the bolt heads while pushing the cable bracket forward. When the larger part of the hole on the bracket is over the bolt, slide the bracket off of the bolt.

3. With the tailgate partially down, lift up on the passenger's side and pull the tailgate toward you, then move the tailgate to the right to release the driver's side.

Reverse the procedure to reinstall the tailgate. Make sure it is secure.

To partially lower the tailgate:

1. With the tailgate fully open, lift up slightly on the entire tailgate assembly.



### Tailgate Partially Down

2. Remove the retaining cable from the passenger side of the pickup box by pulling the clip away from the bolt head while pushing the cable bracket forward.

When the larger part of the hole on the bracket is over the bolt, slide the bracket off of the bolt.

3. Slide the lower end fitting onto the front bolt. The tailgate will now stay in the partially opened position.
4. Repeat Steps 2 and 3 for the driver side.

When closing the tailgate the bracket cannot be in the partially opened position. It must be anchored on the rear bolt using the top position on the bracket.

### Swing-gate (H3)

To lock or unlock the swing-gate, use the power door lock switch or the Remote Keyless Entry (RKE) transmitter.

#### **WARNING**

Make sure the swing-gate is completely closed. Driving with the swing-gate open could injure pedestrians or damage the vehicle.

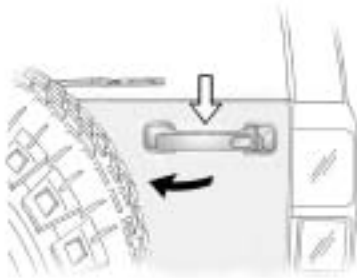

To open the swing-gate, use the door handle to pull the swing-gate rearward slightly so it opens automatically.

## Vehicle Security

Vehicle theft is big business, especially in some cities. This vehicle has theft-deterrent features, however, they do not make it impossible to steal.

### Anti-Theft Alarm System

This vehicle has a content theft-deterrent alarm system.



The security light is located on the instrument panel cluster.

To arm the system:

1. Close all the doors.
2. Lock the doors with the Remote Keyless Entry (RKE) transmitter. The security light flashes.

If the lock button on the RKE transmitter is pressed, but a door is open, the doors lock, the lights may flash and the horn may sound. Close the open door to arm the system.

The alarm goes off if a locked door is not opened using the RKE transmitter, or by OnStar<sup>®</sup>. A pre-alarm sounds the horn at reduced intensity for 10 seconds. Then, the front turn signal lamps flash for two minutes, and the horn sounds for two minutes. The alarm then turns off to save battery power.

Start the engine to turn off the alarm.

The theft-deterrent system does not activate if the doors are locked with the key, the manual door lock, or power door lock switch. The system can only be activated using the RKE transmitter, or by OnStar. See the OnStar Owner's Guide for additional information. The vehicle can be started with the correct key if the alarm has been set off.

## 2-10 Keys, Doors and Windows

---

To avoid setting off the alarm by accident:

- Lock the vehicle with the manual door lock lever, the power door lock switch, or the key, after the doors are closed.
- Unlock the doors by pressing the unlock button on the RKE transmitter or by contacting OnStar. Unlocking a door any other way activates the alarm.

Press unlock on the RKE transmitter, start the vehicle with the correct key, or have OnStar unlock the doors to turn the alarm off. The alarm does not stop if a door is unlocked any other way.

### Testing the Alarm

To test the alarm:

1. From inside the vehicle, lock the doors with the RKE transmitter.
2. Unlock the door with the manual door lock and open the door. The pre-alarm should sound followed by the full alarm about 10 seconds later.
3. Press the unlock button on the RKE transmitter or start the engine to turn the alarm off.

If the alarm does not sound but the lights flash, check to see if the horn works. The horn fuse could be blown. To replace the fuse, see *Fuses and Circuit Breakers on page 10-39*.

If the alarm does not sound or the front turn signal lamps do not flash, see your dealer for service.

### Immobilizer

See *Radio Frequency Statement on page 13-16* for information regarding Part 15 of the Federal Communications Commission (FCC) Rules and RSS-210/211 of Industry Canada.

### Immobilizer Operation (U.S.)

Passlock<sup>®</sup> is a passive theft-deterrent system that enables fuel if the vehicle is started with a valid key. If an incorrect key is used or the ignition lock cylinder is tampered with, the fuel system is disabled and the vehicle does not start.

The security light turns off approximately five seconds after the engine is started. See *Security Light on page 5-17*.

If the engine stalls and the security light flashes, wait about 10 minutes until the light stops flashing before trying to restart the engine. Release the key from START as soon as the engine starts.

If the engine does not start after three tries, the vehicle needs service.

If the engine is running and the security light comes on, the engine restarts if you turn the engine off. However, the Passlock system is not working properly and must be serviced by your dealer. The vehicle is not protected by Passlock at this time. See your dealer for service.

In an emergency, call the Roadside Assistance Center. See *Roadside Service* on page 13-5.

Do not leave the key or device that disarms or deactivates the theft deterrent system in the vehicle.

### **Immobilizer Operation (Canada)**

This vehicle has a passive theft-deterrent system.

The system is automatically armed when the key is removed from the ignition.

The system is automatically disarmed when the key is turned to ON/RUN.

You do not have to manually arm or disarm the system.

The security light comes on if there is a problem with arming or disarming the theft-deterrent system.

The key uses a transponder that matches an immobilizer control unit in the vehicle. Only the correct key starts the vehicle. If the key is ever damaged, the vehicle may not start.

When trying to start the vehicle, if the engine does not start and the security light comes on, there may be a problem with the theft-deterrent system. Turn the ignition off and try again.

## 2-12 Keys, Doors and Windows

---

If the engine still does not start, and the key appears to be undamaged, try another ignition key. Check the fuse. See *Fuses and Circuit Breakers on page 10-39*. If the engine still does not start with the other key, the vehicle needs service. If the vehicle does start, the first key may be faulty. See your dealer who can service the theft-deterrent system and have a new key made.

It is possible for the theft-deterrent system decoder to learn the transponder value of a new or replacement key. Up to 10 keys can be programmed for the vehicle. The following procedure is for programming additional keys only.

If the keys are lost or damaged, only a dealer can service the theft-deterrent system to have new ones made. Two current driver's keys are required to program additional keys.

To program a new key:

1. Verify that the new key has PK3+ stamped on it.
2. Insert the current driver's key in the ignition and start the engine. If the engine does not start see your dealer for service.
3. After the engine has started, turn the key to LOCK/OFF, and remove the key.
4. Insert the second current driver's key in the ignition and start the engine within ten seconds of removing the previous key. If the engine does not start see your dealer for service.

5. After the engine has started, turn the key to LOCK/OFF, and remove the key. Insert the key to be programmed and turn it to ON/RUN within ten seconds of removing the previous key.

The security light turns off once the key has been programmed.

6. Repeat the Steps 1 through 5 if additional keys are to be programmed.

If the security light comes on and stays on while driving, the engine will restart if you turn it off. However, the theft-deterrent system is not working properly and must be serviced by your dealer. The vehicle is not protected by the theft-deterrent system at this time.

In an emergency, contact Roadside Assistance. See *Roadside Service on page 13-5*.

Do not leave the key or device that disarms or deactivates the theft deterrent system in the vehicle.

## Exterior Mirrors

### Convex Mirrors

**⚠ WARNING**

A convex mirror can make things, like other vehicles, look farther away than they really are. If you cut too sharply into the right lane, you could hit a vehicle on the right. Check the inside mirror or glance over your shoulder before changing lanes.

The passenger side mirror is convex shaped. A convex mirror's surface is curved so more can be seen from the driver seat.

### Power Mirrors

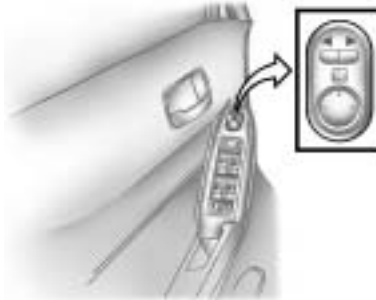

**H3 shown, H3T similar**

Controls for the outside power mirrors are located on the driver door.

To adjust the power mirrors:

1. Press the left or right side of the selector switch to choose the driver or passenger side mirror.
2. Press the round, four-way control pad to adjust the mirror.

### Folding Mirrors

#### Manual

Manually fold the mirrors inward to prevent damage when going through an automatic car wash. To fold, pull the mirror toward the vehicle. Push the mirror outward, to return it to the original position.

### Interior Mirrors

#### Automatic Dimming Rearview Mirror

The vehicle has an automatic dimming rearview mirror with a compass and temperature display.

Vehicles with OnStar<sup>®</sup> have three additional control buttons for the OnStar<sup>®</sup> system. See your dealer for more information about OnStar<sup>®</sup> and how to subscribe to it. See the OnStar<sup>®</sup> owner guide for more information about the services OnStar<sup>®</sup> provides.

**(U) (On/Off):** Press to turn the dimming feature on or off.

The vehicle may also have a Rear Vision Camera (RVC). See *Rear Vision Camera (RVC) on page 9-60* for more information.

#### Automatic Dimming Mirror Operation

Automatic dimming reduces the glare from the headlamps of the vehicle behind you. The dimming feature comes on and the indicator light illuminates each time the ignition is turned to start.

#### Temperature Display

To adjust between Fahrenheit and Celsius:

- Press **(U)** for approximately four seconds to toggle the display from F (Fahrenheit) to C (Celsius) to OFF. Release the button after the display has toggled to the next state.

The temperature display will remain in its current state each time the ignition goes through its cycle.

- At start up, if the vehicle has been off for less than two and a half hours, and the last stored temperature was less than the current temperature, the sensor will increase 1°F every two minutes until the correct temperature is displayed.
- If the vehicle has been off more than two and a half hours, or the last stored temperature is greater than the current temperature, the current temperature immediately displays.
- If the temperature is 37°F (3°C) or lower, ICE will flash on the temperature display. This display will flash every two seconds for a period of one minute.

If an abnormal temperature reading is displayed for an extended period of time, see your dealer. Under certain circumstances, a delay in updating the temperature is normal.



### Compass Display

Press  to turn the compass display on or off.

For more information about the compass, see *Compass on page 5-3*.

### Cleaning the Mirror

Do not spray glass cleaner directly on the mirror. Use a soft towel dampened with water.

## Windows

### WARNING

Leaving children, helpless adults, or pets in a vehicle with the windows closed is dangerous. They can be overcome by the extreme heat and suffer permanent injuries or even death from heat stroke. Never leave a child, a helpless adult, or a pet alone in a vehicle, especially with the windows closed in warm or hot weather.



### Power Windows

#### **WARNING**

Leaving children in a vehicle with the keys is dangerous for many reasons, children or others could be badly injured or even killed. They could operate the power windows or other controls or even make the vehicle move.

The windows will function and they could be seriously injured or killed if caught in the path of a closing window. Do not leave keys in a vehicle with children.

When there are children in the rear seat use the window lockout button to prevent unintentional operation of the windows.



The power window controls are located on each door.

The driver's door also has passenger window switches.

The ignition must be in ACC/ACCESSORY, ON/RUN, or in Retained Accessory Power (RAP). See *Retained Accessory Power (RAP)* on page 9-35.

Pull up or press down on the front edge of the switch to raise or lower the window.

#### **Express-Down Window**

The driver's window has an express-down feature that lowers the window without holding the switch. Press the front edge of the switch past the first position to activate the express-down mode. To stop the express-down, pull up on the switch. To open the window partway, press the front of the switch to the first position until the window is at the desired level.

## Window Lockout

 **(Window Lockout):** The window lockout button is located in front of the window switches. This feature disables the passenger's window switches when the button is pressed. Press the button again to turn the lockout off. A red band on the side of the button is lit when the windows are not locked out.

## Sun Visors

Pull the visor toward you, or move it to the side to help reduce glare. Pull out the extenders for further coverage.

On a visor with a mirror, lift the cover to use it.

## Roof

### Sunroof

To operate a power sliding sunroof, the ignition must be on, or Retained Accessory Power (RAP) must be active. See *Retained Accessory Power (RAP)* on page 9-35.

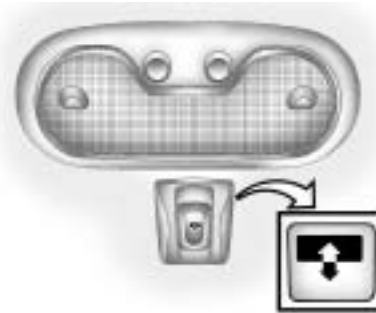

The switch used to operate the sunroof is located in the headliner.

**Express Open/Close:** To open or close the sunroof, fully press and release the rear or front of the switch. The sunroof automatically opens. To stop the sunroof partway, press the switch a second time. An air deflector raises when the sunroof is fully opened.

**Vent:** With the sunroof closed, press and hold the front of the switch to vent the sunroof. To stop the sunroof before it reaches its full vent position, release the switch. Press and hold the back of the switch to close.

Do not leave the sunroof open for long periods of time. Excessive debris may collect in the tracks and possibly damage the sunroof operation, or plug the water draining system.

Dirt and debris may collect on the sunroof seal or in the tracks that could cause an issue with sunroof operation, noise or plug the water drainage system. Periodically open the sunroof and remove any obstacles or loose debris. Wipe the sunroof seal and roof sealing area using a clean cloth, mild soap, and water. Do not remove grease from sunroof.

### **Anti-Pinch Feature**

If an object is in the path of the sunroof when it is closing, the anti-pinch feature detects the object and stops the sunroof from closing at the point of the obstruction. The sunroof then returns to the full-open position.

### **Sunshade Operation**

The sunshade automatically opens with the sunroof. Manually pull it shut after the sunroof is closed.

To adjust the sunshade, push it backward or pull it forward to the desired position. The sunshade cannot be adjusted further than the current closed position of the sunroof.

# Seats and Restraints

## Head Restraints

Head Restraints ..... 3-2

## Front Seats

Seat Adjustment ..... 3-3  
 Power Seat Adjustment ..... 3-3  
 Lumbar Adjustment ..... 3-4  
 Reclining Seatbacks ..... 3-4  
 Heated Front Seats ..... 3-6

## Rear Seats

Rear Seats (H3) ..... 3-7  
 Rear Seats (H3T) ..... 3-9

## Safety Belts

Safety Belts ..... 3-10  
 How to Wear Safety Belts Properly ..... 3-15  
 Lap-Shoulder Belt ..... 3-20  
 Safety Belt Use During Pregnancy ..... 3-25  
 Safety Belt Extender ..... 3-26

Safety System Check ..... 3-26  
 Safety Belt Care ..... 3-26  
 Replacing Safety Belt System Parts After a Crash ..... 3-27

## Airbag System

Airbag System ..... 3-27  
 Where Are the Airbags? ..... 3-29  
 When Should an Airbag Inflate? ..... 3-31  
 What Makes an Airbag Inflate? ..... 3-32  
 How Does an Airbag Restrain? ..... 3-32  
 What Will You See After an Airbag Inflates? ..... 3-33  
 Passenger Sensing System ..... 3-35  
 Servicing the Airbag-Equipped Vehicle ..... 3-40  
 Adding Equipment to the Airbag-Equipped Vehicle ... 3-40  
 Airbag System Check ..... 3-41  
 Replacing Airbag System Parts After a Crash ..... 3-42

## Child Restraints

Older Children ..... 3-42  
 Infants and Young Children ..... 3-44  
 Child Restraint Systems .... 3-47  
 Where to Put the Restraint ... 3-49  
 Lower Anchors and Tethers for Children (LATCH System) ..... 3-51  
 Replacing LATCH System Parts After a Crash ..... 3-59  
 Securing Child Restraints (Rear Outboard Seating Position) ..... 3-59  
 Securing Child Restraints (Rear Center Seating Position) ..... 3-61  
 Securing Child Restraints (Right Front Seat Position) ..... 3-62

### Head Restraints

The front seats have adjustable head restraints in the outboard seating positions.

#### **WARNING**

With head restraints that are not installed and adjusted properly, there is a greater chance that occupants will suffer a neck/spinal injury in a crash. Do not drive until the head restraints for all occupants are installed and adjusted properly.



Adjust the head restraint so that the top of the restraint is at the same height as the top of the occupant's head. This position reduces the chance of a neck injury in a crash.



Pull the head restraint up to raise it. To lower the head restraint, press the button, located on the top of the seatback, and push the restraint down.

Push down on the head restraint after the button is released to make sure that it is locked in place.

The head restraints are not designed to be removed.

## Front Seats

### Seat Adjustment

#### **WARNING**

You can lose control of the vehicle if you try to adjust a manual driver's seat while the vehicle is moving. The sudden movement could startle and confuse you, or make you push a pedal when you do not want to. Adjust the driver's seat only when the vehicle is not moving.

To move a manual seat forward or rearward:



1. Lift the bar to unlock the seat.
2. Slide the seat to the desired position and release the bar.

Try to move the seat with your body to be sure the seat is locked in place.

### Power Seat Adjustment



On a vehicle with power seats, the controls used to operate them are located on the outboard side of the seats.

To adjust the seat:

- Move the seat forward or rearward by sliding the control forward or rearward.
- Raise or lower the front or rear part of the seat cushion by moving the front or rear of the control up or down.

## 3-4 Seats and Restraints

- Raise or lower the entire seat cushion by moving the control up or down.

### Lumbar Adjustment

#### Manual Lumbar



On vehicles with this feature, the knob is located on the outboard side of the seat.

Turn the knob clockwise or counterclockwise to increase or decrease the lumbar support.

#### Power Lumbar



On vehicles with this feature, the control is located on the outboard side of the seat(s).

To increase or decrease lumbar support, press and hold the front or rear of the control.

### Reclining Seatbacks

#### WARNING

You can lose control of the vehicle if you try to adjust a manual driver's seat while the vehicle is moving. The sudden movement could startle and confuse you, or make you push a pedal when you do not want to. Adjust the driver's seat only when the vehicle is not moving.

#### WARNING

If either seatback is not locked, it could move forward in a sudden stop or crash. That could cause injury to the person sitting there. Always push and pull on the seatbacks to be sure they are locked.



The seats have manual reclining seatbacks. The lever used to operate them is located on the outboard side of the seats.

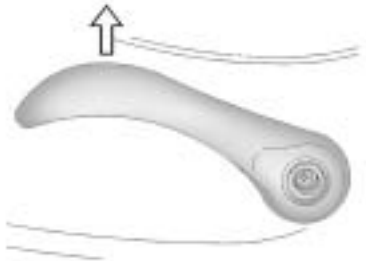

To recline the seatback:

1. Lift the recline lever and move the seatback to the desired position, then release the lever to lock the seatback in place.
2. Push and pull on the seatback to make sure it is locked.

To return the seatback to an upright position:

1. Lift the lever fully without applying pressure to the seatback.
2. Push and pull on the seatback to make sure it is locked.



Do not have a seatback reclined when the vehicle is moving.

**⚠ WARNING**

Sitting in a reclined position when the vehicle is in motion can be dangerous. Even when buckled up, the safety belts cannot do their job when reclined like this.

The shoulder belt cannot do its job because it will not be against your body. Instead, it will be in front of you. In a crash, you could go into it, receiving neck or other injuries.

The lap belt cannot do its job either. In a crash, the belt could go up over your abdomen. The belt forces would be there, not at your pelvic bones. This could cause serious internal injuries.

For proper protection when the vehicle is in motion, have the seatback upright. Then sit well back in the seat and wear the safety belt properly.

## 3-6 Seats and Restraints

### Heated Front Seats

#### WARNING

If you cannot feel temperature change or pain to the skin, the seat heater may cause burns even at low temperatures.

To reduce the risk of burns, people with such a condition should use care when using the seat heater, especially for long periods of time. Do not place anything on the seat that insulates against heat, such as a blanket, cushion, cover or similar item. This may cause the seat heater to overheat. An overheated seat heater may cause a burn or may damage the seat.

This feature heats the cushion and seatbacks.



On vehicles with this feature the controls are located on the outboard sides of the front seats.

Press the top of the switch to turn the heat to the high setting. Press the bottom of the switch to turn the heat to the low setting. Put the switch in the center position to turn the heat off.

The ignition must be on for the heated seat feature to work. The seat will heat to the last setting if the ignition has been turned off and then turned back on.

For the heated seat feature to work on the passenger seat the safety belt must be fastened.

## Rear Seats

### Rear Seats (H3)

The 60/40 split bench seats can be folded for more cargo space.

#### Folding the Seatbacks

There should be nothing on, under, or in front of the seat, and the front seats should be moved forward.

To fold the rear seatback(s):

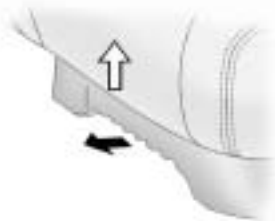

1. Reach under the front of the seat and lift the cushion up while moving it forward.



2. Pull the seat cushion forward until it rests in the footwell.

**Notice:** Folding a rear seat with the safety belts still fastened may cause damage to the seat or the safety belts. Always unbuckle the safety belts and return them to their normal stowed position before folding a rear seat.



3. Lift the latch on top of the seatback and pull the seatback forward. Fold the seatback down until it is nearly flat.
4. If the seatback will not fold nearly flat, try moving the front seat forward and/or moving the front seatback more upright.
5. Repeat the steps for the other half of the 60/40 split bench seat.

## 3-8 Seats and Restraints

---

### Returning the Seatbacks to an Upright Position

 **WARNING**

If either seatback is not locked, it could move forward in a sudden stop or crash. That could cause injury to the person sitting there. Always push and pull on the seatbacks to be sure they are locked.

 **WARNING**

A safety belt that is improperly routed, not properly attached, or twisted will not provide the protection needed in a crash. The person wearing the belt could be seriously injured. After raising the rear seatback, always check to be sure that the safety belts are properly routed and attached, and are not twisted.

To return the seatback(s) to the upright position:

1. Lift the seatback up and push it all the way rearward.
2. Reach under the front seat and lift the cushion while moving it rearward until it latches.
3. Pull forward on the seatback and push down on the seat cushion to make sure the seat is securely in place.

## Rear Seats (H3T)

**Notice:** Folding a rear seat with the safety belts still fastened may cause damage to the seat or the safety belts. Always unbuckle the safety belts and return them to their normal stowed position before folding a rear seat.

To fold the rear seatback(s) forward:



1. Disconnect the rear center safety belt latch from the mini buckle by inserting the tip of the safety belt into the slot on the buckle. Let the belt retract.



2. Pull the loop, located on the outboard side of the seatback, forward until you hear a click.
3. Fold the seatback forward slightly so that the headrest can be removed.

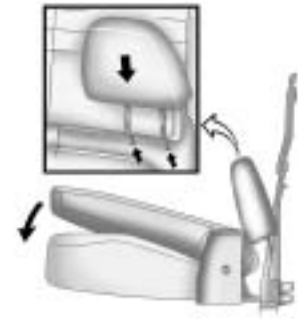

4. Remove the headrest by pressing the button on the headrest post, at the top of the seatback.
5. Lift the headrest off the seatback and store on the back panel.

## 3-10 Seats and Restraints

To return the seatback(s) to the upright position:

1. Lift the seatback partially and reinsert the headrest.
2. Lift the seatback completely and push it into place.

### **WARNING**

If either seatback is not locked, it could move forward in a sudden stop or crash. That could cause injury to the person sitting there. Always push and pull on the seatbacks to be sure they are locked.

3. Make sure the seatback is locked by pushing and pulling on it.

### **WARNING**

A safety belt that is improperly routed, not properly attached, or twisted will not provide the protection needed in a crash. The person wearing the belt could be seriously injured. After raising the rear seatback, always check to be sure that the safety belts are properly routed and attached, and are not twisted.

4. Reconnect the center safety belt latch plate to the mini buckle. Make sure the safety belt is not twisted.
5. Push and pull on the latch plate to be sure it is secure.

When the seatback is not in use, it should be kept in the upright, locked position.

## Safety Belts

This section of the manual describes how to use safety belts properly. It also describes some things not to do with safety belts.

### **WARNING**

Do not let anyone ride where a safety belt cannot be worn properly. In a crash, if you or your passenger(s) are not wearing safety belts, the injuries can be much worse. You can hit things inside the vehicle harder or be ejected from the vehicle. You and your passenger(s) can be seriously injured or killed. In the same crash, you might not be, if you are buckled up. Always fasten your safety belt, and check that your passenger(s) are restrained properly too.

### **WARNING**

It is extremely dangerous to ride in a cargo area, inside or outside of a vehicle. In a collision, people riding in these areas are more likely to be seriously injured or killed. Do not allow people to ride in any area of your vehicle that is not equipped with seats and safety belts. Be sure everyone in your vehicle is in a seat and using a safety belt properly.

### **WARNING**

People riding on the tailgate (if equipped) can easily lose their balance and fall even when the vehicle is operated at low speeds. Falling from a moving vehicle may result in serious injuries or death.

This vehicle has indicators as a reminder to buckle the safety belts. See *Safety Belt Reminders on page 5-9* for additional information.

In most states and in all Canadian provinces, the law requires wearing safety belts. Here is why:

You never know if you will be in a crash. If you do have a crash, you do not know if it will be a serious one.

A few crashes are mild, and some crashes can be so serious that even buckled up, a person would not survive. But most crashes are in between. In many of them, people who buckle up can survive and sometimes walk away. Without safety belts they could have been badly hurt or killed.

After more than 40 years of safety belts in vehicles, the facts are clear. In most crashes buckling up does matter ... a lot!

## 3-12 Seats and Restraints

### Why Safety Belts Work

When you ride in or on anything, you go as fast as it goes.



Take the simplest vehicle. Suppose it is just a seat on wheels.



Put someone on it.



Get it up to speed. Then stop the vehicle. The rider does not stop.





The person keeps going until stopped by something. In a real vehicle, it could be the windshield...



or the instrument panel...



or the safety belts!

With safety belts, you slow down as the vehicle does. You get more time to stop. You stop over more distance, and your strongest bones take the forces. That is why safety belts make such good sense.

## 3-14 Seats and Restraints

---

### Questions and Answers About Safety Belts

**Q: Will I be trapped in the vehicle after a crash if I am wearing a safety belt?**

**A:** You *could* be — whether you are wearing a safety belt or not. But your chance of being conscious during and after an accident, so you *can* unbuckle and get out, is *much* greater if you are belted. And you can unbuckle a safety belt, even if you are upside down.

**Q: If my vehicle has airbags, why should I have to wear safety belts?**

**A:** Airbags are supplemental systems only; so they work *with* safety belts — not instead of them. Whether or not an airbag is provided, all occupants still have to buckle up to get the most protection. That is true not only in frontal collisions, but especially in side and other collisions.

**Q: If I am a good driver, and I never drive far from home, why should I wear safety belts?**

**A:** You may be an excellent driver, but if you are in a crash — even one that is not your fault — you and your passenger(s) can be hurt. Being a good driver does not protect you from things beyond your control, such as bad drivers.

Most accidents occur within 40 km (25 miles) of home. And the greatest number of serious injuries and deaths occur at speeds of less than 65 km/h (40 mph).

Safety belts are for everyone.

## How to Wear Safety Belts Properly

This section is only for people of adult size.

Be aware that there are special things to know about safety belts and children. And there are different rules for smaller children and infants. If a child will be riding in the vehicle, see *Older Children on page 3-42* or *Infants and Young Children on page 3-44*. Follow those rules for everyone's protection.

It is very important for all occupants to buckle up. Statistics show that unbelted people are hurt more often in crashes than those who are wearing safety belts.

Occupants who are not buckled up can be thrown out of the vehicle in a crash. And they can strike others in the vehicle who are wearing safety belts.

First, before you or your passenger(s) wear a safety belt, there is important information you should know.

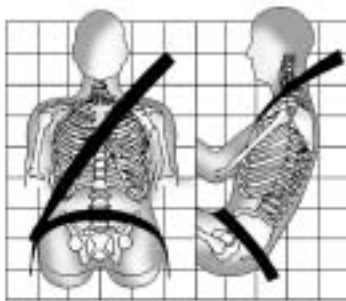

Sit up straight and always keep your feet on the floor in front of you. The lap part of the belt should be

worn low and snug on the hips, just touching the thighs. In a crash, this applies force to the strong pelvic bones and you would be less likely to slide under the lap belt. If you slid under it, the belt would apply force on your abdomen. This could cause serious or even fatal injuries. The shoulder belt should go over the shoulder and across the chest. These parts of the body are best able to take belt restraining forces.

The shoulder belt locks if there is a sudden stop or crash.

## 3-16 Seats and Restraints

**Q:** What is wrong with this?

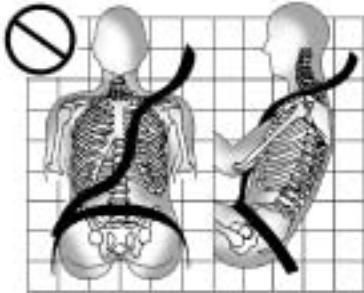

**A:** The shoulder belt is too loose. It will not give as much protection this way.

### **WARNING**

You can be seriously hurt if your shoulder belt is too loose. In a crash, you would move forward too much, which could increase injury. The shoulder belt should fit snugly against your body.

**Q:** What is wrong with this?

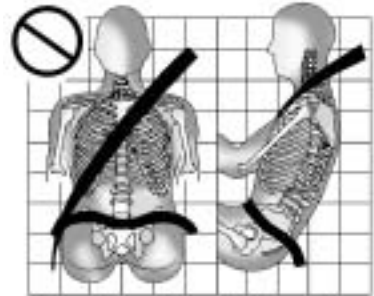

**A:** The lap belt is too loose. It will not give nearly as much protection this way.

**⚠ WARNING**

You can be seriously hurt if your lap belt is too loose. In a crash, you could slide under the lap belt and apply force on your abdomen. This could cause serious or even fatal injuries. The lap belt should be worn low and snug on the hips, just touching the thighs.

**Q: What is wrong with this?**

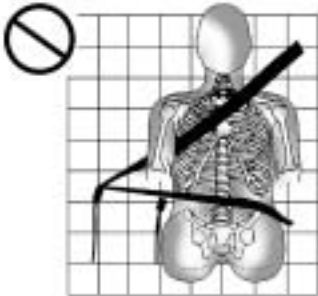

**A: The belt is buckled in the wrong buckle.**

**⚠ WARNING**

You can be seriously injured if your belt is buckled in the wrong place like this. In a crash, the belt would go up over your abdomen. The belt forces would be there, not on the pelvic bones. This could cause serious internal injuries. Always buckle your belt into the buckle nearest you.

## 3-18 Seats and Restraints

**Q:** What is wrong with this?



**A:** The belt is over an armrest.

### **WARNING**

You can be seriously injured if your belt goes over an armrest like this. The belt would be much too high. In a crash, you can slide under the belt. The belt force would then be applied on the abdomen, not on the pelvic bones, and that could cause serious or fatal injuries. Be sure the belt goes under the armrests.

**Q:** What is wrong with this?

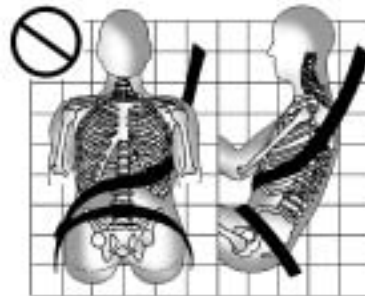

**A:** The shoulder belt is worn under the arm. It should be worn over the shoulder at all times.

**⚠ WARNING**

You can be seriously injured if you wear the shoulder belt under your arm. In a crash, your body would move too far forward, which would increase the chance of head and neck injury. Also, the belt would apply too much force to the ribs, which are not as strong as shoulder bones. You could also severely injure internal organs like your liver or spleen. The shoulder belt should go over the shoulder and across the chest.

**Q: What is wrong with this?**

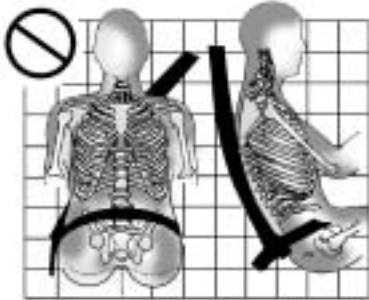

**A: The belt is behind the body.**

**⚠ WARNING**

You can be seriously injured by not wearing the lap-shoulder belt properly. In a crash, you would not be restrained by the shoulder belt. Your body could move too far forward increasing the chance of head and neck injury. You might also slide under the lap belt. The belt force would then be applied right on the abdomen. That could cause serious or fatal injuries. The shoulder belt should go over the shoulder and across the chest.

**Q:** What is wrong with this?

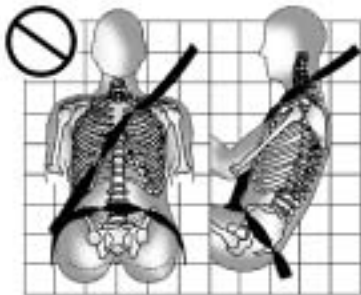

**A:** The belt is twisted across the body.

### **WARNING**

You can be seriously injured by a twisted belt. In a crash, you would not have the full width of the belt to spread impact forces. If a belt is twisted, make it straight so it can work properly, or ask your dealer to fix it.

## Lap-Shoulder Belt

All seating positions in the vehicle have a lap-shoulder belt.

If you are using a rear seating position with a detachable safety belt and the safety belt is not attached, see *Rear Seats (H3)* on page 3-7 or *Rear Seats (H3T)* on page 3-9 for instruction on reconnecting the safety belt to the mini-buckle.

The following instructions explain how to wear a lap-shoulder belt properly.

1. Adjust the seat, if the seat is adjustable, so you can sit up straight. To see how, see “Seats” in the Index.





2. Pick up the latch plate and pull the belt across you. Do not let it get twisted.

The lap-shoulder belt may lock if you pull the belt across you very quickly. If this happens, let the belt go back slightly to unlock it. Then pull the belt across you more slowly.

If the shoulder portion of a passenger belt is pulled out all the way, the child restraint locking feature may be engaged. If this happens, let the belt go back all the way and start again.

Engaging the child restraint locking feature in the right front seating position may affect the passenger sensing system. See *Passenger Sensing System on page 3-35* for more information.



3. Push the latch plate into the buckle until it clicks.

Pull up on the latch plate to make sure it is secure. If the belt is not long enough, see *Safety Belt Extender on page 3-26*.

Position the release button on the buckle so that the safety belt could be quickly unbuckled if necessary.

## 3-22 Seats and Restraints

4. If equipped with a shoulder belt height adjuster, move it to the height that is right for you. See "Shoulder Belt Height Adjustment" later in this section for instructions on use and important safety information.



5. To make the lap part tight, pull up on the shoulder belt.

It may be necessary to pull stitching on the safety belt through the latch plate to fully tighten the lap belt on smaller occupants.



To unlatch the belt, push the button on the buckle. The belt should return to its stowed position. Slide the latch plate up the safety belt webbing when the safety belt is not in use. The latch plate should rest on the stitching on the safety belt, near the guide loop on the side wall.

Before a door is closed, be sure the safety belt is out of the way. If a door is slammed against a safety belt, damage can occur to both the safety belt and the vehicle.

### Shoulder Belt Height Adjuster

The vehicle has a shoulder belt height adjuster for the driver and right front passenger seating positions.

Adjust the height so that the shoulder portion of the belt is centered on the shoulder. The belt should be away from the face and neck, but not falling off of the shoulder. Improper shoulder belt height adjustment could reduce the effectiveness of the safety belt in a crash.

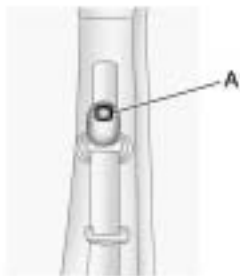

To move it down, press the release button (A) and move the height adjuster to the desired position. You can move the height adjuster up just by pushing up on the shoulder belt guide.

After the adjuster is set to the desired position, try to move it down without pushing the button to make sure it has locked into position.

### Safety Belt Pretensioners

This vehicle has safety belt pretensioners for the front outboard occupants. Although the safety belt pretensioners cannot be seen, they are part of the safety belt assembly. They can help tighten the safety belts during the early stages of a moderate to severe frontal, near frontal, or rear crash if the threshold conditions for pretensioner activation are met. And, for vehicles with side impact airbags, safety belt pretensioners can help tighten the safety belts in a side crash or a rollover event.

Pretensioners work only once. If the pretensioners activate in a crash, they will need to be replaced, and probably other new parts for the vehicle's safety belt system. See *Replacing Safety Belt System Parts After a Crash* on page 3-27.

### Rear Safety Belt Comfort Guides

This vehicle may have rear shoulder belt comfort guides. If not, they are available through your dealer. The guides may provide added safety belt comfort for older children who have outgrown booster seats and for some adults. When installed and properly adjusted, the comfort guide positions the shoulder belt away from the neck and head.

## 3-24 Seats and Restraints

---

Here is how to install a comfort guide to the safety belt:



1. Pull the elastic cord out from between the edge of the seatback and the interior body to remove the guide from its storage clip.



2. Place the guide over the belt and insert the two edges of the belt into the slots of the guide.



3. Be sure that the belt is not twisted and it lies flat. The elastic cord must be under the belt and the guide on top.

**⚠ WARNING**

A safety belt that is not properly worn may not provide the protection needed in a crash. The person wearing the belt could be seriously injured. The shoulder belt should go over the shoulder and across the chest. These parts of the body are best able to take belt restraining forces.



4. Buckle, position, and release the safety belt as described previously in this section. Make sure that the shoulder belt crosses the shoulder.

To remove and store the comfort guide, squeeze the belt edges together so that the safety belt can be removed from the guide. Pull the guide upward to expose its storage clip, and then slide the guide onto the clip. Turn the guide and clip inward and slide them in between the seatback and the interior body, leaving only the loop of the elastic cord exposed.

**Safety Belt Use During Pregnancy**

Safety belts work for everyone, including pregnant women. Like all occupants, they are more likely to be seriously injured if they do not wear safety belts.



A pregnant woman should wear a lap-shoulder belt, and the lap portion should be worn as low as possible, below the rounding, throughout the pregnancy.

The best way to protect the fetus is to protect the mother. When a safety belt is worn properly, it is more likely that the fetus will not be hurt in a crash. For pregnant women, as for anyone, the key to making safety belts effective is wearing them properly.

### Safety Belt Extender

If the vehicle's safety belt will fasten around you, you should use it.

But if a safety belt is not long enough, your dealer will order you an extender. When you go in to order it, take the heaviest coat you will wear, so the extender will be long enough for you. To help avoid personal injury, do not let someone else use it, and use it only for the seat it is made to fit. The extender has been designed for adults. Never use it for securing child seats. To wear it, attach it to the regular safety belt. For more information, see the instruction sheet that comes with the extender.

### Safety System Check

Now and then, check that the safety belt reminder light, safety belts, buckles, latch plates, retractors and anchorages are working properly. Look for any other loose or damaged safety belt system parts that might keep a safety belt system from doing its job. See your dealer to have it repaired. Torn or frayed safety belts may not protect you in a crash. They can rip apart under impact forces. If a belt is torn or frayed, get a new one right away.

Make sure the safety belt reminder light is working. See *Safety Belt Reminders on page 5-9* for more information.

Keep safety belts clean and dry. See *Safety Belt Care on page 3-26*.

### Safety Belt Care

Keep belts clean and dry.

#### **WARNING**

Do not bleach or dye safety belts. It may severely weaken them. In a crash, they might not be able to provide adequate protection. Clean safety belts only with mild soap and lukewarm water.

## Replacing Safety Belt System Parts After a Crash

### WARNING

A crash can damage the safety belt system in the vehicle. A damaged safety belt system may not properly protect the person using it, resulting in serious injury or even death in a crash. To help make sure the safety belt systems are working properly after a crash, have them inspected and any necessary replacements made as soon as possible.

After a minor crash, replacement of safety belts may not be necessary. But the safety belt assemblies that were used during any crash may have been stressed or damaged. See your dealer to have the safety belt assemblies inspected or replaced.

New parts and repairs may be necessary even if the safety belt system was not being used at the time of the crash.

Have the safety belt pretensioners checked if the vehicle has been in a crash, or if the airbag readiness light stays on after you start the vehicle or while you are driving. See *Airbag Readiness Light on page 5-10*.

## Airbag System

The vehicle has the following airbags:

- A frontal airbag for the driver.
- A frontal airbag for the right front passenger.
- A roof-rail airbag for the driver and the passenger seated directly behind the driver.
- A roof-rail airbag for the right front passenger and the passenger seated directly behind the right front passenger.

All of the airbags in the vehicle will have the word AIRBAG embossed in the trim or on an attached label near the deployment opening.

For frontal airbags, the word AIRBAG will appear on the middle part of the steering wheel for the driver and on the instrument panel for the right front passenger.

With roof-rail airbags, the word AIRBAG will appear along the headliner or trim.

## 3-28 Seats and Restraints

Airbags are designed to supplement the protection provided by safety belts. Even though today's airbags are also designed to help reduce the risk of injury from the force of an inflating bag, all airbags must inflate very quickly to do their job.

Here are the most important things to know about the airbag system:

### **WARNING**

You can be severely injured or killed in a crash if you are not wearing your safety belt — even if you have airbags. Airbags are designed to work with safety belts, but do not replace them. Also, airbags are not designed to deploy in every crash. In some crashes safety belts are your only restraint. See *When Should an Airbag Inflate?* on page 3-31.

(Continued)

### **WARNING (Continued)**

Wearing your safety belt during a crash helps reduce your chance of hitting things inside the vehicle or being ejected from it. Airbags are “supplemental restraints” to the safety belts. Everyone in your vehicle should wear a safety belt properly — whether or not there is an airbag for that person.

### **WARNING**

Airbags inflate with great force, faster than the blink of an eye. Anyone who is up against, or very close to, any airbag when it inflates can be seriously injured or killed. Do not sit unnecessarily close to the airbag, as you would be if you were sitting on the edge of your seat or leaning forward.

(Continued)

### **WARNING (Continued)**

Safety belts help keep you in position before and during a crash. Always wear your safety belt, even with airbags. The driver should sit as far back as possible while still maintaining control of the vehicle.

Occupants should not lean on or sleep against the door or side windows in seating positions with roof-rail airbags.



**⚠ WARNING**

Children who are up against, or very close to, any airbag when it inflates can be seriously injured or killed. Airbags plus lap-shoulder belts offer protection for adults and older children, but not for young children and infants. Neither the vehicle's safety belt system nor its airbag system is designed for them. Young children and infants need the protection that a child restraint system can provide. Always secure children properly in your vehicle. To read how, see *Older Children on page 3-42* or *Infants and Young Children on page 3-44*.



There is an airbag readiness light on the instrument panel cluster, which shows the airbag symbol.

The system checks the airbag electrical system for malfunctions. The light tells you if there is an electrical problem. See *Airbag Readiness Light on page 5-10* for more information.

**Where Are the Airbags?**

The driver frontal airbag is in the middle of the steering wheel.

## 3-30 Seats and Restraints



The right front passenger frontal airbag is in the instrument panel on the passenger's side.



### **Driver Side shown, Passenger Side similar**

The roof-rail airbags for the driver, right front passenger, and second row outboard passengers are in the ceiling above the side windows.

### **⚠ WARNING**

If something is between an occupant and an airbag, the airbag might not inflate properly or it might force the object into that person causing severe injury or even death. The path of an inflating airbag must be kept clear. Do not put anything between an occupant and an airbag, and do not attach or put anything on the steering wheel hub or on or near any other airbag covering.

Never secure anything to the roof of a vehicle with roof-rail airbags by routing a rope or tie down through any door or window opening. If you do, the path of an inflating roof-rail airbag will be blocked.

## When Should an Airbag Inflate?

Frontal airbags are designed to inflate in moderate to severe frontal or near-frontal crashes to help reduce the potential for severe injuries mainly to the driver's or right front passenger's head and chest. However, they are only designed to inflate if the impact exceeds a predetermined deployment threshold. Deployment thresholds are used to predict how severe a crash is likely to be in time for the airbags to inflate and help restrain the occupants.

Whether the frontal airbags will or should deploy is not based on how fast your vehicle is traveling. It depends largely on what you hit, the direction of the impact, and how quickly your vehicle slows down.

Frontal airbags may inflate at different crash speeds. For example:

- If the vehicle hits a stationary object, the airbags could inflate at a different crash speed than if the vehicle hits a moving object.
- If the vehicle hits an object that deforms, the airbags could inflate at a different crash speed than if the vehicle hits an object that does not deform.
- If the vehicle hits a narrow object (like a pole), the airbags could inflate at a different crash speed than if the vehicle hits a wide object (like a wall).
- If the vehicle goes into an object at an angle, the airbags could inflate at a different crash speed than if the vehicle goes straight into the object.

Thresholds can also vary with specific vehicle design.

Frontal airbags are not intended to inflate during vehicle rollovers, rear impacts, or in many side impacts.

In addition, the vehicle has dual-stage frontal airbags. Dual-stage airbags adjust the restraint according to crash severity. The vehicle has electronic frontal sensors, which help the sensing system distinguish between a moderate frontal impact and a more severe frontal impact. For moderate frontal impacts, dual-stage airbags inflate at a level less than full deployment. For more severe frontal impacts, full deployment occurs.

The vehicle has roof-rail airbags. See *Airbag System* on page 3-27. Roof-rail airbags are intended to inflate in moderate to severe side crashes. In addition, these roof-rail airbags are intended to inflate during a rollover. Roof-rail airbags will inflate if the crash severity is above the system's designed threshold level. The threshold level can vary with specific vehicle design.

## 3-32 Seats and Restraints

---

Roof-rail airbags are not intended to inflate in rear impacts. Both roof-rail airbags will deploy when either side of the vehicle is struck, or if the sensing system predicts that the vehicle is about to roll over.

In any particular crash, no one can say whether an airbag should have inflated simply because of the damage to a vehicle or because of what the repair costs were.

For frontal airbags, inflation is determined by what the vehicle hits, the angle of the impact, and how quickly the vehicle slows down.

For roof-rail airbags, deployment is determined by the location and severity of the side impact. In a rollover event, roof-rail airbag deployment is determined by the direction of the roll.

### What Makes an Airbag Inflate?

In a deployment event, the sensing system sends an electrical signal triggering a release of gas from the inflator. Gas from the inflator fills the airbag causing the bag to break out of the cover and deploy. The inflator, the airbag, and related hardware are all part of the airbag module.

Frontal airbag modules are located inside the steering wheel and instrument panel. For vehicles with roof-rail airbags, there are airbag modules in the ceiling of the vehicle, near the side windows that have occupant seating positions.

### How Does an Airbag Restrain?

In moderate to severe frontal or near frontal collisions, even belted occupants can contact the steering wheel or the instrument panel. In moderate to severe side collisions, even belted occupants can contact the inside of the vehicle.

Airbags supplement the protection provided by safety belts. Frontal airbags distribute the force of the impact more evenly over the occupant's upper body, stopping the occupant more gradually. Roof-rail airbags distribute the force of the impact more evenly over the occupant's upper body.

Rollover capable roof-rail airbags are designed to help contain the head and chest of occupants in the outboard seating positions in the first and second rows. The rollover capable roof-rail airbags are designed to help reduce the risk of full or partial ejection in rollover events, although no system can prevent all such ejections.

But airbags would not help in many types of collisions, primarily because the occupant's motion is not toward those airbags. See *When Should an Airbag Inflate?* on page 3-31 for more information.

Airbags should never be regarded as anything more than a supplement to safety belts.

## What Will You See After an Airbag Inflates?

After the frontal airbags inflate, they quickly deflate, so quickly that some people may not even realize an airbag inflated. Roof-rail airbags may still be at least partially inflated for some time after they deploy. Some components of the airbag module may be hot for several minutes. For location of the airbag modules, see *What Makes an Airbag Inflate?* on page 3-32.

The parts of the airbag that come into contact with you may be warm, but not too hot to touch. There may be some smoke and dust coming from the vents in the deflated airbags. Airbag inflation does not prevent the driver from seeing out of the windshield or being able to steer the vehicle, nor does it prevent people from leaving the vehicle.

### WARNING

When an airbag inflates, there may be dust in the air. This dust could cause breathing problems for people with a history of asthma or other breathing trouble. To avoid this, everyone in the vehicle should get out as soon as it is safe to do so. If you have breathing problems but cannot get out of the vehicle after an airbag inflates, then get fresh air by opening a window or a door. If you experience breathing problems following an airbag deployment, you should seek medical attention.

The vehicle has a feature that may automatically unlock the doors, turn on the interior lamps and hazard warning flashers, and shut off the fuel system after the airbags inflate.

## 3-34 Seats and Restraints

---

You can lock the doors, turn off the interior lamps and hazard warning flashers by using the controls for those features.

### **WARNING**

A crash severe enough to inflate the airbags may have also damaged important functions in the vehicle, such as the fuel system, brake and steering systems, etc. Even if the vehicle appears to be drivable after a moderate crash, there may be concealed damage that could make it difficult to safely operate the vehicle.

Use caution if you should attempt to restart the engine after a crash has occurred.

If damage to the vehicle is minor, you may attempt to restart the vehicle's engine. Note: If the fuel system has been shut off after an airbag has inflated, you may not be able to restart the engine for up to ten minutes. See *Starting the Engine on page 9-35* for more information.

In many crashes severe enough to inflate the airbag, windshields are broken by vehicle deformation. Additional windshield breakage may also occur from the right front passenger airbag.

- Airbags are designed to inflate only once. After an airbag inflates, you will need some new parts for the airbag system. If you do not get them, the airbag system will not be there

to help protect you in another crash. A new system will include airbag modules and possibly other parts. The service manual for your vehicle covers the need to replace other parts.

- The vehicle has a crash sensing and diagnostic module which records information after a crash. See *Vehicle Data Recording and Privacy on page 13-15* and *Event Data Recorders on page 13-15*.
- Let only qualified technicians work on the airbag systems. Improper service can mean that an airbag system will not work properly. See your dealer for service.

## Passenger Sensing System

The vehicle has a passenger sensing system for the right front passenger position. The passenger airbag status indicator will be visible on the instrument panel when the vehicle is started.



United States



Canada

The words ON and OFF, or the symbol for on and off, are visible during the system check. When the system check is complete, the word

ON or OFF, or the symbol for on or off, will be visible. See *Passenger Airbag Status Indicator* on page 5-11.

The passenger sensing system will turn off the right front passenger frontal airbag under certain conditions. The driver airbags and the roof-rail airbags are not affected by the passenger sensing system.

The passenger sensing system works with sensors that are part of the right front passenger seat and safety belt. The sensors are designed to detect the presence of a properly-seated occupant and determine if the right front passenger frontal airbag should be enabled (may inflate) or not.

According to accident statistics, children are safer when properly secured in a rear seat in the correct child restraint for their weight and size.

We recommend that children be secured in a rear seat, including: an infant or a child riding in a rear-facing child restraint; a child riding in a forward-facing child seat; an older child riding in a booster seat; and children, who are large enough, using safety belts.

## 3-36 Seats and Restraints

A label on the sun visor says, "Never put a rear-facing child seat in the front." This is because the risk to the rear-facing child is so great, if the airbag deploys.

### **WARNING**

A child in a rear-facing child restraint can be seriously injured or killed if the right front passenger airbag inflates. This is because the back of the rear-facing child restraint would be very close to the inflating airbag. A child in a forward-facing child restraint can be seriously injured or killed if the right front passenger airbag inflates and the passenger seat is in a forward position.

(Continued)

### **WARNING (Continued)**

Even if the passenger sensing system has turned off the right front passenger frontal airbag, no system is fail-safe. No one can guarantee that an airbag will not deploy under some unusual circumstance, even though the airbag is turned off.

Secure rear-facing child restraints in a rear seat, even if the airbag is off. If you secure a forward-facing child restraint in the right front seat, always move the front passenger seat as far back as it will go. It is better to secure the child restraint in a rear seat.

The passenger sensing system is designed to turn off the right front passenger frontal airbag if:

- The right front passenger seat is unoccupied.
- The system determines that an infant is present in a rear-facing infant seat.
- The system determines that a small child is present in a child restraint.
- The system determines that a small child is present in a booster seat.
- A right front passenger takes his/her weight off of the seat for a period of time.
- The right front passenger seat is occupied by a smaller person, such as a child who has outgrown child restraints.
- Or, if there is a critical problem with the airbag system or the passenger sensing system.



When the passenger sensing system has turned off the right front passenger frontal airbag, the off indicator will light and stay lit to remind you that the airbag is off. See *Passenger Airbag Status Indicator on page 5-11*.

The passenger sensing system is designed to turn on (may inflate) the right front passenger frontal airbag anytime the system senses that a person of adult size is sitting properly in the right front passenger seat.

When the passenger sensing system has allowed the airbag to be enabled, the on indicator will light and stay lit to remind you that the airbag is active.

For some children who have outgrown child restraints and for very small adults, the passenger sensing system may or may not turn off the right front passenger frontal airbag, depending upon the person seating posture and body build.

Everyone in the vehicle who has outgrown child restraints should wear a safety belt properly — whether or not there is an airbag for that person.

 **WARNING**

If the airbag readiness light ever comes on and stays on, it means that something may be wrong with the airbag system. To help avoid injury to yourself or others, have the vehicle serviced right away. See *Airbag Readiness Light on page 5-10* for more information, including important safety information.

## 3-38 Seats and Restraints

### If the On Indicator is Lit for a Child Restraint

If a child restraint has been installed and the on indicator is lit:

1. Turn the vehicle off.
2. Remove the child restraint from the vehicle.
3. Remove any additional items from the seat such as blankets, cushions, seat covers, seat heaters, or seat massagers.
4. Reinstall the child restraint following the directions provided by the child restraint manufacturer and refer to *Securing Child Restraints (Rear Outboard Seating Position)* on page 3-59 or *Securing Child Restraints (Rear Center Seating Position)* on page 3-61 or *Securing Child Restraints (Right Front Seat Position)* on page 3-62.

5. If, after reinstalling the child restraint and restarting the vehicle, the on indicator is still lit, turn the vehicle off. Then slightly recline the vehicle seatback and adjust the seat cushion, if adjustable, to make sure that the vehicle seatback is not pushing the child restraint into the seat cushion.

Also make sure the child restraint is not trapped under the vehicle head restraint. If this happens, adjust the head restraint. See *Head Restraints* on page 3-2.

6. Restart the vehicle.

If the on indicator is still lit with a child present in a child restraint, secure the child restraint in a rear seat position in the vehicle and check with your dealer.

### If the Off Indicator is Lit for an Adult-Size Occupant



If a person of adult-size is sitting in the right front passenger seat, but the off indicator is lit, it could be because that person is not sitting properly in the seat. If this happens,

use the following steps to allow the system to detect that person and enable the right front passenger frontal airbag:

1. Turn the vehicle off.
2. Remove any additional material from the seat, such as blankets, cushions, seat covers, seat heaters, or seat massagers.
3. Place the seatback in the fully upright position.
4. Have the person sit upright in the seat, centered on the seat cushion, with legs comfortably extended.
5. Restart the vehicle and have the person remain in this position for two to three minutes after the on indicator is lit.

### Additional Factors Affecting System Operation

Safety belts help keep the passenger in position on the seat during vehicle maneuvers and braking, which helps the passenger sensing system maintain the passenger airbag status. See “Safety Belts” and “Child Restraints” in the Index for additional information about the importance of proper restraint use.

If the shoulder portion of the belt is pulled out all the way, the child restraint locking feature will be engaged. This may unintentionally cause the passenger sensing system to turn the airbag off for some adult size occupants. If this happens, just let the belt go back all the way and start again.

A thick layer of additional material, such as a blanket or cushion, or aftermarket equipment such as seat covers, seat heaters, and seat massagers can affect how well the passenger sensing system operates. We recommend that you not use seat covers or other aftermarket equipment except when approved by Hummer for your specific vehicle. See *Adding Equipment to the Airbag-Equipped Vehicle on page 3-40* for more information about modifications that can affect how the system operates.

 **WARNING**

Stowing of articles under the passenger seat or between the passenger seat cushion and seatback may interfere with the proper operation of the passenger sensing system.

### Servicing the Airbag-Equipped Vehicle

Airbags affect how the vehicle should be serviced. There are parts of the airbag system in several places around the vehicle. Your dealer and the service manual have information about servicing the vehicle and the airbag system. To purchase a service manual, see *Service Publications Ordering Information* on page 13-12.

#### **WARNING**

For up to 10 seconds after the ignition is turned off and the battery is disconnected, an airbag can still inflate during improper service. You can be injured if you are close to an airbag when it inflates. Avoid yellow connectors.

(Continued)

#### **WARNING (Continued)**

They are probably part of the airbag system. Be sure to follow proper service procedures, and make sure the person performing work for you is qualified to do so.

### Adding Equipment to the Airbag-Equipped Vehicle

- Q: Is there anything I might add to or change about the vehicle that could keep the airbags from working properly?**
- A:** Yes. If you add things that change the vehicle's frame, bumper system, height, front end or side sheet metal, they may keep the airbag system from working properly. Changing or moving any parts of the front seats, safety belts, the airbag sensing and diagnostic module,

steering wheel, instrument panel, roof-rail airbag modules, ceiling headliner or pillar garnish trim, overhead console, front sensors, side impact sensors, rollover sensor module, or airbag wiring can affect the operation of the airbag system.

In addition, the vehicle has a passenger sensing system for the right front passenger position, which includes sensors that are part of the passenger seat. The passenger sensing system may not operate properly if the original seat trim is replaced with non-Hummer covers, upholstery or trim, or with Hummer covers, upholstery or trim designed for a different vehicle. Any object, such as an aftermarket seat heater or a comfort enhancing pad or device, installed under or

on top of the seat fabric, could also interfere with the operation of the passenger sensing system. This could either prevent proper deployment of the passenger airbag(s) or prevent the passenger sensing system from properly turning off the passenger airbag(s). See *Passenger Sensing System on page 3-35*.

If you have questions, call Customer Assistance. The phone numbers and addresses for Customer Assistance are in Step Two of the Customer Satisfaction Procedure in this manual.

If the vehicle has rollover roof-rail airbags, see *Different Size Tires and Wheels on page 10-60* for additional important information.

**Q: Because I have a disability, I have to get my vehicle modified. How can I find out whether this will affect my airbag system?**

**A:** If you have questions, call Customer Assistance. The phone numbers and addresses for Customer Assistance are in Step Two of the Customer Satisfaction Procedure in this manual.

In addition, your dealer and the service manual have information about the location of the airbag sensors, sensing and diagnostic module and airbag wiring.

## Airbag System Check

The airbag system does not need regularly scheduled maintenance or replacement. Make sure the airbag readiness light is working. See *Airbag Readiness Light on page 5-10* for more information.

**Notice:** If an airbag covering is damaged, opened, or broken, the airbag may not work properly. Do not open or break the airbag coverings. If there are any opened or broken airbag covers, have the airbag covering and/or airbag module replaced. For the location of the airbag modules, see *What Makes an Airbag Inflate?* on page 3-32. See your dealer for service.

### Replacing Airbag System Parts After a Crash

**⚠ WARNING**

A crash can damage the airbag systems in your vehicle. A damaged airbag system may not work properly and may not protect you and your passenger(s) in a crash, resulting in serious injury or even death. To help make sure your airbag systems are working properly after a crash, have them inspected and any necessary replacements made as soon as possible.

If an airbag inflates, you will need to replace airbag system parts. See your dealer for service.

If the airbag readiness light stays on after the vehicle is started or comes on when you are driving, the airbag system may not work properly. Have the vehicle serviced right away. See *Airbag Readiness Light on page 5-10* for more information.

### Child Restraints

#### Older Children



Older children who have outgrown booster seats should wear the vehicle's safety belts.

The manufacturer's instructions that come with the booster seat, state the weight and height limitations for that booster. Use a booster seat with a lap-shoulder belt until the child passes the below fit test:

- Sit all the way back on the seat. Do the knees bend at the seat edge? If yes, continue. If no, return to the booster seat.
- Buckle the lap-shoulder belt. Does the shoulder belt rest on the shoulder? If yes, continue. If no, try using the rear safety belt comfort guide. See "Rear Safety Belt Comfort Guides" under *Lap-Shoulder Belt on page 3-20* for more information. If the shoulder belt still does not rest on the shoulder, then return to the booster seat.

- Does the lap belt fit low and snug on the hips, touching the thighs? If yes, continue. If no, return to the booster seat.
- Can proper safety belt fit be maintained for the length of the trip? If yes, continue. If no, return to the booster seat.

**Q: What is the proper way to wear safety belts?**

**A:** An older child should wear a lap-shoulder belt and get the additional restraint a shoulder belt can provide. The shoulder belt should not cross the face or neck. The lap belt should fit snugly below the hips, just touching the top of the thighs. This applies belt force to the child's pelvic bones in a crash. It should never be worn over the abdomen, which could cause severe or even fatal internal injuries in a crash.

Also see "Rear Safety Belt Comfort Guides" under *Lap-Shoulder Belt on page 3-20*.

According to accident statistics, children and infants are safer when properly restrained in a child restraint system or infant restraint system secured in a rear seating position.

In a crash, children who are not buckled up can strike other people who are buckled up, or can be thrown out of the vehicle. Older children need to use safety belts properly.

### WARNING

Never do this.

Never allow two children to wear the same safety belt. The safety belt can not properly spread the impact forces. In a crash, the two children can be crushed together and seriously injured. A safety belt must be used by only one person at a time.



### WARNING

Never do this.

Never allow a child to wear the safety belt with the shoulder belt behind their back. A child can be seriously injured by not wearing the lap-shoulder belt properly. In a crash, the child would not be restrained by the shoulder belt. The child could move too far forward increasing the chance of head and neck injury. The child might also slide under the lap belt. The belt force would then be applied right on the abdomen. That could cause serious or fatal injuries. The shoulder belt should go over the shoulder and across the chest.



## Infants and Young Children

Everyone in a vehicle needs protection! This includes infants and all other children. Neither the distance traveled nor the age and size of the traveler changes the need, for everyone, to use safety restraints. In fact, the law in every state in the United States and in every Canadian province says children up to some age must be restrained while in a vehicle.



**⚠ WARNING**

Children can be seriously injured or strangled if a shoulder belt is wrapped around their neck and the safety belt continues to tighten. Never leave children unattended in a vehicle and never allow children to play with the safety belts.

Airbags plus lap-shoulder belts offer protection for adults and older children, but not for young children and infants. Neither the vehicle's safety belt system nor its airbag system is designed for them. Every time infants and young children ride in vehicles, they should have the protection provided by appropriate child restraints.

Children who are not restrained properly can strike other people, or can be thrown out of the vehicle.

**⚠ WARNING**

Never do this.

Never hold an infant or a child while riding in a vehicle. Due to crash forces, an infant or a child will become so heavy it is not possible to hold it during a crash. For example, in a crash at only 40 km/h (25 mph), a 5.5 kg (12 lb) infant will suddenly become a 110 kg (240 lb) force on a person's arms. An infant should be secured in an appropriate restraint.



### WARNING

Never do this.

Children who are up against, or very close to, any airbag when it inflates can be seriously injured or killed. Never put a rear-facing child restraint in the right front seat. Secure a rear-facing child restraint in a rear seat. It is also better to secure a forward-facing child restraint in a rear seat. If you must secure a forward-facing child restraint in the right front seat, always move the front passenger seat as far back as it will go.



### **Q: What are the different types of add-on child restraints?**

**A:** Add-on child restraints, which are purchased by the vehicle's owner, are available in four basic types. Selection of a particular restraint should take into consideration not only the child's weight, height, and age but also whether or not the restraint will be compatible with the motor vehicle in which it will be used.

For most basic types of child restraints, there are many different models available. When purchasing a child restraint, be sure it is designed to be used in a motor vehicle. If it is, the restraint will have a label saying that it meets federal motor vehicle safety standards.

The restraint manufacturer's instructions that come with the restraint state the weight and height limitations for a particular child restraint. In addition, there are many kinds of restraints available for children with special needs.

**⚠ WARNING**

To reduce the risk of neck and head injury during a crash, infants need complete support. This is because an infant's neck is not fully developed and its head weighs so much compared with the rest of its body. In a crash, an infant in a rear-facing child restraint settles into the restraint, so the crash forces can be distributed across the strongest part of an infant's body, the back and shoulders. Infants should always be secured in rear-facing child restraints.

**⚠ WARNING**

A young child's hip bones are still so small that the vehicle's regular safety belt may not remain low on the hip bones, as it should. Instead, it may settle up around the child's abdomen. In a crash, the belt would apply force on a body area that is unprotected by any bony structure. This alone could cause serious or fatal injuries. To reduce the risk of serious or fatal injuries during a crash, young children should always be secured in appropriate child restraints.

**Child Restraint Systems**



**(A) Rear-Facing Infant Seat**

A rear-facing infant seat (A) provides restraint with the seating surface against the back of the infant.

The harness system holds the infant in place and, in a crash, acts to keep the infant positioned in the restraint.



**(B) Forward-Facing Child Seat**

A forward-facing child seat (B) provides restraint for the child's body with the harness.



**(C) Booster Seats**

A booster seat (C) is a child restraint designed to improve the fit of the vehicle's safety belt system. A booster seat can also help a child to see out the window.

**Securing an Add-On Child Restraint in the Vehicle**

**⚠ WARNING**

A child can be seriously injured or killed in a crash if the child restraint is not properly secured in the vehicle. Secure the child restraint properly in the vehicle using the vehicle's safety belt or LATCH system, following the instructions that came with that child restraint and the instructions in this manual.

To help reduce the chance of injury, the child restraint must be secured in the vehicle. Child restraint systems must be secured in vehicle seats by lap belts or the lap belt portion of a lap-shoulder belt, or by the LATCH system.

See *Lower Anchors and Tethers for Children (LATCH System)* on page 3-51 for more information. Children can be endangered in a crash if the child restraint is not properly secured in the vehicle.

When securing an add-on child restraint, refer to the instructions that come with the restraint which may be on the restraint itself or in a booklet, or both, and to this manual. The child restraint instructions are important, so if they are not available, obtain a replacement copy from the manufacturer.

Keep in mind that an unsecured child restraint can move around in a collision or sudden stop and injure people in the vehicle. Be sure to properly secure any child restraint in the vehicle — even when no child is in it.

### Securing the Child Within the Child Restraint

 **WARNING**

A child can be seriously injured or killed in a crash if the child is not properly secured in the child restraint. Secure the child properly following the instructions that came with that child restraint.

### Where to Put the Restraint

According to accident statistics, children and infants are safer when properly restrained in a child restraint system or infant restraint system secured in a rear seating position.

We recommend that children and child restraints be secured in a rear seat, including: an infant or a child riding in a rear-facing child restraint; a child riding in a forward-facing child seat; an older child riding in a booster seat; and children, who are large enough, using safety belts.

## 3-50 Seats and Restraints

A label on the sun visor says, "Never put a rear-facing child restraint in the front." This is because the risk to the rear-facing child is so great, if the airbag deploys.

### **WARNING**

A child in a rear-facing child restraint can be seriously injured or killed if the right front passenger airbag inflates. This is because the back of the rear-facing child restraint would be very close to the inflating airbag. A child in a forward-facing child restraint can be seriously injured or killed if the right front passenger airbag inflates and the passenger seat is in a forward position.

(Continued)

### **WARNING (Continued)**

Even if the passenger sensing system has turned off the right front passenger frontal airbag, no system is fail-safe. No one can guarantee that an airbag will not deploy under some unusual circumstance, even though it is turned off.

Secure rear-facing child restraints in a rear seat, even if the airbag is off. If you secure a forward-facing child restraint in the right front seat, always move the front passenger seat as far back as it will go. It is better to secure the child restraint in a rear seat.

See *Passenger Sensing System* on page 3-35 for additional information.

When securing a child restraint in a rear seating position, study the instructions that came with the child restraint to make sure it is compatible with this vehicle.

Wherever a child restraint is installed, be sure to secure the child restraint properly.

Keep in mind that an unsecured child restraint can move around in a collision or sudden stop and injure people in the vehicle. Be sure to properly secure any child restraint in the vehicle — even when no child is in it.

## Lower Anchors and Tethers for Children (LATCH System)

The LATCH system holds a child restraint during driving or in a crash. This system is designed to make installation of a child restraint easier. The LATCH system uses anchors in the vehicle and attachments on the child restraint that are made for use with the LATCH system.

Make sure that a LATCH-compatible child restraint is properly installed using the anchors, or use the vehicle's safety belts to secure the restraint, following the instructions that came with that restraint, and also the instructions in this manual.

When installing a child restraint with a top tether, you must also use either the lower anchors or the safety belts to properly secure the child restraint. A child restraint must never be installed using only the top tether and anchor.

In order to use the LATCH system in the vehicle, you need a child restraint that has LATCH attachments. The child restraint manufacturer will provide you with instructions on how to use the child restraint and its attachments. The following explains how to attach a child restraint with these attachments in the vehicle.

Not all vehicle seating positions or child restraints have lower anchors and attachments or top tether anchors and attachments.

### Lower Anchors

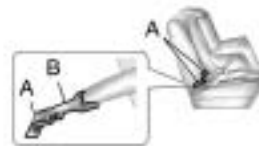

Lower anchors (A) are metal bars built into the vehicle. There are two lower anchors for each LATCH seating position that will accommodate a child restraint with lower attachments (B).

## 3-52 Seats and Restraints

### Top Tether Anchor

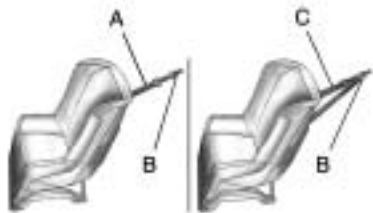

A top tether (A, C) anchors the top of the child restraint to the vehicle. A top tether anchor is built into the vehicle. The top tether attachment (B) on the child restraint connects to the top tether anchor in the vehicle in order to reduce the forward movement and rotation of the child restraint during driving or in a crash.

The child restraint may have a single tether (A) or a dual tether (C). Either will have a single attachment (B) to secure the top tether to the anchor.



Some child restraints that have a top tether are designed for use with or without the top tether being attached. Others require the top tether always to be attached. In Canada, the law requires that forward-facing child restraints have a top tether, and that the tether be attached. Be sure to read and follow the instructions for the child restraint.

If the child restraint does not have a top tether, one can be obtained, in kit form, for many child restraints. Ask the child restraint manufacturer whether or not a kit is available.

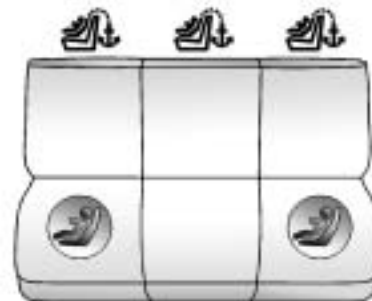
### Lower Anchor and Top Tether Anchor Locations



#### Rear Seat

-  (Top Tether Anchor): Seating positions with top tether anchors.
-  (Lower Anchor): Seating positions with two lower anchors.

Each outboard seating position in the rear seat has exposed metal lower anchors in the crease between the seatback and the seat cushion.





For H3T models, the top tether anchor symbol is located near the top tether anchors to assist you in locating the top tether anchors.

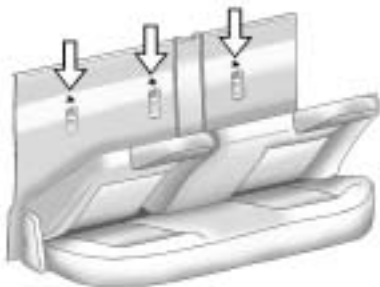

**H3T**

For H3T models, the top tether anchors are located on the back panel behind each rear seating position. Be sure to use an anchor

located on the same side of the vehicle as the seating position where the child restraint will be placed.

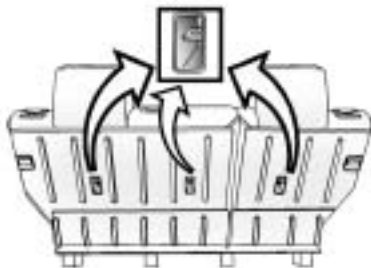

**H3**

For H3 models, the top tether anchors are located on the back of the rear seatbacks. Be sure to use an anchor located on the same side of the vehicle as the seating position where the child restraint will be placed.

Do not secure a child restraint in a position without a top tether anchor if a national or local law requires that the top tether be attached, or if the instructions that come with the child restraint say that the top tether must be attached.

According to accident statistics, children and infants are safer when properly restrained in a child restraint system or infant restraint system secured in a rear seating position. See *Where to Put the Restraint* on page 3-49 for additional information.

## 3-54 Seats and Restraints

### Securing a Child Restraint Designed for the LATCH System

#### WARNING

If a LATCH-type child restraint is not attached to anchors, the child restraint will not be able to protect the child correctly. In a crash, the child could be seriously injured or killed. Install a LATCH-type child restraint properly using the anchors, or use the vehicle's safety belts to secure the restraint, following the instructions that came with the child restraint and the instructions in this manual.

#### WARNING

Do not attach more than one child restraint to a single anchor. Attaching more than one child restraint to a single anchor could cause the anchor or attachment to come loose or even break during a crash. A child or others could be injured. To reduce the risk of serious or fatal injuries during a crash, attach only one child restraint per anchor.

#### WARNING

Children can be seriously injured or strangled if a shoulder belt is wrapped around their neck and the safety belt continues to tighten. Buckle any unused safety belts behind the child restraint so children cannot reach them.

(Continued)

#### WARNING (Continued)

Pull the shoulder belt all the way out of the retractor to set the lock, if your vehicle has one, after the child restraint has been installed.

**Notice:** Do not let the LATCH attachments rub against the vehicle's safety belts. This may damage these parts. If necessary, move buckled safety belts to avoid rubbing the LATCH attachments.

Do not fold the empty rear seat with a safety belt buckled. This could damage the safety belt or the seat. Unbuckle and return the safety belt to its stowed position, before folding the seat.

**H3T Models**

1. If the child restraint manufacturer recommends that the top tether be attached, attach and tighten the top tether to the top tether anchor (A), if equipped. Refer to the child restraint instructions and the following steps:

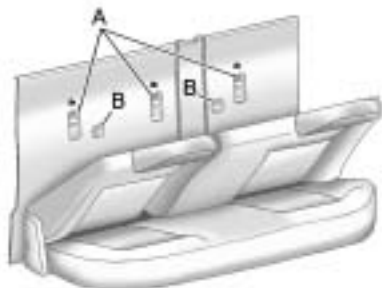

- 1.1. Put the child restraint on the seat.
- 1.2. Pull the seatback forward to access the top tether anchors (A). See *Rear Seats (H3) on page 3-7*

or *Rear Seats (H3T) on page 3-9* for additional information.

- 1.3. Route the top tether according to the child restraint instructions and the following instructions:



If the position you are using does not have a headrest or head restraint and you are using a single tether, route the tether over the seatback.



If the position you are using does not have a headrest or head restraint and you are using a dual tether, route the tether over the seatback.



If the position you are using has a fixed headrest or head restraint and you are using a single tether, route the tether over the headrest or head restraint.



If the position you are using has a fixed headrest or head restraint and you are using a dual tether, route the tether around the headrest or head restraint.

- 1.4. Attach the top tether to the anchor (A). Make sure that you secure the top tether to the top tether anchor and not to the seatback latch (B).

- 1.5. Push rearward on the seatback until it locks into its upright position. Push and pull on the seatback to make sure it is secured properly.

2. Attach and tighten the lower attachments to the lower anchors. If the child restraint does not have lower attachments or the desired seating position does not have lower anchors, secure the child restraint with the top tether and the safety belts. Refer to the child restraint manufacturer instructions and the instructions in this manual.
  - 2.1. Find the lower anchors for the desired seating position.
  - 2.2. Attach and tighten the lower attachments on the child restraint to the lower anchors.

3. Tighten the top tether.

If the headrest interferes with the installation of the child restraint, remove the headrest by pressing the button on the headrest post, at the top of the seatback, and lift to remove. Store the headrest under the outboard side of the rear seat.

4. Push and pull the child restraint in different directions to be sure it is secure.

When removing the child restraint, reinsert the headrest if it has been removed from the seatback.

**H3 Models**

1. Attach and tighten the lower attachments to the lower anchors. If the child restraint does not have lower attachments or the desired

seating position does not have lower anchors, secure the child restraint with the top tether and the safety belts. Refer to the child restraint manufacturer instructions and the instructions in this manual.

- 1.1. Find the lower anchors for the desired seating position.
- 1.2. Put the child restraint on the seat.
- 1.3. Attach and tighten the lower attachments on the child restraint to the lower anchors.

2. If the child restraint manufacturer recommends that the top tether be attached, attach and tighten the top tether to the top tether anchor, if equipped. Refer to the child restraint instructions and the following steps:

- 2.1. Find the top tether anchor.

2.2. Route, attach and tighten the top tether according to the child restraint instructions and the following instructions:



If the position you are using does not have a headrest or head restraint and you are using a single tether, route the tether over the seatback.

## 3-58 Seats and Restraints

---



If the position you are using does not have a headrest or head restraint and you are using a dual tether, route the tether over the seatback.



If the position you are using has a fixed headrest or head restraint and you are using a single tether, route the tether over the headrest or head restraint.



If the position you are using has a fixed headrest or head restraint and you are using a dual tether, route the tether around the headrest or head restraint.

3. Push and pull the child restraint in different directions to be sure it is secure.

## Replacing LATCH System Parts After a Crash

 **WARNING**

A crash can damage the LATCH system in the vehicle. A damaged LATCH system may not properly secure the child restraint, resulting in serious injury or even death in a crash. To help make sure the LATCH system is working properly after a crash, see your dealer to have the system inspected and any necessary replacements made as soon as possible.

If the vehicle has the LATCH system and it was being used during a crash, new LATCH system parts may be needed.

New parts and repairs may be necessary even if the LATCH system was not being used at the time of the crash.

## Securing Child Restraints (Rear Outboard Seating Position)

When securing a child restraint in a rear seating position, study the instructions that came with the child restraint to make sure it is compatible with this vehicle.

If the child restraint has the LATCH system, see *Lower Anchors and Tethers for Children (LATCH System)* on page 3-51 for how and where to install the child restraint using LATCH. If a child restraint is secured in the vehicle using a safety belt and it uses a top tether, see *Lower Anchors and Tethers for Children (LATCH System)* on page 3-51 for top tether anchor locations.

Do not secure a child seat in a position without a top tether anchor if a national or local law requires that the top tether be anchored, or if the instructions that come with the child restraint say that the top strap must be anchored.

In Canada, the law requires that forward-facing child restraints have a top tether, and that the tether be attached.

If the child restraint does not have the LATCH system, you will be using the safety belt to secure the child restraint in this position. Be sure to follow the instructions that came with the child restraint. Secure the child in the child restraint when and as the instructions say.

## 3-60 Seats and Restraints

If more than one child restraint needs to be installed in the rear seat, be sure to read *Where to Put the Restraint* on page 3-49.

1. Put the child restraint on the seat.
2. Pick up the latch plate, and run the lap and shoulder portions of the vehicle's safety belt through or around the restraint. The child restraint instructions will show you how.



3. For H3T models, tilt the latch plate to adjust the belt if needed.



4. Push the latch plate into the buckle until it clicks.  
Position the release button on the buckle so that the safety belt could be quickly unbuckled if necessary.



5. For H3 models, pull the rest of the shoulder belt all the way out of the retractor to set the lock.





6. To tighten the belt, push down on the child restraint, pull the shoulder portion of the belt to tighten the lap portion of the belt and feed the shoulder belt back into the retractor. When installing a forward-facing child restraint, it may be helpful to use your knee to push down on the child restraint as you tighten the belt.
7. If the child restraint has a top tether, follow the child restraint manufacturer's instructions regarding the use of the top tether. See *Lower Anchors and Tethers for Children (LATCH System)* on page 3-51 for more information.  
  
For H3T models, if the headrest interferes with the installation of the child restraint, remove the headrest by pressing the button on the headrest post, at the top of the seatback, and lift to remove. Store the headrest under the outboard side of the rear seat.
8. Push and pull the child restraint in different directions to be sure it is secure.  
  
To remove the child restraint, unbuckle the vehicle safety belt and let it return to the stowed position. If the top tether is attached to a top tether anchor, disconnect it. If the headrest has been removed, reinsert it onto the seatback.

## Securing Child Restraints (Rear Center Seating Position)

Many child restraints are too wide to be correctly secured in the center rear seat, although some of them will fit there. If the center seat position is too narrow for the child restraint, secure it in a rear outside seat position.

If a child restraint is secured in the center seat position, follow the instructions in *Securing Child Restraints (Rear Outboard Seating Position)* on page 3-59 or *Securing Child Restraints (Rear Center Seating Position)* on page 3-61 or *Securing Child Restraints (Right Front Seat Position)* on page 3-62.

## Securing Child Restraints (Right Front Seat Position)

The vehicle has airbags. A rear seat is a safer place to secure a forward-facing child restraint. See *Where to Put the Restraint on page 3-49*.

In addition, the vehicle has a passenger sensing system which is designed to turn off the right front passenger frontal airbag under certain conditions. See *Passenger Sensing System on page 3-35* and *Passenger Airbag Status Indicator on page 5-11* for more information, including important safety information.

A label on the sun visor says, "Never put a rear-facing child seat in the front." This is because the risk to the rear-facing child is so great, if the airbag deploys.

### WARNING

A child in a rear-facing child restraint can be seriously injured or killed if the right front passenger airbag inflates. This is because the back of the rear-facing child restraint would be very close to the inflating airbag. A child in a forward-facing child restraint can be seriously injured or killed if the right front passenger airbag inflates and the passenger seat is in a forward position.

Even if the passenger sensing system has turned off the right front passenger frontal airbag, no system is fail-safe. No one can guarantee that an airbag will not deploy under some unusual circumstance, even though it is turned off.

(Continued)

### WARNING (Continued)

Secure rear-facing child restraints in a rear seat, even if the airbag is off. If you secure a forward-facing child restraint in the right front seat, always move the front passenger seat as far back as it will go. It is better to secure the child restraint in a rear seat.

See *Passenger Sensing System on page 3-35* for additional information.

If the child restraint has the LATCH system, see *Lower Anchors and Tethers for Children (LATCH System) on page 3-51* for how and where to install the child restraint using LATCH. If a child restraint is secured using a safety belt and it uses a top tether, see *Lower Anchors and Tethers for Children (LATCH System) on page 3-51* for top tether anchor locations.

Do not secure a child seat in a position without a top tether anchor if a national or local law requires that the top tether be anchored, or if the instructions that come with the child restraint say that the top strap must be anchored.

In Canada, the law requires that forward-facing child restraints have a top tether, and that the tether be attached.

You will be using the lap-shoulder belt to secure the child restraint in this position. Follow the instructions that came with the child restraint.

1. Move the seat as far back as it will go before securing the forward-facing child restraint.

When the passenger sensing system has turned off the right front passenger frontal airbag, the off indicator on the passenger airbag status indicator should light and stay lit when the vehicle is started. See *Passenger Airbag Status Indicator* on page 5-11.

2. Put the child restraint on the seat.
3. Pick up the latch plate, and run the lap and shoulder portions of the vehicle's safety belt through or around the restraint. The child restraint instructions will show you how.



4. Push the latch plate into the buckle until it clicks.  
Position the release button on the buckle so that the safety belt could be quickly unbuckled if necessary.



5. Pull the rest of the shoulder belt all the way out of the retractor to set the lock.

## 3-64 Seats and Restraints

---



6. To tighten the belt, push down on the child restraint, pull the shoulder portion of the belt to tighten the lap portion of the belt and feed the shoulder belt back into the retractor. When installing a forward-facing child restraint, it may be helpful to use your knee to push down on the child restraint as you tighten the belt.
7. Push and pull the child restraint in different directions to be sure it is secure.

If the airbag is off, the off indicator in the passenger airbag status indicator will come on and stay on when the vehicle is started.

If a child restraint has been installed and the on indicator is lit, see "If the On Indicator is Lit for a Child Restraint" under *Passenger Sensing System* on page 3-35 for more information.

To remove the child restraint, unbuckle the vehicle safety belt and let it return to the stowed position.

# Storage

## Storage Compartments

- Glove Box ..... 4-1
- Cupholders ..... 4-1
- Front Storage ..... 4-1
- Center Console Storage ..... 4-1

## Additional Storage Features

- Rear Compartment/Storage
  - Panel Cover ..... 4-2
  - Cargo Cover ..... 4-2
  - Cargo Tie Downs ..... 4-2
- Cargo Management System ..... 4-2
- Convenience Net ..... 4-3

## Roof Rack System

- Roof Rack System ..... 4-4

# Storage Compartments

## Glove Box

Open the glove box by pulling up on the bottom of the handle.

## Cupholders

The vehicle may have cupholders in front of the front armrest storage area and in the lower area of the driver and front passenger doors.

The H3 may also have a cupholder in the center of the rear bench seat. Pull down on the cover to open the cupholder.

The H3T may have cupholders in the rear seat and cup/bottle holders located on the bottom of the rear doors.

# Front Storage

The vehicle has a storage net located on the back of each front seat. To remove a net, pull out on the four clips.

# Center Console Storage

A two tiered storage area is located in the center console. To open, lift the latch on the front and pull up. Pull out the top storage area to access storage underneath.

### Additional Storage Features

#### Rear Compartment/ Storage Panel Cover

The H3 has a rear storage area located on the passenger side of the cargo area. To open it, pull the two tabs out and open lid.

#### Cargo Cover

**Notice:** Do not put items onto the cargo cover. The weight of the items could cause the attachment clips to break. The cargo cover could no longer be attached and used. The repairs would not be covered by the warranty. Never put anything on top of the cargo cover.

The vehicle may have a cargo cover. It can be used to cover items in the rear of the vehicle. To install the cover, place the loops on each corner of the cover on the four hooks in the rear of the vehicle. The cover should be stored securely when not in use.

#### Cargo Tie Downs

There may be four cargo tie-downs that can be moved on the tracks located on the roof. To move, loosen the tie-down counterclockwise. Turn clockwise to tighten and lock in place.

### Cargo Management System

The vehicle comes with a cargo management system located in the bed of the vehicle. The system contains three rails located on the front and sides of the bed.

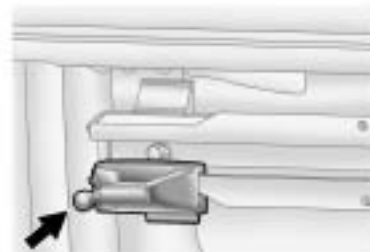

The system has four adjustable cargo tie-downs, that can be placed on the upper and lower slides of the rail.

To adjust a tie-down, pull the locator pin out and move the tie-down to another location making sure the locator pin lines up with a locator hole on the rail. The tie-down pin may not be installed correctly if the pin does not line up, turn it over and reinstall. The tie-down will not move when the pin is completely installed. The maximum load for each rail is 227 kg (500 lbs).

The rails are notched at each end which allows the tie-downs to be removed and placed on another rail. To remove, pull the locator pin out and slide the tie-down to the end of the rail and pull back.

To remove or install cargo tie-downs at the front of the bed, slide the corner cap towards the center of the bed to expose the rail notches. To remove the corner cap, pull either edge away from the rail.

To remove the system, loosen the toggle bolts on each rail until they can be removed from the bed of the truck. To replace the system, place the toggle bolts and rails into their original locations and tighten them to a torque setting of 17N•m (12.5 ft-lbs).

**Notice:** If cargo is tied down using the horizontal slots on the top of the pickup box, the box could be damaged and would not be covered by the vehicle warranty. Only use the tie-down loops if the vehicle does not have the cargo management system.

### Convenience Net

Use the convenience net, located in the rear, to store small loads as far forward as possible. The net should not be used to store heavy loads.

### Roof Rack System

 **WARNING**

If something is carried on top of the vehicle that is longer or wider than the roof rack— like paneling, plywood, or a mattress— the wind can catch it while the vehicle is being driven. The item being carried could be violently torn off, and this could cause a collision, and damage the vehicle. Never carry something longer or wider than the roof rack on top of the vehicle unless using a HUMMER Certified accessory carrier.

For vehicles with a roof rack, the rack can be used to load items. For roof racks that do not have crossrails included, HUMMER Certified crossrails can be purchased as an accessory. See your dealer for additional information.

**Notice:** Loading cargo on the roof rack that weighs more than 113 kg (250 lbs) or hangs over the rear or sides of the vehicle may damage the vehicle. Load cargo so that it rests evenly between the crossrails, making sure to fasten cargo securely.

To prevent damage or loss of cargo when driving, check to make sure crossrails and cargo are securely fastened. Loading cargo on the roof rack will make the vehicle's center of gravity higher. Avoid high speeds, sudden starts, sharp turns, sudden braking or abrupt maneuvers, otherwise it may result in loss of control. If driving for a long distance, on rough roads, or at high speeds, occasionally stop the vehicle to make sure the cargo remains in its place. Do not exceed the maximum vehicle capacity when loading the vehicle. For more information on vehicle capacity and loading, see *Vehicle Load Limits* on page 9-27.



## Adjusting the Crossrails

To adjust the crossrails to fit a load:



1. Turn the crossrail key counterclockwise to unlock the crossrail end cap.
2. Remove the end cap.



3. Pull the lever labeled "PULL" from left to right to loosen the crossrail.

4. Repeat Steps 1 through 3 to the opposite end of the crossrail.
5. Once both sides of the crossrail are loose, adjust the crossrail to the desired position.
6. Push the lever labeled "PULL" from right to left to lock the crossrail in place.
7. Reinstall the end cap and turn the crossrail key to lock the crossrail.
8. Repeat Steps 5 through 7 to the opposite end of the crossrail.

## Stop Tabs

If the vehicle has a sunroof, it has a crossrail stop tab in the siderail. This tab prevents the crossrail from being moved past the opening of the sunroof and cargo from being loaded too far forward.

The vehicle may have cargo tie downs. Once the cargo is loaded onto the crossrails, use the cargo tie downs to secure it. Do not load cargo directly on the roof of the vehicle. See *Vehicle Load Limits* on page 9-27 for more information.



# Instruments and Controls

## Controls

Steering Wheel Adjustment . . .	5-2
Horn . . . . .	5-2
Windshield Wiper/Washer . . . .	5-2
Rear Window Wiper/ Washer . . . . .	5-3
Compass . . . . .	5-3
Clock . . . . .	5-4
Power Outlets . . . . .	5-5
Cigarette Lighter . . . . .	5-5
Ashtrays . . . . .	5-6

## Warning Lights, Gauges, and Indicators

Warning Lights, Gauges, and Indicators . . . . .	5-6
Instrument Cluster . . . . .	5-7
Speedometer . . . . .	5-8
Odometer . . . . .	5-8
Trip Odometer . . . . .	5-8

Tachometer . . . . .	5-8
Fuel Gauge . . . . .	5-8
Engine Coolant Temperature Gauge . . . . .	5-9
Safety Belt Reminders . . . . .	5-9
Airbag Readiness Light . . . . .	5-10
Passenger Airbag Status Indicator . . . . .	5-11
Charging System Light . . . . .	5-11
Malfunction Indicator Lamp . . . . .	5-12
Brake System Warning Light . . . . .	5-14
Antilock Brake System (ABS) Warning Light . . . . .	5-15
Up-Shift Light . . . . .	5-15
Traction Control System (TCS)/StabiliTrak <sup>®</sup> Light . . . .	5-16
Tire Pressure Light . . . . .	5-16
Engine Oil Pressure Light . . . .	5-17
Security Light . . . . .	5-17
High-Beam on Light . . . . .	5-17
Cruise Control Light . . . . .	5-18

## Information Displays

Driver Information Center (DIC) . . . . .	5-18
--	------

## Vehicle Messages

Vehicle Messages . . . . .	5-21
Battery Voltage and Charging Messages . . . . .	5-21
Brake System Messages . . . . .	5-22
Door Ajar Messages . . . . .	5-22
Engine Cooling System Messages . . . . .	5-23
Engine Oil Messages . . . . .	5-23
Engine Power Messages . . . . .	5-23
Fuel System Messages . . . . .	5-24
Lamp Messages . . . . .	5-24
Ride Control System Messages . . . . .	5-24
Service Vehicle Messages . . . .	5-25
Tire Messages . . . . .	5-25
Transmission Messages . . . . .	5-25

## Universal Remote System

Universal Remote System . . . . .	5-26
Universal Remote System Programming . . . . .	5-26
Universal Remote System Operation . . . . .	5-30

### Controls

#### Steering Wheel Adjustment

A tilt wheel allows the steering wheel to be adjusted.



The tilt lever is on the left side of the steering column.

To tilt, hold the steering wheel and pull the tilt lever toward you. Raise or lower the wheel to a comfortable level, then release the tilt lever to lock the wheel in place.



Do not adjust the steering wheel while driving.

#### Horn

Press near the horn symbols or press on the steering wheel pad to sound the horn.

#### Windshield Wiper/Washer

Turn the band with the  symbol to control the windshield wipers.

 **(Mist):** Turn to  for a single wipe, then release. For several wipes, hold the band on  longer.

 **(Adjustable Interval Wipes):** Turn the band up for more frequent wipes or down for less frequent wipes.

 : Slow wipes, turn the band to the first solid position past the delay settings.



 : Fast wipes, turn the band to the second solid position past the delay settings.

 **(Off):** Turns the wipers off.

Clear ice and snow from the wiper blades before using them. If frozen to the windshield, carefully loosen or thaw them. If they become worn or damaged, install new blades or blade inserts. See *Wiper Blade Replacement on page 10-32*

Windshield wipers work in all power modes, except when the ignition is set to LOCK/OFF. After the engine is turned off, wipers will work in Retained Accessory Power (RAP) mode until a door is opened. See *Retained Accessory Power (RAP) on page 9-35*.

**Windshield Washer**

 **(Washer Fluid):** To spray washer fluid on the windshield, push the paddle marked with  at the top of the turn signal/lane change lever. The wipers will clear the window and then either stop or return to the preset speed.

**WARNING**

In freezing weather, do not use your washer until the windshield is warmed. Otherwise the washer fluid can form ice on the windshield, blocking your vision.

**Rear Window Wiper/Washer**

For vehicles with this feature, the knob is located on the instrument panel below the climate controls.

 **(Rear Wiper):** Turn to 1 for a slower wiping speed or to 2 for a faster wiping speed.

**0 (Off):** Turn to 0 for off.

 **(Washer Fluid):** Press to wash and wipe the window.

The rear window washer uses the same fluid bottle as the windshield washer. Check the fluid level if the windshield can be washed, but the rear windows cannot.

**Compass****Compass Display**

The inside rearview mirror may have a compass display. Press  to turn the compass display on or off.

## 5-4 Instruments and Controls

### Compass Calibration

The compass may need to be calibrated if CAL is not displayed and the compass requires calibration. Press and hold  until CAL displays in the compass window, then release the button. The compass is now in calibration mode.

- Drive the vehicle in circles at less than 8 km/h (5 mph) until CAL is no longer displayed in the compass window. Then continue to drive to make sure all eight directions are available.
- Drive the vehicle under normal operating conditions.

### Compass Variance

The mirror is set to zone eight. If you do not live in zone eight or drive out of the area, the compass variance needs to be changed to the appropriate zone.

To adjust for compass variance:

1. Find your current location and variance zone number on the following zone map.

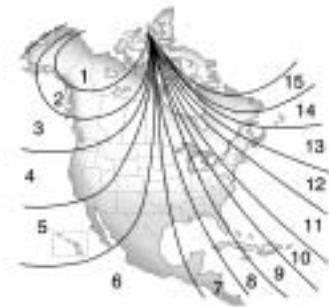

2. Press and hold  for six seconds until ZONE displays. Release the button. The compass is now in zone mode.

3. Keep pressing  until the desired zone number displays. Release the button. After four seconds, the new zone number locks in and the compass display returns.

### Clock

The clock can be set with the ignition on or off. Use the H and M buttons located on the lower left side of the radio.

To set the clock:

1. Press and hold H until the correct hour and AM or PM displays.
2. Press and hold M until the correct minute displays.

Press DISP (Display) to display the time while the ignition is turned off.

## Power Outlets

The accessory power outlets can be used to connect auxiliary electrical equipment, such as a cellular phone.

There are two accessory power outlets located under the climate control system. There is also one accessory power outlet located in the rear cargo area (H3 model only). Pull down the small cover to access the accessory power outlet.

**Notice:** Leaving electrical equipment on for extended periods will drain the battery. Always unplug electrical equipment when not in use and do not plug in equipment that exceeds the maximum amperage rating of 20 amperes.

Certain electrical accessories may not be compatible with the accessory power outlet and could result in blown vehicle or adapter fuses. If you experience a problem, see your dealer for additional information on accessory power outlets.

**Notice:** Adding any electrical equipment to the vehicle can damage it or keep other components from working as they should. The repairs would not be covered by the vehicle warranty. Do not use equipment exceeding maximum amperage rating of 20 amperes. Check with your dealer before adding electrical equipment.

When adding electrical equipment, be sure to follow the proper installation instructions included with the equipment.

**Notice:** Improper use of the power outlet can cause damage not covered by the vehicle warranty. Do not hang any type of accessory or accessory bracket from the plug because the power outlets are designed for accessory power plugs only.

## Cigarette Lighter

For vehicles with a lighter, push the lighter down and it will pop up when it is ready to be used.

**Notice:** Holding a cigarette lighter in while it is heating does not let the lighter back away from the heating element when it is hot. Damage from overheating can occur to the lighter or heating element, or a fuse could be blown. Do not hold a cigarette lighter in while it is heating.

### Ashtrays

For vehicles with a removable ashtray, it can be placed into the cupholder and be removed for cleaning.

**Notice: If papers, pins, or other flammable items are put in the ashtray, hot cigarettes or other smoking materials could ignite them and possibly damage the vehicle. Never put flammable items in the ashtray.**

### Warning Lights, Gauges, and Indicators

Warning lights and gauges can signal that something is wrong before it becomes serious enough to cause an expensive repair or replacement. Paying attention to the warning lights and gauges could prevent injury.

Warning lights come on when there could be a problem with a vehicle function. Some warning lights come on briefly when the engine is started to indicate they are working.

Gauges can indicate when there could be a problem with a vehicle function. Often gauges and warning lights work together to indicate a problem with the vehicle.

When one of the warning lights comes on and stays on while driving, or when one of the gauges shows there may be a problem, check the section that explains what to do. Follow this manual's advice. Waiting to do repairs can be costly and even dangerous.



## Instrument Cluster

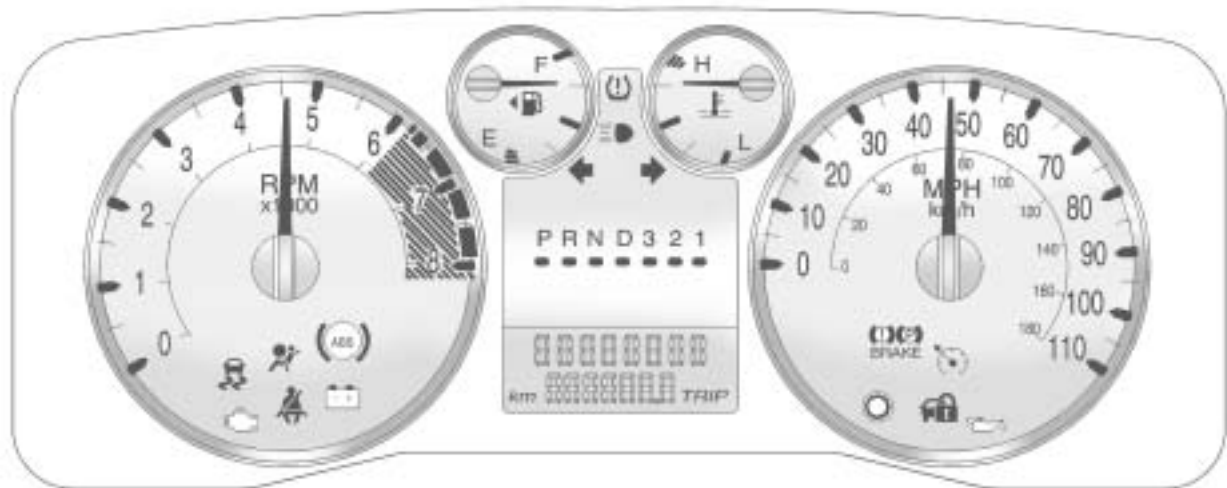

United States 3.7L L5 Automatic Transmission version shown, 5.3L V8, Canada and Manual Transmission similar

## 5-8 Instruments and Controls

### Speedometer

The speedometer shows the vehicle's speed in both kilometers per hour (km/h) and miles per hour (mph).

### Odometer

The odometer shows how far the vehicle has been driven, in either kilometers or miles.

This vehicle has a tamper-resistant odometer. If the vehicle needs a new odometer installed, the new one is set to the mileage of the old odometer. If this is not possible, it is set at zero and a label is put on the driver's door to show the old mileage reading.

### Trip Odometer

The vehicle has a trip odometer that indicates how far the vehicle has been driven since the trip odometer was last set to zero.

See "Trip Odometer" under *Driver Information Center (DIC) on page 5-18* for more information.

### Tachometer

The tachometer displays the engine speed in revolutions per minute (rpm).

### Fuel Gauge

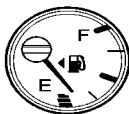

United States



Canada

The fuel gauge indicates about how much fuel there is remaining in the fuel tank. The ignition must be in ON/RUN.

An arrow on the fuel gauge indicates the side of the vehicle the fuel door is on.

Here are three things that can happen but do not indicate a problem with the fuel gauge:

- At the gas station, the gas pump shuts off before the gauge reads full.
- It takes a little more or less fuel to fill up than the gauge indicated. For example, the gauge may have indicated the tank was half full, but it actually took a little more or less than half the tank's capacity to fill the tank.
- The gauge moves a little when turning a corner or speeding up.

When the fuel in the fuel tank is low, a LOW FUEL message displays on the Driver Information Center (DIC). See *Fuel System Messages on page 5-24* for more information.

## Engine Coolant Temperature Gauge

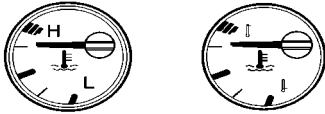

United States

Canada

This gauge shows the engine coolant temperature.

If the gauge pointer is in the shaded area of the gauge, the engine is too hot. It means that the engine coolant has overheated. If the vehicle has been operating under normal driving conditions, pull off the road, stop your vehicle and turn off the engine as soon as possible.

See *Engine Overheating* on page 10-22 for more information.

## Safety Belt Reminders

### Driver Safety Belt Reminder Light

There is a driver safety belt reminder light on the instrument panel cluster.



When the engine is started this light and a chime come on and stay on for several seconds to remind drivers to fasten their safety belts. The light also begins to flash.

This cycle repeats if the driver remains unbuckled and the vehicle is moving.

If the driver safety belt is already buckled, neither the light nor chime come on.

### Passenger Safety Belt Reminder Light

The passenger safety belt reminder light is by the passenger airbag status indicator.



When the engine is started this light and the chime come on and stay on for several seconds to remind the passenger to fasten their safety belt. The light also begins to flash.

This cycle repeats if the passenger remains unbuckled and the vehicle is moving.

If the passenger safety belt is buckled, neither the chime nor the light comes on.

## 5-10 Instruments and Controls

The front passenger safety belt warning light and chime may turn on if an object is put on the seat such as a briefcase, handbag, grocery bag, laptop or other electronic device. To turn off the warning light and or chime, remove the object from the seat or buckle the safety belt.

### Airbag Readiness Light

There is an airbag readiness light on the instrument panel cluster, which shows the airbag symbol. The system checks the airbag's electrical system for malfunctions. The light indicates if there is an electrical problem. The system check includes the airbag sensor, the pretensioners, the airbag

modules, the wiring and the crash sensing and diagnostic module. For more information on the airbag system, see *Airbag System* on page 3-27.



This light comes on when the vehicle is started, and flashes for a few seconds. The light goes out when the system is ready.

If the airbag readiness light stays on after the vehicle is started or comes on while driving, the airbag system may not work properly. Have the vehicle serviced right away.

### WARNING

If the airbag readiness light stays on after the vehicle is started or comes on while driving, it means the airbag system might not be working properly. The airbags in the vehicle might not inflate in a crash, or they could even inflate without a crash. To help avoid injury, have the vehicle serviced right away.

The airbag readiness light should flash for a few seconds when the engine is started. If the light does not come on then, have it fixed immediately.

## Passenger Airbag Status Indicator

The vehicle has the passenger sensing system. See *Passenger Sensing System* on page 3-35 for important safety information. The instrument panel has a passenger airbag status indicator.



United States



Canada

When the vehicle is started, the passenger airbag status indicator will light ON and OFF, or the symbol for on and off, for several seconds

as a system check. Then, after several more seconds, the status indicator will light either ON or OFF, or either the on or off symbol to let you know the status of the right front passenger frontal airbag.

If the word ON or the on symbol is lit on the passenger airbag status indicator, it means that the right front passenger frontal airbag is enabled (may inflate).

If the word OFF or the off symbol is lit on the airbag status indicator, it means that the passenger sensing system has turned off the right front passenger frontal airbag.

If, after several seconds, both status indicator lights remain on, or if there are no lights at all, there may be a problem with the lights or the passenger sensing system. See your dealer for service.

### WARNING

If the airbag readiness light ever comes on and stays on, it means that something may be wrong with the airbag system. To help avoid injury to yourself or others, have the vehicle serviced right away. See *Airbag Readiness Light* on page 5-10 for more information, including important safety information.

## Charging System Light



This light comes on briefly when the ignition key is turned, but the engine is not running, as a check to show it is working.

## 5-12 Instruments and Controls

---

It should go out once the engine starts. If it stays on, or comes on while driving, there could be a problem with the charging system. A charging system message in the Driver Information Center (DIC) may also appear. See *Battery Voltage and Charging Messages on page 5-21* for more information. This light could indicate that there are problems with a generator drive belt, or that there is an electrical problem. Have it checked right away. If the vehicle must be driven a short distance with the light on, turn off all the accessories, such as the radio and air conditioner.

### Malfunction Indicator Lamp

A computer system called OBD II (On-Board Diagnostics-Second Generation) monitors operation of the fuel, ignition, and emission control systems. It ensures that

emissions are at acceptable levels for the life of the vehicle, helping to produce a cleaner environment.



This light comes on when the ignition is on, but the engine is not running, as a check to show it is working. If it does not, have the vehicle serviced by your dealer.

If the check engine light comes on and stays on, while the engine is running, this indicates that there is an OBD II problem and service is required.

Malfunctions often are indicated by the system before any problem is apparent. Being aware of the light can prevent more serious damage to the vehicle. This system assists the service technician in correctly diagnosing any malfunction.

**Notice:** If the vehicle is continually driven with this light on, after a while, the emission controls might not work as well, the vehicle's fuel economy might not be as good, and the engine might not run as smoothly. This could lead to costly repairs that might not be covered by the vehicle warranty.

**Notice:** Modifications made to the engine, transmission, exhaust, intake, or fuel system of the vehicle or the replacement of the original tires with other than those of the same Tire Performance Criteria (TPC) can affect the vehicle's emission controls and can cause this light to come on. Modifications to these systems could lead to costly repairs not covered by the vehicle warranty. This could also result in a failure to pass a required Emission Inspection/Maintenance test. See *Accessories and Modifications on page 10-3*.

This light comes on during a malfunction in one of two ways:

**Light Flashing:** A misfire condition has been detected. A misfire increases vehicle emissions and could damage the emission control system on the vehicle. Diagnosis and service might be required.

The following can prevent more serious damage to the vehicle:

- Reduce vehicle speed.
- Avoid hard accelerations.
- Avoid steep uphill grades.
- If towing a trailer, reduce the amount of cargo being hauled as soon as it is possible.

If the light continues to flash, when it is safe to do so, stop the vehicle. Find a safe place to park the vehicle. Turn the key off, wait at least 10 seconds, and restart the engine. If the light is still flashing, follow the previous steps and see your dealer for service as soon as possible.

**Light On Steady:** An emission control system malfunction has been detected on the vehicle. Diagnosis and service might be required.

An emission system malfunction might be corrected.

- Make sure the fuel cap is fully installed. See *Filling the Tank on page 9-68*. The diagnostic system can determine if the fuel cap has been left off or improperly installed. A loose or missing fuel cap allows fuel to evaporate into the atmosphere. A few driving trips with the cap properly installed should turn the light off.
- If the vehicle has been driven through a deep puddle of water, the vehicle's electrical system might be wet. The condition is usually corrected when the electrical system dries out. A few driving trips should turn the light off.

- Make sure to fuel the vehicle with quality fuel. Poor fuel quality causes the engine not to run as efficiently as designed and may cause: stalling after start-up, stalling when the vehicle is changed into gear, misfiring, hesitation on acceleration, or stumbling on acceleration. These conditions might go away once the engine is warmed up.

If one or more of these conditions occurs, change the fuel brand used. It will require at least one full tank of the proper fuel to turn the light off.

See *Recommended Fuel on page 9-64*.

If none of the above have made the light turn off, your dealer can check the vehicle. The dealer has the proper test equipment and diagnostic tools to fix any mechanical or electrical problems that might have developed.

## 5-14 Instruments and Controls

### Emissions Inspection and Maintenance Programs

Some state/provincial and local governments have or might begin programs to inspect the emission control equipment on the vehicle. Failure to pass this inspection could prevent getting a vehicle registration.

Here are some things to know to help the vehicle pass an inspection:

- The vehicle will not pass this inspection if the check engine light is on with the engine running, or if the key is in ON/RUN and the light is not on.
- The vehicle will not pass this inspection if the OBD II (on-board diagnostic) system determines that critical emission control systems have not been completely diagnosed by the system. The vehicle would be considered not ready for inspection. This can happen if

the battery has recently been replaced or if the battery has run down. The diagnostic system is designed to evaluate critical emission control systems during normal driving. This can take several days of routine driving. If this has been done and the vehicle still does not pass the inspection for lack of OBD II system readiness, your dealer can prepare the vehicle for inspection.

### Brake System Warning Light

The vehicle's hydraulic brake system is divided into two parts. If one part is not working, the other part can still work and stop the vehicle. For good braking though, both parts need to be working well.

If the warning light comes on, there could be a brake problem. Have the brake system inspected right away.



United States



Canada

This light comes on briefly when the ignition key is turned to ON/RUN. If it does not, have it fixed so it will be ready to warn if there is a problem.

When the ignition is on, the brake system warning light comes on when the parking brake is set. See *Parking Brake on page 9-51* for more information. The light stays on if the parking brake does not release fully. If it stays on after the parking brake is fully released, it means there is a brake problem.



If the light comes on while driving, pull off the road and stop. The brake pedal might be harder to push, or it might go closer to the floor. It can take longer to stop. If the light is still on, have the vehicle towed for service. See *Towing the Vehicle on page 10-90*.

 **WARNING**

The brake system might not be working properly if the brake system warning light is on. Driving with the brake system warning light on can lead to a crash. If the light is still on after the vehicle has been pulled off the road and carefully stopped, have the vehicle towed for service.

## Antilock Brake System (ABS) Warning Light



For vehicles with the Antilock Brake System (ABS), this light comes on briefly when the engine is started. If it does not, have the vehicle serviced by your dealer. If the system is working normally the indicator light will then go off.

If the ABS light stays on, turn the ignition off. If the light comes on while driving, stop as soon as it is safely possible and turn the ignition off. Then start the engine again to reset the system. If the ABS light stays on, or comes on again while driving, the vehicle needs service. If the regular brake system warning light is not on, the vehicle still has brakes, but not antilock brakes.

If the regular brake system warning light is also on, the vehicle does not have antilock brakes and there is a problem with the regular brakes. See *Brake System Warning Light on page 5-14*.

For vehicles with a Driver Information Center (DIC), see *Brake System Messages on page 5-22* for more information.

## Up-Shift Light



The vehicle may have an up-shift light.

When this light comes on, shift to the next higher gear if weather, road, and traffic conditions allow.

See *Manual Transmission on page 9-44* for more information.

### Traction Control System (TCS)/StabiliTrak<sup>®</sup> Light



The StabiliTrak system or the Traction Control System (TCS) indicator/warning light comes on briefly while starting the engine.

If it does not, have the vehicle serviced by your dealer. If the system is working normally the indicator light will then go off.

The indicator/warning light flashes while the StabiliTrak or TCS system is working to control the vehicle on a low traction surface.

If the TCS warning light comes on and stays on while driving, the vehicle needs service.

The light comes on when the TCS and the StabiliTrak system is turned off. If the TCS is off, wheel spin is not limited. If the StabiliTrak system is off, the system does not assist in controlling the vehicle. Turn on the TCS and the StabiliTrak system and the warning light turns off.

See *StabiliTrak System* on page 9-53 and *Traction Control System (TCS)* on page 9-52 for more information

### Tire Pressure Light



For vehicles with a tire pressure monitoring system, this light comes on briefly when the engine is started. It provides information about tire pressures and the Tire Pressure Monitoring System.

#### When the Light is On Steady

This indicates that one or more of the tires are significantly underinflated.

A tire pressure message in the Driver Information Center (DIC), can accompany the light. See *Tire Messages* on page 5-25 for more information. Stop as soon as possible, and inflate the tires to the pressure value shown on the tire loading information label. See *Tire Pressure* on page 10-51 for more information.

#### When the Light Flashes First and Then is On Steady

This indicates that there may be a problem with the Tire Pressure Monitor System. The light flashes for about a minute and stays on steady for the remainder of the ignition cycle. This sequence repeats with every ignition cycle. See *Tire Pressure Monitor Operation* on page 10-53 for more information.

## Engine Oil Pressure Light

### WARNING

Do not keep driving if the oil pressure is low. The engine can become so hot that it catches fire. Someone could be burned. Check the oil as soon as possible and have the vehicle serviced.

**Notice:** Lack of proper engine oil maintenance can damage the engine. The repairs would not be covered by the vehicle warranty. Always follow the maintenance schedule in this manual for changing engine oil.



The oil pressure light should come on briefly as the engine is started. If it does not come on have the vehicle serviced by your dealer.

If the light comes on and stays on, it means that oil is not flowing through the engine properly. The vehicle could be low on oil and might have some other system problem. See your dealer.

## Security Light



This light flashes when the security system is activated.

For more information, see *Anti-Theft Alarm System* on page 2-9.

## High-Beam on Light



The high-beam on light comes on when the high-beam headlamps are in use.

See *Headlamp High/Low-Beam Changer* on page 6-3 for more information.

## Cruise Control Light



This light comes on whenever the cruise control is set.

The light goes out when the cruise control is turned off. See *Cruise Control* on page 9-57 for more information.

## Information Displays

### Driver Information Center (DIC)

The Driver Information Center (DIC) displays information such as the trip odometer, personalization features, and warning messages. The DIC display is located on the instrument panel cluster.

The DIC comes on when the ignition is on.

If a problem is detected, a warning message appears on the display. Pressing and releasing the trip odometer reset stem on the DIC acknowledges some current warnings or service messages. Some messages only clear after the required action has been taken.

The DIC has different modes which can be accessed by pressing the trip odometer reset stem on the DIC. These modes are explained in the following section. The DIC trip odometer reset stem is located on

the instrument panel cluster next to the DIC display. To scroll through the available functions, press and release the reset stem.

### Trip Information

#### Odometer

The odometer is automatically displayed on the DIC when you start the vehicle. The odometer shows the total distance the vehicle has been driven in either miles for the United States or kilometers for Canada.

#### Trip Odometer

Press and release the reset stem until TRIP appears on the DIC display. The trip odometer shows the current distance traveled since the last reset of the trip odometer in either miles for the United States or kilometers for Canada.

To reset the trip odometer, press and hold the reset stem until the display returns to zero.

## Engine Oil Life System

With the engine off, turn the key to ON/RUN and then press the reset stem until OIL LIFE RESET appears — alternating between OIL LIFE and RESET — on the DIC display. The CHANGE OIL message alerts you to change the oil on a schedule consistent with your driving conditions. Always reset the OIL LIFE message after an oil change. To reset the message, see *Engine Oil Life System on page 10-11*.

In addition to the engine oil life system monitoring the oil life, additional maintenance is recommended in the Maintenance Schedule in this manual. See *Engine Oil on page 10-9* and *Scheduled Maintenance on page 11-2* for more information.

## Language

This feature allows you to choose the language in which the DIC display shows information.

To set your choice for this feature:

1. With the engine off, turn the key to ON/RUN, but do not start the engine.
2. Close all doors so the DOORS message does not display in the DIC.
3. Momentarily press and release the reset stem until the current language is displayed: English (default), Spanish, or French.
4. To select a different language, press and hold the reset stem until the next language appears.

5. Repeat Step 4 until the desired language is displayed. Once the desired language is shown on the DIC display, the language is set.
6. To exit the language selection, momentarily press and release the reset stem. All DIC messages will now display in the language selected.

## Automatic Door Locks

This feature allows you to program the door locks to a preferred setting.

To set your choice for this feature:

1. With the engine off, turn the key to LOCK/OFF. Do not remove the key from the ignition.
2. Press and hold the power door lock button until the DIC display shows the current door lock mode.

## 5-20 Instruments and Controls

---

3. To view the next available mode, press and hold the reset stem until the mode appears. Release the reset stem and press and hold again to view the next mode.
4. Once the desired mode is shown on the DIC display, briefly press the reset stem to set your choice. The DIC display then clears.

The following are the available modes:

**Lock 1 (default):** On vehicles with an automatic transmission, this mode locks all of the doors when the vehicle is shifted out of P (Park) and unlocks all of the doors when the vehicle is shifted into P (Park).

On vehicles with a manual transmission, this mode locks all of the doors when the vehicle speed is greater than 24 km/h (15 mph) and unlocks all of the doors when the key is removed from the ignition.

**Lock 2:** On vehicles with an automatic transmission, this mode locks all of the doors when the vehicle is shifted out of P (Park) and unlocks the driver's door when the vehicle is shifted into P (Park).

On vehicles with a manual transmission, this mode locks all of the doors when the vehicle speed is greater than 24 km/h (15 mph) and unlocks the driver's door when the key is removed from the ignition.

**Lock 3:** On vehicles with an automatic transmission, this mode locks all of the doors when the vehicle is shifted out of P (Park). The doors will not automatically unlock.

On vehicles with a manual transmission, this mode locks all of the doors when the vehicle speed is greater than 24 km/h (15 mph). The doors will not automatically unlock.

### Remote Keyless Entry (RKE) Feedback

This feature allows you to program the Remote Keyless Entry (RKE) feedback to a preferred setting.

To set your choice for this feature:

1. With the engine off, turn the key to LOCK/OFF. Do not remove the key from the ignition.
2. Press and hold the lock and unlock buttons on the RKE transmitter at the same time. Hold both buttons until the DIC display shows the current RKE feedback mode.
3. To view the next available mode, press and hold the reset stem until the mode appears. Release the reset stem and press and hold again to view the next mode.
4. Once the desired mode is shown on the DIC display, briefly press the reset stem to set your choice. The DIC display then clears.

The following are the available modes:

**RFA 1 (default):** This mode flashes the parking lamps when you press the lock or unlock buttons on the RKE transmitter.

**RFA 2:** This mode flashes the parking lamps and sounds the horn when you press the lock button on the RKE transmitter. This mode also flashes the parking lamps when you press the unlock button on the RKE transmitter.

**RFA 3:** This mode flashes the parking lamps and sounds the horn when you press the lock or unlock buttons on the RKE transmitter.

**RFA 4:** This mode disables RKE feedback. There will be no feedback when you press the lock or unlock buttons on the RKE transmitter.

## Vehicle Messages

Messages are displayed on the DIC to notify the driver that the status of the vehicle has changed and that some action may be needed by the driver to correct the condition. Multiple messages may appear one after another. The messages are displayed for several seconds each.

Some messages may not require immediate action, but you should press and release the trip odometer reset stem to acknowledge that you received the messages and to clear them from the display. Each message must be acknowledged individually.

Some messages cannot be cleared from the DIC display because they are more urgent. These messages require action before they can be cleared. You should take any messages that appear on the

display seriously and remember that clearing the messages only makes the messages disappear, not correct the problem.

The following are the possible messages that can be displayed and some information about them.

## Battery Voltage and Charging Messages

### **SERVICE CHARG (Charge) SYS (System)**

This message displays if there is a problem with the battery charging system. Under certain conditions, the battery warning light may also turn on in the instrument panel cluster. See *Charging System Light on page 5-11*. The battery will not be charging at an optimal rate and the vehicle will lose the ability to enter the fuel economy mode.

## 5-22 Instruments and Controls

---

The vehicle is safe to drive, however have the electrical system checked by your dealer. Press and release the reset stem to acknowledge the message and clear it from the display.

### Brake System Messages

#### ABS (Antilock Brake System) FAULT

This message displays if there is a problem with the Antilock Brake System (ABS). Check the ABS as soon as possible and have the vehicle serviced by your dealer. See *Antilock Brake System (ABS) on page 9-50* and *Antilock Brake System (ABS) Warning Light on page 5-15* for more information. Press and release the reset stem to acknowledge the message and clear it from the display.

#### BRAKES

This message displays if there is a problem with the brakes. Check the brakes as soon as possible and have the vehicle serviced by your dealer. See *Brakes on page 10-26* and *Brake System Warning Light on page 5-14* for more information. Press and release the reset stem to acknowledge the message and clear it from the display.

#### FLUID

This message displays if the brake fluid is low. Check the brake fluid as soon as possible and have the vehicle serviced by your dealer. See *Brake Fluid on page 10-27* for more information. Press and release the reset stem to acknowledge the message and clear it from the display.

#### HSA (Hill Start Assist) ON

This message displays when the Hill Start Assist is enabled. See *Hill Start Assist (HSA) on page 9-52* for more information.

#### PARK BRK (Brake)

This message displays when the parking brake is set. See *Parking Brake on page 9-51* and *Brake System Warning Light on page 5-14* for more information. The message clears from the display after the parking brake is released or by pressing and releasing the reset stem.

#### Door Ajar Messages

##### DOORS

This message displays when one or more of the doors is ajar. Check all the doors on the vehicle to make sure they are closed. The message clears from the display after all of the doors are closed.



## Engine Cooling System Messages

### AC (Air Conditioning) OFF

This message displays when the engine coolant temperature is too high and the air conditioning in the vehicle needs to be turned off. See *Engine Overheating on page 10-22* and *Climate Control Systems on page 8-1* for more information. This message displays along with the ENG HOT message.

### ENG (Engine) HOT

This message displays when the engine coolant temperature is hot. Check the engine coolant temperature gauge. See *Engine Coolant Temperature Gauge on page 5-9*. Have the vehicle serviced by your dealer as soon as possible if you suspect the engine is overheating. See *Engine Overheating on page 10-22* for more information.

## Engine Oil Messages

### CHANGE OIL

This message displays when the oil needs to be changed. Check the oil in the vehicle as soon as possible and have the vehicle serviced by your dealer. See *Engine Oil on page 10-9* and *Scheduled Maintenance on page 11-2* for more information. Press and release the reset stem to acknowledge the message and clear it from the display.

### OIL

This message displays when the oil pressure is low. See *Engine Oil Pressure Light on page 5-17* and *Engine Oil on page 10-9* for more information.

## Engine Power Messages

### REDUCED POWER

This message displays when the vehicle's engine power is reduced. Reduced engine power can affect the vehicle's ability to accelerate. If this message is on, but there is no reduction in performance, proceed to your destination. The performance may be reduced the next time the vehicle is driven. The vehicle may be driven at a reduced speed while this message is on, but acceleration and speed may be reduced. Anytime this message stays on, the vehicle should be taken to your dealer for service as soon as possible. Press and release the reset stem to acknowledge the message and clear it from the display.

### Fuel System Messages

#### FUEL CAP

This message displays if the vehicle's fuel cap is either off or loose. Pull over as soon as possible and check to see if the fuel cap is secure. You may also see the check engine light on the instrument panel cluster. If the check engine light does come on when the fuel cap was loose, it may take a few driving trips before the light turns off. See *Malfunction Indicator Lamp on page 5-12* for more information if the light still remains on. Press and release the reset stem to acknowledge the message and clear it from the display.

#### LOW FUEL

This message displays if the level of fuel in the vehicle is low. Also check the fuel gauge. See *Fuel Gauge on page 5-8* for more information. Refill the fuel tank as soon as possible.

### Lamp Messages

#### TURN SIGNAL

This message displays when the turn signal is on for about 1.2 km (0.75 miles) of travel. Press and release the reset stem to acknowledge the message and clear it from the display.

### Ride Control System Messages

#### SERVICE STAB (Stability) SYS (System)

This message displays if there is a problem with the StabiliTrak<sup>®</sup> system. Have the vehicle serviced by your dealer. See *StabiliTrak System on page 9-53* for more information.

#### STAB (Stability) SYS (System) OFF

This message displays when the StabiliTrak<sup>®</sup> system is turned off. See *StabiliTrak System on page 9-53* for more information.

#### TRAC (Traction) OFF

This message along with the traction off light displays when the Traction Control System (TCS) is turned off by pressing the TCS button. See *Traction Control System (TCS) on page 9-52* and *Traction Control System (TCS)/StabiliTrak<sup>®</sup> Light on page 5-16* for more information.

## TRACTION FAILED

This message displays if there is a problem with the Traction Control System (TCS). Check the TCS as soon as possible and have the vehicle serviced by your dealer. See *Traction Control System (TCS)/StabiliTrak® Light on page 5-16* for more information. Press and release the reset stem to acknowledge the message and clear it from the display.

## Service Vehicle Messages

### SERV (Service) VEH (Vehicle)

This message displays if the vehicle needs service. Have the vehicle serviced by your dealer as soon as possible.

## Tire Messages

### LOW TIRE

On vehicles with the Tire Pressure Monitor System (TPMS), this message displays if a low tire pressure is detected in any of the vehicle's tires. Press and release the reset stem to acknowledge the message and clear it from the display. The message appears at each ignition cycle until the tires are inflated to the correct inflation pressure. See *Tires on page 10-44* and *Tire Pressure on page 10-51* for more information on tires and the correct inflation pressures.

### SERV (Service) TPM (Tire Pressure Monitor)

On vehicles with the Tire Pressure Monitor System (TPMS), this message displays if a part on the TPMS is not working properly. The tire pressure light also flashes

and then remains on during the same ignition cycle. See *Tire Pressure Light on page 5-16*. Several conditions may cause this message to appear. See *Tire Pressure Monitor Operation on page 10-53* for more information. If the warning comes on and stays on, there may be a problem with the TPMS. See your dealer.

## Transmission Messages

### SERV (Service) 4WD (Four-Wheel Drive)

This message displays when there is a problem with the transfer case control system. Check the transfer case on the vehicle and have it serviced by your dealer. See *Four-Wheel Drive on page 9-46* for more information about the transfer case. Press and release the reset stem to acknowledge the message and clear it from the display.

## Universal Remote System

See *Radio Frequency Statement on page 13-16* for information regarding Part 15 of the Federal Communications Commission (FCC) Rules and RSS-210/211 of Industry and Science Canada.

The FCC Grant of Equipment Authorization Certificate number is CB2SAHL3.

The Canadian Registration ID number is 2791021849A.

## Universal Remote System Programming



This system provides a way to replace up to three remote control transmitters used to activate devices such as garage door openers, security systems, and home automation devices.

Do not use the Universal Home Remote with any garage door opener that does not have the stop and reverse feature. This includes any garage door opener model manufactured before April 1, 1982.

Read the instructions completely before attempting to program the Universal Home Remote. Because of the steps involved, it may be helpful to have another person available to assist you with programming the Universal Home Remote.

Keep the original hand-held transmitter for use in other vehicles as well as for future Universal Home Remote programming. It is also recommended that upon the sale of the vehicle, the programmed Universal Home Remote buttons should be erased for security purposes. See “Erasing Universal Home Remote Buttons” later in this section.

When programming a garage door, park outside of the garage. Park directly in line with and facing the garage door opener motor-head or gate motor-head. Be sure that people and objects are clear of the garage door or gate that is being programmed.

It is recommended that a new battery be installed in your hand-held transmitter for quicker and more accurate transmission of the radio-frequency signal.

### Programming the Universal Home Remote System

For questions or help programming the Universal Home Remote System, call 1-800-355-3515 or go to [www.homelink.com](http://www.homelink.com).

Programming a garage door opener involves time-sensitive actions, so read the entire procedure before starting. Otherwise, the device will time out and the procedure will have to be repeated.

To program up to three devices:



1. From inside the vehicle, press and hold down the two outside buttons at the same time, releasing only when the Universal Home Remote indicator light begins to flash, after 20 seconds. This step will erase the factory settings or all previously programmed buttons.  
Do not hold down the buttons for longer than 30 seconds and do not repeat this step to program the remaining two Universal Home Remote buttons.

2. Hold the end of your hand-held transmitter about 3 to 8 cm (1 to 3 inches) away from the Universal Home Remote buttons while keeping the indicator light in view. The hand-held transmitter was supplied by the manufacturer of your garage door opener receiver (motor head unit).
3. At the same time, press and hold both the Universal Home Remote button to be used to control the garage door and the hand-held transmitter button. Do not release the Universal Home Remote button or the hand-held transmitter button until Step 4 has been completed.  
Some entry gates and garage door openers may require substitution of Step 3 with the procedure noted in "Gate Operator and Canadian Programming" later in this section.

## 5-28 Instruments and Controls

---

4. The indicator light on the Universal Home Remote will flash slowly at first and then rapidly after Universal Home Remote successfully receives the frequency signal from the hand-held transmitter. Release both buttons.
5. Press and hold the newly-trained Universal Home Remote button and observe the indicator light.
  - If the indicator light stays on continuously, the programming is complete and the garage door should move when the Universal Home Remote button is pressed and released. There is no need to continue programming Steps 6 through 8.

- If the Universal Home Remote indicator light blinks rapidly for two seconds and then turns to a constant light, continue with the programming Steps 6 through 8.

It may be helpful to have another person assist with the remaining steps.



6. After Steps 1 through 5 have been completed, locate inside the garage the garage door opener receiver (motor-head unit). Locate the “Learn” or “Smart” button. The name and color of the button may vary by manufacturer.
7. Firmly press and release the “Learn” or “Smart” button. After you press this button, you will have 30 seconds to complete Step 8.

8. Immediately return to the vehicle. Firmly press and hold the Universal Home Remote button, selected in Step 3 to control the garage door, for two seconds, and then release it. If the garage door does not move, press and hold the same button a second time for two seconds, and then release it. Again, if the door does not move, press and hold the same button a third time for two seconds, and then release.

The Universal Home Remote should now activate the garage door.

To program the remaining two Universal Home Remote buttons, begin with Step 2 of "Programming the Universal Home Remote System." Do not repeat Step 1, as this will erase all previous programming from the Universal Home Remote buttons.

### **Gate Operator and Canadian Programming**

If you have questions or need help programming the Universal Home Remote System, call 1-800-355-3515 or go to [www.homelink.com](http://www.homelink.com).

Canadian radio-frequency laws require transmitter signals to time out or quit after several seconds of transmission. This may not be long enough for Universal Home Remote to pick up the signal during programming. Similarly, some U.S. gate operators are manufactured to time out in the same manner.

If you live in Canada, or you are having difficulty programming a gate operator or garage door opener by using the "Programming Universal Home Remote" procedures, regardless of where you live, replace Step 3 under "Programming Universal Home Remote" with the following:

Continue to press and hold the Universal Home Remote button while you press and release every two seconds (cycle) the hand-held transmitter button until the frequency signal has been successfully accepted by the Universal Home Remote. The Universal Home Remote indicator light will flash slowly at first and then rapidly. Proceed with Step 4 under "Programming Universal Home Remote" to complete the training procedure.

### Universal Remote System Operation

#### Using Universal Remote

Press and hold the appropriate Universal Remote button for at least half of a second. The indicator light will come on while the signal is being transmitted.

#### Erasing Universal Remote Buttons

All programmed buttons should be erased when the vehicle is sold or the lease ends.

To erase all programmed buttons on the Universal Remote device:

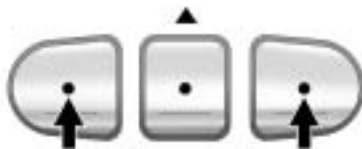

1. Press and hold down the two outside buttons until the indicator light begins to flash, after 20 seconds.
2. Release both buttons.

#### Reprogramming a Single Universal Remote Button

To reprogram any of the three Universal Remote buttons, repeat the programming instructions earlier in this section, beginning with Step 2.

For help or information on the Universal Home Remote System, call the customer assistance phone number under *Customer Assistance Offices* on page 13-3.



## Lighting

### Exterior Lighting

Exterior Lamp Controls .....	6-1
Exterior Lamps Off Reminder .....	6-3
Headlamp High/Low-Beam Changer .....	6-3
Flash-to-Pass .....	6-3
Daytime Running Lamps (DRL) .....	6-3
Automatic Headlamp System .....	6-4
Hazard Warning Flashers .....	6-5

Turn and Lane-Change Signals .....	6-5
Fog Lamps .....	6-6
Off-Road Lamps .....	6-6

### Interior Lighting

Instrument Panel Illumination Control .....	6-7
Dome Lamps .....	6-7
Reading Lamps .....	6-8

### Lighting Features

Exit Lighting .....	6-8
Battery Load Management .....	6-8
Battery Power Protection .....	6-9

## Exterior Lighting

### Exterior Lamp Controls



The exterior lamps control is on the instrument panel to the left of the steering wheel.

**☀ (Exterior Lamps):** Turn the control to select one of the four exterior lamp positions.

## 6-2 Lighting

---

○ (**Off**): Turns all exterior lamps and the Daytime Running Lamps (DRL) off. This is a momentary control that returns to AUTO when released. The DRL does not turn off on vehicles first sold in Canada, unless the following conditions are met:

- The vehicle has an automatic transmission.
- The gear position is in P (Park).
- The headlamp switch is turned to ○.

**AUTO (Automatic)**: Turns the headlamps on and off automatically, together with the following:

- Sidemarker Lamps
- Taillamps
- Parking Lamps
- Instrument Panel Lights

Due to the momentary control, the automatic headlamps may be disabled even if the control is in the AUTO position.

To enable automatic lighting, do any of the following:

- Turn the headlamp control from AUTO to off and release the control. It returns to the AUTO position by itself.
- Turn the headlamp control from the parking lamp or headlamp position to AUTO.

To disable automatic lighting, do any of the following:

- Turn the headlamp control from AUTO to off and release the control. It returns back to the AUTO position by itself.
- Turn the headlamp control from AUTO to the parking lamp or headlamp position.

See *Automatic Headlamp System on page 6-4* for more information.

Vehicles first sold in Canada with an automatic transmission cannot turn off automatic headlamps unless the gear position is in P (Park) and the headlamp control is turned to ⏻.

Vehicles first sold in Canada with a manual transmission can turn off the automatic headlamps with the headlamp control; however, the parking lamps will remain on.

☸ (**Parking Lamps**): Turns on the parking lamps, together with the following:

- Sidemarker Lamps
- Taillamps
- License Plate Lamps
- Instrument Panel Lights

⦿ (**Headlamps**): Turns on the headlamps together with the previously listed lamps and lights.

The headlamps can be switched from low to high beam by pushing the turn signal/lane change lever toward the instrument panel.

## Exterior Lamps Off Reminder

A headlamp reminder chime will sound if the following conditions are met:

- The driver door is open.
- Parking lamps or headlamps are manually turned on.
- The key is either not in the ignition switch, or it is in the LOCK/OFF position of the ignition switch.

The headlamp reminder cannot be turned off if the conditions listed above are met.

In the automatic mode, the headlamps turn off once the ignition is in ACC/ACCESSORY.

## Headlamp High/Low-Beam Changer

 **Headlamp High/Low Beam Changer:** Push the turn signal/lane change lever away from you to turn the high beams on.

Pull the lever towards you to return to low beams.



This indicator light turns on in the instrument panel cluster when the high beam headlamps are on.

## Flash-to-Pass

Pull the turn signal lever toward you, then release it, to signal that you are going to pass.

If the headlamps are in the automatic position or on low beam, the high-beam headlamps will turn on. They stay on as long as the lever is held toward you. The high-beam indicator on the instrument panel cluster will come on. Release the lever to return to normal operation.

## Daytime Running Lamps (DRL)

Daytime Running Lamps (DRL) can make it easier for others to see the front of your vehicle during the day. Fully functional daytime running lamps are required on all vehicles first sold in Canada.

## 6-4 Lighting

---

The DRL system comes on when the following conditions are met:

- The ignition is on.
- The exterior lamps control is in AUTO.
- The transmission is not in P (Park), if the vehicle has an automatic transmission.
- The light sensor determines it is daytime.

When the DRL are on, no other lamps are on. The instrument panel will not be lit up either. For vehicles first sold in Canada, if parking lamps are manually turned on, DRL will stay on.

When it begins to get dark, the automatic headlamp system changes from DRL to the headlamps.

The regular headlamp system should be turned on when needed.

To turn off the DRL, see *Exterior Lamp Controls on page 6-1*.

Vehicles first sold in Canada cannot turn off DRL unless certain conditions are met. See *Exterior Lamp Controls on page 6-1*.

### Automatic Headlamp System

When it is dark enough outside, the automatic headlamp system turns on after the transmission has been shifted from P (Park) to D (Drive). The headlamps, taillamps, sidemarker, parking lamps, roof marker lamps, and the instrument panel lights turn on at normal brightness. The radio lights will become dimmer when the headlights are off compared to when the headlights are on.

The vehicle has a light sensor located on the top of the instrument panel. Do not cover the sensor, or the system will be on whenever the ignition is on.

The system can turn on the headlamps when driving in a parking garage, through a tunnel or when there is overcast weather. This is normal.

There is a delay in the transition between the daytime and nighttime operation of the Daytime Running Lamps (DRL) and the automatic headlamp system so that driving under bridges or bright overhead street lights does not affect the system. The DRL and automatic headlamp system will only be affected when the light sensor detects a change in lighting lasting longer than the delay.

If the vehicle is started in a dark garage, the automatic headlamp system comes on immediately. Once the vehicle leaves the garage, it takes about one minute for the automatic headlamp system to change to DRL if it is light outside.

During that delay, the instrument panel cluster may not be as bright as usual. Make sure the instrument panel brightness control is in the full bright position. See *Instrument Panel Illumination Control on page 6-7*.

## Hazard Warning Flashers

 **(Hazard Warning Flasher):** Press this button located on the instrument panel, to make the front and rear turn signal lamps flash on and off. This warns others that you are having trouble.

Press  again to turn the flashers off.

## Turn and Lane-Change Signals



An arrow on the instrument panel cluster flashes in the direction of the turn or lane change.

Move the lever all the way up or down to signal a turn.

Raise or lower the lever until the arrow starts to flash to signal a lane change. Hold it there until the change is completed.

The lever returns to its starting position whenever it is released.

If after signaling a turn or a lane change the arrow flashes rapidly or does not come on, a signal bulb may be burned out.

Have the bulbs replaced. If the bulb is not burned out, check the fuse. For bulb replacement, see *Bulb Replacement on page 10-35*. For a blown fuse or circuit breaker, see *Fuses and Circuit Breakers on page 10-39*.

### Turn Signal On Chime

If a turn signal is left on for more than 3/4 of a mile (1.2 km), a chime sounds at each flash of the turn signal and the message TURN SIGNAL will also appear in the DIC. To turn the chime and message off, move the turn signal lever to the off position.

See "TURN SIGNAL" under *Lamp Messages on page 5-24*.

## 6-6 Lighting

### Fog Lamps

The fog lamp button is located in the exterior lamps control.

**Fog Lamps:** The headlamps or parking lamps must be on for the fog lamps to work. Press  to turn the fog lamps on or off. An indicator light turns on when the fog lamps are on.

Never use the fog lamps in the dark without turning on the headlamps.

When the high-beam headlamps are turned on, the fog lamps turn off automatically. When the high-beam headlamps are turned off, the fog lamps come on again.

Some localities have laws that require the headlamps to be on along with the fog lamps.

### Off-Road Lamps

For vehicles with off-road lamps, they provide auxiliary lighting when the vehicle is used off road. These lamps are not intended to be used in place of existing vehicle lighting. They are not to be used on any public street or highway and are to be covered when not in use. Check your state and local laws before installing or using any auxiliary lighting. In some states it may be necessary to remove the roof lamps when operating the vehicle on the highway.



The off-road lamps button is located on the instrument panel below the climate controls.

Remove the covers from the lamps and press the button to turn them on or off. An indicator light turns on when the lamps are on.

**Notice:** Turning on the off-road lamps before removing the lamp covers could damage the off-road lamps and the covers. Always remove the covers before turning on the off-road lamps.

The off-road lamps remain on even after the ignition is turned off. The off-road lamp button must be pressed to turn them off.

## Interior Lighting

### Instrument Panel Illumination Control

The instrument panel brightness thumbwheel is next to the exterior lamp control.

#### (Instrument Panel

**Brightness):** Turn the thumbwheel up or down to brighten or dim the instrument panel lights and the radio display. The instrument panel lights, cluster, and radio display do not dim to complete darkness. Turn the thumbwheel all the way up to turn the dome lamps on.

### Dome Lamps

The dome lamps are located in the front area of the vehicle. There is also a dome lamp in the cargo area of the H3 model only.

Turn the thumbwheel, located next to the exterior lamps control, all the way up to turn the dome and footwell lamps on.

The dome lamp in the cargo area automatically turns off when:

- The shift lever is shifted out of P (Park) (automatic transmissions).
- The parking brake is released (manual transmissions).

### Dome Lamp Override

The dome lamp override button is located below the exterior lamps control.

⚡ (Dome Lamp Override): Press the button in to turn the lamps off. In this position, the dome lamps will remain off when the doors are open. To return the lamps to automatic operation, press ⚡ again and return it to the out position. With the button in this position, the dome lamps will come on when a door is opened.

### Reading Lamps

The reading lamps are located in the overhead console.

Press the button located next to each lamp to turn them on or off.

These lamps will not come on with the dome lamps.

## Lighting Features

### Exit Lighting

The interior lamps come on when the key is removed from the ignition. The lamps will not come on if the dome override button is pressed in.

### Battery Load Management

The vehicle has Electric Power Management (EPM) that estimates the battery's temperature and state of charge. It then adjusts the voltage for best performance and extended life of the battery.

When the battery's state of charge is low, the voltage is raised slightly to quickly bring the charge back up. When the state of charge is high, the voltage is lowered slightly to prevent overcharging. If the vehicle has a voltmeter gauge or a voltage display on the Driver Information Center (DIC), you may see the voltage move up or down. This is normal. If there is a problem, an alert will be displayed.

The battery can be discharged at idle if the electrical loads are very high. This is true for all vehicles. This is because the generator (alternator) may not be spinning fast enough at idle to produce all the power that is needed for very high electrical loads.



A high electrical load occurs when several of the following are on, such as: headlamps, high beams, fog lamps, rear window defogger, climate control fan at high speed, heated seats, engine cooling fans, trailer loads, and loads plugged into accessory power outlets.

EPM works to prevent excessive discharge of the battery. It does this by balancing the generator's output and the vehicle's electrical needs. It can increase engine idle speed to generate more power, whenever needed. It can temporarily reduce the power demands of some accessories.

Normally, these actions occur in steps or levels, without being noticeable. In rare cases at the highest levels of corrective action, this action may be noticeable to the driver. If so, a Driver Information Center (DIC) message might be displayed, such as BATTERY SAVER ACTIVE, BATTERY VOLTAGE LOW, or LOW BATTERY. If one of these messages displays, it is recommended that the driver reduce the electrical loads as much as possible. See *Driver Information Center (DIC) on page 5-18*.

## Battery Power Protection

The dome lamp is shut off if it is left on for more than 20 minutes when the ignition is in LOCK/OFF. This helps to prevent the battery from being drained.



# Infotainment System

## Introduction

Introduction ..... 7-1  
 Theft-Deterrent Feature ..... 7-2  
 Operation ..... 7-2

## Radio

AM-FM Radio ..... 7-5  
 Satellite Radio ..... 7-6  
 Radio Reception ..... 7-9  
 Fixed Mast Antenna ..... 7-10  
 Satellite Radio Antenna ..... 7-10

## Audio Players

CD Player ..... 7-10

## Phone

Bluetooth ..... 7-15

## Introduction

Determine which radio the vehicle has and read the following pages to become familiar with its features.

 <b>WARNING</b>
Taking your eyes off the road for extended periods could cause a crash resulting in injury or death to you or others. Do not give extended attention to entertainment tasks while driving.

This system provides access to many audio and non-audio listings.

To minimize taking your eyes off the road while driving, do the following while the vehicle is parked:

- Become familiar with the operation and controls of the audio system.
- Set up the tone, speaker adjustments, and preset radio stations.

For more information, see *Defensive Driving* on page 9-2.

**Notice: Contact your dealer before adding any equipment.**

**Adding audio or communication equipment could interfere with the operation of the vehicle's engine, radio, or other systems, and could damage them. Follow federal rules covering mobile radio and telephone equipment.**

The vehicle has Retained Accessory Power (RAP). With RAP, the audio system can be played even after the ignition is turned off. See *Retained Accessory Power (RAP)* on page 9-35 for more information.

For vehicles with a navigation radio system, see the separate Navigation System manual.

## 7-2 Infotainment System

---

### Theft-Deterrent Feature

THEFTLOCK<sup>®</sup> is designed to discourage theft of the vehicle's radio by learning a portion of the Vehicle Identification Number (VIN). The radio does not operate and LOCKED displays if the radio is stolen or moved to a different vehicle.

When the ignition is in the off position, a blinking red light on the upper left side of the radio indicates that THEFTLOCK<sup>®</sup> is armed.

### Operation

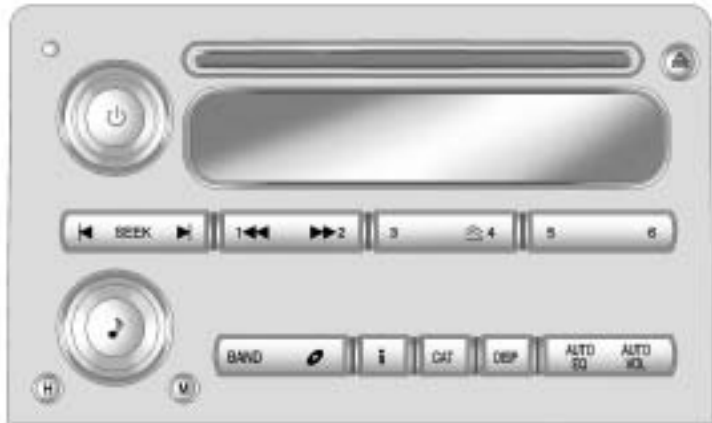

Single CD Radio



Six-Disc CD Radio

The vehicle has one of these radios as its audio system.

### Playing the Radio

**Power/Volume:** Press to turn the system on and off.

Turn to increase or to decrease the volume.

**DISP (Display):** Press to:

- Display the time when the ignition is off.
- Change between the track number and the elapsed time during CD playback.

- Select between showing the preset number and the EQ number on the Six-Disc CD Radio.
- Retrieve four different categories of information while in XM™ mode related to the current song or channel: Artist, Song Title, Category or PTY (program type), Channel Number/Channel Name.

To change the default display:

1. Press DISP until the desired display is shown.
2. Press and hold DISP for two seconds and the radio produces one beep. The selected display becomes the default.

### Audio Settings

**AUTO EQ (Automatic Equalization):** Press and release to select customized equalization settings designed for country/western, jazz, talk, pop, rock, and classical.

## 7-4 Infotainment System

---

### **AUTO VOL (Automatic Volume):**

This adjusts the radio volume to compensate for road and wind noise.

To set Automatic Volume:

1. Adjust the volume at the desired level.
2. Press AUTO VOL to select LOW, MEDIUM, or HIGH. Each higher setting allows for more volume compensation at faster vehicle speeds.

To turn automatic volume off, press AUTO VOL until AVOL OFF displays.



### **Tone and Speaker Controls**

To adjust all tone and speaker controls to the center setting, press and hold  until CEN or ALL CENTERED displays and the radio beeps once.

### **Adjusting the Tone (Bass/Treble)**

To adjust Bass/Treble:



Press and release  until BASS or TREB displays.

- Turn  to increase or to decrease the level.
- To set the Bass or Treble to the center setting, press and hold  until the radio beeps once.

### **Adjusting the Speakers (Balance/Fade)**



To adjust the Balance:

Press and release  until BAL displays.

- Turn  to move the sound toward the right or the left speakers.
- To adjust the balance to the center setting, press and hold  until the radio beeps once.

To adjust the Fade:

Press and release  until FAD or FADE displays

- Turn  to move the sound toward the front or the rear speakers.
- To set the fade to the center setting, press and hold  until the radio beeps once.

### **Radio Messages**

#### **CAL ERR (Calibration Error):**

Displays if the radio is no longer configured properly for the vehicle. The vehicle must be returned to your dealer for service.

**LOCKED:** Displays when the THEFTLOCK<sup>®</sup> system has locked up. The vehicle must be returned to your dealer for service.

If any error occurs repeatedly or cannot be corrected, contact your dealer.

## Radio

### AM-FM Radio

#### Finding a Station

**BAND:** Press to select FM1, FM2, AM, XM1, if equipped, or XM2, if equipped.

#### Manual Tuning

Single CD Radio:

 **(Tune):** Turn to select a radio station.

Six-Disc CD Radio:

**DISP:** Turn to select a radio station.





#### Automatic Tuning

**1-6 (Preset Pushbuttons):** Press to select preset stations.





**◀ SEEK ▶:** Press and release to go to the previous or next station and stay there. The radio only stops at stations with a strong signal.

Press and hold to scan stations or preset stations.

To scan stations:

1. Press and hold  or  for more than two seconds. SC or SCAN displays and the radio beeps once. The radio goes to a station, plays for a few seconds, then goes to the next station.
2. Press  or  again or one of the pushbuttons to stop scanning presets.

To scan preset stations:

1. Press and hold  or  for more than four seconds. PSC or PSCN displays and the radio beeps twice. The radio goes to a preset station, plays for a few seconds, then goes to the next preset station.
2. Press  or  again or one of the pushbuttons to stop scanning presets.

### Setting Preset Stations

Up to 30 stations (six FM1, six FM2, and six AM, six XM1, if equipped, and six XM2, if equipped), and equalization settings for each station can be programmed on the six numbered pushbuttons.

To program presets:

1. Turn the radio on.
2. Press BAND to select FM1, FM2, AM, or XM1 or XM2.
3. Tune in the desired station.
4. Press AUTO EQ to select the equalization.
5. Press and hold one of the six numbered pushbuttons until the radio beeps once.
6. Repeat the steps for each pushbutton.

### Satellite Radio

#### XM™ Satellite Radio Service

For vehicles with XM, it is a satellite radio service that is based in the 48 contiguous United States and 10 Canadian provinces. XM Satellite Radio has a wide variety of programming and commercial-free music, coast-to-coast, and in digital-quality sound. A service fee is required to receive the XM service. For more information, contact XM at [xmradio.com](http://xmradio.com) or call 1-800-929-2100 in the U.S. and [xmradio.ca](http://xmradio.ca) or call 1-877-438-9677 in Canada.

**i (Information):** Press to display additional information current XM station when **i** is shown on the display. When the complete message has shown, **i** disappears from the display. The last message can be viewed until a new message is received or the station is changed.

- Parts of the message appear every three seconds if the entire message cannot be shown on the display at once.
- Press and release **i** to manually scroll through the message.
- When **i** is pressed and a message is not available from the station, NO INFO is shown on the display.

### Finding a Station

**BAND:** Press to select FM1, FM2, AM, XM1, or XM2.

#### Manual Tuning

Single CD Radio:

**♪ (Tune):** Turn to select a radio station.

Six-Disc CD Radio:

**DISP:** Turn to select a radio station.

#### Automatic Tuning

**1-6 (Preset Pushbuttons):** Press to select preset stations.

**◀ SEEK ▶:** Press and release to go to the previous or next station and stay there. The radio only stops at stations with a strong signal.

Press and hold to scan stations or preset stations.



To scan stations:

1. Press and hold ◀ or ▶ for more than two seconds. SC or SCAN displays and the radio beeps once. The radio goes to a station, plays for a few seconds, then goes to the next station.
2. Press ◀ or ▶ again or one of the pushbuttons to stop scanning presets.

To scan preset stations:

1. Press and hold ◀ or ▶ for more than four seconds. PSC or PSCN displays and the radio beeps twice. The radio goes to a preset station, plays for a few seconds, then goes to the next preset station.
2. Press ◀ or ▶ again or one of the pushbuttons to stop scanning presets.

### Finding a Category (CAT) Station

To select an XM station by category for the Single CD Radio:

1. Press CAT to select a category mode.
2. Press CAT repeatedly to change the category.
3. Press ◀ or ▶ to select the first station in the category.
4. To go to another station in the selected category:
  - Press CAT once if the category is displayed.
  - Press CAT twice if the category is not displayed.
5. Press CAT to exit program type select mode. If CAT times out and is no longer on the display, go back to Step 1.

If the desired program type cannot be found, NONE or NOT FOUND displays and the radio returns to the previous station.

To select an XM station by category for the Six-Disc CD Radio:

1. Press CAT to select a category mode.
2. Turn 🎵 to select a category.
3. Press ◀ or ▶ to select the first station in the category.
4. Press ◀ or ▶ to go to another station within the category if category is displayed. If CAT times out and is no longer on the display, go back to Step 1.
5. Press CAT to exit program type select mode.

If the desired program type cannot be found, NONE or NOT FOUND displays and the radio returns to the previous station.

## 7-8 Infotainment System

---

### Setting Preset Stations

Up to 30 stations (six FM1, six FM2, and six AM, six XM1 and six XM2) and equalization settings for each station can be programmed on the six numbered pushbuttons.

To program presets:

1. Turn the radio on.
2. Press BAND to select FM1, FM2, AM, or XM1 or XM2.
3. Tune in the desired station.
4. Press AUTO EQ to select the equalization.
5. Press and hold one of the six numbered pushbuttons until the radio beeps once.
6. Repeat the steps for each pushbutton.

### XM Messages

**XL (Explicit Language Channels):** These channels, or any others, can be blocked by calling 1-800-852-XXXM (9696).

**Updating:** The encryption code in the receiver is being updated, and no action is required. This process should take no longer than 30 seconds.

**No Signal:** The system is functioning correctly, but the vehicle is in a location that is blocking the XM signal. When the vehicle is moved into an open area, the signal should return.

**Loading XM:** The audio system is acquiring and processing audio and text data. No action is needed. This message should disappear shortly.

**CH Off Air:** This channel is not currently in service. Tune in to another channel.

**CH Unauth:** This channel is blocked or cannot be received with your XM Subscription package.

**CH Unavail:** This previously assigned channel is no longer assigned. Tune to another station. If this station was one of the presets, choose another station for that preset button.

**No Info:** No artist, song title, category, or text information is available at this time on this channel. The system is working properly.

**Not Found:** There are no channels available for the selected category. The system is working properly.

**XM Locked:** The XM receiver in the vehicle may have previously been in another vehicle. For security purposes, XM receivers cannot be swapped between vehicles. If this message is received after having the vehicle serviced, check with your dealer.

**Radio ID:** If tuned to channel 0, this message will alternate with the XM Radio 8 digit radio ID label. This label is needed to activate the service.

**Unknown:** If this message is received when tuned to channel 0, there may be a receiver fault. Consult with your dealer.

**Chk XMRcvr:** If this message does not clear within a short period of time, the receiver may have a fault. Consult with your dealer.

## Radio Reception

Frequency interference and static can occur during normal radio reception if items such as cell phone chargers, vehicle convenience accessories, and external electronic devices are plugged into the accessory power outlet. If there is interference or static, unplug the item from the accessory power outlet.

## AM

The range for most AM stations is greater than for FM, especially at night. The longer range can cause station frequencies to interfere with each other. For better radio reception, most AM radio stations boost the power levels during the day, and then reduce these levels during the night. Static can also occur when things like storms and power lines interfere with radio reception. When this happens, try reducing the treble on the radio.

## FM Stereo

FM signals only reach about 16 to 65 km (10 to 40 mile). Although the radio has a built-in electronic circuit that automatically works to reduce interference, some static can occur, especially around tall buildings or hills, causing the sound to fade in and out.

## XM™ Satellite Radio Service

XM Satellite Radio Service gives digital radio reception from coast-to-coast in the 48 contiguous United States, and in Canada. Just as with FM, tall buildings or hills can interfere with satellite radio signals, causing the sound to fade in and out. In addition, traveling or standing under heavy foliage, bridges, garages, or tunnels may cause loss of the XM signal for a period of time.

## Cellular Phone Usage

Cellular phone usage may cause interference with the vehicle's radio. This interference may occur when making or receiving phone calls, charging the phone's battery, or simply having the phone on. This interference causes an increased level of static while listening to the radio. If static is received while listening to the radio, unplug the cellular phone and turn it off.

### Fixed Mast Antenna

The fixed mast antenna can withstand most car washes without being damaged as long as it is securely attached to the base. If the mast becomes slightly bent, straighten it out by hand. If the mast is badly bent, replace it.

Occasionally check to make sure the antenna is tightened to its base. If tightening is required, tighten by hand until fully seated plus one quarter turn.

### Satellite Radio Antenna

The XM Satellite Radio antenna is located on the roof of the vehicle. Keep the antenna clear of obstructions for clear radio reception.

If the vehicle has a sunroof, the performance of the XM system may be affected if the sunroof is open.

## Audio Players

### CD Player

The CD player can play smaller 8 cm (3 in) single CDs with an adapter ring.

A CD in the player it stays in the player when the ignition is turned off. When the ignition or radio is turned on, the CD starts to play where it stopped, if it was the last selected audio source.

#### Care of CDs

Store CDs in their original cases or other protective cases and away from direct sunlight and dust. The CD player scans the bottom of the disc. If the bottom of a CD is damaged it may not play properly or at all. Do not touch the bottom of a CD while handling it. Pick up CDs by grasping the outer edges or the edge of the hole and the outer edge.

If the surface of a CD is dirty, take a soft, lint free cloth or dampen a clean, soft cloth in a mild, neutral

detergent solution mixed with water, and clean it. Make sure the wiping process starts from the center to the edge.

#### Care of the CD Player

Do not add labels to a CD, it could get caught in the CD player. Use a marking pen to write on the top of the CD if a description is needed.

Do not use CD lens cleaners, they could damage the CD player.

**Notice:** If a label is added to a CD, or more than one CD is inserted into the slot at a time, or an attempt is made to play scratched or damaged CDs, the CD player could be damaged. While using the CD player, use only CDs in good condition without any label, load one CD at a time, and keep the CD player and the loading slot free of foreign materials, liquids, and debris.

If an error displays, see “CD Messages” later in this section.

## Loading and Ejecting CDs

### Single CD Radio

To load a CD:

- To Insert a CD with the ignition on, insert the CD partway into the slot, label side up, until the player pulls the CD in. The CD begins playing automatically.
- To insert a CD with the ignition off, press the  (Eject) button or the DISP knob first.

The CD symbol displays when a CD is inserted, and the track number displays just before the track starts to play.

 **(Eject):** Press to eject a CD. Eject can be used with either the ignition or radio off.

### Six-Disc CD Radio

To load CDs:

**LOAD:** Press to load CDs into the CD player.

To insert one CD:

1. Turn the ignition on.
2. Press and release the LOAD button.
3. Wait for the indicator light to turn green.
4. Insert the CD partway into the slot, label side up, until the player pulls the CD in. The CD begins playing automatically.

To insert multiple CDs:

1. Turn the ignition on.
2. Press and hold the LOAD button for two seconds. The radio beeps once, the indicator light flashes, and MULTI LOAD # displays.
3. Load a CD once INSERT CD # displays and the light stops flashing and turns green. Insert the CD partway into the slot, label side up, until the player pulls the CD in.
4. Repeat step 3 to load the remaining CDs.

To load more than one CD but less than six, complete Steps 1 through 3. When finished loading CDs, press the LOAD button to cancel the loading function. The last CD loaded begins playing automatically.

 **(Eject):** Press to eject CD(s).

Press and release  to eject the CD that is currently playing.

To eject multiple CDs:

1. Press and hold  for five seconds. A beep sounds and the indicator light begins to flash and EJECT ALL displays.
2. Remove the CD when REMOVE CD # displays and the light stops flashing.



Once the CD is removed, the indicator light begins flashing again and another CD ejects.

To stop ejecting the CDs, press LOAD or .

## 7-12 Infotainment System

---

The CD is automatically pulled back into the player if the CD is not removed after 25 seconds. Pushing a CD back into the player, before the 25 second time period is complete causes the player to sense an error and the CD player tries to eject the CD several times before stopping.

Pressing  repeatedly after trying to push a CD in manually causes the CD players 25-second eject timer to reset. Wait for the timer to expire before pressing  again.



### Playing CDs



#### Single CD Radio





 (CD): Press to play a CD while listening to the radio.

**1**  (Previous): Press to go to the start of the current track after more than eight seconds have played.

Press or hold **1**  more than once to continue moving backward through the CD.

**2**  (Next): Press to go to the next track. Press or hold **2**  more than once to continue moving forward through the CD.

**4**  (Random): Press to hear the tracks in random order. Press **4**  again to turn off random play.







 **SEEK** : Press to go to the start of the current or the previous track. Press  to go to the start of the next track. To continue moving backward or forward through the tracks press and hold  or , or press multiple times.





#### Six-Disc CD Radio





 (CD): Press to play a CD while listening to the radio.

 (Reverse): Press to reverse within the track.



 (Fast Forward): Press to fast forward within the track.

 **SEEK** : Press  to go to the start of the current track, if more than ten seconds have played. Press  to go to the next track. To continue moving backward or forward through the tracks press and hold  or , or press multiple times.



Press and hold  or  for more than two seconds until SCAN displays and a beep sounds to scan one CD. The radio goes to the next track, plays for 10 seconds, then goes to the next track. Press  or  again, to stop scanning.

Press and hold  or  for more than four seconds until ALL CD SCAN displays and a beep sounds to scan all loaded CDs. Use this feature to listen to 10 seconds of the first track of each loaded CD. Press  or  again, to stop scanning.

 **(Repeat):** One track or an entire CD can be repeated.



- Press and release  to repeat the current track. RPT TRACK # displays. Press again to turn off repeat play.
- Press and hold  for two seconds to repeat the current CD. RPT CD # displays. Press again to turn off repeat play.

 **(Random):** All the tracks on one CD or all the CDs can be played in random order.

- Press and release  to play all the tracks on one CD in random order. RANDOM ONE displays. Press again to turn off random play.
- Press and hold  for more than two seconds to play the tracks on all of the CDs that are loaded in random order. A beep sounds and RANDOM ALL displays. Press again to turn off random play.



 **(Song List):** The Song List feature can save 20 track selections.

To save tracks:



1. If S-LIST is displayed, press  to turn it off.
2. Select the desired CD by pressing the numbered pushbutton and then use  to select the track to be saved.
3. Press and hold  for two seconds, two beeps sound to confirm the track is saved into memory.
4. Repeat Steps 2 and 3 for saving other selections.

S-LIST FULL displays if more than 20 selections are tried to be stored.

To play tracks:

1. Press . One beep sounds and S-LIST displays. The recorded tracks begin to play in the order they were saved
2. Press  or  to go back or forward within the saved tracks.

To delete tracks:



1. Press  to turn song list on. S-LIST displays.
2. Press either SEEK arrow to select the desired track to be deleted.
3. Press and hold  for two seconds. Two beeps sound to confirm that the track has been deleted.

After a track has been deleted, the remaining tracks are moved up the list. When another track is added to the song list, the track is added to the end of the list.

## 7-14 Infotainment System

---

To delete the entire song list:

1. Press  to turn song list on. S-LIST displays.
2. Press and hold  for more than four seconds. One beep sounds and S-LIST EMPTY displays to confirm that the song list has been deleted.

If a CD is ejected, and the song list contains saved tracks from that CD, those tracks are automatically deleted from the song list. Any tracks saved to the song list again are added to the bottom of the list.

To end song list mode, press the  button. One beep sounds and S-LIST is removed from the display.

### CD Messages

**CHECK CD:** If this message displays and/or the CD comes out, it could be for one of the following reasons:

- The CD player is very hot. When the temperature returns to normal, the CD should play.
- The road is very rough. When the road becomes smoother, the CD should play.
- The CD is dirty, scratched, wet, or upside down.
- The air is very humid. Wait about an hour and try again.
- The format of the CD might not be compatible.

- A problem may have occurred while burning the CD.
- The label could be caught in the CD player.

If the CD is not playing correctly, for any other reason, try a known good CD.

If any error occurs repeatedly or if an error cannot be corrected, contact your dealer. If the radio displays an error message, write it down and provide it to your dealer when reporting the problem.



## Phone

### Bluetooth

Vehicles with a Bluetooth system can use a Bluetooth capable cell phone with a Hands Free Profile to make and receive phone calls. The system can be used while the key is in ON/RUN or ACC/ACCESSORY position. The range of the Bluetooth system can be up to 9.1 m (30 ft.). Not all phones support all functions, and not all phones are guaranteed to work with the in-vehicle Bluetooth system. See [gm.com/bluetooth](http://gm.com/bluetooth) for more information on compatible phones.

### Voice Recognition

The Bluetooth system uses voice recognition to interpret voice commands to dial phone numbers and name tags.

**Noise:** Keep interior noise levels to a minimum. The system may not recognize voice commands if there is too much background noise.

**When to Speak:** A short tone sounds after the system responds indicating when it is waiting for a voice command. Wait until the tone and then speak.

**How to Speak:** Speak clearly in a calm and natural voice.

### Audio System

When using the in-vehicle Bluetooth system, sound comes through the vehicle's front audio system speakers and overrides the audio system. Use the audio system volume knob, during a call, to change the volume level. The adjusted volume level remains in memory for later calls. To prevent missed calls, a minimum volume level is used if the volume is turned down too low.

### Bluetooth Controls

Use the  button, located on the driver side of the instrument panel near the headlamp controls, to operate the in-vehicle Bluetooth system.

** (Push To Talk):** Press to answer incoming calls, to confirm system information, and to start speech recognition.

### Pairing

A Bluetooth enabled cell phone must be paired to the in-vehicle Bluetooth system first and then connected to the vehicle before it can be used. See the cell phone manufacturers user guide for Bluetooth functions before pairing the cell phone. If a Bluetooth phone is not connected, calls will be made using OnStar® Hands-Free Calling, if available. Refer to the OnStar owner's guide for more information.

#### Pairing Information:

- Up to five cell phones can be paired to the in-vehicle Bluetooth system.
- The pairing process is disabled when the vehicle is moving.
- The in-vehicle Bluetooth system automatically links with the first available paired cell phone in the order the phone was paired.

- Only one paired cell phone can be connected to the in-vehicle Bluetooth system at a time.
- Pairing should only need to be completed once, unless changes to the pairing information have been made or the phone is deleted.

To link to a different paired phone, see Linking to a Different Phone later in this section.

#### Pairing a Phone

1. Press and release . The system responds with "Ready" followed by a tone.
2. Say "Bluetooth". The system responds with "Bluetooth ready" followed by a tone.
3. Say "Pair". The system responds with instructions and a four digit PIN number. The PIN number will be used in Step 4.

4. Start the pairing process on the cell phone that will be paired to the vehicle. Reference the cell phone manufacturers user guide for information on this process.

Locate the device named "General Motors" in the list on the cellular phone and follow the instructions on the cell phone to enter the four digit PIN number that was provided in Step 3.

5. The system prompts for a name for the phone. Use a name that best describes the phone. This name will be used to indicate which phone is connected. The system then confirms the name provided.
6. The system responds with "<Phone name> has been successfully paired" after the pairing process is complete.
7. Repeat Steps 1 through 7 for additional phones to be paired.

### Listing All Paired and Connected Phones

1. Press and release  $\text{Ⓜ}$ . The system responds with “Ready” followed by a tone.
2. Say “Bluetooth”. The system responds with “Bluetooth ready” followed by a tone.
3. Say “List”. The system lists all the paired Bluetooth devices. If a phone is connected to the vehicle, the system will say “Is connected” after the connected phone.

### Deleting a Paired Phone

1. Press and release  $\text{Ⓜ}$ . The system responds with “Ready” followed by a tone.
2. Say “Bluetooth”. The system responds with “Bluetooth ready” followed by a tone.

3. Say “Delete”. The system asks which phone to delete followed by a tone.
4. Say the name of the phone to be deleted. If the phone name is unknown, use the “List” command for a list of all paired phones. The system responds with “Would you like to delete <phone name>? Yes or No” followed by a tone
5. Say “Yes” to delete the phone. The system responds with “OK, deleting <phone name>”.

### Linking to a Different Phone

1. Press and release  $\text{Ⓜ}$ . The system responds with “Ready” followed by a tone.
2. Say “Bluetooth”. The system responds with “Bluetooth ready” followed by a tone.

3. Say “Change phone”. The system responds with “Please wait while I search for other phones”.
  - If another phone is found, the response will be “<Phone name> is now connected”.
  - If another phone is not found, the original phone remains connected.

### Storing Name Tags

The system can store up to thirty phone numbers as name tags that are shared between the Bluetooth and OnStar systems.

The system uses the following commands to store and retrieve phone numbers:

- Store
- Digit Store
- Directory

## 7-18 Infotainment System

---

### Using the Store Command

The store command allows a phone number to be stored without entering the digits individually.

1. Press and release  $\mathbb{K}$ . The system responds with "Ready" followed by a tone.
2. Say "Store". The system responds with "Store, number please" followed by a tone.
3. Say the complete phone number to be stored at once with no pauses.
  - If the system recognizes the number it responds with "OK, Storing" and repeats the phone number.
  - If the system is unsure it recognizes the phone number, it responds with "Store" and repeats the number followed by "Please say yes or no".

If the number is correct, say "Yes". If the number is not correct, say "No". The system will ask for the number to be re-entered.

4. After the system stores the phone number, it responds with "Please say the name tag" followed by a tone.
5. Say a name tag for the phone number. The name tag is recorded and the system responds with "About to store <name tag>. Does that sound OK?".
  - If the name tag does not sound correct, say "No" and repeat Step 5.
  - If the name tag sounds correct, say "Yes" and the name tag is stored. After the number is stored the system returns to the main menu.

### Using the Digit Store Command

The digit store command allows a phone number to be stored by entering the digits individually.

1. Press and release  $\mathbb{K}$ . The system responds with "Ready" followed by a tone.
2. Say "Digit Store". The system responds with "Please say the first digit to store" followed by a tone.
3. Say the first digit to be stored. The system will repeat back the digit it heard followed by a tone. Continue entering digits until the number to be stored is complete.
  - If an unwanted number is recognized by the system, say "Clear" at any time to clear the last number.
  - To hear all of the numbers recognized by the system, say "Verify" at any time and the system will repeat them.

4. After the complete number has been entered, say “Store”. The system responds with “Please say the name tag” followed by a tone.
5. Say a name tag for the phone number. The name tag is recorded and the system responds with “About to store <name tag>. Does that sound OK?”.
  - If the name tag does not sound correct, say “No” and repeat Step 5.
  - If the name tag sounds correct, say “Yes” and the name tag is stored. After the number is stored the system returns to the main menu.

### **Using the Directory Command**

The directory command lists all of the name tags stored by the system. To use the directory command:

1. Press and release  $\mathbb{W}\xi$ . The system responds with “Ready” followed by a tone.
2. Say “Directory”. The system responds with “Directory” and then plays back all of the stored name tags. When the list is complete, the system returns to the main menu.

### **Deleting Name Tags**

The system uses the following commands to delete name tags:

- Delete
- Delete all name tags

### **Using the Delete Command**

The delete command allows specific name tags to be deleted.

To use the delete command:

1. Press and release  $\mathbb{W}\xi$ . The system responds with “Ready” followed by a tone.
2. Say “Delete”. The system responds with “Delete, please say the name tag” followed by a tone.

3. Say the name tag to be deleted. The system responds with "Would you like to delete, <name tag>? Please say yes or no".
  - If the name tag is correct, say "Yes" to delete the name tag. The system responds with "OK, deleting <name tag>, returning to the main menu."
  - If the name tag is incorrect, say "No". The system responds with "No. OK, let's try again, please say the name tag."

### Using the Delete All Name Tags Command

The delete all name tags command deletes all stored phone book name tags and route name tags for OnStar (if present).

To use the delete all name tags command:

1. Press and release  $\mu\acute{\xi}$ . The system responds with "Ready" followed by a tone.
2. Say "Delete all name tags". The system responds with "You are about to delete all name tags stored in your phone directory and your route destination directory. Are you sure you want to do this? Please say yes or no."
  - Say "Yes" to delete all name tags.
  - Say "No" to cancel the function and return to the main menu.

### Making a Call

Calls can be made using the following commands:

- Dial
- Digit Dial
- Call
- Re-dial

### Using the Dial Command

1. Press and release  $\mu\acute{\xi}$ . The system responds with "Ready" followed by a tone.
2. Say "Dial". The system responds with "Dial using <phone name>." "Number please" followed by a tone.

3. Say the entire number without pausing.
  - If the system recognizes the number, it responds with “OK, Dialing” and dials the number.
  - If the system does not recognize the number, it confirms the numbers followed by a tone. If the number is correct, say “Yes”. The system responds with “OK, Dialing” and dials the number. If the number is not correct, say “No”. The system will ask for the number to be re-entered.

### Using the Digit Dial Command

1. Press and release  $\mu\zeta$ . The system responds with “Ready” followed by a tone.
2. Say “Digit Dial”. The system responds with “Digit dial using <phone name>, please say the first digit to dial” followed by a tone.
3. Say the digits to be dialed one at a time. Following each digit, the system will repeat back the digit it heard followed by a tone.

4. Continue entering digits until the number to be dialed is complete. After the whole number has been entered, say “Dial”. The system responds with “OK, Dialing” and dials the number.
  - If an unwanted number is recognized by the system, say “Clear” at any time to clear the last number.
  - To hear all of the numbers recognized by the system, say “Verify” at any time and the system will repeat them.

### Using the Call Command

1. Press and release  $\mathbb{K}$ . The system responds with “Ready” followed by a tone.
2. Say “Call”. The system responds with “Call using <phone name>”. Please say the name tag” followed by a tone.
3. Say the name tag of the person to call.
  - If the system clearly recognizes the name tag it responds with “OK, calling, <name tag>” and dials the number.
  - If the system is unsure it recognizes the right name tag, it confirms the name tag followed by a tone. If the name tag is correct, say “Yes”.

The system responds with “OK, calling, <name tag>” and dials the number. If the name tag is not correct, say “No”. The system will ask for the name tag to be re-entered.

Once connected, the person called will be heard through the audio speakers.

### Using the Re-dial Command

1. Press and release  $\mathbb{K}$ . The system responds with “Ready” followed by a tone.
2. After the tone, say “Re-dial”. The system responds with “Re-dial using <phone name>” and dials the last number called from the connected Bluetooth phone.

Once connected, the person called will be heard through the audio speakers.

### Receiving a Call

When an incoming call is received, the audio system mutes and a ring tone is heard in the vehicle. Press and release  $\mathbb{K}$  to answer the call.

### Call Waiting

Call waiting must be supported on the Bluetooth phone and enabled by the wireless service carrier to work.

- Press and release  $\mathbb{K}$  to answer an incoming call when another call is active. The original call is placed on hold.
- Press and release  $\mathbb{K}$  again to return to the original call.
- To ignore the incoming call, continue with the original call with no action.



### Three-Way Calling

Three-Way Calling must be supported on the Bluetooth phone and enabled by the wireless service carrier to work.

1. While on a call press and release  $\mathbb{L}$ . The system responds with "Ready" followed by a tone.
2. Say "Three-way call". The system responds with "Three-way call, please say dial or call".
3. Use the dial or call command to dial the number of the third party to be called.
4. Once the call is connected, press  $\mathbb{L}$  to link all the callers together.

### Ending a Call

To end a call:

1. Press and release  $\mathbb{L}$ . The system responds with "Ready" followed by a tone.
2. Say "End Call". The call is then ended.

### Muting a Call

During a call, all sounds from inside the vehicle can be muted so that the person on the other end of the call cannot hear them.

### To Mute a Call

1. Press and release  $\mathbb{L}$ . The system responds with "Ready" followed by a tone.
2. Say "Mute Call". The system responds with "Call muted".

### To Cancel Mute

1. Press and release  $\mathbb{L}$ . The system responds with "Ready" followed by a tone.
2. After the tone, say "Mute Call". The system responds with "Resuming call".

### Transferring a Call

Audio can be transferred between the in-vehicle Bluetooth system and the cell phone.

### To Transfer Audio to the Cell Phone

During a call with the audio in the vehicle:

1. Press and release  $\mathbb{L}$ . The system responds with "Ready" followed by a tone.
2. Say "Transfer Call." The system responds with "Transferring call" and the audio will switch from the vehicle to the cell phone.

### To Transfer Audio to the In-Vehicle Bluetooth System

The cellular phone must be paired and connected with the Bluetooth system before a call can be transferred. The connection process can take up to two minutes after the key is turned to the ON/RUN or ACC/ACCESSORY position.

During a call with the audio on the cell phone, press  $\text{Ⓜ}$  for more than two seconds. The audio switches from the cell phone to the vehicle.

### Voice Pass-Thru

Voice Pass-Thru allows access to the voice recognition commands on the cell phone. See the cell phone manufacturers user guide to see if the cell phone supports this feature.

This feature can be used to verbally access contacts stored in the cell phone.

1. Press and release  $\text{Ⓜ}$ . The system responds with "Ready" followed by a tone.
2. Say "Bluetooth". The system responds with "Bluetooth ready" followed by a tone.
3. Say "Voice". The system responds with "OK, accessing <phone name>".
  - The cell phone's normal prompt messages will go through its cycle according to the phone's operating instructions.

### Dual Tone Multi-Frequency (DTMF) Tones

The in-vehicle Bluetooth system can send numbers and numbers stored as name tags during a call. This is used when calling a menu driven phone system. Account numbers can be programmed into the phonebook for retrieval during menu driven calls.

### Sending a Number During a Call

1. Press and release  $\text{Ⓜ}$ . The system responds with "Ready" followed by a tone.
2. Say "Dial". The system responds with "Say a number to send tones" followed by a tone.

3. Say the number to send.
  - If the system clearly recognizes the number it responds with “OK, Sending Number” and the dial tones are sent and the call continues.
  - If the system is not sure it recognized the number properly, it responds “Dial Number, Please say yes or no?” followed by a tone. If the number is correct, say “Yes”. The system responds with “OK, Sending Number” and the dial tones are sent and the call continues.

**Sending a Stored Name Tag During a Call**

1. Press and release . The system responds with “Ready” followed by a tone.
2. Say “Send name tag.” The system responds with “Say a name tag to send tones” followed by a tone.

3. Say the name tag to send.
  - If the system clearly recognizes the name tag it responds with “OK, Sending <name tag>” and the dial tones are sent and the call continues.
  - If the system is not sure it recognized the name tag properly, it responds “Dial <name tag>. Please say yes or no?” followed by a tone. If the name tag is correct, say “Yes”. The system responds with “OK, Sending <name tag>” and the dial tones are sent and the call continues.

**Clearing the System**

Unless information is deleted out of the in-vehicle Bluetooth system, it will be retained indefinitely. This includes all saved name tags in the phonebook and phone pairing information. For information on how to delete this information, see the above sections on Deleting a Paired Phone and Deleting Name Tags.

**Other Information**

The Bluetooth® word mark and logos are owned by the Bluetooth® SIG, Inc. and any use of such marks by General Motors is under license. Other trademarks and trade names are those of their respective owners.

See *Radio Frequency Statement on page 13-16* for FCC information.



# Climate Controls

## Climate Control Systems

Climate Control Systems ..... 8-1

## Air Vents

Air Vents ..... 8-4

## Climate Control Systems

The heating, cooling, and ventilation of the vehicle can be controlled with this system.

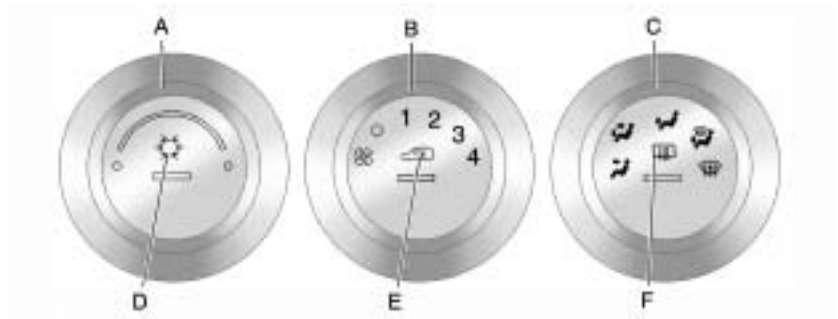

- A. Temperature Control
- B. Fan Control
- C. Air Delivery Mode Control
- D. Air Conditioning
- E. Recirculation
- F. Rear Window Defogger

○ **(Off):** Turn the fan control to this position to turn the fan off. Air still enters the vehicle and increases with vehicle speed depending on the mode and temperature settings. Turn on the recirculation mode to stop this airflow.

**Temperature Control:** Turn clockwise or counterclockwise to increase or decrease the temperature of the air in the vehicle.

## 8-2 Climate Controls

---

 **(Fan Control):** Turn clockwise or counterclockwise to increase or decrease the fan speed.

**Air Delivery Mode Control:** Turn clockwise or counterclockwise to change the direction of the airflow in the vehicle. The airflow can be set between modes.

To change the current mode, select one of the following:

 **(Vent):** Air is directed to the instrument panel outlets.

 **(Bi-Level):** Air is directed to the instrument panel outlets, and the remaining air to the floor outlets and the defroster and side window outlets. Cooler air is directed to the upper outlets and warmer air to the floor outlets.

 **(Floor):** Air is directed to the floor outlets, side window outlets, and defroster. Recirculation is not available in this mode.

 **(Floor/Defog):** This clears the windows of fog and moisture. Air is directed to the windshield, side window, and floor outlets. The system runs the air conditioning unless the outside temperature is near freezing or below. Recirculation is not available in this mode.

 **(Defrost):** This clears the windshield of fog or frost more quickly. Air is directed to the windshield and side window outlets. The system runs the air conditioning system unless the outside temperature is near or below freezing. Recirculation is not available in this mode.

Do not drive the vehicle until all the windows are clear.

 **(Air Conditioning):** Press to turn the air conditioning system on or off. An indicator light comes on when the air conditioning is turned on. This system cools and dehumidifies the air entering the vehicle.

The air conditioning will not function if the fan is turned off. If air conditioning is selected with fan off, the indicator light flashes three times and then turns off.

A slight change in engine performance may occur when the air conditioning compressor shuts off and turns on again. This is normal. The system is designed to make adjustments to help with fuel economy while still maintaining the selected temperature.

The air conditioning system removes moisture from the air, so water might drip under the vehicle while idling or after turning off the engine. This is normal.

 **(Recirculation):** Press to turn the recirculation mode on or off. An indicator light comes on when the recirculation is on. This mode recirculates and helps to quickly cool the air inside the vehicle. It can be used to prevent outside air and odors from entering the vehicle.

Recirculation is available in the bi-level and vent modes. This mode cannot be selected while in the floor, floor/defog or defrost modes. If you try to select the recirculation mode, the indicator flashes three times indicating it is not available in that mode. When the recirculation mode is turned on, the air conditioning turns on automatically.

When it is hot enough outside, the recirculation mode may turn on automatically to help improve cooling performance. The indicator light will be lit to show this mode is active. If the recirculation button is pressed while in this mode, the light flashes three times and stays on to indicate that recirculation may not be shut off.

### **Rear Window Defogger**

The rear window defogger uses a warming grid to remove fog or frost from the rear window when the key is in the ignition and turned to ON/RUN.

 **(Rear Defogger):** Press to turn the rear window defogger on or off. After the button is first pressed the rear window defogger stays on for about 15 minutes. If turned on again, the defogger only runs for about seven and one-half minutes.

**Notice:** Do not use anything sharp on the inside of the rear window. If you do, you could cut or damage the warming grid, and the repairs would not be covered by the vehicle warranty. Do not attach a temporary vehicle license, tape, a decal or anything similar to the defogger grid.

### Air Vents

Use the air outlets located in the center and on the side of the instrument panel to direct the airflow.

Move the louvers up or down to change the direction of the airflow. Use the thumbwheel under the outlets to change the direction of the airflow from left to right.

### Operation Tips

- Use the recirculation mode for maximum air conditioning performance.
- Clear away any ice, snow or leaves from the air inlets at the base of the windshield that may block the flow of air into the vehicle.
- Use of non-HUMMER approved hood deflectors may adversely affect the performance of the system.
- Keep the path under the front seats clear of objects to help circulate the air inside of the vehicle more effectively.



# Driving and Operating

## Driving Information

Defensive Driving .....	9-2
Drunk Driving .....	9-2
Control of a Vehicle .....	9-3
Braking .....	9-3
Steering .....	9-4
Off-Road Recovery .....	9-5
Loss of Control .....	9-6
Off-Road Driving .....	9-7
Driving on Wet Roads .....	9-22
Highway Hypnosis .....	9-22
Hill and Mountain Roads .....	9-23
Winter Driving .....	9-24
If the Vehicle is Stuck .....	9-26
Vehicle Load Limits .....	9-27
Truck-Camper Loading Information .....	9-33

## Starting and Operating

New Vehicle Break-In .....	9-33
Ignition Positions .....	9-34
Retained Accessory Power (RAP) .....	9-35
Starting the Engine .....	9-35
Engine Coolant Heater .....	9-36
Shifting Into Park .....	9-37
Shifting Out of Park .....	9-38
Parking .....	9-39
Parking Over Things That Burn .....	9-40

## Engine Exhaust

Engine Exhaust .....	9-40
Running the Vehicle While Parked .....	9-41

## Automatic Transmission

Automatic Transmission .....	9-41
------------------------------	------

## Manual Transmission

Manual Transmission .....	9-44
---------------------------	------

## Drive Systems

Four-Wheel Drive .....	9-46
------------------------	------

## Brakes

Antilock Brake System (ABS) .....	9-50
Parking Brake .....	9-51
Brake Assist .....	9-51
Hill Start Assist (HSA) .....	9-52

## Ride Control Systems

Traction Control System (TCS) .....	9-52
StabiliTrak System .....	9-53
Locking Rear Axle .....	9-54
Locking Front Axle .....	9-55

## Cruise Control

Cruise Control .....	9-57
----------------------	------

## Object Detection Systems

Rear Vision Camera (RVC) .....	9-60
--------------------------------	------

## Fuel

Fuel .....	9-64
Recommended Fuel .....	9-64
Gasoline Specifications .....	9-65
California Fuel Requirements .....	9-65

## 9-2 Driving and Operating

Fuels in Foreign Countries ...	9-65
Fuel Additives .....	9-65
Fuel E85 (85% Ethanol) .....	9-66
Filling the Tank .....	9-68
Filling a Portable Fuel Container .....	9-69

### Towing

General Towing Information .....	9-70
Driving Characteristics and Towing Tips .....	9-70
Trailer Towing .....	9-74
Towing Equipment .....	9-78
Trailer Recommendations ....	9-81

### Conversions and Add-Ons

Add-On Electrical Equipment .....	9-81
--------------------------------------	------

## Driving Information

### Defensive Driving

Defensive driving means “always expect the unexpected.” The first step in driving defensively is to wear your safety belt, see *Safety Belts on page 3-10*.

#### WARNING

Assume that other road users (pedestrians, bicyclists, and other drivers) are going to be careless and make mistakes. Anticipate what they might do and be ready. In addition:

- Allow enough following distance between you and the driver in front of you.
- Focus on the task of driving.

(Continued)

#### WARNING (Continued)

Driver distraction can cause collisions resulting in injury or possible death. These simple defensive driving techniques could save your life.

### Drunk Driving

#### WARNING

Drinking and then driving is very dangerous. Your reflexes, perceptions, attentiveness, and judgment can be affected by even a small amount of alcohol. You can have a serious — or even fatal — collision if you drive after drinking. Do not drink and drive or ride with a driver who has been drinking. Ride home in a cab; or if you are with a group, designate a driver who will not drink.

Death and injury associated with drinking and driving is a global tragedy.

Alcohol affects four things that anyone needs to drive a vehicle: judgment, muscular coordination, vision, and attentiveness.

Police records show that almost 40 percent of all motor vehicle-related deaths involve alcohol. In most cases, these deaths are the result of someone who was drinking and driving. In recent years, more than 17,000 annual motor vehicle-related deaths have been associated with the use of alcohol, with about 250,000 people injured.

For persons under 21, it is against the law in every U.S. state to drink alcohol. There are good medical, psychological, and developmental reasons for these laws.

The obvious way to eliminate the leading highway safety problem is for people never to drink alcohol and then drive.

Medical research shows that alcohol in a person's system can make crash injuries worse, especially injuries to the brain, spinal cord, or heart. This means that when anyone who has been drinking — driver or passenger — is in a crash, that person's chance of being killed or permanently disabled is higher than if the person had not been drinking.

## Control of a Vehicle

The following three systems help to control the vehicle while driving — brakes, steering, and accelerator. At times, as when driving on snow or ice, it is easy to ask more of those control systems than the tires and road can provide. Meaning, you can lose control of the vehicle. See *Traction Control System (TCS)* on page 9-52 and *StabiliTrak System* on page 9-53.

Adding non-dealer/non-retailer accessories can affect vehicle performance. See *Accessories and Modifications* on page 10-3.

## Braking

See *Brake System Warning Light* on page 5-14.

Braking action involves perception time and reaction time. Deciding to push the brake pedal is perception time. Actually doing it is reaction time.

Average reaction time is about three-fourths of a second. But that is only an average. It might be less with one driver and as long as two or three seconds or more with another. Age, physical condition, alertness, coordination, and eyesight all play a part. So do alcohol, drugs, and frustration. But even in three-fourths of a second, a vehicle moving at 100 km/h (60 mph) travels 20 m (66 ft).

## 9-4 Driving and Operating

---

That could be a lot of distance in an emergency, so keeping enough space between the vehicle and others is important.

And, of course, actual stopping distances vary greatly with the surface of the road, whether it is pavement or gravel; the condition of the road, whether it is wet, dry, or icy; tire tread; the condition of the brakes; the weight of the vehicle; and the amount of brake force applied.

Avoid needless heavy braking. Some people drive in spurts — heavy acceleration followed by heavy braking — rather than keeping pace with traffic. This is a mistake. The brakes might not have time to cool between hard stops. The brakes will wear out much faster with a lot of heavy braking. Keeping pace with the traffic and allowing realistic following distances eliminates a lot of unnecessary braking. That means better braking and longer brake life.

If the engine ever stops while the vehicle is being driven, brake normally but do not pump the brakes. If the brakes are pumped, the pedal could get harder to push down. If the engine stops, there will still be some power brake assist but it will be used when the brake is applied. Once the power assist is used up, it can take longer to stop and the brake pedal will be harder to push.

Adding non-dealer/non-retailer accessories can affect vehicle performance. See *Accessories and Modifications* on page 10-3.

### Steering

#### Power Steering

If power steering assist is lost because the engine stops or the power steering system is not functioning, the vehicle can be steered but it will take more effort.

### Steering Tips

It is important to take curves at a reasonable speed.

Traction in a curve depends on the condition of the tires and the road surface, the angle at which the curve is banked, and vehicle speed. While in a curve, speed is the one factor that can be controlled.

If there is a need to reduce speed, do it before entering the curve, while the front wheels are straight.

Try to adjust the speed so you can drive through the curve. Maintain a reasonable, steady speed. Wait to accelerate until out of the curve, and then accelerate gently into the straightaway.

## Steering in Emergencies

There are times when steering can be more effective than braking. For example, you come over a hill and find a truck stopped in your lane, or a car suddenly pulls out from nowhere, or a child darts out from between parked cars and stops right in front of you. These problems can be avoided by braking — if you can stop in time. But sometimes you cannot stop in time because there is no room. That is the time for evasive action — steering around the problem.

The vehicle can perform very well in emergencies like these. First apply the brakes. See *Braking on page 9-3*. It is better to remove as much speed as possible from a collision. Then steer around the problem, to the left or right depending on the space available.



An emergency like this requires close attention and a quick decision. If holding the steering wheel at the recommended 9 and 3 o'clock positions, it can be turned a full 180 degrees very quickly without removing either hand. But you have to act fast, steer quickly, and just as quickly straighten the wheel once you have avoided the object.

The fact that such emergency situations are always possible is a good reason to practice defensive driving at all times and wear safety belts properly.

## Off-Road Recovery

The vehicle's right wheels can drop off the edge of a road onto the shoulder while driving.



If the level of the shoulder is only slightly below the pavement, recovery should be fairly easy. Ease off the accelerator and then, if there is nothing in the way, steer so that the vehicle straddles the edge of the pavement.

## 9-6 Driving and Operating

---

Turn the steering wheel 8 to 13 cm (3 to 5 inches), about one-eighth turn, until the right front tire contacts the pavement edge. Then turn the steering wheel to go straight down the roadway.

### Loss of Control

Let us review what driving experts say about what happens when the three control systems — brakes, steering, and acceleration — do not have enough friction where the tires meet the road to do what the driver has asked.

In any emergency, do not give up. Keep trying to steer and constantly seek an escape route or area of less danger.

### Skidding

In a skid, a driver can lose control of the vehicle. Defensive drivers avoid most skids by taking reasonable care suited to existing conditions, and by not overdriving those conditions. But skids are always possible.

The three types of skids correspond to the vehicle's three control systems. In the braking skid, the wheels are not rolling. In the steering or cornering skid, too much speed or steering in a curve causes tires to slip and lose cornering force. And in the acceleration skid, too much throttle causes the driving wheels to spin.

If the vehicle starts to slide, ease your foot off the accelerator pedal and quickly steer the way you want the vehicle to go. If you start steering quickly enough, the vehicle may straighten out. Always be ready for a second skid if it occurs.

Of course, traction is reduced when water, snow, ice, gravel, or other material is on the road. For safety, slow down and adjust your driving to these conditions. It is important to slow down on slippery surfaces because stopping distance is longer and vehicle control more limited.

While driving on a surface with reduced traction, try your best to avoid sudden steering, acceleration, or braking, including reducing vehicle speed by shifting to a lower gear. Any sudden changes could cause the tires to slide. You might not realize the surface is slippery until the vehicle is skidding. Learn to recognize warning clues — such as enough water, ice, or packed snow on the road to make a mirrored surface — and slow down when you have any doubt.

Remember: Antilock brakes help avoid only the braking skid.

## Off-Road Driving

The airbag system is designed to work properly under a wide range of conditions, including off-road usage. Always wear your safety belt and observe safe driving speeds, especially on rough terrain.

Drinking and driving can be very dangerous on any road and this is certainly true for off-road driving. At the very time you need special alertness and driving skills, your reflexes, perceptions, and judgment can be affected by even a small amount of alcohol. You could have a serious — or even fatal — accident if you drink and drive or ride with a driver who has been drinking.

Off-roading can be great fun but has some definite hazards. The greatest of these is the terrain itself. When off-road driving, traffic lanes are not marked, curves are not banked, and there are no road signs. Surfaces can be slippery, rough, uphill, or downhill.

Avoid sharp turns and abrupt maneuvers. Failure to operate the vehicle correctly off-road could result in loss of vehicle control or vehicle rollover.

Off-roading involves some new skills. That is why it is very important that you read these driving tips and suggestions to help make off-road driving safer and more enjoyable.

## Before You Go Off-Roading

- Have all necessary maintenance and service work done.
- Make sure there is enough fuel, that fluid levels are where they should be, and that the spare tire is fully inflated.
- Be sure to read all the information about four-wheel-drive vehicles in this manual.
- Make sure all underbody shields, if the vehicle has them, are properly attached.
- Know the local laws that apply to off-roading where you will be driving or check with law enforcement people in the area.
- Be sure to get the necessary permission if you will be on private land.

### Loading Your Vehicle for Off-Road Driving

#### **WARNING**

- Cargo on the load floor piled higher than the seatbacks can be thrown forward during a sudden stop. You or your passengers could be injured. Keep cargo below the top of the seatbacks.
- Unsecured cargo on the load floor can be tossed about when driving over rough terrain. You or your passengers can be struck by flying objects. Secure the cargo properly.

(Continued)

#### **WARNING (Continued)**

- Heavy loads on the roof raise the vehicle's center of gravity, making it more likely to roll over. You can be seriously or fatally injured if the vehicle rolls over. Put heavy loads inside the cargo area, not on the roof. Keep cargo in the cargo area as far forward and low as possible.

There are some important things to remember about how to load your vehicle.

- The heaviest things should be on the floor, forward of the rear axle. Put heavier items as far forward as you can.
- Be sure the load is properly secured, so things are not tossed around.

You will find other important information under *Vehicle Load Limits* on page 9-27 and *Tires* on page 10-44.

#### **Environmental Concerns**

Off-road driving can provide wholesome and satisfying recreation. However, it also raises environmental concerns. We recognize these concerns and urge every off-roader to follow these basic rules for protecting the environment:

- Always use established trails, roads, and areas that have been specially set aside for public off-road recreational driving and obey all posted regulations.
- Avoid any driving practice that could damage shrubs, flowers, trees, or grasses or disturb wildlife. This includes wheel-spinning, breaking down trees, or unnecessary driving through streams or over soft ground.



- Always carry a litter bag and make sure all refuse is removed from any campsite before leaving.
- Take extreme care with open fires (where permitted), camp stoves, and lanterns.
- Never park your vehicle over dry grass or other combustible materials that could catch fire from the heat of the vehicle's exhaust system.

### Traveling to Remote Areas

It makes sense to plan your trip, especially when going to a remote area. Know the terrain and plan your route. Get accurate maps of trails and terrain. Check to see if there are any blocked or closed roads.

It is also a good idea to travel with at least one other vehicle in case something happens to one of them.

For vehicles with a winch, be sure to read the winch instructions. In a remote area, a winch can be handy if you get stuck but you will want to know how to use it properly.

### High Mobility Characteristics

The H3 has a 22.3 cm (8.8 inch) running ground clearance (A), a 23.4 cm (9.2 inch) axle to ground clearance (B), and a low center of gravity.

The H3T has a 24.1 cm (9.5 inch) running ground clearance (A), a 22.1 cm (8.7 inch) axle to ground clearance (B), and a low center of gravity.

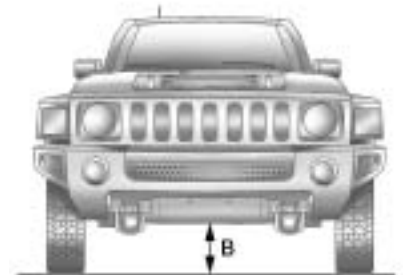

## 9-10 Driving and Operating

---

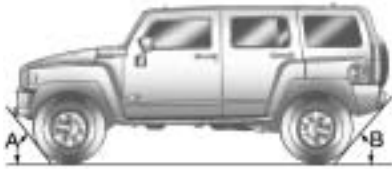

The H3 has an approximate approach angle (A) of 37.4 degrees and an approximate departure angle (B) of 34.7 degrees, depending on suspension packages.

The H3T has an approximate approach angle (A) of 37.1 degrees and an approximate departure angle (B) of 31 degrees, depending on suspension packages.



Design specifications required a minimum gradeability of 60% (31 degrees) slope, with the vehicle fully loaded, on high friction surfaces with maximum vehicle speed not to exceed 9.7 km/h (6 mph). The vehicle is expected to traverse this grade only for short durations. Never stop and idle the vehicle or park it on this grade.



The vehicle should be able to traverse a 40% (22 degrees) side slope at 9.7 km/h (6 mph) while fully loaded on high friction surfaces.

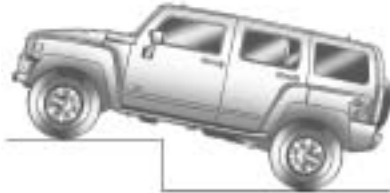

The vehicle can climb a 40.6 cm (16 inch) vertical step. Step climbing is best done by approaching the step at an angle rather than straight on.

### **Brake and Accelerator Operation Techniques for Off-Road Driving**

**For logs, walls, rocks, severe ditches, hills, sand, etc.**

1. Bring the vehicle to a complete stop. Do not rev the engine.
2. Select the proper transmission and transfer case gear range; usually 1 (First) gear, Four-Wheel-Low Lock for such obstacles.
3. If wheel spin is experienced, maintain steady throttle, with your foot off the brake pedal, to allow the Traction Control System (TCS) to control the wheel spin. TCS might not operate if the brakes are applied.
4. If wheel spin cannot be controlled by the TCS system, fully press the brake pedal with your left foot so all wheel spin is stopped.
5. Back away from the obstacle so that a new approach can be tried.
6. As the first wheel crosses the obstacle, be prepared to alternate the brake and accelerator pedal to maintain control and avoid tire drop-off from obstacles. Repeat this process for the other wheels.

## 9-12 Driving and Operating

### **For mounds, washouts, loose up-hill slopes, ditches, etc.**

When wheel spin occurs as the vehicle is moving, the driver may notice a slight shaking or shuddering of the vehicle. This should be stopped as soon as possible to prevent damage to vehicle components. This is the indication that a loss of traction is occurring on this terrain. The operator should:

1. Reduce speed and apply the brakes.
2. Assess the terrain properly and adjust vehicle speed and gear ranges accordingly: Four-Wheel High position for higher speeds and Four-Wheel-Low Lock for more torque and lower speeds. Transmission 1 (First) gear is generally recommended.

3. Apply slight pressure to the brake when the shaking or shuddering sensation is felt, keeping the vehicle moving in a controlled manner.
4. Be prepared to alternate between braking and accelerating through the adverse terrain.

### **Getting Familiar with Off-Road Driving**

It is a good idea to practice in an area that is safe and close to home before you go into the wilderness. Off-roading requires some new and different skills.

Tune your senses to different kinds of signals. Your eyes need to constantly sweep the terrain for unexpected obstacles. Your ears need to listen for unusual tire or engine sounds. Use your arms, hands, feet, and body to respond to vibrations and vehicle bounce.

Controlling the vehicle is the key to successful off-road driving. One of the best ways to control the vehicle is to control the speed. At higher speeds:

- You approach things faster and have less time to react.
- There is less time to scan the terrain for obstacles.
- The vehicle has more bounce when driving over obstacles.
- More braking distance is needed, especially on an unpaved surface.

#### **WARNING**

When you are driving off-road, bouncing and quick changes in direction can easily throw you out of position. This could cause you to lose control and crash. So, whether you are driving on or off the road, you and your passengers should wear safety belts.

### **Scanning the Terrain**

Off-road driving can take you over many different kinds of terrain. Be familiar with the terrain and its many different features.

**Surface Conditions:** Off-roading surfaces can be hard-packed dirt, gravel, rocks, grass, sand, mud, snow, or ice. Each of these surfaces affects the vehicle's steering, acceleration, and braking in different ways. Depending on the surface, slipping, sliding, wheel spinning, delayed acceleration, poor traction, and longer braking distances can occur.

**Surface Obstacles:** Unseen or hidden obstacles can be hazardous. A rock, log, hole, rut, or bump can startle you if you are not prepared for them. Often these obstacles are hidden by grass, bushes, snow, or even the rise and fall of the terrain itself.

Some things to consider:

- Is the path ahead clear?
- Will the surface texture change abruptly up ahead?
- Does the travel take you uphill or downhill?
- Will you have to stop suddenly or change direction quickly?

When driving over obstacles or rough terrain, keep a firm grip on the steering wheel. Ruts, troughs, or other surface features can jerk the wheel out of your hands.

When driving over bumps, rocks, or other obstacles, the wheels can leave the ground. If this happens, even with one or two wheels, you cannot control the vehicle as well or at all.

Because you will be on an unpaved surface, it is especially important to avoid sudden acceleration, sudden turns, or sudden braking.

Off-roading requires a different kind of alertness from driving on paved roads and highways. There are no road signs, posted speed limits, or signal lights. Use good judgment about what is safe and what is not.

## 9-14 Driving and Operating

### Crossing Obstacles

#### Approach Angle — a Key to Mobility

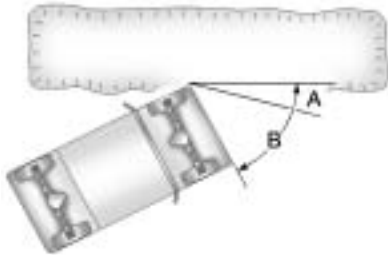

If you encounter a large dip in the terrain, do not enter straight on; enter at an angle — 15° minimum approach (A), 75° maximum approach angle (B). For very large dips, ditches or small washes, coast in, using the engine as a brake (transmission and transfer case lowest gears). Then, use the low ranges in the transmission and transfer case to power out.

### Roll The Tires Over Large Rocks



Do not straddle large rocks; drive over them, letting the tire cover the rock. The tread of the tire is thicker and tougher than the sidewall of the tire and is more resilient to impact than underbody components.

### Log Crossing

Using the proper technique, the vehicle will cross logs up to 25.4 cm (10 inches) in diameter. Approach the log at approximately a 15° angle (A) with the transmission in 1 (First) and the transfer case in Four-Wheel-Low Lock and “walk”

the vehicle over, one tire at a time. It may be necessary to modulate the brake pedal and accelerator to avoid spin-out. Ease the vehicle down from the log with the brake.



### Driving on Hills

Off-road driving often takes you up, down, or across a hill. Driving safely on hills requires good judgment and an understanding of what the vehicle can and cannot do. There are some hills that simply cannot be driven, no matter how well built the vehicle.

 **WARNING**

Many hills are simply too steep for any vehicle. If you drive up them, you will stall. If you drive down them, you cannot control your speed. If you drive across them, you will roll over. You could be seriously injured or killed. If you have any doubt about the steepness, do not drive the hill.

**Approaching a Hill**

When you approach a hill, decide if it is too steep to climb, descend, or cross. Steepness can be hard to judge. On a very small hill, for example, there may be a smooth, constant incline with only a small change in elevation where you can easily see all the way to the top. On a large hill, the incline may get steeper as you near the top, but you might not see this because the crest of the hill is hidden by bushes, grass, or shrubs.

Consider this as you approach a hill:

- Is there a constant incline, or does the hill get sharply steeper in places?
- Is there good traction on the hillside, or will the surface cause tire slipping?
- Is there a straight path up or down the hill so you will not have to make turning maneuvers?
- Are there obstructions on the hill that can block your path, such as boulders, trees, logs, or ruts?
- What is beyond the hill? Is there a cliff, an embankment, a drop-off, a fence? Get out and walk the hill if you do not know. It is the smart way to find out.
- Is the hill simply too rough? Steep hills often have ruts, gullies, troughs, and exposed rocks because they are more susceptible to the effects of erosion.

See *Hill Start Assist (HSA)* on page 9-52 for information on vehicles stopped on a grade.

**Driving Uphill**

Once you decide it is safe to drive up the hill:

- Use transmission and transfer case low gear and get a firm grip on the steering wheel.
- Get a smooth start up the hill and try to maintain speed. Not using more power than needed can avoid spinning the wheels or sliding.
- Let the traction system work to control any wheel slippage. The traction control system allows for moderate wheel spin with some capability to dig in and power up the hill.

## 9-16 Driving and Operating

---

- Do not continue if the vehicle shudders or exhibits suspension hopping. This can cause damage to the driveline or suspension components. Improper driving technique is not covered by the vehicle warranty.

### **WARNING**

Turning or driving across steep hills can be dangerous. You could lose traction, slide sideways, and possibly roll over. You could be seriously injured or killed. When driving up hills, always try to go straight up.

- Try to drive straight up the hill if at all possible. If the path twists and turns, you might want to find another route.
- Ease up on the speed as you approach the top of the hill.

- Attach a flag to the vehicle to be more visible to approaching traffic on trails or hills.
- Sound the horn as you approach the top of the hill to let opposing traffic know you are there.
- Use headlamps even during the day to make the vehicle more visible to oncoming traffic.

### **WARNING**

Driving to the top (crest) of a hill at full speed can cause an accident. There could be a drop-off, embankment, cliff, or even another vehicle. You could be seriously injured or killed. As you near the top of a hill, slow down and stay alert.

If the vehicle stalls, or is about to stall, and you cannot make it up the hill:

- Push the brake pedal to stop the vehicle and keep it from rolling backwards and apply the parking brake.
- If the engine is still running, shift the transmission to R (Reverse), release the parking brake, and slowly back down the hill in R (Reverse).
- If the engine has stopped running, you need to restart it. With the brake pedal pressed, apply the parking brake. If the vehicle has an automatic transmission, shift the transmission to P (Park). Restart the engine. Then, shift to R (Reverse), release the parking brake, and slowly back down the hill as straight as possible in R (Reverse).



- While backing down the hill, put your left hand on the steering wheel at the 12 o'clock position so you can tell if the wheels are straight and can maneuver as you back down. It is best to back down the hill with the wheels straight rather than in the left or right direction. Turning the wheel too far to the left or right will increase the possibility of a rollover.

Things not to do if the vehicle stalls, or is about to stall, when going up a hill:

- Never attempt to prevent a stall by shifting into N (Neutral) to rev-up the engine and regain forward momentum. This will not work. The vehicle can roll backward very quickly and could go out of control.

- Never try to turn around if about to stall when going up a hill. If the hill is steep enough to stall the vehicle, it is steep enough to cause it to roll over. If you cannot make it up the hill, back straight down the hill.

If, after stalling, you try to back down the hill and decide you just cannot do it, set the parking brake. If the vehicle has an automatic transmission, shift to P (Park). Turn off the engine. Leave the vehicle and go get some help. Exit on the uphill side and stay clear of the path the vehicle would take if it rolled downhill. Do not shift the transfer case to Neutral when you leave the vehicle. Leave it in some gear.

 **WARNING**

Shifting the transfer case to Neutral can cause your vehicle to roll even if the transmission is in P (Park). This is because the Neutral position on the transfer case overrides the transmission. You or someone else could be injured. If you are going to leave your vehicle, set the parking brake and shift the transmission to P (Park). But do not shift the transfer case to Neutral.

### Driving Downhill

When off-roading takes you downhill, consider:

- How steep is the downhill?  
Will I be able to maintain vehicle control?
- What is the surface like?  
Smooth? Rough? Slippery?  
Hard-packed dirt? Gravel?
- Are there hidden surface obstacles? Ruts? Logs? Boulders?
- What is at the bottom of the hill?  
Is there a hidden creek bank or even a river bottom with large rocks?

If you decide you can go down a hill safely, try to keep the vehicle headed straight down. Use a low gear so engine drag can help the brakes so they do not have to do all the work. Descend slowly, keeping the vehicle under control at all times.

#### **WARNING**

Heavy braking when going down a hill can cause your brakes to overheat and fade. This could cause loss of control and a serious accident. Apply the brakes lightly when descending a hill and use a low gear to keep vehicle speed under control.

Things not to do when driving down a hill:

- When driving downhill, avoid turns that take you across the incline of the hill. A hill that is not too steep to drive down might be too steep to drive across. The vehicle could roll over.
- Never go downhill with the transmission in N (Neutral), called free-wheeling. The brakes will have to do all the work and could overheat and fade.

Vehicles are much more likely to stall when going uphill, but if it happens when going downhill:

1. Stop the vehicle by applying the regular brakes and apply the parking brake.
2. With an automatic transmission, shift to P (Park). While still braking, restart the engine.
3. Shift back to a low gear, release the parking brake, and drive straight down.
4. If the engine will not start, get out and get help.

## Driving Across an Incline

An off-road trail will probably go across the incline of a hill. To decide whether to try to drive across the incline, consider the following:

 **WARNING**

Driving across an incline that is too steep will make your vehicle roll over. You could be seriously injured or killed. If you have any doubt about the steepness of the incline, do not drive across it. Find another route instead.

- A hill that can be driven straight up or down might be too steep to drive across. When going straight up or down a hill, the length of the wheel base — the distance from the front wheels to the rear wheels — reduces the likelihood the vehicle will tumble end over end. But when driving

across an incline, the narrower track width — the distance between the left and right wheels — might not prevent the vehicle from tilting and rolling over. Driving across an incline puts more weight on the downhill wheels which could cause a downhill slide or a rollover.

- Surface conditions can be a problem. Loose gravel, muddy spots, or even wet grass can cause the tires to slip sideways, downhill. If the vehicle slips sideways, it can hit something that will trip it — a rock, a rut, etc. — and roll over.
- Hidden obstacles can make the steepness of the incline even worse. If you drive across a rock with the uphill wheels, or if the downhill wheels drop into a rut or depression, the vehicle can tilt even more.

For these reasons, carefully consider whether to try to drive across an incline. Just because the trail goes across the incline does not mean you have to drive it. The last vehicle to try it might have rolled over.

If you feel the vehicle starting to slide sideways, turn downhill. This should help straighten out the vehicle and prevent the side slipping. The best way to prevent this is to “walk the course” first, so you know what the surface is like before driving it.

### Stalling on an Incline

 **WARNING**

Getting out on the downhill (low) side of a vehicle stopped across an incline is dangerous. If the vehicle rolls over, you could be crushed or killed. Always get out on the uphill (high) side of the vehicle and stay well clear of the rollover path.

If the vehicle stalls when crossing an incline, be sure you, and any passengers, get out on the uphill side, even if the door there is harder to open. If you get out on the downhill side and the vehicle starts to roll over, you will be right in its path.

If you have to walk down the slope, stay out of the path the vehicle will take if it does roll over.

### Driving in Mud, Sand, Snow, or Ice

When you drive in mud, snow, or sand, the wheels do not get good traction. Acceleration is not as quick, turning is more difficult, and braking distances are longer.

It is best to use a low gear when in mud — the deeper the mud, the lower the gear. In really deep mud, keep the vehicle moving so it does not get stuck.

When driving on sand, wheel traction changes. On loosely packed sand, such as on beaches or sand dunes, the tires will tend to sink into the sand. This affects steering, accelerating, and braking. Drive at a reduced speed and avoid sharp turns or abrupt maneuvers.

Hard packed snow and ice offer the worst tire traction. On these surfaces, it is very easy to lose control. On wet ice, for example, the traction is so poor that you will have difficulty accelerating. And, if the vehicle does get moving, poor steering and difficult braking can cause it to slide out of control.

 **WARNING**

Driving on frozen lakes, ponds, or rivers can be dangerous. Underwater springs, currents under the ice, or sudden thaws can weaken the ice. Your vehicle could fall through the ice and you and your passengers could drown. Drive your vehicle on safe surfaces only.

## Driving in Water

 **WARNING**

Driving through rushing water can be dangerous. Deep water can sweep your vehicle downstream and you and your passengers could drown. If it is only shallow water, it can still wash away the ground from under your tires, and you could lose traction and roll the vehicle over. Do not drive through rushing water.

Heavy rain can mean flash flooding, and flood waters demand extreme caution.

Find out how deep the water is before driving through it. Do not try it if it is deep enough to cover the wheel hubs, axles, or exhaust pipe — you probably will not get through. Deep water can damage the axle and other vehicle parts. The vehicle is capable of depths up to 50 cm (20 inches). Know how to judge whether the water is deeper than this before proceeding into it.

If the water is not too deep, drive slowly through it. At faster speeds, water splashes on the ignition system and the vehicle can stall. Stalling can also occur if you get the tailpipe under water. If the tailpipe is under water, you will never be able to start the engine. When going through water, remember that when the brakes get wet, it might take longer to stop. See *Driving on Wet Roads on page 9-22*.

## After Off-Road Driving

Remove any brush or debris that has collected on the underbody, chassis, or under the hood. These accumulations can be a fire hazard.

After operation in mud or sand, have the brake linings cleaned and checked. These substances can cause glazing and uneven braking. Check the engine and oil coolers for mud accumulation. Thoroughly and carefully clean these devices to allow proper cooling. Check the body structure, steering, suspension, wheels, tires, and exhaust system for damage and check the fuel lines and cooling system for any leakage.

The vehicle requires more frequent service due to off-road use. Refer to the Maintenance Schedule for additional information.

### Driving on Wet Roads

Rain and wet roads can reduce vehicle traction and affect your ability to stop and accelerate. Always drive slower in these types of driving conditions and avoid driving through large puddles and deep-standing or flowing water.

 **WARNING**

Wet brakes can cause crashes. They might not work as well in a quick stop and could cause pulling to one side. You could lose control of the vehicle.

After driving through a large puddle of water or a car/vehicle wash, lightly apply the brake pedal until the brakes work normally.

(Continued)

**WARNING (Continued)**

Flowing or rushing water creates strong forces. Driving through flowing water could cause your vehicle to be carried away. If this happens, you and other vehicle occupants could drown. Do not ignore police warnings and be very cautious about trying to drive through flowing water.

### Hydroplaning

Hydroplaning is dangerous. Water can build up under your vehicle's tires so they actually ride on the water. This can happen if the road is wet enough and you are going fast enough. When your vehicle is hydroplaning, it has little or no contact with the road.

There is no hard and fast rule about hydroplaning. The best advice is to slow down when the road is wet.

### Other Rainy Weather Tips

Besides slowing down, other wet weather driving tips include:

- Allow extra following distance.
- Pass with caution.
- Keep windshield wiper equipment in good shape.
- Keep the windshield washer fluid reservoir filled.
- Have good tires with proper tread depth. See *Tires on page 10-44*.
- Turn off cruise control.

### Highway Hypnosis

Always be alert and pay attention to your surroundings while driving. If you become tired or sleepy, find a safe place to park your vehicle and rest.

Other driving tips include:

- Keep the vehicle well ventilated.
- Keep interior temperature cool.
- Keep your eyes moving — scan the road ahead and to the sides.
- Check the rearview mirror and vehicle instruments often.

## Hill and Mountain Roads

Driving on steep hills or through mountains is different than driving on flat or rolling terrain. Tips for driving in these conditions include:

- Keep the vehicle serviced and in good shape.
- Check all fluid levels and brakes, tires, cooling system, and transmission.
- Going down steep or long hills, shift to a lower gear.

### WARNING

If you do not shift down, the brakes could get so hot that they would not work well. You would then have poor braking or even none going down a hill. You could crash. Shift down to let the engine assist the brakes on a steep downhill slope.

### WARNING

Coasting downhill in N (Neutral) or with the ignition off is dangerous. The brakes will have to do all the work of slowing down and they could get so hot that they would not work well. You would then have poor braking or even none going down a hill. You could crash. Always have the engine running and the vehicle in gear when going downhill.

- Stay in your own lane. Do not swing wide or cut across the center of the road. Drive at speeds that let you stay in your own lane.
- Top of hills: Be alert — something could be in your lane (stalled car, accident).
- Pay attention to special road signs (falling rocks area, winding roads, long grades, passing or no-passing zones) and take appropriate action.

### Winter Driving

#### Driving on Snow or Ice

Drive carefully when there is snow or ice between the tires and the road, creating less traction or grip. Wet ice can occur at about 0°C (32°F) when freezing rain begins to fall, resulting in even less traction. Avoid driving on wet ice or in freezing rain until roads can be treated with salt or sand.

Drive with caution, whatever the condition. Accelerate gently so traction is not lost. Accelerating too quickly causes the wheels to spin and makes the surface under the tires slick, so there is even less traction.

Try not to break the fragile traction. If you accelerate too fast, the drive wheels will spin and polish the surface under the tires even more.

The *Antilock Brake System (ABS)* on page 9-50 improves vehicle stability during hard stops on slippery roads, but apply the brakes sooner than when on dry pavement.

Allow greater following distance on any slippery road and watch for slippery spots. Icy patches can occur on otherwise clear roads in shaded areas. The surface of a curve or an overpass can remain icy when the surrounding roads are clear. Avoid sudden steering maneuvers and braking while on ice.

Turn off cruise control, if equipped, on slippery surfaces.

### Blizzard Conditions

Being stuck in snow can be a serious situation. Stay with the vehicle unless there is help nearby. If possible, use the *Roadside Service on page 13-5*. To get help and keep everyone in the vehicle safe:

- Turn on the hazard warning flashers.
- Tie a red cloth to an outside mirror.

#### **WARNING**

Snow can trap engine exhaust under the vehicle. This may cause exhaust gases to get inside. Engine exhaust contains carbon monoxide (CO) which cannot be seen or smelled. It can cause unconsciousness and even death.

(Continued)



**WARNING (Continued)**

If the vehicle is stuck in the snow:

- Clear away snow from around the base of your vehicle, especially any that is blocking the exhaust pipe.
- Check again from time to time to be sure snow does not collect there.
- Open a window about 5 cm (two inches) on the side of the vehicle that is away from the wind to bring in fresh air.
- Fully open the air outlets on or under the instrument panel.
- Adjust the Climate Control system to a setting that circulates the air inside the vehicle and set the fan speed to the highest setting. See Climate Control System in the Index.

(Continued)

**WARNING (Continued)**

For more information about carbon monoxide, see *Engine Exhaust on page 9-40*.

Snow can trap exhaust gases under your vehicle. This can cause deadly CO (carbon monoxide) gas to get inside. CO could overcome you and kill you. You cannot see it or smell it, so you might not know it is in your vehicle. Clear away snow from around the base of your vehicle, especially any that is blocking the exhaust.

Run the engine for short periods only as needed to keep warm, but be careful.

To save fuel, run the engine for only short periods as needed to warm the vehicle and then shut the engine off and close the window most of the way to save heat. Repeat this until help arrives but only when you feel really uncomfortable from the cold. Moving about to keep warm also helps.

If it takes some time for help to arrive, now and then when you run the engine, push the accelerator pedal slightly so the engine runs faster than the idle speed. This keeps the battery charged to restart the vehicle and to signal for help with the headlamps. Do this as little as possible to save fuel.

### If the Vehicle is Stuck

Slowly and cautiously spin the wheels to free the vehicle when stuck in sand, mud, ice, or snow.

If stuck too severely for the traction system to free the vehicle, turn the traction system off and use the rocking method.

#### WARNING

If the vehicle's tires spin at high speed, they can explode, and you or others could be injured. The vehicle can overheat, causing an engine compartment fire or other damage. Spin the wheels as little as possible and avoid going above 55 km/h (35 mph) as shown on the speedometer.

For information about using tire chains on the vehicle, see *Tire Chains* on page 10-64.

### Rocking the Vehicle to Get it Out

Turn the steering wheel left and right to clear the area around the front wheels. Turn off any traction system. Shift back and forth between R (Reverse) and a forward gear, or with a manual transmission, between 1 (First) or 2 (Second) and R (Reverse), spinning the wheels as little as possible. To prevent transmission wear, wait until the wheels stop spinning before shifting gears. Release the accelerator pedal while shifting, and press lightly on the accelerator pedal when the transmission is in gear. Slowly spinning the wheels in the forward and reverse directions causes a rocking motion that could free the vehicle. If that does not get the vehicle out after a few tries, it might need to be towed out. The recovery loops can be used. If the vehicle does need to be towed out, see *Towing the Vehicle* on page 10-90.

### Recovery Loops

#### WARNING

These loops, when used, are under a lot of force. Keep people away from the vicinity of the loops and any chains or cables during use. Always pull the vehicle straight out. Never pull on the loops at a sideways angle. The loops could break off and you or others could be injured from the chain or cable snapping back.

**Notice:** Never use the recovery loops to tow the vehicle. The vehicle could be damaged and it would not be covered by the vehicle warranty.



The vehicle has two recovery loops at the front of the vehicle and one at the rear of the vehicle.

Use them if the vehicle is stuck off-road and needs to be pulled to some place where the driver can continue driving.



If the vehicle has a brush guard, never tow or apply any loads onto the brush guard.

### Vehicle Load Limits

It is very important to know how much weight the vehicle can carry. This weight is called the vehicle capacity weight and includes the weight of all occupants, cargo and all nonfactory-installed options.

Two labels on the vehicle show how much weight it may properly carry, the Tire and Loading Information label and the Certification/Tire label.

#### **WARNING**

Do not load the vehicle any heavier than the Gross Vehicle Weight Rating (GVWR), or either the maximum front or rear Gross Axle Weight Rating (GAWR). If you do, parts on the vehicle can break, and it can change the way the vehicle handles. These could cause you to lose control and crash. Also, overloading can shorten the life of the vehicle.

## 9-28 Driving and Operating

### Tire and Loading Information Label

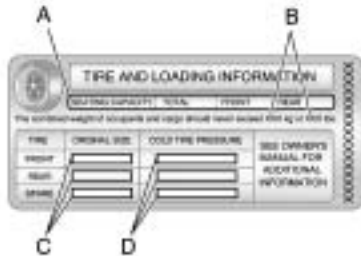

#### Label Example

A vehicle specific Tire and Loading Information label is attached to the vehicle's center pillar (B-pillar). With the driver door open, you will find the label attached below the door latch post. The Tire and Loading Information label shows the number of occupant seating

positions (A), and the maximum vehicle capacity weight (B) in kilograms and pounds.

The Tire and Loading Information label also shows the size of the vehicle's original equipment tires (C) and the recommended cold tire inflation pressures (D). For more information on tires and inflation see *Tires on page 10-44* and *Tire Pressure on page 10-51*.

There is also important information on the Certification/Tire label. It tells Gross Vehicle Weight Rating (GVWR) and the Gross Axle Weight Rating (GAWR) for the front and rear axles. See "Certification/Tire Label" later in this section.

### Steps for Determining Correct Load Limit

1. Locate the statement "The combined weight of occupants and cargo should never exceed XXX kg or XXX lbs" on your vehicle's placard.
2. Determine the combined weight of the driver and passengers that will be riding in your vehicle.
3. Subtract the combined weight of the driver and passengers from XXX kg or XXX lbs.

4. The resulting figure equals the available amount of cargo and luggage load capacity. For example, if the “XXX” amount equals 1400 lbs and there will be five 150 lb passengers in your vehicle, the amount of available cargo and luggage load capacity is 650 lbs (1400 – 750 (5 x 150) = 650 lbs).
5. Determine the combined weight of luggage and cargo being loaded on the vehicle. That weight may not safely exceed the available cargo and luggage load capacity calculated in Step 4.

6. If your vehicle will be towing a trailer, the load from your trailer will be transferred to your vehicle. Consult this manual to determine how this reduces the available cargo and luggage load capacity of your vehicle.

See *Trailer Towing on page 9-74* for important information on towing a trailer, towing safety, and trailering tips.

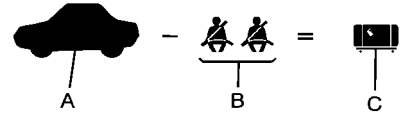

**Example 1**

- A. Vehicle Capacity Weight for Example 1 = 453 kg (1,000 lbs).
- B. Subtract Occupant Weight @ 68 kg (150 lbs) × 2 = 136 kg (300 lbs).
- C. Available Occupant and Cargo Weight = 317 kg (700 lbs).

## 9-30 Driving and Operating

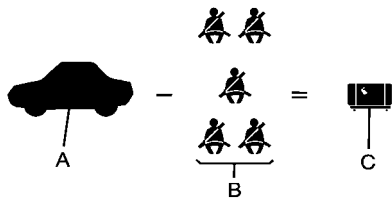

### Example 2

- A. Vehicle Capacity Weight for Example 2 = 453 kg (1,000 lbs).
- B. Subtract Occupant Weight @ 68 kg (150 lbs)  $\times$  5 = 340 kg (750 lbs).
- C. Available Cargo Weight = 113 kg (250 lbs).

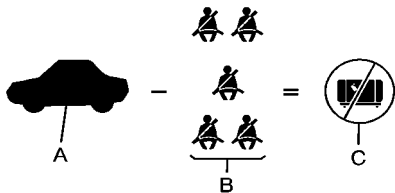

### Example 3

- A. Vehicle Capacity Weight for Example 3 = 453 kg (1,000 lbs).
- B. Subtract Occupant Weight @ 91 kg (200 lbs)  $\times$  5 = 453 kg (1,000 lbs).
- C. Available Cargo Weight = 0 kg (0 lbs).

Refer to the vehicle's Tire and Loading Information label for specific information about the vehicle's capacity weight and seating positions. The combined weight of the driver, passengers, cargo and any accessories or equipment added to the vehicle after it left the factory should never exceed the vehicle's capacity weight.

**Certification/Tire Label**



**Label Example**

A vehicle specific Certification/Tire label is attached to the bottom section of the driver side

center pillar (B-pillar) or on the end of the driver side instrument panel. The label shows the Gross Vehicle Weight Rating (GVWR). The GVWR includes the weight of the vehicle, all occupants, fuel, cargo and trailer tongue weight, if pulling a trailer.

The Certification/Tire label also tells the maximum weights for the front and rear axles, called Gross Axle Weight Rating (GAWR). To find out the actual loads on the front and rear

axles, go to a weigh station and weigh the vehicle. Your dealer can help with this. Be sure to spread out the load equally on both sides of the centerline.

Never exceed the GVWR for the vehicle, or the GAWR for either the front or rear axle.

If the load is heavy, it should be spread out.

## 9-32 Driving and Operating

Similar appearing vehicles may have different GVWRs and capacity weights. Please note the vehicle's Certification/Tire label or consult your dealer for additional details.

### WARNING

Do not load the vehicle any heavier than the Gross Vehicle Weight Rating (GVWR), or either the maximum front or rear Gross Axle Weight Rating (GAWR). If you do, parts on the vehicle can break, and it can change the way the vehicle handles. These could cause you to lose control and crash. Also, overloading can shorten the life of the vehicle.

Using heavier suspension components to get added durability might not change the weight ratings. Ask your dealer to help you load the vehicle the right way.

**Notice : Overloading the vehicle may cause damage. Repairs would not be covered by the vehicle warranty. Do not overload the vehicle.**

If you put things inside your vehicle – like suitcases, tools, packages, or anything else – they will go as fast as the vehicle goes. If you have to stop or turn quickly, or if there is a crash, they will keep going.

### WARNING

Things you put inside your vehicle can strike and injure people in a sudden stop or turn, or in a crash.

- Put things in the cargo area of your vehicle. Try to spread the weight evenly.
- Never stack heavier things, like suitcases, inside the vehicle so that some of them are above the tops of the seats.
- Do not leave an unsecured child restraint in your vehicle.
- When you carry something inside the vehicle, secure it whenever you can.
- Do not leave a seat folded down unless you need to.



There is also important loading information for off-road driving in this manual. See “*Loading Your Vehicle for Off-Road Driving*” under *Off-Road Driving on page 9-7*.

## Truck-Camper Loading Information

The vehicle was neither designed nor intended to carry a slide-in type camper.

**Notice :** Adding a slide-in camper or similar equipment to the vehicle can damage it, and the repairs would not be covered by the vehicle warranty. Do not install a slide-in camper or similar equipment on the vehicle.

## Starting and Operating

### New Vehicle Break-In

**Notice:** The vehicle does not need an elaborate break-in. But it will perform better in the long run if you follow these guidelines:

- Keep your speed at 88 km/h (55 mph) or less for the first 805 km (500 miles).
- Do not drive at any one constant speed, fast or slow, for the first 805 km (500 miles). Do not make full-throttle starts. Avoid downshifting to brake or slow the vehicle.

- Avoid making hard stops for the first 322 km (200 miles) or so. During this time the new brake linings are not yet broken in. Hard stops with new linings can mean premature wear and earlier replacement. Follow this breaking-in guideline every time you get new brake linings.
- Do not tow a trailer during break-in. See *Driving Characteristics and Towing Tips on page 9-70* for the trailer towing capabilities of the vehicle and more information.

Following break-in, engine speed and load can be gradually increased.

## Ignition Positions

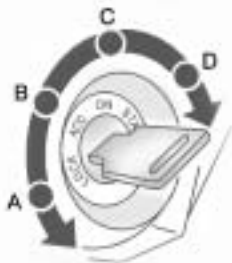

The ignition switch has four different positions.

To shift out of P (Park), turn the ignition to ON/RUN and apply the regular brake pedal.

**Notice:** Using a tool to force the key to turn in the ignition could cause damage to the switch or break the key. Use the correct key, make sure it is all the way in, and turn it only with your hand. If the key cannot be turned by hand, see your dealer.

**(A) LOCK/OFF:** This position locks the ignition. It also locks the transmission on automatic transmission vehicles. It locks the steering wheel on manual transmission vehicles. The key can only be removed in LOCK/OFF.

On vehicles with an automatic transmission, the shift lever must be in P (Park) to turn the ignition switch to LOCK/OFF.

The steering can bind with the wheels turned off center. If this happens, move the steering wheel from right to left while turning the key to ACC/ACCESSORY. If this doesn't work, then the vehicle needs service.

**(B) ACC/ACCESSORY:** This is the position in which you can operate the electrical accessories or items plugged into the accessory power outlets. On automatic transmission vehicles, this position unlocks the ignition. On manual transmission vehicles, it unlocks the ignition and

steering wheel. Use this position if the vehicle must be pushed or towed.

**(C) ON/RUN:** This position can be used to operate the electrical accessories and to display some instrument panel cluster warning and indicator lights. The switch stays in this position when the engine is running. The transmission is also unlocked in this position on automatic transmission vehicles.

If you leave the key in the ACC/ACCESSORY or ON/RUN position with the engine off, the battery could be drained. You may not be able to start the vehicle if the battery is allowed to drain for an extended period of time.

**(D) START:** This is the position that starts the engine. When the engine starts, release the key. The ignition switch returns to ON/RUN for driving.

A warning tone will sound when the driver door is opened, the ignition is in ACC/ACCESSORY or LOCK/OFF and the key is in the ignition.

## Retained Accessory Power (RAP)

These vehicle accessories can be used for up to 20 minutes after the engine is turned off:

- Audio System
- Front Wipers
- Power Windows
- Sunroof (if equipped)

These features will work when the key is in ON/RUN or ACC/ACCESSORY. Once the key is turned from ON/RUN to LOCK/OFF, these features continue working for up to 20 minutes or until a door is opened.

## Starting the Engine

Place the transmission in the proper gear.

### Automatic Transmission

Move the shift lever to P (Park) or N (Neutral). The engine will not start in any other position. To restart the vehicle when it is already moving, use N (Neutral) only.

**Notice: Do not try to shift to P (Park) if the vehicle is moving. If you do, you could damage the transmission. Shift to P (Park) only when the vehicle is stopped.**

### Manual Transmission

The shift lever should be in N (Neutral) and the parking brake engaged. Hold the clutch pedal down to the floor and start the engine. The vehicle will not start if the clutch pedal is not all the way down.

## Starting Procedure

1. With your foot off the accelerator pedal, turn the ignition key to START. When the engine starts, let go of the key. The idle speed will go down as the engine warms. Do not race the engine immediately after starting it. Operate the engine and transmission gently to allow the oil to warm up and lubricate all moving parts.

The vehicle has a Computer-Controlled Cranking System. This feature assists in starting the engine and protects components. If the ignition key is turned to the START position, and then released when the engine begins cranking, the engine will continue cranking for a few seconds or until the vehicle starts. If the engine does not start and the key is held in START for many seconds, cranking will be stopped after 15 seconds to prevent cranking motor damage.

To prevent gear damage, this system also prevents cranking if the engine is already running. Engine cranking can be stopped by turning the ignition switch to ACC/ACCESSORY or LOCK/OFF.

**Notice: Cranking the engine for long periods of time, by returning the key to the START position immediately after cranking has ended, can overheat and damage the cranking motor, and drain the battery. Wait at least 15 seconds between each try, to let the cranking motor cool down.**

2. If the engine does not start after 5-10 seconds, especially in very cold weather (below 0°F or -18°C), it could be flooded with too much gasoline. Push the accelerator pedal all the way to the floor and holding it there as you hold the key in START for a maximum of 15 seconds.

Wait at least 15 seconds between each try, to allow the cranking motor to cool. When the engine starts, let go of the key and accelerator. If the vehicle starts briefly but then stops again, repeat the procedure. This clears the extra gasoline from the engine. Do not race the engine immediately after starting it. Operate the engine and transmission gently until the oil warms up and lubricates all moving parts.

**Notice: The engine is designed to work with the electronics in the vehicle. If you add electrical parts or accessories, you could change the way the engine operates. Before adding electrical equipment, check with your dealer. If you do not, the engine might not perform properly. Any resulting damage would not be covered by the vehicle warranty.**

### Engine Coolant Heater

The engine coolant heater can provide easier starting and better fuel economy during engine warm-up in cold weather conditions at or below -18°C (0°F). Vehicles with an engine coolant heater should be plugged in at least four hours before starting. An internal thermostat in the plug-end of the cord may exist which will prevent engine coolant heater operation at temperatures above -18°C (0°F).

#### To Use the Engine Coolant Heater

1. Turn off the engine.
2. Open the hood and unwrap the electrical cord. The cord is located in the engine compartment behind the underhood fuse block on the driver side of the vehicle.

3. Plug it into a normal, grounded 110-volt AC outlet.

 **WARNING**

Plugging the cord into an ungrounded outlet could cause an electrical shock. Also, the wrong kind of extension cord could overheat and cause a fire. You could be seriously injured. Plug the cord into a properly grounded three-prong 110-volt AC outlet. If the cord will not reach, use a heavy-duty three-prong extension cord rated for at least 15 amps.

4. Before starting the engine, be sure to unplug and store the cord to prevent damage.

The length of time the heater should remain plugged in depends on several factors. Ask a dealer in the area where you will be parking the vehicle for the best advice on this.

### Shifting Into Park

 **WARNING**

It can be dangerous to get out of the vehicle if the shift lever is not fully in P (Park) with the parking brake firmly set. The vehicle can roll. If you have left the engine running, the vehicle can move suddenly. You or others could be injured. To be sure the vehicle will not move, even when you are on fairly level ground, use the steps that follow. If you are pulling a trailer, see *Driving Characteristics and Towing Tips on page 9-70*.

1. Hold the brake pedal down, then set the parking brake.

See *Parking Brake on page 9-51* for more information.

 **WARNING**

With all-wheel drive, the vehicle will be free to roll — even if the shift lever is in P (Park) — if the transfer case is in Neutral. So, be sure the transfer case is in a drive gear, four-wheel high (4H) or four-wheel low (4L) — not in Neutral.

2. Move the shift lever into P (Park) by pressing the shift lever button and moving the lever as far forward as it will go.
3. Turn the ignition key to LOCK/OFF.
4. Remove the key from the ignition.

### Leaving Your Vehicle With the Engine Running (Automatic Transmission)

 **WARNING**

It can be dangerous to leave the vehicle with the engine running. The vehicle could move suddenly if the shift lever is not fully in P (Park) with the parking brake firmly set. And, if you leave the vehicle with the engine running, it could overheat and even catch fire. You or others could be injured. Do not leave the vehicle with the engine running.

If you have to leave the vehicle with the engine running, be sure the vehicle is in P (Park) and the parking brake is firmly set before you leave it. After you have moved the shift lever into P (Park), hold the regular brake pedal down. Then, see if you can move the shift lever away from P (Park) without first pressing the shift lever button. If you can, it means that the shift lever was not fully locked into P (Park).

Torque lock is when the weight of the vehicle puts too much force on the parking pawl in the transmission. This happens when parking on a hill and shifting the transmission into P (Park) is not done properly and then it is difficult to shift out of P (Park). To prevent torque lock, set the parking brake and then shift into P (Park). To find out how, see “Shifting Into P (Park)” listed previously.

If torque lock does occur, your vehicle may need to be pushed uphill by another vehicle to relieve the parking pawl pressure, so you can shift out of P (Park).

### Shifting Out of Park

This vehicle is equipped with an electronic shift lock release system. The shift lock release is designed to:

- Prevent ignition key removal unless the shift lever is in P (Park) with the shift lever button fully released, and
- Prevent movement of the shift lever out of P (Park) unless the ignition is in ON/RUN or ACC/ACCESSORY and the regular brake pedal is applied.

The shift lock release is always functional except in the case of a an uncharged or low voltage (less than 9 volt) battery.

If the vehicle has an uncharged battery or a battery with low voltage, try charging or jump starting the battery. See *Jump Starting on page 10-86* for more information.

To shift out of P (Park):

1. Apply the brake pedal.
2. Then press the shift lever button.
3. Move the shift lever to the desired position.

If you still are unable to shift out of P (Park):

1. Fully release the shift lever button.
2. While holding down the brake pedal, press the shift lever button again.
3. Move the shift lever to the desired position.

If you still cannot move the shift lever from P (Park), consult your dealer or a professional towing service.

## **Parking**

If the vehicle has a manual transmission, before you get out of the vehicle, move the shift lever into R (Reverse), and firmly apply the parking brake. Once the shift lever has been placed into R (Reverse) with the clutch pedal pressed in, turn the ignition key to LOCK/OFF, remove the key and release the clutch.

If you are parking on a hill, or if the vehicle is pulling a trailer, see *Driving Characteristics and Towing Tips on page 9-70*.

## Parking Over Things That Burn

 **WARNING**

Things that can burn could touch hot exhaust parts under the vehicle and ignite. Do not park over papers, leaves, dry grass, or other things that can burn.

## Engine Exhaust

 **WARNING**

Engine exhaust contains Carbon Monoxide (CO) which cannot be seen or smelled. Exposure to CO can cause unconsciousness and even death.

Exhaust may enter the vehicle if:

- The vehicle idles in areas with poor ventilation (parking garages, tunnels, deep snow that may block underbody airflow or tail pipes).
- The exhaust smells or sounds strange or different.
- The exhaust system leaks due to corrosion or damage.

(Continued)

**WARNING (Continued)**

- The vehicle's exhaust system has been modified, damaged or improperly repaired.
- There are holes or openings in the vehicle body from damage or after-market modifications that are not completely sealed.

If unusual fumes are detected or if it is suspected that exhaust is coming into the vehicle:

- Drive it only with the windows completely down.
- Have the vehicle repaired immediately.

Never park the vehicle with the engine running in an enclosed area such as a garage or a building that has no fresh air ventilation.



## Running the Vehicle While Parked

It is better not to park with the engine running. But if you ever have to, here are some things to know.

### WARNING

Idling a vehicle in an enclosed area with poor ventilation is dangerous. Engine exhaust may enter the vehicle. Engine exhaust contains Carbon Monoxide (CO) which cannot be seen or smelled. It can cause unconsciousness and even death. Never run the engine in an enclosed area that has no fresh air ventilation. For more information, see *Engine Exhaust on page 9-40*.

### WARNING

It can be dangerous to get out of the vehicle if the automatic transmission shift lever is not fully in P (Park) with the parking brake firmly set. The vehicle can roll. Do not leave the vehicle when the engine is running unless you have to. If you have left the engine running, the vehicle can move suddenly. You or others could be injured. To be sure the vehicle will not move, even when it is on fairly level ground, always set the parking brake and move the automatic transmission shift lever to P (Park), or the manual transmission shift lever to Neutral.

Follow the proper steps to be sure the vehicle will not move. See *Shifting Into Park on page 9-37* and *Parking on page 9-39*.

If pulling a trailer, see *Driving Characteristics and Towing Tips on page 9-70*.

## Automatic Transmission



The automatic transmission has a shift lever on the console.



It features an electronic shift position indicator within the instrument cluster.

There are several different positions for the shift lever.

**P (Park):** This position locks the rear wheels. It is the best position to use when you start the engine because the vehicle cannot move easily.

### **WARNING**

It is dangerous to get out of the vehicle if the shift lever is not fully in P (Park) with the parking brake firmly set. The vehicle can roll.

Do not leave the vehicle when the engine is running unless you have to. If you have left the engine running, the vehicle can move suddenly. You or others could be injured. To be sure the vehicle will not move, even when you are on fairly level ground, always set the parking brake and move the shift lever to P (Park). See *Shifting Into Park* on page 9-37. If you are pulling a trailer, see *Driving Characteristics and Towing Tips* on page 9-70.

Make sure the shift lever is fully in P (Park) before starting the engine. The vehicle has an automatic transmission shift lock control system. You must fully apply the regular brakes first and then press the shift lever button before you can shift from P (Park) when the ignition key is in ON/RUN. If you cannot shift out of P (Park), ease pressure on the shift lever and push the shift lever all the way into P (Park) as you maintain brake application. Then press the shift lever button and move the shift lever into another gear. See *Shifting Out of Park* on page 9-38.

**R (Reverse):** Use this gear to back up.

**Notice:** **Shifting to R (Reverse) while the vehicle is moving forward could damage the transmission. The repairs would not be covered by the vehicle warranty. Shift to R (Reverse) only after the vehicle is stopped.**

To rock the vehicle back and forth to get out of snow, ice, or sand without damaging the transmission, see *If the Vehicle is Stuck on page 9-26*.

**N (Neutral):** In this position, the engine does not connect with the wheels. To restart the engine when the vehicle is already moving, use N (Neutral) only.

 **WARNING**

Shifting into a drive gear while the engine is running at high speed is dangerous. Unless your foot is firmly on the brake pedal, the vehicle could move very rapidly. You could lose control and hit people or objects. Do not shift into a drive gear while the engine is running at high speed.

**Notice: Shifting out of P (Park) or N (Neutral) with the engine running at high speed may damage the transmission. The repairs would not be covered by the vehicle warranty. Be sure the engine is not running at high speed when shifting the vehicle.**

**D (Drive):** This position is for normal driving. It provides the best fuel economy. If you need more power for passing, and you are:

- Going less than about 55 km/h (35 mph), push the accelerator pedal about halfway down.
- Going about 55 km/h (35 mph) or more, push the accelerator all the way down.

Downshifting the transmission in slippery road conditions could result in skidding, see “Skidding” under *Loss of Control on page 9-6*.

D (Drive) can be used when towing a trailer. You may want to shift the transmission to 3 (Third) or, if necessary, a lower gear if the transmission shifts too often under heavy loads or in hilly conditions.

**3 (Third):** This position is also used for normal driving. However it reduces vehicle speed more than D (Drive) without using the brakes. You might choose 3 (Third) instead of D (Drive) when driving on hilly or winding roads, or when towing a trailer, so there is less shifting between gears, or when going down a steep hill.

## 9-44 Driving and Operating

---

**2 (Second):** This position reduces vehicle speed even more than 3 (Third) without using the brakes. You can use 2 (Second) on hills. It can help control vehicle speed as you go down steep mountain roads, but then you would also want to use the brakes off and on.

**1 (First):** This position reduces vehicle speed even more than 2 (Second) without using the brakes. You can use it on very steep hills, or in deep snow or mud. If the shift lever is put in 1 (First) while the vehicle is moving forward, the transmission will not shift into first gear until the vehicle is going slowly enough.

**Notice:** Spinning the tires or holding the vehicle in one place on a hill using only the accelerator pedal may damage the transmission. The repair will not be covered by the vehicle warranty. If you are stuck, do not spin the tires. When stopping on a hill, use the brakes to hold the vehicle in place.

### Hill Start Assist

H3 and H3T vehicles have a Hill Start Assist feature, which may be useful when stopped on a grade. See *Braking on page 9-3* for more information.

## Manual Transmission



This is the shift pattern.

Vehicles with a manual transmission operate as described below:

**1 (First):** Press the clutch pedal and shift into 1 (First). Then slowly let up on the clutch pedal as you slowly press down on the accelerator pedal.

You can shift into 1 (First) when you are going less than 30 km/h (20 mph). If you have come to a complete stop and it is hard to shift into 1 (First), put the shift lever in Neutral and let up on the clutch. Then press the clutch pedal back down and shift into 1 (First).

**2 (Second):** Press the clutch pedal as you let up on the accelerator pedal and shift into 2 (Second). Then, slowly let up on the clutch pedal as you press the accelerator pedal.

**3 (Third), 4 (Fourth) and 5 (Fifth):** Shift into 3 (Third), 4 (Fourth) and 5 (Fifth) the same way you do for 2 (Second). Slowly let up on the clutch pedal as you press the accelerator pedal.

To stop, let up on the accelerator pedal and press the brake pedal. Just before the vehicle stops, press the clutch pedal and the brake pedal, and shift to Neutral.

**Neutral:** Use this position when you start or idle the engine.

**R (Reverse):** To back up, stop the vehicle. Press the clutch pedal and shift into R (Reverse). Slowly let up on the clutch pedal as you press the accelerator pedal. If it is hard to shift, let the shift lever return to Neutral and release the clutch pedal. Then press the clutch again and shift into R (Reverse). Do not attempt to shift into the fifth gear position prior to shifting into R (Reverse). The transmission has a lock out feature which prevents a 5 (Fifth) gear to R (Reverse) gear shift.

**Notice: Shifting to R (Reverse) while the vehicle is moving forward could damage the transmission. The repairs would not be covered by the vehicle warranty. Shift to R (Reverse) only after the vehicle is stopped.**

Use R (Reverse), along with the parking brake, for parking the vehicle.

## Up-Shift Light



This light will show you when to shift to the next higher gear for best fuel economy.

When this light comes on, you can shift to the next higher gear if weather, road and traffic conditions permit. For the best fuel economy, accelerate slowly and shift when the light comes on.

While you accelerate, it is normal for the light to go on and off if you quickly change the position of the accelerator. Ignore the shift light when you downshift.

Disregard the shift light when the transfer case is in four-wheel low.

For more information, see *Up-Shift Light* on page 5-15.

## Shift Speeds

**⚠ WARNING**

If you skip a gear when you downshift, you could lose control of the vehicle. You could injure yourself or others. Do not shift down more than one gear at a time when you downshift.

## Hill Start Assist

H3 and H3T vehicles have a Hill Start Assist feature, which may be useful when stopped on a grade. See *Braking on page 9-3* for more information.

## Drive Systems

### Four-Wheel Drive

Full-Time Four-Wheel Drive sends engine power to all four wheels for extra traction. To get the most out of Full-Time Four-Wheel Drive, you must be familiar with its operation.

### Transfer Case Buttons



The transfer case buttons are located to the right of the instrument panel cluster. Use these switches to shift into and out of the different Full-Time Four-Wheel Drive modes.

**4 ↑ (Four-Wheel High):** This setting is used for driving in most street and highway situations. You can also use this setting for light or variable off-road conditions.

**N (Neutral):** Shift the transfer case to Neutral only when towing the vehicle. See *Driving Characteristics and Towing Tips on page 9-70* for more information.

**Notice:** Driving on pavement in Four-Wheel High Lock or Four Wheel Low Lock for extended periods may cause premature wear on the vehicle powertrain and tires. Do not drive in Four-Wheel High Lock or Four-Wheel Low Lock on pavement for extended periods.

**4 ↑ (Four-Wheel-High Lock):** Use this setting when you need extra traction in most off-road situations such as sand, mud, snow or level, rocky trails.

**Notice: Operating the vehicle in Four-Wheel-Low Lock above 48 km/h (30 mph) for any extended period of time could cause damage to the transfer case. Do not operate the vehicle in Four-Wheel-Low Lock above 48 km/h (30 mph) for extended periods.**

#### 4 ↓ (Four-Wheel-Low Lock):

This setting delivers extra torque to all four wheels and is used for extreme off-road conditions.

If the vehicle has locking axles, they can be locked for additional traction in extreme off-road situations. See *Locking Rear Axle on page 9-54* and *Locking Front Axle on page 9-55*.

Indicator lights in the buttons show which setting the transfer case is in. The indicator lights will come on briefly when the ignition is in ON/RUN. The If the lights do not come on, take the vehicle to your dealer for service. An indicator light

will flash while shifting the transfer case. If the transfer case cannot make a requested shift, it will return to the last chosen setting.

If the SERV 4WD message on the Driver Information Center (DIC) stays on, take the vehicle to your dealer for service. See Service 4WD message under *Driver Information Center (DIC) on page 5-18*.

#### Shifting between Four-Wheel High and Four-Wheel-High Lock

With the vehicle traveling less than 120 km/h (75 mph), press and release the Four-Wheel High or Four-Wheel-High Lock button.

It may be necessary to drive backwards while turning for a distance of 7.5 m (25 feet) to get the lock feature to disengage.

#### Shifting into Four-Wheel Low Lock

**Notice: Shifting the transmission into gear before the indicator light stops flashing could cause damage to the transfer case.**

**Always wait until the indicator light stops flashing before putting the transmission back in gear.**

To shift into Four-Wheel-Low Lock, the ignition must be in ON/RUN and the vehicle must be stopped or moving less than 5 km/h (3 mph) with the transmission in N (Neutral). The preferred method for shifting into Four-Wheel Low is to have the vehicle moving 1.6 to 3.2 km/h (1 to 2 mph). Press and release the Four-Wheel-Low Lock button. If the vehicle has a manual transmission, the clutch pedal must be pressed to the floor while you press the Four-Wheel-Low Lock button, or the shift will not be completed. You must wait for the Four-Wheel-Low Lock indicator light to stop flashing and remain lit before shifting the transmission into gear.

It is normal for the vehicle to have engagement noise and bump when shifting between Four-Wheel Low and Four-Wheel High ranges or from Neutral.

If the Four-Wheel-Low Lock button is pressed when the vehicle is in gear and/or moving too fast, the Four-Wheel-Low Lock indicator light will flash for 15 seconds and not complete the shift.

### Shifting Out of Four-Wheel-Low Lock

**Notice:** Shifting the transmission into gear before the indicator light stops flashing could cause damage to the transfer case. Always wait until the indicator light stops flashing before putting the transmission back in gear.

To shift out of Four-Wheel-Low Lock, the vehicle must be stopped or moving less than 5 km/h (3 mph) with the transmission in N (Neutral) and the ignition in ON/RUN. The preferred method for shifting out of Four-Wheel-Low Lock is to have the vehicle moving 1.6 to 3.2 km/h (1 to 2 mph). Press and release the Four-Wheel High or Four-Wheel-High Lock button.

If the vehicle has a manual transmission, the clutch pedal must be pressed to the floor while you press the Four-Wheel High or Four-Wheel-High Lock button, or the shift will not be completed. You must wait for the Four-Wheel High or Four-Wheel-High Lock indicator light to stop flashing and remain lit before shifting the transmission into gear.

It is normal for the vehicle to have engagement noise and bump when shifting between Four-Wheel Low and Four-Wheel High ranges or from Neutral.

If the Four-Wheel High or Four-Wheel-High Lock button is pressed when the vehicle is in gear and/or moving too fast, the Four-Wheel High or Four-Wheel-High Lock indicator light will flash for 15 seconds but will not complete the shift.

### Shifting Into Neutral

To shift the transfer case to Neutral:

1. Set the parking brake.
2. Start the vehicle.
3. Put the transmission in N (Neutral). If the vehicle has a manual transmission, press and hold the clutch pedal down while you perform Steps 5 through 9.
4. Shift the transfer case to Four-Wheel High.

#### WARNING

Shifting an all-wheel-drive vehicle's transfer case into Neutral can cause the vehicle to roll even if the automatic transmission is in P (Park) or the manual transmission is in any gear. You or others could be injured. Make sure the parking brake is firmly set before you shift the transfer case to Neutral.



5. Simultaneously press and hold the Four-Wheel High and Four-Wheel-Low Lock buttons for 10 seconds. The Neutral light will come on when the transfer case shift to Neutral is complete.
6. Press and hold the regular brake pedal and shift the transmission to R (Reverse), then shift the transmission to D (Drive) for an automatic transmission, or 1 (First) for vehicles have a manual transmission and then let out the clutch. This is to ensure the transfer case is in Neutral. If not, repeat this procedure starting at Step 3.
7. Turn the engine off.

8. Place the transmission shift lever in P (Park) for an automatic transmission, or 1 (First) for vehicles that have a manual transmission.
9. Turn the ignition to LOCK/OFF.

### Shifting Out of Neutral

To shift out of Neutral:

1. Set the parking brake and apply the regular brake pedal.
2. Shift the transmission to N (Neutral) for an automatic transmission, or press the clutch pedal for vehicles that have a manual transmission. Then turn the ignition to ON/RUN but do not start the engine.

3. Press the button for the desired transfer case shift position (Four-Wheel High, Four-Wheel-High Lock or Four-Wheel-Low Lock).

After the transfer case has shifted out of Neutral the light will go out.

4. Release the parking brake.

**Notice: Shifting the transmission into gear before the indicator light stops flashing could cause damage to the transfer case. Always wait until the indicator light stops flashing before putting the transmission back in gear.**

5. You may start the engine and shift the transmission to the desired position.

## Brakes

### Antilock Brake System (ABS)

This vehicle has the Antilock Brake System (ABS), an advanced electronic braking system that helps prevent a braking skid.

When the engine is started and the vehicle begins to drive away, ABS checks itself. A momentary motor or clicking noise might be heard while this test is going on, and it might even be noticed that the brake pedal moves a little. This is normal.



If there is a problem with ABS, this warning light stays on. See *Antilock Brake System (ABS) Warning Light* on page 5-15.

If driving safely on a wet road and it becomes necessary to slam on the brakes and continue braking to avoid a sudden obstacle, a computer senses that the wheels are slowing down. If one of the wheels is about to stop rolling, the computer will separately work the brakes at each wheel.

ABS can change the brake pressure to each wheel, as required, faster than any driver could. This can help the driver steer around the obstacle while braking hard.

As the brakes are applied, the computer keeps receiving updates on wheel speed and controls braking pressure accordingly.

Remember: ABS does not change the time needed to get a foot up to the brake pedal or always decrease stopping distance. If you get too close to the vehicle in front of you,

there will not be enough time to apply the brakes if that vehicle suddenly slows or stops. Always leave enough room up ahead to stop, even with ABS.

### Using ABS

Do not pump the brakes. Just hold the brake pedal down firmly and let ABS work. The ABS pump or motor might be heard operating, and the brake pedal might be felt to pulsate, but this is normal.

### Braking in Emergencies

ABS allows the driver to steer and brake at the same time. In many emergencies, steering can help more than even the very best braking.

## Parking Brake



The parking brake pedal is located to the left of the regular brake pedal, near the driver door.

To set the parking brake, hold the regular brake pedal down, then push the parking brake pedal down to its fully-applied position.

A chime will sound and the brake warning light will flash when the parking brake is applied and the vehicle is moving at least 5 km/h (3 mph) for at least three seconds. See *Brake System Warning Light* on page 5-14.



To release the parking brake, hold the regular brake pedal down. Pull the park brake release lever, located above the parking brake pedal.

**Notice:** Driving with the parking brake on can overheat the brake system and cause premature wear or damage to brake system parts. Make sure that the parking brake is fully released and the brake warning light is off before driving.

If you are towing a trailer and are parking on a hill, see *Trailer Towing* on page 9-74.

## Brake Assist

This vehicle has a brake assist feature designed to assist the driver in stopping or decreasing vehicle speed in emergency driving conditions. This feature uses the stability system hydraulic brake control module to supplement the power brake system under conditions where the driver has quickly and forcefully applied the brake pedal in an attempt to quickly stop or slow down the vehicle.

The stability system hydraulic brake control module increases brake pressure at each corner of the vehicle until the ABS activates. Minor brake pedal pulsations or pedal movement during this time is normal and the driver should continue to apply the brake pedal as the driving situation dictates. The brake assist feature will automatically disengage when the brake pedal is released or brake pedal pressure is quickly decreased.

### **Hill Start Assist (HSA)**

This vehicle has a Hill Start Assist (HSA) feature, which may be useful when the vehicle is stopped on a grade. This feature is designed to prevent the vehicle from rolling, either forward or rearward, during vehicle drive off. After the vehicle is stopped on an incline, quickly push the brake pedal to the floor to activate Hill Start Assist.

When the system activates, a chime will sound and the HSA ON message will be displayed. The brakes will automatically be held for a maximum of two seconds while the driver switches from applying the brakes to pushing the accelerator pedal. When Hill Start Assist is active, the driver might experience a “hard brake pedal.” This is normal and does not affect safe brake operation. After activation, the system will automatically disengage when the accelerator pedal is pressed. Do not turn off the ignition while this feature is active. The Hill Start Assist feature may not disengage fully if the ignition is turned off.

The system will not activate with the transmission in P (Park), when traveling down a steep grade in a drive gear, or if the vehicle is facing uphill with the transmission in R (Reverse).

## **Ride Control Systems**

### **Traction Control System (TCS)**

The vehicle has a Traction Control System (TCS) that limits wheel spin. This is especially useful in slippery road conditions. The system operates only if it senses that any of the wheels are spinning or beginning to lose traction. When this happens, TCS reduces engine power. The system may be heard or felt while it is working. This is normal and does not mean there is a problem with the vehicle.

TCS can operate on dry roads under some conditions. When this happens, the system may be heard working or a reduction in acceleration may be noticed. This is normal and does not mean there is a problem with the vehicle.

Examples of these conditions include hard acceleration in a turn, an abrupt upshift or downshift of the transmission or driving on rough roads.

If cruise control is being used when TCS begins to limit wheel spin, the cruise control automatically disengages. The cruise control can be re-engaged when road conditions allow. See *Cruise Control on page 9-57* for more information.

TRACTION FAILED appears on the Driver information Center (DIC) when a TCS or antilock brake system problem has been detected and the vehicle needs service. When this message is on, the system will not limit wheel spin. Adjust your driving accordingly. See *Driver Information Center (DIC) on page 5-18* for more information.

It is recommended to leave the system on for normal driving conditions, but it may be necessary to turn the system off if the vehicle is stuck in sand, mud, ice, or snow,

and it is necessary to “rock” the vehicle to attempt to free it. See *If the Vehicle is Stuck on page 9-26* for more information.



To turn the system off, press and release the TCS/StabiliTrak button.



When TCS has been turned off, this light comes on steady and TRAC OFF appears on the DIC. This light flashes when TCS is active.

Press and release the TCS/StabiliTrak button again to turn the system back on. The TRAC OFF message then goes off.

TCS automatically comes on whenever the vehicle is started and resets itself at each ignition cycle.

Adding non-dealer/non-retailer accessories can affect the vehicle's performance. See *Accessories and Modifications on page 10-3*.

## StabiliTrak System

The vehicle has a vehicle stability enhancement system called StabiliTrak. It is an advanced computer controlled system that assists the driver with directional control of the vehicle in difficult driving conditions.

StabiliTrak activates when the computer senses a difference between the intended path and the direction the vehicle is actually traveling. StabiliTrak selectively applies braking pressure at any one of the vehicle's brakes to assist the driver with keeping the vehicle on the intended path.

When the vehicle is started and begins to move, the system performs several diagnostic checks to insure there are no problems. The system may be heard or felt while it is working. This is normal and does not mean there is a problem with the vehicle.

If cruise control is being used when StabiliTrak activates, the cruise control automatically disengages. The cruise control can be re-engaged when road conditions allow. See *Cruise Control on page 9-57*.

If there is a problem detected with StabiliTrak, a SERVICE STAB SYS message displays on the Driver Information Center (DIC). See *Driver Information Center (DIC) on page 5-18* for more information. When this message is displayed, the system is not working. Adjust your driving accordingly.

StabiliTrak comes on automatically whenever the vehicle is started and resets itself at each ignition cycle. However, when the transfer case is placed in Four-Wheel-Low Lock mode, StabiliTrak is automatically disabled. See *Four-Wheel Drive on page 9-46* for more information. It is recommended to leave the system on for normal driving conditions, but it may be necessary to turn the system off if the vehicle is stuck in sand, mud, ice, or snow, and it is necessary to “rock” the vehicle to attempt to free it. See *If the Vehicle is Stuck on page 9-26*.



This light comes on steady when TCS has been turned off. This light flashes when StabiliTrak is active.

To Turn off TCS and StabiliTrak, press and hold the TCS/StabiliTrak button until STAB SYS OFF displays on the DIC. Press and release the TCS/StabiliTrak button again to turn StabiliTrak back on.

### Locking Rear Axle

For vehicles with this feature, additional traction can be obtained from the rear wheels when traveling in off-road situations such as mud, snow, sand, steep hills and uneven terrain.



The button used to turn this feature on or off is located on the instrument panel.

To lock the rear axle, do the following:

1. Place the transfer case in the 4LO Lock mode. This is the only mode which will allow the rear axle to lock. See *Four-Wheel Drive on page 9-46* for more information regarding the transfer case and 4LO Lock mode.
2. Press the rear axle locking button with the vehicle moving less than 26 km/h (16 mph).

The light in the button stops flashing and remains illuminated when the rear axle is locked.

**Notice:** If you try to lock the axle while the vehicle is stuck and the tires are spinning, the vehicle's drivetrain could be damaged.

**The repairs would not be covered by the vehicle warranty. Always lock the axle before attempting situations and/or navigating terrain which could possibly cause the vehicle to become stuck.**

The locking rear axle will be disengaged when the wheel speed is greater than 64 km/h (40 mph), if the vehicle's battery is low and/or the transfer case is shifted out of 4LO Lock mode.

**Notice:** If the vehicle's axle is locked while driving on pavement, the drivetrain could be damaged. Repairs would not be covered by the vehicle warranty. Do not use the locking axle on pavement. If four-wheel drive is needed when traveling on pavement, use only 4HI.

## Locking Front Axle

For vehicles with this feature, the locking front axle, used with the locking rear axle, can give the vehicle additional traction when traveling in off-road situations such as mud, snow, sand, steep hills and uneven terrain.



The button used to turn the locking front axle on or off is located on the instrument panel.

Before the front axle can be locked, the rear axle must be locked.

To lock the front and rear axles:

1. Place the transfer case in the 4LO Lock mode. This is the only mode which allows the front and rear axles to lock. See *Four-Wheel Drive on page 9-46* for more information regarding the transfer case and 4LO Lock mode.
2. Press the rear axle locking button with the vehicle moving less than 16 mph (26 km/h).
3. Wait for the light in the button to stop flashing and remain illuminated to show that the rear axle is locked.
4. Press the front axle locking button with the vehicle stopped or moving less than 26 km/h (16 mph).

5. Wait for the light in the button to stop flashing and remain illuminated to show that the front axle is locked.

**Notice:** If you try to lock the axle while the vehicle is stuck and the tires are spinning, the vehicle's drivetrain could be damaged. The repairs would not be covered by the vehicle warranty. Always lock the axle before attempting situations and/or navigating terrain which could possibly cause the vehicle to become stuck.

Locking axles will be disengaged when the wheel speed is greater than 64 km/h (40 mph), if the vehicle's battery is low and/or the transfer case is shifted out of 4LO Lock mode.

**Notice:** If the vehicle's axle is locked while driving on pavement, the drivetrain could be damaged. Repairs would not be covered by the vehicle warranty. Do not use the locking axle on pavement. If four-wheel drive is needed when traveling on pavement, use only 4HI.



## Cruise Control

With cruise control, a speed of about 40 km/h (25 mph) or more can be maintained without keeping your foot on the accelerator. Cruise control does not work at speeds below about 40 km/h (25 mph).



**○ (Off):** Turns the cruise control system off.

**| (On):** Turns the cruise control the system on.

**+ (Resume/Accelerate):** Makes the vehicle accelerate or resume to a previously set speed.

**▶ (Set):** Press this button to set the speed.

Cruise control will not work if the parking brake is set, or if the master cylinder brake fluid level is low.

If the brakes are applied, the cruise control shuts off.

### WARNING

Cruise control can be dangerous where you cannot drive safely at a steady speed. So, do not use the cruise control on winding roads or in heavy traffic.

(Continued)

### WARNING (Continued)

Cruise control can be dangerous on slippery roads. On such roads, fast changes in tire traction can cause excessive wheel slip, and you could lose control. Do not use cruise control on slippery roads.

The cruise control disengages, if the vehicle has the Traction Control System (TCS) and it begins to limit wheel spin. See *Traction Control System (TCS)* on page 9-52. When road conditions allow the cruise control to be safely used again, it can be turned back on.

### Setting Cruise Control

#### **WARNING**

If you leave your cruise control on when you are not using cruise, you might hit a button and go into cruise when you do not want to. You could be startled and even lose control. Keep the cruise control switch off until you want to use cruise control.

1. Move the cruise control switch to on.
2. Get up to the speed desired.

3. Press  at the end of the lever and release it.
4. Take your foot off the accelerator pedal.



The cruise symbol on the instrument panel comes on when the cruise control is engaged.

### Resuming a Set Speed

Suppose the cruise control is set at a desired speed and then you apply the brake or step on the clutch. This disengages the cruise control. But it does not need to be reset.

Once the vehicle is going about 40 km/h (25 mph) or more, move the cruise control switch briefly from | to +.

The vehicle goes back to the chosen speed and stays there.



If the switch is held at resume/accelerate the vehicle keeps going faster until the switch is released or the brake is applied. Do not hold the switch at resume/accelerate, unless you want the vehicle to go faster.

### Increasing Speed While Using Cruise Control

There are two ways to go to a higher speed:

- Use the accelerator pedal to get to the higher speed. Press  at the end of the lever, then release the button and the accelerator pedal. The vehicle will now cruise at the higher speed. If the accelerator pedal is held longer than 60 seconds, cruise control will turn off.
- Move the cruise switch from | to +. Hold it there until the desired speed is reached, and then release the switch. To increase the vehicle speed in small amounts, move the switch briefly to resume/accelerate. Each time this is done, the vehicle goes about 1.6 km/h (1 mph) faster.

### Reducing Speed While Using Cruise Control

- Press and hold  until the desired lower speed is reached, then release it.
- To slow down in very small amounts, briefly press . Each time this is done, the vehicle goes about 1.6 km/h (1 mph) slower.

### Passing Another Vehicle While Using Cruise Control

Use the accelerator pedal to increase the vehicle speed. When you take your foot off the pedal, the vehicle slows down to the cruise control speed set earlier.

### Using Cruise Control on Hills

How well the cruise control works on hills depends upon the vehicle's speed, load, and the steepness of the hills. When going up steep hills, the accelerator pedal might have to be used to maintain the vehicle speed. When going downhill, you might have to brake or shift to a lower gear to keep the vehicle speed down. When the brake is applied the cruise control will turn off.

### Ending Cruise Control

To turn off the cruise control, do one of the following:

- Step lightly on the brake pedal.
- Move the cruise control switch to .
- Lightly tap or press the clutch, if the vehicle has a manual transmission.

### Erasing Speed Memory

The cruise control set speed memory is erased, when the cruise control or the ignition is turned off.

## Object Detection Systems

### Rear Vision Camera (RVC)

Vehicles with the rear vision camera system are designed to help the driver while the vehicle is backing up. The area behind the vehicle is displayed on the screen in the inside rear view mirror. Read this entire section before using the camera system.

When the key is in the ON/RUN position and the driver shifts the vehicle into R (Reverse), the video image appears from inside the rear view mirror. Once the vehicle is shifted out of R (Reverse), the image disappears.

The display may have a guideline overlay that can help the driver align the vehicle when backing into a parking spot.

### Turning the Rear Vision Camera System On or Off

To turn off the rear vision camera system, press and hold , located on the inside rearview mirror, until the left indicator light turns off. The rear camera vision display is now disabled.

To turn the rear vision camera system on again, press and hold  until the left indicator light illuminates. The rear vision camera system display is now enabled and the display will appear in the mirror normally.

**⚠ WARNING**

The Rear Vision Camera (RVC) system does not replace driver vision. RVC does not:

- Detect objects that are outside the camera's field of view, below the bumper, or underneath the vehicle.
- Detect children, pedestrians, bicyclists, or pets.

Do not back the vehicle by only looking at the RVC screen, or use the screen during longer, higher speed backing maneuvers or where there could be cross-traffic. Your judged distances using the screen will differ from actual distances.

(Continued)

**WARNING (Continued)**

So if you do not use proper care before backing up, you could hit a vehicle, child, pedestrian, bicyclist, or pet, resulting in vehicle damage, injury, or death. Even though the vehicle has the RVC system, always check carefully before backing up by checking behind and around the vehicle.

**Rear Vision Camera Location**



**View of H3 Camera Location**



**View of H3T Camera Location**

## 9-62 Driving and Operating

The image on the screen is provided by the camera located on the rear bumper.

The image from the camera that appears on the screen appears farther than the actual distance. The area displayed by the camera is limited. The camera does not display objects which are close to either corner of the bumper or under the bumper. On the H3, the spare tire and carrier extends rearward of the rear bumper. The area displayed on the screen may vary according to vehicle orientation or road conditions.

The following illustration shows the field of view that the camera provides.

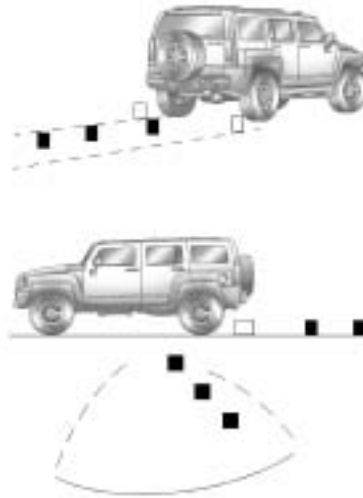

**H3 Field of View**

**Notice:** The spare tire extends farther away from rear of the vehicle than the trailer hitch shown on rear vision camera display. The spare tire could hit an object even though there appears to be enough distance on the display between the trailer hitch and objects behind you causing vehicle or property damage. Do not use this system to judge the distance between the spare tire and objects behind you.

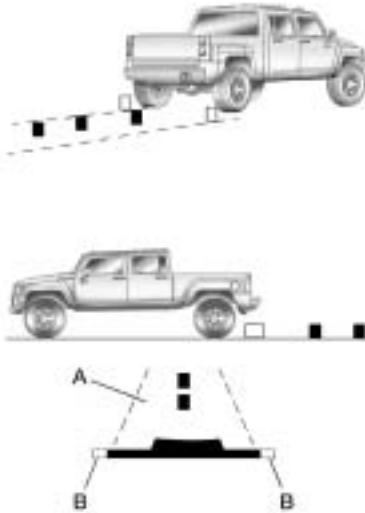

**H3T Field of View**

- A. View displayed by the camera.
- B. Corner of the rear bumper.

**When the System Does Not Seem To Work Properly**

The rear vision camera system may not work properly or display a clear image:

- In the dark.
- When the sun or the beam of headlamps is shining directly into the camera lens.
- If ice, snow, mud, or anything else builds up on the camera lens. Clean the lens, rinse it with water, and wipe it with a soft cloth.
- If the back of the vehicle is in an accident, the position and mounting angle of the camera may be affected. Be sure to have the camera and its position and mounting angle checked at your dealer.
- If there are extreme temperatures or extreme temperature changes.

The rear vision camera system display in the rearview mirror may turn off or not appear as expected due to a loss of video signal, or no video signal present during the reverse cycle. The display will be blank and the left indicator light will slowly flash as long as the vehicle is in R (Reverse) or until the condition returns to normal.

Pressing and holding  when the left indicator light is flashing will turn off the video display along with the left indicator light.

### Fuel

Use of the recommended fuel is an important part of the proper maintenance of this vehicle. To help keep the engine clean and maintain optimum vehicle performance, we recommend the use of gasoline advertised as TOP TIER Detergent Gasoline.

Look for the TOP TIER label on the fuel pump to ensure gasoline meets enhanced detergency standards developed by auto companies. A list of marketers providing TOP TIER Detergent Gasoline can be found at [www.toptiergas.com](http://www.toptiergas.com).



The 8th digit of the Vehicle Identification Number (VIN) shows the code letter or number that identifies the vehicle's engine.

The VIN is at the top left of the instrument panel. See *Vehicle Identification Number (VIN)* on page 12-1.

If the vehicle has the 5.3LV8 engine (VIN Code P), you can use either unleaded gasoline or ethanol fuel containing up to 85% ethanol (E85). See *Fuel E85 (85% Ethanol)* on page 9-66. In all other engines, use only regular unleaded gasoline.

### Recommended Fuel

Use regular unleaded gasoline with a posted octane rating of 87 or higher. If the octane rating is less than 87, an audible knocking noise, commonly referred to as spark knock, might be heard when driving. If this occurs, use a gasoline rated at 87 octane or higher as soon as possible. If heavy knocking is heard when using gasoline rated at 87 octane or higher, the engine needs service.



## Gasoline Specifications

At a minimum, gasoline should meet ASTM specification D 4814 in the United States or CAN/CGSB-3.5 or 3.511 in Canada. Some gasolines contain an octane-enhancing additive called methylcyclopentadienyl manganese tricarbonyl (MMT). We recommend against the use of gasolines containing MMT. See *Fuel Additives* on page 9-65 for additional information.

## California Fuel Requirements

If the vehicle is certified to meet California Emissions Standards, it is designed to operate on fuels that meet California specifications. See the underhood emission control label. If this fuel is not available in states adopting California emissions standards, the vehicle will operate satisfactorily on fuels meeting federal specifications, but emission control system performance might

be affected. The malfunction indicator lamp could turn on and the vehicle might fail a smog-check test. See *Malfunction Indicator Lamp* on page 5-12. If this occurs, return to your authorized dealer/retailer for diagnosis. If it is determined that the condition is caused by the type of fuel used, repairs might not be covered by the vehicle warranty.

## Fuels in Foreign Countries

If you plan on driving in another country outside the United States or Canada, the proper fuel might be hard to find. Never use leaded gasoline or any other fuel not recommended in the previous text on fuel. Costly repairs caused by use of improper fuel would not be covered by the vehicle warranty.

To check the fuel availability, ask an auto club, or contact a major oil company that does business in the country where you will be driving.

## Fuel Additives

To provide cleaner air, all gasolines in the United States are now required to contain additives that help prevent engine and fuel system deposits from forming, allowing the emission control system to work properly. In most cases, nothing should have to be added to the fuel. However, some gasolines contain only the minimum amount of additive required to meet U.S. Environmental Protection Agency regulations. To help keep fuel injectors and intake valves clean, or if the vehicle experiences problems due to dirty injectors or valves, look for gasoline that is advertised as TOP TIER Detergent Gasoline. Look for the TOP TIER label on the fuel pump to ensure gasoline meets enhanced detergency standards developed by the auto companies. A list of marketers providing TOP TIER Detergent Gasoline can be found at [www.toptiergas.com](http://www.toptiergas.com).

For customers who do not use TOP TIER Detergent Gasoline regularly, one bottle of GM Fuel System Treatment PLUS, added to the fuel tank at every engine oil change, can help clean deposits from fuel injectors and intake valves. GM Fuel System Treatment PLUS is the only gasoline additive recommended by HUMMER. It is available at your dealer/retailer.

Gasolines containing oxygenates, such as ethers and ethanol, and reformulated gasolines might be available in your area. We recommend that you use these gasolines, if they comply with the specifications described earlier. However, E85 (85% ethanol) and other fuels containing more than 10% ethanol must not be used in vehicles that were not designed for those fuels.

**Notice:** This vehicle was not designed for fuel that contains methanol. Do not use fuel containing methanol. It can corrode metal parts in the fuel system and also damage plastic and rubber parts. That damage would not be covered under the vehicle warranty.

Some gasolines that are not reformulated for low emissions can contain an octane-enhancing additive called methylcyclopentadienyl manganese tricarbonyl (MMT); ask the attendant where you buy gasoline whether the fuel contains MMT. We recommend against the use of such gasolines. Fuels containing MMT can reduce the life of spark plugs and the performance of the emission control system could be affected. The malfunction indicator lamp might turn on. If this occurs, return to your dealer/retailer for service.

### Fuel E85 (85% Ethanol)

The 8th digit of the Vehicle Identification Number (VIN) shows the code letter or number that identifies the vehicle's engine. The VIN is at the top left of the instrument panel. See *Vehicle Identification Number (VIN)* on page 12-1.

If the vehicle has the 5.3L V8 engine (VIN Code P), you can use either unleaded gasoline or ethanol fuel containing up to 85% ethanol (E85). In all other engines, use only the unleaded gasoline described under *Recommended Fuel* on page 9-64.

Only vehicles that have the 5.3L V8 engine (VIN Code P) can use 85% ethanol fuel (E85). We encourage the use of E85 in vehicles that are designed to use it. The ethanol in E85 is a "renewable" fuel, meaning it is made from renewable sources such as corn and other crops.

Many service stations will not have an 85% ethanol fuel (E85) pump available. The U.S. Department of Energy has an alternative fuels website ([www.eere.energy.gov/afdc/infrastructure/locator.html](http://www.eere.energy.gov/afdc/infrastructure/locator.html)) that can help you find E85 fuel. Those stations that do have E85 should have a label indicating ethanol content. Do not use the fuel if the ethanol content is greater than 85%.

At a minimum, E85 should meet ASTM Specification D 5798. By definition, this means that fuel labeled E85 will have an ethanol content between 70% and 85%. Filling the fuel tank with fuel mixtures that do not meet ASTM specifications can affect driveability and could cause the malfunction indicator lamp to come on.

To ensure quick starts in the wintertime, the E85 fuel must be formulated properly for your climate according to ASTM specification D 5798. If you have trouble starting on E85, it could be because the E85 fuel is not properly formulated for your climate. If this happens, switching to gasoline or adding gasoline to the fuel tank can improve starting. For good starting and heater efficiency below 0°C (32°F), the fuel mix in the fuel tank should contain no more than 70% ethanol. It is best not to alternate repeatedly between gasoline and E85. If you do switch fuels, it is recommended that you add as much fuel as possible — do not add less than 11 L (three gallons) when refueling. You should drive the vehicle immediately after refueling for at least 11 km (seven miles) to allow the vehicle to adapt to the change in ethanol concentration.

E85 has less energy per gallon than gasoline, so you will need to refill the fuel tank more often when using E85 than when you are using gasoline. See *Filling the Tank on page 9-68*.

**Notice:** Some additives are not compatible with E85 fuel and can harm the vehicle's fuel system. Do not add anything to E85. Damage caused by additives would not be covered by the vehicle warranty.

**Notice:** This vehicle was not designed for fuel that contains methanol. Do not use fuel containing methanol. It can corrode metal parts in the fuel system and also damage plastic and rubber parts. That damage would not be covered under the vehicle warranty.

## Filling the Tank

### WARNING

Fuel vapor burns violently and a fuel fire can cause bad injuries. To help avoid injuries to you and others, read and follow all the instructions on the fuel pump island. Turn off the engine when refueling. Do not smoke near fuel or when refueling the vehicle. Do not use cellular phones. Keep sparks, flames, and smoking materials away from fuel. Do not leave the fuel pump unattended when refueling the vehicle. This is against the law in some places. Do not re-enter the vehicle while pumping fuel. Keep children away from the fuel pump; never let children pump fuel.



The fuel cap is located on the driver side of the vehicle.

To remove the fuel cap, turn it slowly counterclockwise. While refueling, let the fuel cap hang by the tether, if it has one.

When reinstalling the cap, turn it clockwise until three clicks, otherwise the Malfunction Indicator Lamp could turn on. See *Malfunction Indicator Lamp* on page 5-12.

### WARNING

Fuel can spray out on you if you open the fuel cap too quickly. If you spill fuel and then something ignites it, you could be badly burned. This spray can happen if the tank is nearly full, and is more likely in hot weather. Open the fuel cap slowly and wait for any hiss noise to stop. Then unscrew the cap all the way.

Be careful not to spill fuel. Do not top off or overfill the tank and wait a few seconds after you have finished pumping before removing the nozzle. Clean fuel from painted surfaces as soon as possible. See *Exterior Care* on page 10-92.

When replacing the fuel cap, turn it clockwise until three clicks. Make sure the cap is fully installed. The diagnostic system can determine if the fuel cap has been left off or improperly installed.

This would allow fuel to evaporate into the atmosphere. See *Malfunction Indicator Lamp* on page 5-12.

The FUEL CAP message displays on the Driver Information Center (DIC) if the fuel cap is not properly installed. See *Fuel System Messages* on page 5-24 for more information.

 **WARNING**

If a fire starts while you are refueling, do not remove the nozzle. Shut off the flow of fuel by shutting off the pump or by notifying the station attendant. Leave the area immediately.

**Notice:** If a new fuel cap is needed, be sure to get the right type of cap from your dealer. The wrong type fuel cap might not fit properly, might cause the malfunction indicator lamp to

**light, and could damage the fuel tank and emissions system. See *Malfunction Indicator Lamp* on page 5-12.**

## Filling a Portable Fuel Container

 **WARNING**

Never fill a portable fuel container while it is in the vehicle. Static electricity discharge from the container can ignite the fuel vapor. You can be badly burned and the vehicle damaged if this occurs. To help avoid injury to you and others:

- Dispense fuel only into approved containers.
- Do not fill a container while it is inside a vehicle, in a vehicle's trunk, pickup bed, or on any surface other than the ground.

(Continued)

**WARNING (Continued)**

- Bring the fill nozzle in contact with the inside of the fill opening before operating the nozzle. Contact should be maintained until the filling is complete.
- Do not smoke while pumping fuel.
- Do not use a cellular phone while pumping fuel.

## Towing

### General Towing Information

Only use towing equipment that has been designed for the vehicle.

Contact your dealer or trailering retailer for assistance with preparing the vehicle for towing a trailer.

See the following trailer towing information in this section:

- For information on driving while towing a trailer, see “Driving Characteristics and Towing Tips”.
- For maximum vehicle and trailer weights, see “Trailer Towing”.
- For information on equipment to tow a trailer, see “Towing Equipment”.

For information on towing a disabled vehicle, see *Towing the Vehicle on page 10-90*. For information on towing the vehicle behind another vehicle — such as a motorhome, see *Recreational Vehicle Towing on page 10-90*.

### Driving Characteristics and Towing Tips

#### WARNING

The driver can lose control when pulling a trailer if the correct equipment is not used or the vehicle is not driven properly.

For example, if the trailer is too heavy, the brakes may not work well — or even at all. The driver and passengers could be seriously injured. The vehicle may also be damaged; the resulting repairs would not be covered by the vehicle warranty.

(Continued)

#### WARNING (Continued)

Pull a trailer only if all the steps in this section have been followed. Ask your dealer for advice and information about towing a trailer with the vehicle.

**Notice:** Pulling a trailer improperly can damage the vehicle and result in costly repairs not covered by the vehicle warranty. To pull a trailer correctly, follow the advice in this section and see your dealer for important information about towing a trailer with the vehicle.

The vehicle can tow a trailer when it is equipped with the proper trailer towing equipment. For trailering capacity, see *Trailer Towing on page 9-74*. Trailering changes handling, acceleration, braking, durability and fuel economy.

With the added weight, the engine, transmission, wheel assemblies and tires are forced to work harder and under greater loads. The trailer also adds wind resistance, increasing the pulling requirements. For safe trailering, correctly use the proper trailering equipment.

The following information has important trailering tips and rules for your safety and that of your passengers. Read this section carefully before pulling a trailer.

### **Pulling A Trailer**

Here are some important points:

- There are many laws, including speed limit restrictions that apply to trailering. Check for legal requirements with state or provincial police.
- Consider using a sway control. See "Hitches" later in this section.

- Do not tow a trailer at all during the first 800 km (500 miles) the new vehicle is driven. The engine, axle or other parts could be damaged.
- Then, during the first 800 km (500 miles) that a trailer is towed, do not drive over 80 km/h (50 mph) and do not make starts at full throttle. This helps the engine and other parts of the vehicle wear in at the heavier loads.
- Vehicles with an automatic transmission can tow in D (Drive). Use a lower gear if the transmission shifts too often. For vehicles with a manual transmission, it is better not to use the highest gear.
- This vehicle has a Hill Start Assist feature, which may be useful when the vehicle is stopped on a grade. See *Hill Start Assist (HSA) on page 9-52* for more information.

- Do not drive faster than the maximum posted speed for trailers.

### **Driving with a Trailer**

Towing a trailer requires experience. Get familiar with handling and braking with the added trailer weight. The vehicle is now longer and not as responsive as the vehicle is by itself.

Check all trailer hitch parts and attachments, safety chains, electrical connectors, lamps, tires and mirror adjustments. If the trailer has electric brakes, start the vehicle and trailer moving and then apply the trailer brake controller by hand to be sure the brakes are working.

During the trip, check occasionally to be sure that the load is secure, and the lamps and trailer brakes are working properly.

### Towing with a Stability Control System

When towing, the sound of the stability control system might be heard. The system is reacting to the vehicle movement caused by the trailer, which mainly occurs during cornering. This is normal when towing heavier trailers.

### Following Distance

Stay at least twice as far behind the vehicle ahead as you would when driving the vehicle without a trailer. This can help to avoid situations that require heavy braking and sudden turns.

### Passing

More passing distance is needed when towing a trailer. Because the rig is longer, it is necessary to go much farther beyond the passed vehicle before returning to the lane.

### Backing Up

Hold the bottom of the steering wheel with one hand. Then, to move the trailer to the left, move that hand to the left. To move the trailer to the right, move your hand to the right. Always back up slowly and, if possible, have someone guide you.

### Making Turns

**Notice: Making very sharp turns while trailering could cause the trailer to come in contact with the vehicle. The vehicle could be damaged. Avoid making very sharp turns while trailering.**

When turning with a trailer, make wider turns than normal. Do this so the trailer won't strike soft shoulders, curbs, road signs, trees or other objects. Avoid jerky or sudden maneuvers. Signal well in advance.

### Turn Signals When Towing a Trailer

The arrows on the instrument panel flash whenever signaling a turn or lane change. Properly hooked up, the trailer lamps also flash, telling other drivers the vehicle is turning, changing lanes or stopping.

When towing a trailer, the arrows on the instrument panel flash for turns even if the bulbs on the trailer are burned out. For this reason you may think other drivers are seeing the signal when they are not. It is important to check occasionally to be sure the trailer bulbs are still working.

### Driving On Grades

Reduce speed and shift to a lower gear before starting down a long or steep downgrade. If the transmission is not shifted down, the brakes might have to be used so much that they would get hot and no longer work well.



Vehicles with an automatic transmission can tow in D (Drive). Shift the transmission to a lower gear if the transmission shifts too often under heavy loads and/or hilly conditions. For vehicles with a manual transmission, it is better not to use the highest gear.

When towing at high altitude on steep uphill grades, consider the following: Engine coolant will boil at a lower temperature than at normal altitudes. If the engine is turned off immediately after towing at high altitude on steep uphill grades, the vehicle may show signs similar to engine overheating. To avoid this, let the engine run while parked, preferably on level ground, with the automatic transmission in P (Park) for a few minutes before turning the engine off. For vehicles with manual

transmissions, let the engine run while parked, preferably on level ground, with the transmission out of gear and the parking brake applied, for a few minutes before turning the engine off. If the overheat warning comes on, see *Engine Overheating on page 10-22*.

### Parking on Hills

 **WARNING**

Parking the vehicle on a hill with the trailer attached can be dangerous. If something goes wrong, the rig could start to move. People can be injured, and both the vehicle and the trailer can be damaged. When possible, always park the rig on a flat surface.

If parking the rig on a hill:

1. Press the brake pedal, but do not shift into P (Park) yet for vehicles with an automatic transmission, or into gear for vehicles with a manual transmission. Turn the wheels into the curb if facing downhill or into traffic if facing uphill.
2. Have someone place chocks under the trailer wheels.
3. When the wheel chocks are in place, release the brake pedal until the chocks absorb the load.
4. Reapply the brake pedal. Then apply the parking brake and shift into P (Park) for vehicles with an automatic transmission or into gear for vehicles with a manual transmission.
5. Release the brake pedal.

### Leaving After Parking on a Hill

1. Apply and hold the brake pedal while you:
  - start the engine,
  - shift into a gear, and
  - release the parking brake.
2. Let up on the brake pedal.
3. Drive slowly until the trailer is clear of the chocks.
4. Stop and have someone pick up and store the chocks.

### Maintenance When Trailer Towing

The vehicle needs service more often when pulling a trailer. See this manual's Maintenance Schedule or Index for more information. Things that are especially important in trailer operation are automatic transmission fluid, engine oil, axle

lubricant, belts, cooling system and brake system. It is a good idea to inspect these before and during the trip.

Check periodically to see that all hitch nuts and bolts are tight.

### Engine Cooling When Trailer Towing

The cooling system may temporarily overheat during severe operating conditions. See *Engine Overheating on page 10-22*.

### Trailer Towing

Three important considerations have to do with weight:

- The weight of the trailer.
- The weight of the trailer tongue.
- The total weight on the vehicle's tires.

### Weight of the Trailer

How heavy can a trailer safely be?

Speed, altitude, road grades, outside temperature, special equipment, and the amount of tongue weight the vehicle can carry must be considered. See "Weight of the Trailer Tongue" later in this section for more information.

Maximum trailer weight is calculated assuming only the driver is in the tow vehicle and it has all the required trailering equipment. The weight of additional optional equipment, passengers and cargo in the tow vehicle must be subtracted from the maximum trailer weight.

Use the following chart to determine how much a vehicle can weigh, based on the vehicle model and options.

Vehicle	Axle Ratio	Maximum Trailer Weight	*GCWR
<b>H3</b>			
3.7L L5 Engine, Automatic Transmission	4.56	4,500 lbs (2 041 kg)	9,500 lbs (4 309 kg)
3.7L L5 Engine, Manual Transmission	4.56	3,000 lbs (1 361 kg)	8,000 lbs (3 629 kg)
5.3L V8 Engine, Automatic Transmission	4.10	6,000 lbs (2 721 kg)	11,400 lbs (5 171 kg)
<b>H3T</b>			
3.7L L5 Engine, Automatic Transmission	4.56	4,400 lbs (1 996 kg)	9,500 lbs (4 309 kg)
3.7L L5 Engine, Manual Transmission	4.56	2,900 lbs (1 315 kg)	8,000 lbs (3 629 kg)
5.3L V8 Engine, Automatic Transmission	4.10	5,900 lbs (2 676 kg)	11,400 lbs (5 171 kg)
*The Gross Combination Weight Rating (GCWR) is the total allowable weight of the completely loaded vehicle and trailer including any passengers, cargo, equipment and conversions. The GCWR for the vehicle should not be exceeded.			

## 9-76 Driving and Operating

Ask your dealer for our trailering information or advice, or write us at our Customer Assistance Offices. See *Customer Assistance Offices* on page 13-3 for more information.

### Weight of the Trailer Tongue

The tongue load (A) of any trailer is an important weight to measure because it affects the total gross weight of the vehicle. The Gross Vehicle Weight (GVW) includes the curb weight of the vehicle, any cargo carried in it, and the people who will be riding in the vehicle. If there are a lot of options, equipment, passengers or cargo in the vehicle, it will reduce the tongue weight the vehicle can carry, which will also reduce the trailer weight the vehicle can tow. If towing a trailer, the tongue load must be added to the GVW because the vehicle will be carrying that weight, too. See *Vehicle Load Limits* on page 9-27 for more information about the vehicle's maximum load capacity.

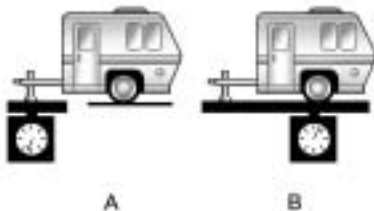

If a weight-carrying hitch or a weight-distributing hitch is being used, the trailer tongue (A) should weigh 10-15 percent of the total loaded trailer weight (B) up to a maximum of 227 kg (500 lbs).

After loading the trailer, weigh the trailer and then the tongue, separately, to see if the weights are proper. If they are not, adjustments might be made by moving some items around in the trailer.

Trailering may be limited by the vehicle's ability to carry tongue weight. Tongue weight cannot cause the vehicle to exceed the GVWR (Gross Vehicle Weight Rating) or the RGAWR (Rear Gross Axle Weight Rating). The effect of additional weight may reduce the trailering capacity more than the total of the additional weight. Choose the shortest hitch extension that will position the hitch ball closest to the vehicle. This will help reduce the effect of trailer tongue weight on the rear axle.

If the spare tire carrier is mounted on the back of the vehicle and the hitch extension is too short, the spare tire may interfere with trailer coupling or trailer tongue jack operation on some types of trailers.

Consider the following example:

A vehicle model base weight is 2 495 kg (5,500 lbs); 1 270 kg (2,800 lbs) at the front axle and 1 225 kg (2,700 lbs) at the rear axle. It has a GVWR of 3 266 kg (7,200 lbs), a RGAWR of 1 814 kg (4,000 lbs) and a GCWR (Gross Combination Weight Rating) of 6 350 kg (14,000 lbs). The trailer rating should be:

6350 kg (14,000 lbs)	GCWR
<u>2495 kg (-5,500 lbs)</u>	Vehicle Weight
3855 kg (8,500 lbs)	Trailer Rating

Expect tongue weight to be at least 10 percent of trailer weight (386 kg (850 lbs)) and because the weight is applied well behind the rear axle, the effect on the rear axle is greater than just the weight itself, as much as 1.5 times as much. The weight at the rear axle could be 386 kg (850 lbs) X 1.5 = 578 kg (1,275 lbs).

Since the rear axle already weighs 1 225 kg (2,700 lbs), adding 578 kg (1,275 lbs) brings the total to 1 803 kg (3,975 lbs). This is very close to, but within the limit for RGAWR as well. The vehicle is set to trailer up to 3 856 kg (8,500 lbs).

If the vehicle has many options and there is a front seat passenger and two rear seat passengers with some luggage and gear in the vehicle as well. 136 kg (300 lbs) could be added to the front axle weight and 181 kg (400 lbs) to the rear axle weight. The vehicle now weighs:

1270 kg (2,800 lbs)	+	136 kg (300 lbs)	Front
<u>1225 kg (2,700 lbs)</u>	+	<u>181 kg (400 lbs)</u>	Rear
2812 kg (6,200 lbs)			Total

Weight is still below 3 266 kg (7,200 lbs) and you might think 318 additional kilograms (700 lbs) should be subtracted from the trailering capacity to stay within GCWR limits. The maximum trailer

would only be 3 538 kg (7,800 lbs). You may go further and think the tongue weight should be limited to less than 454 kg (1,000 lbs) to avoid exceeding GVWR. But the effect on the rear axle must still be considered. Because the rear axle now weighs 1 406 kg (3,100 lbs), 408 kg (900 lbs) can be put on the rear axle without exceeding RGAWR. The effect of tongue weight is about 1.5 times the actual weight. Dividing the 408 kg (900 lbs) by 1.5 leaves only 272 kg (600 lbs) of tongue weight that can be handled. Since tongue weight is usually at least 10 percent of total loaded trailer weight, expect that the largest trailer the vehicle can properly handle is 2 722 kg (6,000 lbs).

It is important that the vehicle does not exceed any of its ratings — GCWR, GVWR, RGAWR, Maximum Trailer Rating or Tongue Weight. The only way to be sure it is not exceeding any of these ratings is to weigh the vehicle and trailer.

### Total Weight on the Vehicle's Tires

Inflate the vehicle's tires to the upper limit for cold tires. These numbers can be found on the Certification label or see *Vehicle Load Limits* on page 9-27. Do not go over the GVW limit for the vehicle, or the GAWR, including the weight of the trailer tongue.

### Towing Equipment

#### Hitches

It is important to have the correct hitch equipment. Crosswinds, large trucks going by and rough roads are a few reasons why the right hitch is needed.

The rear bumper on the vehicle is not intended for hitches. Do not attach rental hitches or other bumper-type hitches to it. Use only a frame-mounted hitch that does not attach to the bumper.

Will any holes be made in the body of the vehicle when the trailer hitch is installed? If there are, then be sure to seal the holes when the hitch is removed. If the holes are not sealed, dirt, water, and deadly carbon monoxide (CO) from the exhaust may get into the vehicle. See *Engine Exhaust* on page 9-40.

### Weight-Distributing Hitches and Weight Carrying Hitches

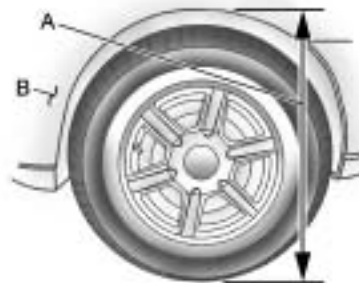

**(A) Body-to-Ground Distance (B) Front of Vehicle**

When using a weight-distributing hitch, the hitch must be adjusted so that the distance (A) remains the same both before and after coupling the trailer to the tow vehicle.

## Safety Chains

Always attach chains between the vehicle and the trailer. Cross the safety chains under the tongue of the trailer to help prevent the tongue from contacting the road if it becomes separated from the hitch. Always leave just enough slack so the rig can turn. Never allow safety chains to drag on the ground.

## Trailer Brakes

A loaded trailer that weighs more than 680 kg (1,500 lbs) needs to have its own brake system that is adequate for the weight of the trailer. Be sure to read and follow the instructions for the trailer brakes so they are installed, adjusted and maintained properly.

## Trailer Wiring Harness

### Light-Duty Trailer Wiring Package

If the vehicle does not have a trailer towing package, the chassis harness will contain the following blunt cut circuits:

- Yellow: Left Stop/Turn Signal
- Dark Green: Right Stop/Turn Signal
- White: Ground
- Brown: Tail Lamps

To add a trailer towing wiring package, have it installed by your dealer or a qualified service center. Also, see *Add-On Electrical Equipment on page 9-81* for more information.

## Heavy-Duty Trailer Wiring Package



If the vehicle has a trailer towing package, the rear bumper harness will have a seven-pin universal heavy-duty trailer connector attached to a bracket on the hitch platform.

## 9-80 Driving and Operating

The trailer towing harness contains the following seven trailer circuits:

- Yellow: Left Stop/Turn Signal
- Dark Green: Right Stop/Turn Signal
- Brown: Taillamps
- White: Ground
- Light Green: Back-up Lamps
- Red: Battery Feed
- Dark Blue: Trailer Brake

If charging a remote (non-vehicle) battery, turn on the headlamps to boost the vehicle system voltage to properly charge the battery.

### Four-Wire Harness Adapter

If towing a light-duty trailer with a standard four-way, flat pin connector, an adapter is available from your dealer.



Hold the adapter with the tab pointing up.



Connect the adapter to the seven-pin universal heavy-duty trailer connector attached to the bracket on the hitch platform. The flip cap on the vehicle's harness locks onto the tab and helps hold the adapter in place. Plug the four-way pin connector onto the adapter.



### Trailer Brake Control Wiring Harness

The trailer brake control wiring harness is located under the instrument panel to the right of the steering column. The wires are taped to the harness that goes to the courtesy light under the instrument panel. The harness has the following wires:

- Red Wire: AUX B+
- Black Wire: Ground
- Light Blue Wire: Brake Signal
- Dark Blue Wire: Trailer Brakes

### Trailer Recommendations

Subtract the hitch loads from the Cargo Weight Rating (CWR). CWR is the maximum weight of the load the vehicle can carry. It does not include the weight of the people inside, but you can figure about 68 kg (150 lbs) for each passenger. The total cargo load must not be more than the vehicles CWR.

Weigh the vehicle with the trailer attached, so the GVWR or GAWR are not exceeded. If using a weight-distributing hitch, weigh the vehicle without the spring bars in place.

The best performance is obtained by correctly spreading out the weight of the load and choosing the correct hitch and trailer brakes.

For more information see *Trailer Towing* on page 9-74.

### Conversions and Add-Ons

#### Add-On Electrical Equipment

**Notice: Do not add anything electrical to the vehicle unless you check with your dealer first. Some electrical equipment can damage the vehicle and the damage would not be covered by the vehicle's warranty. Some add-on electrical equipment can keep other components from working as they should.**

Add-on equipment can drain the vehicle battery, even if the vehicle is not operating.

The vehicle has an airbag system. Before attempting to add anything electrical to the vehicle, see *Servicing the Airbag-Equipped Vehicle* on page 3-40 and *Adding Equipment to the Airbag-Equipped Vehicle* on page 3-40.



## Vehicle Care

### General Information

General Information .....	10-2
California Proposition 65 Warning .....	10-2
California Perchlorate Materials Requirements ....	10-3
Accessories and Modifications .....	10-3

### Vehicle Checks

Doing Your Own Service Work .....	10-4
Hood .....	10-5
Engine Compartment Overview .....	10-6
Engine Oil .....	10-9
Engine Oil Life System ....	10-11
Automatic Transmission Fluid .....	10-12
Manual Transmission Fluid .....	10-15

Hydraulic Clutch .....	10-16
Engine Air Cleaner/Filter ....	10-17
Cooling System .....	10-18
Engine Coolant .....	10-19
Engine Overheating .....	10-22
Engine Fan .....	10-24
Power Steering Fluid .....	10-24
Washer Fluid .....	10-25
Brakes .....	10-26
Brake Fluid .....	10-27
Battery .....	10-28
Four-Wheel Drive .....	10-29
Front Axle .....	10-29
Rear Axle .....	10-29
Starter Switch Check .....	10-30
Automatic Transmission Shift Lock Control System Check .....	10-30
Ignition Transmission Lock Check .....	10-31
Park Brake and P (Park) Mechanism Check .....	10-31
Wiper Blade Replacement .....	10-32

### Headlamp Aiming

Headlamp Aiming .....	10-33
-----------------------	-------

### Bulb Replacement

Bulb Replacement .....	10-35
Halogen Bulbs .....	10-35
Headlamps .....	10-35
Taillamps, Turn Signal, Stoplamps, and Back-Up Lamps (H3) .....	10-35
Taillamps, Turn Signal, Stoplamps, and Back-Up Lamps (H3T) .....	10-36
License Plate Lamp .....	10-37
Replacement Bulbs .....	10-37

### Electrical System

Electrical System Overload .....	10-38
Fuses and Circuit Breakers .....	10-39
Engine Compartment Fuse Block .....	10-39

### Wheels and Tires

Tires .....	10-44
Tire Sidewall Labeling .....	10-44
Tire Designations .....	10-46
Tire Terminology and Definitions .....	10-48
Tire Pressure .....	10-51
Tire Pressure Monitor System .....	10-52
Tire Pressure Monitor Operation .....	10-53
Tire Inspection .....	10-57
Tire Rotation .....	10-57
When It Is Time for New Tires .....	10-58
Buying New Tires .....	10-59
Different Size Tires and Wheels .....	10-60
Uniform Tire Quality Grading .....	10-61

Wheel Alignment and Tire Balance .....	10-62
Wheel Replacement .....	10-63
Tire Chains .....	10-64
If a Tire Goes Flat .....	10-64
Tire Changing (H3T) .....	10-66
Tire Changing (H3) .....	10-75
Secondary Latch System ...	10-84
Full-Size Spare Tire .....	10-85

### Jump Starting

Jump Starting .....	10-86
---------------------	-------

### Towing

Towing the Vehicle .....	10-90
Recreational Vehicle Towing .....	10-90

### Appearance Care

Exterior Care .....	10-92
Interior Care .....	10-96

## General Information

For service and parts needs, visit your dealer/retailer. You will receive genuine parts and trained and supported service people.

## California Proposition 65 Warning

Most motor vehicles, including this one, contain and/or emit chemicals known to the State of California to cause cancer and birth defects or other reproductive harm. Engine exhaust, many parts and systems, many fluids, and some component wear by-products contain and/or emit these chemicals.

## California Perchlorate Materials Requirements

Certain types of automotive applications, such as airbag initiators, seat belt pretensioners, and lithium batteries contained in remote keyless transmitters, may contain perchlorate materials. Special handling may be necessary. For additional information, see [www.dtsc.ca.gov/hazardouswaste/perchlorate](http://www.dtsc.ca.gov/hazardouswaste/perchlorate).

## Accessories and Modifications

Adding non-dealer/non-retailer accessories to the vehicle can affect vehicle performance and safety, including such things as airbags, braking, stability, ride and handling, emissions systems, aerodynamics, durability, and electronic systems like antilock brakes, traction control, and stability control. Some of these accessories could even cause malfunction or damage not covered by the vehicle warranty.

Damage to vehicle components resulting from the installation or use of non-certified parts, including control module modifications, is

not covered under the terms of the vehicle warranty and may affect remaining warranty coverage for affected parts.

HUMMER Accessories are designed to complement and function with other systems on the vehicle. Your HUMMER dealer/retailer can accessorize the vehicle using genuine HUMMER Accessories. When you go to your HUMMER dealer/retailer and ask for HUMMER Accessories, you will know that HUMMER-trained and supported service technicians will perform the work using genuine HUMMER Accessories.

Also, see *Adding Equipment to the Airbag-Equipped Vehicle* on page 3-40.

## Vehicle Checks

### Doing Your Own Service Work

 **WARNING**

You can be injured and the vehicle could be damaged if you try to do service work on a vehicle without knowing enough about it.

- Be sure you have sufficient knowledge, experience, the proper replacement parts, and tools before attempting any vehicle maintenance task.

(Continued)

**WARNING (Continued)**

- Be sure to use the proper nuts, bolts, and other fasteners. English and metric fasteners can be easily confused. If the wrong fasteners are used, parts can later break or fall off. You could be hurt.

If doing some of your own service work, use the proper service manual. It tells you much more

about how to service the vehicle than this manual can. To order the proper service manual, see *Service Publications Ordering Information on page 13-12*.

This vehicle has an airbag system. Before attempting to do your own service work, see *Airbag System Check on page 3-41*.

Keep a record with all parts receipts and list the mileage and the date of any service work performed. See *Maintenance Records on page 11-11*.

## Hood

To open the hood:



1. Pull the handle with this symbol on it. It is located inside the vehicle on the lower left side of the instrument panel.

2. Release the secondary latch on the hood. It is located below the front center of the hood.
3. Lift the hood.

Before closing the hood, be sure all the filler caps are on properly. Then pull the hood down and close it firmly.

## Engine Compartment Overview

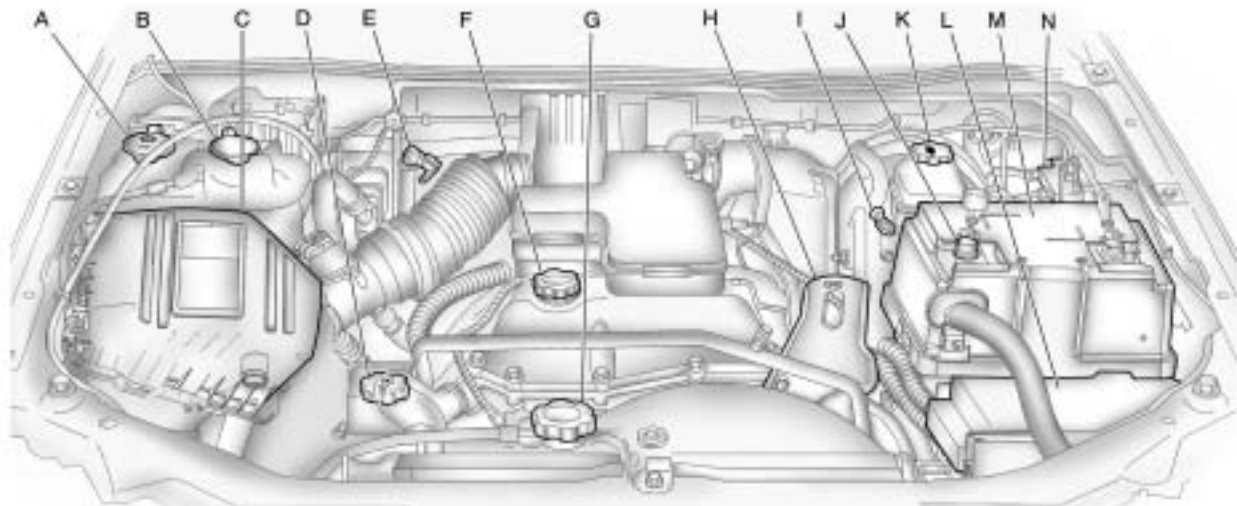

3.7 L L5 Engine



- A. Windshield Washer Fluid Reservoir. See "Adding Washer Fluid" under *Washer Fluid* on page 10-25.
- B. Engine Coolant Recovery Tank. See *Engine Coolant* on page 10-19.
- C. *Engine Air Cleaner/Filter* on page 10-17.
- D. Power Steering Fluid Reservoir. See *Power Steering Fluid* on page 10-24.
- E. Automatic Transmission Fluid Dipstick (If Equipped). See "Checking the Fluid Level" under *Automatic Transmission Fluid* on page 10-12.
- F. Engine Oil Fill Cap. See "When to Add Engine Oil" under *Engine Oil* on page 10-9.
- G. Radiator Pressure Cap. See *Cooling System* on page 10-18.
- H. Remote Negative (-) Terminal (GND). See *Jump Starting* on page 10-86.
- I. Engine Oil Dipstick. See "Checking Engine Oil" under *Engine Oil* on page 10-9.
- J. Positive (+) Battery Terminal. See *Jump Starting* on page 10-86.
- K. Brake Fluid Reservoir. See "Brake Fluid" under *Brakes* on page 10-26.
- L. *Engine Compartment Fuse Block* on page 10-39.
- M. *Battery* on page 10-28.
- N. Hydraulic Clutch Fluid Reservoir (If Equipped). See *Hydraulic Clutch* on page 10-16.

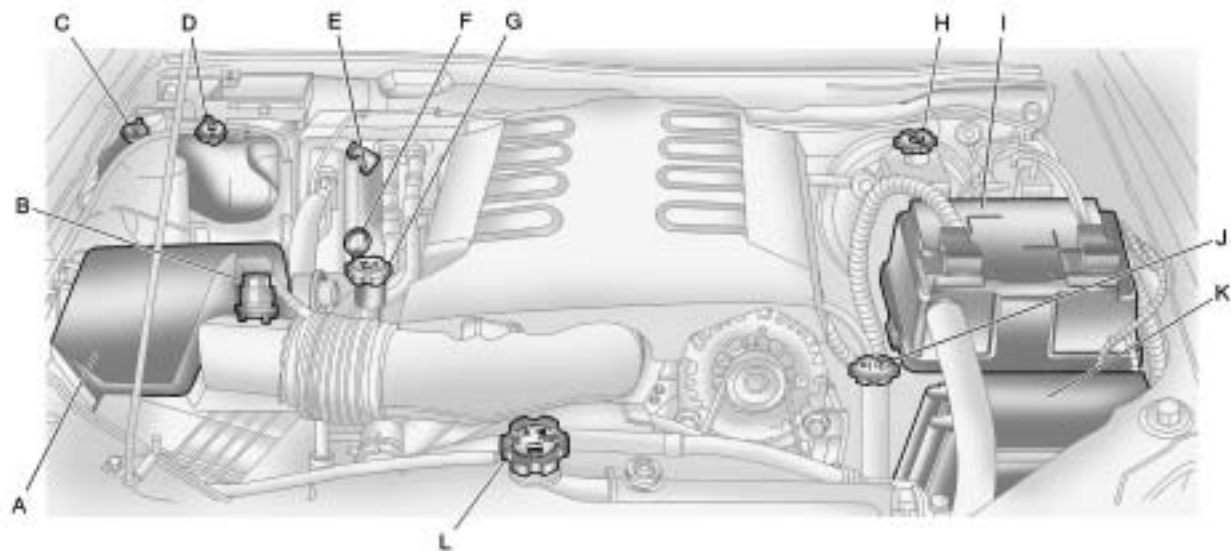

5.3 L V8 Engine

- A. *Engine Air Cleaner/Filter on page 10-17.*
- B. *Air Filter Restriction Indicator (If Equipped). See Engine Air Cleaner/Filter on page 10-17.*
- C. *Windshield Washer Fluid Reservoir. See "Adding Washer Fluid" under Washer Fluid on page 10-25.*
- D. *Engine Coolant Recovery Tank. See Engine Coolant on page 10-19.*
- E. *Automatic Transmission Fluid Dipstick (If Equipped). See "Checking the Fluid Level" under Automatic Transmission Fluid on page 10-12.*
- F. *Engine Oil Dipstick. See "Checking Engine Oil" under Engine Oil on page 10-9.*
- G. *Engine Oil Fill Cap. See "When to Add Engine Oil" under Engine Oil on page 10-9.*
- H. *Brake Fluid Reservoir. See "Brake Fluid" under Brakes on page 10-26.*
- I. *Battery on page 10-28.*
- J. *Power Steering Fluid Reservoir. See Power Steering Fluid on page 10-24.*
- K. *Engine Compartment Fuse Block on page 10-39.*
- L. *Radiator Pressure Cap. See Cooling System on page 10-18.*

## Engine Oil

### Checking Engine Oil

It is a good idea to check the engine oil level at each fuel fill. In order to get an accurate reading, the oil must be warm and the vehicle must be on level ground.

The engine oil dipstick handle is a yellow loop. See *Engine Compartment Overview on page 10-6* for the location of the engine oil dipstick.

1. Turn off the engine and give the oil several minutes to drain back into the oil pan. If this is not done, the oil dipstick might not show the actual level.
2. Pull out the dipstick and clean it with a paper towel or cloth, then push it back in all the way. Remove it again, keeping the tip down, and check the level.

### When to Add Engine Oil



If the oil is below the cross-hatched area (L), add at least one liter/quart of the recommended oil. This section explains what kind of oil to use. For engine oil crankcase capacity, see *Capacities and Specifications* on page 12-2.

**Notice:** Do not add too much oil. If the engine has so much oil that the oil level gets above the cross-hatched area that shows the proper operating range, the engine could be damaged.

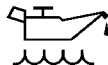

See *Engine Compartment Overview* on page 10-6 for the location of the engine oil fill cap.

Add enough oil to put the level somewhere in the proper operating range. Push the dipstick all the way back in when through.

### What Kind of Engine Oil to Use

Look for three things:

- GM6094M

Use only an oil that meets GM Standard GM6094M.

- SAE 5W-30

SAE 5W-30 is best for the vehicle. These numbers on an oil container show its viscosity, or thickness. Do not use other viscosity oils such as SAE 20W-50.

- American Petroleum Institute (API) starburst symbol



Oils meeting these requirements should have the starburst symbol on the container. This symbol indicates that the oil has been certified by the American Petroleum Institute (API).

**Notice:** Use only engine oil identified as meeting GM Standard GM6094M and showing the American Petroleum Institute Certified For Gasoline Engines starburst symbol. Failure to use the recommended oil can result in engine damage not covered by the vehicle warranty.

## Cold Temperature Operation

If in an area of extreme cold, where the temperature falls below  $-29^{\circ}\text{C}$  ( $-20^{\circ}\text{F}$ ), use either an SAE 5W-30 synthetic oil or an SAE 0W-30 engine oil. Both provide easier cold starting for the engine at extremely low temperatures. Always use an oil that meets the required specification, GM6094M. See "What Kind of Engine Oil to Use" for more information.

## Engine Oil Additives / Engine Oil Flushes

Do not add anything to the oil. The recommended oils with the starburst symbol that meet GM standards are all that is needed for good performance and engine protection.

Engine oil system flushes are not recommended and could cause engine damage not covered by the vehicle warranty.

## Engine Oil Life System

### When to Change Engine Oil

This vehicle has a computer system that indicates when to change the engine oil and filter. This is based on engine revolutions and engine temperature, and not on mileage. Based on driving conditions, the mileage at which an oil change is indicated can vary considerably. For the oil life system to work properly, the system must be reset every time the oil is changed.

When the system has calculated that oil life has been diminished, it indicates that an oil change is necessary. A "Change Oil" message comes on. See *Engine Oil Messages on page 5-23*. Change the oil as soon as possible within the next 1 000 km (600 miles). It is possible that, if driving under the best conditions, the oil life system might not indicate that an oil change is necessary for over a year.

However, the engine oil and filter must be changed at least once a year and at this time the system must be reset. Your dealer has trained service people who will perform this work using genuine parts and reset the system. It is also important to check the oil regularly and keep it at the proper level.

If the system is ever reset accidentally, the oil must be changed at 5 000 km (3,000 miles) since the last oil change. Remember to reset the oil life system whenever the oil is changed.

### How to Reset the Engine Oil Life System

The Engine Oil Life System calculates when to change the engine oil and filter based on vehicle use. Whenever the oil is changed, reset the system so it can calculate when the next oil change is required. If a situation occurs where the oil is changed prior to a change engine oil message being turned on, reset the system.

After changing the engine oil, reset the system:

1. Turn the ignition key to ON/RUN with the engine off.
2. Press and release the stem in the lower center of the instrument cluster until the OIL LIFE message is displayed.
3. Once the alternating “Oil Life” and “Reset” messages appear, press and hold the stem until several beeps sound. This confirms that the oil life system has been reset.
4. Turn the key to LOCK/OFF.

If the “Change Oil” message comes on again and stays on for 30 seconds at the next ignition cycle, it did not reset. The system needs to be reset again.

### What to Do with Used Oil

Used engine oil contains certain elements that can be unhealthy for your skin and could even cause cancer. Do not let used oil stay on your skin for very long. Clean your skin and nails with soap and water, or a good hand cleaner. Wash or properly dispose of clothing or rags containing used engine oil. See the manufacturer's warnings about the use and disposal of oil products.

Used oil can be a threat to the environment. If you change your own oil, be sure to drain all the oil from the filter before disposal. Never dispose of oil by putting it in the trash, pouring it on the ground, into sewers, or into streams or bodies of water. Recycle it by taking it to a place that collects used oil.

### Automatic Transmission Fluid

#### When to Check and Change Automatic Transmission Fluid

A good time to check the automatic transmission fluid level is when the engine oil is changed.

Change the fluid and filter at the intervals listed in *Scheduled Maintenance on page 11-2*, and be sure to use the transmission fluid listed in *Recommended Fluids and Lubricants on page 11-8*.

#### How to Check Automatic Transmission Fluid

Because this operation can be a little difficult, you may choose to have this done at the dealer service department.

If adding it yourself, be sure to follow all the instructions here, or there could be a false reading on the dipstick.

**Notice:** Too much or too little fluid can damage the transmission. Too much can mean that some of the fluid could come out and fall on hot engine parts or exhaust system parts, starting a fire. Too little fluid could cause the transmission to overheat. Be sure to get an accurate reading if checking the transmission fluid.

Wait at least 30 minutes before checking the transmission fluid level if you have been driving:

- When outside temperatures are above 32°C (90°F).
- At high speed for quite a while.
- In heavy traffic — especially in hot weather.
- While pulling a trailer.

To get the right reading, the fluid should be at normal operating temperature, which is 82°C to 93°C (180°F to 200°F).

Get the vehicle warmed up by driving about 24 km (15 miles) when outside temperatures are above 10°C (50°F). If it is colder than 10°C (50°F), drive the vehicle in 3 (Third) until the engine temperature gauge moves and then remains steady for 10 minutes.

A cold fluid check can be made after the vehicle has been sitting for eight hours or more with the engine off, but this is used only as a reference. Let the engine run at idle for five minutes if outside temperatures are 10°C (50°F) or more. If it is colder than 10°C (50°F), the engine might have to idle longer. Should the fluid level be low during this cold check, check the fluid hot before adding fluid. Checking the fluid hot gives a more accurate reading of the fluid level.

### Checking the Fluid Level

To prepare the vehicle:

1. Park the vehicle on a level place. Keep the engine running.
2. With the parking brake applied, place the shift lever in P (Park).
3. With your foot on the brake pedal, move the shift lever through each gear range, pausing for about three seconds in each range. Then, position the shift lever in P (Park).
4. Let the engine run at idle for three minutes or more.

## 10-14 Vehicle Care

---

Then, without shutting off the engine:

1. Flip the handle up and then pull out the dipstick and wipe it with a clean rag or paper towel.



The automatic transmission dipstick handle with this symbol on it is located in the engine compartment on the passenger side of the vehicle.

See *Engine Compartment Overview on page 10-6* for more information on location.

2. Push it back in all the way, wait three seconds, and pull it back out again.



3. Check both sides of the dipstick, and read the lower level. The fluid level must be in the COLD area, below the cross-hatched area, for a cold check or in the HOT or cross-hatched area for a hot check. Be sure to keep the dipstick pointed down to get an accurate reading.
4. If the fluid level is in the acceptable range, push the dipstick back in all the way; then flip the handle down to lock the dipstick in place.

### How to Add Automatic Transmission Fluid

Refer to the Maintenance Schedule to determine what kind of transmission fluid to use. See *Recommended Fluids and Lubricants on page 11-8*.

Add fluid only after checking the transmission fluid while it is hot. A cold check is used only as a reference. If the fluid level is low, add only enough of the proper fluid to bring the level up to the HOT area for a hot check. It does not take much fluid, generally less than one pint (0.5 L). Do not overfill.



**Notice:** Use of the incorrect automatic transmission fluid may damage the vehicle, and the damages may not be covered by the vehicle's warranty. Always use the automatic transmission fluid listed in *Recommended Fluids and Lubricants* on page 11-8.

- After adding fluid, recheck the fluid level as described under "How to Check Automatic Transmission Fluid," earlier in this section.
- When the correct fluid level is obtained, push the dipstick back in all the way; then flip the handle down to lock the dipstick in place.

## Manual Transmission Fluid

### When to Check

A good time to check the manual transmission fluid is when the engine oil is changed. However, the fluid in the manual transmission does not require changing.

### How to Check

Because this operation can be a little difficult, you may choose to have this done at your HUMMER dealer service department.

If doing it yourself, be sure to follow all the instructions here, or there could be a false reading.

**Notice:** Too much or too little fluid can damage the transmission. Too little fluid could cause the transmission to overheat. Be sure to get an accurate reading if checking the transmission fluid.

To check the fluid:

1. Park the vehicle on a level surface, then shut the engine off. Let the vehicle sit until the transmission case is cool enough to touch.



2. Remove the filler plug.
3. Check that the lubricant level is up to the bottom of the filler plug hole.

4. If the fluid level is good, install the plug and be sure it is fully seated. If the fluid level is low, add more fluid as described in the next steps.

### How to Add Fluid

Refer to the Maintenance Schedule to determine what kind of fluid to use. See *Recommended Fluids and Lubricants* on page 11-8.

1. Remove the filler plug.
2. Add fluid at the filler plug hole. Add only enough fluid to bring the fluid level up to the bottom of the filler plug hole.
3. Install the filler plug. Be sure the plug is fully seated.

### Hydraulic Clutch

The hydraulic clutch linkage in the vehicle is self-adjusting. The clutch master cylinder reservoir is filled with hydraulic clutch fluid.



The hydraulic clutch fluid reservoir cap has this symbol on it. See *Engine Compartment Overview* on page 10-6 for reservoir location.

It is not necessary to regularly check clutch fluid unless a leak in the system is suspected. Adding fluid will not correct a leak.

A fluid loss in this system could indicate a problem. Have the system inspected and repaired.

### When to Check and What to Use



Refer to the Maintenance Schedule to determine how often to check the fluid level in the clutch master cylinder reservoir and for the proper fluid. See *Recommended Fluids and Lubricants* on page 11-8.

### How to Check and Add Fluid

The proper fluid should be added if the level does not reach the bottom of the diaphragm when it is in place in the reservoir. See the instructions on the reservoir cap.

## Engine Air Cleaner/Filter

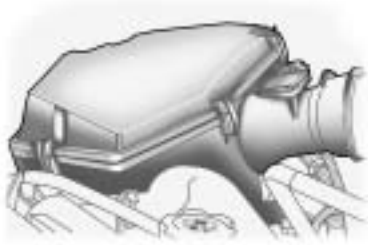

### 3.7 L shown (5.3 L similar)

The engine air cleaner/filter is located in the engine compartment on the passenger side of the vehicle. See *Engine Compartment Overview* on page 10-6 for more information on location.

### When to Inspect the Engine Air Cleaner/Filter

Inspect the air cleaner/filter at the Maintenance II intervals and replace it at the first oil change after each 80 000 km (50,000 mile) interval. See *Scheduled Maintenance* on page 11-2 for more information. If you are driving in dusty/dirty conditions, inspect the filter at each engine oil change.

### How to Inspect the Engine Air Cleaner/Filter

To inspect or replace the engine air cleaner/filter:

1. Unfasten the clips that hold the cover on and remove the cover.
2. Lift out the engine air cleaner/filter.

3. Inspect or replace the air filter. See *Maintenance Replacement Parts* on page 11-10 to determine which filter to use.
4. Reinstall the engine air cleaner/filter cover. Fasten the clips to hold the cover in place.

### WARNING

Operating the engine with the air cleaner/filter off can cause you or others to be burned. The air cleaner not only cleans the air; it helps to stop flames if the engine backfires. Use caution when working on the engine and do not drive with the air cleaner/filter off.

**Notice:** If the air cleaner/filter is off, dirt can easily get into the engine, which could damage it. Always have the air cleaner/filter in place when you are driving.

### Cooling System

The cooling system allows the engine to maintain the correct working temperature.

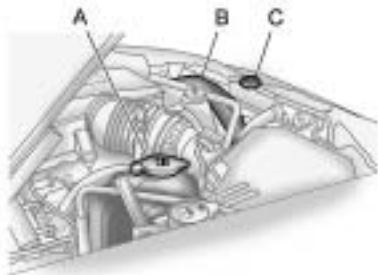

#### 3.7L L5 Engine

- A. Coolant Recovery Tank
- B. Engine Cooling Fan
- C. Radiator Pressure Cap

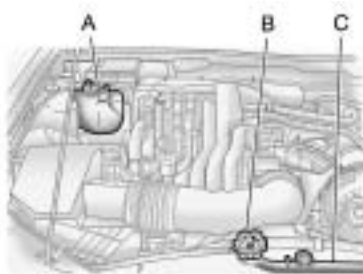

#### 5.3L V8 Engine

- A. Coolant Recovery Tank
- B. Radiator Pressure Cap
- C. Engine Cooling Fan

#### WARNING

An electric engine cooling fan under the hood can start up even when the engine is not running and can cause injury. Keep hands, clothing, and tools away from any underhood electric fan.

#### WARNING

Heater and radiator hoses, and other engine parts, can be very hot. Do not touch them. If you do, you can be burned.

Do not run the engine if there is a leak. If you run the engine, it could lose all coolant. That could cause an engine fire, and you could be burned. Get any leak fixed before you drive the vehicle.

**Notice:** Using coolant other than DEX-COOL<sup>®</sup> can cause premature engine, heater core, or radiator corrosion. In addition, the engine coolant could require changing sooner, at 50 000 km (30,000 miles) or 24 months, whichever occurs first. Any repairs would not be covered by the vehicle warranty. Always use DEX-COOL<sup>®</sup> (silicate-free) coolant in the vehicle.

## Engine Coolant

The cooling system in the vehicle is filled with DEX-COOL<sup>®</sup> engine coolant. This coolant is designed to remain in the vehicle for five years or 240 000 km (150,000 miles), whichever occurs first.

The following explains the cooling system and how to check and add coolant when it is low. If there is a problem with engine overheating, see *Engine Overheating* on page 10-22.

### What to Use

 **WARNING**

Adding only plain water to the cooling system can be dangerous. Plain water, or some other liquid such as alcohol, can boil before the proper coolant mixture will. The vehicle's coolant warning system is set for the proper coolant mixture.

(Continued)

**WARNING (Continued)**

With plain water or the wrong mixture, the engine could get too hot but you would not get the overheat warning. The engine could catch fire and you or others could be burned. Use a 50/50 mixture of clean, drinkable water and DEX-COOL<sup>®</sup> coolant.

Use a 50/50 mixture of clean, drinkable water and DEX-COOL coolant. If using this mixture, nothing else needs to be added. This mixture:

- Gives freezing protection down to -37°C (-34°F), outside temperature.
- Gives boiling protection up to 129°C (265°F), engine temperature.

- Protects against rust and corrosion.
- Will not damage aluminum parts.
- Helps keep the proper engine temperature.

**Notice:** If an improper coolant mixture is used, the engine could overheat and be badly damaged. The repair cost would not be covered by the vehicle warranty. Too much water in the mixture can freeze and crack the engine, radiator, heater core, and other parts.

**Notice:** If extra inhibitors and/or additives are used in the vehicle's cooling system, the vehicle could be damaged. Use only the proper mixture of the engine coolant listed in this manual for the cooling system. See *Recommended Fluids and Lubricants* on page 11-8 for more information.

### Checking Coolant

The vehicle must be on a level surface when checking the coolant level.



The coolant recovery tank cap has this symbol on it.

It is located toward the rear of the engine compartment on the passenger side of the vehicle. See *Engine Compartment Overview on page 10-6* for more information on location.

Check to see if coolant is visible in the coolant recovery tank. If the coolant inside the coolant recovery tank is boiling, do not do anything else until it cools down. If coolant is visible but the coolant level is not at or above the FULL COLD mark, add a 50/50 mixture of clean, drinkable

water and DEX-COOL coolant at the coolant recovery tank, but be sure the cooling system is cool before this is done.

The vehicle must be on a level surface. When the engine is cold, the coolant level should be at FULL COLD, or a little higher. When the engine is warm, the level could be above the FULL COLD level.

When the engine is cold, the coolant level should be at least up to the FULL COLD mark. If it is not, there could be a leak in the cooling system.

### How to Add Coolant to the Recovery Tank

#### WARNING

You can be burned if you spill coolant on hot engine parts. Coolant contains ethylene glycol and it will burn if the engine parts are hot enough. Do not spill coolant on a hot engine.

**Notice:** This vehicle has a specific coolant fill procedure. Failure to follow this procedure could cause the engine to overheat and be severely damaged.

When the coolant in the coolant recovery tank is at the FULL COLD mark, start the vehicle.

If coolant is needed, add the proper DEX-COOL coolant mixture at the coolant recovery tank.

### How to Add Coolant to the Radiator

#### WARNING

An electric engine cooling fan under the hood can start up even when the engine is not running and can cause injury. Keep hands, clothing, and tools away from any underhood electric fan.

**⚠ WARNING**

Steam and scalding liquids from a hot cooling system can blow out and burn you badly. They are under pressure, and if you turn the surge tank pressure cap — even a little — they can come out at high speed. Never turn the cap when the cooling system, including the surge tank pressure cap, is hot. Wait for the cooling system and surge tank pressure cap to cool if you ever have to turn the pressure cap.

If coolant is needed, add the proper mixture directly to the radiator, but be sure the cooling system is cool before this is done.

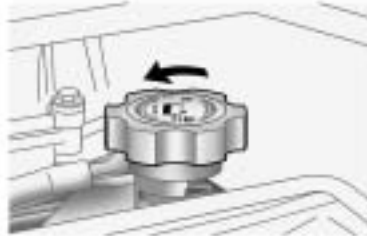

1. Remove the radiator pressure cap when the cooling system, including the upper radiator hose, is no longer hot. Turn the pressure cap slowly counterclockwise about one full turn.

If you hear a hiss, wait for that to stop. A hiss means there is still some pressure left.

2. Keep turning the cap to remove it.

3. Fill the radiator with the proper DEX-COOL coolant mixture, up to the base of the filler neck. See *Engine Coolant on page 10-19* for more information about the proper coolant mixture.



4. Fill the coolant recovery tank to the FULL COLD mark.
5. Reinstall the cap on the coolant recovery tank, but leave the radiator pressure cap off.



6. Start the engine and let it run until you can feel the upper radiator hose getting hot. Watch out for the engine cooling fan.
7. By this time, the coolant level inside the radiator filler neck might be lower. If the level is lower, add more of the proper DEX-COOL coolant mixture through the filler neck until the level reaches the base of the filler neck.
8. Then replace the pressure cap.

At any time during this procedure if coolant begins to flow out of the filler neck, reinstall the pressure cap.

**Notice:** If the pressure cap is not tightly installed, coolant loss and possible engine damage may occur. Be sure the cap is properly and tightly secured.

### Engine Overheating

The vehicle has an indicator to warn of engine overheating.

A coolant temperature gauge is displayed on the instrument panel. See *Engine Coolant Temperature Gauge* on page 5-9.

You may decide not to lift the hood when this warning appears, but instead get service help right away. See *Roadside Service* on page 13-5.

If you do decide to lift the hood, make sure the vehicle is parked on a level surface.

Then check to see if the engine cooling fans are running. If the engine is overheating, both fans should be running. If they are not, do not continue to run the engine and have the vehicle serviced.

The air conditioning might stop working if the engine is too hot. This is normal and helps cool the engine.

**Notice:** Engine damage from running the engine without coolant is not covered by the warranty.

**Notice:** If the engine catches fire because of being driven with no coolant, your vehicle can be badly damaged. The costly repairs would not be covered by the vehicle warranty.



**If Steam Is Coming From The Engine Compartment**

 **WARNING**

Steam from an overheated engine can burn you badly, even if you just open the hood. Stay away from the engine if you see or hear steam coming from it. Just turn it off and get everyone away from the vehicle until it cools down. Wait until there is no sign of steam or coolant before you open the hood.

If you keep driving when your engine is overheated, the liquids in it can catch fire. You or others could be badly burned. Stop your engine if it overheats, and get out of the vehicle until the engine is cool.

**If No Steam Is Coming From The Engine Compartment**

If an engine overheat warning is displayed but no steam can be seen or heard, the problem may not be too serious. Sometimes the engine can get a little too hot when the vehicle:

- Climbs a long hill on a hot day.
- Stops after high-speed driving.
- Idles for long periods in traffic.
- Tows a trailer. See “Driving on Grades” under *Trailer Towing on page 9-74*.

If the overheat warning is displayed with no sign of steam:

1. Turn the air conditioning off.
2. Turn the heater on to the highest temperature and to the highest fan speed. Open the windows as necessary.

3. In heavy traffic, let the engine idle in N (Neutral) while stopped. If it is safe to do so, pull off the road, shift to P (Park) or N (Neutral) and let the engine idle.

If the temperature overheat gauge is no longer in the overheat zone or an overheat warning no longer displays, the vehicle can be driven. Continue to drive the vehicle slow for about 10 minutes. Keep a safe vehicle distance from the car in front of you. If the warning does not come back on, continue to drive normally.

If the warning continues, pull over, stop, and park the vehicle right away.

If there is no sign of steam, idle the engine for three minutes while parked. If the warning is still displayed, turn off the engine until it cools down.

### Engine Fan

This vehicle has a clutched engine cooling fan. When the clutch is engaged, the fan spins faster to provide more air to cool the engine. In most everyday driving conditions, the clutch is not engaged. This improves fuel economy and reduces fan noise. Under heavy vehicle loading, trailer towing and/or high outside temperatures, the fan speed increases when the clutch engages. So you may hear an increase in fan noise. This is normal and should not be mistaken as the transmission slipping or making extra shifts. It is merely the cooling system functioning properly. The fan will slow down when additional cooling is not required and the clutch disengages.

You may also hear this fan noise when you start the engine. It will go away as the fan clutch disengages.

### Power Steering Fluid



See *Engine Compartment Overview on page 10-6* for reservoir location.

#### When to Check Power Steering Fluid

It is not necessary to regularly check power steering fluid unless a leak in the system is suspected or an unusual noise is heard. A fluid loss in this system could indicate a problem. Have the system inspected and repaired.

#### How to Check Power Steering Fluid

1. Turn the key off and let the engine compartment cool down.
2. Wipe the cap and the top of the reservoir clean.
3. Unscrew the cap and wipe the dipstick with a clean rag.
4. Replace the cap and completely tighten it.
5. Then remove the cap again and look at the fluid level on the dipstick.

The level should be between the ADD and FULL marks. If necessary, add only enough fluid to bring the level up to the proper range.

## What to Use

To determine what kind of fluid to use, see *Recommended Fluids and Lubricants* on page 11-8. Always use the proper fluid.

**Notice:** Use of the incorrect fluid may damage the vehicle and the damages may not be covered by the vehicle's warranty. Always use the correct fluid listed in *Recommended Fluids and Lubricants* on page 11-8.

## Washer Fluid

### What to Use

When windshield washer fluid is needed, be sure to read the manufacturer's instructions before use. If operating the vehicle in an area where the temperature may fall below freezing, use a fluid that has sufficient protection against freezing.

## Adding Washer Fluid



Open the cap with the washer symbol on it. Add washer fluid until the tank is full. See *Engine Compartment Overview* on page 10-6 for reservoir location.

### Notice:

- When using concentrated washer fluid, follow the manufacturer's instructions for adding water.

- Do not mix water with ready-to-use washer fluid. Water can cause the solution to freeze and damage the washer fluid tank and other parts of the washer system. Also, water does not clean as well as washer fluid.
- Fill the washer fluid tank only three-quarters full when it is very cold. This allows for fluid expansion if freezing occurs, which could damage the tank if it is completely full.
- Do not use engine coolant (antifreeze) in the windshield washer. It can damage the vehicle's windshield washer system and paint.

### Brakes

This vehicle has disc brakes. Disc brake pads have built-in wear indicators that make a high-pitched warning sound when the brake pads are worn and new pads are needed. The sound can come and go or be heard all the time the vehicle is moving, except when applying the brake pedal firmly.

 **WARNING**

The brake wear warning sound means that soon the brakes will not work well. That could lead to an accident. When the brake wear warning sound is heard, have the vehicle serviced.

**Notice:** Continuing to drive with worn-out brake pads could result in costly brake repair.

Some driving conditions or climates can cause a brake squeal when the brakes are first applied or lightly applied. This does not mean something is wrong with the brakes.

Properly torqued wheel nuts are necessary to help prevent brake pulsation. When tires are rotated, inspect brake pads for wear and evenly tighten wheel nuts in the proper sequence to torque specifications in *Capacities and Specifications on page 12-2*.

Brake linings should always be replaced as complete axle sets.

### Brake Pedal Travel

See your dealer if the brake pedal does not return to normal height, or if there is a rapid increase in pedal travel. This could be a sign that brake service might be required.

### Brake Adjustment

Every time the brakes are applied, with or without the vehicle moving, the brakes adjust for wear.

### Replacing Brake System Parts

The braking system on a vehicle is complex. Its many parts have to be of top quality and work well together if the vehicle is to have really good braking. The vehicle was designed and tested with top-quality brake parts. When parts of the braking system are replaced, be sure to get new, approved replacement parts. If this is not done, the brakes might not work properly. For example, installing disc brake pads that are wrong for the vehicle, can change the balance between the front and rear brakes — for the worse. The braking performance expected can change in many other ways if the wrong replacement brake parts are installed.

## Brake Fluid



The brake master cylinder reservoir is filled with DOT 3 brake fluid as indicated on the reservoir cap. See *Engine Compartment Overview on page 10-6* for the location of the reservoir.

There are only two reasons why the brake fluid level in the reservoir might go down:

- The brake fluid level goes down because of normal brake lining wear. When new linings are installed, the fluid level goes back up.
- A fluid leak in the brake hydraulic system can also cause a low fluid level. Have the brake hydraulic system fixed, since a leak means that sooner or later the brakes will not work well.

Do not top off the brake fluid. Adding fluid does not correct a leak. If fluid is added when the linings are worn, there will be too much fluid when new brake linings are installed. Add or remove brake fluid, as necessary, only when work is done on the brake hydraulic system.

### WARNING

If too much brake fluid is added, it can spill on the engine and burn, if the engine is hot enough. You or others could be burned, and the vehicle could be damaged. Add brake fluid only when work is done on the brake hydraulic system.

When the brake fluid falls to a low level, the brake warning light comes on. See *Brake System Warning Light on page 5-14*.

### What to Add

Use only new DOT 3 brake fluid from a sealed container. See *Recommended Fluids and Lubricants* on page 11-8.

Always clean the brake fluid reservoir cap and the area around the cap before removing it. This helps keep dirt from entering the reservoir.

#### **WARNING**

With the wrong kind of fluid in the brake hydraulic system, the brakes might not work well. This could cause a crash. Always use the proper brake fluid.

### Notice:

- **Using the wrong fluid can badly damage brake hydraulic system parts. For example, just a few drops of mineral-based oil, such as engine oil, in the brake hydraulic system can damage brake hydraulic system parts so badly that they will have to be replaced. Do not let someone put in the wrong kind of fluid.**
- **If brake fluid is spilled on the vehicle's painted surfaces, the paint finish can be damaged. Be careful not to spill brake fluid on the vehicle. If you do, wash it off immediately.**

### Battery

Refer to the replacement number shown on the original battery label when a new battery is needed. See *Engine Compartment Overview* on page 10-6 for battery location.

#### **DANGER**

Battery posts, terminals, and related accessories contain lead and lead compounds, chemicals known to the State of California to cause cancer and reproductive harm. Wash hands after handling.

## Vehicle Storage

### WARNING

Batteries have acid that can burn you and gas that can explode. You can be badly hurt if you are not careful. See *Jump Starting* on page 10-86 for tips on working around a battery without getting hurt.

**Infrequent Usage:** Remove the black, negative (-) cable from the battery to keep the battery from running down.

**Extended Storage:** Remove the black, negative (-) cable from the battery or use a battery trickle charger.

## Four-Wheel Drive

It is recommended that the four-wheel drive transfer case fluid be checked and filled by the dealer.

## Front Axle

It is not necessary to regularly check front axle fluid unless a leak is suspected or an unusual noise is heard. A fluid loss could indicate a problem.

It is recommended that the front axle fluid be checked and filled by your dealer.

## Rear Axle

### When to Check and Change Lubricant

It is not necessary to regularly check rear axle fluid unless a leak is suspected or an unusual noise is heard. A fluid loss could indicate a problem. Have it inspected and repaired.

### How to Check Lubricant

To get an accurate reading, the vehicle should be on a level surface.

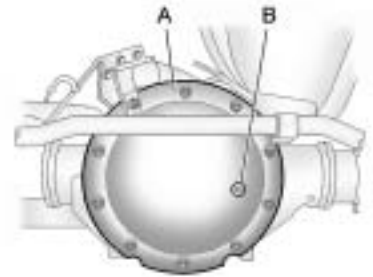

A. Rear Axle

B. Filler Plug

The proper level for the rear axle fluid is 0 mm to 10 mm (0 to 3/8 inch) below the bottom of the filler plug hole, located on the rear axle.

### What to Use

See *Recommended Fluids and Lubricants* on page 11-8 to determine which kind of lubricant to use.

### Starter Switch Check

 **WARNING**

When you are doing this inspection, the vehicle could move suddenly. If the vehicle moves, you or others could be injured.

1. Before starting this check, be sure there is enough room around the vehicle.
2. Firmly apply both the parking brake and the regular brake. See *Parking Brake on page 9-51*.  
Do not use the accelerator pedal, and be ready to turn off the engine immediately if it starts.

3. For automatic transmission vehicles, try to start the engine in each gear. The vehicle should start only in P (Park) or N (Neutral). If the vehicle starts in any other position, contact your dealer for service.

For manual transmission vehicles, put the shift lever in Neutral, push the clutch pedal down halfway, and try to start the engine. The vehicle should start only when the clutch pedal is pushed down all the way to the floor. If the vehicle starts when the clutch pedal is not pushed all the way down, contact your dealer for service.

### Automatic Transmission Shift Lock Control System Check

 **WARNING**

When you are doing this inspection, the vehicle could move suddenly. If the vehicle moves, you or others could be injured.

1. Before starting this check, be sure there is enough room around the vehicle. It should be parked on a level surface.
2. Firmly apply the parking brake. See *Parking Brake on page 9-51*.  
Be ready to apply the regular brake immediately if the vehicle begins to move.



3. With the engine off, turn the ignition to ON/RUN, but do not start the engine. Without applying the regular brake, try to move the shift lever out of P (Park) with normal effort. If the shift lever moves out of P (Park), contact your dealer for service.

### Ignition Transmission Lock Check

While parked, and with the parking brake set, try to turn the ignition to LOCK/OFF in each shift lever position.

- For automatic transmission vehicles, the ignition should turn to LOCK/OFF only when the shift lever is in P (Park). The ignition key should come out only in LOCK/OFF.

- For manual transmission vehicles, the ignition key should come out only in LOCK/OFF.

Contact your dealer if service is required.

### Park Brake and P (Park) Mechanism Check

 **WARNING**

When you are doing this check, the vehicle could begin to move. You or others could be injured and property could be damaged. Make sure there is room in front of the vehicle in case it begins to roll. Be ready to apply the regular brake at once should the vehicle begin to move.

Park on a fairly steep hill, with the vehicle facing downhill. Keeping your foot on the regular brake, set the parking brake.

- To check the parking brake's holding ability: With the engine running and the transmission in N (Neutral), slowly remove foot pressure from the regular brake pedal. Do this until the vehicle is held by the parking brake only.
- To check the P (Park) mechanism's holding ability: With the engine running, shift to P (Park). Then release the parking brake followed by the regular brake.

Contact your dealer if service is required.

### Wiper Blade Replacement

Windshield wiper blades should be inspected for wear and cracking. See *Scheduled Maintenance on page 11-2* for more information.

Replacement blades come in different types and are removed in different ways. For proper type and length, see *Maintenance Replacement Parts on page 11-10*.

To replace the windshield wiper blade:



1. Lift the wiper arm away from the windshield.

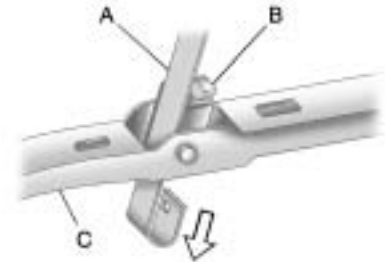

2. Push the release lever (B) to disengage the hook and push the wiper arm (A) out of the blade (C).
3. Push the new wiper blade securely on the wiper arm until you hear the release lever click into place.

To replace the rear wiper blade, lift the rear wiper arm from the window and pull the blade.

## Headlamp Aiming

The vehicle may have a visual optical headlamp aiming system. The aim has been preset at the factory and should need no further adjustment.

However, if the vehicle is damaged in a crash, the headlamp aim may be affected and adjustment may be necessary.

If oncoming vehicles flash their high beams at you, this may also mean the vertical aim needs to be adjusted.

It is recommended that the vehicle is taken to your dealer for service if the headlamps need to be re-aimed. It is possible however, to re-aim the headlamps as described.

The vehicle should be:

- Placed so the headlamps are 7.6 m (25 ft) from a light colored wall or other flat surface.
- On a level surface which is level all the way to a wall.
- Placed so it is at a right angle to the wall or other flat surface.
- Clear of any snow, ice, or mud on it.
- Fully assembled, the tires properly inflated, and all other work stopped while headlamp aiming is being performed.
- Normally loaded with the spare tire in its original location and a full tank of fuel and one person or 75 kg (160 lbs) sitting on the driver seat.

To adjust the vertical aim:

1. Open the hood. See *Hood* on page 10-5.



2. Record the distance from the ground to the aim dot on the headlamp.

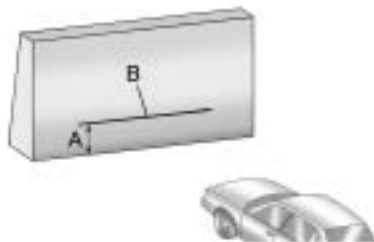

3. At a wall, measure from the ground upward the recorded distance from Step 2 and mark it.
4. Draw or tape a horizontal line the width of the vehicle at the wall where it was marked it Step 4.

**Notice: Do not cover a headlamp to improve beam cut-off when aiming. Covering a headlamp may cause excessive heat build-up which may cause damage to the headlamp.**

5. Turn on the headlamps and place a piece of cardboard or equivalent in front of the headlamp not being aimed. This should allow only the beam of light from the headlamp being aimed to be seen on the wall.

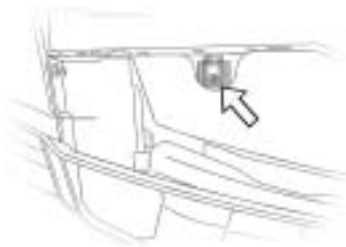

### Passenger Side Shown

6. Locate the vertical headlamp aiming screws, which are under the hood near each headlamp assembly.

The adjustment screw can be turned with an E8 Torx<sup>®</sup> socket or T15 Torx<sup>®</sup> screwdriver.

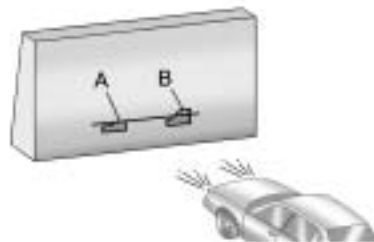

7. Turn the vertical aiming screw until the headlamp beam is aimed to the horizontal tape line. Turn it clockwise or counterclockwise to raise or lower the beam.

The top edge of the cut-off should be positioned at the bottom edge of the horizontal tape line.

8. Repeat Steps 7 and 8 for the opposite headlamp.

## Bulb Replacement

For the proper type of replacement bulbs, see *Replacement Bulbs* on page 10-37.

For any bulb changing procedure not listed in this section, contact your dealer.

## Halogen Bulbs

**⚠ WARNING**

Halogen bulbs have pressurized gas inside and can burst if you drop or scratch the bulb. You or others could be injured. Be sure to read and follow the instructions on the bulb package.

## Headlamps

To replace a headlamp bulb:

1. Open the hood. See *Hood* on page 10-5 for more information.



2. Turn the bulb socket counterclockwise to remove it from the headlamp assembly and pull it straight out.
3. Unplug the electrical connector by pushing the release tab and pulling the bulb socket out.

4. Replace with a new bulb socket.
5. Reverse steps 1 through 3 to reinstall.

## Taillamps, Turn Signal, Stoplamps, and Back-Up Lamps (H3)

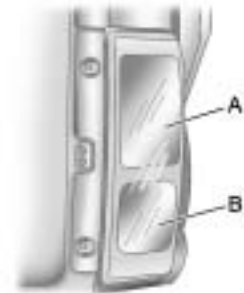

- A. Stoplamp, Taillamp and Turn Signal Lamp
- B. Back-up Lamp

## 10-36 Vehicle Care

To replace one of these bulbs in the taillamp assembly:

1. Open the swing-gate. See *Tailgate on page 2-7*.



### Passenger Side Shown

2. Remove the two screws from the taillamp assembly.
3. Pull the taillamp assembly away from the vehicle.
4. Turn the bulb socket counterclockwise to remove it from the taillamp assembly.

5. Pull the old bulb to release it from the socket.
6. Reverse steps 1 through 4 to reinstall.

### Taillamps, Turn Signal, and Back-Up Lamps (H3T)

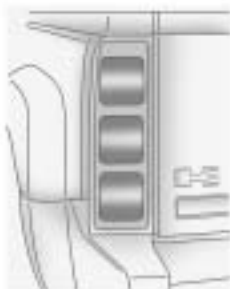

- A. Stoplamp and Taillamp
- B. Turn Signal Lamp
- C. Back-up Lamp

To replace one of these bulbs in the taillamp assembly:

1. Open the tailgate. See *Tailgate on page 2-7*.



2. Remove the two screws from the taillamp assembly.
3. Pull the taillamp assembly away from the vehicle.

4. Turn the bulb socket counterclockwise to remove it from the taillamp assembly.
5. Pull the old bulb to release it from the socket.
6. Turn the bulb socket clockwise to reinstall in the taillamp assembly.
7. Reinstall the taillamp assembly making sure to line up the pins with the vehicle.
8. Reinstall the two screws.

## License Plate Lamp

To replace one of these bulbs:



1. Remove the two screws holding the license plate lamp.
2. Pull the license plate lamp away from the fascia.
3. Turn the bulb socket counterclockwise and pull the bulb straight out of the license plate lamp assembly.

4. Install the new bulb into the socket.
5. Reverse steps 1 through 4 to reinstall.

## Replacement Bulbs

Exterior Lamp	Bulb Number
Back-up Lamp (H3T)	W16W
Back-up (H3), Stoplamp, Taillamp and Turn Signal Lamp	3157K
License Plate Lamp	194
Low-Beam and High-Beam Headlamp	H13

For replacement bulbs not listed here, contact your dealer.

## Electrical System

### Electrical System Overload

The vehicle has fuses and circuit breakers to protect against an electrical system overload.

When the current electrical load is too heavy, the circuit breaker opens and closes, protecting the circuit until the current load returns to normal or the problem is fixed. This greatly reduces the chance of circuit overload and fire caused by electrical problems.

Fuses and circuit breakers protect the following in the vehicle:

- Headlamp Wiring
- Windshield Wiper Motor
- Power Windows and other Power Accessories

#### Headlamp Wiring

An electrical overload may cause the lamps to go on and off, or in some cases to remain off. Have the headlamp wiring checked right away if the lamps go on and off or remain off.

#### Windshield Wipers

If the wiper motor overheats due to heavy snow or ice, the windshield wipers will stop until the motor cools and will then restart.

Although the circuit is protected from electrical overload, overload due to heavy snow or ice, may cause wiper linkage damage. Always clear ice and heavy snow from the windshield before using the windshield wipers.

If the overload is caused by an electrical problem and not snow or ice, be sure to get it fixed.

#### Power and Heated Seat Circuit Breakers

There is a circuit breaker located underneath the driver side front seat that controls the power and heated seat functions.



## Fuses and Circuit Breakers

The wiring circuits in your vehicle are protected from short circuits by a combination of fuses and circuit breakers. This greatly reduces the chance of fires caused by electrical problems.

Look at the silver-colored band inside the fuse. If the band is broken or melted, replace the fuse. Be sure you replace a bad fuse with a new one of the identical size and rating.

If you ever have a problem on the road and do not have a spare fuse, you can borrow one that has the same amperage. Just pick some feature of your vehicle that you can get along without — like the radio or cigarette lighter — and use its fuse, if it is the correct amperage. Replace it as soon as you can.

## Engine Compartment Fuse Block



The engine compartment fuse block is located on the driver side of the engine compartment. See *Engine Compartment Overview* on page 10-6 for more information on location.

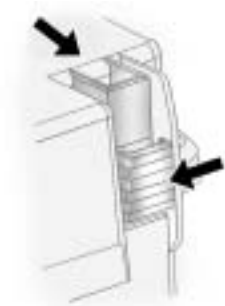

To remove the cover, push in on the tabs at the ends of the cover and lift. To reinstall the cover, line up the tabs and push down on the cover until the tabs clicks into place.

**Notice:** Spilling liquid on any electrical components on the vehicle may damage it. Always keep the covers on any electrical component.

## 10-40 Vehicle Care

---

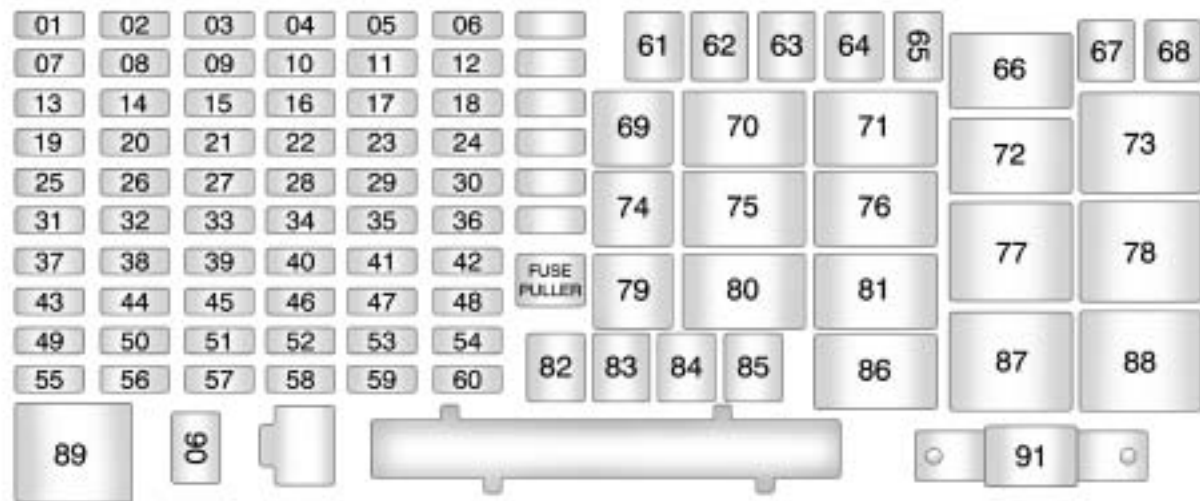

<b>Fuse</b>	<b>Usage</b>
1	Heated Seats
2	Grille Guard
3	Stop Lamp (H3T Only)
4	Roof Rack Lamps
5	Battery Ignition Switch
6	Front Wiper
7	Regulated Voltage Control Power
8	Power Locks
9	Sunroof, Front Washer Pump
10	Accessories (SPO)
11	Not Used
12	Transfer Case Control Module
13	Radio
14	Body Control Module

<b>Fuse</b>	<b>Usage</b>
15	Rear Wiper Motor (H3 Only)
16	Rear Wiper Pump Switch (H3 Only)
17	Air Injection Reactor (AIR) Pump Relay/ Transmission Control Module (TCM) (V8 Only)
18	Rear Vision Camera
19	Cluster
20	Rear Turn Lamp, Hazard Lamp
21	Powertrain Control Module 1
22	Mass Air Flow Sensor, Canister Vent Purge Solenoid
23	Injector/V8 Coil
24	Fog Lamp
25	Powertrain Control Module B

<b>Fuse</b>	<b>Usage</b>
26	Transmission Control Module (TCM)
27	Airbags
28	Not Used
29	Antilock Brake System, StabiliTrak®
30	Rear Window Defogger
31	Canister Vent
32	Regulated Voltage Control Sensor
33	Ignition 1
34	Transmission
35	Cruise Control, Miscellaneous
36	Horn
37	Driver Side Rear Park Lamp
38	Amplifier

**10-42 Vehicle Care**

Fuse	Usage
39	Daytime Running Lamps
40	Passenger Side Headlamp
41	Driver Side Headlamp
42	Trailer Back-Up Lamp
43	Front Park Lamps
44	Air Injection Reactor (AIR) Solenoid
45	Auxiliary Power 2/ Cigarette Lighter
46	Electronic Throttle Control
47	Oxygen Sensor
48	Air Conditioning Clutch
49	Rear Park Lamp
50	Stop Lamp

Fuse	Usage
51	Auxiliary Power 1/ Cigarette Lighter
52	StabiliTrak <sup>®</sup> , Antilock Brake System
53	Power Heated Seat, Belt Switch
54	Fuel System Control Module (FSCM)
55	Trailer Parking Lamps
56	Front Turn Signal, Hazard Signal, Courtesy Mirror
57	Power Sunroof
58	Transfer Case Control Module Switch
59	Climate Controls Control Head
60	Back-Up Lamp
61	Power Seats

Fuse	Usage
62	Air Injection Reactor (AIR) Pump
63	Passenger Side Power Window
64	Antilock Brake System, StabiliTrak <sup>®</sup> 2 Solenoid
67	Antilock Brake System, StabiliTrak <sup>®</sup> 1 Motor
68	Driver Side Power Window
82	Climate Control Fan
83	Electronic Brake Controller
84	Trailer B+ Fuse
85	Starter
91	Generator Megafuse

<b>Relay</b>	<b>Usage</b>
66	Stop Lamp (H3T Only)
69	Fog Lamp
70	High, Low Beam Headlamps
71	Rear Defogger
72	Windshield Wiper On/Off
73	Windshield Wiper High/Low
74	Horn

<b>Relay</b>	<b>Usage</b>
75	Headlamp
76	Air Conditioning Clutch
77	Powertrain Control Module (Starter)
78	Run, Crank
79	Daytime Running Lamps
80	Air Injection Reactor (AIR) Solenoid
81	Powertrain

<b>Relay</b>	<b>Usage</b>
86	Back-up
87	Ignition 3 (Heating, Ventilation, Air Conditioning)
88	Retained Accessory Power/Accessory
89	Park Lamp

<b>Diode</b>	<b>Usage</b>
65	Wiper Diode
90	Air Conditioning Clutch Diode

## Wheels and Tires

### Tires

Your new vehicle comes with high-quality tires made by a leading tire manufacturer. If you ever have questions about your tire warranty and where to obtain service, see your vehicle Warranty booklet for details. For additional information refer to the tire manufacturer.

#### WARNING

Poorly maintained and improperly used tires are dangerous.

- Overloading your tires can cause overheating as a result of too much flexing. You could have an air-out and a serious accident. See *Vehicle Load Limits* on page 9-27.

(Continued)

#### WARNING (Continued)

- Underinflated tires pose the same danger as overloaded tires. The resulting accident could cause serious injury. Check all tires frequently to maintain the recommended pressure. Tire pressure should be checked when your tires are cold. See *Tire Pressure* on page 10-51.
- Overinflated tires are more likely to be cut, punctured or broken by a sudden impact — such as when you hit a pothole. Keep tires at the recommended pressure.
- Worn, old tires can cause accidents. If your tread is badly worn, or if your tires have been damaged, replace them.

### Tire Sidewall Labeling

Useful information about a tire is molded into the sidewall. The following illustrations are examples of a typical P-Metric and a LT-Metric tire sidewall.

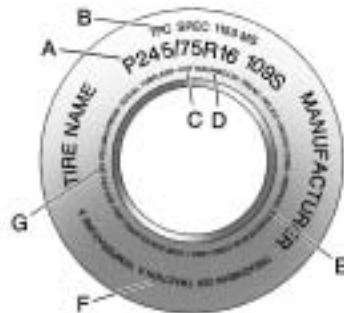

#### Passenger (P-Metric) Tire

**(A) Tire Size:** The tire size code is a combination of letters and numbers used to define a particular tire's width, height, aspect ratio, construction type,

and service description. See the “Tire Size” illustration later in this section for more detail.

**(B) TPC Spec (Tire Performance Criteria Specification):**

Original equipment tires designed to GM's specific tire performance criteria have a TPC specification code molded onto the sidewall. GM's TPC specifications meet or exceed all federal safety guidelines.

**(C) DOT (Department of Transportation):**

The Department of Transportation (DOT) code indicates that the tire is in compliance with the U.S. Department of Transportation Motor Vehicle Safety Standards.

**(D) Tire Identification Number (TIN):**

The letters and numbers following DOT code are the Tire Identification Number (TIN).

The TIN shows the manufacturer and plant code, tire size, and date the tire was manufactured. The TIN is molded onto both sides of the tire, although only one side may have the date of manufacture.

**(E) Tire Ply Material:** The type of cord and number of plies in the sidewall and under the tread.

**(F) Uniform Tire Quality Grading (UTQG):**

Tire manufacturers are required to grade tires based on three performance factors: treadwear, traction, and temperature resistance. For more information, see *Uniform Tire Quality Grading* on page 10-61.

**(G) Maximum Cold Inflation Load Limit:**

Maximum load that can be carried and the maximum pressure needed to support that load.

For information on recommended tire pressure see *Tire Pressure* on page 10-51 and *Vehicle Load Limits* on page 9-27.

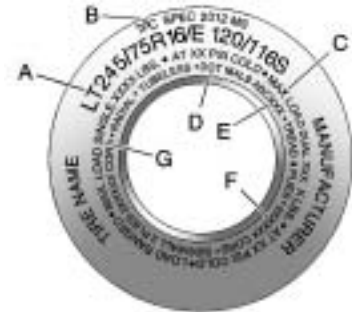

**Light Truck (LT-Metric) Tire**

**(A) Tire Size:** The tire size code is a combination of letters and numbers used to define a particular tire's width, height, aspect ratio, construction type, and service description. See the “Tire Size” illustration later in this section for more detail.

**(B) TPC Spec (Tire Performance Criteria Specification):**

Original equipment tires designed to GM's specific tire performance criteria have a TPC specification code molded onto the sidewall. GM's TPC specifications meet or exceed all federal safety guidelines.

**(C) Dual Tire Maximum Load:**

Maximum load that can be carried and the maximum pressure needed to support that load when used in a dual configuration. For information on recommended tire pressure see *Tire Pressure on page 10-51* and *Vehicle Load Limits on page 9-27*.

**(D) DOT (Department of Transportation):**

The Department of Transportation (DOT) code indicates that the

tire is in compliance with the U.S. Department of Transportation Motor Vehicle Safety Standards.

**(E) Tire Identification Number (TIN):**

The letters and numbers following DOT code are the Tire Identification Number (TIN). The TIN shows the manufacturer and plant code, tire size, and date the tire was manufactured. The TIN is molded onto both sides of the tire, although only one side may have the date of manufacture.

**(F) Tire Ply Material:** The type of cord and number of plies in the sidewall and under the tread.

**(G) Single Tire Maximum**

**Load:** Maximum load that can be carried and the maximum pressure needed to support that load when used as a single. For information on recommended

tire pressure see *Tire Pressure on page 10-51* and *Vehicle Load Limits on page 9-27*.

**Tire Designations****Tire Size**

The following examples show the different parts of a tire size.

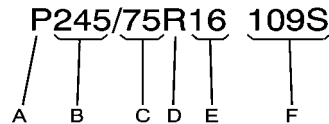
**Passenger (P-Metric) Tire**

**(A) Passenger (P-Metric) Tire:** The United States version of a metric tire sizing system. The letter P as the first character in the tire size means a passenger vehicle tire engineered to standards set by the U.S. Tire and Rim Association.



**(B) Tire Width:** The three-digit number indicates the tire section width in millimeters from sidewall to sidewall.

**(C) Aspect Ratio:** A two-digit number that indicates the tire height-to-width measurements. For example, if the tire size aspect ratio is 75, as shown in item C of the illustration, it would mean that the tire's sidewall is 75 percent as high as it is wide.

**(D) Construction Code:** A letter code is used to indicate the type of ply construction in the tire. The letter R means radial ply construction; the letter D means diagonal or bias ply construction; and the letter B means belted-bias ply construction.

**(E) Rim Diameter:** Diameter of the wheel in inches.

**(F) Service Description:** These characters represent the load index and speed rating of the tire. The load index represents the load carry capacity a tire is certified to carry. The speed rating is the maximum speed a tire is certified to carry a load.

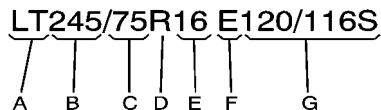

**Light Truck (LT-Metric) Tire**

**(A) Light Truck (LT-Metric) Tire:** The United States version of a metric tire sizing system. The letters LT as the first two characters in the tire size means a light truck tire engineered to standards set by the U.S. Tire and Rim Association.

**(B) Tire Width:** The three-digit number indicates the tire section width in millimeters from sidewall to sidewall.

**(C) Aspect Ratio:** A two-digit number that indicates the tire height-to-width measurements. For example, if the tire size aspect ratio is 75, as shown in item C of the light truck (LT-Metric) tire illustration, it would mean that the tire's sidewall is 75 percent as high as it is wide.

**(D) Construction Code:** A letter code is used to indicate the type of ply construction in the tire. The letter R means radial ply construction; the letter D means diagonal or bias ply construction; and the letter B means belted-bias ply construction.

**(E) Rim Diameter:** Diameter of the wheel in inches.

**(F) Load Range:** Load Range.

**(G) Service Description:** The service description indicates the load index and speed rating of a tire. If two numbers are given as in the example, 120/116, then this represents the load index for single versus dual wheel usage (single/dual). The speed rating is the maximum speed a tire is certified to carry a load.

## Tire Terminology and Definitions

**Air Pressure:** The amount of air inside the tire pressing outward on each square inch of the tire. Air pressure is expressed in psi (pounds per square inch) or kPa (kilopascal).

**Accessory Weight:** This means the combined weight of optional accessories. Some examples of optional accessories are, automatic transmission, power steering, power brakes, power windows, power seats, and air conditioning.

**Aspect Ratio:** The relationship of a tire's height to its width.

**Belt:** A rubber coated layer of cords that is located between the plies and the tread. Cords may be made from steel or other reinforcing materials.

**Bead:** The tire bead contains steel wires wrapped by steel cords that hold the tire onto the rim.

**Bias Ply Tire:** A pneumatic tire in which the plies are laid at alternate angles less than 90 degrees to the centerline of the tread.

**Cold Tire Pressure:** The amount of air pressure in a tire, measured in psi (pounds per square inch) or kPa (kilopascal) before a tire has built up heat from driving. See *Tire Pressure on page 10-51*.

**Curb Weight:** The weight of a motor vehicle with standard and optional equipment including the maximum capacity of fuel, oil, and coolant, but without passengers and cargo.

**DOT Markings:** A code molded into the sidewall of a tire signifying that the tire is in compliance with the U.S. Department of Transportation (DOT) motor vehicle safety standards. The DOT code includes the Tire Identification Number (TIN), an alphanumeric designator which can also identify the tire manufacturer, production plant, brand, and date of production.

**GVWR:** Gross Vehicle Weight Rating. See *Vehicle Load Limits on page 9-27*.

**GAWR FRT:** Gross Axle Weight Rating for the front axle. See *Vehicle Load Limits on page 9-27*.

**GAWR RR:** Gross Axle Weight Rating for the rear axle. See *Vehicle Load Limits on page 9-27*.

**Intended Outboard Sidewall:** The side of an asymmetrical tire, that must always face outward when mounted on a vehicle.

**Kilopascal (kPa):** The metric unit for air pressure.

**Light Truck (LT-Metric) Tire:** A tire used on light duty trucks and some multipurpose passenger vehicles.

**Load Index:** An assigned number ranging from 1 to 279 that corresponds to the load carrying capacity of a tire.

**Maximum Inflation Pressure:** The maximum air pressure to which a cold tire can be inflated. The maximum air pressure is molded onto the sidewall.

**Maximum Load Rating:** The load rating for a tire at the maximum permissible inflation pressure for that tire.

**Maximum Loaded Vehicle Weight:** The sum of curb weight, accessory weight, vehicle capacity weight, and production options weight.

**Normal Occupant Weight:** The number of occupants a vehicle is designed to seat multiplied by 68 kg (150 lbs). See *Vehicle Load Limits on page 9-27*.

**Occupant Distribution:** Designated seating positions.

**Outward Facing Sidewall:** The side of an asymmetrical tire that has a particular side that faces outward when mounted on a vehicle. The side of the tire that contains a whitewall, bears white lettering, or bears manufacturer, brand, and/or model name molding that is higher or deeper than the same moldings on the other sidewall of the tire.

**Passenger (P-Metric) Tire:**

A tire used on passenger cars and some light duty trucks and multipurpose vehicles.

**Recommended Inflation**

**Pressure:** Vehicle manufacturer's recommended tire inflation pressure as shown on the tire placard. See *Tire Pressure on page 10-51* and *Vehicle Load Limits on page 9-27*.

**Radial Ply Tire:** A pneumatic tire in which the ply cords that extend to the beads are laid at 90 degrees to the centerline of the tread.

**Rim:** A metal support for a tire and upon which the tire beads are seated.

**Sidewall:** The portion of a tire between the tread and the bead.

**Speed Rating:** An alphanumeric code assigned to a tire indicating the maximum speed at which a tire can operate.

**Traction:** The friction between the tire and the road surface. The amount of grip provided.

**Tread:** The portion of a tire that comes into contact with the road.

**Treadwear Indicators:** Narrow bands, sometimes called wear bars, that show across the tread of a tire when only 1.6 mm (1/16 inch) of tread remains. See *When It Is Time for New Tires on page 10-58*.

**UTQGS (Uniform Tire Quality Grading Standards):** A tire information system that provides consumers with ratings for a tire's traction, temperature, and treadwear. Ratings are determined by tire manufacturers using government testing procedures. The ratings are molded into the sidewall of the tire. See *Uniform Tire Quality Grading on page 10-61*.

**Vehicle Capacity Weight:** The number of designated seating positions multiplied by 68 kg (150 lbs) plus the rated cargo load. See *Vehicle Load Limits on page 9-27*.

**Vehicle Maximum Load on the Tire:** Load on an individual tire due to curb weight, accessory weight, occupant weight, and cargo weight.

**Vehicle Placard:** A label permanently attached to a vehicle showing the vehicle's capacity weight and the original equipment tire size and recommended inflation pressure. See "Tire and Loading Information Label" under *Vehicle Load Limits* on page 9-27.

## Tire Pressure

Tires need the correct amount of air pressure to operate effectively.

**Notice: Do not let anyone tell you that under-inflation or over-inflation is all right. It is not. If your tires do not have enough air (under-inflation), you can get the following:**

- **Too much flexing**
- **Too much heat**
- **Tire overloading**

- **Premature or irregular wear**
- **Poor handling**
- **Reduced fuel economy**

**If your tires have too much air (over-inflation), you can get the following:**

- **Unusual wear**
- **Poor handling**
- **Rough ride**
- **Needless damage from road hazards**

A vehicle specific Tire and Loading Information label is attached to your vehicle. This label shows your vehicle's original equipment tires and the correct inflation pressures for your tires when they are cold. The recommended cold tire inflation pressure, shown on the label, is the minimum amount of

air pressure needed to support your vehicle's maximum load carrying capacity.

For additional information regarding how much weight your vehicle can carry, and an example of the Tire and Loading Information label, see *Vehicle Load Limits* on page 9-27.

How you load your vehicle affects vehicle handling and ride comfort. Never load your vehicle with more weight than it was designed to carry.

## When to Check

Check your tires once a month or more. Also check the tire pressure of the spare tire. If your vehicle has a compact spare tire, it should be at 60 psi (420 kPa). See *Full-Size Spare Tire* on page 10-85 for additional information.

### How to Check

Use a good quality pocket-type gauge to check tire pressure. You cannot tell if your tires are properly inflated simply by looking at them. Radial tires may look properly inflated even when they are underinflated. Check the tire's inflation pressure when the tires are cold. Cold means your vehicle has been sitting for at least three hours or driven no more than 1 mile (1.6 km).

Remove the valve cap from the tire valve stem. Press the tire gauge firmly onto the valve to get a pressure measurement. If the cold tire inflation pressure matches the recommended pressure on the Tire and Loading Information label, no further adjustment is necessary. If the inflation pressure is low, add air until you reach the recommended amount.

If you overfill the tire, release air by pushing on the metal stem in the center of the tire valve. Recheck the tire pressure with the tire gauge.

Be sure to put the valve caps back on the valve stems. They help prevent leaks by keeping out dirt and moisture.

### Tire Pressure Monitor System

The Tire Pressure Monitor System (TPMS) uses radio and sensor technology to check tire pressure levels. The TPMS sensors monitor the air pressure in your vehicle's tires and transmit tire pressure readings to a receiver located in the vehicle.

Each tire, including the spare (if provided), should be checked monthly when cold and inflated to the inflation pressure recommended by the vehicle manufacturer on the

vehicle placard or tire inflation pressure label. (If your vehicle has tires of a different size than the size indicated on the vehicle placard or tire inflation pressure label, you should determine the proper tire inflation pressure for those tires.)

As an added safety feature, your vehicle has been equipped with a tire pressure monitoring system (TPMS) that illuminates a low tire pressure telltale when one or more of your tires is significantly under-inflated.

Accordingly, when the low tire pressure telltale illuminates, you should stop and check your tires as soon as possible, and inflate them to the proper pressure. Driving on a significantly under-inflated tire causes the tire to overheat and can lead to tire failure. Under-inflation also reduces fuel efficiency and tire tread life, and may affect the vehicle's handling and stopping ability.

Please note that the TPMS is not a substitute for proper tire maintenance, and it is the driver's responsibility to maintain correct tire pressure, even if under-inflation has not reached the level to trigger illumination of the TPMS low tire pressure telltale.

Your vehicle has also been equipped with a TPMS malfunction indicator to indicate when the system is not operating properly. The TPMS malfunction indicator is combined with the low tire pressure telltale. When the system detects a malfunction, the telltale will flash for approximately one minute and then remain continuously illuminated. This sequence will continue upon subsequent vehicle start-ups as long as the malfunction exists.

When the malfunction indicator is illuminated, the system may not be able to detect or signal low tire pressure as intended.

TPMS malfunctions may occur for a variety of reasons, including the installation of replacement or alternate tires or wheels on the vehicle that prevent the TPMS from functioning properly. Always check the TPMS malfunction telltale after replacing one or more tires or wheels on your vehicle to ensure that the replacement or alternate tires and wheels allow the TPMS to continue to function properly.

See *Tire Pressure Monitor Operation* on page 10-53 for additional information.

### **Federal Communications Commission (FCC) and Industry Canada**

See *Radio Frequency Statement* on page 13-16 for information regarding Part 15 of the Federal Communications Commission (FCC) Rules and RSS-210/211 of Industry Canada.

## **Tire Pressure Monitor Operation**

This vehicle may have a Tire Pressure Monitor System (TPMS). The TPMS is designed to warn the driver when a low tire pressure condition exists. TPMS sensors are mounted onto each tire and wheel assembly on the vehicle, excluding the spare tire. The TPMS sensors monitor the air pressure in the vehicle's tires and transmit the tire pressure readings to a receiver located in the vehicle.



When a low tire pressure condition is detected, the TPMS illuminates the low tire pressure warning light located on the instrument panel cluster.

If the warning light comes on, stop as soon as possible and inflate the tires to the recommended pressure shown on the tire loading information label. See *Vehicle Load Limits on page 9-27*.

At the same time, a Driver Information Center (DIC) message is displayed on the DIC display screen. The low tire pressure warning light and the DIC warning message come on at each ignition cycle until the tires are inflated to the correct inflation pressure. For additional information and details about the DIC operation and displays see *Tire Messages on page 5-25*.

The low tire pressure warning light may come on in cool weather when the vehicle is first started, and then turn off as you start to drive. This could be an early indicator that the air pressure in the tire(s) are getting low and need to be inflated to the proper pressure.

A Tire and Loading Information label, attached to the vehicle, shows the size of the vehicle's original equipment tires and the correct inflation pressure for the vehicle's tires when they are cold. See *Vehicle Load Limits on page 9-27*, for an example of the Tire and Loading Information label and its location on the vehicle. Also see *Tire Pressure on page 10-51*.

The vehicle's TPMS can warn you about a low tire pressure condition but it does not replace normal tire maintenance. See *Tire Inspection on page 10-57*, *Tire Rotation on page 10-57* and *Tires on page 10-44*.

**Notice: Liquid tire sealants could damage the Tire Pressure Monitor System (TPMS) sensors. Sensor damage caused by using a tire sealant is not covered by your warranty. Do not use liquid tire sealants.**

### TPMS Malfunction Light and Message

The TPMS will not function properly if one or more of the TPMS sensors are missing or inoperable. When the system detects a malfunction, the low tire warning light flashes for about one minute and then stays on for the remainder of the ignition cycle. A DIC warning message is also displayed. The low tire warning light and DIC warning message come on at each ignition cycle until the problem is corrected. Some of the conditions that can cause the malfunction light and DIC message to come on are:

- One of the road tires has been replaced with the spare tire. The spare tire does not have a TPMS sensor. The TPMS malfunction light and DIC message should go off once you re-install the road tire containing the TPMS sensor.



- The TPMS sensor matching process was started but not completed or not completed successfully after rotating the vehicle's tires. The DIC message and TPMS malfunction light should go off once the TPMS sensor matching process is performed successfully. See "TPMS Sensor Matching Process" later in this section.
- One or more TPMS sensors are missing or damaged. The DIC message and the TPMS malfunction light should go off when the TPMS sensors are installed and the sensor matching process is performed successfully. See your dealer/retailer for service.

- Replacement tires or wheels do not match the vehicle's original equipment tires or wheels. Tires and wheels other than those recommended for the vehicle could prevent the TPMS from functioning properly. See *Buying New Tires on page 10-59*.
- Operating electronic devices or being near facilities using radio wave frequencies similar to the TPMS could cause the TPMS sensors to malfunction.

If the TPMS is not functioning it cannot detect or signal a low tire condition. See your dealer/retailer for service if the TPMS malfunction light and DIC message comes on and stays on.

### **TPMS Sensor Matching Process**

Each TPMS sensor has a unique identification code. Any time you replace one or more of the TPMS sensors or rotate the vehicle's tires, the identification codes need to be matched to the new tire/wheel position. The sensors are matched to the tire/wheel positions in the following order: driver side front tire, passenger side front tire, passenger side rear tire, and driver side rear tire using a TPMS diagnostic tool. See your dealer/retailer for service.

The TPMS sensors can also be matched to each tire/wheel position by increasing or decreasing the tire's air pressure. If increasing the tire's air pressure, do not exceed the maximum inflation pressure indicated on the tire's sidewall. To let air-pressure out of a tire you can use the pointed end of the valve cap, a pencil-style air pressure gauge, or a key.

You have one minute to match the first tire/wheel position, and five minutes overall, to match all four tire/wheel positions. If it takes longer than one minute, to match the first tire and wheel, or more than five minutes to match all four tire and wheel positions, the matching process stops and you need to start over.

The TPMS sensor matching procedure is outlined below:

1. Set the parking brake.
2. Turn the ignition switch to ON/RUN with the engine off.
3. Turn the exterior lamp switch from AUTO to OFF four times within three seconds.  
A double horn chirp will sound and the TPMS low tire warning light starts flashing. The double horn chirp and flashing TPMS warning light indicates the TPMS matching process has started. The TPMS

warning light should continue flashing throughout the matching procedure. The LOW TIRE message displays on the Driver Information Center (DIC).

4. Start with the driver side front tire.
5. Remove the valve cap from the valve cap stem. Activate the TPMS sensor by increasing or decreasing the tire's air pressure for 10 seconds, then stop and listen for a single horn chirp. The single horn chirp should sound within 15 seconds, confirming that the sensor identification code has been matched to this tire and wheel position. If you do not hear the confirming single horn chirp, turn the ignition switch to LOCK and start over beginning with Step 2.
6. Proceed to the passenger side front tire, and repeat the procedure in Step 5.

7. Proceed to the passenger side rear tire, and repeat the procedure in Step 5.
8. Proceed to the driver side rear tire, and repeat the procedure in Step 5.
9. After hearing the confirming horn chirp for the driver side rear tire, check to see if the TPMS low tire warning light and the DIC LOW TIRE messages have turned off. If yes, the TPMS sensors have been relearned. Turn the ignition switch to LOCK/OFF.

If the low tire warning light and the SERV TPM message on the DIC are on after completing Step 5 for the driver side rear tire, the sensor relearn process has not been successful. Turn the ignition switch to LOCK/OFF and repeat the matching process beginning with Step 2.

10. Set all four tires to the recommended air pressure level as indicated on the Tire and Loading Information label.
11. Put the valve caps back on the valve stems.

## Tire Inspection

We recommend that you regularly inspect your vehicle's tires, including the spare tire, if the vehicle has one, for signs of wear or damage. See *When It Is Time for New Tires* on page 10-58 for more information.

## Tire Rotation

Tires should be rotated every 5,000 to 8,000 miles (8 000 to 13 000 km). See *Scheduled Maintenance* on page 11-2.

The purpose of a regular tire rotation is to achieve a uniform wear for all tires on the vehicle. This will ensure that the vehicle continues to perform most like it did when the tires were new. The first rotation is the most important. See *Scheduled Maintenance* on page 11-2.

Any time you notice unusual wear, rotate the tires as soon as possible and check wheel alignment. Also check for damaged tires or wheels. See *When It Is Time for New Tires* on page 10-58 and *Wheel Replacement* on page 10-63.

Make sure the spare tire is stored securely. Push, pull and then try to rotate or turn the tire. If it moves, use the wheel wrench/hoist shaft to tighten the cable. See *If a Tire Goes Flat* on page 10-64.

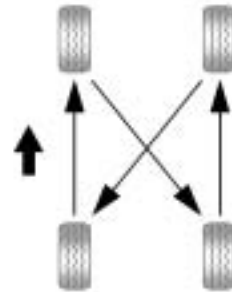

When rotating the vehicle's tires, always use the correct rotation pattern shown here. Do not include the spare tire in the tire rotation.

After the tires have been rotated, adjust the front and rear inflation pressures as shown on the Tire and Loading Information label. See *Tire Pressure* on page 10-51 and *Vehicle Load Limits* on page 9-27.

Reset the Tire Pressure Monitor System. See *Tire Pressure Monitor Operation* on page 10-53.

Make certain that all wheel nuts are properly tightened. See "Wheel Nut Torque" under *Capacities and Specifications* on page 12-2.

### **WARNING**

Rust or dirt on a wheel, or on the parts to which it is fastened, can make wheel nuts become loose after time. The wheel could come off and cause an accident. When changing a wheel, remove any rust or dirt from places where the wheel attaches to the vehicle. In an emergency, use a cloth or a paper towel to do this; but be sure to use a scraper or wire brush later, if needed, to get all the rust or dirt off. See *If a Tire Goes Flat* on page 10-64.

## When It Is Time for New Tires

Various factors, such as maintenance, temperatures, driving speeds, vehicle loading, and road conditions influence when you need new tires.

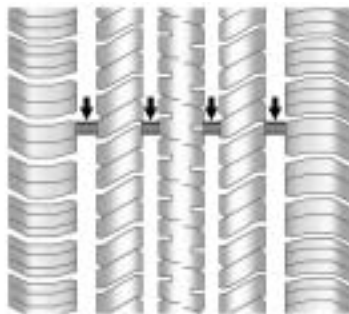

One way to tell when it is time for new tires is to check the treadwear indicators, which appear when the tires have only 1.6 mm (1/16 inch) or less of tread remaining.

The vehicle needs new tires if any of the following statements are true:

- You can see the indicators at three or more places around the tire.
- You can see cord or fabric showing through the tire's rubber.
- The tread or sidewall is cracked, cut, or snagged deep enough to show cord or fabric.
- The tire has a bump, bulge, or split.
- The tire has a puncture, cut, or other damage that cannot be repaired well because of the size or location of the damage.

The rubber in tires degrades over time. This is also true for the spare tire, if the vehicle has one, even if it is not being used. Multiple conditions affect how fast this aging takes place, including temperatures, loading conditions, and inflation pressure maintenance. With proper care and maintenance tires typically wear out before they degrade due to age. If you are unsure about the need to replace the tires as they get older, consult the tire manufacturer for more information.

## Buying New Tires

GM has developed and matched specific tires for your vehicle. The original equipment tires installed on your vehicle, when it was new, were designed to

meet General Motors Tire Performance Criteria Specification (TPC spec) system rating. If you need replacement tires, GM strongly recommends that you get tires with the same TPC Spec rating. This way, your vehicle will continue to have tires that are designed to give the same performance and vehicle safety, during normal use, as the original tires.

GM's exclusive TPC Spec system considers over a dozen critical specifications that impact the overall performance of your vehicle, including brake system performance, ride and handling, traction control, and

tire pressure monitoring performance. GM's TPC Spec number is molded onto the tire's sidewall near the tire size. If the tires have an all-season tread design, the TPC spec number will be followed by a MS, for mud and snow. See *Tire Sidewall Labeling on page 10-44* for additional information.

GM recommends replacing tires in sets of four. This is because uniform tread depth on all tires will help keep your vehicle performing most like it did when the tires were new. Replacing less than a full set of tires can affect the braking and handling performance of your vehicle.

See *Tire Inspection* on page 10-57 and *Tire Rotation* on page 10-57 for information on proper tire rotation.

### **WARNING**

Mixing tires could cause you to lose control while driving. If you mix tires of different sizes, brands, or types (radial and bias-belted tires) the vehicle may not handle properly, and you could have a crash. Using tires of different sizes, brands, or types may also cause damage to your vehicle. Be sure to use the correct size, brand, and type of tires on your vehicle's wheels.

### **WARNING**

If you use bias-ply tires on the vehicle, the wheel rim flanges could develop cracks after many miles of driving. A tire and/or wheel could fail suddenly, causing a crash. Use only radial-ply tires with the wheels on the vehicle.

If you must replace your vehicle's tires with those that do not have a TPC Spec number, make sure they are the same size, load range, speed rating, and construction type (radial and bias-belted tires) as your vehicle's original tires.

Vehicles equipped with a tire pressure monitoring system may give an inaccurate low-pressure warning if non-TPC spec rated tires are installed on your vehicle. Non-TPC Spec rated

tires may give a low-pressure warning that is higher or lower than the proper warning level you would get with TPC Spec rated tires. See *Tire Pressure Monitor System* on page 10-52.

Your vehicle's original equipment tires are listed on the Tire and Loading Information Label. See *Vehicle Load Limits* on page 9-27, for more information about the Tire and Loading Information Label and its location on your vehicle.

## **Different Size Tires and Wheels**

If you add wheels or tires that are a different size than your original equipment wheels and tires, this could affect the way your vehicle performs, including its braking, ride and handling characteristics, stability, and resistance to rollover.

Additionally, if your vehicle has electronic systems such as anti-lock brakes, rollover airbags, traction control, and electronic stability control, the performance of these systems can be affected.

 **WARNING**

If you add different sized wheels, your vehicle may not provide an acceptable level of performance and safety if tires not recommended for those wheels are selected. You may increase the chance that you will crash and suffer serious injury. Only use Hummer specific wheel and tire systems developed for your vehicle, and have them properly installed by a GM certified technician.

See *Buying New Tires on page 10-59* and *Accessories and Modifications on page 10-3* for additional information.

## Uniform Tire Quality Grading

Quality grades can be found where applicable on the tire sidewall between tread shoulder and maximum section width. For example:

### Treadwear 200 Traction AA Temperature A

The following information relates to the system developed by the United States National Highway Traffic Safety Administration (NHTSA), which grades tires by treadwear, traction, and temperature performance. This applies only to vehicles sold in the United States. The grades are molded on the sidewalls of most passenger car tires. The Uniform Tire Quality Grading (UTQG) system does not apply to deep tread, winter-type snow tires,

space-saver, or temporary use spare tires, tires with nominal rim diameters of 10 to 12 inches (25 to 30 cm), or to some limited-production tires.

While the tires available on Hummer light trucks may vary with respect to these grades, they must also conform to federal safety requirements and additional General Motors Tire Performance Criteria (TPC) standards.

All Passenger Car Tires Must Conform to Federal Safety Requirements In Addition To These Grades.

### Treadwear

The treadwear grade is a comparative rating based on the wear rate of the tire when tested under controlled conditions on a specified government test course.

For example, a tire graded 150 would wear one and a half (1½) times as well on the government course as a tire graded 100. The relative performance of tires depends upon the actual conditions of their use, however, and may depart significantly from the norm due to variations in driving habits, service practices and differences in road characteristics and climate.

### **Traction – AA, A, B, C**

The traction grades, from highest to lowest, are AA, A, B, and C. Those grades represent the tire's ability to stop on wet pavement as measured under controlled conditions on specified government test surfaces of asphalt and concrete. A tire marked C may have poor traction performance.

**Warning:** The traction grade assigned to this tire is based on straight-ahead braking traction tests, and does not include acceleration, cornering, hydroplaning, or peak traction characteristics.

### **Temperature – A, B, C**

The temperature grades are A (the highest), B, and C, representing the tire's resistance to the generation of heat and its ability to dissipate heat when tested under controlled conditions on a specified indoor laboratory test wheel. Sustained high temperature can cause the material of the tire to degenerate and reduce tire life, and excessive temperature can lead to sudden tire failure. The grade C corresponds to a level of performance which all passenger car tires must meet under the Federal Motor Safety

Standard No. 109. Grades B and A represent higher levels of performance on the laboratory test wheel than the minimum required by law. **Warning:** The temperature grade for this tire is established for a tire that is properly inflated and not overloaded. Excessive speed, underinflation, or excessive loading, either separately or in combination, can cause heat buildup and possible tire failure.

### **Wheel Alignment and Tire Balance**

The tires and wheels on the vehicle were aligned and balanced carefully at the factory to give the longest tire life and best overall performance. Adjustments to wheel alignment and tire balancing will not be necessary on a regular basis. However, if there is unusual tire wear or the vehicle pulls to one side or the other, the alignment should be checked.



If the vehicle vibrates when driving on a smooth road, the tires and wheels might need to be rebalanced. See your dealer for proper diagnosis.

## Wheel Replacement

Replace any wheel that is bent, cracked, or badly rusted or corroded. If wheel nuts keep coming loose, the wheel, wheel bolts, and wheel nuts should be replaced. If the wheel leaks air, replace it (except some aluminum wheels, which can sometimes be repaired). See your dealer if any of these conditions exist.

Your dealer will know the kind of wheel you need.

Each new wheel should have the same load-carrying capacity, diameter, width, offset, and be mounted the same way as the one it replaces.

If you need to replace any of the wheels, wheel bolts, wheel nuts, or Tire Pressure Monitor System (TPMS) sensors, replace them only with new GM original equipment parts. This way, you will be sure to have the right wheel, wheel bolts, wheel nuts, and TPMS sensors for the vehicle.

### WARNING

Using the wrong replacement wheels, wheel bolts, or wheel nuts on your vehicle can be dangerous. It could affect the braking and handling of your vehicle, make your tires lose air and make you lose control. You could have a collision in which you or others could be injured. Always use the correct wheel, wheel bolts, and wheel nuts for replacement.

**Notice:** The wrong wheel can also cause problems with bearing life, brake cooling, speedometer or odometer calibration, headlamp aim, bumper height, vehicle ground clearance, and tire or tire chain clearance to the body and chassis.

See *If a Tire Goes Flat* on page 10-64 for more information.

## Used Replacement Wheels

### WARNING

Putting a used wheel on the vehicle is dangerous. You cannot know how it has been used or how far it has been driven. It could fail suddenly and cause a crash. If you have to replace a wheel, use a new GM original equipment wheel.

## Tire Chains

 **WARNING**

If your vehicle has LT285/75R16 or P265/65R18 size tires, do not use tire chains. They can damage your vehicle because there is not enough clearance. Tire chains used on a vehicle without the proper amount of clearance can cause damage to the brakes, suspension, or other vehicle parts. The area damaged by the tire chains could cause you to lose control of your vehicle and you or others may be injured in a crash.

Use another type of traction device only if its manufacturer recommends it for use on your vehicle and tire size combination and road conditions. Follow that manufacturer's instructions.

(Continued)

**WARNING (Continued)**

To help avoid damage to your vehicle, drive slowly, readjust, or remove the device if it is contacting your vehicle, and do not spin your vehicle's wheels.

If you do find traction devices that will fit, install them on the rear tires.

**Notice:** If your vehicle has a tire size other than LT285/75R16 or P265/65R18 use tire chains only where legal and only when you must. Use chains that are the proper size for your tires. Install them on the tires of the rear axle. Do not use chains on the tires of the front axle. Tighten them as tightly as possible with the ends securely fastened. Drive slowly and follow the chain manufacturer's instructions.

If you can hear the chains contacting your vehicle, stop and retighten them. If the contact continues, slow down until it stops. Driving too fast or spinning the wheels with chains on will damage your vehicle.

### If a Tire Goes Flat

It is unusual for a tire to blowout while you are driving, especially if you maintain your vehicle's tires properly. If air goes out of a tire, it is much more likely to leak out slowly. But if you should ever have a blowout, here are a few tips about what to expect and what to do:

If a front tire fails, the flat tire creates a drag that pulls the vehicle toward that side. Take your foot off the accelerator pedal and grip the steering wheel firmly. Steer to maintain lane position, and then gently brake to a stop well out of the traffic lane.

A rear blowout, particularly on a curve, acts much like a skid and may require the same correction you would use in a skid. In any rear blowout remove your foot from the accelerator pedal. Get the vehicle under control by steering the way you want the vehicle to go. It may be very bumpy and noisy, but you can still steer. Gently brake to a stop, well off the road if possible.

 **WARNING**

Lifting a vehicle and getting under it to do maintenance or repairs is dangerous without the appropriate safety equipment and training. If a jack is provided with the vehicle, it is designed only for changing a flat tire. If it is used for anything else, you or others could be badly injured or killed if the vehicle slips off the jack. If a jack is provided with the vehicle, only use it for changing a flat tire.

If a tire goes flat, avoid further tire and wheel damage by driving slowly to a level place. Turn on your hazard warning flashers. See *Hazard Warning Flashers* on page 6-5.

 **WARNING**

Changing a tire can be dangerous. The vehicle can slip off the jack and roll over or fall on you or other people. You and they could be badly injured or even killed. Find a level place to change your tire. To help prevent the vehicle from moving:

1. Set the parking brake firmly.
2. Put the shift lever in P (Park).
3. If you have a four-wheel-drive vehicle, be sure the transfer case is in a drive gear – not in N (Neutral).

(Continued)

**WARNING (Continued)**

4. Turn off the engine and do not restart while the vehicle is raised.
5. Do not allow passengers to remain in the vehicle.

To be even more certain the vehicle will not move, put blocks at the front and rear of the tire farthest away from the one being changed. That would be the tire on the other side, at the opposite end of the vehicle.

When the vehicle has a flat tire, the wheel blocks need to be set up before changing it. The wheel blocks are located in the tool bag in the swing-gate for H3 models or below the rear seat for H3T models.

## 10-66 Vehicle Care

See *Tire Changing (H3T)* on page 10-66 or *Tire Changing (H3)* on page 10-75 for more information.



To use the wheel blocks, lift the wheel block and lock it into place.

Use the following example as a guide to assist in the placement of the wheel blocks (A) when the vehicle has a flat tire (B).

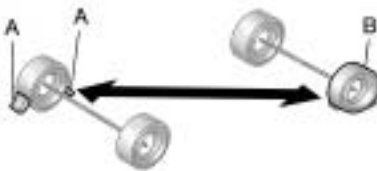

A. Wheel Block

B. Flat Tire

The following information explains how to use the jack and change a tire.

## Tire Changing (H3T)

### Removing the Spare Tire and Tools

To access the jack and tools located under the rear seat:

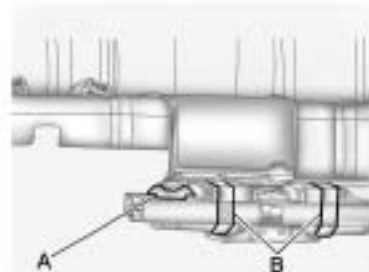

1. Turn the wing nut (A) counterclockwise to release the jack and tools.
2. Remove the jack and tool kit from the bracket.
3. Release the straps (B) that secure the tool bag to the jack.

The following tools are used to remove the spare tire and flat tire.

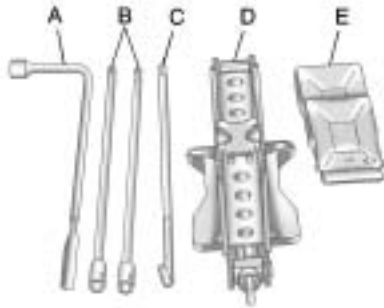

- A. Wheel Wrench
- B. Jack Handle Extensions
- C. Jack Handle
- D. Jack
- E. Wheel Blocks

To access the spare tire:

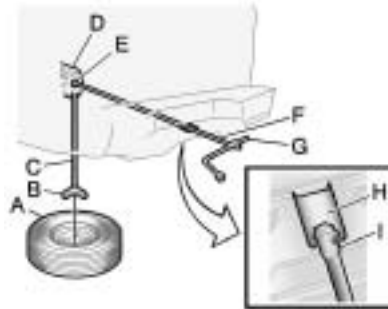

- A. Spare Tire/Flat Tire (Valve Stem Pointed Down)
- B. Tire/Wheel Retainer
- C. Hoist Cable
- D. Hoist Assembly
- E. Hoist Shaft
- F. Jack Handle Extension(s)
- G. Wheel Wrench
- H. Hoist Shaft Access Ramp
- I. Hoist End of the Extension Tool

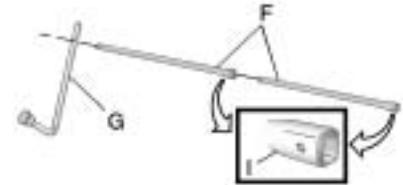

1. Assemble the two jack handle extensions (F) and wheel wrench (G).

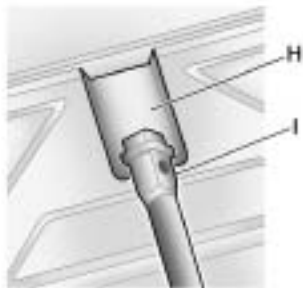

2. Insert the hoist end of the extension tool (I) through the hoist shaft access ramp (H).

3. The hoist end of the extension tool (I) must connect to the hoist shaft (E). The hoist end of the extension tool is used to lower the spare tire.

Do not use the chiseled end of the wheel wrench.

4. Turn the wheel wrench (G) counterclockwise to lower the spare tire (A) to the ground. Continue to turn the wheel wrench until the spare tire (A) can be pulled from under the vehicle.

If the spare tire does not lower to the ground, the secondary latch is engaged. See *Secondary Latch System* on page 10-84.

5. Pull the spare tire towards you.



6. Tilt the tire, with slack in the cable, to access the tire/wheel retainer (B).



7. Separate the retainer from the guide pin by sliding the retainer up the pin while pressing down on the latch. When the retainer is separated from the guide pin, tilt the retainer and pull it through the center of the wheel along with the cable and guide pin.
8. Put the spare tire near the flat tire.

### Removing the Flat Tire and Installing the Spare Tire

1. Do a safety check before proceeding. See *If a Tire Goes Flat* on page 10-64 for more information.



2. Remove the center cap by placing the flat end of the wheel wrench in the slot on the wheel and gently pry the center cap out.



3. Turn the wheel wrench counterclockwise to loosen the wheel nuts. Do not remove them yet.  
  
If the vehicle has locking lug nuts, the key is supplied in the tool bag. Use the key along with the wheel wrench to remove the wheel nuts from the tire.  
  
Now jack up the vehicle.



**Jacking Locations (Overall View)**

- A. Front Position - Lower Control Arm
  - B. Rear Position - Lower Axle
4. Locate the vehicle's jacking positions (A and B).

5. Assemble the jack and tools as follows:

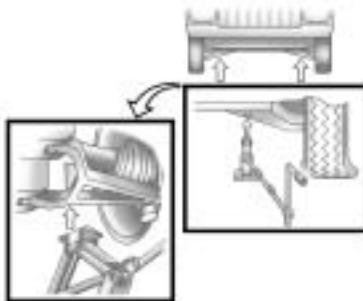

**Front Position**

**Front Tire Flat:** If the flat tire is on a front tire of the vehicle, use the jack handle and both jack handle extensions. Attach the wheel wrench to the jack handle extensions. Attach the jack handle to the jack.

From the front of the vehicle position the jack on the front lower control arm along the bar that runs front to back. Turn the wheel wrench clockwise to raise the vehicle. Raise the vehicle far enough off the ground so there is enough room for the spare tire to clear the ground.

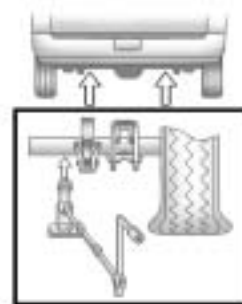

**Rear Positions**

Refer to the graphic above to locate the placement of the jack if the flat tire is on the rear of the vehicle.





**Rear Tire Flat:** Use the jack handle and both jack handle extensions. Attach the wheel wrench to the jack extensions. Attach the jack handle to the jack. From the rear of the vehicle align the jack under the rear axle. Turn the wheel wrench clockwise to raise the vehicle. Raise the vehicle far enough off the ground so there is enough room for the spare tire to clear the ground.

6. Turn the wheel wrench clockwise to raise the jack head to the lifting point.

**⚠ WARNING**

Getting under a vehicle when it is jacked up is dangerous. If the vehicle slips off the jack, you could be badly injured or killed. Never get under a vehicle when it is supported only by a jack.

**⚠ WARNING**

Raising your vehicle with the jack improperly positioned can damage the vehicle and even make the vehicle fall. To help avoid personal injury and vehicle damage, be sure to fit the jack lift head into the proper location before raising the vehicle.

7. Remove all the wheel nuts and take off the flat tire.

**⚠ WARNING**

Rust or dirt on a wheel, or on the parts to which it is fastened, can make wheel nuts become loose after time. The wheel could come off and cause an accident. When changing a wheel, remove any rust or dirt from places where the wheel attaches to the vehicle. In an emergency, use a cloth or a paper towel to do this; but be sure to use a scraper or wire brush later, if needed, to get all the rust or dirt off. See *If a Tire Goes Flat* on page 10-64.

8. Remove any rust or dirt from the wheel bolts, mounting surfaces and spare wheel.

### WARNING

Never use oil or grease on bolts or nuts because the nuts might come loose. The vehicle's wheel could fall off, causing a crash.

- Put the spare tire on the mounting surface.
- Put the wheel nuts back on with the rounded end of the nuts toward the wheel after mounting the spare.
- Tighten each wheel nut by hand. Then use the wheel wrench to tighten the nuts until the wheel is held against the hub.
- Turn the wheel wrench counterclockwise to lower the vehicle. Lower the jack completely.

### WARNING

Wheel nuts that are improperly or incorrectly tightened can cause the wheels to become loose or come off. The wheel nuts should be tightened with a torque wrench to the proper torque specification after replacing. Follow the torque specification supplied by the aftermarket manufacturer when using accessory locking wheel nuts. See *Capacities and Specifications* on page 12-2 for original equipment wheel nut torque specifications.

**Notice:** Improperly tightened wheel nuts can lead to brake pulsation and rotor damage. To avoid expensive brake repairs, evenly tighten the wheel nuts in the proper sequence and to the proper torque specification. See *Capacities and Specifications* on page 12-2 for the wheel nut torque specification.



- Tighten the nuts firmly in a crisscross sequence as shown by turning the wheel wrench clockwise.
- After installing the wheel and tire, reinstall the center cap. Place the cap on the wheel and tap it into place until it sits flush with the wheel.

## Storing a Flat or Spare Tire and Tools

**⚠ WARNING**

Storing a jack, a tire, or other equipment in the passenger compartment of the vehicle could cause injury. In a sudden stop or collision, loose equipment could strike someone. Store all these in the proper place.

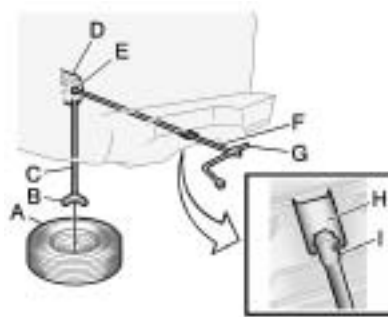

- A. Spare Tire/Flat Tire (Valve Stem Pointed Down)
- B. Tire/Wheel Retainer
- C. Hoist Cable
- D. Hoist Assembly
- E. Hoist Shaft
- F. Jack Handle Extension(s)
- G. Wheel Wrench
- H. Hoist Shaft Access Ramp
- I. Hoist End of the Extension Tool

To store the flat or spare tire on the spare tire mount:

1. Place the flat or spare tire (A) on the ground at the rear of the vehicle with the valve stem pointed down and to the rear.





2. Tilt the tire. Separate the tire/wheel retainer (B) from the guide pin. Pull the pin through the center of the wheel. Tilt the tire/wheel retainer (B) down through the center wheel opening.
3. Make sure the tire/wheel retainer (B) is fully seated across the underside of the wheel.

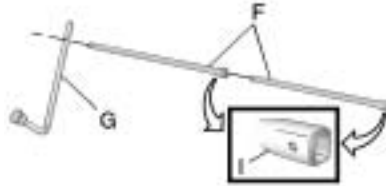

4. Assemble the two jack handle extensions (F) and wheel wrench (G).



5. Insert the hoist end of the extension tool (I) through the hoist shaft access ramp (H).
6. Raise the tire part upward. Make sure the tire/wheel retainer (B) is seated in the wheel opening.
7. Raise the tire fully against the underside of the vehicle by turning the wheel wrench clockwise until you hear two clicks or feel it skip twice. You cannot overtighten the cable.



8. Push, pull (A) and then try to turn (B) the tire. If the tire moves, use the wheel wrench to tighten the cable.

To store the jack tool bag and jack:

1. Return the tools to the jack tool bag.
2. Secure the tool bag to the jack by securely wrapping the straps around the jack. Then, slide the straps through the rings on the bag and secure.



3. Reinstall the wing nut retainer to fasten the jack and tool bag under the rear seat.

Make sure that the wing nut passes through the tool bag and the jack before tightening it.

4. Turn the wing nut retainer clockwise to secure.

## Tire Changing (H3)

### Removing the Spare Tire and Tools

The equipment needed is located in the swing-gate, behind a cover. To remove the equipment:

1. Open the tailgate. See *Tailgate on page 2-7*.
2. Lift the two latches, located on the inside of the tailgate, to remove the cover.

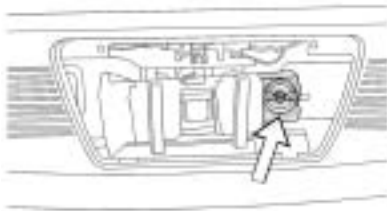

3. Turn the wing nut counterclockwise to release the jack tool bag and jack and remove them.
4. Release the straps that secure the jack tool bag to the jack.

5. Open the tool bag to find the following tools, which are used to remove the spare tire and flat tire:

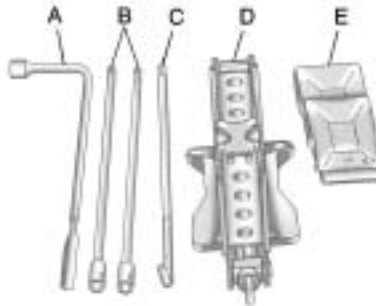

- A. Wheel Wrench
- B. Jack Handle Extensions
- C. Jack Handle
- D. Jack
- E. Wheel Blocks

The spare tire is attached to the outside of the tailgate. To remove the spare tire:



1. If the vehicle has a spare tire cover release the latch by pulling the latch straight back and turning it away from the cover at the same time.

**Notice:** Opening the endgate before completely closing and latching the spare tire cover may result in damage to your vehicle. Close and latch the spare tire cover before opening the endgate to avoid possible damage.



2. Remove the center cap, if equipped, by placing the flat end of the wheel wrench in the slot on the wheel and gently pry the center cap out.



3. Use the wheel wrench to remove the wheel nuts securing the spare tire.  
If the vehicle has locking lug nuts, the key is supplied in the tool bag. Use the key along with the wheel wrench to remove the wheel nuts from the tire.
4. You may need assistance to remove the spare tire. Pull off and gently lower the spare tire to the ground. Set it next to the flat tire.

### Removing the Flat Tire and Installing the Spare Tire

1. Do a safety check before proceeding. See *If a Tire Goes Flat* on page 10-64 for more information.



2. Remove the center cap by placing the flat end of the wheel wrench in the slot on the wheel and gently pry the center cap out.



3. Turn the wheel wrench counterclockwise to loosen the wheel nuts. Do not remove them yet.

If the vehicle has locking lug nuts, the key is supplied in the tool bag. Use the key along with the wheel wrench to remove the wheel nuts from the tire.

Now jack up the vehicle.



**Jacking Locations (Overall View)**

- A. Front Position - Lower Control Arm
  - B. Rear Position - Lower Axle
4. Locate the vehicle's jacking positions (A and B).

5. Assemble the jack and tools as follows:

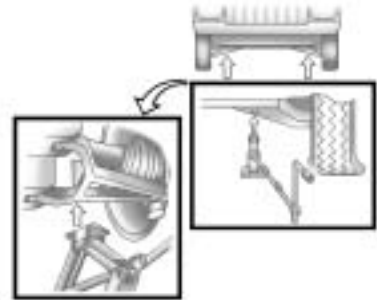

**Front Position**

**Front Tire Flat:** If the flat tire is on a front tire of the vehicle, use the jack handle and both jack handle extensions. Attach the wheel wrench to the jack handle extensions. Attach the jack handle to the jack. From the front of the vehicle position the jack on the front lower control arm along the bar that runs front to back. Turn the wheel wrench clockwise to raise the vehicle.



Raise the vehicle far enough off the ground so there is enough room for the spare tire to clear the ground.

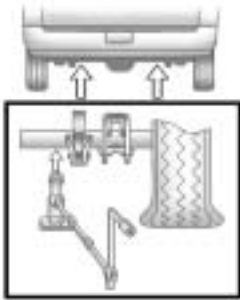

**Rear Positions**

Refer to the graphic above to locate the placement of the jack if the flat tire is on the rear of the vehicle.



**Rear Tire Flat:** Use the jack handle and both jack handle extensions. Attach the wheel wrench to the jack extensions. Attach the jack handle to the jack. From the rear of the vehicle align the jack under the rear axle. Turn the wheel wrench clockwise to raise the vehicle. Raise the vehicle far enough off the ground so there is enough room for the spare tire to clear the ground.

6. Turn the wheel wrench clockwise to raise the jack head to the lifting point.

**⚠ WARNING**

Getting under a vehicle when it is jacked up is dangerous. If the vehicle slips off the jack, you could be badly injured or killed. Never get under a vehicle when it is supported only by a jack.

**⚠ WARNING**

Raising your vehicle with the jack improperly positioned can damage the vehicle and even make the vehicle fall. To help avoid personal injury and vehicle damage, be sure to fit the jack lift head into the proper location before raising the vehicle.

7. Remove all the wheel nuts and take off the flat tire.

 **WARNING**

Rust or dirt on a wheel, or on the parts to which it is fastened, can make wheel nuts become loose after time. The wheel could come off and cause an accident. When changing a wheel, remove any rust or dirt from places where the wheel attaches to the vehicle. In an emergency, use a cloth or a paper towel to do this; but be sure to use a scraper or wire brush later, if needed, to get all the rust or dirt off. See *If a Tire Goes Flat on page 10-64*.

8. Remove any rust or dirt from the wheel bolts, mounting surfaces and spare wheel.

 **WARNING**

Never use oil or grease on bolts or nuts because the nuts might come loose. The vehicle's wheel could fall off, causing a crash.

9. Put the spare tire on the mounting surface.
10. Put the wheel nuts back on with the rounded end of the nuts toward the wheel after mounting the spare.

11. Tighten each wheel nut by hand. Then use the wheel wrench to tighten the nuts until the wheel is held against the hub.
12. Turn the wheel wrench counterclockwise to lower the vehicle. Lower the jack completely.

**⚠ WARNING**

Wheel nuts that are improperly or incorrectly tightened can cause the wheels to become loose or come off. The wheel nuts should be tightened with a torque wrench to the proper torque specification after replacing. Follow the torque specification supplied by the aftermarket manufacturer when using accessory locking wheel nuts. See *Capacities and Specifications on page 12-2* for original equipment wheel nut torque specifications.

**Notice:** Improperly tightened wheel nuts can lead to brake pulsation and rotor damage. To avoid expensive brake repairs, evenly tighten the wheel nuts in the proper sequence and to the proper torque specification. See *Capacities and Specifications on page 12-2* for the wheel nut torque specification.



13. Tighten the nuts firmly in a crisscross sequence as shown by turning the wheel wrench clockwise.
14. After installing the wheel and tire, reinstall the center cap. Place the cap on the wheel and tap it into place until it sits flush with the wheel.

### Storing a Flat or Spare Tire and Tools

#### WARNING

Storing a jack, a tire, or other equipment in the passenger compartment of the vehicle could cause injury. In a sudden stop or collision, loose equipment could strike someone. Store all these in the proper place.

To store the flat or spare tire on the spare tire mount:

1. Slide the flat or spare tire onto the swing-gate.  
You may need assistance to do this.
2. Reinstall the nuts to retain the flat or spare tire.
3. Tighten the nuts by hand.

#### WARNING

Wheel nuts that are improperly or incorrectly tightened can cause the wheels to become loose or come off. The wheel nuts should be tightened with a torque wrench to the proper torque specification after replacing. Follow the torque specification supplied by the aftermarket manufacturer when using accessory locking wheel nuts. See *Capacities and Specifications* on page 12-2 for original equipment wheel nut torque specifications.



4. Use the wheel wrench to tighten the nuts firmly. Try to move the tire back and forth slightly to be sure it is secure.
5. Reinstall the center tire cover onto the spare or flat tire.
6. If the vehicle has a spare tire cover close the cover and latch the side latch.

To store the jack tool bag and jack:

1. Return the tools to the jack tool bag.



2. Secure the tool bag to the jack by securely wrapping the straps around the jack. Then, slide the straps through the rings on the bag and secure.

3. Position the jack and jack tool bag in the swing-gate.

When reinstalling the jack and jack tool bag, make sure the jack base is securely seated behind the tabs in the swing-gate.

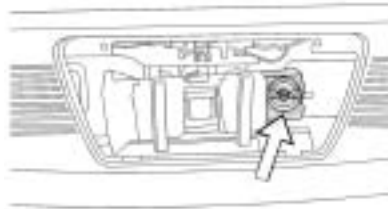

4. Reinstall the wing nut retainer to fasten the jack and tool bag in the storage compartment.

Make sure that the wing nut passes through the tool bag and the jack before tightening it.

5. Turn the wing nut retainer clockwise to secure.
6. Reinstall the compartment cover by inserting the locator tabs in the holes in the swing-gate. Push the latches down to secure.

### Secondary Latch System

This vehicle has an underbody mounted tire hoist assembly that has a secondary latch system. It is designed to stop the spare tire from suddenly falling off the vehicle if the cable holding the spare tire is damaged. For the secondary latch to work, the tire must be stowed with the valve stem pointing down. See *Tire Changing (H3T)* on page 10-66 or *Tire Changing (H3)* on page 10-75 for instructions on storing the spare tire correctly.

#### **WARNING**

Before beginning this procedure read all the instructions. Failure to read and follow the instructions could damage the hoist assembly and you and others could get hurt. Read and follow the instructions listed next.

To release the spare tire from the secondary latch:

#### **WARNING**

Someone standing too close during the procedure could be injured by the jack. If the spare tire does not slide off the jack completely, make sure no one is behind you or on either side of you as you pull the jack out from under the spare.

1. If the cable is not visible, start this procedure at Step 3.

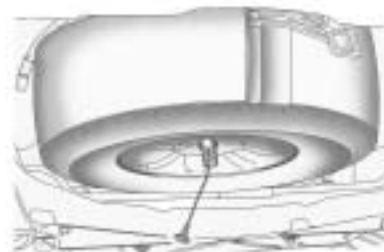

2. Turn the lug wrench counterclockwise until approximately 6 inches (15 cm) of cable is exposed.
3. Attach the lug wrench to the jack and raise the jack at least 10 turns.
4. Place the jack under the vehicle, ahead of the rear bumper. Position the center lift point of the jack under the center of the spare tire.

5. Turn the lug wrench clockwise to raise the jack until it lifts the secondary latch spring.
6. Keep raising the jack until the spare tire stops moving upward and is held firmly in place. This lets you know that the secondary latch has released and the spare tire is balancing on the jack.



7. Lower the jack by turning the lug wrench counterclockwise. Keep lowering the jack until the spare tire slides off the jack.



8. Disconnect the lug wrench from the jack and carefully remove the jack. Use one hand to push against the spare tire while firmly pulling the jack out from under the spare tire with the other hand.

9. Tilt the retainer and slip it through the wheel opening when the spare tire has been completely lowered.
10. Turn the lug wrench clockwise to raise the cable back up if the cable is hanging.

Have the hoist shaft assembly inspected as soon as you can. You will not be able to store a spare tire using the hoist assembly until it has been repaired or replaced.

### Full-Size Spare Tire

The vehicle, when new, had a fully-inflated spare tire. A spare tire may lose air over time, so check its inflation pressure regularly. See *Tire Pressure* on page 10-51 and *Vehicle Load Limits* on page 9-27 for information regarding proper tire inflation and loading your vehicle. For instruction on how to remove, install or store a spare tire, see *Tire Changing (H3T)* on page 10-66 or *Tire Changing (H3)* on page 10-75.

After installing the spare tire on your vehicle, you should stop as soon as possible and make sure the spare is correctly inflated.

The spare tire does not have a Tire Pressure Monitor System sensor. You may get a low pressure warning light. See *Tire Pressure Monitor Operation on page 10-53*. Have the damaged or flat road tire repaired or replaced as soon as you can.

Do not mix tires and wheels of different sizes, because they will not fit. Keep your spare tire and its wheel together.

### Jump Starting

If the vehicle's battery has run down, you may want to use another vehicle and some jumper cables to start your vehicle. Be sure to use the following steps to do it safely.

#### **WARNING**

Batteries can hurt you. They can be dangerous because:

- They contain acid that can burn you.
- They contain gas that can explode or ignite.
- They contain enough electricity to burn you.

If you do not follow these steps exactly, some or all of these things can hurt you.

**Notice:** Ignoring these steps could result in costly damage to the vehicle that would not be covered by the warranty.

**Trying to start the vehicle by pushing or pulling it will not work, and it could damage the vehicle.**

1. Check the other vehicle. It must have a 12-volt battery with a negative ground system.

**Notice:** If the other vehicle's system is not a 12-volt system with a negative ground, both vehicles can be damaged. Only use vehicles with 12-volt systems with negative grounds to jump start your vehicle.

2. Get the vehicles close enough so the jumper cables can reach, but be sure the vehicles are not touching each other. If they are, it could cause a ground connection you do not want.



You would not be able to start your vehicle, and the bad grounding could damage the electrical systems.

To avoid the possibility of the vehicles rolling, set the parking brake firmly on both vehicles involved in the jump start procedure. Put an automatic transmission in P (Park) or a manual transmission in Neutral before setting the parking brake. If you have a four-wheel-drive vehicle, be sure the transfer case is not in Neutral.

**Notice: If you leave the radio or other accessories on during the jump starting procedure, they could be damaged. The repairs would not be covered by the warranty. Always turn off the radio and other accessories when jump starting the vehicle.**

3. Turn off the ignition on both vehicles. Unplug unnecessary accessories plugged into the cigarette lighter or the accessory power outlets. Turn off the radio and all lamps that are not needed. This will avoid sparks and help save both batteries. And it could save the radio!
4. Open the hoods and locate the batteries on both vehicles. You will use the positive (+) battery terminal and the remote negative (-) jump starting terminal to jump start your vehicle. To access the positive (+) battery terminal, open the terminal cover. See *Engine Compartment Overview on page 10-6* for more information on the terminal locations.

 **WARNING**

Using a match near a battery can cause battery gas to explode. People have been hurt doing this, and some have been blinded. Use a flashlight if you need more light.

Be sure the batteries have enough water. You do not need to add water to the ACDelco® battery (or batteries) installed in your new vehicle. But if a battery has filler caps, be sure the right amount of fluid is there. If it is low, add water to take care of that first. If you do not, explosive gas could be present.

Battery fluid contains acid that can burn you. Do not get it on you. If you accidentally get it in your eyes or on your skin, flush the place with water and get medical help immediately.

### **WARNING**

Fans or other moving engine parts can injure you badly. Keep your hands away from moving parts once the engine is running.

5. Check that the jumper cables do not have loose or missing insulation. If they do, you could get a shock. The vehicles could be damaged too.

Before you connect the cables, here are some basic things you should know. Positive (+) will go to positive (+) or to a remote positive (+) terminal if the vehicle has one. Negative (-) will go to a heavy, unpainted metal engine part or to a remote negative (-) terminal if the vehicle has one.

6. Do not connect positive (+) to negative (-) or you will get a short that would damage the battery and maybe other parts too. And do not connect the negative (-) cable to the negative (-) terminal on the dead battery because this can cause sparks.
6. Connect the red positive (+) cable to the positive (+) terminal of the dead battery. Use a remote positive (+) terminal if the vehicle has one.
7. Do not let the other end touch metal. Connect it to the positive (+) terminal of the good battery. Use a remote positive (+) terminal if the vehicle has one.
8. Now connect the black negative (-) cable to the negative (-) terminal of the good battery. Use a remote negative (-) terminal if the vehicle has one.

Do not let the other end touch anything until the next step. The other end of the negative (-) cable does not go to the dead battery. It goes to a heavy, unpainted metal engine part, or to a remote negative (-) terminal on the vehicle with the dead battery.

9. Connect the other end of the negative (-) cable at least 18 inches (45 cm) away from the dead battery, but not near engine parts that move. The electrical connection is just as good there, and the chance of sparks getting back to the battery is much less.

Your vehicle has a remote negative (-) terminal, marked GND (Ground), for this purpose.

10. Now start the vehicle with the good battery and run the engine for a while.
11. Try to start the vehicle that had the dead battery. If it will not start after a few tries, it probably needs service.

**Notice:** If the jumper cables are connected or removed in the wrong order, electrical shorting may occur and damage the vehicle. The repairs would not be covered by the vehicle warranty. Always connect and remove the jumper cables in the correct order, making sure that the cables do not touch each other or other metal.

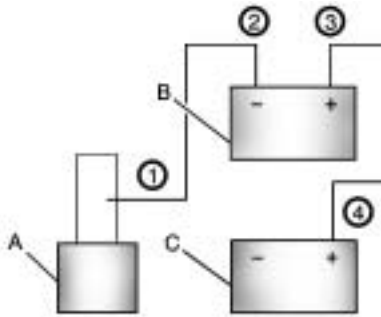

#### Jumper Cable Removal

- A. Heavy, Unpainted Metal Engine Part or Remote Negative (-) Terminal
- B. Good Battery or Remote Positive (+) and Remote Negative (-) Terminals
- C. Dead Battery or Remote Positive (+) Terminal

To disconnect the jumper cables from both vehicles, do the following:

1. Disconnect the black negative (-) cable from the vehicle that had the dead battery.
2. Disconnect the black negative (-) cable from the vehicle with the good battery.
3. Disconnect the red positive (+) cable from the vehicle with the good battery.
4. Disconnect the red positive (+) cable from the other vehicle.
5. Return the positive (+) battery terminal cover to its original position.

## Towing

### Towing the Vehicle

To avoid damage, the disabled vehicle should be towed with all four wheels off the ground. Consult your dealer or a professional towing service if the disabled vehicle must be towed. See *Roadside Service on page 13-5*.

To tow the vehicle behind another vehicle for recreational purposes — such as behind a motorhome, see “Recreational Vehicle Towing” following.

### Recreational Vehicle Towing

Recreational vehicle towing means towing the vehicle behind another vehicle – such as behind a motorhome. The two most common types of recreational vehicle towing are known as “dinghy towing” — towing the vehicle with all four wheels on the ground, and

“dolly towing” — towing the vehicle with two wheels on the ground and two wheels up on a device known as a “dolly”.

Here are some important things to consider before recreational vehicle towing:

- What is the towing capacity of the tow vehicle? Be sure to read the tow vehicle manufacturer’s recommendations.
- What is the distance that will be travelled? Some vehicles have restrictions on how far and how long they can tow.
- Is the proper towing equipment going to be used? See your dealer or trailering professional for additional advice and equipment recommendations.
- Is the vehicle ready to be towed? Just as preparing the vehicle for a long trip, make sure the vehicle is prepared to be towed.

### Dinghy Towing



This full-time four-wheel-drive vehicle can be dinghy towed from the front. These vehicles can also be towed by placing them on a platform trailer with all four wheels off the ground. These vehicles cannot be towed using a dolly.

Use the following procedure to tow the vehicle:

1. Put the transmission in P (Park) for an automatic transmission or in 1 (First) for a manual transmission.
2. Turn the engine off, but leave the ignition in ACC/ACCESSORY.
3. Firmly set the parking brake.
4. Securely attach the vehicle being towed to the tow vehicle.

**⚠ WARNING**

Shifting a full-time four-wheel-drive vehicle's transfer case into N (Neutral) can cause the vehicle to roll even if the automatic transmission is in P (Park) or the manual transmission is in any gear. You or others could be injured. Make sure the parking brake is firmly set before the transfer case is shifted to N (Neutral).

5. Shift the transfer case to N (Neutral). See *Four-Wheel Drive* on page 9-46 for the proper procedure to select the N (Neutral) position for the vehicle.
6. Release the parking brake only after the vehicle being towed is firmly attached to the tow vehicle.
7. Make sure the ignition is in ACC/ACCESSORY.

When towing the vehicle for extended periods of time, start the vehicle as often as possible to prevent battery drain. This should only be done when the tow vehicle is parked.

After towing, see "Shifting Out of NEUTRAL" under *Four-Wheel Drive* on page 9-46.

**Dolly Towing**



**Notice:** Dolly towing the vehicle will damage drivetrain components. Do not dolly tow the vehicle.

The vehicle cannot be dolly towed. If the vehicle must be towed behind another vehicle, use the dinghy towing procedure explained previously.

## Appearance Care

### Exterior Care

#### Cleaning Exterior Lamps/ Lenses

Use only lukewarm or cold water, a soft cloth and a car washing soap to clean exterior lamps and lenses. Follow instructions under "Washing the Vehicle" later in this section.

#### Finish Care

Occasional waxing or mild polishing of the vehicle by hand may be necessary to remove residue from the paint finish. Approved cleaning products can be obtained from your dealer.

If the vehicle has a basecoat/clearcoat paint finish, the clearcoat gives more depth and gloss to the colored basecoat. Always use waxes and polishes that are non-abrasive and made for a basecoat/clearcoat paint finish.

**Notice: Machine compounding or aggressive polishing on a basecoat/clearcoat paint finish may damage it. Use only non-abrasive waxes and polishes that are made for a basecoat/clearcoat paint finish on the vehicle.**

Foreign materials such as calcium chloride and other salts, ice melting agents, road oil and tar, tree sap, bird droppings, chemicals from industrial chimneys, etc., can damage the vehicle's finish if they remain on painted surfaces. Wash the vehicle as soon as possible. If necessary, use non-abrasive cleaners that are marked safe for painted surfaces to remove foreign matter.

Exterior painted surfaces are subject to aging, weather and chemical fallout that can take their toll over a period of years. To keep the paint finish looking new, keep the vehicle garaged or covered whenever possible.

#### Protecting Exterior Bright Metal Parts

Bright metal parts should be cleaned regularly to keep their luster. Wash with water or use chrome polish on chrome or stainless steel trim, if necessary.

Use special care with aluminum trim. To avoid damaging protective trim, never use auto or chrome polish, steam or caustic soap to clean aluminum. A coating of wax, rubbed to high polish, is recommended for all bright metal parts.

## Washing the Vehicle

To preserve the vehicle's finish, keep it clean by washing it often.

Do not wash the vehicle in direct sunlight and use a car washing soap.

**Notice: Certain cleaners contain chemicals that can damage the emblems or nameplates on the vehicle. Check the cleaning product label. If it states that it should not be used on plastic parts, do not use it on the vehicle or damage may occur and it would not be covered by the warranty.**

Do not use cleaning agents that are petroleum based or that contain acid or abrasives, as they can damage the paint, metal or plastic on the vehicle. Approved cleaning products can be obtained from your dealer. Follow all manufacturer directions regarding correct product usage, necessary safety

precautions and appropriate disposal of any vehicle care product.

Rinse the vehicle well, before washing and after to remove all cleaning agents completely. If they are allowed to dry on the surface, they could stain.

Dry the finish with a soft, clean chamois or an all-cotton towel to avoid surface scratches and water spotting.

High pressure car washes could cause water to enter the vehicle. Avoid using high pressure washes closer than 30 cm (12 inches) to the surface of the vehicle. Use of power washers exceeding 8,274 kPa (1,200 psi) can result in damage or removal of paint and decals.

**Notice: Conveyor systems on some automatic car washes could damage the vehicle. There may not be enough clearance for the undercarriage. Check with the car wash manager before using the automatic car wash.**

## Weatherstrips

Silicone grease on weatherstrips will make them last longer, seal better, and not stick or squeak. Apply silicone grease with a clean cloth. During very cold, damp weather frequent application may be required. See "Fluids and Lubricants" in the Index of the "Maintenance and Warranty and Owner assistance Information" manual.

### **Wheels and Trim — Aluminum or Chrome**

The vehicle may have either aluminum or chrome-plated wheels.

Keep the wheels clean using a soft clean cloth with mild soap and water. Rinse with clean water. After rinsing thoroughly, dry with a soft clean towel. A wax may then be applied.

**Notice:** Chrome wheels and other chrome trim may be damaged if the vehicle is not washed after driving on roads that have been sprayed with magnesium, calcium or sodium chloride. These chlorides are used on roads for conditions such as ice and dust. Always wash the vehicle's chrome with soap and water after exposure.

**Notice:** Using strong soaps, chemicals, abrasive polishes, cleaners, brushes, or cleaners that contain acid on aluminum or chrome-plated wheels, could damage the surface of the wheel(s). The repairs would not be covered by the vehicle warranty. Use only approved cleaners on aluminum or chrome-plated wheels.

The surface of these wheels is similar to the painted surface of the vehicle. Do not use strong soaps, chemicals, abrasive polishes, abrasive cleaners, cleaners with acid, or abrasive cleaning brushes on them because the surface could be damaged. Do not use chrome polish on aluminum wheels.

**Notice:** Using chrome polish on aluminum wheels could damage the wheels. The repairs would not be covered by the vehicle warranty. Use chrome polish on chrome wheels only.

Use chrome polish only on chrome-plated wheels, but avoid any painted surface of the wheel, and buff off immediately after application.

**Notice:** Driving the vehicle through an automatic car wash that has silicone carbide tire cleaning brushes, could damage the aluminum or chrome-plated wheels. The repairs would not be covered by the vehicle warranty. Never drive a vehicle that has aluminum or chrome-plated wheels through an automatic car wash that uses silicone carbide tire cleaning brushes.



## Windshield, Backglass, and Wiper Blades

Clean the outside of the windshield and backglass with glass cleaner.

Clean the rubber blades using a lint free cloth or paper towel soaked with windshield washer fluid or a mild detergent. Wash the windshield thoroughly when cleaning the blades. Bugs, road grime, sap, and a buildup of vehicle wash/wax treatments may cause wiper streaking. Replace the wiper blades if they are worn or damaged.

Wipers can be damaged by:

- Extreme dusty conditions
- Sand and salt
- Heat and sun
- Snow and ice, without proper removal

## Tires

Use a stiff brush with tire cleaner to clean the tires.

**Notice: Using petroleum-based tire dressing products on the vehicle may damage the paint finish and/or tires. When applying a tire dressing, always wipe off any overspray from all painted surfaces on the vehicle.**

## Sheet Metal Damage

If the vehicle is damaged and requires sheet metal repair or replacement, make sure the body repair shop applies anti-corrosion material to parts repaired or replaced to restore corrosion protection.

Original manufacturer replacement parts will provide the corrosion protection while maintaining the vehicle warranty.

## Finish Damage

Any stone chips, fractures or deep scratches in the finish should be repaired right away. Bare metal will corrode quickly and may develop into major repair expense.

Minor chips and scratches can be repaired with touch-up materials available from your dealer. Larger areas of finish damage can be corrected in your dealer's/retailer's body and paint shop.

## Underbody Maintenance

Chemicals used for ice and snow removal and dust control can collect on the underbody. If these are not removed, corrosion and rust can develop on the underbody parts such as fuel lines, frame, floor pan, and exhaust system even though they have corrosion protection.

At least every spring, flush these materials from the underbody with plain water. Clean any areas where mud and debris can collect. Dirt packed in close areas of the frame should be loosened before being flushed. Your dealer or an underbody car washing system can do this.

### Chemical Paint Spotting

Some weather and atmospheric conditions can create a chemical fallout. Airborne pollutants can fall upon and attack painted surfaces on the vehicle. This damage can take two forms: blotchy, ring-shaped discolorations, and small, irregular dark spots etched into the paint surface.

### Interior Care

The vehicle's interior will continue to look its best if it is cleaned often. Dust and dirt can accumulate on the upholstery and cause damage to the carpet, fabric, leather, and plastic surfaces. Stains should be removed quickly as extreme heat could cause them to set rapidly.

Lighter colored interiors may require more frequent cleaning. Newspapers and garments that can transfer color to home furnishings can also transfer color to the vehicle's interior.

Remove dust from small buttons and knobs with a small brush with soft bristles.

Your dealer has products for cleaning the vehicle's interior. When cleaning the vehicle's interior, only use cleaners specifically designed for the surfaces that are being cleaned. Permanent damage can

result from using cleaners on surfaces for which they were not intended. Apply the cleaner directly to the cleaning cloth to prevent over-spray. Remove any accidental over-spray from other surfaces immediately.

**Notice:** Using abrasive cleaners when cleaning glass surfaces on the vehicle, could scratch the glass and/or cause damage to the rear window defogger. When cleaning the glass on the vehicle, use only a soft cloth and glass cleaner.

Cleaners can contain solvents that can become concentrated in the vehicle's interior. Before using cleaners, read and adhere to all safety instructions on the label. While cleaning the vehicle's interior, maintain adequate ventilation by opening the vehicle's doors and windows.

Do not clean the interior using the following cleaners or techniques:

- Never use a knife or any other sharp object to remove a soil from any interior surface.
- Never use a stiff brush. It can cause damage to the vehicle's interior surfaces.
- Never apply heavy pressure or rub aggressively with a cleaning cloth. Use of heavy pressure can damage the interior and does not improve the effectiveness of soil removal.
- Use only mild, neutral-pH soaps. Avoid laundry detergents or dishwashing soaps with degreasers. Using too much soap will leave a residue that leaves streaks and attracts dirt. For liquid cleaners, about 20 drops per 3.78 L (1 gal) of water is a good guide.
- Do not heavily saturate the upholstery while cleaning.

- Damage to the vehicle's interior may result from the use of many organic solvents such as naphtha, alcohol, etc.

### **Fabric/Carpet**

Use a vacuum cleaner with a soft brush attachment to remove dust and loose dirt. A canister vacuum with a beater bar in the nozzle may only be used on floor carpet and carpeted floor mats. For soils, always try to remove them first with plain water or club soda. Before cleaning, gently remove as much of the soil as possible using one of the following techniques:

- For liquids: gently blot the remaining soil with a paper towel. Allow the soil to absorb into the paper towel until no more can be removed.
- For solid dry soils: remove as much as possible and then vacuum.

To clean:

1. Saturate a lint-free, clean white cloth with water or club soda.
2. Remove excess moisture.
3. Start on the outside edge of the soil and gently rub toward the center. Continue cleaning, using a clean area of the cloth each time it becomes soiled.
4. Continue to gently rub the soiled area.
5. If the soil is not completely removed, use a mild soap solution and repeat the cleaning process with plain water.

If any of the soil remains, a commercial fabric cleaner or spot lifter may be necessary. Test a small hidden area for colorfastness before using a commercial upholstery cleaner or spot lifter. If the locally cleaned area gives any impression that a ring formation may result, clean the entire surface.

A paper towel can be used to blot excess moisture from the fabric or carpet after the cleaning process.

### Leather

To remove dust, a soft cloth dampened with water can be used. If a more thorough cleaning is necessary, a soft cloth dampened with a mild soap solution can be used. Allow the leather to dry naturally. Do not use heat, steam, or spot lifters or spot removers, or shoe polish on leather. Many commercial leather cleaners and coatings that are sold to preserve and protect leather may permanently change the appearance and feel of the leather and are not recommended. Do not use silicone or wax-based products, or those containing organic solvents to clean the vehicle's interior because they can alter the appearance by increasing the gloss in a non-uniform manner.

### Instrument Panel, Vinyl, and Other Plastic Surfaces

To remove dust, a soft cloth dampened with water can be used. If a more thorough cleaning is necessary, a clean soft cloth dampened with a mild soap solution can be used to gently remove dust and dirt. Never use spot lifters or removers on plastic surfaces. Many commercial cleaners and coatings that are sold to preserve and protect soft plastic surfaces may permanently change the appearance and feel of the interior and are not recommended. Do not use silicone or wax-based products, or those containing organic solvents to clean the vehicle's interior because they can alter the appearance by increasing the gloss in a non-uniform manner.

Some commercial products may increase gloss on the instrument panel. The increase in gloss may cause annoying reflections in the windshield and even make it difficult to see through the windshield under certain conditions.

### Care of Safety Belts

Keep belts clean and dry.

#### **WARNING**

Do not bleach or dye safety belts. It may severely weaken them. In a crash, they might not be able to provide adequate protection. Clean safety belts only with mild soap and lukewarm water.

# Service and Maintenance

## General Information

General Information ..... 11-1

## Scheduled Maintenance

Scheduled Maintenance ..... 11-2

## Recommended Fluids, Lubricants, and Parts

Recommended Fluids and Lubricants ..... 11-8

Maintenance Replacement Parts ..... 11-10

## Maintenance Records

Maintenance Records ..... 11-11

## General Information

**Notice:** Maintenance intervals, checks, inspections, recommended fluids, and lubricants are necessary to keep this vehicle in good working condition. Damage caused by failure to follow scheduled maintenance might not be covered by the vehicle warranty.

As the vehicle owner, you are responsible for the scheduled maintenance in this section. We recommend having your dealer/retailer perform these services. Proper vehicle maintenance helps to keep the vehicle in good working condition, improves fuel economy, and reduces vehicle emissions for better air quality.

Because of all the different ways people use vehicles, maintenance needs vary. The vehicle might need more frequent checks and services. Please read the information under Scheduled Maintenance. To keep the vehicle in good condition, see your dealer/retailer.

The maintenance schedule is for vehicles that:

- Carry passengers and cargo within recommended limits on the Tire and Loading Information label. See *Vehicle Load Limits* on page 9-27.
- Are driven on reasonable road surfaces within legal driving limits.

## 11-2 Service and Maintenance

- Are driven off-road in the recommended manner. See *Off-Road Driving on page 9-7*.
- Use the recommended fuel. See *Recommended Fuel on page 9-64*.

### **WARNING**

Performing maintenance work can be dangerous. Some jobs can cause serious injury. Perform maintenance work only if you have the required know-how and the proper tools and equipment. If in doubt, see your dealer to have a qualified technician do the work. See *Doing Your Own Service Work on page 10-4*.

At your dealer/retailer, you can be certain that you will receive the highest level of service available.

Your dealer/retailer has specially trained service technicians, uses genuine replacement parts, as well as, up to date tools and equipment to ensure fast and accurate diagnostics.

The proper replacement parts, fluids, and lubricants to use are listed in *Recommended Fluids and Lubricants on page 11-8* and *Maintenance Replacement Parts on page 11-10*. We recommend the use of genuine parts from your dealer/retailer.

### **Rotation of New Tires**

To maintain ride, handling, and performance of the vehicle, it is important that the first rotation service for new tires be performed when they have 8 000 to 13 000 km (5,000 to 8,000 miles). See *Tire Rotation on page 10-57*.

## **Scheduled Maintenance**

### **When the Change Oil Message Displays**

Change engine oil and filter. See *Engine Oil on page 10-9*. An *Emission Control Service*.

When the “Change Oil” message displays, service is required for the vehicle as soon as possible, within the next 1 000 km/600 miles. If driving under the best conditions, the engine oil life system might not indicate the need for vehicle service for more than a year. The engine oil and filter must be changed at least once a year and the oil life system must be reset. Your dealer has trained service technicians who will perform this work and reset the system. If the engine oil life system is reset accidentally, service the vehicle within 5 000 km/3,000 miles since the last service. Reset the oil

life system whenever the oil is changed. See *Engine Oil Life System on page 10-11*.

When the “Change Oil” message displays, certain services, checks, and inspections are required. The services described for Maintenance I should be performed at every engine oil change. The services described for Maintenance II should be performed when:

- Maintenance I was performed the last time the engine oil was changed.
- It has been 10 months or more since the “Change Oil” message has displayed or since the last service.

### Maintenance I

- Change engine oil and filter. See *Engine Oil on page 10-9. An Emission Control Service*.
- Engine coolant level check. See *Engine Coolant on page 10-19*.

- Windshield washer fluid level check. See *Washer Fluid on page 10-25*.
- Tire inflation check. See *Tire Pressure on page 10-51*.
- Tire wear inspection. See *Tire Inspection on page 10-57*.
- Rotate tires. See *Tire Rotation on page 10-57*.
- Fluids visual leak check (or every 12 months, whichever occurs first). A leak in any system must be repaired and the fluid level checked.
- Engine air cleaner filter inspection (vehicles driven in dusty conditions only). See *Engine Air Cleaner/Filter on page 10-17*.
- Brake system inspection (or every 12 months, whichever occurs first).

### Maintenance II

- Perform all services described in Maintenance I.
- Steering and suspension inspection. Visual inspection for damaged, loose, or missing parts or signs of wear.
- Lubricate the front suspension, steering linkage, and parking brake cable guides. Control arm ball joints require lubrication but should not be lubricated unless their temperature is  $-12^{\circ}\text{C}$  ( $10^{\circ}\text{F}$ ) or higher, or they could be damaged.
- Engine cooling system inspection. Visual inspection of hoses, pipes, fittings, and clamps and replacement, if needed.

## 11-4 Service and Maintenance

---

- Windshield wiper blade inspection for wear, cracking, or contamination and windshield and wiper blade cleaning, if contaminated. See *Exterior Care on page 10-92*. Worn or damaged wiper blade replacement. See *Wiper Blade Replacement on page 10-32*.
- Body hinges and latches, key lock cylinders, folding seat hardware, and rear compartment hinges, linkage, and handle pivot points lubrication. See *Recommended Fluids and Lubricants on page 11-8*. More frequent lubrication may be required when vehicle is exposed to a corrosive environment. Applying silicone grease on weatherstrips with a clean cloth makes them last longer, seal better, and not stick or squeak.

- Restraint system component check. See *Safety System Check on page 3-26*.
- Automatic transmission fluid level check and adding fluid, if needed. See *Automatic Transmission Fluid on page 10-12*.
- Four-wheel drive vehicles: Transfer case fluid level check and adding fluid, if needed.
- Engine air cleaner filter inspection. See *Engine Air Cleaner/Filter on page 10-17*.

### Additional Required Services

#### At Each Fuel Stop

- Engine oil level check. See *Engine Oil on page 10-9*.
- Engine coolant level check. See *Engine Coolant on page 10-19*.
- Windshield washer fluid level check. See *Washer Fluid on page 10-25*.

#### Once a Month

- Tire inflation check. See *Tire Pressure on page 10-51*.
- Tire wear inspection. See *Tire Inspection on page 10-57*.

#### Once a Year

- See *Starter Switch Check on page 10-30*.
- See *Automatic Transmission Shift Lock Control System Check on page 10-30*.
- See *Ignition Transmission Lock Check on page 10-31*.
- See *Park Brake and P (Park) Mechanism Check on page 10-31*.
- Engine cooling system and pressure cap pressure check. Radiator and air conditioning condenser outside cleaning. See *Cooling System on page 10-18*.



- Exhaust system and nearby heat shields inspection for loose or damaged components.
- Accelerator pedal check for damage, high effort, or binding. Replace if needed.

**First Engine Oil Change After Every 40 000 km/25,000 Miles**

- Fuel system inspection for damage or leaks.

**First Engine Oil Change After Every 80 000 km/50,000 Miles**

- Engine air cleaner filter replacement. See *Engine Air Cleaner/Filter on page 10-17*.
- Automatic transmission fluid change (severe service) for vehicles mainly driven in heavy city traffic in hot weather, in hilly or mountainous terrain, when frequently towing a trailer, or used for taxi, police, or delivery service. See *Automatic Transmission Fluid on page 10-12*.

- Four-wheel drive only: Transfer case fluid change. Check vent hose at transfer case for kinks and proper installation. Check to be sure vent hose is unobstructed, clear, and free of debris. During any maintenance, if a power washer is used to clean mud and dirt from the underbody, care should be taken to not directly spray the transfer case output seals. High pressure water can overcome the seals and contaminate the transfer case fluid. Contaminated fluid will decrease the life of the transfer case and should be replaced.

**First Engine Oil Change After Every 160 000 km/100,000 Miles**

- Automatic transmission fluid change (normal service). See *Automatic Transmission Fluid on page 10-12*.

- Rear axle fluid change (normal service). See *Rear Axle on page 10-29*.
- Spark plug replacement and spark plug wires inspection. *An Emission Control Service*.

**First Engine Oil Change After Every 240 000 km/150,000 Miles**

- Engine cooling system drain, flush, and refill, cooling system and cap pressure check, and cleaning of outside of radiator and air conditioning condenser (or every 5 years, whichever occurs first). See *Cooling System on page 10-18*. *An Emission Control Service*.
- Engine accessory drive belt inspection for fraying, excessive cracks, or obvious damage and replacement, if needed. *An Emission Control Service*.

## 11-6 Service and Maintenance

---

Service	Maintenance I	Maintenance II
Change engine oil and filter. Reset oil life system.	•	•
Engine coolant level check.	•	•
Windshield washer fluid level check.	•	•
Tire inflation pressures check.	•	•
Tire wear inspection.	•	•
Rotate tires.	•	•
Fluids visual leak check.	•	•
Engine air cleaner filter inspection (vehicles driven in dusty conditions only).	•	•
Brake system inspection.	•	•
Body components lubrication.		•
Steering and suspension inspection.		•

<b>Service</b>	<b>Maintenance I</b>	<b>Maintenance II</b>
Chassis components lubrication.		•
Engine cooling system inspection.		•
Windshield wiper blades inspection.		•
Body components lubrication.		•
Restraint system components check.		•
Automatic transmission fluid level check.		•
Four-wheel drive only: Transfer case fluid level check.		•
Engine air cleaner filter inspection (vehicles not driven in dusty conditions).		•

**Recommended Fluids, Lubricants, and Parts****Recommended Fluids and Lubricants**

<b>Usage</b>	<b>Fluid/Lubricant</b>
Engine Oil	Engine oil which meets GM Standard GM6094M and displays the American Petroleum Institute Certified for Gasoline Engines starburst symbol. To determine the proper viscosity for your vehicle's engine, see <i>Engine Oil</i> on page 10-9.
Engine Coolant	50/50 mixture of clean, drinkable water and use only DEX-COOL <sup>®</sup> Coolant. See <i>Engine Coolant</i> on page 10-19
Hydraulic Brake System	DOT 3 Hydraulic Brake Fluid (GM Part No. U.S. 12377967, in Canada 89021320).
Windshield Washer	Optikleen <sup>®</sup> Washer Solvent.
Hydraulic Power Steering System	GM Power Steering Fluid (GM Part No. U.S. 89021184, in Canada 89021186).
Automatic Transmission	DEXRON <sup>®</sup> -VI Automatic Transmission Fluid.
Manual Transmission	Manual Transmission Fluid (GM Part No. U.S. 89021806, in Canada 89021807).
Hydraulic Clutch System	Hydraulic Clutch Fluid (GM Part No. U.S. 12345347, in Canada 10953517) or equivalent DOT-3 brake fluid.

<b>Usage</b>	<b>Fluid/Lubricant</b>
Key Lock Cylinders	Multi-Purpose Lubricant, Superlube (GM Part No. U.S. 12346241, in Canada 10953474).
Chassis Lubrication	Chassis Lubricant (GM Part No. U.S. 12377985, in Canada 88901242) or lubricant meeting requirements of NLGI #2, Category LB or GC-LB.
Front and Rear Axle	SAE 75W-90 Synthetic Axle Lubricant (GM Part No. U.S. 89021677, in Canada 89021678).
Transfer Case	DEXRON®-VI Automatic Transmission Fluid.
Hood Hinges	Multi-Purpose Lubricant, Superlube (GM Part No. U.S. 12346241, in Canada 10953474).
Outer Endgate Handle Pivot Points	Multi-Purpose Lubricant, Superlube (GM Part No. U.S. 12346241, in Canada 10953474).
Weatherstrip Conditioning	Weatherstrip Lubricant (GM Part No. U.S. 3634770, in Canada 10953518) or Dielectric Silicone Grease (GM Part No. U.S. 12345579, in Canada 992887).
Weatherstrip Squeaks	Synthetic Grease with Teflon, Superlube (GM Part No. U.S. 12371287, in Canada 10953437).

## 11-10 Service and Maintenance

---

### Maintenance Replacement Parts

Replacement parts identified below by name, part number or specification can be obtained from your dealer.

Part	GM Part Number	ACDelco Part Number
Engine Air Cleaner/Filter		
3.7L L5 and 5.3L V8 Engine	15942429	—
Engine Oil Filter		
3.7L L5 Engine	19210285	PF61
5.3L V8 Engine	89017524	PF48
Spark Plugs		
3.7L L5 Engine	12625058	41-103
5.3L V8 Engine	12621258	41-110
Wiper Blades		
Front Driver Side – 42.5 cm (16.7 in)	10389562	—
Front Passenger Side – 40.0 cm (15.7 in)	10389563	—
Rear – 30.0 cm (11.8 in)	10389570	—











## Technical Data

### Vehicle Identification

Vehicle Identification Number (VIN) .....	12-1
Service Parts Identification Label .....	12-1

### Vehicle Data

Capacities and Specifications .....	12-2
Engine Drive Belt Routing ...	12-4

## Vehicle Identification

### Vehicle Identification Number (VIN)



This legal identifier is in the front corner of the instrument panel, on the left side of the vehicle. It can be seen through the windshield from outside. The VIN also appears on the Vehicle Certification and Service Parts labels and certificates of title and registration.

## Engine Identification

The eighth character in the VIN is the engine code. This code identifies the vehicle's engine, specifications, and replacement parts. See "Engine Specifications" under *Capacities and Specifications* on page 12-2 for the vehicle's engine code.

## Service Parts Identification Label

This label, on the inside of the glove box, has the following information:

- Vehicle Identification Number (VIN)
- Model designation
- Paint information
- Production options and special equipment

Do not remove this label from the vehicle.

## Vehicle Data

### Capacities and Specifications

The following approximate capacities are given in English and metric. Please refer to *Recommended Fluids and Lubricants on page 11-8* for more information.

#### Capacities and Specifications

Application	Capacities	
	Metric	English
Air Conditioning Refrigerant R134a	For the air conditioning system refrigerant charge amount, see the refrigerant caution label located under the hood. See your dealer for more information.	
Cooling System		
3.7L L5 Engine	9.5 L	10.0 qt
5.3L V8 Engine	13.5 L	14.3 qt
Engine Oil with Filter		
3.7L L5 and 5.3L V8 Engines	5.7 L	6.0 qt
Fuel Tank		
H3	87.1 L	23.0 gal
H3T	102.2 L	27.0 gal

**Capacities and Specifications (cont'd)**

Application	Capacities	
	Metric	English
Transfer Case	1.5 L	1.6 qt
Transmission		
3.7L L5 and 5.3L V8, Automatic Transmission (Pan Removal and Filter Replacement)	4.7 L	5.0 qt
3.7L L5, Manual Transmission (Drain and Refill)	2.4 L	2.5 qt
Wheel Nut Torque	140 N•m	100 lb ft
All capacities are approximate. When adding, be sure to fill to the approximate level, as recommended in this manual.		

**Engine Specifications**

Engine	VIN Code	Transmission	Spark Plug Gap
3.7L L5	E	Automatic Manual	1.01 mm (0.040 in)
5.3L V8	P	Automatic	1.01 mm (0.040 in)

**Engine Drive Belt Routing**

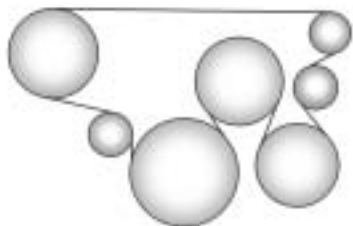

**3.7L L5 Engine**

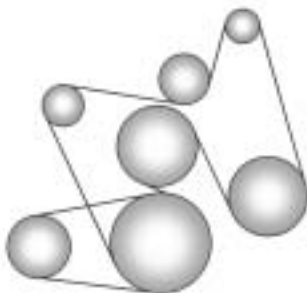

**5.3L V8 Engine**

# Customer Information

## Customer Information

Customer Satisfaction Procedure .....	13-1
Customer Assistance Offices .....	13-3
Customer Assistance for Text Telephone (TTY) Users .....	13-4
Online Owner Center .....	13-4
Roadside Service .....	13-5
Scheduling Service	
Appointments .....	13-8
Courtesy Transportation Program .....	13-8
Collision Damage Repair ...	13-10
Service Publications	
Ordering Information .....	13-12

## Reporting Safety Defects

Reporting Safety Defects to the United States Government .....	13-13
Reporting Safety Defects to the Canadian Government .....	13-14
Reporting Safety Defects to General Motors .....	13-14

## Vehicle Data Recording and Privacy

Vehicle Data Recording and Privacy .....	13-15
Event Data Recorders .....	13-15
OnStar® .....	13-16
Navigation System .....	13-16
Radio Frequency Identification (RFID) .....	13-16
Radio Frequency Statement .....	13-16

# Customer Information

## Customer Satisfaction Procedure

Your satisfaction and goodwill are important to your dealer and to HUMMER. Normally, any concerns with the sales transaction or the operation of the vehicle will be resolved by the dealer's sales or service departments. Sometimes, however, despite the best intentions of all concerned, misunderstandings can occur. If your concern has not been resolved to your satisfaction, the following steps should be taken:

**STEP ONE:** Discuss your concern with a member of dealership management. Normally, concerns can be quickly resolved at that level. If the matter has already been reviewed with the sales, service or parts manager, contact the owner of the dealership or the general manager.

## 13-2 Customer Information

---

**STEP TWO:** If after contacting a member of dealership management, it appears your concern cannot be resolved by the dealership without further help, call the HUMMER Consumer Relations Manager at 1-866-HUMMER6 (486-6376), Customer Assistance prompt. In Canada, call GM of Canada Customer Communication Centre at 1-800-263-3777 (English), or 1-800-263-7854 (French).

We encourage you to call the toll-free number in order to give your inquiry prompt attention. Have the following information available to give the Customer Assistance Representative:

- Vehicle Identification Number (VIN). This is available from the vehicle registration or title, or the plate at the top left of the instrument panel and visible through the windshield.

- Dealership name and location
- Vehicle delivery date and present mileage

When contacting HUMMER, please remember that your concern will likely be resolved at a dealer's facility. That is why we suggest you follow Step One first if you have a concern.

**STEP THREE — U.S. Owners:**

Both HUMMER and your dealer are committed to making sure you are completely satisfied with your new vehicle. However, if you continue to remain unsatisfied after following the procedure outlined in Steps One and Two, you can file with the Better Business Bureau (BBB) Auto Line Program to enforce any additional rights you may have.

The BBB Auto Line Program is an out of court program administered by the Council of Better Business Bureaus to settle automotive disputes regarding vehicle repairs or the interpretation of the New Vehicle Limited Warranty. Although you may be required to resort to this informal dispute resolution program prior to filing a court action, use of the program is free of charge and your case will generally be heard within 40 days. If you do not agree with the decision given in your case, you may reject it and proceed with any other venue for relief available to you.



Contact the BBB Auto Line Program using the toll-free telephone number or write them at:

BBB Auto Line Program  
Council of Better Business  
Bureaus, Inc.

4200 Wilson Boulevard  
Suite 800  
Arlington, VA 22203-1838

Telephone: 1-800- 955-5100  
[dr.bbb.org/goauto](http://dr.bbb.org/goauto)

This program is available in all 50 states and the District of Columbia. Eligibility is limited by vehicle age, mileage, and other factors. General Motors reserves the right to change eligibility limitations and/or discontinue its participation in this program.

Your inquiry should be accompanied by the Vehicle Identification Number (VIN).

## Customer Assistance Offices

HUMMER encourages customers to call the toll-free number for assistance. However, if a customer wishes to write or e-mail HUMMER, refer to the addresses below.

### United States – Customer Assistance

HUMMER Customer  
Assistance Center  
P.O. Box 33177  
Detroit, MI 48232-5177  
[www.HUMMER.com](http://www.HUMMER.com)

1-866-HUMMER6 (1-866-486-6376)  
1-800-833-6537 (For Text  
Telephone devices (TTYs))  
Roadside Assistance:  
1-866-HUMMER6 (1-866-486-6376)

From Puerto Rico:

1-800-496-9992 (English)  
1-800-496-9993 (Spanish)

From U.S. Virgin Islands:

1-800-496-9994

### Canada – Customer Assistance

General Motors of Canada Limited  
Customer Communication Centre,  
CA1-163-005  
1908 Colonel Sam Drive  
Oshawa, Ontario L1H 8P7  
[www.gmcanada.com](http://www.gmcanada.com)

1-800-263-3777 (English)  
1-800-263-7854 (French)  
1-800-263-3830 (For Text  
Telephone devices (TTYs))  
Roadside Assistance:  
1-800-268-6800

### Overseas – Customer Assistance

Please contact the local General Motors Business Unit.

## 13-4 Customer Information

---

### **Mexico, Central America and Caribbean Islands/Countries (Except Puerto Rico and U.S. Virgin Islands) – Customer Assistance**

General Motors de Mexico,  
S. de R.L. de C.V.  
Customer Assistance Center  
Paseo de la Reforma # 2740  
Col. Lomas de Bezares  
C.P. 11910, Mexico, D.F.

01-800-508-0000  
Long Distance: 011-52-53 29 0 800

### **Customer Assistance for Text Telephone (TTY) Users**

To assist customers who are deaf, hard of hearing, or speech-impaired and who use Text Telephones (TTYs), HUMMER has TTY equipment available at its Customer Assistance Center. Any TTY user in the U.S. can communicate with HUMMER by dialing: 1-800-833-6537. (TTY users in Canada can dial 1-800-263-3830.)

### **Online Owner Center**

**Online Owner Center (U.S.) — [www.gmownercenter.com/hummer](http://www.gmownercenter.com/hummer)**

Information and services customized for your specific vehicle — all in one convenient place.

- Digital owner manual, warranty information, and more
- Online service and maintenance records
- Find HUMMER dealers for service nationwide
- Exclusive privileges and offers
- Recall notices for your specific vehicle
- OnStar<sup>®</sup> and GM Cardmember Services Earnings summaries

**Other Helpful Links:**

HUMMER — [www.hummer.com](http://www.hummer.com)

HUMMER Merchandise —  
[www.hummerstuff.com](http://www.hummerstuff.com)

**Roadside Service**

For U.S. purchased vehicles, call **1-866-HUMMER6 (486-6376)**; (**Text Telephone (TTY): 1-888-889-2438**).

For Canadian purchased vehicles, call **1-800-268-6800**.

Service is available 24 hours a day, 365 days a year.

**Calling for Assistance**

When calling Roadside Assistance, have the following information ready:

- Your name, home address, and home telephone number
- Telephone number of your location
- Location of the vehicle
- Model, year, color, and license plate number of the vehicle
- Odometer reading, Vehicle Identification Number (VIN), and delivery date of the vehicle
- Description of the problem

**Coverage**

Services are provided up to 5 years/100,000 miles (160 000 km), whichever comes first.

In the U.S., anyone driving the vehicle is covered. In Canada, a person driving the vehicle without permission from the owner is not covered.

Roadside Assistance is not a part of the New Vehicle Limited Warranty. HUMMER and General Motors of Canada Limited reserve the right to make any changes or discontinue the Roadside Assistance program at any time without notification.

HUMMER and General Motors of Canada Limited reserve the right to limit services or payment to an owner or driver if they decide the claims are made too often, or the same type of claim is made many times.

## 13-6 Customer Information

---

### Services Provided

- **Emergency Fuel Delivery:** Delivery of enough fuel for the vehicle to get to the nearest service station.
- **Lock-Out Service:** Service is provided to unlock the vehicle if you are locked out. A remote unlock may be available if you have OnStar<sup>®</sup>. For security reasons, the driver must present identification before this service is given.
- **Emergency Tow From a Public Road or Highway:** Tow to the nearest HUMMER dealer for warranty service, or if the vehicle was in a crash and cannot be driven.

- **Flat Tire Change:** Service is provided to change a flat tire with spare tire. The spare tire, if equipped, must be in good condition and properly inflated. It is your responsibility for the repair or replacement of the tire if it is not covered by the warranty.
- **Battery Jump Start:** Service is provided to jump start a dead battery.
- **Trip Routing Service:** Detailed maps of North America are provided when requested either with the most direct route or the most scenic route. Additional travel information is also available. Allow three weeks for delivery.

- **Trip Interruption Benefits and Assistance:** If your trip is interrupted due to a warranty failure, incidental expenses may be reimbursed during the 5 year/100,000 miles (160 000 km) Powertrain warranty period. Items considered are hotel, meals, and rental car.

### HUMMER Technician Roadside Service (U.S. only)

HUMMER's exceptional Roadside Service is more than an auto club or towing service. It provides every HUMMER owner in the United States with the advantage of contacting a HUMMER advisor and, where available, a HUMMER trained dealer technician who can provide on-site service.

A dealer technician will travel to your location within a 30 mile radius of a participating HUMMER dealership. If beyond this radius, we will arrange to have your vehicle towed to the nearest HUMMER dealership. Each technician travels with a specially equipped service vehicle complete with the necessary HUMMER parts and tools required to handle most roadside repairs.

### Services Not Included in Roadside Assistance

- Impound towing caused by violation of any laws.
- Legal fines.
- Mounting, dismounting or changing of snow tires, chains, or other traction devices.
- Towing or services for vehicles driven on a non-public road or highway.

### Services Specific to Canadian Purchased Vehicles

- **Fuel delivery:** Reimbursement is approximately \$5 Canadian. Diesel fuel delivery may be restricted. Propane and other fuels are not provided through this service.
- **Lock-Out Service:** Vehicle registration is required.
- **Trip Routing Service:** Limit of six requests per year.
- **Trip Interruption Benefits and Assistance:** Pre-authorization, original detailed receipts, and a copy of the repair orders are required. Once authorization has been received, the Roadside Assistance advisor will help you make arrangements and explain how to receive payment.

- **Alternative Service:** If assistance cannot be provided right away, the Roadside Assistance advisor may give you permission to get local emergency road service. You will receive payment, up to \$100, after sending the original receipt to Roadside Assistance. Mechanical failures may be covered, however any cost for parts and labor for repairs not covered by the warranty are the owner responsibility.

### **Scheduling Service Appointments**

When your vehicle requires warranty service, contact your dealer and request an appointment. By scheduling a service appointment and advising your service consultant of your transportation needs, your dealer can help minimize your inconvenience.

If your vehicle cannot be scheduled into the service department immediately, keep driving it until it can be scheduled for service, unless, of course, the problem is safety-related. If it is, please call your dealership/retailer, let them know this, and ask for instructions.

If the dealer requests you to bring the vehicle for service, you are urged to do so as early in the work day as possible to allow for the same day repair.

### **Courtesy Transportation Program**

To enhance your ownership experience, we and our participating dealers are proud to offer Courtesy Transportation, a customer support program for vehicles with the Bumper to Bumper (Base Warranty Coverage period in Canada) and extended powertrain, and hybrid specific warranty in both the U.S. and Canada.

Several courtesy transportation options are available to assist in reducing your inconvenience when warranty repairs are required.

Courtesy Transportation is not a part of the New Vehicle Limited Warranty. A separate booklet entitled "Warranty and Owner Assistance Information" furnished with each new vehicle provides detailed warranty coverage information.

### **Transportation Options**

Warranty service can generally be completed while you wait. However, if you are unable to wait, HUMMER helps to minimize your inconvenience by providing several transportation options. Depending on the circumstances, your dealer can offer you one of the following:

#### **Shuttle Service**

Shuttle service is the preferred means of offering Courtesy Transportation. Dealers may provide you with shuttle service to get you to your destination with minimal interruption of your daily schedule. This includes one-way or round trip shuttle service within reasonable time and distance parameters of the dealer's area.

**Public Transportation or Fuel Reimbursement**

If your vehicle requires overnight warranty repairs, and public transportation is used instead of the dealer's shuttle service, the expense must be supported by original receipts and can only be up to the maximum amount allowed by HUMMER for shuttle service. In addition, for U.S. customers, should you arrange transportation through a friend or relative, limited reimbursement for reasonable fuel expenses may be available. Claim amounts should reflect actual costs and be supported by original receipts. See your dealer for information regarding the allowance amounts for reimbursement of fuel or other transportation costs.

**Courtesy Rental Vehicle**

Your dealer may arrange to provide you with a courtesy rental vehicle or reimburse you for a rental vehicle that you obtain if your vehicle is kept for an overnight warranty repair. Rental reimbursement will be limited and must be supported by original receipts. This requires that you sign and complete a rental agreement and meet state/provincial, local, and rental vehicle provider requirements. Requirements vary and may include minimum age requirements, insurance coverage, credit card, etc. You are responsible for fuel usage charges and may also be responsible for taxes, levies, usage fees, excessive mileage, or rental usage beyond the completion of the repair.

It may not be possible to provide a like-vehicle as a courtesy rental.

**Additional Program Information**

All program options, such as shuttle service, may not be available at every dealer. Please contact your dealer for specific information about availability. All Courtesy Transportation arrangements will be administered by appropriate dealer personnel.

*HUMMER reserves the right to unilaterally modify, change or discontinue Courtesy Transportation at any time and to resolve all questions of claim eligibility pursuant to the terms and conditions described herein at its sole discretion.*

### **Collision Damage Repair**

If your vehicle is involved in a collision and it is damaged, have the damage repaired by a qualified technician using the proper equipment and quality replacement parts. Poorly performed collision repairs will diminish your vehicle's resale value, and safety performance can be compromised in subsequent collisions.

### **Collision Parts**

Genuine Collision parts are new parts made with the same materials and construction methods as the parts with which your vehicle was originally built. Genuine Collision parts are your best choice to ensure that your vehicle's designed appearance, durability and safety are preserved. The use of Genuine parts can help maintain your HUMMER New Vehicle Warranty.

Recycled original equipment parts may also be used for repair. These parts are typically removed from vehicles that were total losses in prior crashes. In most cases, the parts being recycled are from undamaged sections of the vehicle. A recycled original equipment part, may be an acceptable choice to maintain your vehicle's originally designed appearance and safety performance, however, the history of these parts is not known. Such parts are not covered by your HUMMER New Vehicle Limited Warranty, and any related failures are not covered by that warranty.

Aftermarket collision parts are also available. These are made by companies other than HUMMER and may not have been tested for your vehicle. As a result, these parts may fit poorly, exhibit premature durability/corrosion problems, and may not perform properly in subsequent collisions.

Aftermarket parts are not covered by your HUMMER New Vehicle Limited Warranty, and any vehicle failure related to such parts are not covered by that warranty.

### **Repair Facility**

HUMMER also recommends that you choose a collision repair facility that meets your needs before you ever need collision repairs. Your HUMMER dealer may have a collision repair center with trained technicians and state of the art equipment, or be able to recommend a collision repair center that has trained technicians and comparable equipment.



## Insuring Your Vehicle

Protect your investment in your HUMMER vehicle with comprehensive and collision insurance coverage. There are significant differences in the quality of coverage afforded by various insurance policy terms. Many insurance policies provide reduced protection to your HUMMER vehicle by limiting compensation for damage repairs by using aftermarket collision parts. Some insurance companies will not specify aftermarket collision parts. When purchasing insurance, we recommend that you assure your vehicle will be repaired with original equipment collision parts. If such insurance coverage is not available from your current insurance carrier, consider switching to another insurance carrier.

If your vehicle is leased, the leasing company may require you to have insurance that assures repairs with Genuine Original Equipment Manufacturer (OEM) parts or Genuine Manufacturer replacement parts. Read your lease carefully, as you may be charged at the end of your lease for poor quality repairs.

### If a Crash Occurs

If there has been an injury, call emergency services for help. Do not leave the scene of a crash until all matters have been taken care of. Move the vehicle only if its position puts you in danger, or you are instructed to move it by a police officer.

Give only the necessary information to police and other parties involved in the crash.

For emergency towing see *Roadside Service on page 13-5.*

Gather the following information:

- Driver's name, address, phone number
- Driver's license number
- Owner's name, address, phone number
- Vehicle license plate
- Vehicle make, model and model year
- Vehicle Identification Number (VIN)
- Insurance company and policy number
- General description of the damage to the other vehicle

Choose a reputable repair facility that uses quality replacement parts. See "Collision Parts" earlier in this section.

If the airbag has inflated, see *What Will You See After an Airbag Inflates?* on page 3-33.

### **Managing the Vehicle Damage Repair Process**

In the event that your vehicle requires damage repairs, HUMMER recommends that you take an active role in its repair. If you have a pre-determined repair facility of choice, take your vehicle there, or have it towed there. Specify to the facility that any required replacement collision parts be original equipment parts, either new Genuine parts or recycled original parts. Remember, recycled parts will not be covered by your HUMMER vehicle warranty.

Insurance pays the bill for the repair, but you must live with the repair. Depending on your policy limits, your insurance company may initially value the repair using aftermarket parts.

Discuss this with your repair professional, and insist on Genuine parts. Remember if your vehicle is leased you may be obligated to have the vehicle repaired with Genuine parts, even if your insurance coverage does not pay the full cost.

If another party's insurance company is paying for the repairs, you are not obligated to accept a repair valuation based on that insurance company's collision policy repair limits, as you have no contractual limits with that company. In such cases, you can have control of the repair and parts choices as long as cost stays within reasonable limits.

### **Service Publications Ordering Information**

#### **Service Manuals**

Service Manuals have the diagnosis and repair information on engines, transmission, axle suspension, brakes, electrical, steering, body, etc.

#### **Service Bulletins**

Service Bulletins give additional technical service information needed to knowledgeably service cars and trucks. Each bulletin contains instructions to assist in the diagnosis and service of your vehicle.

## Owner Information

Owner publications are written specifically for owners and intended to provide basic operational information about the vehicle. The owner manual includes the Maintenance Schedule for all models.

In-Portfolio: Includes a Portfolio, Owner Manual, and Warranty Booklet.

RETAIL SELL PRICE:  
\$35.00 (U.S.) plus processing fee

Without Portfolio: Owner Manual only.

RETAIL SELL PRICE:  
\$25.00 (U.S.) plus processing fee

## Current and Past Model Order Forms

Technical Service Bulletins and Manuals are available for current and past model HUMMER vehicles. To request an order form, specify year and model name of the vehicle.

**ORDER TOLL FREE:**  
**1-800-551-4123 Monday-Friday**  
**8:00 AM - 6:00 PM Eastern Time**

For Credit Card Orders Only (VISA-MasterCard-Discover), visit Helm, Inc. on the World Wide Web at: [helminc.com](http://helminc.com)

Or you can write to:

Helm, Incorporated  
P.O. Box 07130  
Detroit, MI 48207

Prices are subject to change without notice and without incurring obligation. Allow ample time for delivery.

Note to Canadian Customers: All listed prices are quoted in U.S. funds. Canadian residents are to make checks payable in U.S. funds.

## Reporting Safety Defects

### Reporting Safety Defects to the United States Government

If you believe that your vehicle has a defect which could cause a crash or could cause injury or death, you should immediately inform the National Highway Traffic Safety Administration (NHTSA) in addition to notifying General Motors.

If NHTSA receives similar complaints, it may open an investigation, and if it finds that a safety defect exists in a group of vehicles, it may order a recall and remedy campaign.

## 13-14 Customer Information

---

However, NHTSA cannot become involved in individual problems between you, your dealer, or General Motors.

To contact NHTSA, you may call the Vehicle Safety Hotline toll-free at 1-888-327-4236 (TTY: 1-800-424-9153); go to <http://www.safercar.gov>; or write to:

Administrator, NHTSA  
1200 New Jersey Avenue, S.E.  
Washington, D.C. 20590

You can also obtain other information about motor vehicle safety from <http://www.safercar.gov>.

### Reporting Safety Defects to the Canadian Government

If you live in Canada, and you believe that your vehicle has a safety defect, notify Transport Canada immediately, in addition to notifying General Motors of Canada Limited. Call them at 1-800-333-0510 or write to:

Transport Canada  
Road Safety Branch  
2780 Sheffield Road  
Ottawa, Ontario K1B 3V9

### Reporting Safety Defects to General Motors

In addition to notifying NHTSA (or Transport Canada) in a situation like this, please notify General Motors.

Call 1-866-HUMMER6 (486-6376), or write:

HUMMER Customer  
Assistance Center  
P.O. Box 33177  
Detroit, MI 48232-5177

In Canada, call 1-800-263-3777 (English) or 1-800-263-7854 (French), or write:

General Motors of Canada Limited  
Customer Communication Centre  
CA1-163-005  
1908 Colonel Sam Drive  
Oshawa, Ontario L1H 8P7

## Vehicle Data Recording and Privacy

Your HUMMER vehicle has a number of sophisticated computers that record information about the vehicle's performance and how it is driven. For example, your vehicle uses computer modules to monitor and control engine and transmission performance, to monitor the conditions for airbag deployment and deploy airbags in a crash and, if so equipped, to provide antilock braking to help the driver control the vehicle. These modules may store data to help your dealer technician service your vehicle. Some modules may also store data about how you operate the vehicle, such as rate of fuel consumption or average speed. These modules may also retain the owner's personal preferences, such as radio pre-sets, seat positions, and temperature settings.

## Event Data Recorders

This vehicle has an Event Data Recorder (EDR). The main purpose of an EDR is to record, in certain crash or near crash-like situations, such as an airbag deployment or hitting a road obstacle, data that will assist in understanding how a vehicle's systems performed. The EDR is designed to record data related to vehicle dynamics and safety systems for a short period of time, typically 30 seconds or less. The EDR in this vehicle is designed to record such data as:

- How various systems in your vehicle were operating
- Whether or not the driver and passenger safety belts were buckled/fastened
- How far, if at all, the driver was pressing the accelerator and/or brake pedal
- How fast the vehicle was traveling

This data can help provide a better understanding of the circumstances in which crashes and injuries occur.

**Important:** EDR data is recorded by your vehicle only if a non-trivial crash situation occurs; no data is recorded by the EDR under normal driving conditions and no personal data (e.g., name, gender, age, and crash location) is recorded. However, other parties, such as law enforcement, could combine the EDR data with the type of personally identifying data routinely acquired during a crash investigation.

To read data recorded by an EDR, special equipment is required, and access to the vehicle or the EDR is needed. In addition to the vehicle manufacturer, other parties, such as law enforcement, that have the special equipment, can read the information if they have access to the vehicle or the EDR.

HUMMER will not access this data or share it with others except: with the consent of the vehicle owner or, if the vehicle is leased, with the consent of the lessee; in response to an official request of police or similar government office; as part of HUMMER's defense of litigation through the discovery process; or, as required by law. Data that HUMMER collects or receives may also be used for HUMMER research needs or may be made available to others for research purposes, where a need is shown and the data is not tied to a specific vehicle or vehicle owner.

### **OnStar®**

If the vehicle has OnStar and you subscribe to the OnStar services, please refer to the OnStar Terms and Conditions in the OnStar Owners Guide for information on data collection and use.

### **Navigation System**

If your vehicle has a navigation system, use of the system may result in the storage of destinations, addresses, telephone numbers, and other trip information. Refer to the navigation system operating manual for information on stored data and for deletion instructions.

### **Radio Frequency Identification (RFID)**

RFID technology is used in some vehicles for functions such as tire pressure monitoring and ignition system security, as well as in connection with conveniences such as key fobs for remote door locking/unlocking and starting, and in-vehicle transmitters for garage door openers. RFID technology in HUMMER vehicles does not use or record personal information or link with any other HUMMER system containing personal information.

### **Radio Frequency Statement**

This vehicle has systems that operate on a radio frequency that comply with Part 15 of the Federal Communications Commission (FCC) Rules and with RSS-210/211 of Industry Canada.

Operation is subject to the following two conditions:

1. The device may not cause interference.
2. The device must accept any interference received, including interference that may cause undesired operation of the device.

Changes or modifications to any of these systems by other than an authorized service facility could void authorization to use this equipment.

**A**

Accessories and  
 Modifications ..... 10-3  
 Accessory Power ..... 9-35  
 Add-On Electrical  
 Equipment ..... 9-81  
 Adding Equipment to the  
 Airbag-Equipped Vehicle ..... 3-40  
 Adjustments  
 Lumbar, Front Seats ..... 3-4  
 Air Cleaner/Filter, Engine ..... 10-17  
 Air Vents ..... 8-4  
 Airbag System  
 Check ..... 3-41  
 How Does an Airbag  
 Restrain? ..... 3-32  
 Passenger Sensing  
 System ..... 3-35  
 What Makes an Airbag  
 Inflate? ..... 3-32

Airbag System (cont.)  
 What Will You See After  
 an Airbag Inflates? ..... 3-33  
 When Should an Airbag  
 Inflate? ..... 3-31  
 Where Are the Airbags? ..... 3-29  
 Airbags  
 Adding Equipment to the  
 Vehicle ..... 3-40  
 Passenger Status Indicator ... 5-11  
 Readiness Light ..... 5-10  
 Servicing Airbag-Equipped  
 Vehicles ..... 3-40  
 System Check ..... 3-27  
 Alarm System  
 Anti-Theft ..... 2-9  
 AM-FM Radio ..... 7-5  
 Antenna  
 Satellite Radio ..... 7-10  
 Anti-Theft  
 Alarm System ..... 2-9

Antilock Brake  
 System (ABS) ..... 9-50  
 Warning Light ..... 5-15  
 Appearance Care  
 Exterior ..... 10-92  
 Interior ..... 10-96  
 Ashtrays ..... 5-6  
 Audio Players ..... 7-10  
 CD ..... 7-10  
 Audio System  
 Fixed Mast Antenna ..... 7-10  
 Radio Reception ..... 7-9  
 Theft-Deterrent Feature ..... 7-2  
 Automatic  
 Door Locks ..... 2-6  
 Headlamp System ..... 6-4  
 Automatic Transmission ..... 9-41  
 Fluid ..... 10-12  
 Shiftlock Control System  
 Check ..... 10-30  
 Axle  
 Locking Front ..... 9-55  
 Axle, Front ..... 10-29  
 Axle, Rear ..... 10-29

**B**

Battery .....	10-28
Jump Starting .....	10-86
Load Management .....	6-8
Power Protection .....	6-9
Voltage and Charging Messages .....	5-21
Blade Replacement, Wiper ...	10-32
Bluetooth .....	7-15
Brakes .....	10-26
Antilock .....	9-50
Assist .....	9-51
Fluid .....	10-27
Parking .....	9-51
System Messages .....	5-22
Braking .....	9-3
Break-In, New Vehicle .....	9-33
Bulb Replacement .....	10-37
Fog Lamps .....	6-6
Halogen Bulbs .....	10-35
Headlamp Aiming .....	10-33

Bulb Replacement (cont.)	
Headlamps .....	10-35
License Plate Lamps .....	10-37
Taillamps, Turn Signal, Stoplamps, and Back-Up Lamps ....	10-35, 10-36
Buying New Tires .....	10-59

**C**

Calibration .....	5-3
California	
Fuel Requirements .....	9-65
Perchlorate Materials Requirements .....	10-3
Warning .....	10-2
Camera, Rear Vision .....	9-60
Canadian Vehicle Owners .....	iii
Capacities and Specifications .....	12-2
Carbon Monoxide	
Engine Exhaust .....	9-40
Tailgate .....	2-7
Winter Driving .....	9-24

Cargo	
Cover .....	4-2
Management System .....	4-2
Tie Downs .....	4-2
Cautions, Danger, and Warnings .....	iii
CD Player .....	7-10
Center Console Storage .....	4-1
Chains, Tire .....	10-64
Charging System Light .....	5-11
Check	
Engine Lamp .....	5-12
Ignition Transmission Lock .....	10-31
Child Restraints	
Infants and Young Children .....	3-44
Lower Anchors and Tethers for Children .....	3-51
Older Children .....	3-42
Securing .....	3-59, 3-61, 3-62
Systems .....	3-47
Where to Put the Restraint ...	3-49



Cigarette Lighter ..... 5-5  
 Circuit Breakers ..... 10-39  
 Cleaning  
     Exterior Care ..... 10-92  
     Interior Care ..... 10-96  
 Climate Control Systems ..... 8-1  
 Clock ..... 5-4  
 Cluster, IP ..... 5-7  
 Clutch, Hydraulic ..... 10-16  
 Collision Damage Repair ..... 13-10  
 Compass ..... 5-3  
 Control of a Vehicle ..... 9-3  
 Convenience Net ..... 4-3  
 Convex Mirrors ..... 2-13  
 Coolant  
     Engine ..... 10-19  
     Engine Temperature Gauge ... 5-9  
 Cooling System ..... 10-18  
     Engine Messages ..... 5-23  
 Courtesy Transportation  
     Program ..... 13-8  
 Covers  
     Cargo ..... 4-2  
     Rear Compartment/Storage  
         Panel ..... 4-2

Cruise Control ..... 9-57  
     Light ..... 5-18  
 Cupholders ..... 4-1  
 Customer Assistance ..... 13-4  
     Offices ..... 13-3  
     Text Telephone (TTY)  
         Users ..... 13-4  
 Customer Information  
     Service Publications  
         Ordering Information ..... 13-12  
 Customer Satisfaction  
     Procedure ..... 13-1

**D**

Damage Repair, Collision ..... 13-10  
 Danger, Warnings, and  
     Cautions ..... iii  
 Data Recorders, Event ..... 13-15  
 Daytime Running  
     Lamps (DRL) ..... 6-3  
 Defensive Driving ..... 9-2  
 Dome Lamps ..... 6-7

Door  
     Ajar Messages ..... 5-22  
     Locks ..... 2-4  
     Power Locks ..... 2-5  
 Driver Information  
     Center (DIC) ..... 5-18  
 Driving  
     Characteristics and  
         Towing Tips ..... 9-70  
     Defensive ..... 9-2  
     Drunk ..... 9-2  
     Highway Hypnosis ..... 9-22  
     Hill and Mountain Roads ..... 9-23  
     If the Vehicle is Stuck ..... 9-26  
     Loss of Control ..... 9-6  
     Off-Road ..... 9-7  
     Off-Road Recovery ..... 9-5  
     Vehicle Load Limits ..... 9-27  
     Winter ..... 9-24  
 Driving for Better Fuel  
     Economy ..... 1-18

**E**

E85 Fuel .....	9-66
Electrical Equipment, Add-On .....	9-81
Electrical System	
Engine Compartment	
Fuse Block .....	10-39
Fuses and Circuit Breakers .....	10-39
Overload .....	10-38
Engine	
Air Cleaner/Filter .....	10-17
Check and Service Engine Soon Lamp .....	5-12
Compartment Overview .....	10-6
Coolant .....	10-19
Coolant Heater .....	9-36
Coolant Temperature Gauge ...	5-9
Cooling System .....	10-18
Cooling System Messages ...	5-23
Drive Belt Routing .....	12-4
Exhaust .....	9-40
Fan .....	10-24

Engine (cont.)	
Overheating .....	10-22
Power Messages .....	5-23
Pressure Light .....	5-17
Running While Parked .....	9-41
Starting .....	9-35
Engine Oil	
Life System .....	10-11
Messages .....	5-23
Equipment, Towing .....	9-78
Event Data Recorders .....	13-15
Exit Lighting .....	6-8
Extender, Safety Belt .....	3-26
Exterior Lamp Controls .....	6-1
Exterior Lamps Off Reminder ...	6-3

**F**

Fan	
Engine .....	10-24
Filter	
Engine Air Cleaner .....	10-17
Flash-to-Pass .....	6-3
Flashers, Hazard Warning .....	6-5
Flat Tire .....	10-64
Flat Tire, Changing .....	10-66, 10-75

Fluid	
Automatic Transmission ....	10-12
Brakes .....	10-27
Four-Wheel Drive	
Transfer Case .....	9-46
Power Steering .....	10-24
Washer .....	10-25
Fog Lamps	
Bulb Replacement .....	6-6
Folding Mirrors .....	2-13
Four-Wheel Drive .....	10-29, 9-46
Front Axle .....	10-29
Locking .....	9-55
Front Seats	
Adjustment .....	3-3
Heated .....	3-6
Front Storage .....	4-1
Fuel .....	9-64
Additives .....	9-65
E85 (85% Ethanol) .....	9-66
Filling a Portable Fuel Container .....	9-69
Filling the Tank .....	9-68

Fuel (cont.)  
 Fuels in Foreign Countries . . . . . 9-65  
 Gasoline Specifications . . . . . 9-65  
 Gauge . . . . . 5-8  
 Recommended . . . . . 9-64  
 Requirements, California . . . . . 9-65  
 System Messages . . . . . 5-24  
 Fuel Economy  
 Driving for Better . . . . . 1-18  
 Full-Size Spare Tire . . . . . 10-85  
 Fuses  
 Engine Compartment  
 Fuse Block . . . . . 10-39  
 Fuses and Circuit  
 Breakers . . . . . 10-39

**G**

Garage Door Opener . . . . . 5-26  
 Programming . . . . . 5-26  
 Gasoline  
 Specifications . . . . . 9-65

Gauges  
 Engine Coolant  
 Temperature . . . . . 5-9  
 Fuel . . . . . 5-8  
 Odometer . . . . . 5-8  
 Speedometer . . . . . 5-8  
 Tachometer . . . . . 5-8  
 Trip Odometer . . . . . 5-8  
 Warning Lights and  
 Indicators . . . . . 5-6  
 General Information  
 Service and Maintenance . . . . . 11-1  
 Towing . . . . . 9-70  
 Vehicle Care . . . . . 10-2  
 Glove Box . . . . . 4-1

**H**

Halogen Bulbs . . . . . 10-35  
 Hazard Warning Flashers . . . . . 6-5  
 Head Restraints . . . . . 3-2

Headlamps . . . . . 10-35  
 Aiming . . . . . 10-33  
 Automatic . . . . . 6-4  
 Bulb Replacement . . . . . 10-35  
 Daytime Running  
 Lamps (DRL) . . . . . 6-3  
 Flash-to-Pass . . . . . 6-3  
 High-Beam On Light . . . . . 5-17  
 High/Low Beam Changer . . . . . 6-3  
 Heated Front Seats . . . . . 3-6  
 Heater  
 Engine Coolant . . . . . 9-36  
 High-Beam On Light . . . . . 5-17  
 Highway Hypnosis . . . . . 9-22  
 Hill and Mountain Roads . . . . . 9-23  
 Hill Start Assist (HSA) . . . . . 9-52  
 Hood . . . . . 10-5  
 Horn . . . . . 5-2  
 How to Wear Safety Belts  
 Properly . . . . . 3-15  
 Hydraulic Clutch . . . . . 10-16

**I**

Ignition Positions .....	9-34
Ignition Transmission Lock Check .....	10-31
Immobilizer .....	2-10
Infants and Young Children, Restraints .....	3-44
Instrument Cluster .....	5-7
Introduction .....	iii, 7-1

**J**

Jump Starting .....	10-86
---------------------	-------

**K**

Keyless Entry Remote (RKE) System .....	2-3
Keyless Entry System .....	2-2
Keys .....	2-2

**L**

Labeling, Tire Sidewall .....	10-44
Lamp Messages .....	5-24
Lamps Daytime Running (DRL) .....	6-3
Dome .....	6-7
Exterior Controls .....	6-1
Exterior Lamps Off Reminder .....	6-3
License Plate .....	10-37
Malfunction Indicator .....	5-12
Off-Road .....	6-6
Reading .....	6-8
Lap-Shoulder Belt .....	3-20
LATCH System Replacing Parts After a Crash .....	3-59
Latch, Lower Anchors and Tethers for Children .....	3-51
Lighter, Cigarette .....	5-5
Lighting Exit .....	6-8
Illumination Control .....	6-7

**Lights**

Airbag Readiness .....	5-10
Antilock Brake System (ABS) Warning .....	5-15
Charging System .....	5-11
Cruise Control .....	5-18
Engine Oil Pressure .....	5-17
Flash-to-Pass .....	6-3
High-Beam On .....	5-17
High/Low Beam Changer .....	6-3
Safety Belt Reminders .....	5-9
Security .....	5-17
Tire Pressure .....	5-16
Traction Control System (TCS)/StabiliTrak® .....	5-16
Up-Shift .....	5-15
Locking Front Axle .....	9-55
Locking Rear Axle .....	9-54
Locks Automatic Door .....	2-6
Door .....	2-4
Lockout Protection .....	2-6
Power Door .....	2-5
Safety .....	2-6
Loss of Control .....	9-6

Lower Anchors and Tethers  
for Children (LATCH  
SYSTEM) ..... 3-51  
Lumbar Adjustment ..... 3-4  
Front Seats ..... 3-4

**M**

Maintenance  
Records ..... 11-11  
Maintenance Schedule  
Recommended Fluids and  
Lubricants ..... 11-8  
Scheduled Maintenance ..... 11-2  
Transfer Case Vent Filter ..... 9-46  
Malfunction Indicator Lamp ..... 5-12  
Manual Transmission ..... 9-44  
Fluid ..... 10-15  
Messages  
Battery Voltage and  
Charging ..... 5-21  
Brake System ..... 5-22  
Door Ajar ..... 5-22  
Engine Cooling System ..... 5-23  
Engine Oil ..... 5-23  
Engine Power ..... 5-23  
Fuel System ..... 5-24

Messages (cont.)  
Lamp ..... 5-24  
Ride Control System ..... 5-24  
Service Vehicle ..... 5-25  
Tire ..... 5-25  
Transmission ..... 5-25  
Vehicle ..... 5-21

Mirrors

Automatic Dimming  
Rearview ..... 2-14  
Convex ..... 2-13  
Folding ..... 2-13  
Power ..... 2-13

Monitor System, Tire

Pressure ..... 10-52

**N**

Navigation System  
Vehicle Data Recording  
and Privacy ..... 13-16  
Net, Convenience ..... 4-3  
New Vehicle Break-In ..... 9-33

**O**

Odometer ..... 5-8  
Trip ..... 5-8  
Off-Road ..... 9-7  
Driving ..... 9-7  
Lamps ..... 6-6  
Recovery ..... 9-5  
Oil  
Engine ..... 10-9  
Engine Oil Life System ..... 10-11  
Messages ..... 5-23  
Pressure Light ..... 5-17  
Older Children, Restraints ..... 3-42  
Online Owner Center ..... 13-4  
OnStar® System ..... 1-19  
Operation, Infotainment  
System ..... 7-2  
Outlets  
Power ..... 5-5  
Overheating, Engine ..... 10-22

**P**

Park	
Shifting Into .....	9-37
Shifting Out of .....	9-38
Parking .....	9-39
Brake .....	9-51
Brake and P (Park)	
Mechanism Check .....	10-31
Over Things That Burn .....	9-40
Passenger Airbag Status	
Indicator .....	5-11
Passenger Sensing System ...	3-35
Perchlorate Materials	
Requirements, California .....	10-3
Phone	
Bluetooth .....	7-15
Power	
Door Locks .....	2-5
Mirrors .....	2-13
Outlets .....	5-5
Protection, Battery .....	6-9
Retained Accessory (RAP) ...	9-35

Power (cont.)	
Seat Adjustment .....	3-3
Steering Fluid .....	10-24
Windows .....	2-16
Pregnancy, Using Safety	
Belts .....	3-25
Privacy	
Radio Frequency	
Identification (RFID) .....	13-16
Program	
Courtesy Transportation .....	13-8
Proposition 65 Warning,	
California .....	10-2

**R**

Radio Frequency	
Identification (RFID) .....	13-16
Statement .....	13-16
Radios	
AM-FM Radio .....	7-5
Reception .....	7-9
Satellite .....	7-6

Reading Lamps .....	6-8
Rear Axle .....	10-29
Locking .....	9-54
Rear Compartment/Storage	
Panel Cover .....	4-2
Rear Seats .....	3-7, 3-9
Rear Vision Camera (RVC) ....	9-60
Rear Window Washer/Wiper ....	5-3
Rearview Mirrors	
Automatic Dimming .....	2-14
Reclining Seatbacks .....	3-4
Recommended Fluids and	
Lubricants .....	11-8
Recommended Fuel .....	9-64
Records	
Maintenance .....	11-11
Recreational Vehicle	
Towing .....	10-90
Remote Keyless Entry	
(RKE) System .....	2-2, 2-3
Replacement Bulbs .....	10-37
Replacement Parts	
Airbags .....	3-42
Maintenance .....	11-10

Replacing Airbag System ..... 3-42

Replacing LATCH System  
 Parts After a Crash ..... 3-59

Replacing Safety Belt  
 System Parts After a  
 Crash ..... 3-27

Reporting Safety Defects  
 Canadian Government ..... 13-14  
 General Motors ..... 13-14  
 U.S. Government ..... 13-13

Retained Accessory  
 Power (RAP) ..... 9-35

Ride Control Systems  
 Messages ..... 5-24

Roadside Service ..... 13-5

Roof  
 Sunroof ..... 2-17

Roof Rack System ..... 4-4

Rotation, Tires ..... 10-57

Routing, Engine Drive Belt ..... 12-4

Running the Vehicle While  
 Parked ..... 9-41

**S**

Safety Belts ..... 3-10  
 Care ..... 3-26  
 Extender ..... 3-26  
 How to Wear Safety Belts  
 Properly ..... 3-15  
 Lap-Shoulder Belt ..... 3-20  
 Reminders ..... 5-9  
 Replacing After a Crash ..... 3-27  
 Use During Pregnancy ..... 3-25

Safety Defects Reporting  
 Canadian Government ..... 13-14  
 General Motors ..... 13-14  
 U.S. Government ..... 13-13

Safety Locks ..... 2-6

Safety System Check ..... 3-26

Satellite Radio ..... 7-6

Scheduled Maintenance ..... 11-2

Scheduling Appointments ..... 13-8

Seats  
 Adjustment, Front ..... 3-3  
 Head Restraints ..... 3-2  
 Heated Front ..... 3-6  
 Lumbar Adjustment, Front ..... 3-4

Seats (cont.)  
 Power Adjustment, Front ..... 3-3  
 Rear ..... 3-7, 3-9  
 Reclining Seatbacks ..... 3-4

Secondary Latch System ..... 10-84

Securing Child  
 Restraints ..... 3-59, 3-61, 3-62

Security  
 Light ..... 5-17  
 Vehicle ..... 2-9

Service  
 Accessories and  
 Modifications ..... 10-3  
 Doing Your Own Work ..... 10-4  
 Engine Soon Lamp ..... 5-12  
 Maintenance Records ..... 11-11  
 Maintenance, General  
 Information ..... 11-1  
 Parts Identification Label ..... 12-1  
 Publications Ordering  
 Information ..... 13-12  
 Scheduling Appointments ..... 13-8  
 Vehicle Messages ..... 5-25

Servicing the	
Airbag-Equipped Vehicle	3-40
Shifting	
Into Park	9-37
Out of Park	9-38
Signals, Turn and	
Lane-Change	6-5
Specifications and	
Capacities	12-2
Speedometer	5-8
StabiliTrak System	9-53
Start Assist, Hills	9-52
Starter Switch Check	10-30
Starting the Engine	9-35
Steering	9-4
Fluid, Power	10-24
Wheel Adjustment	5-2
Stoplamps and Back-Up Lamps	
Bulb Replacement	10-35, 10-36
Storage Areas	
Cargo Cover	4-2
Cargo Management System	4-2
Center Console	4-1
Convenience Net	4-3
Front	4-1

Storage Areas (cont.)	
Glove Box	4-1
Rear Compartment/Storage	
Panel Cover	4-2
Roof Rack System	4-4
Stuck Vehicle	9-26
Sun Visors	2-17
Sunroof	2-17
Symbols	iv
System	
Roof Rack	4-4
System Check	
Automatic Transmission	
Shiftlock Control	10-30

## T

Tachometer	5-8
Tailgate	2-7
Taillamps	
Bulb Replacement	10-35, 10-36
Text Telephone (TTY) Users	13-4
Theft-Deterrent	
Systems	2-10, 2-11
Immobilizer	2-10
Time	5-4

Tires	
Buying New Tires	10-59
Chains	10-64
Changing	10-66, 10-75
Designations	10-46
Different Size	10-60
Full-Size Spare	10-85
If a Tire Goes Flat	10-64
Inflation Monitor System	10-53
Inspection	10-57
Messages	5-25
Pressure Light	5-16
Pressure Monitor System	10-52
Rotation	10-57
Secondary Latch System	10-84
Sidewall Labeling	10-44
Terminology and	
Definitions	10-48
Uniform Tire Quality	
Grading	10-61
Wheel Alignment and Tire	
Balance	10-62
Wheel Replacement	10-63
When It Is Time for New	
Tires	10-58



Towing  
 Driving Characteristics .....9-70  
 Equipment .....9-78  
 General Information .....9-70  
 Recreational Vehicle ..... 10-90  
 Trailer .....9-74  
 Trailer Recommendations ....9-81  
 Vehicle ..... 10-90

Traction  
 Control System (TCS) .....9-52  
 Control System (TCS)/  
 StabiliTrak® Light .....5-16

Trailer  
 Towing Recommendations ....9-81

Trailer Towing .....9-74

Transfer Case  
 Vent Filter .....9-46

Transmission  
 Automatic .....9-41  
 Fluid, Automatic ..... 10-12  
 Fluid, Manual ..... 10-15  
 Messages .....5-25

Transportation Program,  
 Courtesy ..... 13-8

Trip Odometer ..... 5-8

Truck-Camper Loading  
 Information .....9-33

Turn and Lane-Change  
 Signals ..... 6-5

Turn Signal  
 Bulb Replacement ... 10-35, 10-36

**U**

Uniform Tire Quality  
 Grading .....10-61

Universal Remote System ..... 5-26  
 Operation .....5-30  
 Programming .....5-26

Up-Shift Light ..... 5-15

Using this Manual ..... iii

**V**

Vehicle  
 Canadian Owners .....iii  
 Control ..... 9-3  
 Load Limits .....9-27  
 Messages .....5-21  
 Security ..... 2-9  
 Towing ..... 10-90

Vehicle Care  
 Tire Pressure ..... 10-51

Vehicle Identification  
 Number (VIN) .....12-1  
 Service Parts Identification  
 Label .....12-1

Vent Filter  
 Transfer Case .....9-46

Ventilation, Air ..... 8-4

Visors ..... 2-17

**W**

Warning Lights, Gauges, and Indicators .....	5-6
Warnings .....	iii
Cautions and Danger .....	iii
Hazard Flashers .....	6-5
Washer Fluid .....	10-25
Wheels	
Alignment and Tire	
Balance .....	10-62
Different Size .....	10-60
Replacement .....	10-63
When It Is Time for New	
Tires .....	10-58
Where to Put the Child	
Restraint .....	3-49
Windows .....	2-15
Power .....	2-16
Windshield	
Wiper/Washer .....	5-2
Winter Driving .....	9-24
Wiper Blade Replacement ....	10-32
Wipers	
Rear Washer .....	5-3