

2013 Odyssey

Owner's Manual

(Unlinked)

This document does not contain hyperlinks and may be formatted for printing instead of web use. This is due to changes in content and specifications of the vehicle that happen throughout the model year. This manual will be replaced with a hyperlinked version at the end of the model year.

This owner's manual should be considered a permanent part of the vehicle and should remain with the vehicle when it is sold.

This owner's manual covers all models of your vehicle. You may find descriptions of equipment and features that are not on your particular model.

Images throughout this owner's manual (including the front cover) represent features and equipment that are available on some, but not all, models. Your particular model may not have some of these features.

This owner's manual is for vehicles sold in the United States and Canada.

The information and specifications included in this publication were in effect at the time of approval for printing. Honda Motor Co., Ltd. reserves the right, however, to discontinue or change specifications or design at any time without notice and without incurring any obligation.

➤ Safe Driving P. 25

For Safe Driving P. 26 Seat Belts P. 30 Airbags P. 39

➤ Instrument Panel P. 71

Indicators P. 72 Gauges and Displays P. 86

➤ Controls P. 107

Setting the Clock P. 108 Locking and Unlocking the Doors P. 109
Security System P. 133 Opening and Closing the Windows P. 136
Adjusting the Mirrors P. 151
Heating and Cooling* P. 182

➤ Features P. 193

Audio System P. 194 Audio System Basic Operation P. 197
Rear Entertainment System* P. 236 HomeLink® Universal Transceiver* P. 252

➤ Driving P. 279

Before Driving P. 280 Towing a Trailer P. 285
Rearview Camera P. 317 Refueling P. 318

➤ Maintenance P. 323

Before Performing Maintenance P. 324 Maintenance Minder™ P. 327
Checking and Maintaining Wiper Blades P. 358
Remote Control and Wireless Headphone Care* P. 374

➤ Handling the Unexpected P. 381

Tools P. 382 If a Tire Goes Flat P. 383
Overheating P. 396 Indicator, Coming On/Blinking P. 398
When You Cannot Open or Close the Tailgate P. 410

➤ Information P. 411

Specifications P. 412 Identification Numbers P. 414
Warranty Coverages P. 419 Authorized Manuals P. 421

Contents

Quick Reference Guide P. 2

Safe Driving P. 25

Instrument Panel P. 71

Controls P. 107

Features P. 193

Driving P. 279

Maintenance P. 323

Handling the Unexpected P. 381

Information P. 411

Index P. 425

Child Safety P. 54

Exhaust Gas Hazard P. 68

Safety Labels P. 69

Opening and Closing the Tailgate P. 119

Opening and Closing the Moonroof* P. 139

Adjusting the Seats P. 153

Climate Control System* P. 186

Opening and Closing the Sliding Doors P. 125

Operating the Switches Around the Steering Wheel P. 140

Interior Lights/Interior Convenience Items P. 168

Audio Error Messages P. 230

Bluetooth® HandsFreeLink® P. 254

General Information on the Audio System P. 232

Compass* P. 277

When Driving P. 291

Fuel Economy P. 321

Braking P. 308

Accessories and Modifications P. 322

Parking Your Vehicle P. 312

Maintenance Under the Hood P. 335

Checking and Maintaining Tires P. 362

Heating and Cooling System*/Climate Control System* Maintenance P. 376

Replacing Light Bulbs P. 347

Battery P. 371

Remote Transmitter Care P. 372

Cleaning P. 377

Engine Does Not Start P. 392

Fuses P. 403

Jump Starting P. 393

Emergency Towing P. 409

Shift Lever Does Not Move P. 395

Devices that Emit Radio Waves P. 415

Customer Service Information P. 422

Reporting Safety Defects P. 416

Gracenote® End User License Agreement P. 423

Emissions Testing P. 417

Visual Index

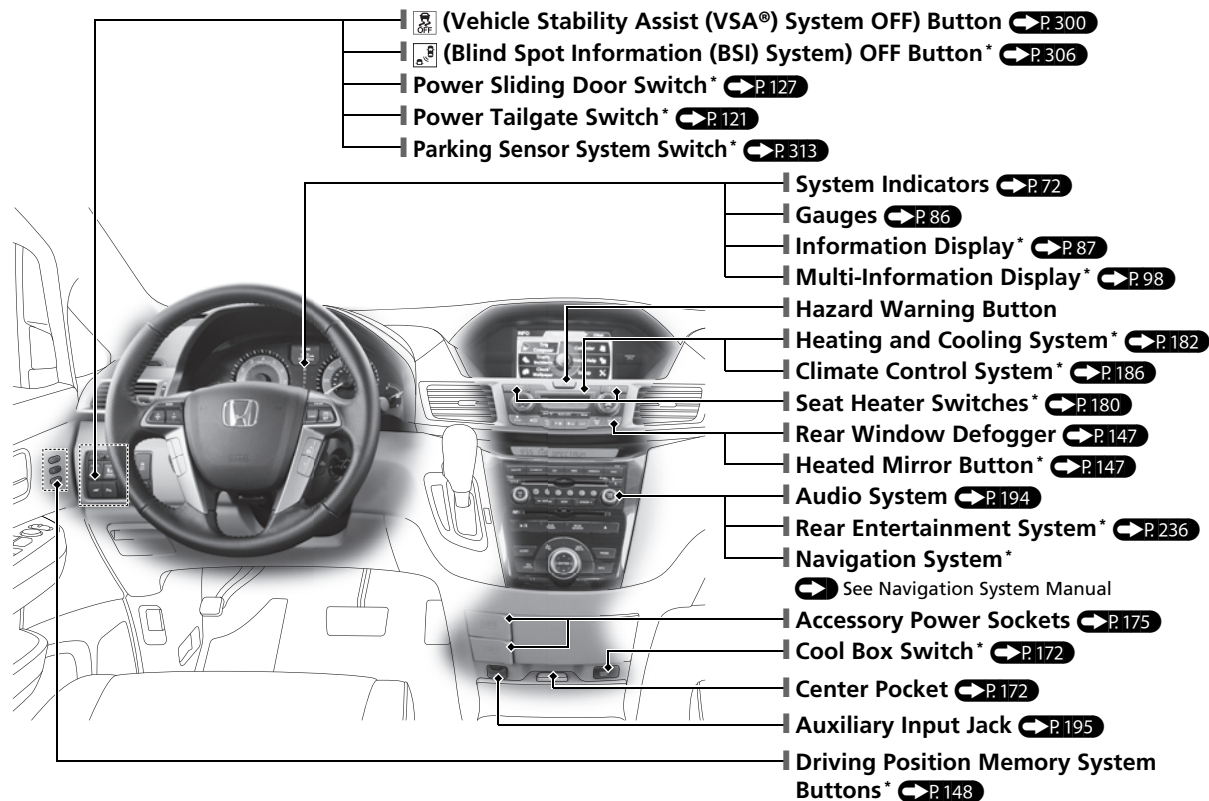

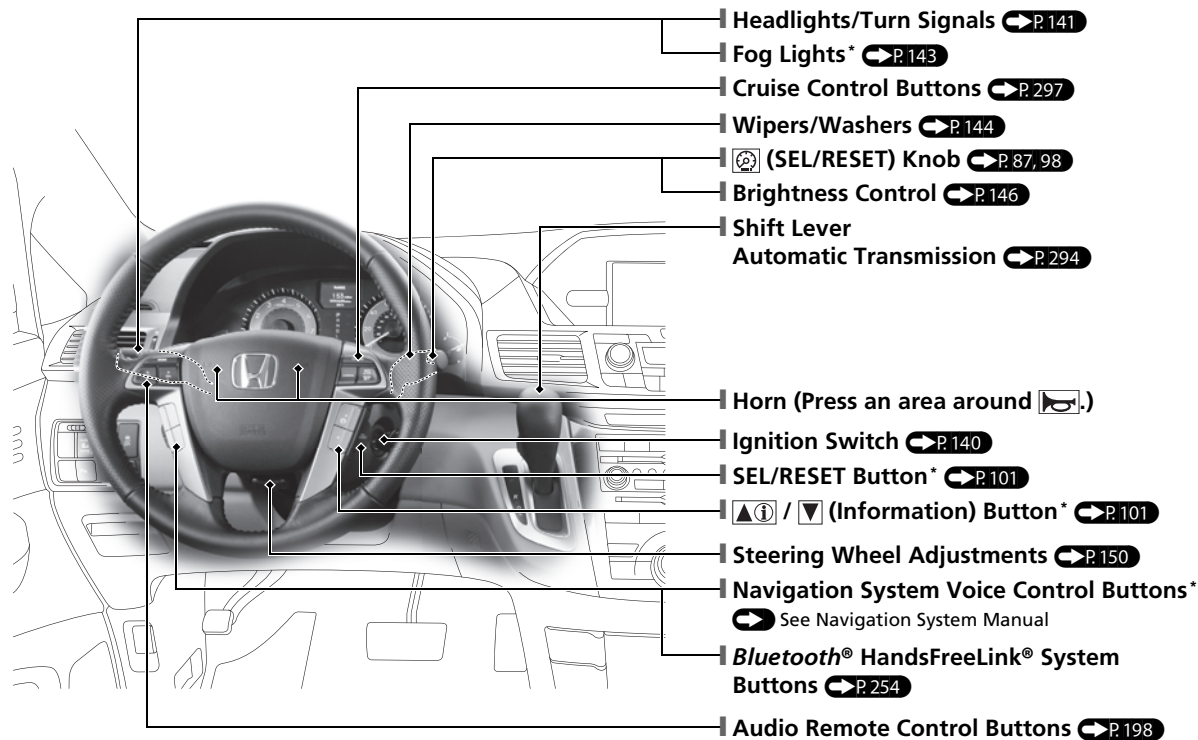

Visual Index

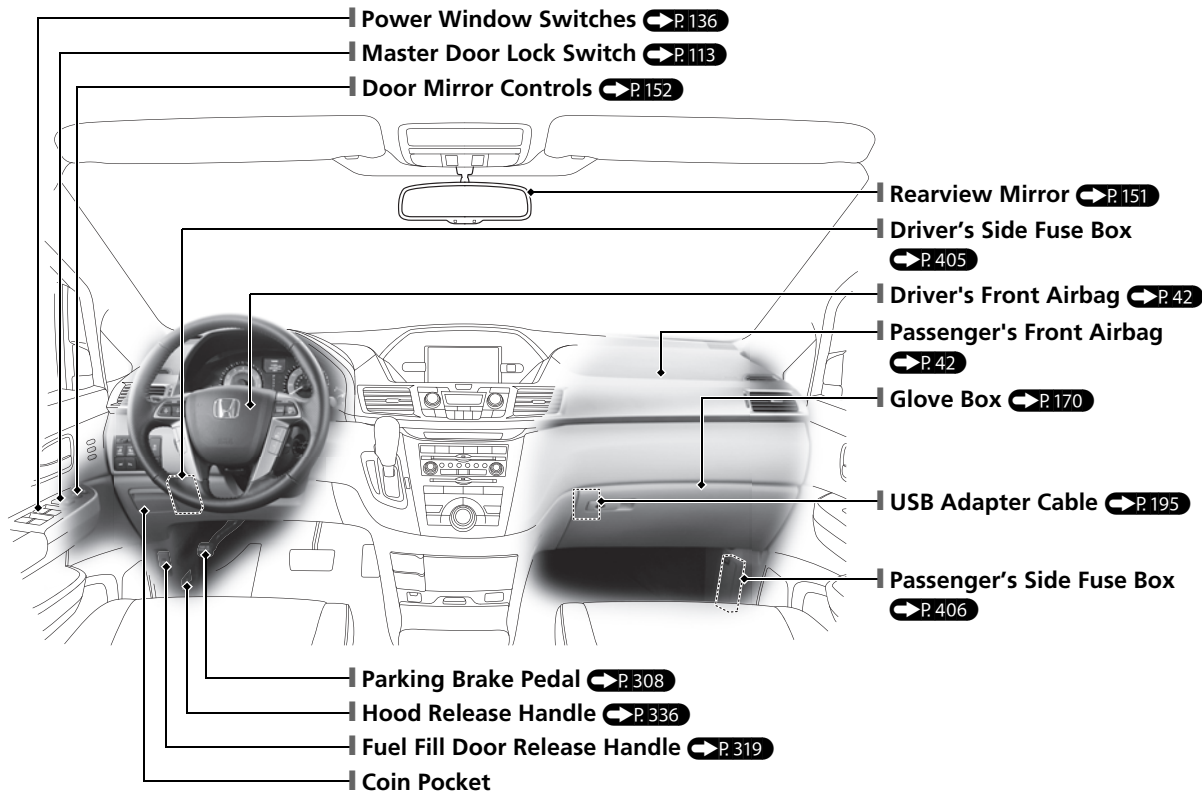

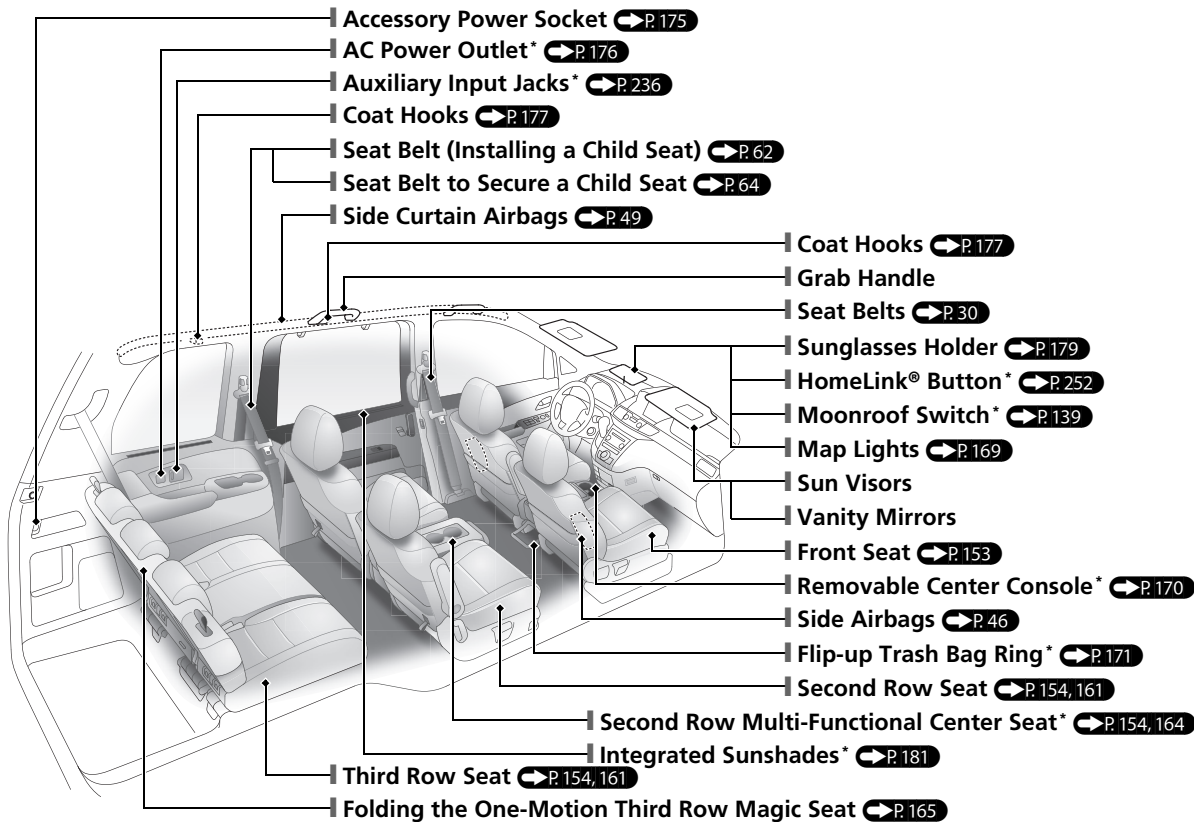

* Not available on all models

Visual Index

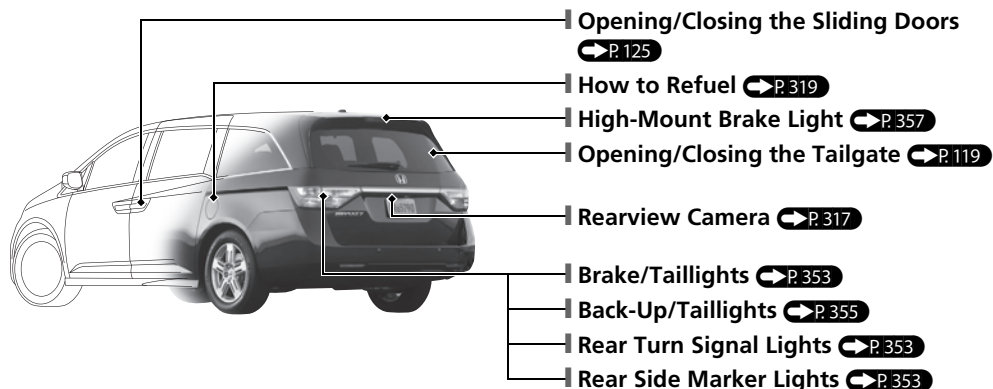
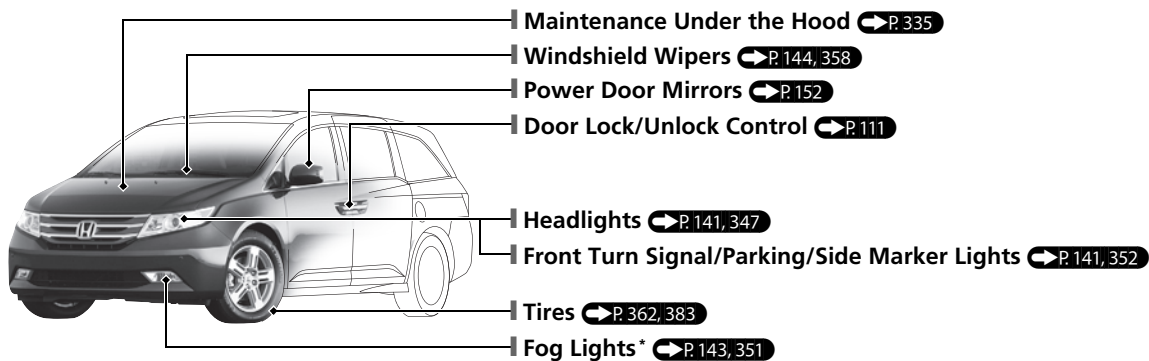

Safe Driving ➔ P.25

Airbags ➔ P.39

- Your vehicle is fitted with airbags to help protect you and your passengers during a moderate-to-severe collision.

Child Safety ➔ P.54

- All children 12 and younger should be seated in the rear seat.
- Smaller children should be properly restrained in a forward-facing child seat.
- Infants must be properly restrained in a rear-facing child seat.

Exhaust Gas Hazard ➔ P.68

- Your vehicle emits dangerous exhaust gases that contain carbon monoxide. Do not run the engine in confined spaces where carbon monoxide gas can accumulate.

Seat Belts ➔ P.30

- Fasten your seat belt and sit upright well back in the seat.
- Check that your passengers are wearing their seat belts correctly.

Before Driving Checklist ➔ P.29

- Before driving, check that the front seats, head restraints, steering wheel, and mirrors have been properly adjusted.

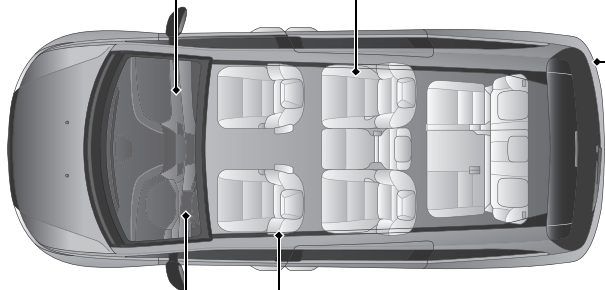









Fasten your lap belt as low as possible.

Instrument Panel P.71



Gauges  P.86 / Information Display*  P.87 /
Multi-Information Display*  P.98 / System Indicators  P.72

System Indicators

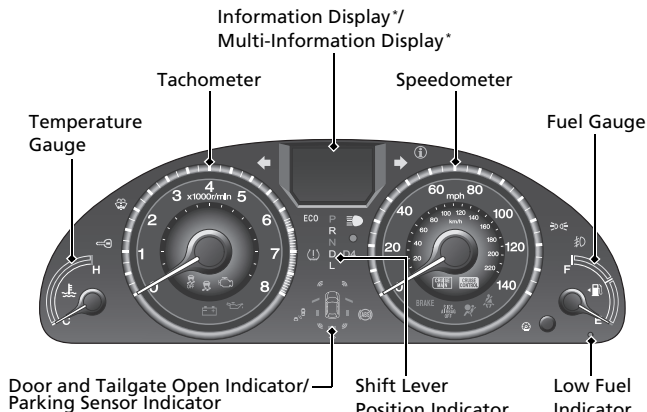

-  Malfunction Indicator Lamp
-  Low Oil Pressure Indicator
-  Charging System Indicator
- DRL** Daytime Running Lights Indicator
-  Vehicle Stability Assist (VSA®) System Indicator
-  VSA® OFF Indicator
-  Power Tailgate Indicator*
Canada
- ECO** Fuel Economy Indicator
-  Blind Spot Information System Indicator*
-  Immobilizer System Indicator
- BRAKE** Parking Brake and Brake System Indicator
U.S.

Canada













TPMS TPMS Indicator*

-  Low Tire Pressure Indicator* / Low Tire Pressure/ TPMS Indicator*
-  Maintenance Minder Indicator*
-  Washer Level Indicator*

Lights Reminders

-  Lights On Indicator
-  High Beam Indicator
-  Fog Light Indicator*

System Indicators

-  Turn Signal and Hazard Warning Indicators
-  Security System Alarm Indicator
-  Seat Belt Reminder Indicator
-  Supplemental Restraint System Indicator
-  Side Airbag Off U.S. Indicator
Canada
-  Cruise Main Indicator
-  Cruise Control Indicator
-  Starter System Indicator*
Canada
-  Power Sliding Door Indicator*
Canada
-  System Message Indicator*
-  Anti-lock Brake System (ABS) Indicator

Controls P.107

Turn Signals P.141

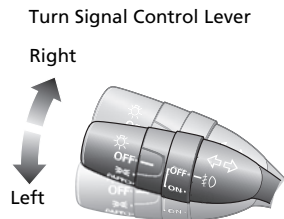

Lights P.141

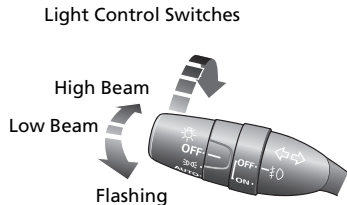

Wipers and Washers P.144

 P.144

Wiper/Washer Control Lever

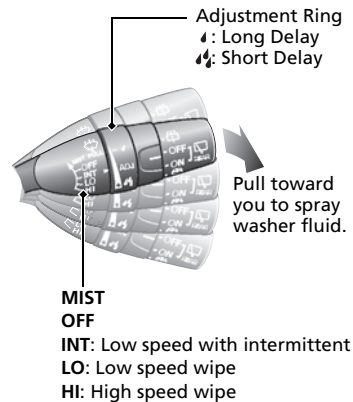

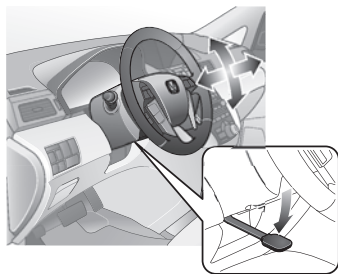

Steering Wheel P.150

- To adjust, push the adjustment lever down, adjust to the desired position, then pull up the lever back in place.



Power Sliding Door*

 P.127

- When the main switch is ON, the power sliding door opens and closes automatically when you press OPEN or CLOSE side of the  /  switch.



Tailgate P.119

Tailgate Release Button

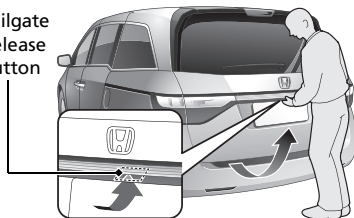

- To open the tailgate, push the tailgate release button, and lift up.

Models with the power tailgate

- Press the power tailgate button on the driver's door or the remote transmitter to open and close the power tailgate.

Power Door Mirrors P.152

- With the ignition switch in ON , move the selector switch to L or R.
- Push the appropriate edge of the adjustment switch to adjust the mirror.

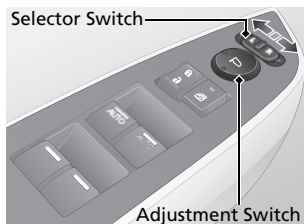

- Place the selector switch in the L or R position to use the reverse tilt door mirror feature.

Power Windows P.136

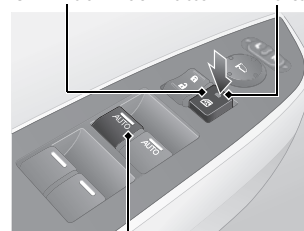

- With the ignition switch in ON , open and close the power windows.
- If the power window lock button is in the OFF position, the passenger's window can be opened and closed with its own switch.
- If the power window lock button is in the ON position (indicator is on), the passenger's window switch is disabled.

Power Window Lock Button Indicator





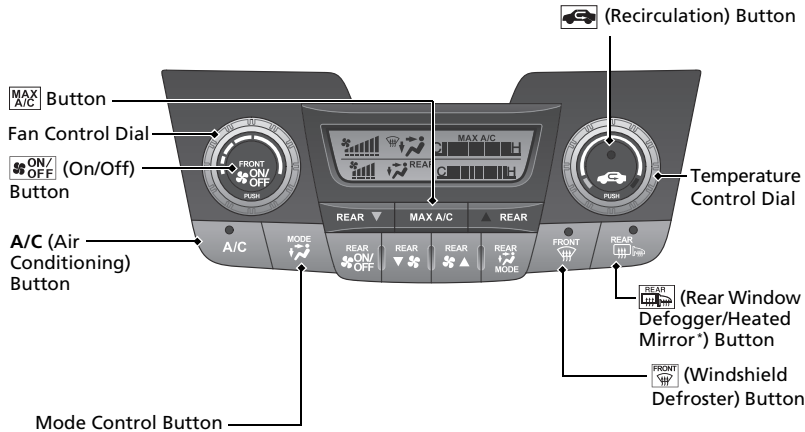

Window Switch

Heating and Cooling System* P.182



- Rotate the fan control dial to adjust the fan speed.
- Press the Mode button to select the vents air flows from.
- Rotate the temperature control dial to adjust the temperature.
- Use the  button for maximum cool setting.
- Press the  button to turn the system on or off.
- Press the  button to defrost the windshield.



- Mode Control Button
-  Air flows from dashboard vents.
 -  Air flows from floor and dashboard vents.
 -  Air flows from floor vents.
 -  Air flows from floor and windshield defroster vents.

* Not available on all models

Climate Control System*

- Press the **AUTO** button to activate the climate control system.
- Press the  button to turn the system on or off.
- Press the  button to defrost the windshield.

Models with navigation system

The climate control system is voice operable. See the navigation system manual for complete details.

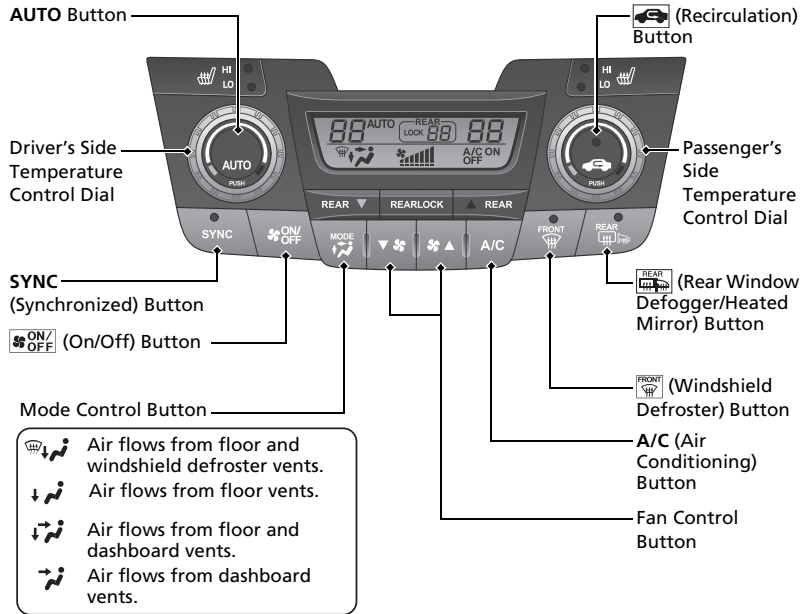



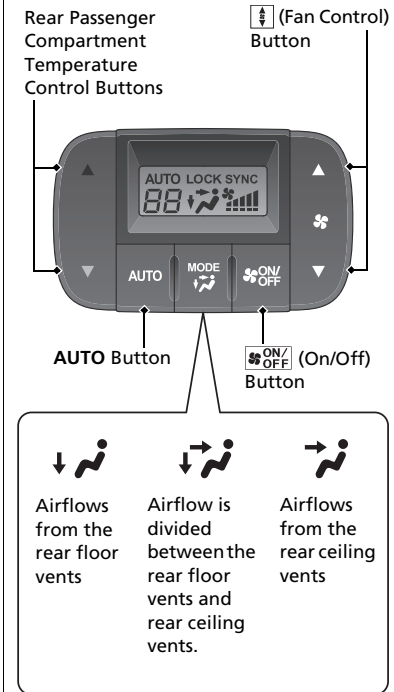

Rear Climate Control

- Press the **AUTO** button to activate the rear climate control system.
- Press the  button to turn the system on or off.

Rear Passenger Compartment Temperature Control Buttons



Clock P.108

- 1** Press the **CLOCK** button to access the clock adjustment mode screen.
- 2** Press  to select the item you want to adjust (12/24 hour mode, hour, minutes).
- 3** Rotate  to make the adjustment.
- 4** Press  to enter your selection. Repeat steps 2 to 4 to adjust other items.
- 5** To enter the selection, press  and select **EXIT**, then press .

Models with navigation system

The navigation system receives signals from GPS satellites, updating the clock automatically.

Features P.193

Audio system P.194

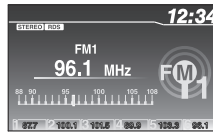

Models without rear entertainment system

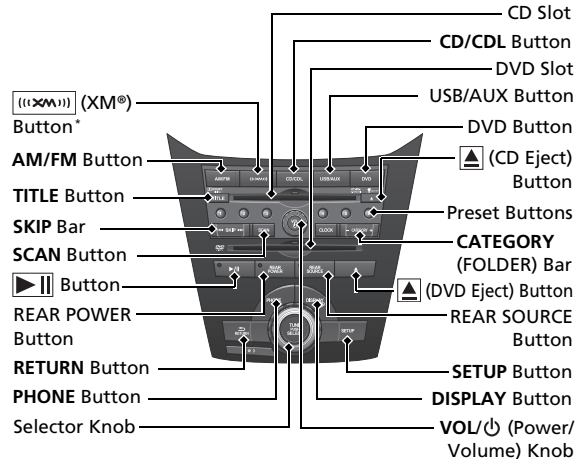
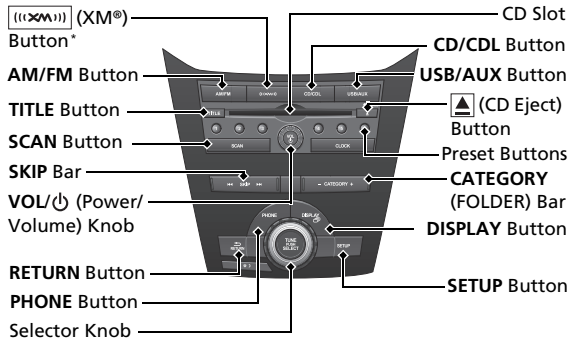

Models with rear entertainment system

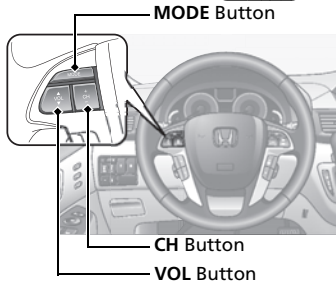

● **Audio Remote Controls**  P.198



● **VOL (Volume) Button**

Press  /  to adjust the volume up/down.

● **MODE Button**

Press and release to change the audio mode: FM1/FM2/AM/XM1'/XM2''/CD/CD-L/AUX.

● **CH (Channel) Button**

Radio: Press and release to change the preset station.
Press and hold to select the next or previous strong station.

CD/CD Library/USB device:

Press and release to skip to the beginning of the next song or return to the beginning of the current song.

CD/CD Library:

Press and hold to change a folder/album.

Driving ➔ P.279

Automatic Transmission ➔ P.295

- Shift to **P** and depress the brake pedal when starting the engine.

● Shifting

- P** **Park**
Turn off or start the engine.
Transmission is locked.
- R** **Reverse**
Used when reversing.
- N** **Neutral**
Transmission is not locked.
- D** **Drive**
Normal driving.
- L** **Low**
Strong engine braking.

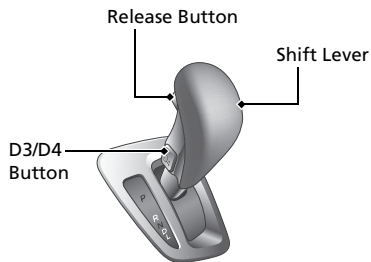

Models with D3 button

- D3**
Press the D3 button while the shift lever is in **D**.
Used when:
·Going up or down hills
·Towing a trailer in hilly terrain

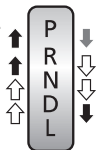

Depress the brake pedal and press the release button to move out of **P**.

Press the release button to move the shift lever.

Move the shift lever without pressing the release button.

Models with D4 button

- D4**
Press the D4 button while the shift lever is in **D**.
Used when:
·Going up or down hills
·Towing a trailer in hilly terrain

VSA® OFF Button P.301

- The vehicle stability assist (VSA®) system helps stabilize the vehicle during cornering, and helps maintain traction while accelerating on loose or slippery road surfaces.
- VSA® comes on automatically every time you start the engine.
- To turn VSA® on or off, press and hold the button until you hear a beep.

Cruise Control P.297

- Cruise control allows you to maintain a set speed without keeping your foot on the accelerator pedal.
- To use cruise control, press the **CRUISE** button, then press **DECEL/SET** once you have achieved the desired speed (above 25 mph or 40 km/h).

Tire Pressure Monitoring System (TPMS) P.302

- TPMS monitors tire pressure.
- TPMS is turned on automatically every time you start the engine.

Refueling P.318

Fuel recommendation: Unleaded gasoline with a pump octane number 87 or higher required

Fuel tank capacity: 21 US gal (79.5 L)

- 1** Pull the fuel fill door release handle.

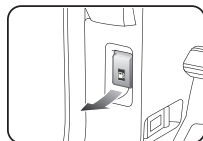

- 2** Turn the fuel fill cap slowly to remove the cap.

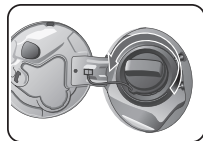

- 3** Place the cap in the holder on the fuel fill door.

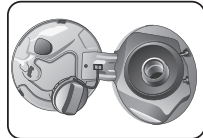

- 4** After refueling, screw the cap back on until it clicks at least once.



Maintenance ↔ P. 323

Under the Hood ↔ P. 335

- Check engine oil, engine coolant, and window washer fluid. Add when necessary.
- Check brake fluid.
- Check the battery regularly.

- 1 Pull the hood release handle under the corner of the dashboard.



- 2 Locate the hood latch lever, slide the lever, and lift up the hood.

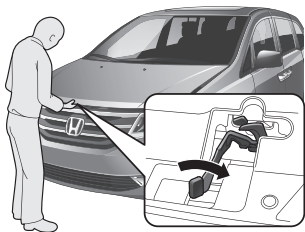

- 3 When finished, close the hood and make sure it is firmly locked in place.

Wiper Blades ↔ P. 358

- Replace blades if they leave streaks across the windshield.

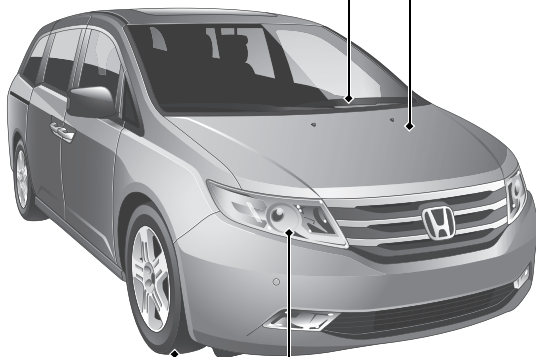

Tires ↔ P. 362

- Inspect tires and wheels regularly.
- Check tire pressures regularly.
- Install snow tires for winter driving.

Lights ↔ P. 347

- Inspect all lights regularly.

Handling the Unexpected ➔ P.381

Flat Tire ➔ P.383

- Park in a safe location and replace the flat tire with the compact spare tire in under the floor between the front seats and the second row seats.



Indicators Come On ➔ P.398

- Identify the indicator and consult the owner's manual.

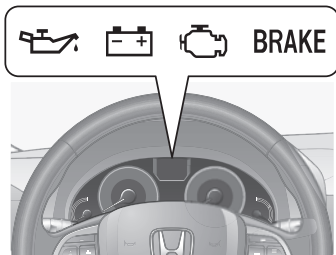

Engine Won't Start ➔ P.392

- If the battery is dead, jump start using a booster battery.



Blown Fuse ➔ P.403

- Check for a blown fuse if an electrical device does not operate.

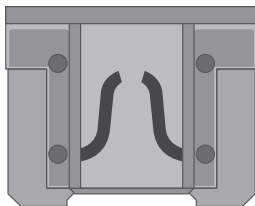

Overheating ➔ P.396

- Park in a safe location. If you do not see steam under the hood, open the hood, and let the engine cool down.



Emergency Towing ➔ P.409

- Call a professional towing service if you need to tow your vehicle.



What to Do If

Q The ignition switch does not turn from **0** to **1**.
Why?

A

- The steering wheel may be locked.
- Try to turn the steering wheel left and right while turning the ignition key.



Q The ignition switch does not turn from **1** to **0** and I cannot remove the key.
Why?

A The shift lever should be moved to **P**.



Q Why does the brake pedal pulsate slightly when applying the brakes?

A This can occur when the ABS activates, and does not indicate a problem. Apply firm, steady pressure on the brake pedal. Never pump the brake pedal.

Q The rear door cannot be opened from inside the vehicle. Why?

A Check if the childproof lock is in the LOCK position. If so, open the rear door with the outside door handle. To cancel this function, push the lever to the UNLOCK position.



Q Why do the doors lock after I unlocked the doors using a remote transmitter?

A If you do not open the doors within 30 seconds, the doors are relocked automatically for security.

Q Why does the beeper sound when I open the driver's door?

A The beeper sounds when:

- The key is left in the ignition switch.
- The exterior lights are left on.

Q Why does the beeper sound when I start driving?

A The beeper sounds when:

- Driver and/or front passenger are not wearing their seat belts.
- The parking brake lever is not fully released.

Q Why do I hear a screeching sound when I apply the brake pedal?

A The brake pads may need to be replaced. Have your vehicle inspected by a dealer.

California Proposition 65 Warning

WARNING: This product contains or emits chemicals known to the state of California to cause cancer and birth defects or other reproductive harm.

Event Data Recorders

This vehicle is equipped with an event data recorder (EDR).

The main purpose of an EDR is to record, in certain crash or near crash-like situations, such as an air bag deployment or hitting a road obstacle, data that will assist in understanding how a vehicle's systems performed. **The EDR is designed to record data related to vehicle dynamics and safety systems for a short period of time, typically 30 seconds or less. The EDR in this vehicle is designed to record such data as:**

- **How various systems in your vehicle were operating;**
- **Whether or not the driver and passenger safety belts were buckled/fastened;**
- **How far (if at all) the driver was depressing the accelerator and/or brake pedal; and,**
- **How fast the vehicle was traveling.**

These data can help provide a better understanding of the circumstances in which crashes and injuries occur. NOTE: EDR data are recorded by your vehicle only if a non-trivial crash situation occurs; no data are recorded by the EDR under normal driving conditions and no personal data (e.g., name, gender, age, and crash location) are recorded. However, other parties, such as law enforcement, could combine the EDR data with the type of personally identifying data routinely acquired during a crash investigation.

To read data recorded by an EDR, special equipment is required, and access to the vehicle or the EDR is needed. In addition to the vehicle manufacturer, other parties, such as law enforcement, that have the special equipment, can read the information if they have access to the vehicle or the EDR.

The data belongs to the vehicle owner and may not be accessed by anyone else except as legally required or with the permission of the vehicle owner.

Service Diagnostic Recorders

This vehicle is equipped with service-related devices that record information about powertrain performance. The data can be used to verify emissions law requirements and/or help technicians diagnose and solve service problems. It may also be combined with data from other sources for research purposes, but it remains confidential.

California Perchlorate Contamination Prevention Act

The airbags, seat belt tensioners, and CR type batteries in this vehicle may contain perchlorate materials - special handling may apply. See www.dtsc.ca.gov/hazardouswaste/perchlorate/

As you read this manual, you will find information that is preceded by a **NOTICE** symbol. This information is intended to help you avoid damage to your vehicle, other property, or the environment.

A Few Words About Safety

Your safety, and the safety of others, is very important. And operating this vehicle safely is an important responsibility.

To help you make informed decisions about safety, we have provided operating procedures and other information on labels and in this manual. This information alerts you to potential hazards that could hurt you or others.

Of course, it is not practical or possible to warn you about all the hazards associated with operating or maintaining your vehicle. You must use your own good judgement.

You will find this important safety information in a variety of forms, including:

- **Safety Labels** - on the vehicle.
- **Safety Messages** - preceded by a safety alert symbol  and one of three signal words: **DANGER**, **WARNING**, or **CAUTION**. These signal words mean:

 **DANGER**

You **WILL** be **KILLED** or **SERIOUSLY HURT** if you don't follow instructions.

 **WARNING**

You **CAN** be **KILLED** or **SERIOUSLY HURT** if you don't follow instructions.

 **CAUTION**

You **CAN** be **HURT** if you don't follow instructions.

- **Safety Headings** - such as Important Safety Precautions.
- **Safety Section** - such as Safe Driving.
- **Instructions** - how to use this vehicle correctly and safely.

This entire book is filled with important safety information - please read it carefully.

Safe Driving

You can find many safety recommendations throughout this chapter, and throughout this manual.

For Safe Driving

Important Safety Precautions	26
Your Vehicle's Safety Features.....	28

Seat Belts

About Your Seat Belts.....	30
Fastening a Seat Belt.....	33
Seat Belt Inspection.....	38

Airbags

Airbag System Components.....	39
Types of Airbags	42
Front Airbags (SRS)	42
Side Airbags.....	46

Side Curtain Airbags.....	49
Airbag System Indicators.....	50
Airbag Care	53

Child Safety

Protecting Child Passengers	54
Safety of Infants and Small Children	56
Safety of Larger Children	66

Exhaust Gas Hazard

Carbon Monoxide Gas.....	68
--------------------------	----

Safety Labels

Label Locations	69
-----------------------	----

The following pages explain your vehicle's safety features and how to use them properly. The safety precautions below are ones that we consider to be among the most important.

Important Safety Precautions

■ Always wear your seat belt

A seat belt is your best protection in all types of collisions. Airbags are designed to supplement seat belts, not replace them. So even though your vehicle is equipped with airbags, make sure you and your passengers always wear your seat belts, and wear them properly.

■ Restrain all children

Children age 12 and under should ride properly restrained in a back seat, not the front seat. Infants and small children should be restrained in a child seat. Larger children should use a booster seat and a lap/shoulder seat belt until they can use the belt properly without a booster seat.

■ Be aware of airbag hazards

While airbags can save lives, they can cause serious or fatal injuries to occupants who sit too close to them, or are not properly restrained. Infants, young children, and short adults are at the greatest risk. Be sure to follow all instructions and warnings in this manual.

■ Don't drink and drive

Alcohol and driving don't mix. Even one drink can reduce your ability to respond to changing conditions, and your reaction time gets worse with every additional drink. So don't drink and drive, and don't let your friends drink and drive, either.

⊗ Important Safety Precautions

Some states, provinces and territories prohibit the use of cell phones other than hands-free devices by the driver while driving.

■ Pay appropriate attention to the task of driving safely

Engaging in cell phone conversation or other activities that keep you from paying close attention to the road, other vehicles, and pedestrians could lead to a crash. Remember, situations can change quickly, and only you can decide when it is safe to divert some attention away from driving.

■ Control your speed

Excessive speed is a major factor in crash injuries and deaths. Generally, the higher the speed, the greater the risk, but serious injuries can also occur at lower speeds. Never drive faster than is safe for current conditions, regardless of the maximum speed posted.

■ Keep your vehicle in safe condition

Having a tire blowout or a mechanical failure can be extremely hazardous. To reduce the possibility of such problems, check your tire pressures and condition frequently, and perform all regularly scheduled maintenance.

Your Vehicle's Safety Features

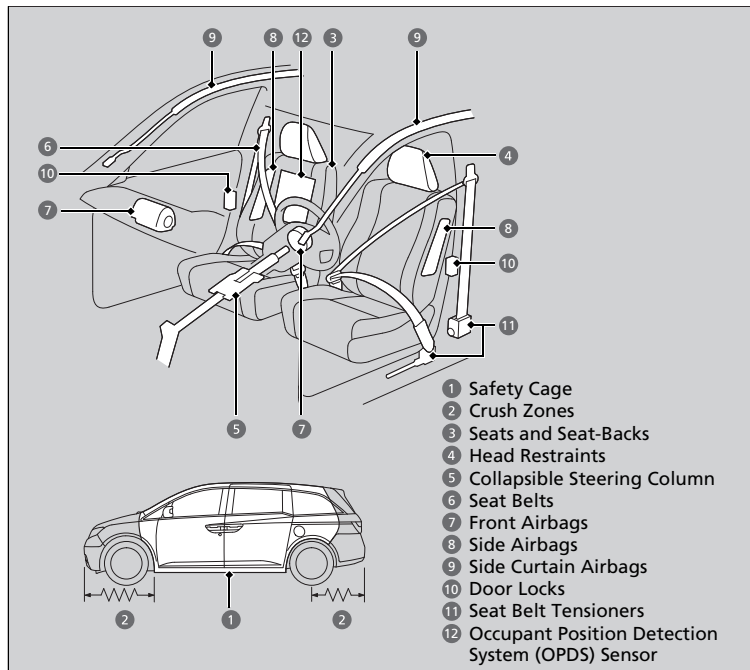

The following checklist will help you take an active role in protecting yourself and your passengers.

▣ Your Vehicle's Safety Features

Your vehicle is equipped with many features that work together to help protect you and your passengers during a crash.

Some features do not require any action on your part. These include a strong steel framework that forms a safety cage around the passenger compartment, front and rear crush zones, a collapsible steering column, and tensioners that tighten the front seat belts in a sufficient crash.

However, you and your passengers cannot take full advantage of these features unless you remain seated in the correct position and always wear your seat belts. In fact, some safety features can contribute to injuries if they are not used properly.

Safety Checklist

For the safety of you and your passengers, make a habit of checking these items each time before you drive.

- After everyone has entered the vehicle, be sure all doors and the tailgate are closed and locked. Locking the doors helps prevent an occupant from being ejected and an outsider from unexpectedly opening a door.
 - ▶ **Locking/Unlocking the Doors from the Inside** P. 113
- Adjust your seat to a position suitable for driving. Be sure the front seats are adjusted as far to the rear as possible while allowing the driver to control the vehicle. Sitting too close to a front airbag can result in serious or fatal injury in a crash.
 - ▶ **Adjusting the Seats** P. 153
- Adjust head restraints to the proper position. Head restraints are most effective when the center of the head restraint aligns with the center of your head. Taller persons should adjust their head restraint to the highest position.
 - ▶ **Adjusting the Head Restraints** P. 156
- Always wear your seat belt, and make sure you wear it properly. Confirm that any passengers are properly belted as well.
 - ▶ **Fastening a Seat Belt** P. 33
- Protect children by using seat belts or child seats according to a child's age, height and weight.
 - ▶ **Child Safety** P. 54

* Not available on all models

▶▶ Safety Checklist

If the door and tailgate open indicator is on, a door or the tailgate is not completely closed. Close all doors tightly until the indicator goes off.

▶ **Door and Tailgate Open Indicator** P. 77

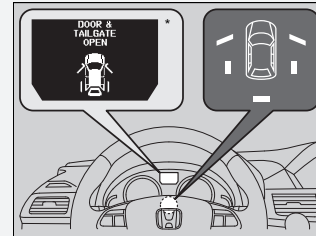

About Your Seat Belts

Seat belts are the single most effective safety device because they keep you connected to the vehicle so that you can take advantage of many built-in safety features. They also help keep you from being thrown against the inside of the vehicle, against other passengers, or out of the vehicle. When worn properly, seat belts also keep your body properly positioned in a crash so that you can take full advantage of the additional protection provided by the airbags.

In addition, seat belts help protect you in almost every type of crash, including:

- frontal impacts
- side impacts
- rear impacts
- rollovers

■ Lap/shoulder seat belts

All seven or eight seating positions are equipped with lap/shoulder seat belts with emergency locking retractors. In normal driving the retractor lets you move freely while keeping some tension on the belt. During a collision or sudden stop the retractor locks to restrain your body. The second and third row passenger's seat belts also have a lockable retractor for use with child seats.

➤ **Installing a Child Seat with a Lap/Shoulder Seat Belt** P. 62

>About Your Seat Belts

WARNING

Not wearing a seat belt properly increases the chance of serious injury or death in a crash, even though your vehicle has airbags.

Be sure you and your passengers always wear seat belts and wear them properly.

Seat belts cannot completely protect you in every crash. But in most cases, seat belts can reduce your risk of serious injury.

Most states and all Canadian provinces and territories require you to wear seat belts.

■ Proper use of seat belts

Follow these guidelines for proper use:

- All occupants should sit upright, well back in the seat, and remain in that position for the duration of the trip. Slouching and leaning reduces the effectiveness of the belt and can increase the chance of serious injury in a crash.
- Never place the shoulder part of a lap/shoulder seat belt under your arm or behind your back. This could cause very serious injuries in a crash.
- Two people should never use the same seat belt. If they do, they could be very seriously injured in a crash.
- Do not put any accessories on the seat belts. Devices intended to improve comfort or reposition the shoulder part of a seat belt can reduce the protective capability and increase the chance of serious injury in a crash.

■ Seat Belt Reminder



Your vehicle monitors front seat belt use. If the ignition switch is turned to ON **II** before the driver's seat belt is fastened, a beeper will sound and the indicator will blink. If the driver does not fasten the belt before the beeper stops, the indicator will remain on.

The beeper will also periodically sound and the indicator will blink while driving until the driver's and front passenger's seat belts are fastened.

»» About Your Seat Belts

If a rear seat passenger moves around and extends the seat belt, the lockable retractor may activate. If this happens, release the retractor by unfastening the seat belt and allow the belt to retract completely. Then refasten the belt.

»» Seat Belt Reminder

The indicator will also come on if a front passenger does not fasten their seat belt within 6 seconds after the ignition switch is turned to ON **II**. When no one is sitting in the front passenger's seat, or a child or small adult is riding there, the indicator will not come on. This is because the weight sensors in the seat cannot detect their presence.

Automatic Seat Belt Tensioners

The front seats are equipped with automatic seat belt tensioners to enhance safety.

The tensioners automatically tighten the front seat belts during a moderate-to-severe frontal collision, sometimes even if the collision is not severe enough to inflate the front airbags.

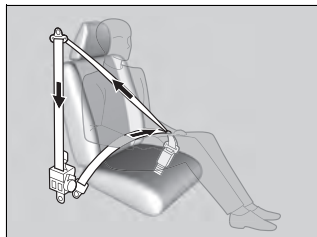

Automatic Seat Belt Tensioners

The seat belt tensioners can only operate once. If a tensioner is activated, the SRS indicator will come on. Have a dealer replace the tensioner and thoroughly inspect the seat belt system as it may not offer protection in a subsequent crash.

During a moderate-to-severe side impact, the tensioner on that side of the vehicle also activates.

Fastening a Seat Belt

After adjusting a front seat to the proper position, and while sitting upright and well back in the seat:

Adjusting the Seats P. 153

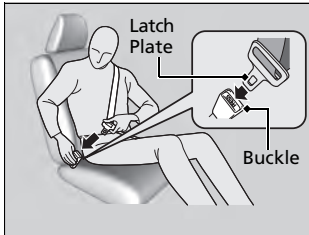
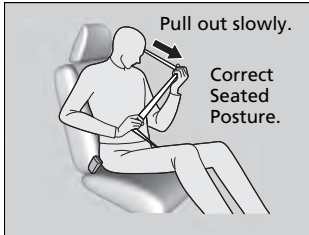

1. Pull the seat belt out slowly.

2. Insert the latch plate into the buckle, then tug on the belt to make sure the buckle is secure.
- ▶ Make sure that the belt is not twisted or caught on anything.

Fastening a Seat Belt

No one should sit in a seat with an inoperative seat belt or one that does not appear to be working correctly. Using a seat belt that is not working properly may not protect the occupant in a crash. Have a dealer check the belt as soon as possible.

Never insert any foreign objects into the buckle or retractor mechanism.

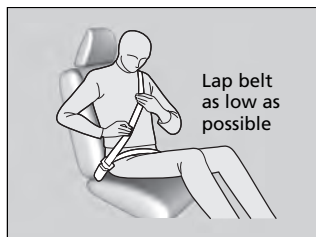

3. Position the lap part of the belt as low as possible across your hips, then pull up on the shoulder part of the belt so the lap part fits snugly. This lets your strong pelvic bones take the force of a crash and reduces the chance of internal injuries.
4. If necessary, pull up on the belt again to remove any slack, then check that the belt rests across the center of your chest and over your shoulder. This spreads the forces of a crash over the strongest bones in your upper body.

Adjusting the Shoulder Anchor

The front seats and second row seats have adjustable shoulder anchors to accommodate taller and shorter occupants.

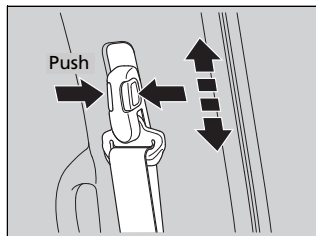

1. Move the anchor up and down while holding the release button.
2. Position the anchor so that the belt rests across the center of your chest and over your shoulder.

Fastening a Seat Belt

⚠ WARNING

Improperly positioning the seat belts can cause serious injury or death in a crash.

Make sure all seat belts are properly positioned before driving.

To release the belt, push the red PRESS button then guide the belt by hand until it has retracted completely. When exiting the vehicle, be sure the belt is out of the way and will not get caught by closing the door.

Adjusting the Shoulder Anchor

The shoulder anchor height can be adjusted to four levels. If the belt contacts your neck, lower the height one level at a time.

After an adjustment, make sure that the shoulder anchor position is secure.

Seat Belt with Detachable Anchor

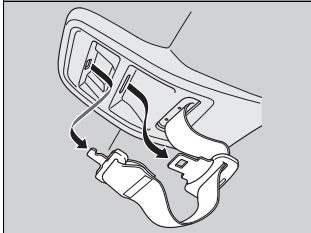

1. Pull out the seat belt's small latch plate and the latch plate from each holding slot in the ceiling.

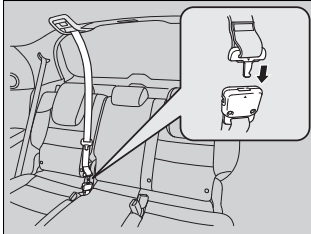

2. Line up the triangle marks on the small latch plate and anchor buckle. Make sure the seat belt is not twisted. Attach the belt to the anchor buckle.

Seat Belt with Detachable Anchor

⚠ WARNING

Using the seat belt with the detachable anchor unlatched increases the chance of serious injury or death in a crash.

Before using the seat belt, make sure the detachable anchor is correctly latched.

Continued

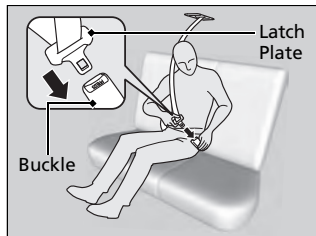

3. Insert the latch plate into the buckle.
Properly fasten the seat belt the same way you fasten the lap/shoulder seat belt.

▶▶ Seat Belt with Detachable Anchor

To unlatch the detachable anchor, insert a key into the slot on the side of the anchor buckle.

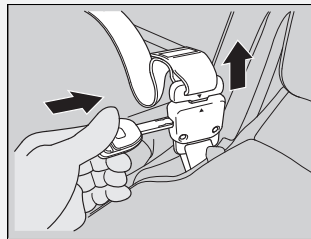

Second row center seat

Pivot down the anchor buckle forward. Insert a key into the slot on the back of the anchor buckle.

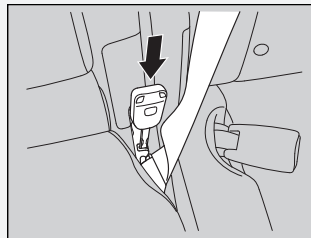

Advice for Pregnant Women

If you are pregnant, the best way to protect yourself and your unborn child when driving or riding in a vehicle is to always wear a seat belt and keep the lap part of the belt as low as possible across the hips.

Wear the shoulder belt across the chest avoiding the abdomen.



Wear the lap part of the belt as low as possible across the hips.

Advice for Pregnant Women

Each time you have a checkup, ask your doctor if it is okay for you to drive.

To reduce the risk of injuries to both you and your unborn child that can be caused by an inflating front airbag:

- When driving, sit upright and adjust the seat as far back as possible while allowing full control of the vehicle.
- When sitting in the front passenger's seat, adjust the seat as far back as possible.

Seat Belt Inspection

Regularly check the condition of your seat belts as follows:

- Pull each belt out fully, and look for frays, cuts, burns, and wear.
- Check that the latches work smoothly and the belts retract easily.
 - If a belt does not retract easily, cleaning the belt may correct the problem. Only use a mild soap and warm water. Do not use bleach or cleaning solvents. Make sure the belt is completely dry before allowing it to retract.

Any belt that is not in good condition or working properly will not provide proper protection and should be replaced as soon as possible.

A belt that has been worn during a crash may not provide the same level of protection in a subsequent crash. Have your seat belts inspected by a dealer after any collision.

Seat Belt Inspection

⚠ WARNING

Not checking or maintaining seat belts can result in serious injury or death if the seat belts do not work properly when needed.

Check your seat belts regularly and have any problem corrected as soon as possible.

Airbag System Components

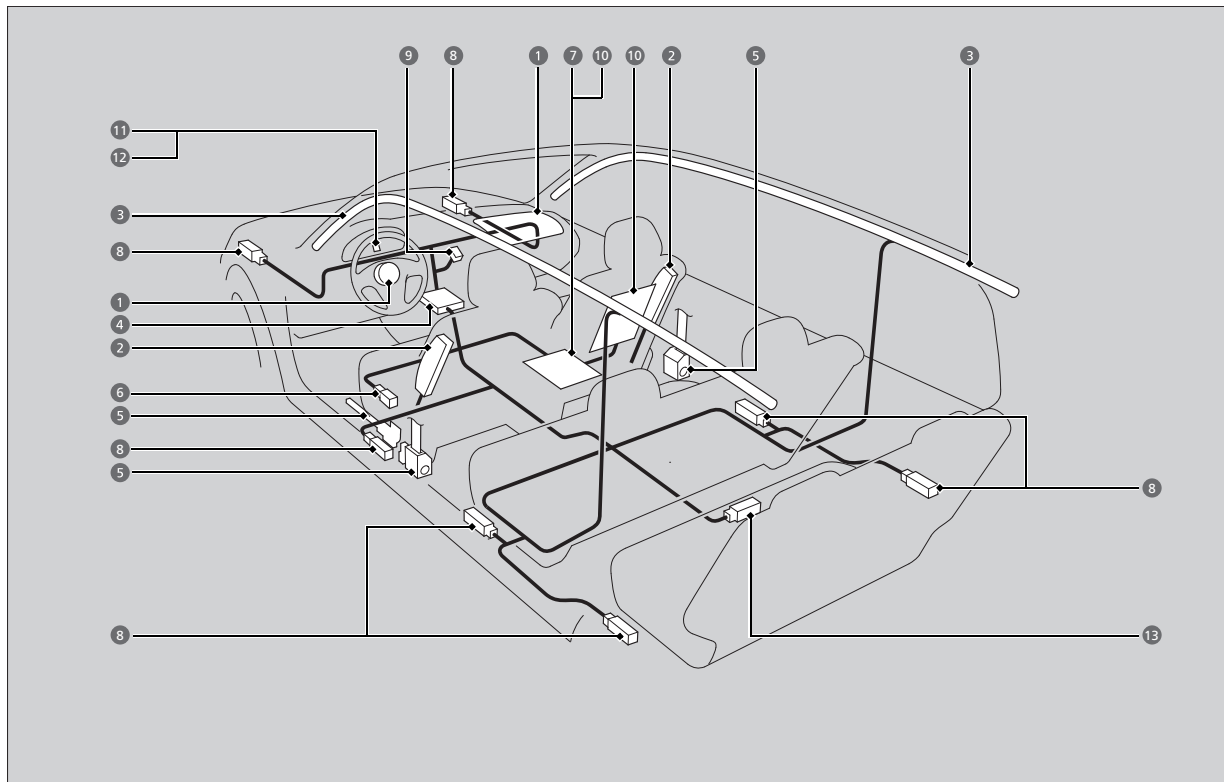

The front, front side, and side curtain airbags are deployed according to the direction and severity of impact. The airbag system includes:

- 1 Two SRS (Supplemental Restraint System) front airbags. The driver's airbag is stored in the center of the steering wheel; the front passenger's airbag is stored in the dashboard. Both are marked **SRS AIRBAG**.
- 2 Two side airbags, one for the driver and one for a front passenger. The airbags are stored in the outer edges of the seat-backs. Both are marked **SIDE AIRBAG**.
- 3 Two side curtain airbags, one for each side of the vehicle. The airbags are stored in the ceiling, above the side windows. The front and rear pillars are marked **SIDE CURTAIN AIRBAG**.
- 4 An electronic control unit that continually monitors and records information about the sensors, the airbag activators, the seat belt tensioners, and driver and front passenger seat belt use when the ignition switch is in ON **II**.
- 5 Automatic front seat belt tensioners. The driver's and front passenger's seat belts incorporate sensors that detect whether or not they are fastened.
- 6 A driver's seat position sensor. If the seat is too far forward, the airbag will inflate with less force.
- 7 Weight sensors in the front passenger's seat. The front passenger's airbag will be turned off if the weight on the seat is 65 lbs (29 kg) or less (the weight of an infant or small child).
- 8 Impact sensors that can detect a moderate to severe front or side collision.
- 9 An indicator on the dashboard that alerts you that the front passenger's front airbag has been turned off.
- 10 Sensors that can detect if a child or small statured adult is in the deployment path of the front passenger's side airbag.
- 11 An indicator on the instrument panel that alerts you to a possible problem with your airbag system or seat belt tensioners.
- 12 An indicator on the instrument panel that alerts you that the front passenger's side airbag has been turned off.
- 13 A rollover sensor that can detect if your vehicle is about to roll over and signal the control unit to deploy both side curtain airbag.

■ Important facts about your airbags

Airbags can pose serious hazards. To do their job, airbags must inflate with tremendous force. So, while airbags help save lives, they can cause burns, bruises, and other minor injuries, and sometimes even fatal ones if occupants are not wearing their seat belts properly and sitting correctly.

What you should do: Always wear your seat belt properly, and sit upright and as far back from the steering wheel as possible while allowing full control of the vehicle. A front passenger should move their seat as far back from the dashboard as possible.

Remember, however, that no safety system can prevent all injuries or deaths that can occur in a severe crash, even when seat belts are properly worn and the airbags deploy.

Do not place hard or sharp objects between yourself and a front airbag.

Carrying hard or sharp objects on your lap, or driving with a pipe or other sharp object in your mouth, can result in injuries if your front airbag inflates.

Do not attach or place objects on the front airbag covers. Objects on the covers marked **SRS AIRBAG** could interfere with the proper operation of the airbags or be propelled inside the vehicle and hurt someone if the airbags inflate.

▣ Important facts about your airbags

Do not attempt to deactivate your airbags. Together, airbags and seat belts provide the best protection.

When driving, keep hands and arms out of the deployment path of the front airbag by holding each side of the steering wheel. Do not cross an arm over the airbag cover.

Types of Airbags

Your vehicle is equipped with three types of airbags:

- **Front airbags:** Airbags in front of the driver's and front passenger's seats.
- **Side airbags:** Airbags in the driver's and front passenger's seat-backs.
- **Side curtain airbags:** Airbags above the side windows.

Each is discussed in the following pages.

Front Airbags (SRS)

The front SRS airbags inflate in a moderate to severe frontal collision to help protect the head and chest of the driver and/or front passenger.

SRS (Supplemental Restraint System) indicates that the airbags are designed to supplement seat belts, not replace them. Seat belts are the occupant's primary restraint system.

Housing Locations

The front airbags are housed in the center of the steering wheel for the driver, and in the dashboard for the front passenger. Both airbags are marked **SRS AIRBAG**.

Types of Airbags

The airbags can inflate whenever the ignition switch is in ON (II).

Front Airbags (SRS)

Dual-Stage, Multiple-Threshold Front Airbags (SRS)

Your vehicle is equipped with dual-stage, multiple-threshold front airbags (SRS).

During a frontal crash severe enough to cause one or both front airbags to deploy, the airbags can inflate at different rates, depending on the severity of the crash, whether or not the seat belts are latched, and/or other factors. Frontal airbags are designed to supplement the seat belts to help reduce the likelihood of head and chest injuries in frontal crashes.

■ Operation

Front airbags are designed to inflate during moderate-to-severe frontal collisions. When the vehicle decelerates suddenly, the sensors send information to the control unit which signals one or both front airbags to inflate.

A frontal collision can be either head-on or angled between two vehicles, or when a vehicle crashes into a stationary object, such as a concrete wall.

■ How the Front Airbags Work

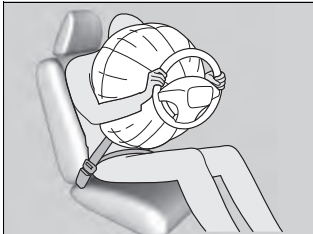

While your seat belt restrains your torso, the front airbag provides supplemental protection for your head and chest.

The front airbags deflate immediately so that they won't interfere with the driver's visibility or the ability to steer or operate other controls.

The total time for inflation and deflation is so fast that most occupants are not aware that the airbags deployed until they see them lying in front of them.

▣ How the Front Airbags Work

After a front airbag inflates in a crash, you may see what looks like smoke. This is actually powder from the airbag's surface. Although the powder is not harmful, people with respiratory problems may experience some temporary discomfort. If this occurs, get out of the vehicle as soon as it is safe to do so.

Although the driver's and front passenger's airbags normally inflate within a split second of each other, it is possible for only one airbag to deploy. This can happen if the severity of a collision is at the margin, or threshold, that determines whether or not the airbags will deploy. In such cases, the seat belt will provide sufficient protection, and the supplemental protection offered by the airbag would be minimal.

■ When front airbags should not deploy

Minor frontal crashes: Front airbags were designed to supplement seat belts and help save lives, not to prevent minor scrapes, or even broken bones that might occur during a less than moderate-to-severe frontal crash.

Side impacts: Front airbags can provide protection when a sudden deceleration causes a driver or front passenger to move towards the front of the vehicle. Side airbags and side curtain airbags have been specifically designed to help reduce the severity of injuries that can occur during a moderate-to-severe side impact which can cause the driver or passenger to move towards the side of the vehicle.

Rear impacts: Head restraints and seat belts are your best protection during a rear impact. Front airbags cannot provide any significant protection and are not designed to deploy in such collisions.

Rollovers: Seat belts and, in vehicles equipped with a rollover sensor, side airbags and side curtain airbags offer the best protection in a rollover. Because front airbags could provide little if any protection, they are not designed to deploy during a rollover.

■ When front airbags deploy with little or no visible damage

Because the airbag system senses sudden deceleration, a strong impact to the vehicle framework or suspension might cause one or more of the airbags to deploy. Examples include running into a curb, the edge of a hole, or other low fixed object that causes a sudden deceleration in the vehicle chassis. Since the impact is underneath the vehicle, damage may not be readily apparent.

■ When front airbags may not deploy, even though exterior damage appears severe

Since crushable body parts absorb crash energy during an impact, the amount of visible damage does not always indicate proper airbag operation. In fact, some collisions can result in severe damage but no airbag deployment because the airbags would not have been needed or would not have provided protection even if they had deployed.

Advanced Airbags

Your front airbags have advanced features to help reduce the likelihood of airbag related injuries to smaller occupants.

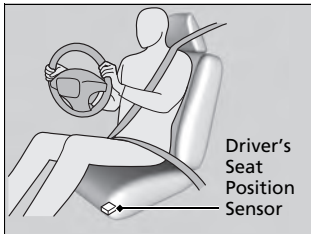

The driver's advanced front airbag system includes a seat position sensor.

If the seat is too far forward, the airbag inflates with less force, regardless of the severity of the impact.

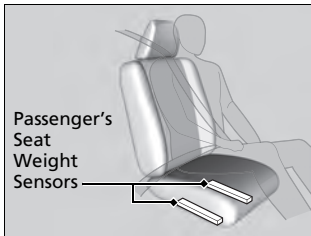

The passenger's advanced front airbag system has weight sensors.

Although Honda recommends against carrying an infant or small child in front, if the sensors detect the weight of a child (up to about 65 lbs or 29 kg), the system will automatically turn off the passenger's front airbag.

Advanced Airbags

If there is a problem with the driver's seat position sensor, the SRS indicator will come on and the airbag will inflate with full (normal) force, regardless of the driver's seating position.

For both advanced front airbags to work properly:

- Do not spill any liquid on or under the seats.
- Do not put any object under the passenger's seat.
- Make sure any objects are positioned properly on the floor. Improperly positioned objects can interfere with the advanced airbag sensors.
- All occupants should sit upright and wear their seat belts properly.
- Do not place any cover over the passenger side dashboard.

Make sure the floor mat behind the front passenger's seat is hooked to the floor mat anchor. An improperly placed mat can interfere with the advanced airbag sensors.

📖 **Floor Mats** P. 378

Side Airbags

The side airbags help protect the upper torso of the driver or a front passenger during a moderate to severe side impact.

Housing Locations

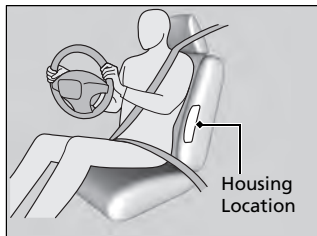

The side airbags are housed in the outside edge of the driver's and passenger's seat-backs.

Both are marked **SIDE AIRBAG**.

Operation

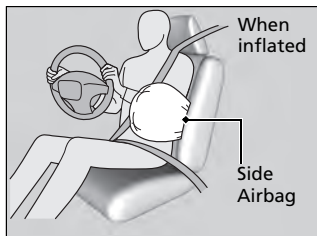

When the sensors detect a moderate-to-severe side impact, the control unit signals the side airbag on the impact side to immediately inflate.

Side Airbags

Do not attach accessories on or near the side airbags. They can interfere with the proper operation of the airbags, or hurt someone if an airbag inflates.

If the impact is on the passenger side, the airbag may not deploy when there is no passenger in the front passenger seat.

Do not cover or replace the front seat-back covers without consulting a dealer. Improperly replacing or covering front seat-back covers can prevent your side airbags from properly deploying during a side impact.

■ When a side airbag deploys with little or no visible damage

Because the airbag systems senses sudden acceleration, a strong impact to the side of the vehicle's framework can cause a side airbag to deploy. In such cases, there may be little or no damage, but the side impact sensors detected a severe enough impact to deploy the airbag.

■ When a side airbag may not deploy, even though visible damage appears severe

It is possible for a side airbag to not deploy during an impact that results in apparently severe damage. This can occur when the point of impact was towards the far front or rear of the vehicle, or when the vehicle's crushable body parts absorbed most of the crash energy. In either case, the side airbag would not have been needed nor provided protection even if it had deployed.

Side Airbag Cutoff System

To reduce the likelihood that a front passenger may be injured by an inflating side airbag, the passenger side airbag is automatically turned off when:

- The height sensors detect a child or short-statured adult is seated in the front passenger seat.
- The position sensor detects that the front passenger is leaning into the deployment path of the side airbag.

When the side airbag cutoff system is activated, the side airbag off indicator comes on.

➤ **Side Airbag Off Indicator** P. 52

Side Airbag Off Indicator

If the side airbag off indicator comes on, have the passenger sit upright. A few seconds after the passenger is sitting properly, the side airbag will automatically be turned on, and the indicator will go off.

If the front passenger is a child, stop when it is safe to do so, and have the child sit properly restrained in a rear seat.

Side Airbag Cutoff System

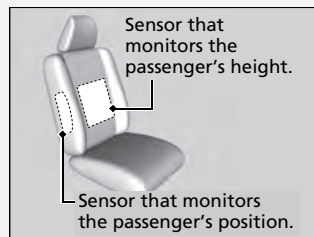

The sensors that monitor the front passenger's height and body position may not work if:

- The seat-back is wet
- The passenger is touching a metal or other electrical conductive object
- A seat cushion is on the seat
- The passenger is wearing excessively thick clothing

Side Curtain Airbags

The side curtain airbags help protect the heads of the driver and passengers in outer seating positions during a moderate-to-severe side impact.

■ Housing Locations

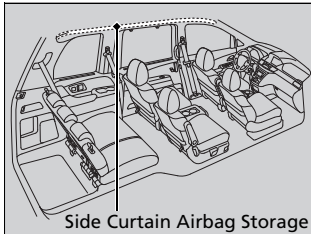

The side curtain airbags are located in the ceiling above the side windows on both sides of the vehicle.

■ Operation

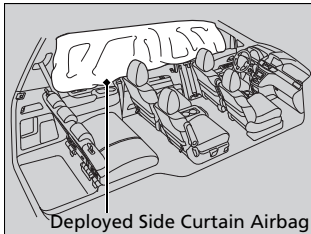

The side curtain airbag is designed to deploy in a moderate-to-severe side impact.

■ When side curtain airbags deploy in a frontal collision

One or both side curtain airbags may inflate in a moderate to severe angled frontal collision.

In this case, the side curtain airbags will deploy slightly after the front airbags.

⌘ Side Curtain Airbags

The side curtain airbags are most effective when an occupant is wearing their seat belt properly and sitting upright, well back in their seat.

Do not attach any objects to the side windows or roof pillars as they can interfere with the proper operation of the side curtain airbags.

Airbag System Indicators

If a problem occurs in the airbag system, the SRS indicator will come on and a message appears on the multi-information display*.

SRS (Supplemental Restraint System) Indicator

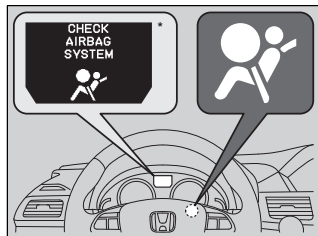

■ When the ignition switch is turned to ON

The indicator comes on for a few seconds, then goes off. This tells you the system is working properly.

If the indicator comes on at any other time, or does not come on at all, have the system checked by a dealer as soon as possible. If you don't, your airbags and seat belt tensioners may not work properly when they are needed.

SRS (Supplemental Restraint System) Indicator

WARNING

Ignoring the SRS indicator can result in serious injury or death if the airbag systems or tensioners do not work properly.

Have your vehicle checked by a dealer as soon as possible if the SRS indicator alerts you to a possible problem.

Passenger Airbag Off Indicator

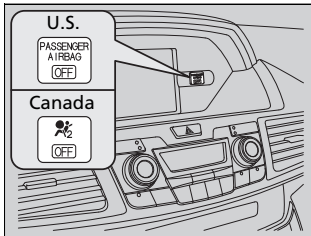

■ When the passenger airbag off indicator comes on

The indicator comes on to alert you that the passenger's front airbag has been turned off. This occurs when the weight sensors detect 65 lbs (29 kg) or less, the weight of an infant or small child, on the seat.

Infants and small children should always ride properly restrained in a back seat.

📖 **Child Safety** P. 54

Objects placed on the seat can also cause the indicator to come on.

If the front passenger seat is empty, the passenger's front airbag will not deploy and the indicator will not come on.

▶▶ Passenger Airbag Off Indicator

If the indicator comes on with no front passenger and no objects on the passenger's seat, or with an adult riding there, something may be interfering with the weight sensors. Such as:

- An object hanging on the seat or in the seat-back pocket.
- A child seat or other object pressing against the rear of the seat-back.
- A rear passenger pushing or pulling on the back of the front passenger's seat.
- The front seat or seat-back is forced back against an object on the seat or floor behind it.
- An object placed under the front passenger's seat.

If none of these conditions exist, have your vehicle checked by a dealer as soon as possible.

The passenger airbag off indicator may come on and go off repeatedly if the total weight on the seat is near the airbag cutoff threshold.

Side Airbag Off Indicator

When the side airbag off indicator comes on

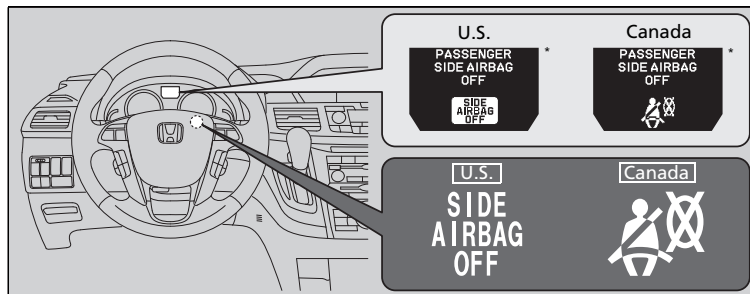

This indicator comes on if the passenger's side airbag has been turned off because the passenger is too small to be sitting in the front seat, is slouching or not sitting upright, or has leaned into the airbag's deployment path.

Unless the passenger is a smaller statured adult or a child, the indicator should go off when the passenger returns to a proper upright sitting position.

Side Airbag Off Indicator

When you turn the ignition switch to ON **(II)**, the indicator should come on for a few seconds and then go out. If it doesn't come on, stays on, or comes on while driving without a passenger in the front seat, have the system checked by a dealer as soon as possible.

Airbag Care

You do not need to, and should not, perform any maintenance on or replace any airbag system components yourself. However, you should have your vehicle inspected by a dealer in the following situations:

■ When the airbags have deployed

If an airbag has inflated, the control unit and other related parts must be replaced. Similarly, once an automatic seat belt tensioner has been activated, it must be replaced.

■ When the vehicle has been in a moderate-to-severe collision

Even if the airbags did not inflate, have your dealer inspect the following: the driver's seat position sensor, weight sensors in the passenger's seat, front seat belt tensioners, and each seat belt that was worn during the crash.

■ Do not remove or modify a front seat without consulting a dealer

This would likely disable the driver's seat position sensor or the passenger's weight sensor. If it is necessary to remove or modify a front seat to accommodate a person with disabilities, contact a Honda dealer, or for U.S. vehicles, American Honda Automobile Customer Service at 800-999-1009 and for Canadian vehicles, Honda Canada Customer Relations at 888-9-HONDA-9.

▶▶ Airbag Care

We recommend against the use of salvaged airbag system components, including the airbag, tensioners, sensors, and control unit.

Protecting Child Passengers

Each year, many children are injured or killed in vehicle crashes because they are either unrestrained or not properly restrained. In fact, vehicle accidents are the number one cause of death of children age 12 and under.

To reduce the number of child deaths and injuries, every state, Canadian province and territory requires that infants and children be properly restrained when they ride in a vehicle.

Children should sit properly restrained in a rear seat. This is because:

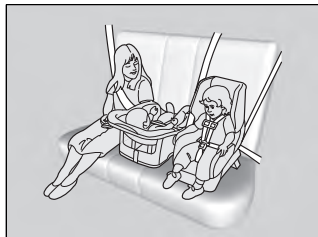

- An inflating front or side airbag can injure or kill a child sitting in the front seat.
- A child in the front seat is more likely to interfere with the driver's ability to safely control the vehicle.
- Statistics show that children of all sizes and ages are safer when they are properly restrained in a rear seat.

Protecting Child Passengers

⚠ WARNING

Children who are unrestrained or improperly restrained can be seriously injured or killed in a crash.

Any child too small for a seat belt should be properly restrained in a child seat. A larger child should be properly restrained with a seat belt, using a booster seat if necessary.

The National Highway Traffic Safety Administration and Transport Canada recommend that all children age 12 and under be properly restrained in a rear seat. Some states or provinces/territories have laws restricting where children may ride.

- Any child who is too small to wear a seat belt correctly must be restrained in an approved child seat that is properly secured to the vehicle using either the lap belt portion of the lap/shoulder belt or the lower anchors of the LATCH system.
- Never hold a child on your lap because it is impossible to protect them in the event of a collision.
- Never put a seat belt over yourself and a child. During a crash, the belt would likely press deep into the child and cause serious or fatal injuries.
- Never let two children use the same seat belt. Both children could be very seriously injured in a crash.
- Do not allow children to operate the doors, windows or seat adjustments.
- Do not leave children in the vehicle unattended, especially in hot weather when the inside of the vehicle can get hot enough to kill them. They could also activate vehicle controls causing it to move unexpectedly.

▶▶ Protecting Child Passengers

⚠ WARNING

Allowing a child to play with a seat belt or wrap one around their neck can result in serious injury or death.

Instruct children not to play with any seat belt and make sure any unused seat belt a child can reach is buckled, fully retracted, and locked.

To deactivate a lockable retractor, release the buckle and allow the seat belt to wind up all the way.

To remind you of the passenger's front airbag hazards and child safety, your vehicle has warning labels on the dashboard (U.S. models) and on the front visors. Please read and follow the instructions on these labels.

▶ **Safety Labels** P. 69

Safety of Infants and Small Children

■ Protecting Infants

An infant must be properly restrained in a rear-facing, reclining child seat until the infant reaches the seat maker's weight or height limit for the seat, and the infant is at least one year old.

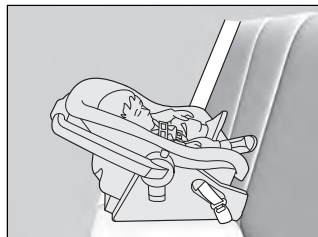

■ Positioning a rear-facing child seat

Child seats must be placed and secured in a rear seating position.

When properly installed, a rear-facing child seat may prevent the driver or a front passenger from moving their seat all the way back, or from locking their seat-back in the desired position.

It can also interfere with proper operation of the passenger's advanced front airbag system.

► Airbags P. 39

If this occurs, we recommend that you install the child seat directly behind the front passenger's seat, move the seat as far forward as needed, and leave it unoccupied. Or, you may wish to get a smaller rear-facing child seat.

► Protecting Infants

▲ WARNING

Placing a rear-facing child seat in the front seat can result in serious injury or death during a crash.

Always place a rear-facing child seat in the rear seat, not the front.

Rear-facing child seats should never be installed in a forward facing position.

Always refer to the child seat manufacturer's instructions before installation.

Protecting Smaller Children

If a child is at least one year old and within the weight range indicated by the child seat manufacturer, the child should be properly restrained in a firmly secured forward-facing child seat.

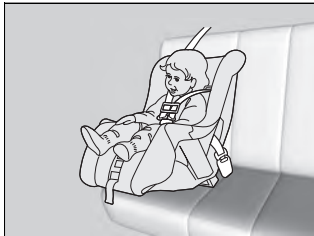

■ Forward-facing child seat placement

We strongly recommend placing a forward-facing child seat in a rear seating position.

Placing a forward-facing child seat in the front seat can be hazardous, even with advanced front airbags that automatically turn the passenger's front airbag off. A rear seat is the safest place for a child.

Protecting Smaller Children

⚠ WARNING

Placing a forward-facing child seat in the front seat can result in serious injury or death if the front airbag inflates.

If you must place a forward-facing child seat in front, move the vehicle seat as far back as possible, and properly restrain the child.

Educate yourself about the laws and regulations regarding child seat use where you are driving, and follow the child seat manufacturer's instructions.

Many experts recommend use of a rear-facing seat up to age two, if the child's height and weight are appropriate for a rear-facing seat.

■ Selecting a Child Seat

Most child seats are LATCH-compatible (Lower Anchors and Tethers for CHildren). Some have a rigid-type connector, while others have a flexible-type connector. Both are equally easy to use. Some existing and previously owned child seats can only be installed using the seat belt. Whichever type you choose, follow the child seat manufacturer's use and care instructions as well as the instructions in this manual. Proper installation is key to maximizing your child's safety.

In seating positions and vehicles not equipped with LATCH, a LATCH compatible child seat can be installed using the seat belt and a top tether for added security. This is because all child seats are required to be designed so that they can be secured with a lap belt or the lap part of a lap/shoulder belt. In addition, the child seat manufacturer may advise that a seat belt be used to attach a LATCH-compatible seat once a child reaches a specified weight. Please read the child seat owner's manual for proper installation instructions.

■ Important consideration when selecting a child seat

Make sure the child seat meets the following three requirements:

- The child seat is the correct type and size for the child.
- The child seat is the correct type for the seating position.
- The child seat is compliant with Federal Motor Vehicle Safety Standard 213 or Canadian Motor Vehicle Safety Standard 213.

☒ Selecting a Child Seat

Installation of a LATCH-compatible child seat is simple.

LATCH-compatible child seats have been developed to simplify the installation process and reduce the likelihood of injuries caused by incorrect installation.

Installing a LATCH-Compatible Child Seat

A LATCH-compatible child seat can be installed in each of the second and third row seats. A child seat is attached to the lower anchors with either the rigid or flexible type of connectors.

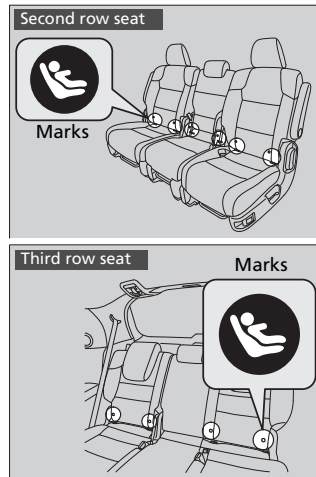

1. Locate the lower anchors under the marks.

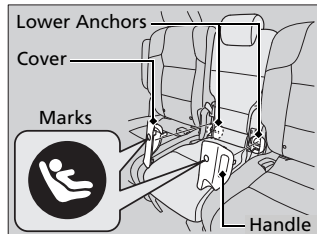
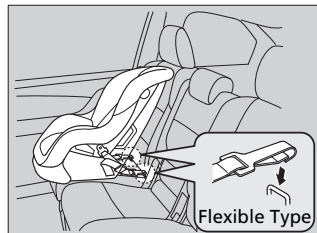
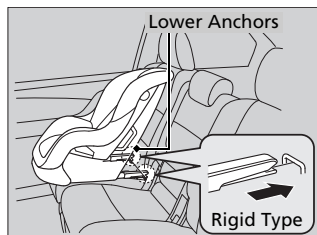

2. Place the child seat on the vehicle seat then attach the child seat to the lower anchors according to the instructions that came with the child seat.

- When installing the child seat, make sure that the lower anchors are not obstructed by the seat belt or any other object.

Second row center seat

To install a LATCH-compatible child seat in the second row center seat, remove the covers on each lower end of the seat -back by pulling on the handles.

Installing a LATCH-Compatible Child Seat

For your child's safety, when using a child seat installed using the LATCH system, make sure that the seat is properly secured to the vehicle. A child seat that is not properly secured will not adequately protect a child in a crash and may cause injury to the child or other vehicle occupants.

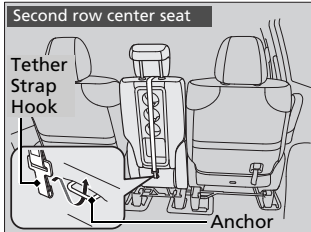
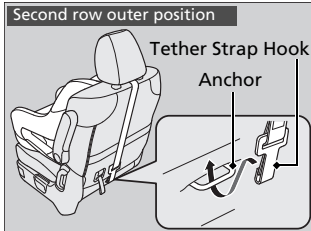

3. Raise the head restraint to its highest position, then route the tether strap between the head restraint legs, and secure the tether strap hook onto the anchor.
4. Tighten the tether strap as instructed by the child seat maker.
5. Make sure the child seat is firmly secured by rocking it forward and back and side to side; little movement should be felt.
6. Make sure any unused seat belt that a child can reach is buckled, the lockable retractor is activated, and the belt is fully retracted and locked.

■ Installing a Child Seat with a Lap/Shoulder Seat Belt

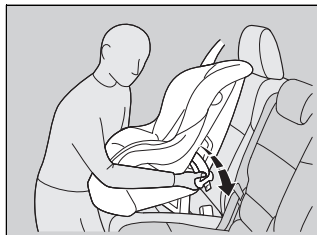

1. Place the child seat on the vehicle seat.
2. Route the seat belt through the child seat according to the seat maker's instructions, and insert the latch plate into the buckle.
 - Insert the latch plate fully until it clicks.

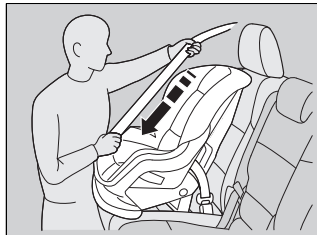

3. Slowly pull the shoulder part of the belt all the way out until it stops. This activates the lockable retractor.
4. Let the seat belt completely wind up into the retractor, then try to pull it out to make sure the retractor is locked.
 - If you are able to pull the shoulder belt out, the lockable retractor is not activated. Pull the seat belt all the way out, and repeat steps 2 – 4.

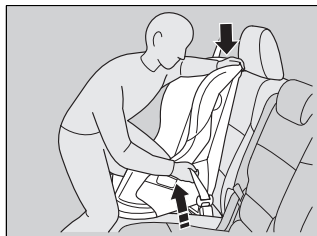

5. Grab the shoulder part of the seat belt near the buckle, and pull up to remove any slack from the lap part of the belt.
 - When doing this, place your weight on the child seat and push it into the vehicle seat.

⊗ Installing a Child Seat with a Lap/Shoulder Seat Belt

A child seat that is not properly secured will not adequately protect a child in a crash and may cause injury to the child or other vehicle occupants.

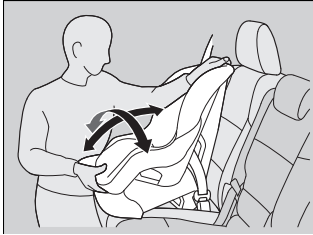

6. Make sure the child seat is firmly secured by rocking it forward and back and side to side; little movement should be felt.
7. Make sure any unused seat belt that a child can reach is buckled, the lockable retractor is activated, and the belt is fully retracted and locked.

►► Installing a Child Seat with a Seat Belt

To deactivate a lockable retractor, release the buckle and allow the seat belt to wind up all the way.

Adding Security with a Tether

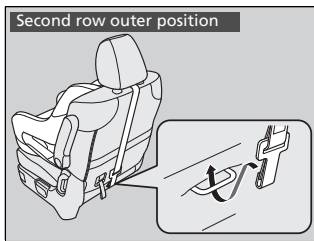
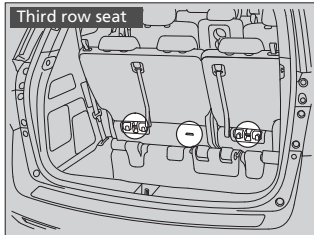
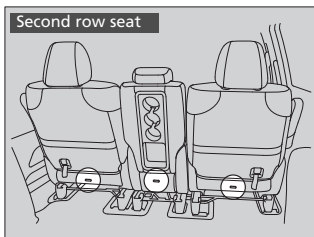

A tether anchorage point is provided behind each second and third row seating position. A child seat that is installed with a seat belt and comes with a tether can use the tether for additional security.

1. Locate the appropriate tether anchorage point.

2. Raise the head restraint to its highest position, then route the tether strap through the head restraint legs. Make sure the strap is not twisted.

Adding Security with a Tether

Since a tether can provide additional security to the lap/shoulder seat belt installation, we recommend using a tether whenever one is available.

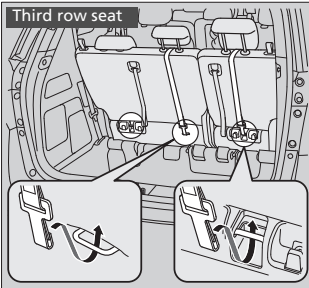
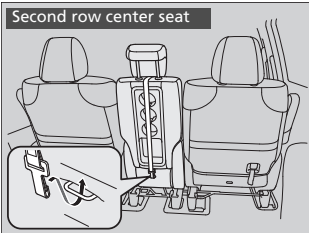

3. Secure the tether strap hook onto the anchor.
4. Tighten the tether strap as instructed by the child seat manufacturer.

Safety of Larger Children

■ Protecting Larger Children

The following pages give instructions on how to check proper seat belt fit, what kind of booster seat to use if one is needed, and important precautions for a child who must sit in front.

■ Checking Seat Belt Fit

When a child is too big for a child seat, secure the child in a rear seat using the lap/shoulder seat belt. Have the child sit upright and all the way back, then answer the following questions.

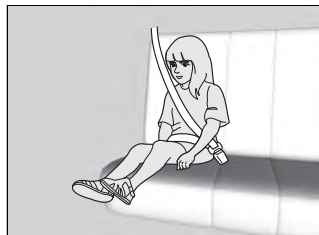

■ Checklist

- Do the child's knees bend comfortably over the edge of the seat?
- Does the shoulder belt cross between the child's neck and arm?
- Is the lap part of the seat belt as low as possible, touching the child's thighs?
- Will the child be able to stay seated like this for the whole trip?

If you answer yes to all these questions, the child is ready to wear the lap/shoulder seat belt correctly. If you answer no to any question, the child needs to ride on a booster seat until the seat belt fits properly without a booster seat.

► Safety of Larger Children

⚠ WARNING

Allowing a child age 12 or under to sit in front can result in injury or death if the passenger's front airbag inflates.

If a larger child must ride in front, move the vehicle seat as far to the rear as possible, have the child sit up properly and wear the seat belt properly, using a booster seat if needed.

Booster Seats



If a lap/shoulder seat belt cannot be used properly, position the child in a booster seat in a rear seating position. For the child's safety, check that the child meets the booster seat manufacturer's recommendations.

Protecting Larger Children-Final Checks

Your vehicle has a rear seat where children can be properly restrained. If you ever have to carry a group of children, and a child must ride in front:

- Make sure you read and fully understand the instructions and safety information in this manual.
- Move the front passenger seat as far back as possible.
- Have the child sit upright and well back in the seat.
- Check that the seat belt is properly positioned so that the child is secure in the seat.

Monitoring child passengers

We strongly recommend that you keep an eye on child passengers. Even older, more mature children sometimes need to be reminded to fasten their seat belts and sit up properly.

Booster Seats

When installing a booster seat, make sure to read the instructions that came with it, and install the seat accordingly.

There are high- and low-type booster seats. Choose a booster seat that allows the child to wear the seat belt correctly.

Some U.S. states and Canadian provinces and territories require children to use a booster seat until they reach a given age or weight (e.g. 6 years or 60 lbs). Be sure to check current laws in the state or province, or territory where you intend to drive.

Carbon Monoxide Gas

The engine exhaust from this vehicle contains carbon monoxide, a colorless, odorless, and highly toxic gas. As long as you properly maintain your vehicle, carbon monoxide gas will not get into the interior.

■ Have the exhaust system inspected for leaks whenever

- The exhaust system is making an unusual noise.
- The exhaust system may have been damaged.
- The vehicle is raised for an oil change.

When you operate a vehicle with the tailgate open, airflow can pull exhaust gas into the interior and create a hazardous condition. If you must drive with the tailgate open, open all the windows and set the heating and cooling*/climate control* system as shown below.

1. Select the fresh air mode.
2. Select the  mode.
3. Set the fan speed to high.
4. Set the temperature control to a comfortable setting.

Adjust the heating and cooling*/climate control* system in the same manner if you sit in your parked vehicle with the engine running.

☒ Carbon Monoxide Gas

⚠ WARNING

Carbon monoxide gas is toxic. Breathing it can cause unconsciousness and even kill you.

Avoid any enclosed areas or activities that expose you to carbon monoxide.

An enclosed area such as a garage can quickly fill up with carbon monoxide gas. Do not run the engine with the garage door closed. Even when the garage door is open, drive out of the garage immediately after starting the engine.

Label Locations

These labels are in the locations shown. They warn you of potential hazards that can cause serious injury or death. Read these labels carefully.

If a label comes off or becomes hard to read (except for the U.S. dashboard label which may be removed by the owner), contact a dealer for a replacement.

Sun Visor

U.S. models

Canadian models

CAUTION
TO AVOID SERIOUS INJURY:
FOR MAXIMUM SAFETY PROTECTION IN ALL TYPES OF CRASHES YOU MUST ALWAYS WEAR YOUR SAFETY BELT.
DO NOT INSTALL REARWARD-FACING CHILD SEATS IN ANY FRONT PASSENGER SEAT POSITION.
DO NOT SIT OR LEAN UNNECESSARILY CLOSE TO THE AIR BAG.
DO NOT PLACE ANY OBJECTS OVER THE AIR BAG OR BETWEEN THE AIR BAG AND YOURSELF.
SEE THE OWNER'S MANUAL FOR FURTHER INFORMATION AND EXPLANATIONS.

PRECAUTIONS:
POUR ÉVITER DES BLESSURES GRAVES:
POUR PROTÉGER D'UNE PROTECTION MAXIMALE LORS D'UNE COLLISION BOUCLEZ TOUJOURS VOTRE CEINTURE DE SÉCURITÉ.
N'INSTALLEZ JAMAIS UN SIÈGE POUR ENFANTS FAISANT FACE À L'ARRIÈRE SUR LE SIÈGE DU PASSAGER AVANT.
NE VOUS APPUYEZ PAS ET NE VOUS ASSOYEZ PAS PRES DU COUSSIN GONFLABLE.
NE DÉPOSEZ AUCUN OBJET SUR LE COUSSIN GONFLABLE ET VOUS.
LISEZ LE GUIDE UTILISATEUR POUR DE PLUS AMPLES RENSEIGNEMENTS.

Dashboard U.S. models only

This Vehicle is Equipped with Advanced Air Bags

Even with Advanced Air Bags, Children and Infants should always be properly restrained. Always use proper tie-down technique. Always use proper tie-down technique. Always use proper tie-down technique.

Radiator Cap

Doorjamb

U.S. models

SIDE AIRBAG

- This car is equipped with side airbags in the front seats and side curtain airbags.
- Do not lean against the door.
- See owner's manual for more information.

Canadian models

SIDE AIRBAG

- This car is equipped with side airbags in the front seats and side curtain airbags.
- Do not lean against the door.
- See owner's manual for more information.

COUSSIN GONFLABLE LATÉRAL

- Cette voiture est équipée de coussins gonflables latéraux dans les sièges avant ainsi que des coussins gonflables latéraux de type rideau.
- Ne vous appuyez pas sur la porte.
- Consultez le Manuel de l'Utilisateur pour plus de détails.



Instrument Panel





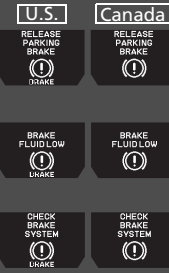

This chapter describes the buttons, indicators, and gauges that are used while driving.









Indicators	72
Multi-Information Display Warning and Information Messages*	84
Gauges and Displays	
Gauges	86
Information Display*	87
Audio/Information Screen	91
Multi-Information Display*	98



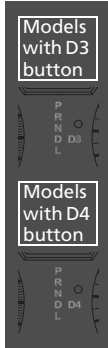





* Not available on all models





Indicator	Name	On/Blinking	Explanation	Message*
	Parking Brake and Brake System Indicator	<ul style="list-style-type: none"> Comes on for a few seconds when you turn the ignition switch to ON [II], then goes off. Comes on when the parking brake is applied, and goes off when it is released. Comes on when the brake fluid level is low. Comes on if there is a problem with the brake system. The beeper sounds and the indicator comes on if you drive with the parking brake not fully released. 	<ul style="list-style-type: none"> Comes on while driving - Make sure the parking brake is released. Check the brake fluid level. <ul style="list-style-type: none"> ➤ What to do when the indicator comes on while driving P. 400 Comes on along with the ABS indicator - Have the vehicle checked by a dealer. <ul style="list-style-type: none"> ➤ If the Brake System Indicator Comes On P. 400 	
	Low Oil Pressure Indicator	<ul style="list-style-type: none"> Comes on when you turn the ignition switch to ON [II], and goes off when the engine starts. Comes on when the engine oil pressure is low. 	<ul style="list-style-type: none"> Comes on while driving - Immediately stop in a safe place. <ul style="list-style-type: none"> ➤ If the Low Oil Pressure Indicator Comes On P. 398 	





Indicator	Name	On/Blinking	Explanation	Message*
	Malfunction Indicator Lamp	<ul style="list-style-type: none"> • Comes on when you turn the ignition switch to ON , and goes off either when the engine starts or after several seconds if the engine is not started. If “readiness codes” have not been set, it blinks five times before it goes off. • Comes on if there is a problem with the emissions control system. • Blinks when a misfire in the engine's cylinders is detected. 	<ul style="list-style-type: none"> • Readiness codes are part of the on board diagnostics for the emissions control systems. <ul style="list-style-type: none"> ➤ Testing of Readiness Codes P. 417 • Comes on while driving - Have the vehicle checked by a dealer. • Blinks while driving - Stop in a safe place where there are no flammable objects. Stop the engine for 10 minutes or more, and wait for it to cool down. Then, take the vehicle to a dealer. <ul style="list-style-type: none"> ➤ If the Malfunction Indicator Lamp Comes On or Blinks P. 399 	
	Charging System Indicator	<ul style="list-style-type: none"> • Comes on when you turn the ignition switch to ON , and goes off when the engine starts. • Comes on when the battery is not charging. 	<ul style="list-style-type: none"> • Stays on while driving - Turn off the heating and cooling*/climate control* system and rear defogger in order to reduce electricity consumption. <ul style="list-style-type: none"> ➤ If the Charging System Indicator Comes On P. 398 	

* Not available on all models

Indicator	Name	On/Blinking	Explanation	Message*
 <p>Models with D3 button</p> <p>Models with D4 button</p>	Shift Lever Position Indicator	<ul style="list-style-type: none"> Indicates current shift lever position. D3/D4 Indicator: Comes on for a few seconds when you turn the ignition switch to ON , then goes off. Comes on when you press the D3/D4 button while the shift lever is in . 	 Shifting P. 295	—
	Transmission Indicator	<ul style="list-style-type: none"> Comes on for a few seconds when you turn the ignition switch to ON , then goes off. Blinks if the transmission system has a problem. 	<ul style="list-style-type: none"> Blinks while driving - Avoid sudden starts and acceleration and have the vehicle checked by a dealer immediately. 	





Indicator	Name	On/Blinking	Explanation	Message*
	Seat Belt Reminder Indicator	<ul style="list-style-type: none"> Comes on and the beeper sounds if you are not wearing a seat belt when you turn the ignition switch to ON II. If the front passenger is not wearing a seat belt, the indicator comes on about a few seconds later. Blinks while driving if either you or the front passenger has not fastened a seat belt. The beeper sounds and the indicator blinks at regular intervals. 	<ul style="list-style-type: none"> The beeper stops and the indicator goes off when you and the front passenger fasten their seat belts. Stays on after you or the front passenger has fastened the seat belt - A detection error may have occurred in the sensor. Have the vehicle checked by a dealer.  Seat Belt Reminder P. 31 	 
	Low Fuel Indicator	<ul style="list-style-type: none"> Comes on when the fuel reserve is running low (approximately 3.0 U.S. gal./11.4 Liter left). Blinks if there is a problem with the fuel gauge. 	<ul style="list-style-type: none"> Comes on - Refuel your vehicle as soon as possible. Blinks - Have the vehicle checked by a dealer. 	
	ABS (Anti-lock Brake System) Indicator	<ul style="list-style-type: none"> Comes on for a few seconds when you turn the ignition switch to ON II, then goes off. If it comes on at any other time, there is a problem with the ABS. 	<ul style="list-style-type: none"> Stays on constantly - Have the vehicle checked by a dealer. With this indicator on, your vehicle still has normal braking ability but no anti-lock function.  ABS (Anti-lock Brake System) P. 310 	









Indicator	Name	On/Blinking	Explanation	Message*
	Supplemental Restraint System Indicator	<ul style="list-style-type: none"> Comes on for a few seconds when you turn the ignition switch to ON [II], then goes off. Comes on if a problem with any of the following is detected: <ul style="list-style-type: none"> Supplemental restraint system Side airbag system Side curtain airbag system Seat belt tensioner 	<ul style="list-style-type: none"> Stays on constantly or does not come on at all - Have the vehicle checked by a dealer. 	
	VSA® (Vehicle Stability Assist) System Indicator	<ul style="list-style-type: none"> Comes on for a few seconds when you turn the ignition switch to ON [II], then goes off. Blinks when VSA® is active. Comes on if there is a problem with the VSA® system. 	<ul style="list-style-type: none"> Stays on constantly - Have the vehicle checked by a dealer. <ul style="list-style-type: none"> ➤ VSA® (Vehicle Stability Assist), aka ESC (Electronic Stability Control), System P. 300 	
	VSA® (Vehicle Stability Assist) OFF Indicator	<ul style="list-style-type: none"> Comes on for a few seconds when you turn the ignition switch to ON [II], then goes off. Comes on when you deactivate VSA®. 	<ul style="list-style-type: none"> ➤ VSA® On and Off P. 301 	—

Indicator	Name	On/Blinking	Explanation	Message*
	Door and Tailgate Open Indicator	<ul style="list-style-type: none"> Comes on for a few seconds when you turn the ignition switch to ON II, then goes off. Comes on if any door or the tailgate is not completely closed. The beeper sounds and the indicator comes on if any door or the tailgate is opened while driving. 	<ul style="list-style-type: none"> Goes off when all doors and tailgate are closed. 	
	Parking Sensor Indicator*	<ul style="list-style-type: none"> Comes on for a few seconds when you turn the ignition switch to ON II, then goes off. A corresponding indicator comes on when an obstacle is detected while parking. Comes on if there is a problem with the parking sensor system. The beeper sounds. 	<ul style="list-style-type: none"> Comes on without any obstacles or when you are not parking - Check if the area around the sensor(s) is covered with mud, ice, snow, etc. If the indicator(s) stays on even after you clean the area, have the system checked by a dealer. 	—
DRL	Daytime Running Lights Indicator*	<ul style="list-style-type: none"> Comes on for a few seconds when you turn the ignition switch to ON II, then goes off. Comes on if there is a problem with the DRL system. 	<ul style="list-style-type: none"> Have your vehicle checked by a dealer.  Daytime Running Lights P. 143 	





Instrument Panel









* Not available on all models

Indicator	Name	On/Blinking	Explanation	Message*
TPMS	<p>Models with information display</p> <p>TPMS Indicator</p>	<ul style="list-style-type: none"> Comes on for a few seconds when you turn the ignition switch to ON . Comes on if there is a problem with the TPMS, or when a compact spare tire is temporarily installed. 	<ul style="list-style-type: none"> Stays on constantly or does not come on at all - Have the vehicle checked by a dealer. If the vehicle is fitted with a compact spare, get your regular tire repaired or replaced and put back on your vehicle as soon as you can. 	—
	<p>Models with information display</p> <p>Low Tire Pressure Indicator</p> <p>Models with multi-information display</p> <p>Low Tire Pressure/TPMS Indicator</p>	<ul style="list-style-type: none"> Comes on for a few seconds when you turn the ignition switch to ON . Comes on if the tire pressure of any of the tires becomes significantly low. <p>Models with information display</p> <ul style="list-style-type: none"> Comes on for a while and then goes off when a compact spare tire is temporarily installed. <p>Models with multi-information display</p> <ul style="list-style-type: none"> Blinks for about one minute, and then stays on if there is a problem with the TPMS, or when a compact spare tire is temporarily installed. 	<ul style="list-style-type: none"> Comes on while driving - Stop in a safe place, check tire pressures, and inflate the tire(s) if necessary. <p>Models with multi-information display</p> <ul style="list-style-type: none"> Blinks and remains on - Have the vehicle checked by a dealer. If the vehicle is fitted with a compact spare, get your regular tire repaired or replaced and put back on your vehicle as soon as you can. 	<p>CHECK TIRE PRESSURE</p>  <p>CHECK TPMS SYSTEM</p> <p>TPMS</p>







Indicator	Name	On/Blinking	Explanation	Message*
	System Message Indicator*	<ul style="list-style-type: none"> Comes on for a few seconds when you turn the ignition switch to ON II, then goes off. Comes on along with a beep when a problem is detected. A system message on the multi-information display appears at the same time. 	<ul style="list-style-type: none"> While the indicator is on, press the  /  (information) button to see the message again. Refer to the Indicators information in this chapter when a system message appears on the multi-information display. Take the appropriate action for the message. The multi-information display does not return to the normal screen unless the warning is canceled, or the  /  (information) button is pressed. 	—
	Turn Signal and Hazard Warning Indicators	<ul style="list-style-type: none"> The turn signal indicators blink when you operate the turn signal lever. If you press the hazard warning button, both indicators and all turn signals blink at the same time. 	<ul style="list-style-type: none"> Does not blink or blinks rapidly - A turn signal light bulb has blown. Change the bulb immediately.  Replacing Light Bulbs P. 352, 353 	—
	High Beam Indicator	<ul style="list-style-type: none"> Comes on when the high beam headlights are on. 	—	—
	Lights On Indicator	<ul style="list-style-type: none"> Comes on whenever the light switch is on, or in AUTO* when the exterior lights are on. 	<ul style="list-style-type: none"> If you remove the key from the ignition switch while the lights are on, a chime sounds when the driver's door is opened. 	—









* Not available on all models

Indicator	Name	On/Blinking	Explanation	Message*
	Fog Light Indicator*	<ul style="list-style-type: none"> Comes on when the fog lights are on. 	—	—
	Side Airbag Off Indicator	<ul style="list-style-type: none"> Comes on for a few seconds when you turn the ignition switch to ON [II], then goes off. Comes on when the passenger side airbag system is automatically shut off. 	<ul style="list-style-type: none"> It does not mean there is a problem with your side airbags. Comes on when nobody is sitting in the passenger seat - Have the vehicle checked by a dealer. Comes on when someone is sitting in the seat - Have the passenger sit properly. 	
	Immobilizer System Indicator	<ul style="list-style-type: none"> Comes on briefly when you turn the ignition switch to ON [II], then goes off. Comes on if the immobilizer system cannot recognize the key information. 	<ul style="list-style-type: none"> Blinks - You cannot start the engine. Turn the ignition switch to LOCK [0], pull the key out, and then insert the key and turn it to ON [II] again. Repeatedly blinks - The system may be malfunctioning. Have the vehicle checked by a dealer. Do not attempt to alter this system or add other devices to it. Electrical problems can occur. 	—

Indicator	Name	On/Blinking	Explanation	Message*
	Security System Alarm Indicator*	<ul style="list-style-type: none"> Blinks when the security system alarm has been set. 	<p>➤ Security System Alarm* P. 133</p>	—
	Starter System Indicator*	<ul style="list-style-type: none"> Comes on if there is a problem with the starter system. 	<ul style="list-style-type: none"> As a temporary measure, hold the ignition switch to START  for up to 15 seconds and start the engine. Have the vehicle checked by a dealer. 	 
	Fuel Economy Indicator	<ul style="list-style-type: none"> Comes on and stays on while you are driving with good fuel economy. 	—	—
	CRUISE MAIN Indicator	<ul style="list-style-type: none"> Comes on when you press the CRUISE button. 	<p>➤ Cruise Control P. 297</p>	—
	CRUISE CONTROL Indicator	<ul style="list-style-type: none"> Comes on if you have set a speed for cruise control. 	<p>➤ Cruise Control P. 297</p>	—

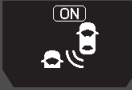
* Not available on all models

Indicator	Name	On/Blinking	Explanation	Message*
	Washer Level Indicator*	<ul style="list-style-type: none"> Comes on when the washer fluid gets low. 	<ul style="list-style-type: none"> Refill washer fluid. ► Refilling Window Washer Fluid P. 346 	
	Maintenance Minder Indicator*	<ul style="list-style-type: none"> Comes on when the scheduled maintenance is due soon. 	► Maintenance Minder™ P. 327	—
	Power Tailgate Indicator*	<ul style="list-style-type: none"> Comes on for a few seconds when you turn the ignition switch to ON . Comes on if there is a problem with the power tailgate system. 	<ul style="list-style-type: none"> Stays on constantly or does not come on at all - You can still open or close the tailgate manually. Have the vehicle checked by a dealer. 	 

Indicator	Name	On/Blinking	Explanation	Message*
	Power Sliding Door Indicator*	<ul style="list-style-type: none"> Comes on for a few seconds when you turn the ignition switch to ON II, then goes off. Comes on if there is a problem with the power sliding door system. 	<ul style="list-style-type: none"> Stays on constantly or does not come on at all - Turn off the main switch and manually operate the power sliding doors. Have the vehicle checked by a dealer. <ul style="list-style-type: none"> ✉ Opening/Closing the Power Sliding Doors* P. 127 	 
	BSI (Blind Spot Information) Indicator*	<ul style="list-style-type: none"> Comes on for a few seconds when you turn the ignition switch to ON II, then goes off. Stays on while BSI is turned off. Comes on when mud, snow, or ice accumulates in the vicinity of sensor. Comes on if there is a problem with the system. 	<p style="text-align: center;">—</p> <ul style="list-style-type: none"> Comes on while driving - Remove the obstacle in the vicinity of sensor. Comes on while driving - Have the vehicle checked by a dealer. 	   





Instrument Panel

* Not available on all models

Multi-Information Display Warning and Information Messages*

The following messages appear only on the multi-information display. Press the / (information) button to see the message again with the system message indicator on.

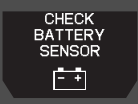
Message	Condition	Explanation
	<ul style="list-style-type: none"> Appears when the fuel fill cap is loose or is not installed. 	<ul style="list-style-type: none"> Check/Tighten Fuel Cap Message P. 399
	<ul style="list-style-type: none"> Appears when the scheduled maintenance is due soon. Consequently, SERVICE DUE NOW and SERVICE PAST DUE follow. 	<ul style="list-style-type: none"> Maintenance Minder Messages on the Multi-Information Display P. 332
	<ul style="list-style-type: none"> Appears when the ignition key is turned to ACCESSORY I from ON II. (The driver's door is closed.) 	—
	<ul style="list-style-type: none"> Appears when you open the driver's door while the ignition key is in LOCK 0. 	<ul style="list-style-type: none"> Remove the key from the ignition switch.
	<ul style="list-style-type: none"> Appears when the engine coolant temperature gets abnormally high. 	<ul style="list-style-type: none"> Overheating P. 396

Message	Condition	Explanation
	<ul style="list-style-type: none"> Appears when the daytime running lights are off. 	<ul style="list-style-type: none">  Daytime Running Lights P. 143
	<ul style="list-style-type: none"> Appears when there is a problem with the sensor on the battery. 	<ul style="list-style-type: none"> Have your vehicle checked by a dealer. <ul style="list-style-type: none">  Checking the Battery P. 371
	<ul style="list-style-type: none"> Appears if there is a problem with the parking sensor system. The beeper sounds. 	<ul style="list-style-type: none"> Check if the area around the sensor(s) is covered with mud, ice, snow, etc. If the indicator(s) stays on even after you clean the area, have the system checked by a dealer.

Gauges

Gauges include the speedometer, tachometer, fuel gauge, and related indicators. They are displayed when the ignition switch is in ON **II**.

Speedometer

Displays your driving speed in mph or km/h.

Tachometer

Shows the number of engine revolutions per minute.

Fuel Gauge

Displays the amount of fuel left in the fuel tank.

Temperature Gauge

Displays the temperature of the engine coolant.

Fuel Gauge

NOTICE

You should refuel when the reading approaches **E**. Running out of fuel can cause the engine to misfire, damaging the catalytic converter.

The actual amount of remaining fuel may differ from the fuel gauge reading.

Temperature Gauge

If the temperature gauge pointer is in the upper zone, the engine is in danger or overheating. Driving with the temperature gauge pointer in the upper zone can cause serious engine damage. Pull safety to the side of the road and allow engine temperature to return to normal.

➤ **Overheating** P. 396

Information Display*

The information display shows the odometer, trip meter, engine oil life and maintenance service codes, and other gauges.

Switching the Display

Press the  (Select/Reset) knob to change the display.

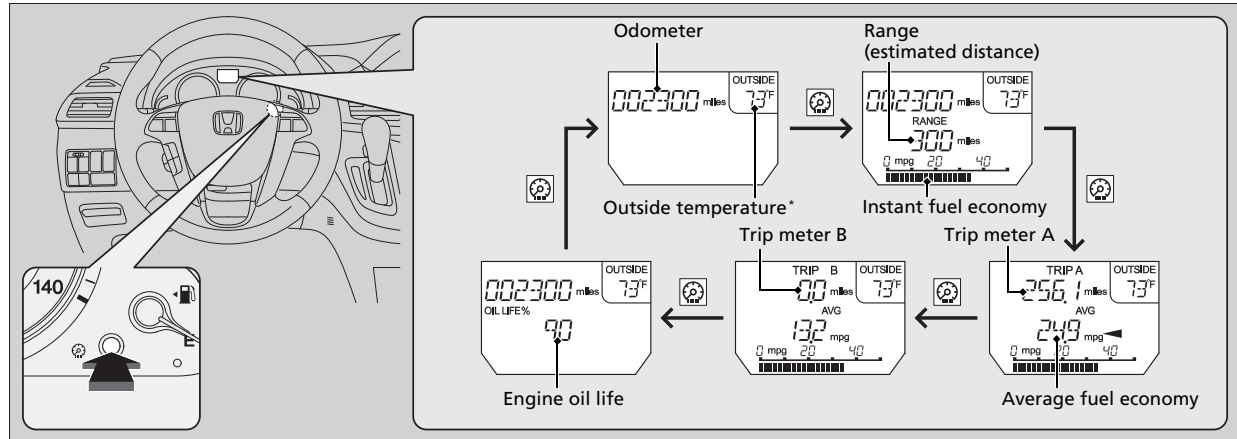

Instrument Panel

Odometer

Shows the total number of miles or kilometers that your vehicle has accumulated.

* Not available on all models

■ Trip Meter

Shows the total number of miles or kilometers driven since the last reset. Meters A and B can be used to measure 2 separate trips.

■ Resetting a trip meter

To reset a trip meter, display it, then press and hold the  knob. The trip meter is reset to **0.0**.

■ Instant Fuel Economy

Shows the instant fuel economy as a bar graph in mpg or l/100 km.

■ Average Fuel Economy

Shows the estimated average fuel economy of each trip meter in mpg or l/100 km. The display is updated at set intervals. When a trip meter is reset, the average fuel economy is also reset.

■ Engine Oil Life

Shows the remaining oil life and Maintenance Minder™.

► **Maintenance Minder™** P. 327

■ Range

Shows the estimated distance you can travel on the remaining fuel. This distance is estimated from the fuel economy of your trips in the past.

☒ Trip Meter

Switch between trip meter A and trip meter B by pressing the  knob.

■ Outside Temperature*

Shows the outside temperature in Fahrenheit (U.S.) or Celsius (Canada).

■ Adjusting the outside temperature indicator

Adjust the temperature reading up to $\pm 5^{\circ}\text{F}$ or $\pm 3^{\circ}\text{C}$ if the temperature reading seems incorrect.

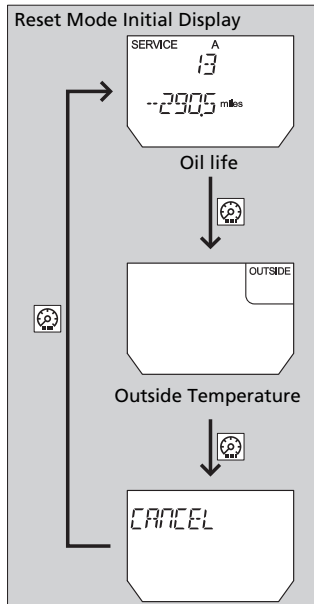

* Not available on all models

Continued

►► Outside Temperature*

The temperature sensor is in the front bumper. Road heat and exhaust from another vehicle can affect the temperature reading when your vehicle speed is less than 19 mph (30 km/h).

It may take several minutes for the display to be updated after the temperature reading has stabilized.

►► Adjusting the outside temperature indicator

Adjust the temperature reading up to $\pm 5^{\circ}\text{F}$ or $\pm 3^{\circ}\text{C}$.

■ Check Fuel Cap

Appears when the fuel fill cap is loose or is not installed.

➤ **Check/Tighten Fuel Cap Message** P. 399

■ Check Batt Sensor

Appears when there is a problem with the sensor on the battery.



➤ **Checking the Battery** P. 371

Models without navigation system

Audio/Information Screen

Displays audio status, trip computer and wallpaper, and allows you to go to various setup options.

Switching the Display

Press the **DISPLAY** button. Rotate  and select the mode from the four display modes. Press .

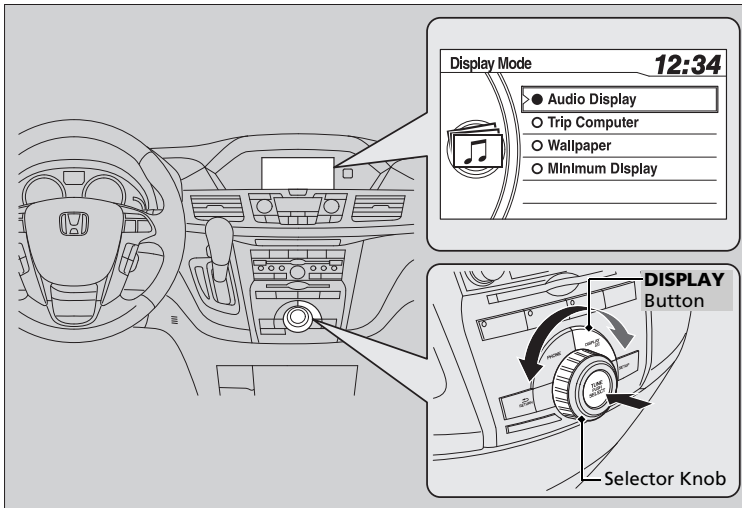

Switching the Display

These indications are used to show how to operate the selector knob.

Rotate  to select.

Press  to enter.

■ Audio Display

Shows the current audio information.

- **Audio System Basic Operation** P. 197

■ Trip Computer

Shows the instant fuel economy, average fuel economy, distance (trip meter), average speed, elapsed time, and range.

- **Instant Fuel Economy** P. 88
- **Trip Meter** P. 88
- **Range** P. 88

■ Average speed

Shows the average speed in mph (U.S.) or km/h (Canada).

■ Elapsed time

Shows the time during one drive cycle.

■ Wallpaper

Shows a clock screen or an image you import.

- **Wallpaper Setup** P. 94

■ Minimum Display

Minimizes the display by only showing the compass, audio status, and clock on the upper part of the display.



☒ Trip Computer

You can reset the trip computer.

- **Trip Computer Reset** P. 96

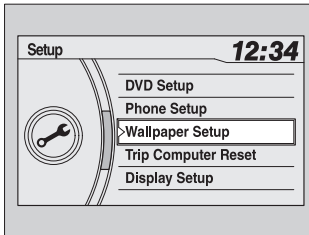
Setting Options



1. Press the **SETUP** button.
2. Rotate  and select the setup option you want to change. Press .

DVD Setup*

- ▶ DVD setup from the front panel P. 239

Phone Setup*

- ▶ Phone Setup P. 259
- ▶ To Create a Security Code P. 264
- ▶ Automatic Answering P. 265
- ▶ Automatic Transferring P. 265
- ▶ To Clear the System P. 266
- ▶ Speed Dial P. 268

* Not available on all models

■ Wallpaper Setup

You can change, store, delete the wallpaper on the audio/information screen.

Models with navigation system

See the navigation system manual for how to change the wallpaper.

■ Importing pictures from USB

You can import up to five images, one at a time, for wallpaper from USB flash drive. Select **Import picture from USB** from setup menu and properly connect a USB flash drive to store an image.

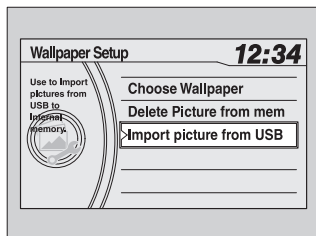

1. Connect the USB flash drive to the adapter cable.

▶ **USB Adapter Cable** P. 195

2. Press the **SETUP** button.
3. Rotate to select **Wallpaper Setup**, then press .
4. Rotate to select **Import picture from USB**, then press .
5. Rotate to select a desired picture, then press .
 - ▶ **Loading Picture** will appear on the display.

▣ Wallpaper Setup

- When importing wallpaper files, the image must be in the USB flash drive's root directory. Images in a folder cannot be imported.
- The file format of the image that can be imported is BMP (bmp) or JPEG (jpg).
- The maximum image size is 1,024 x 768 pixels. Smaller images are displayed in the middle of the screen with the extra area appearing in black.

If the USB flash drive does not have any pictures, **No Files** will appear.

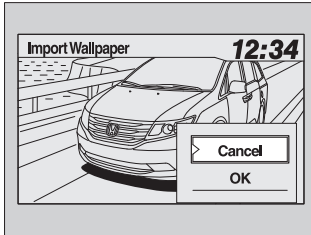

6. The preview of the imported data is displayed.
7. Rotate to select **OK**, then press .
- ▶ The imported list number and the confirmation message will appear. Then the display will return to the import wallpaper list.

■ Choose wallpaper

1. Rotate to select **Choose Wallpaper** on the wallpaper setup menu, then press .
- ▶ The screen will change to the wallpaper list.
2. Rotate to select desired wallpaper and press .
3. Your selection will be indicated by the filled in circle.
 - ▶ You can also select **Default Wallpaper** (Honda logo) or **Clock** on the list.





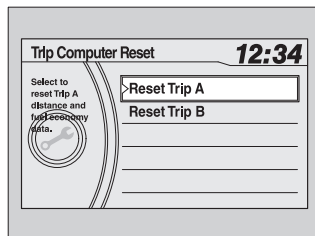

■ Delete wallpaper

1. Rotate to select **Delete Picture from mem** on the wallpaper setup menu, then press .
- ▶ The screen will change to the delete wallpaper list.
2. Rotate to select wallpaper that you want to delete and press .
- ▶ The confirmation message will appear.
3. Rotate to select **Yes**, then press to delete completely.

■ Trip Computer Reset



You can reset all data on the trip computer.

1. Press the **SETUP** button.
2. Rotate  to select **Trip Computer Reset**, then press .
3. Rotate  to **Trip A** or **Trip B**, then press .
 - The confirmation message will appear.
4. Rotate  to select **Yes**, then press  to reset completely.

Display Setup

■ Brightness/Contrast

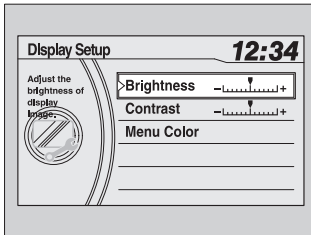

If you select **Brightness** or **Contrast**, adjust the setting by rotating  and pressing .

■ Menu Color

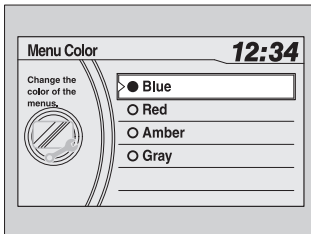



If you select **Menu Color**, rotate  to setting you want, then press .

Multi-Information Display *

The multi-information display shows the odometer, trip meter, outside temperature indicator, and other gauges.

It also displays important messages such as warnings and other helpful information.

Switching the Display

Press the  /  (information) button or the **SEL/RESET** button to change the display.

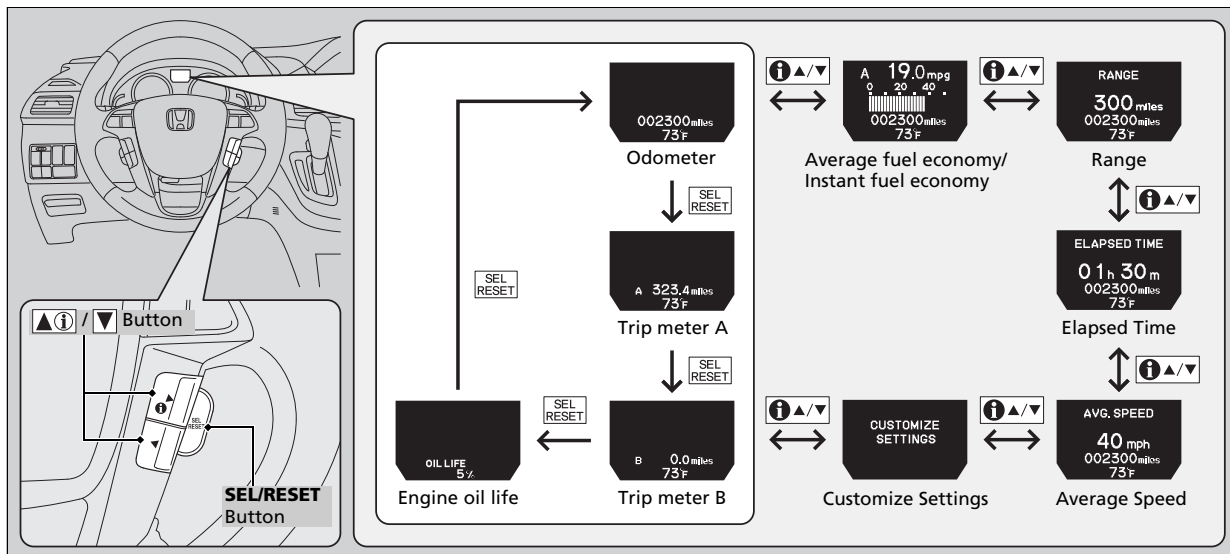

■ Odometer

Shows the total number of miles or kilometers that your vehicle has accumulated.

■ Trip Meter

Shows the total number of miles or kilometers driven since the last reset. Meters A and B can be used to measure two separate trips.

■ Resetting a trip meter

To reset a trip meter, display it, then press and hold the **SEL/RESET** button. The trip meter is reset to **0.0**.

■ Average Fuel Economy

Shows the estimated average fuel economy of each trip meter in mpg or l/100 km. The display is updated at set intervals. When a trip meter is reset, the average fuel economy is also reset.

■ Instant Fuel Economy

Shows the instant fuel economy as a bar graph in mpg or l/100 km.

■ Range

Shows the estimated distance you can travel on the remaining fuel. This distance is estimated from the fuel economy of your trips in the past.

■ Elapsed Time

Shows the time elapsed since the last time Trip A or Trip B was reset.

▶▶ Trip Meter

Switch between trip meter A and trip meter B by pressing the **SEL/RESET** button.

▶▶ Average Fuel Economy

You can change when to reset the average fuel economy.

▶ **Customized Features** P. 101

■ Average Speed

Shows the average speed in mph or km/h since the last time Trip A or Trip B was reset.

■ Engine Oil Life

Shows the remaining oil life and Maintenance Minder™.

➤ **Maintenance Minder™** P. 327

■ Outside Temperature

Shows the outside temperature in Fahrenheit (U.S.) or Celsius (Canada).

■ Adjusting the outside temperature display

Adjust the temperature reading up to $\pm 5^{\circ}\text{F}$ or $\pm 3^{\circ}\text{C}$ if the temperature reading seems incorrect.

☒ Outside Temperature

The temperature sensor is in the front bumper. Road heat and exhaust from another vehicle can affect the temperature reading when your vehicle speed is less than 19 mph (30 km/h).

It may take several minutes for the display to be updated after the temperature reading has stabilized.



Use the multi-information display's customized features to correct the temperature.

➤ **Customized Features** P. 101

■ Customized Features



Use the multi-information display to customize certain features.

■ How to customize

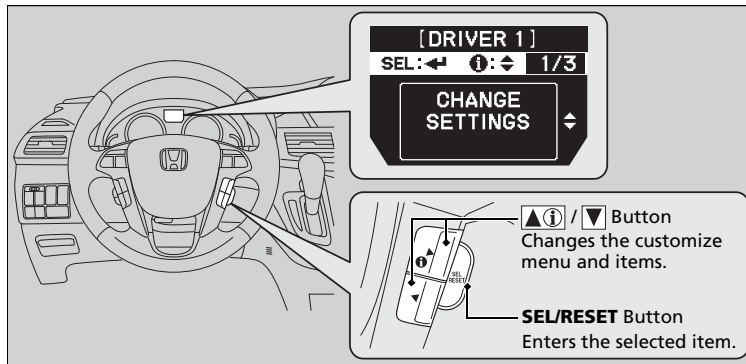
Select the **CUSTOMIZE SETTINGS** by pressing the  /  button while the ignition switch is in ON . Press the **SEL/RESET** button to change the display to the **CHANGE SETTINGS**.



» Customized Features

To customize other features, press the  /  button.

▶ **List of customizable options** P. 103

▶ **Example of customization settings** P. 105

Customization is possible when you see the driver's ID (**DRIVER 1** or **DRIVER 2**) on the **CHANGE SETTINGS** screen.

The driver's ID indicates which remote transmitter you have used to unlock the driver's door.

The customized settings are recalled every time you unlock the driver's door with that remote.

When you customize settings:

Shift to .

■ Customization flow

Press the  /  button.

Instrument Panel

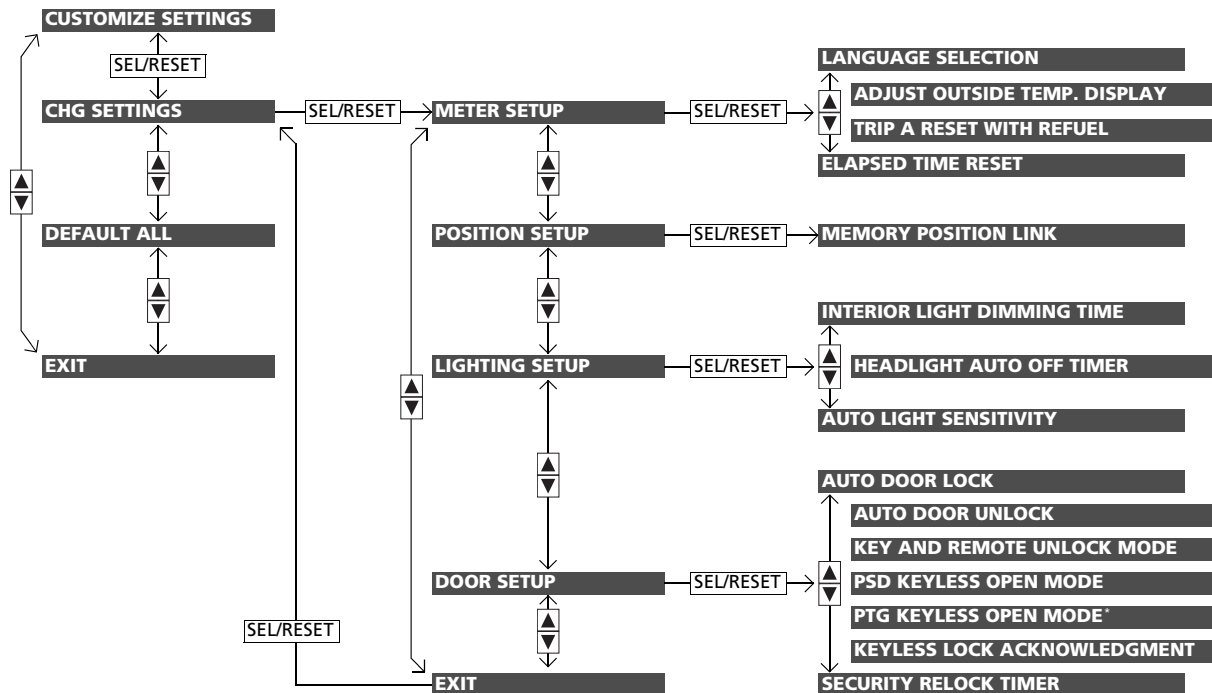

■ List of customizable options

Setup Group	Customizable Features	Description	Selectable settings
METER SETUP	LANGUAGE SELECTION	Changes the displayed language.	ENGLISH*¹/FRENCH/SPANISH
	ADJUST OUTSIDE TEMP. DISPLAY	Adjust the temperature reading by a few degrees.	-5°F ~ ±0°F*¹ ~ +5°F (U.S.) -3°C ~ ±0°C*¹ ~ +3°C (Canada)
	TRIP A RESET WITH REFUEL	Sets Trip A and the average fuel economy to reset when you refuel.	ON/OFF*¹
	ELAPSED TIME RESET	Changes the resetting conditions of the elapsed time.	IGN OFF*¹/TRIP A/TRIP B
POSITION SETUP	MEMORY POSITION LINK	Changes the driver's seat position to a stored setting.	ON*¹/OFF
LIGHTING SETUP	INTERIOR LIGHT DIMMING TIME	Changes the length of time the interior lights stay on after you close the doors.	60sec/30sec*¹/15sec
	HEADLIGHT AUTO OFF TIMER	Changes the length of time the exterior lights stay on after you close the driver's door.	60sec/30sec/15sec*¹/0sec
	AUTO LIGHT SENSITIVITY	Changes the timing for the headlights to come on.	Max/High/Mid*¹/Low/Min

*1: Default Setting

Setup Group	Customizable Features	Description	Selectable settings
DOOR SETUP	AUTO DOOR LOCK	Changes the setting for the automatic locking feature.	SHIFT FROM [P]/WITH VEH SPD^{*1}/OFF
	AUTO DOOR UNLOCK	Changes the setting for when the doors unlock automatically.	SHIFT TO [P]^{*1}/IGN OFF/OFF DRIVER DOOR^{*1}/ALL DOORS
	KEY AND REMOTE UNLOCK MODE	Changes which doors unlock with the remote transmitter on a first push.	DRIVER DOOR^{*1}/ALL DOORS
	PSD KEYLESS OPEN MODE	Changes the setting for when the power sliding door opens.	ANY TIME^{*1}/WHEN UNLOCKED
	PTG KEYLESS OPEN MODE*	Changes the setting for when the power tailgate opens.	ANY TIME^{*1}/WHEN UNLOCKED
	KEYLESS LOCK ACKNOWLEDGMENT	LOCK/UNLOCK - The exterior lights flash LOCK (2nd push) - The beeper sounds	ON^{*1}/OFF
	SECURITY RELOCK TIMER	Changes the time it takes for the doors to relock and the security system to set after you unlock the vehicle without opening any door.	90sec/60sec/30sec^{*1}
DEFAULT ALL	Sets/Cancel all the customized settings as default.		SET/CANCEL

*1: Default Setting

■ Example of customization settings

The steps for changing the **TRIP A RESET WITH REFUEL** setting to ON are shown below. The default setting for **TRIP A RESET WITH REFUEL** is OFF.

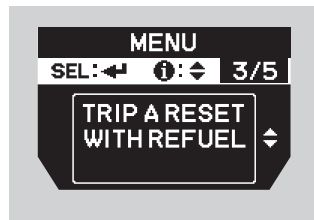
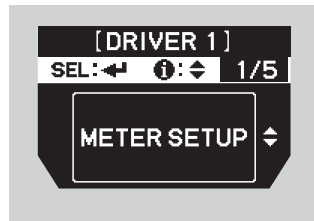
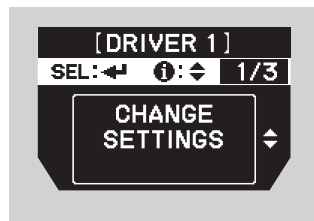

1. Press and release / button until **CUSTOMIZE SETTINGS** appears on the display.
2. Press the **SEL/RESET** button.
▶ **CHANGE SETTINGS** appears on the display.
3. Press the **SEL/RESET** button to go into the **METER SETUP** group.
4. Press the **SEL/RESET** button again.
▶ **LANGUAGE SELECTION** appears first on the display.
5. Press the / button until **TRIP A RESET WITH REFUEL** appears on the display, then press the **SEL/RESET** button.
▶ The display switches to the **SETUP** screen, where you can select **ON**, **OFF**, or **EXIT**.

Continued



6. Press the  /  button and select **ON**, then press the **SEL/RESET** button.

► The **ON** setup screen appears, then the display returns to the customize item screen.

7. Press the  /  button until **EXIT** appears on the display, then press the **SEL/RESET** button.

8. Repeat Step 7 until you return to the normal screen.

Controls

This chapter explains how to operate the various controls necessary for driving.

Setting the Clock	108
Locking and Unlocking the Doors	
Key Types and Functions	109
Locking/Unlocking the Doors from the Outside	111
Locking/Unlocking the Doors from the Inside	113
Childproof Door Locks	114
Auto Door Locking/Unlocking	115
Opening and Closing the Tailgate	119
Opening and Closing the Sliding Doors	125
Security System	133
Immobilizer System	133
Security System Alarm*	133

Opening and Closing the Windows	136
Opening and Closing the Moonroof*	139
Operating the Switches Around the Steering Wheel	
Ignition Switch	140
Turn Signals	141
Light Switches	141
Fog Lights*	143
Daytime Running Lights	143
Wipers and Washers	144
Brightness Control	146
Rear Defogger/Heated Door Mirror* Button	147
Driving Position Memory System*	148
Adjusting the Steering Wheel.....	150





Adjusting the Mirrors	151
Interior Rearview Mirror	151
Power Door Mirrors	152
Adjusting the Seats	153
Adjusting the Seat Positions	153
Interior Lights/Interior Convenience Items	168
Interior Lights	168
Interior Convenience Items	170
Heating and Cooling*	182
Using Vents, Heating and A/C	182
Climate Control System*	186
Using Automatic Climate Control	186
Automatic Climate Control Sensors .	191

* Not available on all models

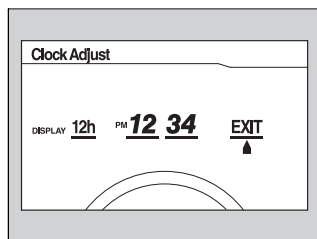
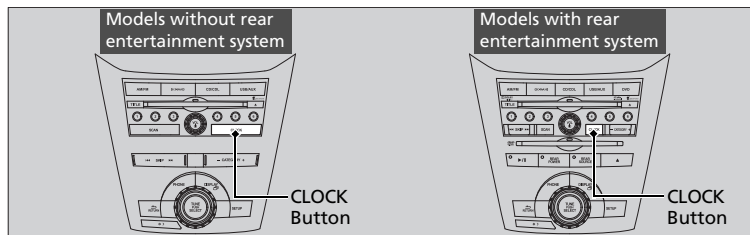
Clock

You can adjust the time in the clock display, using the **CLOCK** button with the ignition switch in ON .



1. Press the **CLOCK** button to access the clock adjustment mode screen.
2. Press  to select the item you want to adjust (12/24 hour mode, hour, minute).
3. Rotate  to make the adjustment.
4. Press  to enter your selection. Repeat steps 2 to 4 to adjust other items.
5. To enter the selection, press  and select **EXIT**, then press .



Clock

These indications are used to show how to operate the selector knob.

Rotate  to select.

Press  to enter.

You can also press the **SETUP** button to access the clock adjustment mode screen.

1. Press the **SETUP** button.
2. Rotate  to select **CLOCK ADJUST** on the screen.
3. Press , **CLOCK ADJUST** appears.

Models with navigation system

The clock is automatically updated through the navigation system, so the time does not need to be adjusted.

Key Types and Functions

This vehicle comes with the following keys:

Master Keys

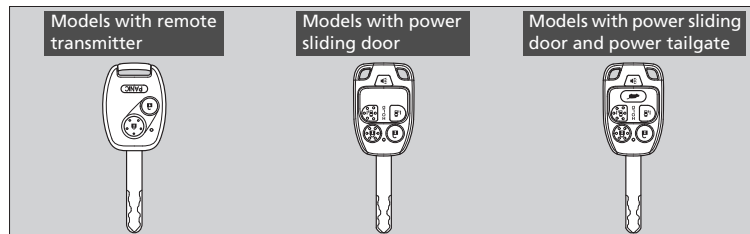

Use the keys to start and stop the engine, and to lock and unlock the doors and tailgate. You can also use the remote transmitter to lock and unlock the doors and to open the tailgate.

There is a panic button in the remote transmitter.

Key Types and Functions

All of the keys have an immobilizer system. The immobilizer system helps to protect against vehicle theft.

Immobilizer System P. 133

The keys contain precision electronics. Adhere to the following advice to prevent damage to the electronics:

- Do not leave the keys in direct sunlight, or in locations with high temperature or high humidity.
- Do not drop the keys or set heavy objects on them.
- Keep the keys away from liquids.
- Do not take the keys apart except for replacing the battery.

If the circuits in the keys are damaged, the engine may not start, and the remote transmitter may not work.

If the keys do not work properly, have them inspected by a dealer.

■ Valet Key

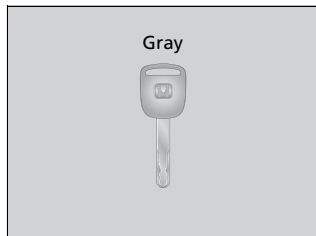

Can be used to start and stop the engine, and lock and unlock driver's door.

■ Key Number Tag

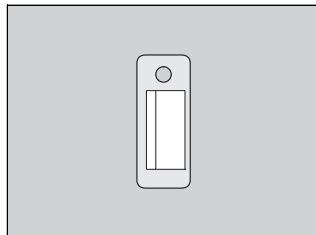

Contains a number that you will need if you purchase a replacement key.

☒ Valet Key

When you need to leave a key with a third party, leave the valet key.

☒ Key Number Tag

Keep the key number tag separate from the key in a safe place outside of your vehicle. If you wish to purchase an additional key, contact a dealer.

If you lose your key and you cannot start the engine, contact a dealer.

Locking/Unlocking the Doors from the Outside

■ Using the Remote Transmitter*

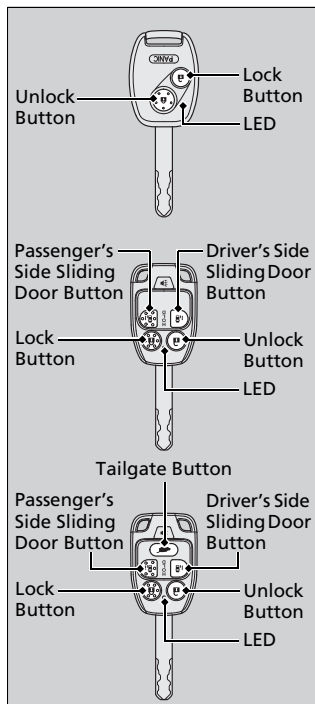

■ Locking the doors

Press the lock button.

Once:

- ▶ Some exterior lights will flash, all the doors and the tailgate will lock, and the security system sets.

Twice (within five seconds after the first push):

- ▶ A beeper sounds and verifies the security system* is set.

■ Unlocking the doors

Press the unlock button.

Once:

- ▶ Some exterior lights flash twice, and the driver's door unlocks.

Twice:

- ▶ The remaining doors and the tailgate unlock.

▶▶ Using the Remote Transmitter*

If you do not open a door within 30 seconds of unlocking the vehicle with the remote transmitter, the doors will automatically relock. You can change the relock timer setting.

▶ **Customized Features** P. 101

If the interior light switch is in the door activated position, the interior lights come on when you press the unlock button.

No doors opened: The lights fade out after 30 seconds.

Doors relocked with the remote: The lights go off immediately.

▶ **Interior Lights** P. 168

The remote transmitter uses low-power signals, so the operating range may vary depending on the surroundings.

The remote will not lock the vehicle when a door is open.

If the distance at which it works varies, the battery is probably low.

If the LED does not come on when you press a button, the battery is dead.

▶ **Replacing the Button Battery** P. 372

Models with multi-information display

You can customize the door unlock mode setting.

▶ **Customized Features** P. 101

* Not available on all models

■ Locking/Unlocking the Doors Using a Key

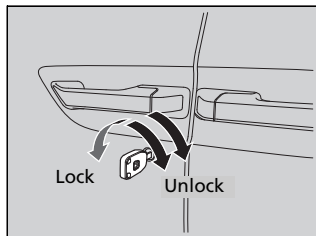

Fully insert the key and turn it.

■ Locking a Door Without Using a Key

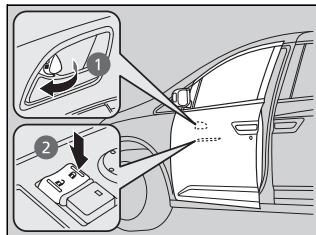

■ Locking the driver's door

Push the lock tab rearward ① or push the master door lock switch in the lock direction ②, and close the door.

■ Locking the passenger's doors

Push the lock tab rearward and close the door.

■ Lockout prevention system

The doors and tailgate cannot be locked when the key is in the ignition switch, and any door or the tailgate is open.

▣ Locking/Unlocking the Doors Using a Key

When you lock the driver's door with a key, all of the other doors and the tailgate lock at the same time. When unlocking, the driver's door unlocks first. Turn the key a second time within a few seconds to unlock the remaining doors and the tailgate.

Models with multi-information display

You can customize the door unlock mode setting.

➔ **Customized Features** P. 101

▣ Locking a Door Without Using a Key

When you lock the driver's door, all the other doors and the tailgate lock at the same time.

Make sure you have the key in your hand before locking the door to prevent it from being locked in the vehicle.

Locking/Unlocking the Doors from the Inside

■ Using the Lock Tab

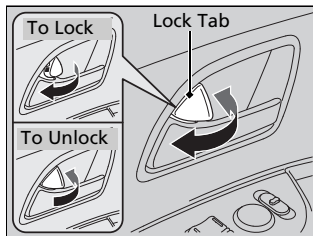

■ Locking a door

Pull the lock tab.

■ Unlocking a door

Push the lock tab in.

■ Using the Master Door Lock Switch*

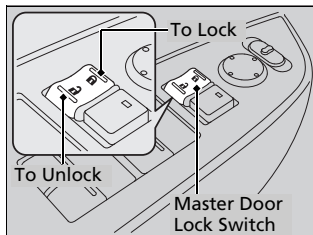

Press the master door lock switch in as shown to lock or unlock all doors and the tailgate.

►► Using the Lock Tab

When you lock the door using the lock tab on the driver's door, all of the other doors and the tailgate lock at the same time.

When you unlock the door using the lock tab on the driver's door, only the driver's door will unlock.

►► Using the Master Door Lock Switch*

When you lock/unlock the driver's door using the master door lock switch, all the other doors and the tailgate lock/unlock at the same time.

The front passenger's door also has the master door lock switch.

* Not available on all models

Childproof Door Locks

The childproof door locks prevent the rear doors from being opened from the inside regardless of the position of the lock tab.

■ Setting the Childproof Door Locks

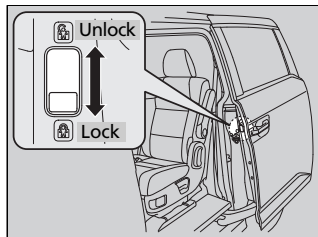

Slide the lever in the rear door to the lock position, and close the door.

■ When opening the sliding door

Open the door using the outside door handle.

▣ Childproof Door Locks

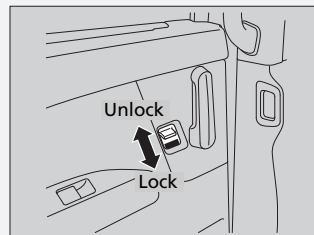

To open the door from the inside when the childproof door lock is on, put the lock tab in the unlock position, lower the rear window, put your hand out of the window, and pull the outside door handle.

▣ Models with power sliding doors

The door pillar switches become disabled.

▣ **Power Sliding Door Switches** P. 129

Auto Door Locking/Unlocking

Your vehicle locks all doors and the tailgate and unlocks the driver's door automatically when a certain condition is met.

■ Auto Door Locking

■ Drive lock mode

All doors and the tailgate lock when the vehicle's speed reaches about 10 mph (15 km/h).

■ Auto Door Unlocking

■ Park unlock mode

The driver's door unlocks when the shift lever is moved into **P** with the brake pedal depressed.

»» Auto Door Locking/Unlocking

Models without multi-information display

You can turn off or change to another auto door locking/unlocking setting using the master door lock switch.

➔ Customizing the Auto Door Locking/Unlocking Setting* P. 116

Models with multi-information display

You can turn off or change to another auto door locking/unlocking setting using the multi-information display.

➔ Customized Features P. 101

* Not available on all models

Customizing the Auto Door Locking/Unlocking Setting*

You can customize the auto door locking/unlocking setting to your liking using the master door lock switch.

List of the Auto Door Locking/Unlocking Customizable Options

■ Auto door locking

Mode	Description
Drive Lock Mode * ¹	All doors and the tailgate lock when the vehicle's speed reaches about 10 mph (15 km/h).
Park Lock Mode	All doors and the tailgate lock when the shift lever is moved out of P with the brake pedal depressed.
Off	The auto door locking is deactivated all the time.

■ Auto door unlocking

Mode	Description
Park Unlock Mode	Driver's door unlocks* ¹
	All doors and the tailgate unlock When the shift lever is moved into P with the brake pedal depressed.
Ignition Switch Unlock Mode	Driver's door unlocks
	All doors and the tailgate unlock When the ignition switch is moved out of ON II .
Off	The auto door unlocking is deactivated all the time.

*1: Default setting

Customizing Flow for Auto Door Locking Options

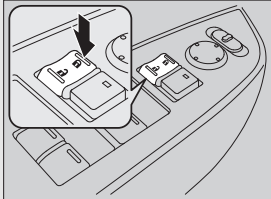
Steps	Drive Lock Mode*1	Park Lock Mode	Off
1	Move the shift lever out of P with the brake pedal depressed.	Move the shift lever to P with the brake pedal depressed.	Move the shift lever to P with the brake pedal depressed.
2	The driver's door must be closed at this stage.		Open the driver's door.
3	Turn the ignition switch to ON II .		Turn the ignition switch to ON II .
4	<p>Press and hold the front of the master door lock switch on the driver's door for more than five seconds. Release the switch after you hear a click twice.</p> 		<p>Press and hold the front of the master door lock switch on the driver's door for more than five seconds. Release the switch after you hear one click.</p>
5	<p>Turn the ignition switch to ACCESSORY I within 20 seconds. ▶ Customization is completed.</p>		

*1: Default setting

■ Customizing Flow for Auto Door Unlocking Options

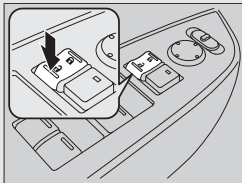
Steps	Ignition Switch Unlock Mode		Park Unlock Mode		Off
	To unlock driver's door	To unlock all doors and the tailgate	To unlock driver's door* ¹	To unlock all doors and the tailgate	
1	Move the shift lever out of P with the brake pedal depressed.		Move the shift lever to P with the brake pedal depressed.		Move the shift lever to P with the brake pedal depressed.
2	The driver's door must be closed at this stage.				Open the driver's door.
3	Turn the ignition switch to ON II .				Turn the ignition switch to ON II .
4	Press and hold the rear of the master door lock switch on the driver's door for more than five seconds. You will hear a click twice.				
					
5	Release the switch.	Keep pressing the switch for another five seconds to hear one more click.	Release the switch.	Keep pressing the switch for another five seconds to hear one more click.	Release the switch.
6	Turn the ignition switch to ACCESSORY I within 20 seconds. ▶ Customization is completed.				

*1: Default setting

Precautions for Opening/Closing the Tailgate

Always make sure individuals and objects are clear of the tailgate before opening or closing it.

■ Opening the tailgate

- Open the tailgate all the way.
 - ▶ If it is not fully opened, the tailgate may begin to close under its own weight.
- Be careful when it is windy. The wind may cause the tailgate to close.

■ Closing the tailgate

Keep the tailgate closed while driving to:

- ▶ Avoid possible damage.
- ▶ Prevent exhaust gas from leaking into the vehicle.
- **Exhaust Gas Hazard** P. 68

» Precautions for Opening/Closing the Tailgate

Models with power tailgate

WARNING

Closing a power tailgate while anyone is in the path of the tailgate can cause serious injury.

Make sure everyone is clear before closing the tailgate.

Be careful not to hit your head on the tailgate or to put your hands between the tailgate and the cargo area.

When operating the power tailgate, make sure there is enough space around your vehicle. People near the tailgate may be seriously hurt if the tailgate hits their head or closes on their heads. Be especially cautious if children are around.

When you are storing or picking up luggage from the cargo area while the engine is idling, do not stand in front of the exhaust pipe. You may get burned.

Do not allow any passenger in the cargo space. They may get hurt during hard braking, a sudden acceleration, or a crash.

Opening/Closing the Tailgate Using the Tailgate Release Button

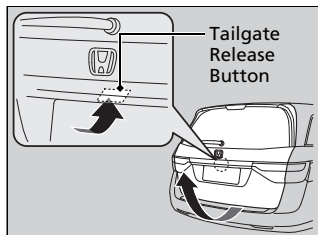

When all the doors are unlocked, the tailgate is unlocked. Push the tailgate release button and lift open the tailgate.

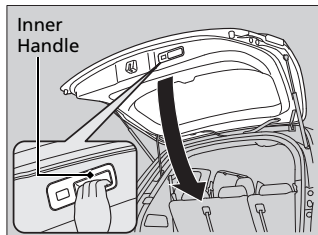

To manually close the tailgate, grab the inner handle, pull the tailgate down, and push it closed from outside.

Opening/Closing the Power Tailgate*

The power tailgate can be operated by pressing the power tailgate button on the remote transmitter, pressing the power tailgate switch on the dashboard, or pressing the button on the tailgate.

■ The power tailgate can be opened when:

- The tailgate is fully closed.
- The shift lever is in **P**.
- Press and hold the tailgate button on the remote transmitter for about one second.
 - ▶ If you have changed the **PTG keyless open mode** setting to **When Unlocked**, you need to unlock the tailgate before you press the tailgate button to open it.
 - 🔗 **Customized Features** P. 101

■ The power tailgate can be closed when:

- The tailgate is fully open.
- The shift lever is in **P**.
- Press and hold the tailgate button on the remote transmitter for about one second.

🔗 Opening/Closing the Power Tailgate*

The power tailgate may not open or close under the following conditions:

- The vehicle is parked on a steep hill.
- The vehicle is swayed in a strong wind.
- The tailgate or the roof is covered with snow or ice.

If you close the power tailgate when all the doors are locked, the power tailgate locks automatically.

If you replace the battery or the power tailgate fuse while the tailgate is open, the power tailgate may be disabled. The power tailgate resumes once you manually close the tailgate.

Installing aftermarket components other than genuine Honda accessories on the power tailgate may prevent it from fully opening or closing.

Make sure the power tailgate is fully open before you get your luggage in and out.

Make sure the power tailgate is fully closed before you start the vehicle.

Remote Transmitter

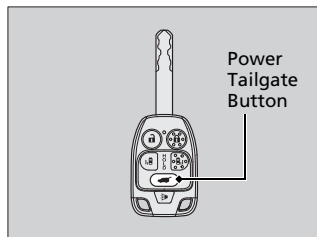

Press the power tailgate button for more than one second to operate.

To reverse direction while the power tailgate is in operation, press the button again. The beeper sounds three times and the tailgate reverses direction.

■ Customizing when to open the tailgate

ANYTIME: The power tailgate unlocks and opens at the same time. This is the default setting.

WHEN UNLOCKED: The tailgate opens unless the door is unlocked.

Models with multi-information display

► **Customized Features** P. 101

Models without multi-information display

To change the setting, do the following:

1. Apply the parking brake.
2. Turn the ignition switch to ON **II**.
3. Press and hold the power tailgate button on the dashboard until you hear a beep.
4. Turn the ignition switch to LOCK **0**.
 - When Anytime is set, you hear one long beep.
 - When Unlocked is set, you hear three short beeps.

► Opening/Closing the Power Tailgate*

If the power tailgate meets resistance while opening or closing, the auto reverse feature reverses the direction. Three beeps sound.

The auto reverse function stops sensing when the tailgate is almost closed to make sure that it fully closes.

Do not touch the sensors located on both sides of the tailgate. The power tailgate does not close if you touch either sensor when you are trying to close the tailgate.

Be careful not to scratch the sensors with a sharp object. If scratched, they can be damaged, and the power tailgate closing feature malfunctions.

■ Power Tailgate Button

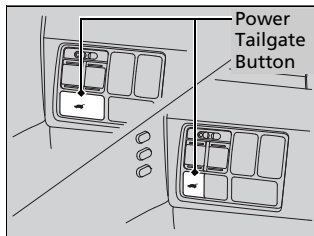

To open or close the power tailgate, press the tailgate button on the dashboard for about one second. The beeper sounds and some exterior lights flash.

To reverse direction while the power tailgate is in operation, press the button again. The beeper sounds three times and the tailgate reverses direction.

■ Power Tailgate Close Button

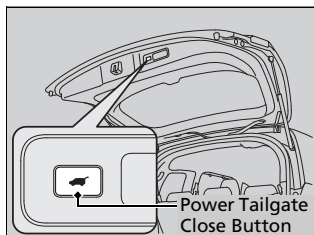

Press the button on the tailgate to close the power tailgate.
If you press the button again while the power tailgate is closing, it stops and reverses direction.

►► Power Tailgate Close Button

If you push the power tailgate close button while the tailgate is automatically opening or closing, the power tailgate operation stops. Use caution if the tailgate stops in the middle of either operation. It may suddenly swing up or down.

■ Auto-Closer

If you manually close the power tailgate, it latches automatically.

■ Power Tailgate Fail-safe Mode

The power tailgate fail-safe mode detects if there is an extra load on the tailgate (for example, it is covered with snow). If an extra load is detected, the tailgate opens completely then lowers to the close position.

☒ Auto-Closer

The auto-closer feature does not activate if you push the tailgate release button while the power tailgate is closing.

Do not put any force on the tailgate while the power tailgate is latching.

Keep your hands away from the tailgate when you manually close the tailgate and let it latch automatically. It is dangerous to put your hands around the tailgate as it starts to latch itself.

☒ Power Tailgate Fail-safe Mode

If you try to manually close the power tailgate immediately after it fully opens, the power tailgate fail-safe mode may activate.

Once the power tailgate fail-safe mode activates, wait until the power tailgate fully closes. Keep away from the power tailgate when it is in motion.

If the power tailgate fail-safe mode constantly activates, consult at a dealer.

Precautions for Opening/Closing the Sliding Doors

Always make sure individuals and objects are clear of the sliding doors.

■ Opening the sliding doors

Open the door all the way until it stops.

- ▶ If it is not fully opened, the door may close again by its own weight.

» Precautions for Opening/Closing the Sliding Doors

WARNING

Closing a sliding door while any part of a passenger is in the door's path can cause serious injury.

Make sure all passengers are clear of the doorway before closing a sliding door.

Do not leave the sliding door open while parking on a slope. The door may slide close by its weight.

When opening or closing the sliding doors, do not grab the door or place your hand on the vehicle body. Use the handle.

Do not put your foot and hand on the sliding door rail and on the rollers.

If a small child is in the vehicle, use the childproof door locks to prevent the child in the rear seat from accidentally opening the sliding doors.

 **Childproof Door Locks** P. 114

Do not put any items that stick out from the pocket in the door pockets. It may prevent the doors from properly opening or closing, and damage the vehicle.

Opening/Closing a Sliding Door

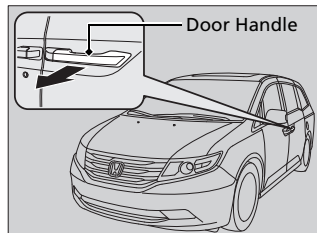

■ From outside

To open: Pull the door handle rearward and slide the door.

To close: Pull the door handle forward and slide the door.

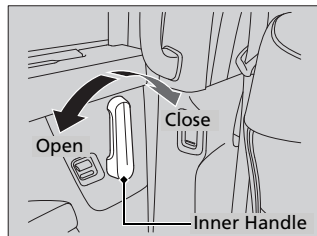

■ From inside

To open: Grab the inner handle and pull it rearward. Slide the door.

To close: Grab the inner handle and pull it forward. Slide the door.

▣ Opening/Closing a Sliding Door

Once a door is fully opened, the door position is locked.

Do not step on the cover that stores the wiring for the sliding door. The wiring is likely to get damaged, causing the sliding door operation to malfunction.

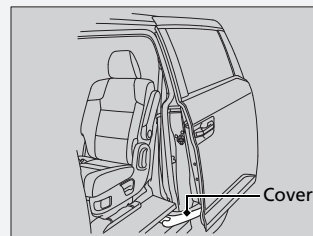

If you try to open the sliding door with the window open more than 3 inch (8 cm), the door stops halfway. Close the door, close the window, and then open the door again.

While the fuel fill door is open, you cannot open the driver side sliding door. Operate the door after the fuel fill door is closed.

▣ Models with power sliding doors

If you try to open the driver side power sliding door while the fuel fill door is open, the beeper sounds and the door stops.

Opening/Closing the Power Sliding Doors*

The power sliding doors can be operated by pressing the power sliding door button on the remote transmitter, pressing the power sliding door switches on the dashboard or door pillars, or using the door handle.

The power sliding doors can be operated when:

- The sliding door main switch is in the **ON** position.
- The power sliding door is unlocked.
- The fuel fill door is closed (on the driver side sliding door only).
- The key is not in the ignition switch when using the remote transmitter.
- The shift lever is in **[P]**, the brake pedal is depressed, or the parking brake is applied (with the ignition switch in ON **[II]**) when using the power sliding door switches on the dashboard.

⌘ Opening/Closing the Power Sliding Doors*

If you move the shift lever out of P, and release the brake pedal and the parking brake:

While opening – The sliding door stops and is left ajar.

While closing – The beeper sounds until the door closes.

Check that passengers, especially children, do not have their hands on the sliding doors or on the door pillars before its operation. If someone is caught in the opening or closing sliding door, it can cause serious injury.

Before replacing a rear tire, turn the power sliding door main switch to OFF.

Operate the power sliding doors only when the vehicle is at a complete stop. Make sure you apply the brake when rear passengers are boarding or exiting.

■ Switching between manual and automatic operations

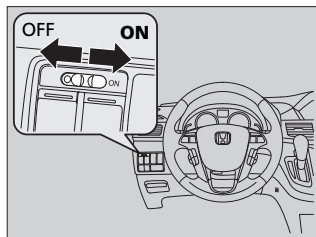

Automatic operation: Select the **ON** position of the sliding door main switch.

Manual operation: Select the **OFF** position of the sliding door main switch.

► **Opening/Closing a Sliding Door** P. 126

▣ Opening/Closing the Power Sliding Doors*

Do not turn the main switch off while the power sliding door is in operation on a slope. The power sliding door's fail-safe mode activates and the beeper sounds continuously.

When the fail-safe mode is active, turn the main switch on and close the door automatically.





The following can deactivate the fail-safe mode and the sliding door may close by its own weight.

- Using the door handle
- Turning the main switch from **ON** to **OFF**

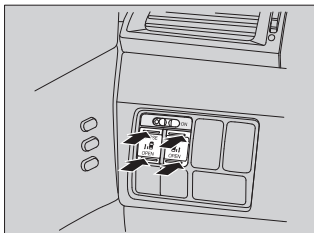
If you replace the battery or the power sliding door fuse while the door is open, the power sliding door may be disabled. The power sliding door resumes once you manually close the door.

Power Sliding Door Switches



The power sliding door opens when you press the **OPEN** side of the  /  switch, and closes when you press the **CLOSE** side of the  /  switch.

While the power sliding door is in operation, if you press the switch that corresponds to that power sliding door, the beeper sounds and the operation stops.

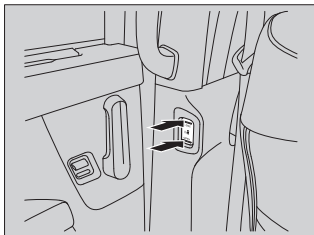

To resume the power sliding door operation, press the same switch again.

Opening/Closing the Power Sliding Doors*

Auto Reverse

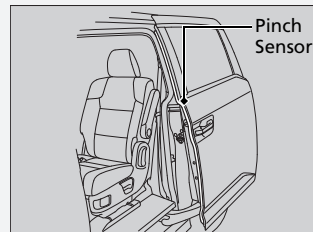

Do not touch the pinch sensor located at the front edge of the power sliding door. Do not damage the sensor. The power sliding door may not operate properly.

If the power sliding door senses resistance when closing automatically, it will stop closing and reverse direction. The beeper sounds.

Before the power sliding door operation, make sure there are no people or obstacles near the door. The auto reverse function should be activated in case of emergency only. If someone is caught in the opening or closing sliding door, it can cause serious injury. Pay special attention to children.

Closing a power sliding door on someone's hand or fingers can cause serious injury. Some parts of the door edge do not sense resistance when the door is near closing.

* Not available on all models

Continued

Remote Transmitter

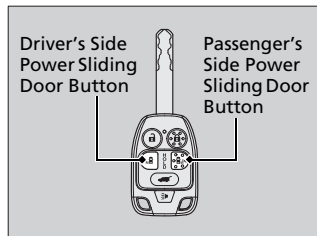

Press the power sliding door button for more than one second to operate.

While the power sliding door is in operation, if you press the button that corresponds to that power sliding door, the beeper sounds and the operation stops.

If you press the same button again, the sliding door reverses its direction.

Customizing when to open the sliding doors

ANYTIME: The power sliding door unlocks and opens at the same time. This is the default setting.



WHEN UNLOCKED: The door opens unless the door is unlocked.

Models with multi-information display

► Customized Features P. 101

Models without multi-information display

To change the setting, do the following:

1. Press and hold the **CLOSE** side of the  switch on the dashboard until step 3.
2. Press and hold the  button on the remote transmitter.
 - Release the button when the LED on the remote flashes.
3. Release the dashboard switch.
 - Follow steps one through three within 20 seconds.
4. Repeat the above procedure four times.

Remote Transmitter

When you press the power sliding door button to open the door, the front door on the same side unlocks.

Customizing when to open the sliding doors

When you select **WHEN UNLOCKED**, you will hear three short beeps.

When you select **ANY TIME**, you will hear one long beep.

In **WHEN UNLOCKED**, trying to operate the power sliding door without unlocking the door triggers the beeper to sound.

Models without multi-information display

Before you start customizing,

- Turn the main switch to OFF.
- Turn the ignition switch to LOCK , and remove the key.
- Close and lock all doors.

Door Handles

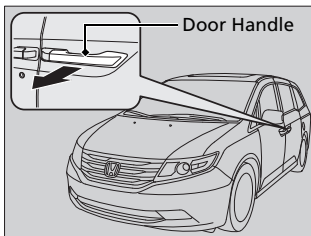

Outer handles

Pull up on the outer handle towards you. The sliding door starts opening or closing.

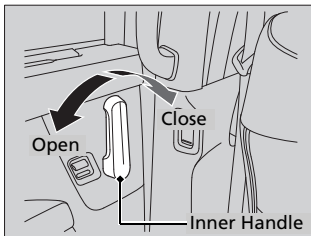

Inner handles

Pull it rearward to automatically open the sliding door, and pull it forward to automatically close the door.

While the power sliding door is in operation, if you pull either handle that corresponds to that power sliding door, the beeper sounds and the operation stops.

To resume the power sliding door operation, pull the same handle in the same direction again.

Opening/Closing the Power Sliding Doors*

The beeper sounds and the power sliding door does not open when you pull the inner or outer handle under the following conditions:

- The ignition switch is in ON **II**
- The shift lever is in other than **P**
- The brake pedal is released
- The parking brake is released

If you leave the power sliding door half open on a steep hill with the engine off, the door starts to sliding down towards the hill bottom after 30 minutes. While the door is sliding down, the beeper sounds.

* Not available on all models

Auto-Closer

If you manually close the power sliding door, it latches automatically.

Models with power sliding door

The auto-closer feature activates with or without the main switch ON. The only exception is when the fuel fill door is open with the main switch ON.

Auto-Closer

Keep your hands away from the power sliding door. The manually closed door latches automatically when it is half-shut.

The auto-closer feature does not activate if you keep pulling the inner or outer handle and while the sliding door is closing.

Do not put any force on the power sliding door while the door is latching.

Immobilizer System

The immobilizer system prevents a key that has not been pre-registered from starting the engine. Each key contains electronic transmitters that use electronic signals to verify the key.

Pay attention to the following when inserting the key into the ignition switch:

- Do not allow objects that emit strong radio waves near the ignition switch.
- Make sure the key is not covered by or touching a metal object.
- Do not bring a key from another vehicle's immobilizer system near the ignition switch.

Security System Alarm*

The security system alarm activates when the doors, tailgate, or hood are opened without the key, or remote transmitter. It also activates if you turn the ignition switch to ON  after locking the doors with the remote transmitter.

■ When the security system alarm activates

The horn sounds intermittently, and all of the exterior lights flash.

■ To deactivate the security system alarm

Unlock the vehicle using the key or remote transmitter. The system, along with the horn and flashing lights, is deactivated.

* Not available on all models

» Immobilizer System

NOTICE

Leaving the ignition key in the vehicle can result in theft or accidental movement of the vehicle. Always take the ignition key with you whenever you leave the vehicle unattended.

Do not alter the system or add other devices to it. Doing so may damage the system and make your vehicle inoperable.

» Security System Alarm*

The security alarm continues for a maximum of two minutes until the security system deactivates.

■ Setting the security system alarm

The security system alarm automatically sets when the following conditions have been met:

- The ignition switch is in LOCK [0], and the key has been removed from the ignition switch.
- The hood is closed.
- All doors and the tailgate are locked with the key or the remote transmitter.

■ When the security system alarm sets

The security system alarm indicator in the instrument panel blinks. When the blinking interval changes after about 15 seconds, the security system alarm is set.

■ To cancel the security system alarm

The security system alarm is canceled when the vehicle is unlocked using the key or remote transmitter. The security system alarm indicator goes off at the same time.

☒ Security System Alarm*

Do not set the security system alarm when someone is in the vehicle or a window is open. The system can accidentally activate when:

- Unlocking the door with the lock tab or the master door lock switch.

Models with power tailgate

- Opening the tailgate with the power tailgate button on the dashboard.

If the battery goes dead after you have set the security system alarm, the security alarm may go off once the battery is recharged or replaced.

If this occurs, deactivate the security system alarm by unlocking a door using the key or remote transmitter.

Do not attempt to alter this system or add another device to it.

■ Panic Mode

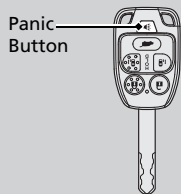
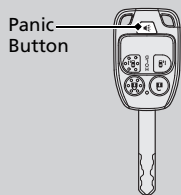

■ The panic button on the remote transmitter

If you press the panic button for approximately one second, the following will occur for about 30 seconds:

- The horn sounds.
- Some exterior lights flash.

■ Canceling panic mode

Press any button on the remote transmitter, or turn the ignition switch to ON .

Opening/Closing the Power Windows

The power windows can be opened and closed when the ignition switch is in ON (II), using the switches on the doors. The driver side switches can be used to open and close all of the windows.

The power window lock button on the driver side must be switched off (not pushed in, indicator off) to open and close the windows from anywhere other than the driver's seat.

When the power window lock button is pushed in, the indicator comes on and you can only operate the driver's window. Turn the power window lock button on when children are in the vehicle.

Opening/Closing Windows with Auto-Open/Close Function *

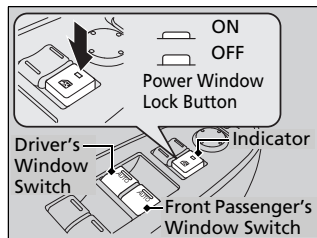

Automatic operation

To open: Push the switch down firmly.

To close: Pull the switch up firmly.

The window opens or closes completely. To stop the window at any time, push or pull the switch briefly.

Manual operation

To open: Push the switch down lightly.

To close: Pull the switch up lightly.

Release the switch when the window reaches the desired position.

Opening/Closing the Power Windows

WARNING

Closing a power window on someone's hands or fingers can cause serious injury.

Make sure your passengers are away from the windows before closing them.

The power windows can be operated for up to 10 minutes after you turn the ignition switch off. Opening either front door cancels this function.

Auto Reverse

If a power window senses resistance when closing automatically, it will stop closing and reverse direction.

The driver's window auto reverse function is disabled when you continuously pull up the switch.

The auto reverse function stops sensing when the window is almost closed to ensure that it fully closes.

Opening/Closing Windows without Auto-Open/Close Function

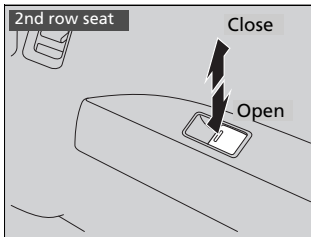

To open: Push the switch down.

To close: Pull the switch up.

Release the switch when the window reaches the desired position.

Opening the Windows and Moonroof* with the Remote Transmitter

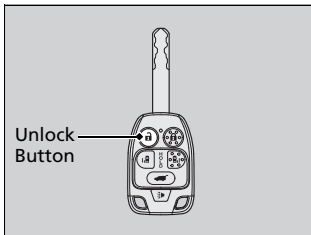

To open: Press the unlock button twice within 10 seconds and hold it down for the second time. If the windows stop midway, repeat the procedure.

* Not available on all models

■ Opening/Closing the Windows and Moonroof* with the Key

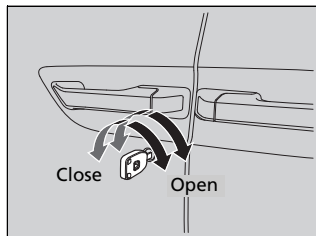

To open: Unlock the driver's door with the key. Within 10 seconds of returning the key to the central position, turn the key in the unlock direction and hold it there.

To close: Lock the driver's door with the key. Within 10 seconds of returning the key to the central position, turn the key in the lock direction and hold it there.

Release the key to stop the windows/moonroof at the desired position. If you want further adjustment, repeat the same operation.

Opening/Closing the Moonroof

You can only operate the moonroof when the ignition switch is in ON **II**. Use the switch in the front of the ceiling to open and close the moonroof.

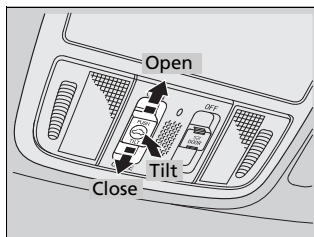

Automatic operation

To open: Pull the switch back firmly, then release.

To close: Push the switch forward firmly, then release.

The moonroof will automatically open or close all the way. To stop the moonroof midway, touch the switch briefly.

Manual operation

To open: Pull the switch back, and hold it until the desired position is reached.

To close: Push the switch forward, and hold it until the desired position is reached.

Tilting the moonroof up

To tilt: Push on the center of the moonroof switch.

To close: Push the switch forward firmly, then release.

Opening/Closing the Moonroof

WARNING

Opening or closing the moonroof on someone's hands or fingers can cause serious injury.

Make sure all hands and fingers are clear of the moonroof before opening or closing it.

NOTICE

Opening the moonroof in below freezing temperature or when it is covered with snow or ice can damage the moonroof panel or motor.

The power moonroof can be operated for up to 10 minutes after you turn the ignition switch off. Opening either front door cancels this function.

When resistance is detected, the auto reverse function causes the moonroof to change directions, then stop. Auto reverse stops sensing when the moonroof is almost closed to ensure that it fully closes. Make sure that all objects, including fingers, are clear of the moonroof.

You can use the remote transmitter or the key to operate the moonroof.

➤ **Opening the Windows and Moonroof* with the Remote Transmitter** P. 137

➤ **Opening/Closing the Windows and Moonroof* with the Key** P. 138

* Not available on all models

Ignition Switch

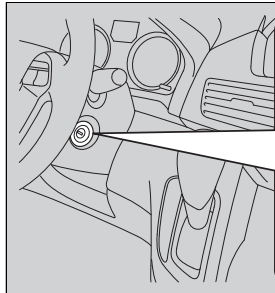

- 0** LOCK: Insert and remove the key in this position.
- I** ACCESSORY: Operate the audio system and other accessories in this position.
- II** ON: This is the position when driving.
- III** START: This position is for starting the engine. The switch returns to ON **II** when you let go of the key.

Ignition Switch

You cannot take the key out unless the shift lever is in **P**.

If you open the driver's door when the key is in LOCK **0** or ACCESSORY **I**, a warning buzzer will sound to remind you to take the key out.

When this happens, the following messages appear on the multi-information display*:

- In LOCK **0**: **REMOVE KEY**.
- In ACCESSORY **I**: **REMOVE KEY** The buzzer will stop when you take the key out.

If the key won't turn from LOCK **0** to ACCESSORY **I**, turn the key while moving the steering wheel left and right. The steering wheel will unlock, allowing the key to turn.

Turn Signals

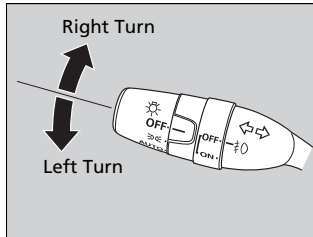

The turn signals can be used when the ignition switch is in ON **II**.

Light Switches

Manual Operation

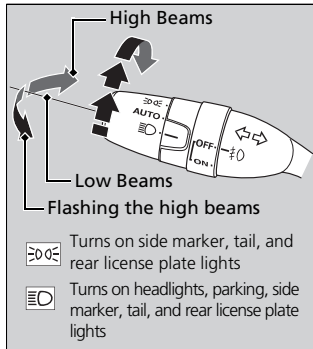

Rotating the light switch turns the lights on and off, regardless of the position of the ignition switch.

■ High beams

Push the lever forward until you hear a click.

■ Low beams

When in high beams, pull the lever back to return to low beams.

■ Flashing the high beams

Pull the lever back, and release it.

▶▶ Light Switches

If you remove the key from the ignition switch while the lights are on, a chime sounds when the driver's door is opened.

When the lights are on, the lights on indicator in the instrument panel will be on.

▶ **Lights On Indicator** P. 79

▶▶ Models with high voltage discharge tube bulb

Repeatedly turning the headlights on and off reduces the life of the HID headlight bulbs. If you sense that the level of the headlights is abnormal, have the vehicle inspected by a dealer.

Do not leave the lights on when the engine is off because it will cause the battery to discharge.

Automatic Lighting Control*

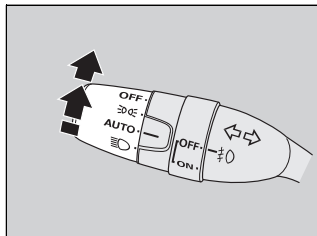

Automatic lighting control can be used when the ignition switch is in ON **II**.

When you turn the light switch to **AUTO**, the headlights and other exterior lights will switch on and off automatically depending on the ambient brightness.

- ▶ You can change the auto light sensitivity setting.

▶ **Customized Features** P. 101

Automatic Lighting Off Feature

The headlights, all other exterior lights, and the instrument panel lights turn off within 15 seconds after you remove the key and close the driver's door.

- ▶ You can change the headlight auto off timer setting.

▶ **Customized Features** P. 101

If you turn the ignition switch to LOCK **0** with the headlight switch on, but do not open the door, the lights turn off after 10 minutes (3 minutes, if the switch is in the **AUTO** position).

The lights turn on again when you unlock or open the driver's door. If you unlock the door, but do not open it within 15 seconds, the lights go off. If you open the driver's door, you will hear a lights on reminder chime.

Automatic Lighting Control*

We recommend that you turn on the lights manually when driving at night, in a dense fog, or in dark areas such as long tunnels or parking facilities.

The light sensor is in the location shown below. Do not cover this light sensor with anything; otherwise, the automatic lighting system may not work properly.

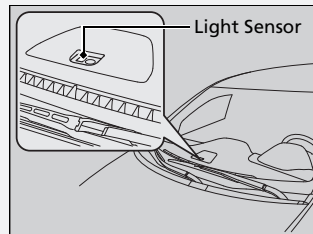

Adjust the auto light sensitivity as follows:

Setting	The exterior lights come on when the ambient light is at
MAX	Bright
HIGH	
MID	
LOW	
MIN	

Fog Lights*

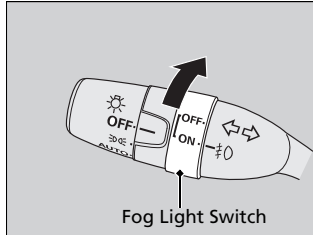

When the low beam headlights are on, turn the fog light switch on to use the fog lights.

Daytime Running Lights

The high beam headlights come on slightly dimmer than normal when the following conditions have been met:

- The ignition switch is in ON **II**.
- The headlight switch is off.
- The parking brake is released.

The lights remain on even if you set the parking brake. Turning off the ignition switch will turn off the daytime running lights.

The high beam headlights return to the original brightness once the headlight switch is turned on.

* Not available on all models

☒ Fog Lights*

When the fog lights are on, the indicator in the instrument panel will be on.

☒ **Fog Light Indicator*** P. 80

Wipers and Washers

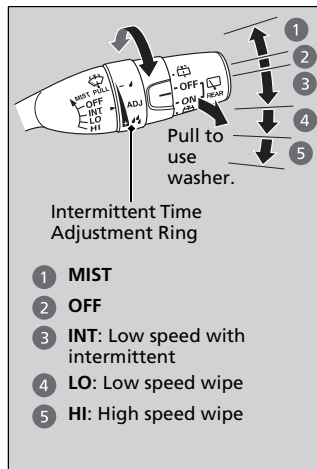

The windshield wipers and washers can be used when the ignition switch is in ON **II**.

■ MIST

The wipers run at high speed until you release the lever.

■ Wiper switch (OFF, INT, LO, HI)

Change the wiper switch setting according to the amount of rain.

■ Adjusting the delay

Turn the adjustment ring to adjust the wiper delay.



■ Washer

Sprays while you pull the lever toward you. When you release the lever, the wipers make two or three more sweeps before stopping.

Wipers and Washers

NOTICE

Do not use the wipers when the windshield is dry. The windshield will get scratched, or the rubber blades will get damaged.

NOTICE

In cold weather, the blades may freeze to the windshield, becoming stuck. Operating the wipers in this condition may damage the wipers. Use the defroster to warm the windshield, then turn the wipers on.

If the vehicle speeds up while the wipers are operating intermittently, the length of the wipe interval shortens. When the vehicle starts moving, the wipers make a single sweep. When the vehicle speeds up, the wiper operation's shortest delay setting **(I)** and the **LO** setting become the same.

Turn the washers off if no washer fluid comes out. The pump may get damaged.

■ Rear Wiper/Washer

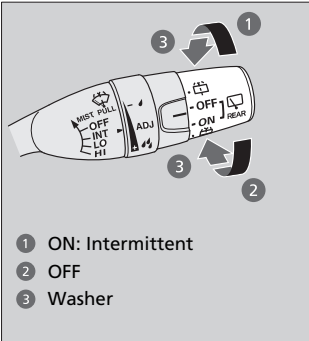

The rear wiper and washer can be used when the ignition switch is in ON .

■ Wiper switch (OFF, ON)

The wiper operates intermittently after completing a few sweeps.

■ Washer ()

Sprays while you rotate the switch to this position.

Hold it to activate the wiper and to spray the washer. Once released, it stops operating after a few more sweeps.

■ Operating in reverse

When you shift the transmission to R with the front wiper activated, the rear wiper operates automatically as follows even if its switch is off.

Front Wiper Position	Rear Wiper Operation
INT (Intermittent)	Intermittent
LO (Low speed wipe)	Continuous
HI (High speed wipe)	

►► Rear Wiper/Washer

If the wiper stops operating due to any obstacle such as the build-up of snow, park the vehicle in a safe place:

Rotate the wiper switch to OFF, and turn the ignition switch to ACCESSORY I or LOCK 0, then remove the obstacle.

The wiper motor is equipped with a breaker that may stop motor operation temporarily to prevent an overload. Wiper operation will return to normal within a few minutes, once the circuit has returned to normal.

Brightness Control

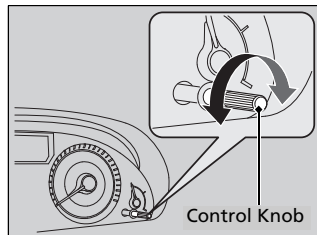

When the ignition switch is in ON (II), you can use the brightness control knob to adjust instrument panel brightness.

Brighten: Turn the knob to the right.

Dim: Turn the knob to the left.

You will hear a beeper when the brightness reaches minimum or maximum. The information display*/multi-information display* will return to its original state several seconds after you adjust the brightness.

■ Brightness level indicator

The brightness level is shown on the information display*/multi-information display* while you are adjusting it.

On multi-information display

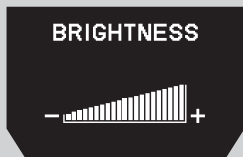



On information display



☒ Brightness Control

Instrument panel brightness varies, depending on whether the exterior lights are on or off. The instrument panel dims to reduce glare when they are on.

Pressing the  (Select/Reset) knob or the  (information) button* switches the display.

If you turn the knob to the right until the brightness display is up to max, the beeper sounds. This cancels the reduced instrument panel brightness when the exterior lights are on.

Rear Defogger/Heated Door Mirror* Button

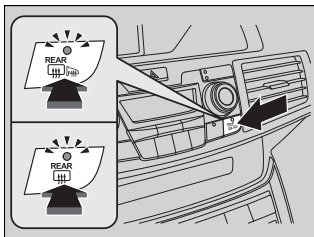

Press the rear defogger and heated door mirror button to defog the rear window and mirrors when the ignition switch is in ON **II**.

Models with heating and cooling system

The rear defogger and heated door mirrors* automatically switch off after 20 minutes.

Models with climate control system

The rear defogger and heated door mirrors automatically switch off after 10-30 minutes depending on the outside temperature. However, if the outside temperature is 32°F (0°C) or below, they do not automatically switch off.

▶▶ Rear Defogger/Heated Door Mirror* Button

NOTICE

When cleaning the inside of the rear window, be careful not to damage the heating wires. It is critical to wipe the window from side to side along the defogger heating wires.

This system consumes a lot of power, so turn it off when the window has been defogged. Also, do not use the system for a long period when the engine is idling. This may weaken the battery, making it difficult to start the engine.

* Not available on all models

Driving Position Memory System*

You can store two driver's seat and outside mirrors position with the driving position memory system.

When you unlock and open the driver's door with a remote transmitter, the seat and outside mirrors adjust automatically to one of the two preset positions.

The multi-information display shows you which remote transmitter you used to unlock the vehicle when you enter.

- **DRIVER 1** transmitter is linked to memory button 1.
- **DRIVER 2** transmitter is linked to memory button 2.

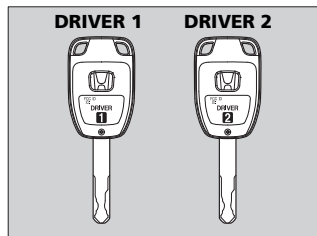

▶▶ Driving Position Memory System*

Using the multi-information display, you can disable the automatic seat adjustment function.

▶▶ **Customized Features** P. 101

Storing a Position in Memory

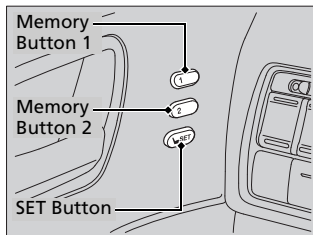

1. Adjust the driver's seat and the outside mirrors to the desired position, and turn the ignition switch to ON **[II]**.
2. Press the SET button.
 - ▶ You will hear the beeper, and the memory button indicator light will blink.
3. Press and hold memory button **[1]** or **[2]** within five seconds of pressing the SET button.
 - ▶ Once the seat and the outside mirrors position has been memorized, the indicator light on the button you pressed stays on.

Recalling the Stored Position

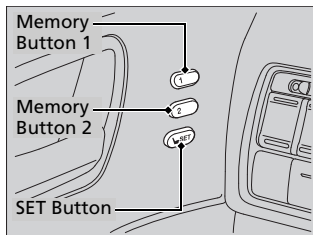

1. Move the shift lever to **[P]**.
2. Apply the parking brake.
3. Press a memory button (**[1]** or **[2]**).
 - ▶ You will hear the beeper, and the indicator light will blink.

The seat and the outside mirrors will automatically move to the memorized position. When it has finished moving, you will hear the beeper, and the indicator light stays on.

Storing a Position in Memory

After you press the SET button, the storing operation will be canceled when:

- You do not press the memory button within five seconds.
- You readjust the seat position before the double-beep.
- You readjust the outside mirrors.
- You turn the ignition switch to any position except ON **[II]**.

Recalling the Stored Position

The seat and the outside mirrors will stop moving if you:

- Press the SET button, or a memory button (**[1]** or **[2]**).
- Adjust the seat position.
- Adjust the outside mirrors.
- Shift into any position except **[P]**.

Adjusting the Steering Wheel

The steering wheel height and distance from your body can be adjusted so that you can comfortably grip the steering wheel in an appropriate driving posture.

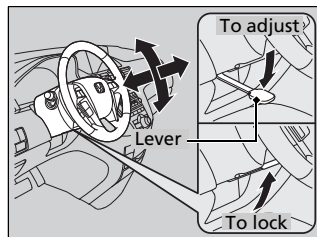

1. Push the steering wheel adjustment lever down.
 - The steering wheel adjustment lever is under the steering column.
2. Move the steering wheel up or down, and in or out.
 - Make sure you can see the instrument panel gauges and indicators.
3. Pull the steering wheel adjustment lever up to lock the steering wheel in position.
 - After adjusting the position, make sure you have securely locked the steering wheel in place by trying to move it up, down, in, and out.

Adjusting the Steering Wheel

⚠ WARNING

Adjusting the steering wheel position while driving may cause you to lose control of the vehicle and be seriously injured in a crash.

Adjust the steering wheel only when the vehicle is stopped.

Make any steering wheel adjustments before you start driving.

Interior Rearview Mirror

Adjust the angle of the rearview mirror when you are sitting in the correct driving position.

■ Rearview Mirror with Day and Night Positions*

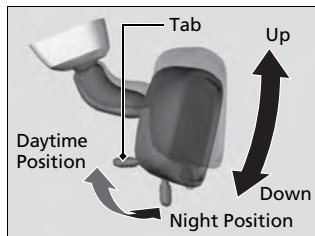

Flip the tab to switch the position. The night position will help to reduce the glare from headlights behind you when driving after dark.

■ Automatic Dimming Rearview Mirror*

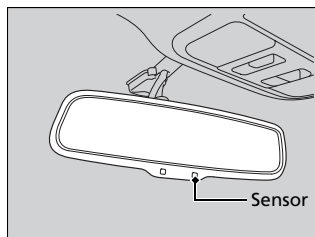

When driving after dark, the automatic dimming rearview mirror always reduces the glare from headlights behind you, based in inputs from the mirror sensor. This feature is always active.

» Adjusting the Mirrors

Keep the inside and outside mirrors clean and adjusted for best visibility.

Adjust the mirrors before you start driving.

➤ **Adjusting the Seat Positions** P. 153

» Automatic Dimming Rearview Mirror*

The auto dimming function cancels when the shift position is in **[R]**.

* Not available on all models

Power Door Mirrors

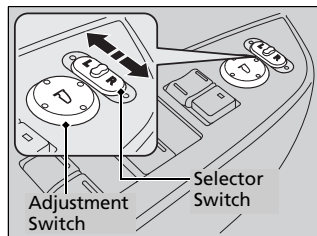

You can adjust the door mirrors when the ignition switch is in ON **II**.

■ Mirror position adjustment

L/R selector switch: Select the left or right mirror. After adjusting the mirror, return the switch to the center position.

Mirror position adjustment switch: Press the switch left, right, up, or down to move the mirror.

■ Reverse Tilt Door Mirror

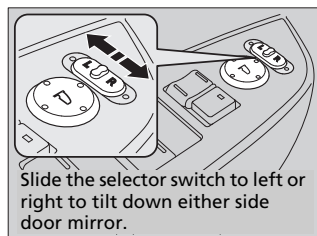

Slide the selector switch to left or right to tilt down either side door mirror.

If activated, either side door mirror automatically tilts downward when you put the shift lever in **R**; this improves close-in visibility on the selected side of the vehicle when backing up. The mirror automatically returns to its original position when you shift out of **R**.

To activate this feature, turn the ignition switch to ON **II** and slide the selector switch to the left or right side.

Adjusting the Seat Positions

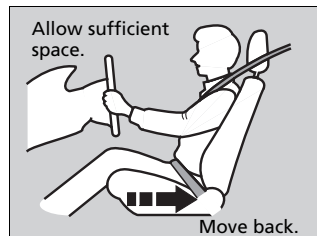

Adjust the driver's seat as far back as possible while allowing you to maintain full control of the vehicle. You should be able to sit upright, well back in the seat and be able to adequately press the pedals without leaning forward, and grip the steering wheel comfortably. The passenger's seat should be adjusted in a similar manner, so that it is as far back from the front airbag in the dashboard as possible.

■ Adjusting the front driver's and passenger's power seat(s)*

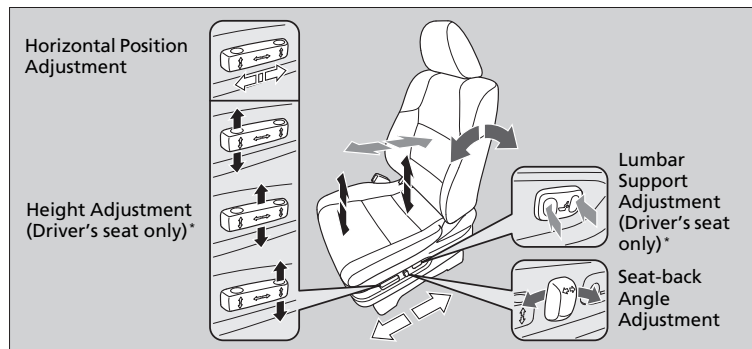

* Not available on all models

Continued

Adjusting the Seats

WARNING

Sitting too close to a front airbag can result in serious injury or death if the front airbags inflate.

Always sit as far back from the front airbags as possible while maintaining control of the vehicle.

The National Highway Traffic Safety Administration and Transport Canada recommend that drivers allow at least 10 inches (25 cm) between the center of the steering wheel and the chest.

Always make seat adjustments before driving.

Once a seat is adjusted correctly, rock it back and forth to make sure it is locked in position.

■ Adjusting the passenger's manual seats

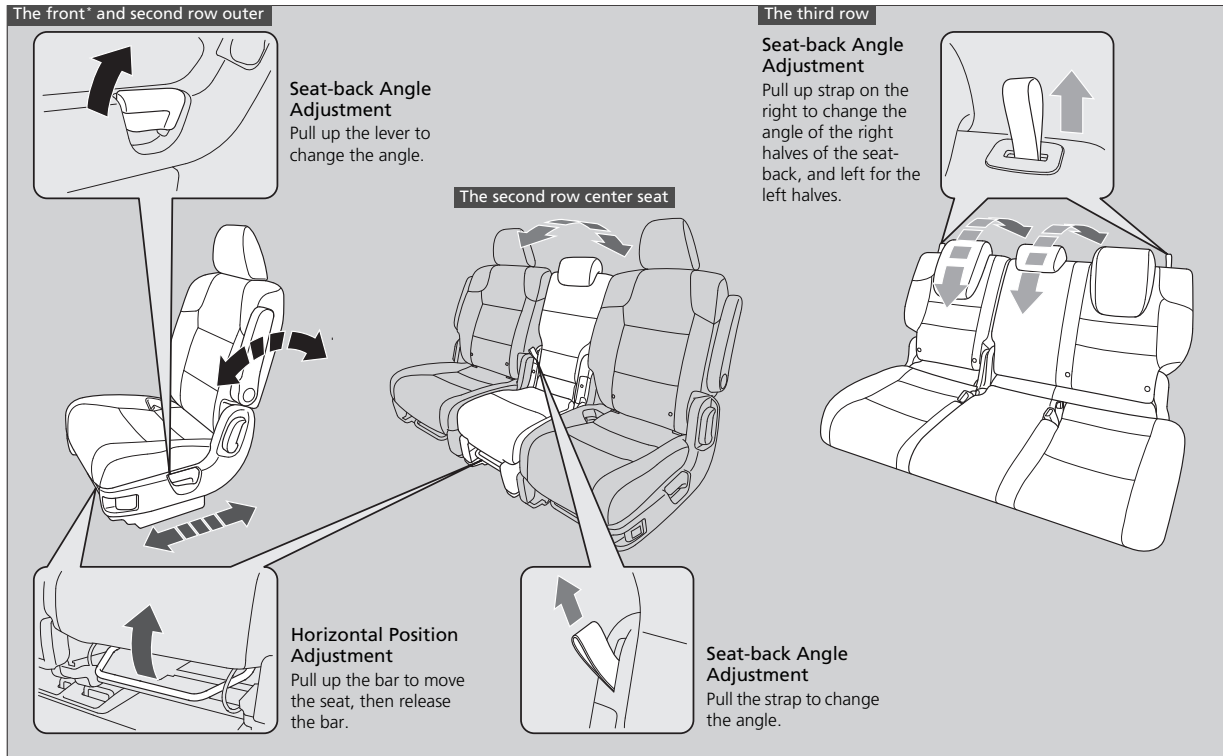

■ Adjusting the Seat-Backs

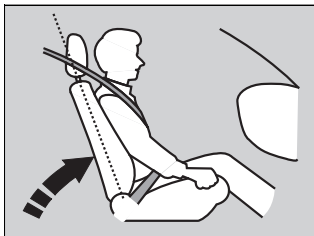

Adjust the driver's seat-back to a comfortable, upright position, leaving ample space between your chest and the airbag cover in the center of the steering wheel.

The front seat passenger should also adjust their seat-back to a comfortable, upright position.

Reclining a seat-back so that the shoulder part of the belt no longer rests against the occupant's chest reduces the protective capability of the belt. It also increases the chance of sliding under the belt in a crash and being seriously injured. The farther a seat-back is reclined, the greater the risk of injury.

» Adjusting the Seat-Backs

⚠ WARNING

Reclining the seat-back too far can result in serious injury or death in a crash.

Adjust the seat-back to an upright position, and sit well back in the seat.

Do not put a cushion, or other object, between the seat-back and your back.

Doing so may interfere with proper seat belt or airbag operation.

If you cannot get far enough away from the steering wheel and still reach the controls, we recommend that you investigate whether some type of adaptive equipment may help.

Adjusting the Head Restraints

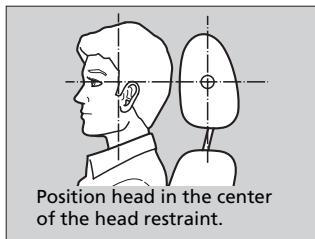

Your vehicle is equipped with head restraints in all seating positions.

Head restraints are most effective for protection against whiplash and other rear-impact crash injuries when the center of the back of the occupant's head rests against the center of the restraint. The tops of the occupant's ears should be level with the center height of the restraint.

Adjusting the Head Restraints

⚠ WARNING

Improperly positioning head restraints reduces their effectiveness and increases the likelihood of serious injury in a crash.

Make sure head restraints are in place and positioned properly before driving.

■ **Adjusting the front and second row outer and third row outer head restraint positions**

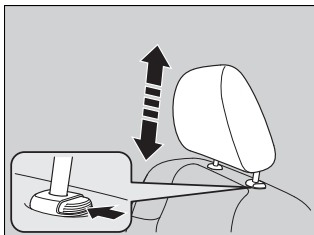

To raise the head restraint: Pull it upward.

To lower the head restraint: Push it down while pressing the release button.

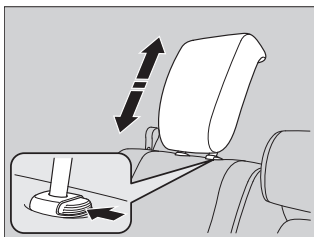

Changing the Second Row*/Third Row Center Seat Head Restraint Positions

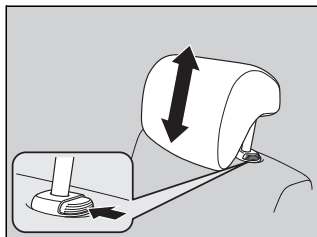

A passenger sitting in the second row/third row center seating position should adjust the height of their head restraint to an appropriate position before the vehicle begins moving.

To raise the head restraint:

Pull it upward.

To lower the head restraint:

Push it down while pressing the release button.

Removing and Reinstalling the Head Restraints

Head restraints can be removed for cleaning or repair.

To remove a head restraint:

Pull the restraint up as far as it will go. Then push the release button, and pull the restraint up and out.

To reinstall a head restraint:

Insert the legs back in place, then adjust the head restraint to an appropriate height while pressing the release button. Pull up on the restraint to make sure it is locked in position.

Removing and Reinstalling the Head Restraints

⚠ WARNING

Failure to reinstall, or correctly reinstall, the head restraints can result in severe injury during a crash.

Always replace the head restraints before driving.

To remove the third row seat outer head restraints, fold down the seat-back first.

► **Adjusting the passenger's manual seats**

P. 154

Maintain a Proper Sitting Position

After all occupants have adjusted their seats and head restraints, and put on their seat belts, it is very important that they continue to sit upright, well back in their seats, with their feet on the floor, until the vehicle is safely parked and the engine is off.

Sitting improperly can increase the chance of injury during a crash. For example, if an occupant slouches, lies down, turns sideways, sits forward, leans forward or sideways, or puts one or both feet up, the chance of injury during a crash is greatly increased.

In addition, an occupant who is out of position in the front seat can be seriously or fatally injured in a crash by striking interior parts of the vehicle or being struck by an inflating front airbag.

ⓘ Maintain a Proper Sitting Position

⚠ WARNING

Sitting improperly or out of position can result in serious injury or death in a crash.

Always sit upright, well back in the seat, with your feet on the floor.

Active Head Restraints

The driver's and front passenger's seats have active head restraints. In a rear impact, an occupant properly secured by a seat belt will be pushed against the seat-back and the head restraint will move forward. This reduces the distance between the restraint and the occupant's head, which helps reduce the likelihood of whiplash and injuries to the neck and upper spine.

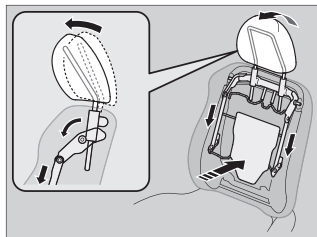

Active Head Restraints

In order for the active head restraints to operate properly:

- Do not hang any items on the head restraints, or from the restraint legs.
- Do not place any objects between an occupant and the seat-back.
- Install each restraint in its proper location.

After a collision, the activated restraint should return to its normal position. If the restraint does not return to its normal position, or in the event of a severe collision, have the vehicle inspected by a dealer.

Rear Seats

■ Third Row Seat Access

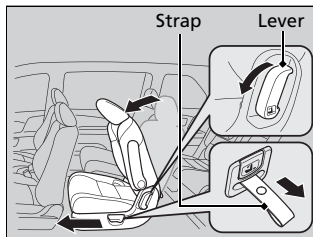

Pull up on the seat-back angle adjustment lever, or pulling the release strap tilts the second row outer seat's seat-back forward.

Slide the whole seat forward.

▶▶ Third Row Seat Access

When you enter the third row seat, be careful not to trip over the second row seat belt. If necessary, move the seat forward after tilting the seat-back forward.

Removing a Second Row Outer Seat

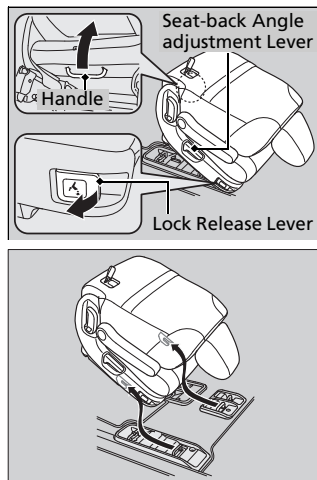

1. Lower the head restraint to its lowest position.
2. Move the seat to its rearmost position.
3. Fold the seat-back down.
4. Pull the lock release lever, and lift the rear of the seat.
 - To lift the seat, grab the handle under the rear side of the seat cushion.
5. Pull the seat-back slightly, then pivot it upward.
 - This unhooks the front of the seat from the floor.

Removing a Second Row Outer Seat

Do not remove the seat while driving.

To reinstall the seat, hook the front of the seat to the floor first. Pushing the rear of the seat-back locks the seat in place. Make sure the seat is latched before driving.

Sliding the Second Row Outer Seats Outward

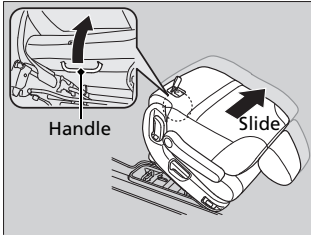
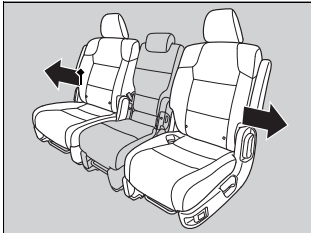

1. Lower the head restraint to its lowest position.
2. Move the seat to its rearmost position.
3. Fold the seat-back down.
4. Pull the lock release lever, and lift the rear of the seat.
 - ▶ To lift the seat, grab the handle under the rear side of the seat cushion.
5. With the front of the seat hooked to the floor, slide the seat laterally to the outer position until it stops.
6. Lower the seat and push the rear of the seat-back until it locks. Make sure the seat is latched before driving.

Sliding the Second Row Outer Seats Outward

When the second row outer seats are in the original (center) position, passengers have easier access to the third row seats. When they are in the outer position, you can install two or three child seats in the second row seats.

■ Removing the Second Row Center Seat*

Your vehicle's multi-functional second row center seat is removable.

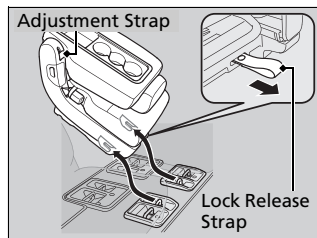

1. Store the center seat belt first. Insert a key into the slot on the side of the anchor buckle.
2. Retract the seat belt into the holder on the ceiling.
 - ▣ **Seat Belt with Detachable Anchor** P. 35
3. Pull up the adjustment strap, and fold down the seat-back.
4. Pull the lock release strap under the seat cushion, and lift the rear of the seat.
 - To lift the seat, hold the seat-back.
5. Pull the seat-back slightly, then pivot it upward.
 - This unhooks the front of the seat from the floor.

▣ Removing the Second Row Center Seat*

Do not remove the seat while driving.

The multi-functional center seat can be used as the beverage holder when folded down.

▣ **Beverage Holders** P. 173

To reinstall the seat, hook the front of the seat to the floor first. Pushing the rear of the seat-back locks the seat in place. Make sure the seat is latched before driving.

Tucking away the One-Motion Third row magic Seat®

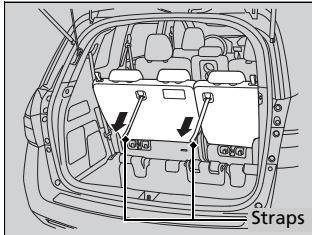

1. Store the center seat belt first. Insert a key into the slot on the side of the anchor buckle.
2. Retract the seat belt into the holder on the ceiling.
 - ▶ **Seat Belt with Detachable Anchor** P. 35
3. Lower the head restraints to their lowest position.
4. The right and left halves can be tucked away separately. Pull either strap to release the front leg lock of the third row seat.
5. Continue pulling the strap to tuck the seat and strap away into the cargo area.

▶▶ Tucking away the One-Motion Third row magic Seat®

Remove any items from the cargo area before you tuck away the third row seat.

The instruction label is attached at the back of the third row seat-back.

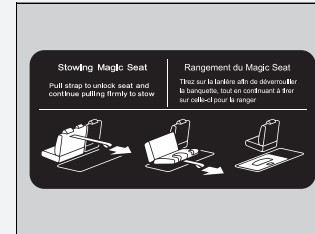

When you tuck away one side of the third row seats and use the non-recessed part of the cargo area, make sure to secure the cargo. Loose items can fly forward and cause injury if you have to brake hard.

■ **To return the seat to the upright position:**

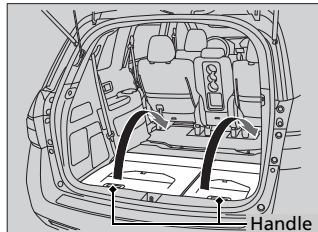

1. Grab the handle from outside.
Pull up the folded seat and pivot it forward.

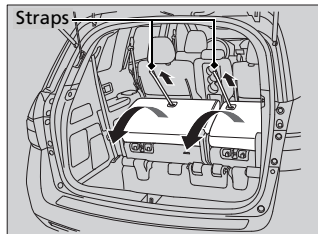

2. The front leg automatically latches.
Pull the strap to put the seat-back(s)
upright.

☒ **To return the seat to the upright position:**

Make sure the seat is latched before driving.

Armrest

■ Using the Front and Second Row Outer Seat Armrest

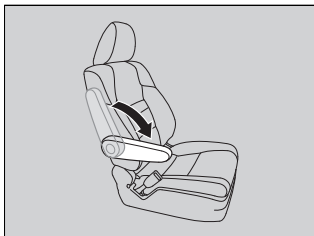

Pull down the armrest.

■ Front seat with adjustable armrest

Pivot down the armrest all the way, then pull it up to a desired angle.

■ Using the Second and Third Row Seat Armrest*

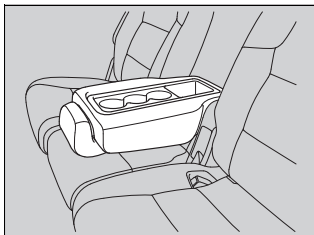

Pull down the armrest of the center seat-back.

* Not available on all models

Interior Lights

Interior Light Switches

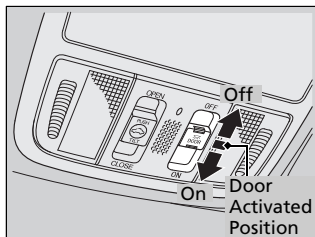

ON

The interior lights come on regardless of whether the doors or the tailgate are open or closed.

Door activated

The interior lights come on in the following situations:

Front:

- When any of the doors or the tailgate are opened.
- You unlock the driver's door.
- You remove the key from the ignition switch.

Cargo area:

When the tailgate is open.

OFF

The interior lights remain off regardless of whether the doors or the tailgate are open or closed.

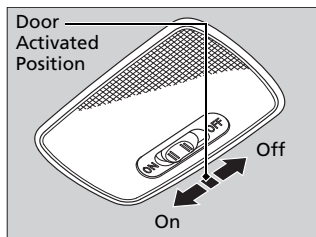

Interior Light Switches

In the door activated position, the interior lights fade out and go off about 30 seconds after the doors are closed.

The lights go off after 30 seconds in the following situations:

- When you unlock the driver's door but do not open it.
- When you remove the key from the ignition switch but do not open a door.

Models with multi-information display

You can change the interior light dimming time.

Customized Features P. 101

All models

The interior lights go off immediately in the following situations:

- When you lock the driver's door.
- When you close the driver's door with the key in the ignition switch.
- When you turn the ignition switch to ON **II**.

If you leave any of the doors open without the key in the ignition switch, the interior lights go off after about 15 minutes.

If you leave the tailgate open without the key in the ignition switch, the cargo area light goes off after about 30 minutes.

Map Lights

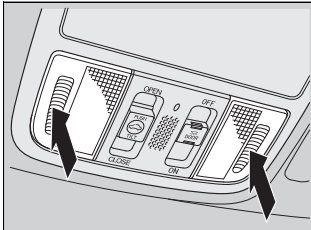

■ Front

The map lights can be turned on and off by pressing the lenses.

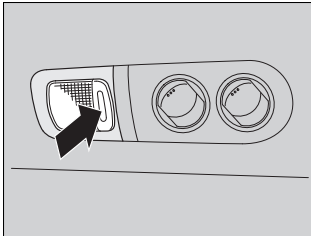

■ Second and third row

The map lights can be turned on and off by pressing the lenses when the front interior light switch is in the door activated position.

»» Map Lights

When the front interior light switch is in the door activated position and any door is open, the map light will not go off when you press the lens.

Interior Convenience Items

Glove Box

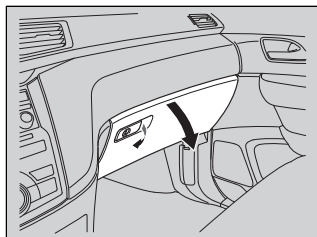

Pull the handle to open the glove box. You can lock the glove box with the master key.

Glove Box

⚠ WARNING

An open glove box can cause serious injury to your passenger in a crash, even if the passenger is wearing the seat belt.

Always keep the glove box closed while driving.

Removable Center Console*

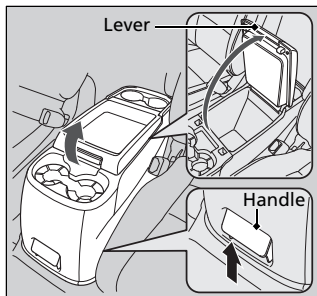

Pull up on the lever to open the console compartment.

■ Removing the center console

Pull up the handle on the front lower side and unlock the console from the floor. Raise it forward to remove.

Removable Center Console*

When you reinstall the center console, place the rear side on the floor first, and align the marks on the sides with the marks on the floor. Push the center console down and lock it. Make sure it is securely latched before driving.

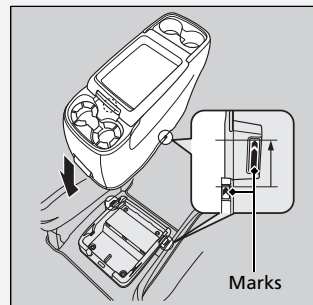

■ Flip-up Trash Bag Ring*

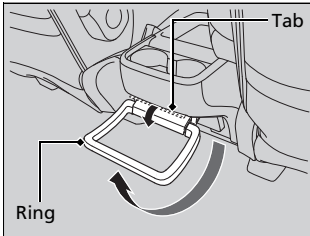

Pull up the ring until it clicks, and lift the tab. Put a plastic bag in the ring. Push the tab down to hold the bag.

▣ Flip-up Trash Bag Ring*

The ring is designed to hold light items only. Store the ring when it is not in use.

* Not available on all models

Continued

■ Center Pocket

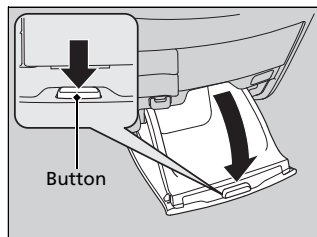

Press the button to open the center pocket.

■ Using the center pocket as a cool box*

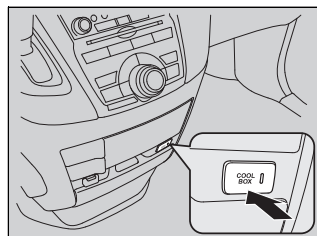

While the air conditioner is in use, you can store items in the center pocket to keep them cool.

Press the COOL BOX button to cool inside the center pocket (indicator on).

☒ Using the center pocket as a cool box*

NOTICE

Do not put opened cans, or uncovered containers with loose ice inside the cool box. Spilled liquids can damage the upholstery and electrical components in and around the cool box.

The cool box is not a refrigerator. It only keeps chilled beverages cool.

The climate control system continues to cool the cool box when the heater is turned on.

Pressing the COOL BOX button automatically turns on the air conditioning system.

The cool box automatically turns off if:

- The air conditioning system is turned off
- You turn the ignition switch to LOCK [0]

■ Beverage Holders

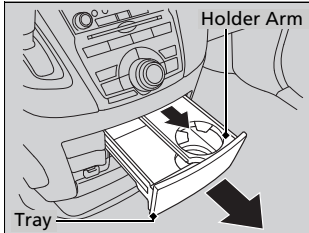

■ **Front panel beverage holder**
Pull the beverage holder arm inside the front panel tray until the arm contacts the tray front.

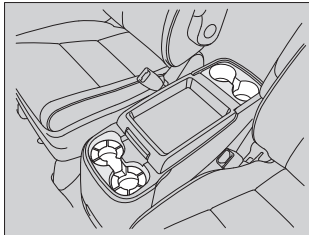

■ **Removable center console beverage holders***

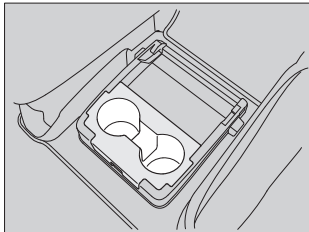

■ **Front seat beverage holders***

* Not available on all models

Continued

» Beverage Holders

NOTICE

Spilled liquids can damage the upholstery, carpeting, and electrical components in the interior.

Be careful when you are using the beverage holders. Hot liquid can scald you.

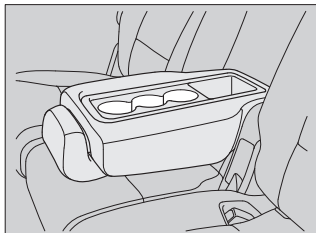

■ **Second row seat beverage holders***

To use the beverage holder, fold the seat-back.

- **Using the Second and Third Row Seat Armrest*** P. 167

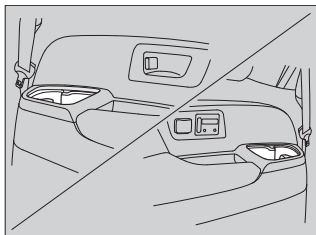

■ **Third row seat beverage holders**

■ Accessory Power Sockets

The accessory power sockets can be used when the ignition switch is in ACCESSORY **I** or ON **II**.

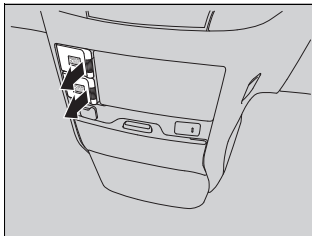

■ Accessory power socket(s) (console panel)

Open the cover to use it.

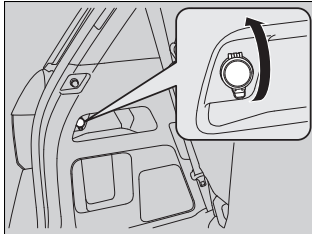

■ Accessory power socket (cargo area)

Open the cover to use it.

»» Accessory Power Sockets

NOTICE

Do not insert an automotive type cigarette lighter element. This can overheat the power socket.

The accessory power socket is designed to supply power for 12 volt DC accessories that are rated 120 watts or less (10 amps).

To prevent battery drain, only use the power socket with the engine run.

When each socket is being used simultaneously, the combined power rating of the accessories should not exceed 120 watts (10 amps).

■ AC Power Outlet*

The AC power outlet can be used when the engine is running.

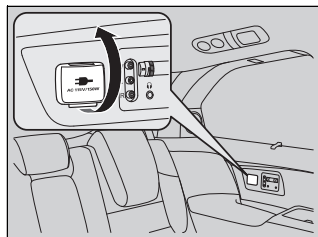

Open the cover to use it. Plug in the appliance slightly, turn it 90° clockwise, then push it all the way.

▣ AC Power Outlet*

NOTICE

Do not use the AC power outlet for electric appliances that require high initial peak wattage, such as cathode-ray tube type televisions, refrigerators, electric pumps, etc. It is not suitable for devices that process precise data, such as medical equipment, and that require an extremely stable power supply, such as microcomputer-controlled electric blankets, touch sensor lamps, etc.

The AC power outlet is designed to supply power for up to 115 volt appliances that are rated 150 watts or less.

Coat Hooks

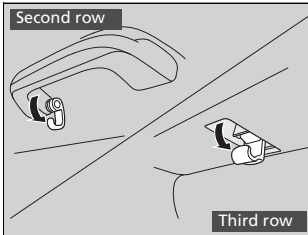

There are coat hooks on the both side of the grab handle and the window frame. Pull it down to use it.

Cargo Hooks

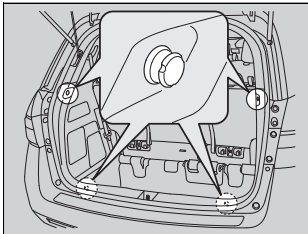

Use the floor cargo hooks to secure luggage in the cargo area.

Coat Hooks

The coat hooks are not designed for large or heavy items.

■ Grocery Bag Hooks

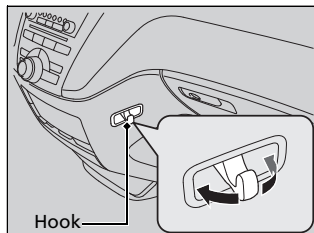

■ Front

Pull out the hook on the instrument panel from the side.

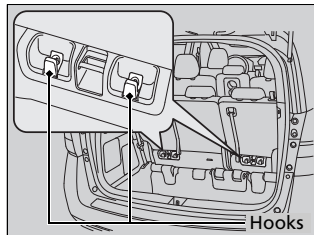

■ Rear

☒ Grocery Bag Hooks

The hooks are designed to hold light items. Heavy objects may damage the hook.

■ Sunglasses Holder

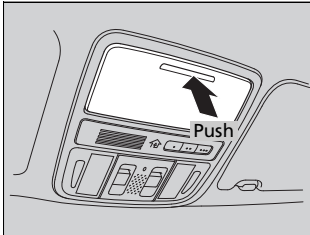

To open the sunglasses holder, push and release the indent. To close, push it again until it latches.

You can store eyeglasses and other small items in this holder.

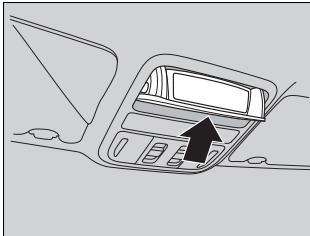

■ Conversation mirror*

The sunglasses holder comes with a mirror. Open the sunglasses holder fully, then push it back to the first detent. You can use the mirror to view the rear seats.

* Not available on all models

Continued

»Sunglasses Holder

Keep the holder closed while driving except when accessing stored items.

Seat Heaters*

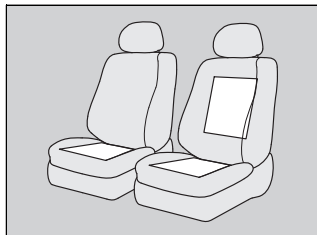

The ignition switch must be in ON **II** to use the seat heaters. The **HI** setting heats the seats faster than the **LO** setting.

There is no heater in the passenger's seat-back due to the side airbag cutoff system.

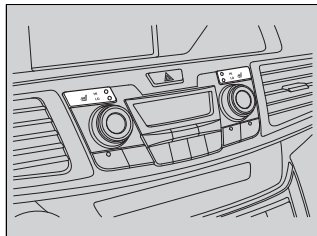

The appropriate indicator will be on while the seat heater is on. Each time you press the switch, the mode changes to **HI**, **LOW** and **OFF**.

Seat Heaters*

⚠ WARNING

Heat induced burns are possible when using seat heaters.

Persons with a diminished ability to sense temperature (e.g., persons with diabetes, lower-limb nerve damage, or paralysis) or with sensitive skin should not use seat heaters.

Do not use the seat heaters even in **LO** when the engine is off. Under such conditions, the battery may be weakened, making the engine difficult to start.

■ Integrated Sunshades*

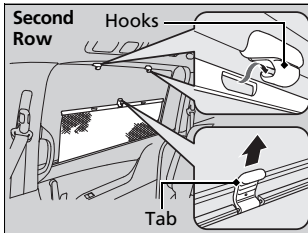

■ Second row sunshades

Pull the tab and roll up the sunshade all the way. Use the hooks to hang it.

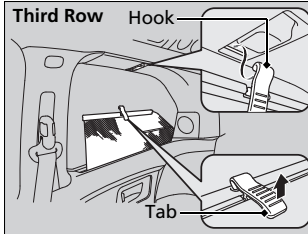

■ Third row sunshades

Pull the tab and roll up the sunshade all the way. Attach the tab to the hook.

»» Integrated Sunshades*

Use the sunshades only when the windows are fully closed. Using the shade while a window is open can unhook and blow off the shade, hitting and hurting anyone sitting near the window.

* Not available on all models

Using Vents, Heating and A/C

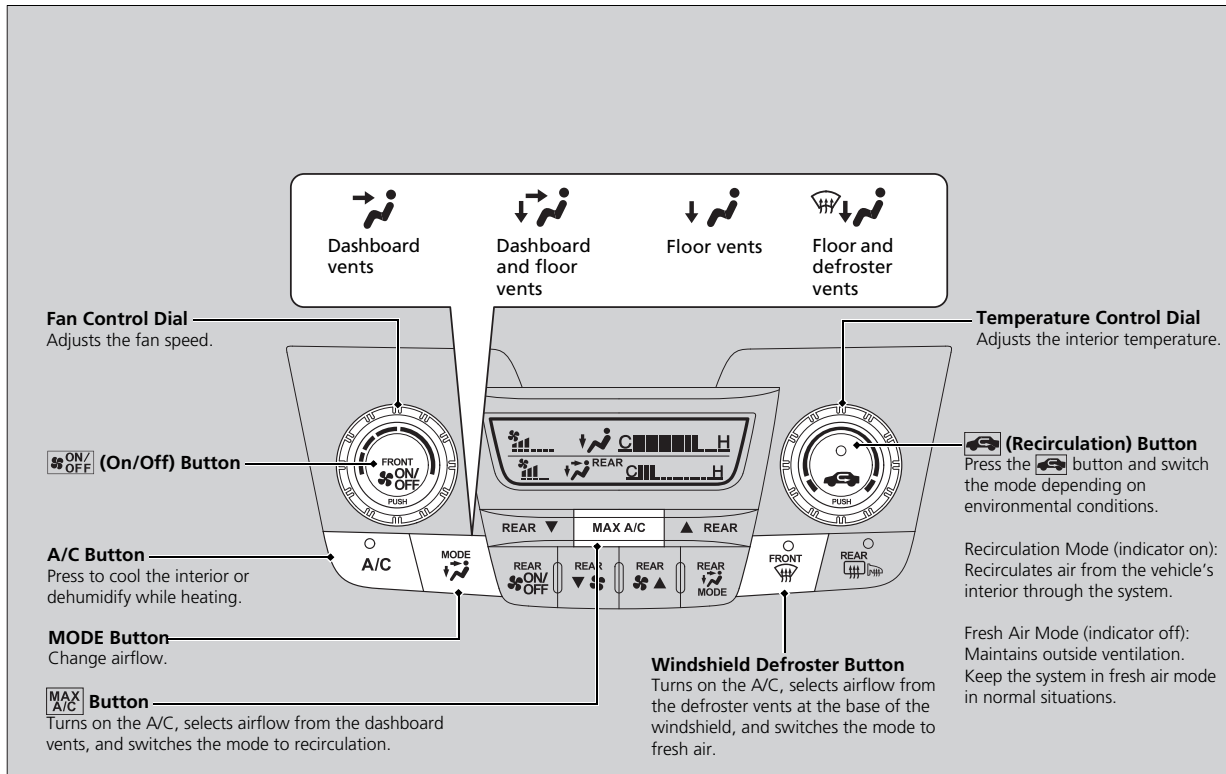

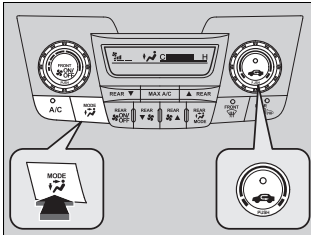

Heating



The heater uses heat from the engine coolant to warm the air.

1. Adjust the fan speed using the fan control dial.
2. Press the mode button to select .
3. Adjust the temperature using the temperature control dial.

■ To rapidly warm up the interior

1. Set the fan to the maximum speed.
2. Select .
3. Set the temperature to maximum heat.
4. Press the  button (indicator on).

■ To dehumidify the interior

When used in combination with the heater, the air conditioning system makes the interior warm and dry and can prevent the windows from fogging up.

1. Adjust the fan speed using the fan control dial.
2. Press the **A/C** button to turn on the air conditioning.
3. Select .
4. Adjust the temperature using the temperature control dial.

►► Heating

When you select , the mode automatically switches to fresh air.

►► To rapidly warm up the interior

Change to fresh air mode as soon as the interior gets warm enough. The windows may fog up if kept in recirculation mode.

Cooling

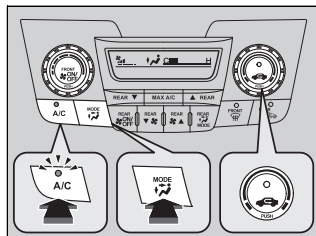



1. Adjust the fan speed using the fan control dial.
2. Press the mode button to select .
3. Adjust the temperature using the temperature control dial.
4. Press the **A/C** button (indicator on).

■ To rapidly cool down the interior

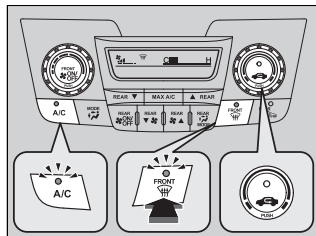

1. Set the fan to the maximum speed.
2. Set the temperature to maximum cool.
3. Press the  button (indicator on).

Defrosting the Windshield and Windows



Pressing the  button turns the air conditioning system on and automatically switches the system to fresh air mode.

■ To rapidly defrost the windows

1. Set the fan to the maximum speed.
2. Press the  button.
3. Press the  button.
4. Set the temperature to maximum heat.

☒ To rapidly cool down the interior

If the interior is very warm, you can cool it down more rapidly by partially opening the windows.

☒ Defrosting the Windshield and Windows

For your safety, make sure you have a clear view through all the windows before driving.

Do not set the temperature near the upper or lower limit.

When cold air hits the windshield, the outside of the windshield may fog up.

If the side windows fog up, adjust the vents so that the air hits the side windows.

☒ To rapidly defrost the windows

After defrosting the windows, switch over to fresh air mode.

If you keep the system in recirculation mode, the windows may fog up from humidity. This impedes visibility.

Rear A/C Controls

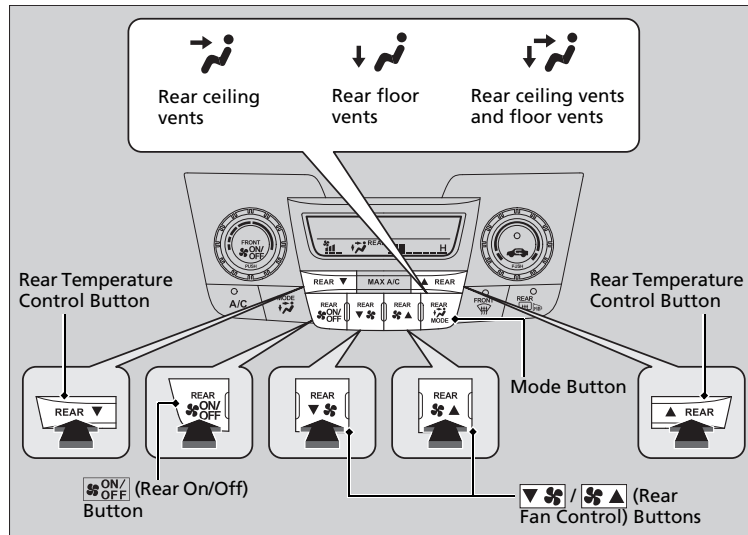

Use the system when the engine is running.

1. Press the **ON/OFF** button.
2. Adjust the temperature and the fan speed using the appropriate buttons. Select the air flow to the rear passenger compartment using the mode button.
3. To turn off the rear A/C, press the **ON/OFF** button again.

Using Automatic Climate Control

The automatic climate control system maintains the interior temperature you select. The system also selects the proper mix of heated or cooled air that raises or lowers the interior temperature to your preference as quickly as possible.

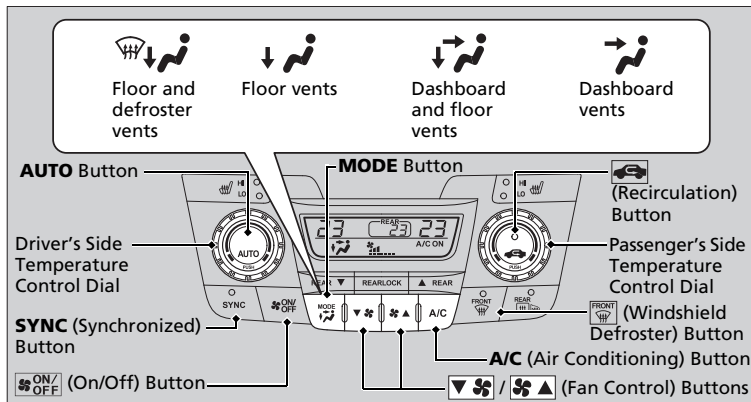

Use the system when the engine is running.

1. Press the **AUTO** button.
2. Adjust the interior temperature using the temperature control dial.
3. Press the **ON/OFF** button to cancel.

Switching between the recirculation and fresh air modes

Press the  button and switch the mode depending on environmental conditions. Recirculation Mode (indicator on): Recirculates air from the vehicle's interior through the system.

Fresh Air Mode (indicator off): Maintains outside ventilation. Keep the system in fresh air mode in normal situations.

Using Automatic Climate Control

If any buttons are pressed while using the climate control system in auto, the function of the button that was pressed will take priority. The **AUTO** indicator will go off, but functions unrelated to the button that was pressed will be controlled automatically.

The compressor may turn on to prevent window fogging, even if the display reads **A/C OFF**.

To prevent cold air from blowing in from outside, the fan may not start immediately when the **AUTO** button is pressed.

Once you have set the desired temperature, do not use the temperature control dials more than necessary.

Doing so may delay the time it takes to reach the set temperature.

If the interior is very warm, you can cool it down more rapidly by partially opening the windows, turning the system on auto, and setting the temperature to low. Change the fresh air mode to recirculation mode until the temperature cools down.

When you set the temperature to the lower or upper limit, **Lo** or **Hi** is displayed.

Pressing the **ON/OFF** button switches the climate control system between on and off. When turned on, the system returns to your last selection.

■ Defrosting the Windshield and Windows

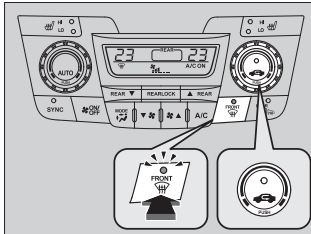

Pressing the **FRONT WIP** button turns the air conditioner system on and automatically switches the system to fresh air mode.

■ To rapidly defrost the windows

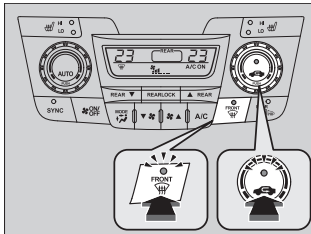

1. Press the **FRONT WIP** button.
2. Press the **FRONT WIP** button.

►► Defrosting the Windshield and Windows

For your safety, make sure you have a clear view through all the windows before driving.

Do not set the temperature near the upper or lower limit.

When cold air hits the windshield, the outside of the windshield may fog up.

If the side windows fog up, adjust the vents so that the air hits the side windows.

►► To rapidly defrost the windows

After defrosting the windows, switch over to fresh air mode.

If you keep the system in recirculation mode, the windows may fog up from humidity. This impedes visibility.

Synchronized Mode

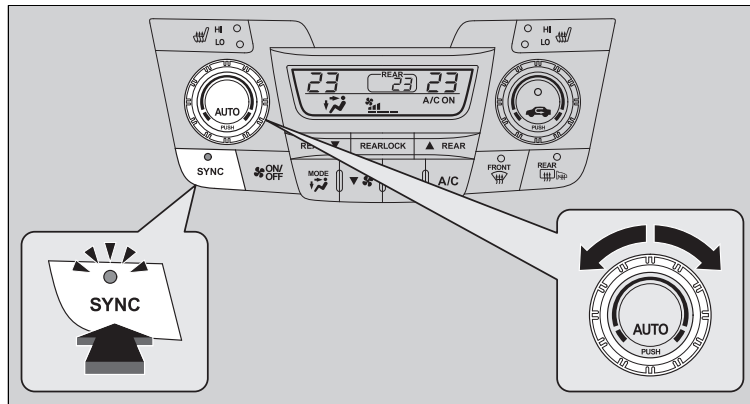

You can set the temperature synchronously for the driver side, the passenger side and the rear passenger compartment in synchronized mode.

1. Press the **SYNC** button.
 - The system will switch to synchronized mode.
2. Adjust the temperature using driver's side temperature control dial.

Press the **SYNC** button to return to dual mode.

☒ Synchronized Mode

When the system is in dual mode, the driver side temperature, the passenger side temperature and the rear passenger compartment (if it is on) can be set separately.

Rear Climate Control System

■ Using the Rear Climate Control System From the Front Panel

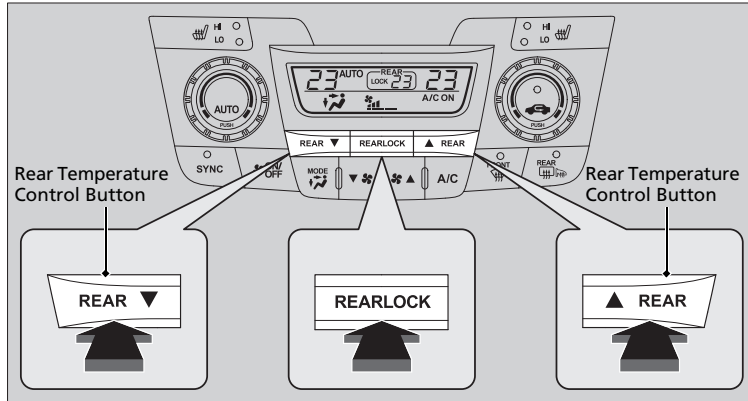

Use the system when the engine is running.

1. Press the **REARLOCK** button.
 - **LOCK** appears on the front control panel. The rear system changes to **AUTO** mode.
2. The system automatically adjusts the fan speed and airflow levels to maintain the set rear temperature.
 - Change the temperature if necessary.
3. To turn off the rear climate control system, press and hold the **REARLOCK** button for a few seconds.

►► Rear Climate Control System

AUTO LOCK appears on the rear control panel while the rear lock is on.

If the rear lock is on while in SYNC mode, the rear control panel is disabled. **AUTO LOCK SYNC** appears on the rear control panel.

■ Using the Rear Climate Control System From the Rear Panel

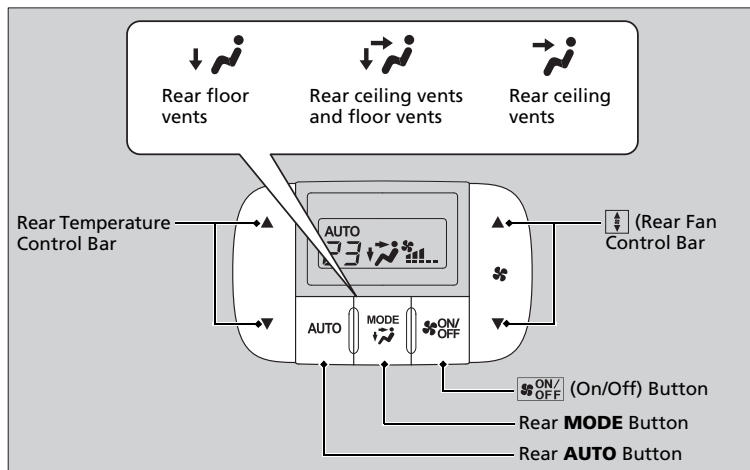

Use the system when the engine is running.

1. Press the **AUTO** button.
2. Adjust the interior temperature using the rear temperature control bar.
3. To turn off the rear climate control system, press  button.

▣ Using the Rear Climate Control System From the Rear Panel

When the **REARLOCK** button on the front control panel is off, the temperature of the rear passenger compartment can be controlled independently.

Automatic Climate Control Sensors

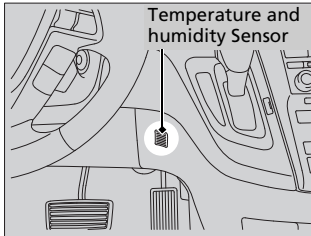
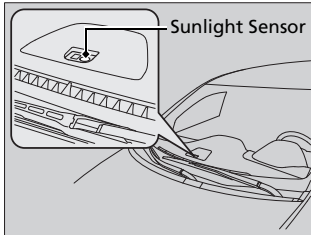

The automatic climate control system is equipped with a sunlight sensor, an interior temperature and humidity sensor. Do not cover or spill any liquid on them.

Features

This chapter describes how to operate technology features.

Audio System

About Your Audio System.....	194
USB Adapter Cable	195
Auxiliary Input Jack	195
Audio System Theft Protection	196
Audio System Basic Operation	197
Audio Remote Controls.....	198
Adjusting the Sound	199
Playing the AM/FM Radio.....	200
Playing the XM® Radio *	204
Playing a CD	207
Playing CD Library	211
Playing an iPod®.....	217

Playing a USB Flash Drive	221
Playing <i>Bluetooth</i> ® Audio.....	225
Audio Error Messages	
CD Player.....	230
iPod®/USB Flash Drive.....	231

General Information on the Audio System

XM® Radio Service *	232
Recommended CDs	233
Compatible iPod® and USB Flash Drives ...	235
Rear Entertainment System *	236
HomeLink® Universal Transceiver * ..	252

Bluetooth® HandsFreeLink®

Using HFL	254
HFL Menus	256
Compass *	277

* Not available on all models

About Your Audio System

On models with navigation system, see the Navigation System Manual for operation of the audio system, *Bluetooth*® HandsFreeLink®, and voice commands for these features.

The audio system features AM/FM radio and the XM® Radio Service*. It can also play audio CDs, WMA/MP3/AAC files, iPod®, USB flash drives*, and *Bluetooth*®* devices.

You can operate the audio system from the buttons and switches on the panel, or the remote controls on the steering wheel*.

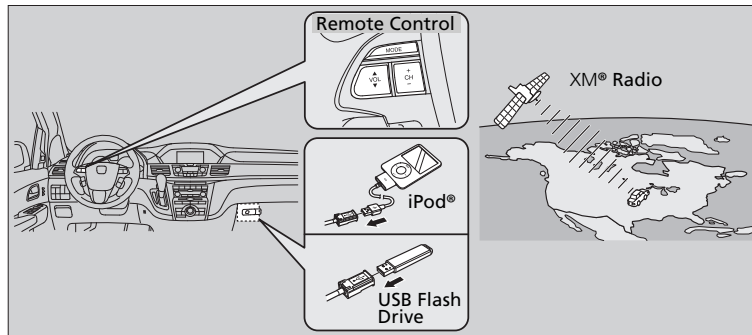

▣ About Your Audio System

XM® Radio is available on a subscription basis only. For more information on XM® Radio, contact a dealer.

➤ General Information on the Audio System P. 232

XM® Radio is available in the United States and Canada, except Hawaii, Alaska, and Puerto Rico.

XM® Radio is a registered trademark of Sirius XM Radio, Inc.

Video CDs, DVDs, and 3-inch (8-cm) mini CDs are not supported.

iPod® is a registered trademark owned by Apple Inc.

State or local laws may prohibit the operation of handheld electronic devices while operating a vehicle.

USB Adapter Cable

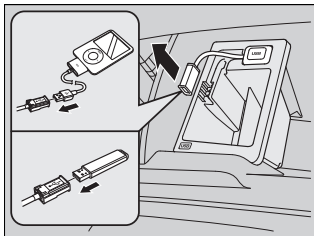

1. Unclip the USB connector and loosen the adapter cable.
2. Install the iPod® dock connector or the USB flash drive to the USB connector.

Auxiliary Input Jack

Use the jack to connect standard audio devices.

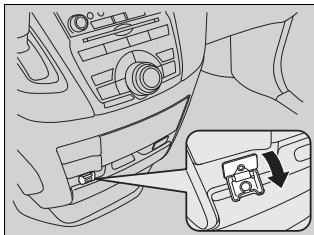

1. Open the AUX cover.
2. Connect a standard audio device to the input jack using a 1/8 inch (3.5 mm) stereo miniplug.
 - ▶ The audio system automatically switches to the AUX mode.

⌘ USB Adapter Cable

- Do not leave the iPod® or USB flash drive in the vehicle. Direct sunlight and high temperatures may damage it.
- Do not use an extension cable with the USB adapter cable.
- Do not connect the iPod® or USB flash drive using a hub.
- Do not use a device such as a card reader or hard disk drive, as the device or your files may be damaged.
- We recommend backing up your data before using the device in your vehicle.
- Displayed messages may vary depending on the device model and software version.

If the audio system does not recognize the iPod®, try reconnecting it a few times or reboot the device. To reboot, follow the manufacturer's instructions provided with the iPod® or visit www.apple.com/ipod.

⌘ Auxiliary Input Jack

To switch the mode, press any of the audio mode buttons. You can return to the AUX mode by pressing the **AUX** button.

You cannot use the auxiliary input jack if you replace the audio system.

Audio System Theft Protection

The audio system is disabled when it is disconnected from the power source, such as when the battery is disconnected or goes dead.

■ Reactivating the audio system

1. Turn the ignition switch to ON **[II]**, and turn on the audio system.
 - ▶ If you turn the ignition switch to ACCESSORY **[I]**, you will be requested to enter the audio security code. See step 3.
2. Press and hold the power volume knob again for more than two seconds.
 - ▶ The audio system is reactivated when the system's control unit recognizes that the system is in your vehicle.
If the control unit fails to recognize, **ENTER CODE** appears on the audio/information screen.
3. Enter the audio security code using the preset buttons. If you enter an incorrect digit, continue to the last digit, then try again. If you do not enter the code correctly after 10 tries, leave the system for one hour before trying again, or visit a dealer to have the system reset.

▶▶ Audio System Theft Protection

You can find out about your serial number and security code from a dealer.

U.S. models

You can register the security code at Owner Link (owners.honda.com), and find information on how to retrieve the serial number and obtain the code at radio-navicode.honda.com.

To use the audio system function, the ignition switch must be in ACCESSORY **I** or ON **II**.

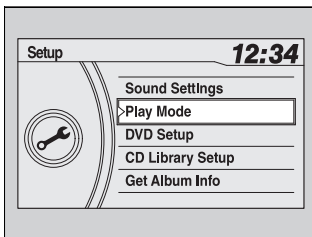
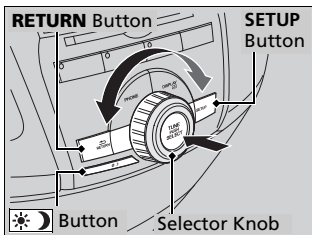

Use the selector knob or **SETUP** button to access some audio functions.

Press to switch between the normal and extended display for some functions.

Selector knob: Rotate left or right to scroll through the available choices. Press to set your selection.

SETUP button: Press to select any mode such as the Auto Select, Sound Settings, Play Mode, Resume/Pause, or compass.

RETURN button: Press to go back to the previous display.

button: Press to change the audio/information screen brightness. The brightness can be set differently for the day time and night time. Press once for the day time mode. Press twice for the night time mode. Adjust the brightness using .

Audio System Basic Operation

These indications are used to show how to operate the selector knob.

Rotate to select.

Press to enter.

Audio Remote Controls

Allows you to operate the audio system while driving.

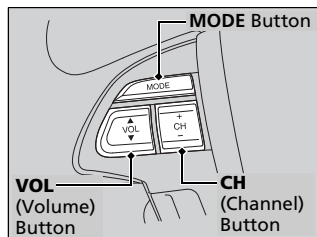

MODE Button

Cycles through the audio modes as follows:

FM1→**FM2**→**AM**→**XM1***→**XM2***→**CD**→**CD**









-L→**AUX**

VOL Button

Press : Increases the volume.

Press : Decreases the volume.

CH Button

- When listening to the radio
 - Press : Selects the next preset radio station.
 - Press : Selects the previous preset radio station.
 - Press and hold : Selects the next strong station.
 - Press and hold : Selects the previous strong station.
- When listening to a CD, CD Library, iPod® or USB flash drive.
 - Press : Skips to the next song.
 - Press : Goes back to the beginning of the current or previous song.
- When listening to a CD or CD Library.
 - Press and hold : Skips to the next folder/album.
 - Press and hold : Goes back to the previous folder/album.

Audio Remote Controls



The CD mode appears only when a CD is loaded.

When in the AUX mode, the following are operable from the remote controls:

- iPod®/USB flash drive connected to the USB adapter cable
- Bluetooth® Audio (with some phones only)

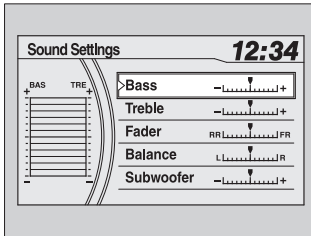
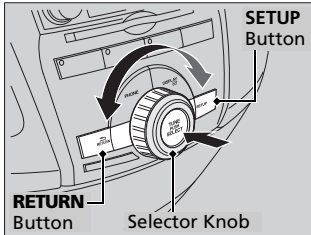
Adjusting the Sound



Press the **SETUP** button, and rotate  to adjust the setting. Rotate  to scroll through the following choices:

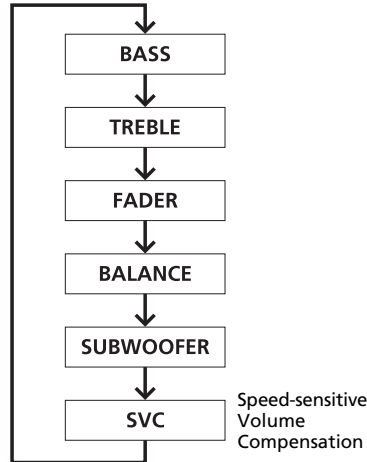

Speed-sensitive
Volume
Compensation

▶▶ Adjusting the Sound

The SVC has four modes: OFF, LOW, MID, and HIGH. SVC adjusts the volume level based on the vehicle speed. As you go faster, audio volume increases. As you slow down, audio volume decreases.

Playing the AM/FM Radio

Models without rear entertainment system

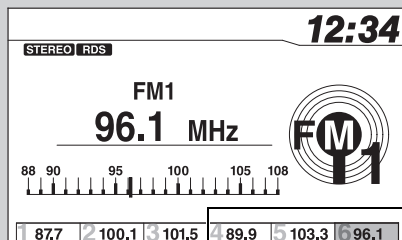

AM/FM Button
Press to select a band.

TITLE Button
Press to switch the RDS name on and off.

SCAN Button
Press to sample each of the strongest stations on the selected band for 10 seconds. To turn off scan, press the button again.

SKIP Bar
Press and hold to search up and down the selected band for a station with a strong signal.

RETURN Button
Press to go back to the previous display.

VOL/  (Power/volume) Knob
Press to turn the audio system ON and OFF.
Turn to adjust the volume.

Preset Buttons (1-6)
To store a station:
1. Tune to the selected station.
2. Pick a preset button and hold it until you hear a beep.

To listen to a stored station, select a band, then press the preset button.

CATEGORY Bar (FOLDER Bar)
Press either side to display and select an RDS category.

SETUP Button
Press to display menu items.

Selector Knob
Press and turn to tune the radio frequency.

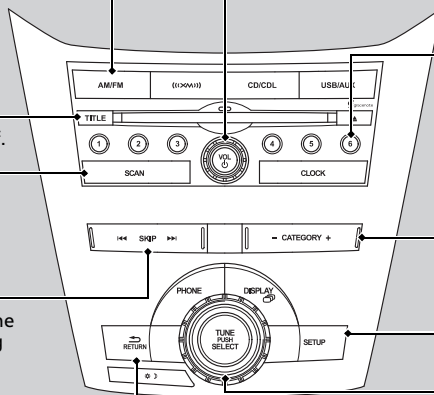

Models with rear entertainment system

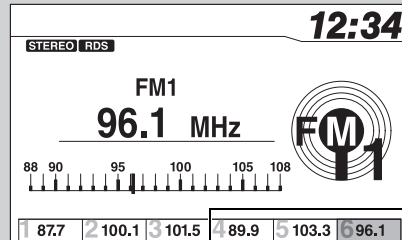

AM/FM Button
Press to select a band.

TITLE Button
Press to switch the RDS name on and off.

SKIP Bar
Press and hold to search up and down the selected band for a station with a strong signal.

SCAN Button
Press to sample each of the strongest stations on the selected band for 10 seconds. To turn off scan, press the button again.

RETURN Button
Press to go back to the previous display.

VOL/ (Power/volume) Knob
Press to turn the audio system ON and OFF.
Turn to adjust the volume.

Preset Buttons (1-6)

- To store a station:
1. Tune to the selected station.
 2. Pick a preset button and hold it until you hear a beep.

To listen to a stored station, select a band, then press the preset button.

CATEGORY Bar (FOLDER Bar)

Press either side to display and select an RDS category.

SETUP Button

Press to display menu items.

Selector Knob

Press and turn to tune the radio frequency.

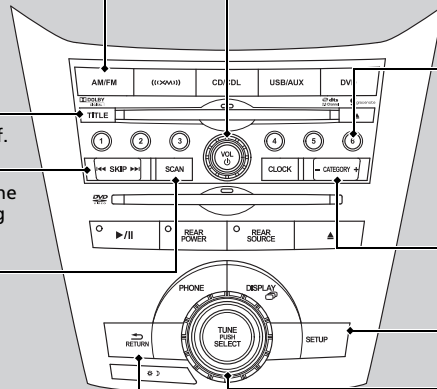

Auto Select

Use the auto select feature to scan both bands and store the strongest station in each preset.

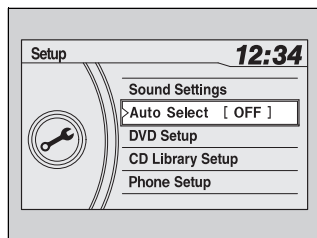

1. Press the **SETUP** button.
2. Rotate to select **Auto Select**, then press .
3. Select **PUSH TO START** or **ON**, then press .

To turn off auto select, press again. This restores the presets you originally set.

▶▶ Playing the AM/FM Radio

The ST indicator appears on the display indicating stereo FM broadcasts. Stereo reproduction in AM is not available.

Switching the Audio Mode

Press the **MODE** button on the steering wheel.

Audio Remote Controls P. 198

You can store six AM stations and twelve FM stations into the preset button memory. FM1 and FM2 let you store six stations each.

Auto Select function scans and stores up to six AM stations and twelve FM stations with a strong signal into the preset button memory.

If you do not like the stations auto select has stored, you can manually store your preferred frequencies.

Radio Data System (RDS)

Provides text data information related to your selected RDS capable FM station.

■ RDS INFO ON

Press the **TITLE** button while listening to an RDS capable station. **RDS INFO ON** appears, and the station name is displayed.

■ To find an RDS station from your selected program category

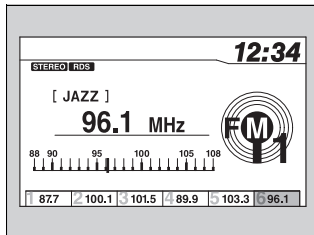

1. Press the **FOLDER** bar or the **CATEGORY** bar to display and select an RDS category.
2. Use **SKIP** or **SCAN** to select an RDS station.

▶▶ Playing the AM/FM Radio

The ST indicator appears on the display indicating stereo FM broadcasts.

Stereo reproduction in AM is not available.

Switching the Audio Mode

Press the **MODE** button on the steering wheel.

▶▶ **Audio Remote Controls** P. 198

You can store six AM stations and twelve FM stations into the preset button memory. FM1 and FM2 let you store six stations each.

A.SEL function scans and stores up to six AM stations and twelve FM stations with a strong signal into the preset button memory.

If you do not like the stations auto select has stored, you can manually store your preferred frequencies.

Playing the XM® Radio *

Models without rear entertainment system

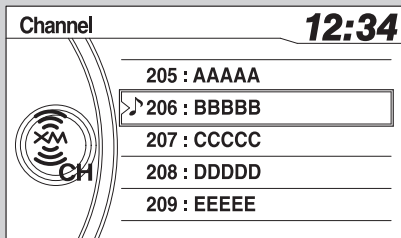

[[XM]] (XM®) Button

Press to select XM® radio.

TITLE Button

Press and release to cycle the display between the name, title, and category.

SCAN Button

Press to sample all channels (in the channel mode), or channels within a category (in the category mode). Each sampling continues for a few seconds. Press SCAN again to cancel scanning and continue listening to the channel.

SKIP Bar

Press to skip to the previous or next channel.

RETURN Button

Press to go back to the previous display.

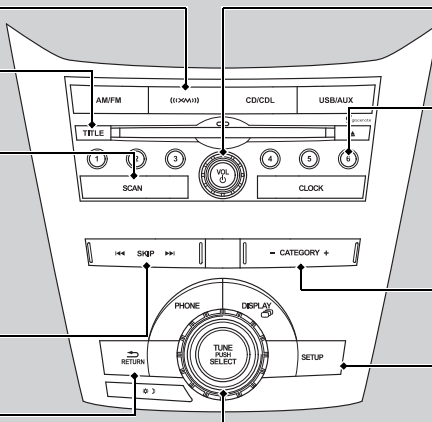

VOL/ [Power] (Power/volume) Knob

Press to turn the audio system ON and OFF.

Turn to adjust the volume.

Preset Buttons (1-6)

To store a channel:

1. Select the channel.
2. Pick a preset button and hold it until you hear a beep.

To listen to a stored channel, select XM, then press the preset button.

CATEGORY Bar

Press either side to display and select an XM® Radio category.

SETUP Button

Press to display menu items.

Selector Knob

Turn to select channel.

Models with rear entertainment system

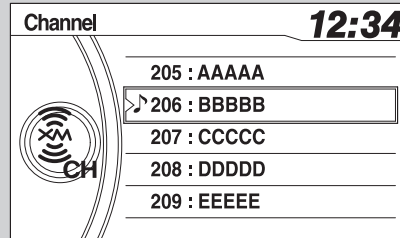

XM® Button

Press to select XM® radio.

TITLE Button

Press and release to cycle the display between the name, title, and category.

SCAN Button

Press to sample all channels (in the channel mode), or channels within a category (in the category mode).

Each sampling continues for a few seconds. Press SCAN again to cancel scanning and continue listening to the channel.

SKIP Bar

Press to skip to the previous or next channel.

RETURN Button

Press to go back to the previous display.

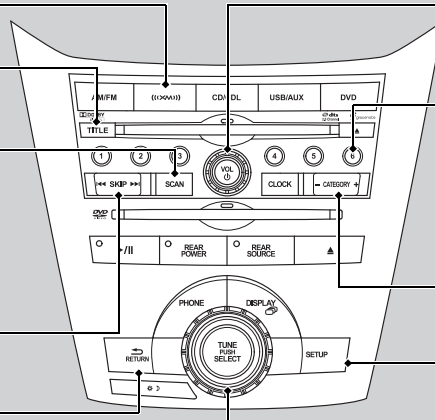

VOL/ (Power/volume) Knob

Press to turn the audio system ON and OFF.

Turn to adjust the volume.

Preset Buttons (1-6)

To store a channel:

1. Select the channel.
2. Pick a preset button and hold it until you hear a beep.

To listen to a stored channel, select XM, then press the preset button.

CATEGORY Bar

Press either side to display and select an XM® Radio category.





SETUP Button

Press to display menu items.

Selector Knob



Turn to select channel.

■ To Play the XM® Radio

1. Press the  button to select the XM® radio band (XM1 or XM2).
2. Press and hold the **TITLE** button to switch between the channel mode and category mode.
If you press the **SETUP** button, rotate  to select **XM Mode**, and press . You can select channel mode or category mode by turning and pressing the selector knob.
3. Select a channel using the **TUNE** () , **SKIP**, **CATEGORY**, **SCAN**, or preset buttons.

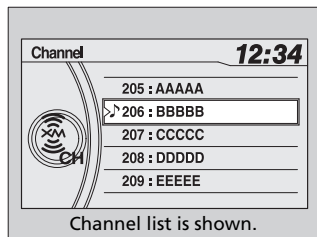
■ To Select a Channel from a List



1. Press  to display a channel list.
2. Rotate  to select a channel, then press .

▶▶ Playing the XM® Radio *

In the channel mode, all available channels are selectable. In the category mode, you can select a channel within a category (Jazz, Rock, Classical, etc.).

You can store twelve XM® stations in the preset buttons. XM1 and XM2 let you store six stations each.

There may be instances when XM® Radio does not broadcast all the data fields (artist name, title). This does not indicate a problem with your audio system.

Playing a CD

Your audio system supports audio CDs, CD-Rs and CD-RWs in either MP3, WMA, or AAC format. With the CD loaded, press the CD button.

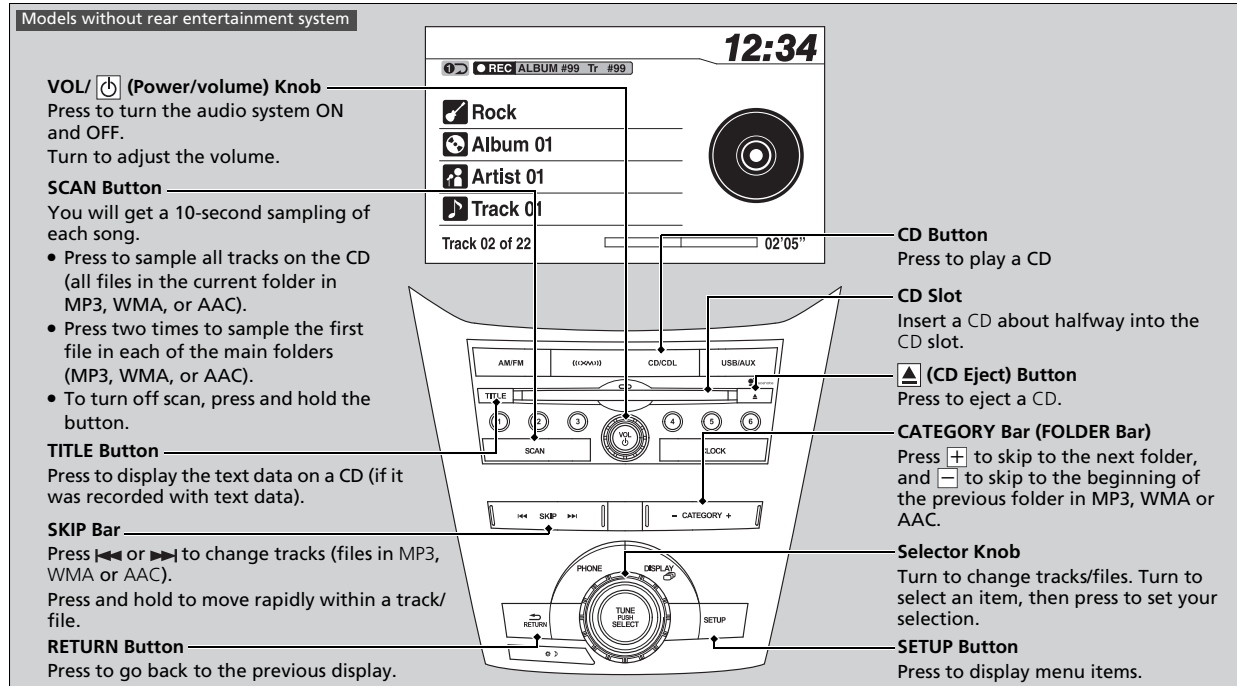

Models with rear entertainment system

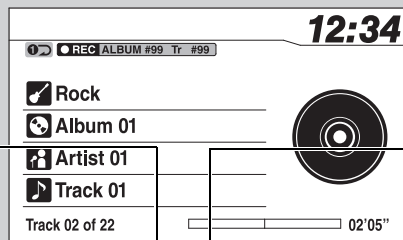

SCAN Button

You will get a 10-second sampling of each song.

- Press to sample all tracks on the CD (all files in the current folder in MP3, WMA, or AAC).
- Press two times to sample the first file in each of the main folders (MP3, WMA, or AAC).
- To turn off scan, press and hold the button.

TITLE Button

Press to display the text data on a CD (if it was recorded with text data).

SKIP Bar

Press **⏮** or **⏭** to change tracks (files in MP3, WMA or AAC).
Press and hold to move rapidly within a track/file.

RETURN Button

Press to go back to the previous display.

VOL/ (Power/volume) Knob

Press to turn the audio system ON and OFF.

Turn to adjust the volume.

CD Button

Press to play a CD

CD Slot

Insert a CD about halfway into the CD slot.

(CD Eject) Button

Press to eject a CD.

CATEGORY Bar

Press **+** to skip to the next folder, and **-** to skip to the beginning of the previous folder in MP3, WMA or AAC.

Selector Knob

Turn to change tracks/files. Turn to select an item, then press to set your selection.

SETUP Button

Press to display menu items.

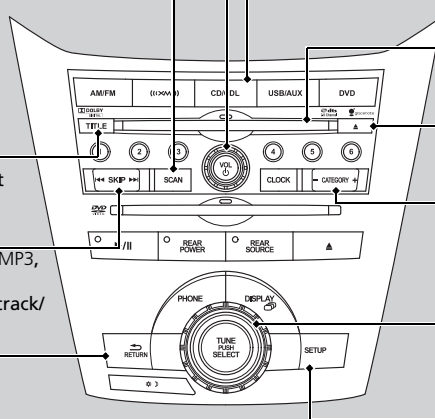

How to Select a File from a Folder with the Selector Knob (MP3/WMA/AAC)

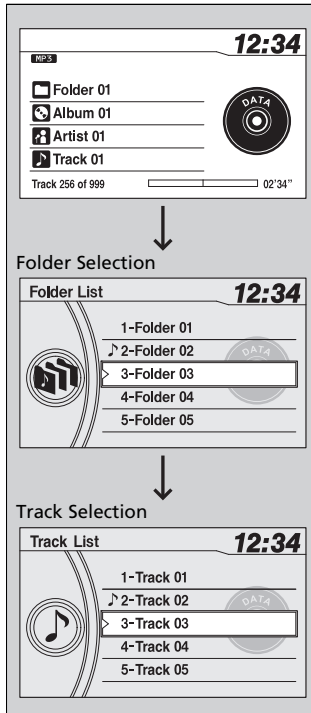

1. Press  to switch the display to a folder list.

2. Rotate  to select a folder.

3. Press  to change the display to a list of files in that folder.

4. Rotate  to select a file, then press .

▶▶ Playing a CD

NOTICE

Do not use CDs with adhesive labels. The label can cause the CD to jam in the unit.

WMA files protected by digital rights management (DRM) cannot be played. The audio system displays **UNSUPPORTED**, then skips to the next file.

Text data appears on the display under the following circumstances:

- When you select a new folder, file, or track.
- When you change the audio mode to CD.
- When you insert a CD.

If you eject the CD but do not remove it from the slot, the system reloads the CD automatically after several seconds.

■ How to Select a Play Mode

You can select repeat, random, and scan modes when playing a track or file.

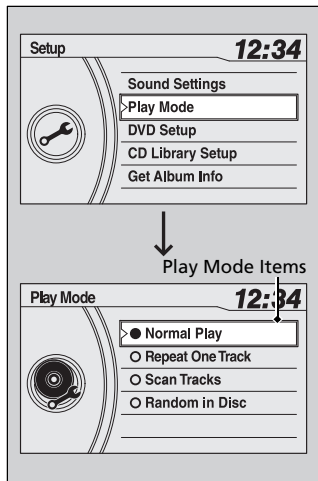

1. Press the **SETUP** button.

2. Rotate to select **Play Mode**, then press .
3. Rotate to select a mode, then press .

■ To turn off a play mode

1. Press the **SETUP** button.
2. Rotate to select **Play Mode**, then press .
3. Rotate to select **Normal Play**, then press .

☒ How to Select a Play Mode

Press the / RETURN button to go back to the previous display, and press the **SETUP** button to cancel this setting mode.

Play Mode Menu Items

Normal Play

Repeat One Track: Repeats the current track/file(s).

Repeat One Folder (MP3/WMA/AAC): Repeats all files in the current folder.

Random in Folder (MP3/WMA/AAC): Plays all files in the current folder in random order.

Random in Disc: Plays all tracks/files in random order.

Scan Tracks: Samples all tracks on the CD.

(MP3/WMA/AAC): Samples all files in the current folder.

Scan Folders (MP3/WMA/AAC): Samples the first file in each folder.

Playing CD Library

The songs on music CDs can be recorded to the flash memory. You can then play the songs directly from your vehicle's audio system.



Models without rear entertainment system

VOL/  (Power/volume) Knob
Press to turn the audio system ON and OFF.
Turn to adjust the volume.

SCAN Button
You will get a 10-second sampling of each song.
Press to sample all tracks on the album list.

- Press two times to sample the first track in each album list.
- To turn off scan, press and hold the button.

TITLE Button
Press to display the text data on the album list (if it was recorded with text data).

SKIP Bar
Press  or  to change tracks.
Press and hold to move rapidly within a track.

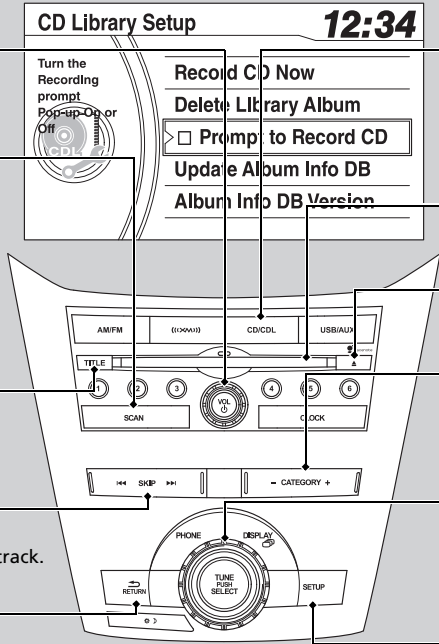

RETURN Button
Press to go back to the previous display.



CDL Button
Press and hold to play tracks from CD Library. The previously selected track will be played.

CD Slot
Insert a CD about halfway into the CD slot.

 (CD Eject) Button
Press to eject a CD.

CATEGORY Bar (FOLDER Bar)
Press  to skip to the next album, and  to skip to the beginning of the previous album.

Selector Knob
Press to display the album list.
Turn to change tracks/albums. Turn to select an item, then press to set your selection.

SETUP Button
Press to display menu items.

Models with rear entertainment system

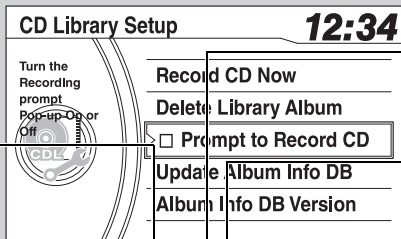

SCAN Button

You will get a 10-second sampling of each song.
Press to sample all tracks on the album list.

- Press two times to sample the first track in each album list.
- To turn off scan, press and hold the button.

TITLE Button

Press to display the text data on the album list (if it was recorded with text data).

SKIP Bar

Press ◀ or ▶ to change tracks.
Press and hold to move rapidly within a track.

RETURN Button

Press to go back to the previous display.

VOL/ ⏻ (Power/volume) Knob

Press to turn the audio system ON and OFF.
Turn to adjust the volume.

CDL Button

Press and hold to play tracks from CD Library. The previously selected track will be played.

CD Slot

Insert a CD about halfway into the CD slot.

▲ (CD Eject) Button

Press to eject a CD.

CATEGORY Bar

Press + to skip to the next album, and - to skip to the beginning of the previous album.

Selector Knob

Press to display the album list.
Turn to change tracks/albums. Turn to select an item, then press to set your selection.

SETUP Button

Press to display menu items.

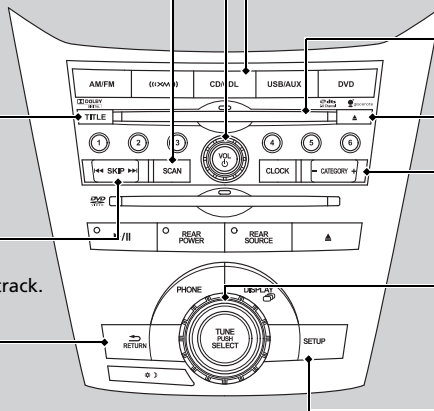

Recording a Music CD to CD Library

■ If the CD is played in the audio unit for the first time

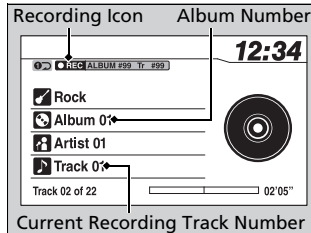
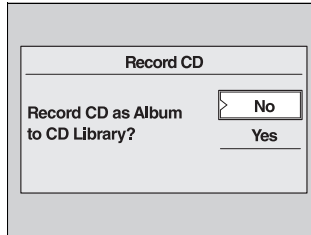

1. A prompt appears and asks if you want the currently playing CD to be recorded to the flash memory.
2. Rotate to select **YES**. Press to start recording.
 - ▶ The display changes to the album list.
3. Rotate to select one of the album numbers you want the currently playing CD to be stored, then press .
4. The display indicates, with an icon, that the CD is being recorded.
 - ▶ The icon disappears when the recording is finished.

▶▶ Playing CD Library

You can store up to 18 albums.

The system supports the recording function from the standard CD-DA only.

▶▶ Recommended CDs P. 233

The system does not support the CD-DA with copy protection.

Gracenote® searches for the title information for the CD you have recorded to the flash memory. If the information is found, song titles are displayed.

If you turn off the ignition switch while recording a CD, there may be pauses between songs when you playback from the CD Library.

Forward/rewind, repeat, random and scan function are not available during recording. You can listen to tracks from other album lists while recording.

There is no compensation offered in the case of unsuccessful recording of audio data or the loss of audio data due to any cause whatsoever.

■ Deactivating the prompt display

If you do not want the prompt to appear on the display for the first time you play a CD:

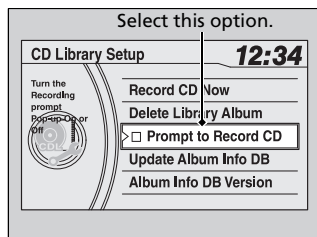

1. Press the **SETUP** button.
2. Rotate to select **CD Library Setup**, then press .
3. Rotate to select **Prompt to Record CD**, then press .
 - ▶ To activate the prompt display again, follow the same procedure.

■ Recording a CD Manually

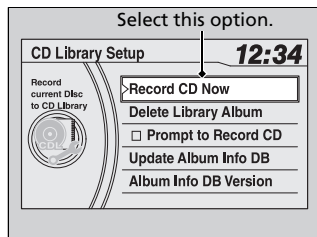





1. Insert a CD you want to record to the flash memory, and press the **SETUP** button.
2. Rotate to select **CD Library Setup**, then press .
3. Rotate to select **Record CD Now**, then press .
 - ▶ The display changes to the album list.
4. Rotate to select one of the album numbers you want the currently playing CD to be stored, then press .
 - ▶ If you select an album number that has already had another CD, the system asks if you want to replace this album with the album currently in the slot. Select **Yes** to replace, and **No** to return.

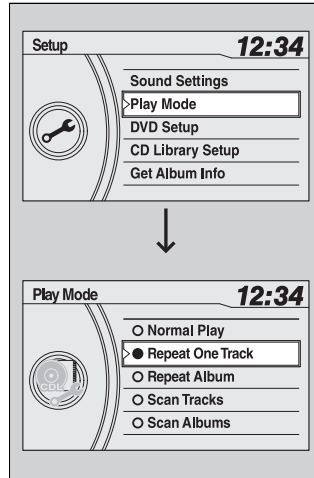



■ Selecting a Play Mode for CD Library

You can select repeat, random, and scan modes when playing CD Library.



1. Press the **SETUP** button.
2. Rotate  to select **Play Mode**, then press .
3. Rotate  to select a mode, then press .

■ To turn off a play mode

1. Press the **SETUP** button.
2. Rotate  to select **Play Mode**, then press .
3. Rotate  to select **Normal Play**, then press .

▶▶ How to Select a Play Mode

Press the  / **RETURN** button to go back to the previous display, and press the **SETUP** button to cancel this setting mode.

Play Mode Menu Items

Normal Play

Repeat One Track: Repeats the current track.

Repeat Album: Repeats all tracks in the current album.

Scan Tracks: Samples all tracks on the CD.

Scan Albums: Samples the first track in each album.

Random in Albums: Plays all tracks in the current album in random order.

Random All: Plays all tracks in the current album list in random order.

Other CD Library Setup Menu

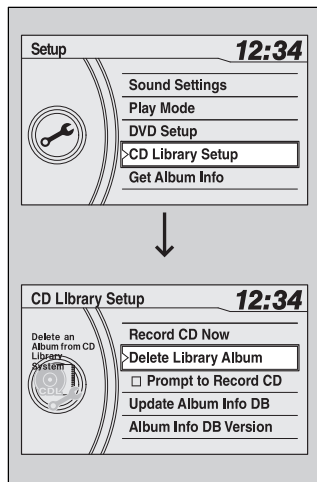

1. Press the **SETUP** button.
2. Rotate to select **CD Library Setup**, then press .
3. Rotate to select a menu item, then press .

To update Gracenote® Album Info

1. Insert the update disc into the disc slot that includes the update.
2. Press the **SETUP** button.
3. Rotate to select **CD Library Setup**.
4. Rotate to select **Update Album Info DB**, then press .
5. Rotate to select **Yes**. Press to start updating.

Other CD Library Setup Menu

CD Library setup menu items

Delete Library Album: Delete albums in CD Library. Rotate to select an album you want to delete and select **Yes**.

Album Info DB Version: Displays the current album's database version information.

Update Album Info DB:

To update Gracenote® Album Info

To update Gracenote® Album Info

To acquire updated files:

Consult a dealer

US: Visit www.honda.com.

Canada: Visit www.honda.ca.

Once you perform an update, any information you edited before will be overwritten or erased.

Gracenote® End User License Agreement
P. 423

Playing an iPod®

Connect the iPod® using your dock connector to the USB adapter cable, then press the **USB/AUX** button.

🔗 **USB Adapter Cable** P. 195

Models without rear entertainment system

VOL/ (Power/volume) Knob
Press to turn the audio system ON and OFF.
Turn to adjust the volume.

USB/AUX Button
Press to select iPod® (if connected).

Selector Knob
Turn to select a song, file, menu item, or play mode. Press to set your selection.

SETUP Button
Press to display menu items.

SKIP Bar
Press ◀◀ or ▶▶ to change songs.
Press and hold to move rapidly within a song.

RETURN Button
Press to go back to the previous display.

Models with rear entertainment system

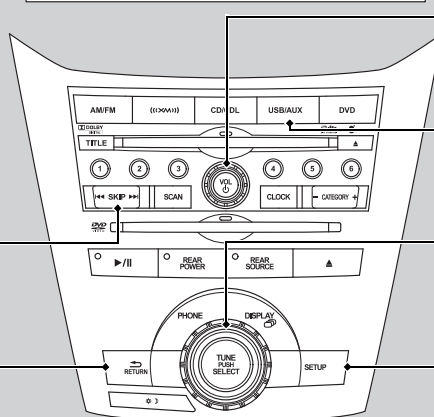
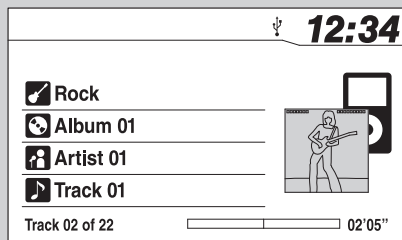

VOL/ (Power/volume) Knob
 Press to turn the audio system ON and OFF.
 Turn to adjust the volume.

USB/AUX Button
 Press to select iPod® (if connected).

Selector Knob
 Turn to select a song, file, menu item, or play mode. Press to set your selection.

SETUP Button
 Press to display menu items.

SKIP Bar
 Press or to change songs.
 Press and hold to move rapidly within a song.

RETURN Button
 Press to go back to the previous display.

How to Select a File from the iPod® Menu

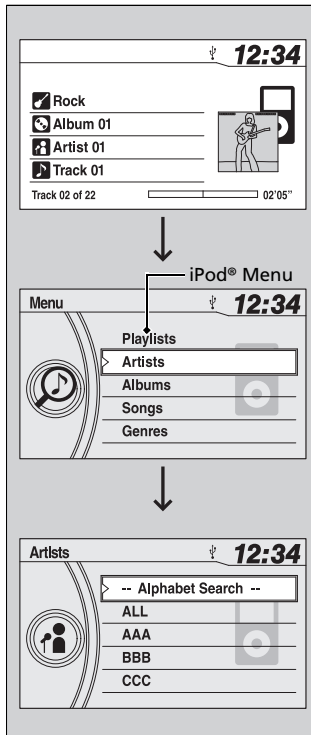

1. Press to display the iPod® menu.

2. Rotate to select a menu.

3. Press to display the items on that menu.

4. Rotate to select an item, then press .

▶▶ Playing an iPod®

Available operating functions vary on models or versions. Some functions may not be available on the vehicle's audio system.

If there is a problem, you may see an error message on the multi-information display.

iPod®/USB Flash Drive P. 231

■ How to Select a Play Mode

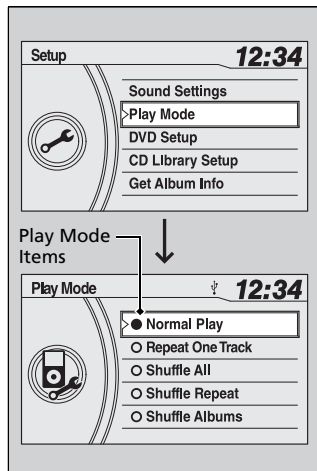

You can select repeat and shuffle modes when playing a file.



1. Press the **SETUP** button.

2. Rotate  to select **Play Mode**, then press



3. Rotate  to select a mode, then press .

■ To turn off a play mode

1. Press the **SETUP** button.

2. Rotate  to select **Play Mode**, then press .

3. Rotate  to select **Normal Play**, then press .

☒ How to Select a Play Mode

Play Mode Menu Items

Normal Play

Repeat One Track: Repeats the current track.

Shuffle All: Plays all available files in a selected list (playlists, artists, albums, songs, genres, or composers) in random order.

Shuffle Repeat: Repeats the shuffle all feature.

Shuffle Albums: Plays all available albums in a selected list (playlists, artists, albums, songs, genres, or composers) in random order.

Shuffle Album Repeat: Repeats the shuffle album feature.

Playing a USB Flash Drive

Your audio system reads and plays sound files on a USB flash drive in either MP3, WMA or AAC*1 format.

Connect your USB flash drive to the USB adapter cable, then press the **USB/AUX** button.

➤ **USB Adapter Cable** P. 195

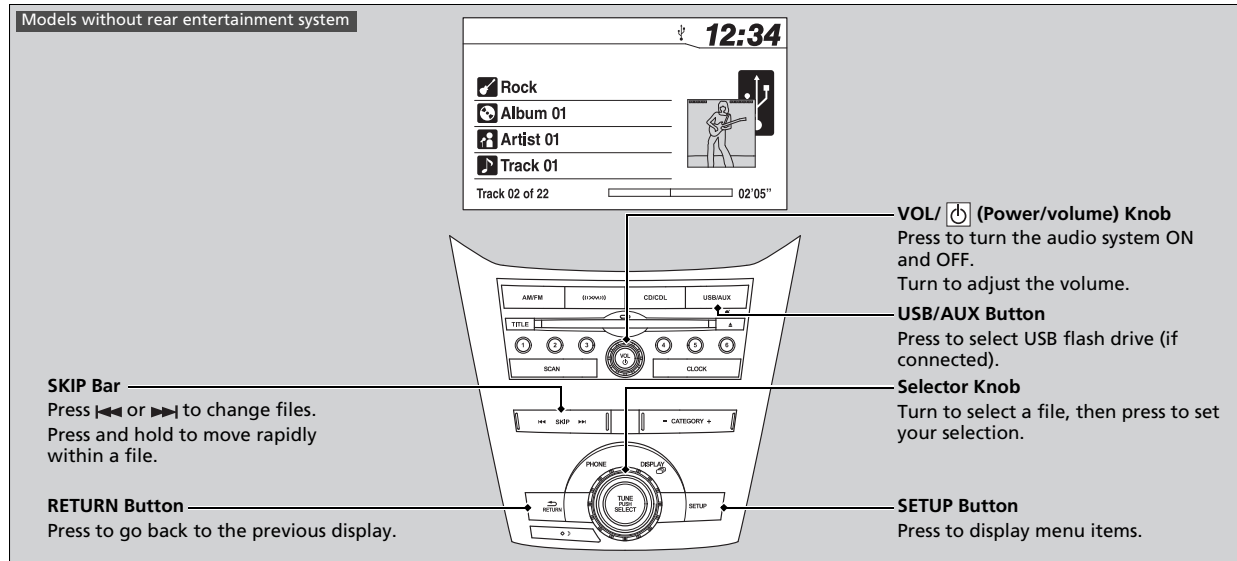

*1: Only AAC format files recorded with iTunes® are playable on this audio unit.

Models with rear entertainment system

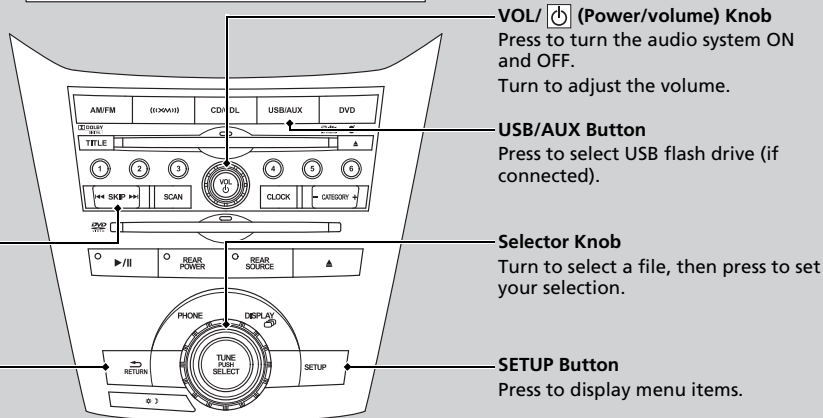
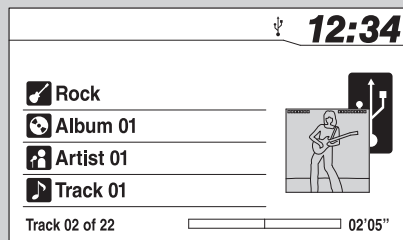

How to Select a File from a Folder with the Selector Knob

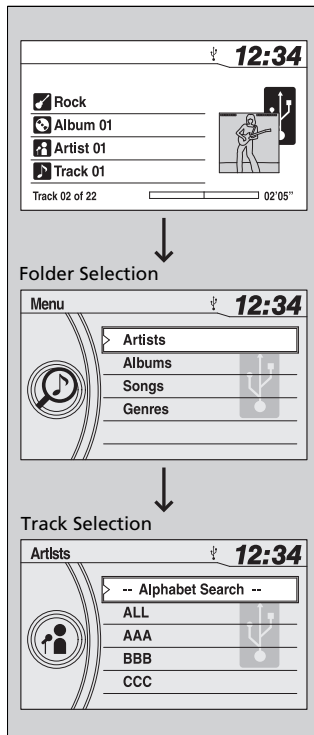

1. Press to switch the display to a folder list.

2. Rotate to select a folder.

3. Press to change the display to a list of files in that folder.

4. Rotate to select a file, then press .

▶▶▶ Playing a USB Flash Drive

Use the recommended USB flash drives.

▶ **General Information on the Audio System**
P. 232

Files in WMA format protected by digital rights management (DRM) are not played.

The audio system displays **UNPLAYABLE FILE**, and then skips to the next file.

If there is a problem, you may see an error message on the multi-information display.

▶ **iPod®/USB Flash Drive** P. 231

■ How to Select a Play Mode

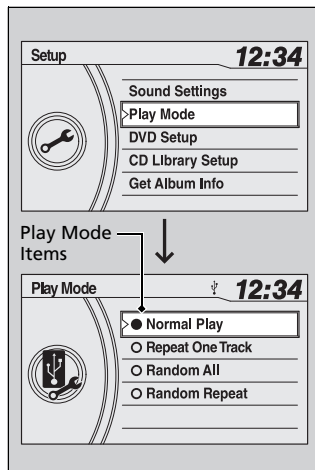

You can select repeat and random modes when playing a file(s).



1. Press the **SETUP** button.

2. Rotate  to select **Play Mode**, then press



3. Rotate  to select a mode, then press .

■ To turn off a play mode

1. Press the **SETUP** button.

2. Rotate  to select **Play Mode**, then press .

3. Rotate  to select **Normal Play**, then press .

☒ How to Select a Play Mode

Play Mode Menu Items

Normal Play

Repeat One Track: Repeats the current file.

Random All: Plays all files in random order.

Random Repeat: Repeats the random all feature.

Playing Bluetooth® Audio

Your audio system allows you to listen to music from your *Bluetooth*®-compatible phone.

This function is available when the phone is paired and linked to the vehicle's *Bluetooth*® HandsFreeLink® (HFL) system.

➤ **Phone Setup** P. 259

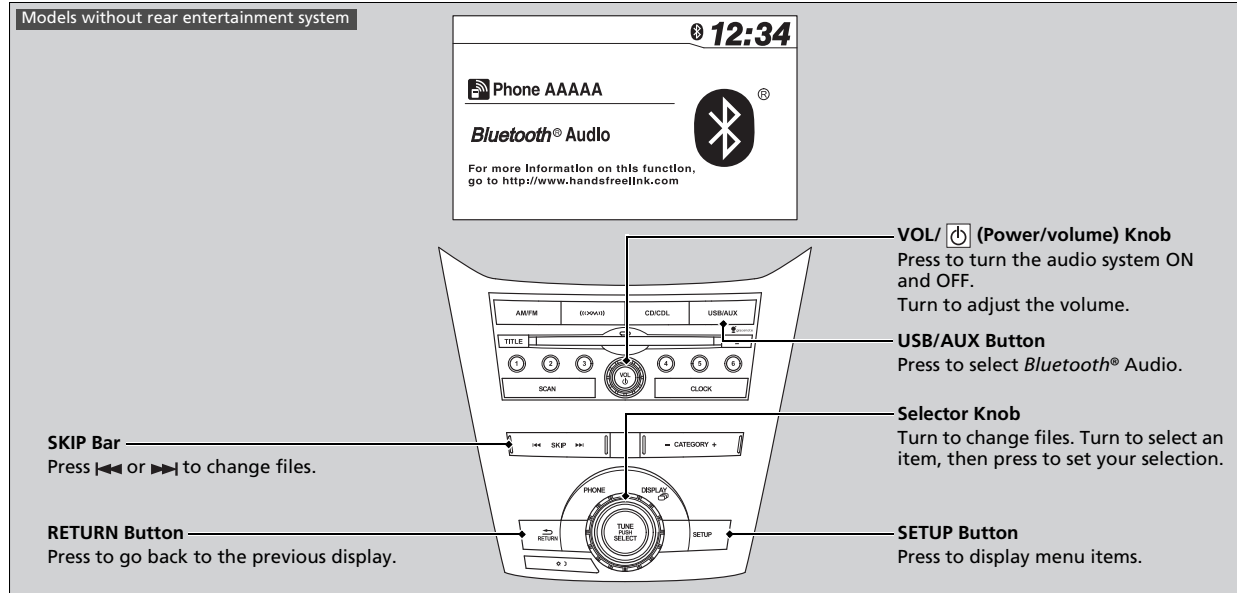

Models with rear entertainment system

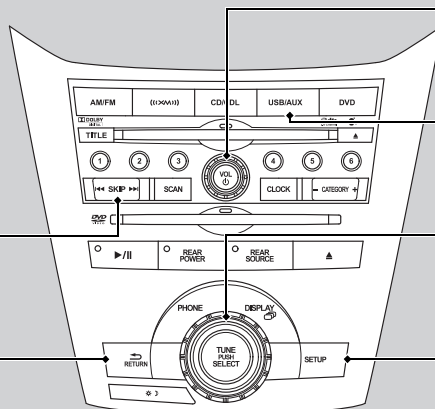
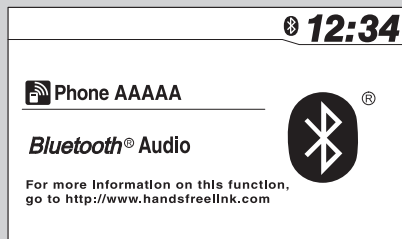

VOL/ (Power/volume) Knob
 Press to turn the audio system ON and OFF.
 Turn to adjust the volume.

USB/AUX Button
 Press to select Bluetooth® Audio.

Selector Knob
 Turn to change files. Turn to select an item, then press to set your selection.

SKIP Bar
 Press ◀ or ▶ to change files.

RETURN Button
 Press to go back to the previous display.

SETUP Button
 Press to display menu items.



■ To Play *Bluetooth*® Audio Files

1. Make sure that your phone is paired and linked to HFL.
2. Press the **AUX** button.

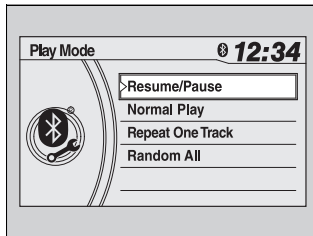
If the phone is not recognized, another HFL-compatible phone, which is not compatible for *Bluetooth*® Audio, may already be linked.



■ To pause or resume a file

1. Press the **SETUP** button.
2. Rotate  to select **Resume/Pause**, then press .

Each time you press , the setting switches between Pause and Resume.

▶▶ Playing *Bluetooth*® Audio

Not all *Bluetooth*-enabled phones with streaming audio capabilities are compatible with the system. You can find an approved phone by visiting www.handsfreelink.honda.com, or by calling the HandsFreeLink® consumer support at (888) 528 - 7876. In Canada, visit www.handsfreelink.ca, or call (888) 528 -7876.

In some states, it may be illegal to perform some data device functions while driving.

If more than one phone is paired to the HFL system, there will be a delay before the system begins to play.

▶▶ To Play *Bluetooth*® Audio Files

To play the audio files, you may need to operate your phone. If so, follow the phone maker's operating instructions.

The pause function may not be available on some phones.

If any audio device is connected to the auxiliary input jack, you may need to press the **AUX** button repeatedly to select the *Bluetooth*® Audio system.

Switching to another mode pauses the music playing from your phone.

How to Select a Play Mode

You can select repeat and random modes when playing a file(s).

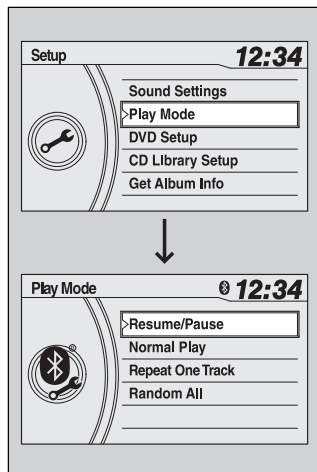

1. Press the **SETUP** button.
2. Rotate to select **Play Mode**, then press .

3. Rotate to select a mode, then press .

To turn off a play mode

1. Press the **SETUP** button.
2. Rotate to select **Play Mode**, then press .
3. Rotate to select **Normal Play**, then press .

How to Select a Play Mode

PlayMode Menu Items

Normal Play

Repeat One Track: Repeats the current file.

Random All: Plays all files in random order.

Switching to HFL

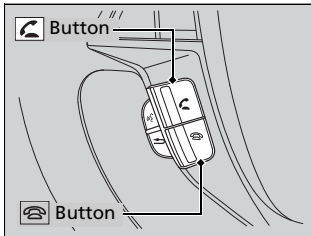

Press the  (pick-up) button on the steering wheel to receive a call when *Bluetooth*® Audio is playing.

 **Bluetooth® HandsFreeLink®** P. 254



Press the  (hang-up) button to end the call and return to *Bluetooth*® Audio.

Switching to HFL

If you receive a call while *Bluetooth*® Audio is in the pause mode, it will resume play after ending the call.

CD Player

If a disc error occurs, you may see the following error messages.

Error Message	Cause	Solution
UNSUPPORTED	Track/file format not supported	<ul style="list-style-type: none">• Current track/file will be skipped. The next supported track/file plays automatically.
BAD DISC PLEASE CHECK OWNERS MANUAL PUSH EJECT	Mechanical error	<ul style="list-style-type: none">• Press the  (eject) button and remove the disc, and check that the error message is cleared.• Check that the disc is not damaged or deformed, and insert the disc again.<ul style="list-style-type: none">➤ Protecting CDs P. 234
BAD DISC PLEASE CHECK OWNERS MANUAL	Servo error	<ul style="list-style-type: none">• If the error message reappears, press the  button, and pull out the disc.• Insert a different disc. If the new disc plays, there is a problem with the first disc.• If the error message repeats, or the disc cannot be removed, contact a dealer. Do not try to force the disc out of the player.
CHECK DISC	Disc error	<ul style="list-style-type: none">• Check that the disc is not damaged or deformed.<ul style="list-style-type: none">➤ Protecting CDs P. 234

iPod®/USB Flash Drive

If an error occurs while playing an iPod® or USB flash drive, you may see the following error messages. If you cannot clear the error message, contact a dealer.

Error Message	Solution
USB ERROR	Appears when there is a problem with the USB adapter unit. Check if the device is compatible with the USB adapter unit.
BAD USB DEVICE PLEASE CHECK OWNERS MANUAL	Appears when an incompatible device is connected. Disconnect the device. Then turn the audio system off, and turn it on again. Do not reconnect the device that caused the error.
NO SONG	Appears when the iPod® is empty. Check that compatible files are stored on the device.
UNSUPPORTED VER	Appears when an unsupported iPod® is connected. If it appears when a supported iPod® is connected, update the iPod® software to the newer version.
CONNECT RETRY	Appears when the system does not acknowledge the iPod®. Reconnect the iPod®.
UNPLAYABLE FILE	Appears when the files in the USB flash drive are DRM or an unsupported format. This error message appears for about 3 seconds, then plays the next song.
NO DATA	Appears when the USB flash drive is empty or there are no MP3, WMA, or AAC files in the USB flash drive. Check that compatible files are stored on the device.
UNSUPPORTED	Appears when an unsupported device is connected. If it appears when a supported device is connected, reconnect the device.

XM® Radio Service*

■ Subscribing to XM® Radio

1. You need your radio ID ready before registering for subscription.
To see the ID on the display: Turn the selector knob until **0** appears.
2. Have your radio ID and credit card number ready, and either call or visit the XM® website to subscribe.

■ Receiving XM® Radio

Press the  (XM®) button and stay in this mode for about 30 minutes until the service is activated. Make sure your vehicle is in an open area with good reception.

■ XM® Radio Display Messages

LOADING: XM® is loading the audio or program information.

OFF AIR: The channel is not currently broadcasting.

UNAUTHORIZED: The encryption code is being updated. Channels 0 and 1 still work normally.

NO SIGNAL: The signal is too weak in the current location.

UNAVAILABLE: No such channel exists, the channel is not part of your subscription, or the artist or title information is unavailable.

CHECK ANTENNA: There is a problem with the XM® antenna. Contact a dealer.

☒ Subscribing to XM® Radio

Contact Information for XM® Radio:

US: XM® Radio at www.siriusxm.com or (800) 852-9696

Canada: XM® Canada at www.xmradio.ca, or (877) 209-0079

☒ Receiving XM® Radio

The XM® satellites are in orbit over the equator, therefore, objects south of the vehicle may cause satellite reception interruptions. Satellite signals are more likely to be blocked by tall buildings and mountains the farther north you travel from the equator.

You may experience reception problems under the following circumstances:

- In a location with an obstruction to the south of your vehicle.
- In tunnels
- On the lower level of a multi-tiered road
- Large items carried on the roof rack

Recommended CDs

- Use only high-quality CD-R or CD-RW discs labeled for audio use.
- Use only CD-R or CD-RW discs on which the recordings are closed.
- Play only standard round-shaped CDs.

The CD packages or jackets should have one of these marks.



CDs with MP3, WMA or AAC files

- Some software files may not allow for audio play or text data display.
- Some versions of MP3, WMA or AAC formats may be unsupported.

▶▶ Recommended CDs

A Dual-disc cannot play on this audio unit. If recorded under certain conditions, a CD-R or CD-RW may not play either.

■ Protecting CDs

Follow these precautions when handling or storing CDs:









- Store a CD in its case when it is not being played.
- When wiping a CD, use a soft clean cloth from the center to the outside edge.
- Handle a CD by its edge. Never touch either surface.
- Never insert foreign objects into the CD player.
- Keep CDs out of direct sunlight and extreme heat.
- Do not place stabilizer rings or labels on the CD.
- Avoid fingerprints, liquids, and felt-tip pens on the CD.

☒ Protecting CDs

NOTICE

Do not insert a damaged CD. It may be stuck inside and damage the audio unit.

Examples:

- **Bubbled, wrinkled, labeled, and excessively thick CDs**
 -  Bubbled/Wrinkled
 -  With Label/Sticker
 -  Using Printer Label Kit
 -  Sealed
 -  With Plastic Ring
- **Damaged CDs**
 -  Chipped/Cracked
 -  Warped
 -  Burrs
- **Poor quality CDs**
- **Small CDs**
 -  3-inch (8-cm) CD

Compatible iPod® and USB Flash Drives

■ iPod® Model Compatibility

Model
iPod classic® 80/160G
iPod classic® 120G
iPod classic® 160G (launch in 2009)
iPod® (5th generation)
iPod nano®
iPod touch®

■ USB Flash Drives

- Use a recommended USB flash drive of 256 MB or higher.
- Some digital audio players may not be compatible.
- Some USB flash drives (e.g., a device with security lockout) may not work.
- Some software files may not allow for audio play or text data display.
- Some versions of MP3, WMA, or AAC formats may be unsupported.

» iPod® Model Compatibility

This system may not work with all software versions of these devices.

» USB Flash Drives

Files on the USB flash drive are played in their stored order. This order may be different from the order displayed on your PC or device.

Rear Entertainment System*

Models with navigation system

For models with the navigation system, see the Navigation System Manual for how to operate the rear entertainment system.

Models without navigation system

Allows the rear passengers to enjoy a different entertainment source, such as DVD, CD, CD Library, and radio, than the front passengers.

Wireless Headphones

The rear seat passengers can listen to audio from the rear entertainment system by a wireless headphone that comes with your vehicle.

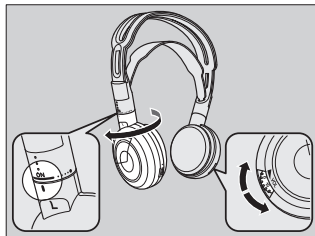

To turn on the switch: Pivot the left earpiece outward.

To adjust the volume: Turn the dial at the bottom of the right earpiece.

Rear Entertainment System*

NOTICE

This vehicle's overhead mounted video display, if so equipped, includes mercury-containing components. Upon removal, please reuse, recycle, or dispose of as hazardous waste.

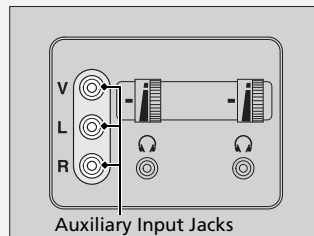

The system also allows for auxiliary inputs from standard video games. The jacks are above the third row seat armrest on the driver's side.

V = Video jack

L = Left audio jack

R = Right audio jack

Wireless Headphones

Your vehicle comes with two wireless headphones.

Wear the headphone correctly with the earpiece marked with L goes to your left ear and R goes to your right ear.

Wearing the headphone backward may affect the audio reception.

Overhead Screen

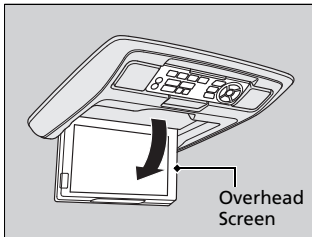

Pull down the screen to the first or second detent until it latches.

Overhead Screen

NOTICE

This vehicle's overhead mounted video display, if so equipped, includes mercury-containing components. Upon removal, please reuse, recycle, or dispose of as hazardous waste.

You can use the rear control panel as a remote. Press the lock tab to detach it.

Operating the System

To operate the system, turn the ignition switch to ON **II** or ACCESSORY **I**. Press the **REAR POWER** button to turn on the system (indicator on).

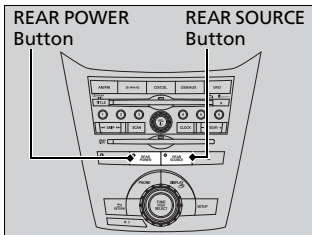

REAR SOURCE button on the front panel

When you press the **REAR SOURCE** button (indicator on), the beeper sounds three times, and the front display changes to what is displayed on the rear overhead screen.

The audio from the front speakers switches to the audio played in the rear.

Operating the System

If you do not operate the system from the front panel for more than 20 seconds, the indicator in the **REAR SOURCE** button goes off, and the front display returns to what has previously been displayed.

System Controls and Menus for DVD

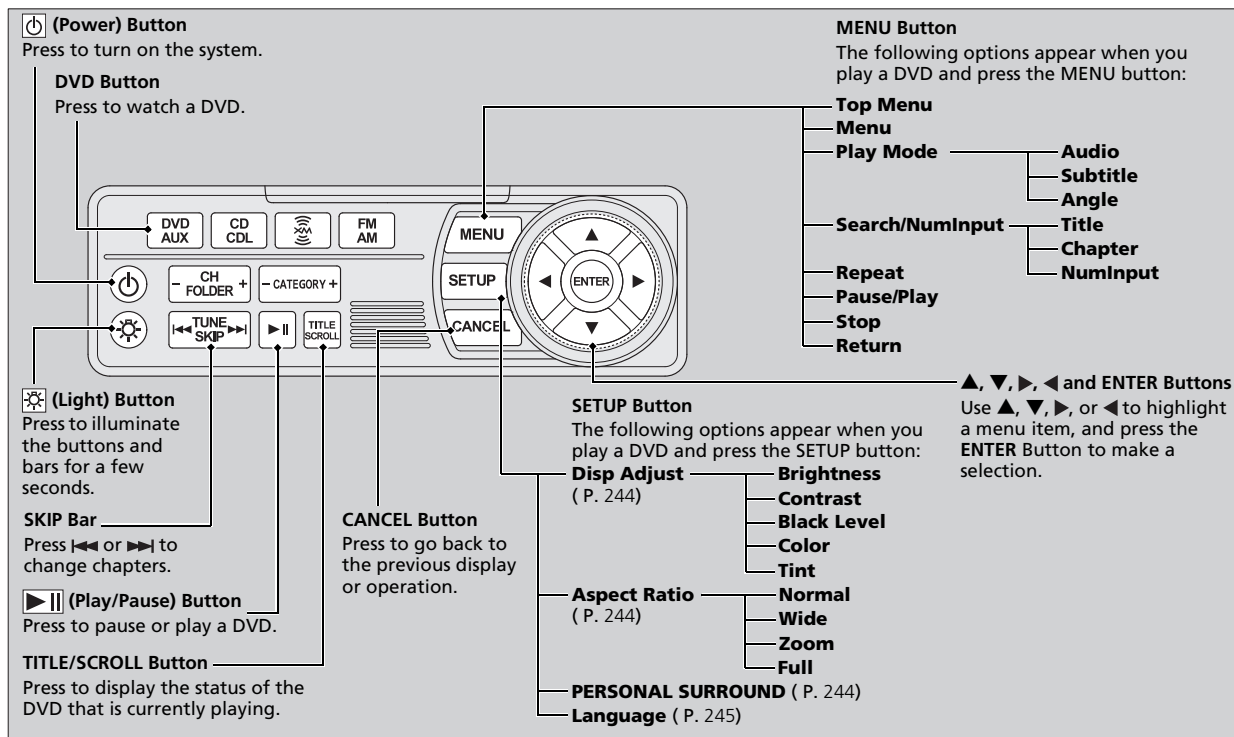

■ Playing a DVD

- Insert a DVD into the lower slot of the front audio unit.
 - ▶ The system automatically starts the DVD.
- To fast forward, press and hold the ▶▶ (SEEK/SKIP) bar, and to reverse, press and hold the ◀◀ bar on the front panel or the remote.
- To go to the next chapter, press the ▶▶ bar, and to go to the beginning of the current chapter, press the ◀◀ bar on the front panel or the remote. Quickly press the ◀◀ bar twice to go to the previous chapter.

■ DVD setup from the front panel

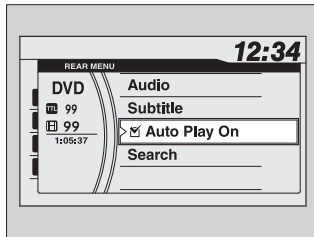

Press the **REAR SOURCE** button on the front panel while a DVD is playing and display **REAR MENU** in front. Rotate to select DVD Setup, then press .

Setting up Audio:

1. Rotate to select **Audio**, then press .
2. Rotate to select a language for audio that is available on the DVD, then press .

Setting up Subtitle:



1. Rotate to select **Subtitle**, then press .
2. Rotate to select a subtitle language that is available on the DVD.

▶▶ Playing a DVD





DVD is available for the rear seat passenger only.

If you have turned off the Auto Play feature, press the (play) button on the front panel or remote.

Auto Play On:

1. Rotate  to select **Auto Play On**, then press .
2. The check mark disappears, and the auto play feature turns off.
 - ▶ With this feature off, the DVD does not automatically start playing when the disc is inserted. Press  button to play.

Title/Chapter Search:

1. Rotate  to select **Title Search** or **Chapter Search**, then press .
2. Rotate  to select a title or chapter number, then press .

■ TITLE/SCROLL button on the remote

Press the **TITLE/SCROLL** button while the DVD is playing to see the current status of title, chapter, elapsed time, angle, subtitle, audio, and sound characteristics.

■ MENU button on the remote

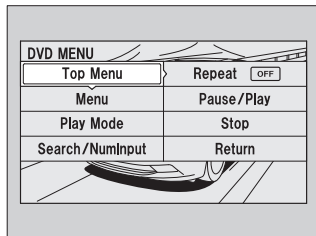

Press the **MENU** button while the DVD is playing to see the available options. Use the **▲**, **▼**, **▶**, and **◀** buttons to highlight the option and then press the **ENTER** button.

▶ TITLE/SCROLL button on the remote

Press the **TITLE/SCROLL** button again to return.

Top Menu:

The top page of the DVD's title menu appears. The title menu also appears when you press the **MENU** button while the DVD is in the slot not playing. Press the **CANCEL** or **MENU** button to return.

Menu:

The DVD's title menu appears.

Play Mode:

You can change the following three settings:

-
- Audio - Select a language for audio that is available on the DVD. The sound characteristics (Dolby Digital, LPCM, MPEG Audio, dts, etc) of that audio is also displayed.
 - Subtitle - Select a subtitle that is available on the DVD.
 - Angle - Select a view angle that is available on the DVD. If the DVD currently playing does not carry multiple angles, only one option **Angle 1** comes on. Press the **CANCEL** or **MENU** button to return.
-

When the DVD is not playing

If you press the **MENU** button while the DVD is not playing, the option **Play Mode** changes to **Initial Settings**.

Initial Settings:

You can configure the initial Language, Dynamic Range, and Angle Mark settings before playing DVD.

Language Settings - Select the language for the DVD's displayed menus (Menu Language), the DVD's audio (Audio Language), and the DVD's subtitle (Subtitle Language).

1. Select the language setting.
2. Select the language from **English, French, Spanish, Arabic, German, Italian, Dutch, Chinese, Korean, Thai, Japanese**, and **other**.
3. If you select other, you need to enter the four digit language code number to configure the language that is not listed. Select Yes to go to the number input screen.
 - ▶ To return to the language **Setting screen**, select No.
4. Press the **ENTER** button each time you input digit.
 - ▶ If you want to delete a number, select **DEL**.
5. The cursor automatically goes to **ENT** after you input four digits. Press the **ENTER** button to command.

Dynamic Range - The feature reduces the difference between the loud and quiet sound levels. Select **ON** or **OFF**.

Angle Mark - You can select whether to display the angle mark appearing in the upper right corner of the screen when you change the view angle while the DVD is playing. Select **ON** or **OFF**.

MENU button on the remote

Initial Settings:

The prior language varies by disc. You may not be able to configure your selected language setting.

Search:

You can search for a DVD segment from the following methods.

Title Search -	Select the title you want to play.
Chapter Search -	Select the chapter you want to play.
NumInput -	Enter a three digit number, if issued to the DVD, to find the segment you want to start to play.

1. Select **NumInput** to go to the number input screen.
2. Use the ▲, ▼, ▶, and ◀ buttons to input numbers.
 - ▶ If you want to delete a number, select **DEL**.
3. The cursor automatically goes to **ENT** after you input three digits. Press the **ENTER** button to command.

Repeat:

Highlight this option and press the **ENTER** button to change the repeat mode from chapter repeat and title repeat, to repeat off.

■ SETUP button on the remote

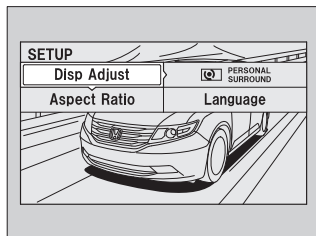

Press the **SETUP** button while the DVD is playing to see the available options. Use the ▲, ▼, ▶, and ◀ buttons to highlight the option and then press the **ENTER** button.

Disp Adjust:

You can adjust the overhead screen's brightness, contrast, black level, color, and tint. To return to the default display setting, select **Reset**.

After you make all the adjustments, the screen goes back to the top **SETUP** screen, or press the **CANCEL** button to return.

Aspect Ratio:

You can select the screen mode with a different aspect ratio from Normal, Wide, Zoom and Full. After you select the mode, it takes about one second to return to the play mode with the selected ratio.

Personal Surround:

You can select the sound effect mode that fits the DVD's audio source from Music, Cinema, and Voice. Select Off to turn this feature off.

Language:

You can select the display language from **English**, **French**, and **Spanish**.

When the DVD is not playing

You can select the audio language from **English**, **French**, and **Spanish**.

Appearance:

You can select the screen color from **white**, **black**, **blue**, **brown**, and **red**.

System Controls and Menus for Audio

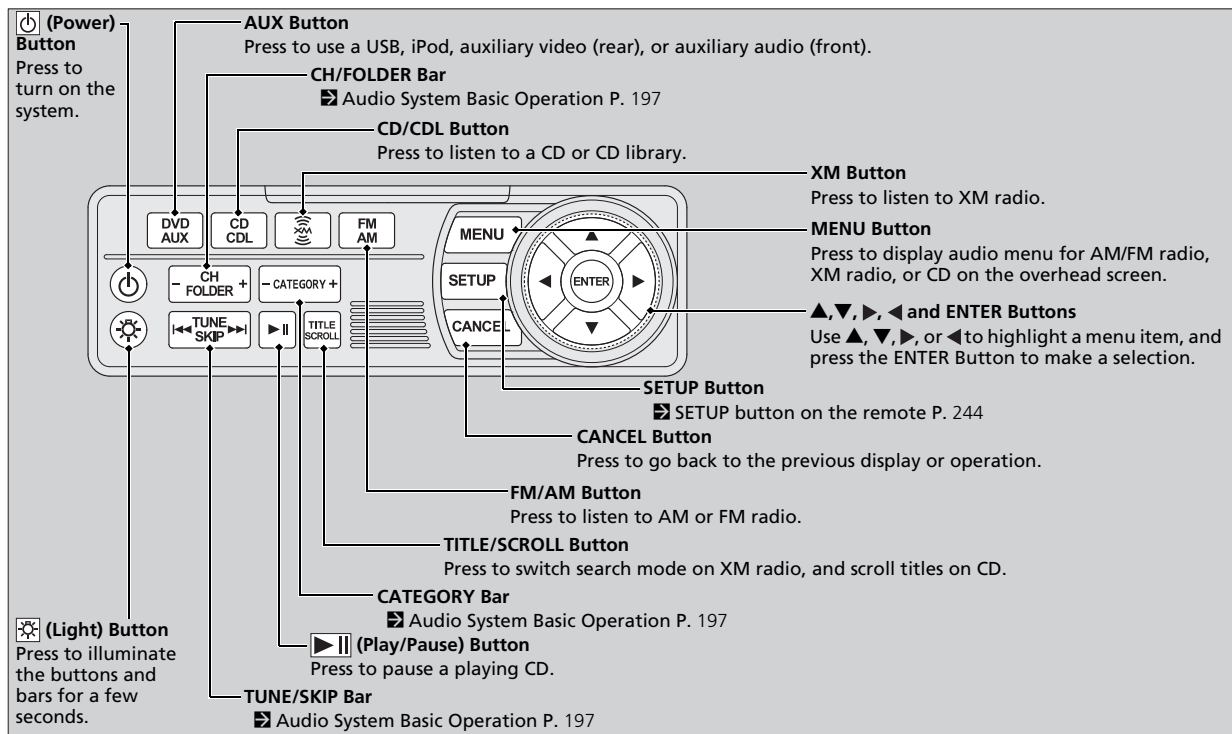

■ Playing AM/FM radio in the rear

Press the **AM/FM** button.

When you press the **MENU** button while the radio is playing, the audio menu appears on the overhead screen. The available functions are the same as those of the front audio system. The **TUNE/SKIP** bar on the control panel works the same as the **TUNE** or **SKIP** bar on the front panel for AM/FM radio operation.

▶ **Playing the AM/FM Radio** P. 200

■ Playing XM radio in the rear

Press the **XM** button.

When you press the **MENU** button while the radio is playing, the audio menu appears on the overhead screen. The available functions are the same as those of the front audio system. The **TUNE/SKIP** bar on the control panel works the same as the **TUNE** or **SKIP** bar on the front panel for XM radio operation.

▶ **Playing the XM® Radio*** P. 204

To change the mode between category and channel, press and hold the **TITLE/SCROLL** button for five seconds.

▶▶ System Controls and Menus for Audio

If you press the  button on the front panel, you can operate the rear entertainment system from the front display.

▶  **button on the front panel** P. 237

■ Playing a CD, and CD Library

Press the **CD/CDL** button.

The available options appear on the overhead screen are Repeat, Random, and Scan. These functions are the same as those of the front audio system.

➤ **Playing a CD** P. 207

➤ **Playing CD Library** P. 211

To scroll your audio data title, press the **TITLE/SCROLL** button for five seconds.

■ Playing iPod® and a USB flash drive

Press the **AUX** button.

The available options appear on the overhead screen are Repeat, Random, and Scan. These functions are the same as those of the front audio system.

➤ **Playing an iPod®** P. 217

➤ **Playing a USB Flash Drive** P. 221

To scroll your audio data title, press the **TITLE/SCROLL** button for five seconds.

System Controls and Menus for Audio

If you press the  button on the front panel, you can operate the rear entertainment system from the front display.

➤  **button on the front panel** P. 237

You can also insert an audio CD compatible with the system, or recorded in MP3/WMA/AAC formats into the lower slot and play. The front passengers can listen to the same CD, or select another audio source.

➤ **Playable Discs** P. 250

➤ **Audio Sources for Front and Rear Seats**
P. 249

Audio Sources for Front and Rear Seats

The table shows the possible audio source combinations of the front audio system and rear entertainment system's simultaneous use.

Front Rear	AM/FM Radio	XM Radio	CD	CD Library	DVD*1	USB iPod®
AM/FM Radio	Yes	Yes	Yes	Yes	Yes	Yes
XM Radio	Yes	Yes	Yes	Yes	Yes	No
CD	Yes	Yes	Yes*2	Yes	Yes	Yes
CD Library	Yes	Yes	Yes	Yes	Yes	Yes
DVD	Yes	Yes	Yes	Yes	Yes	Yes
USB iPod®	Yes	No	Yes	Yes	Yes	Yes

*1: The front seat passengers are only able to hear the DVD's sound from the front speakers.

*2: There are two cases. Two different CDs can be played, one for the front seats, and the other for the rear seats if the upper and lower slots are used. If only one slot is used, the front and rear seats can share the same audio source.

▶▶ Audio Sources for Front and Rear Seats

Yes: These audio sources are simultaneously playable.
No: These audio sources are not simultaneously playable.

Playable Discs



The discs that come with these labels can be played in your vehicle's rear entertainment system.

Also look for the region code of 1 or ALL on the package or jacket on the disc.

DVD-ROMs are not playable in this unit.

▶▶ Playable Discs

This product incorporates copyright protection technology that is protected by U.S. patents and other intellectual property rights.

Use of this copyright protection technology must be authorized by Macrovision, and is intended for home and other limited viewing uses only unless otherwise authorized by Macrovision.

Manufactured under license under U.S. Patent's: 5,451,942; 5,956,674; 5,974,380; 5,978,762; 6,487,535 & other U.S. and worldwide patents issued & pending. DTS and DTS Digital Surround are registered trademarks and the DTS logos and Symbol are trademarks of DTS, Inc. All Rights Reserved. Reverse engineering or disassembly is prohibited.

Manufactured under license from Dolby Laboratories. Dolby, Pro Logic, MLP Lossless and the double-D symbol are trademarks of Dolby Laboratories.

DVD Player Error Messages

Error Message	Cause	Solution
CHECK DISC	FOCUS Error	Press the disc eject button, and remove the disc. Check for an error indication. Insert the disc again. If the code does not disappear or the disc cannot be removed, consult a dealer.
PUSH EJECT	Mechanical Error	
CHECK REGION	Invalid region code	The disc is not playable in this unit. Eject the disc, and insert a disc compatible with this system.
UNSUPPORTED FILE	DVD format not supported	

The HomeLink® Universal Transceiver can be programmed to operate up to three remote controlled devices around your home, such as garage doors, lighting, or home security systems.

■ Important Safety Precautions

Refer to the safety information that comes with your garage door opener to test that the safety features are functioning properly. If you do not have the safety information, contact the manufacturer.

Before programming HomeLink, make sure that people and objects are out of the way of the garage or gate to prevent potential injury or damage.

When programming a garage door opener, park just outside the garage door's path.

Training HomeLink

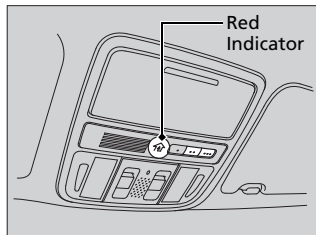

If you have not trained any of the buttons in HomeLink before, you should erase any previously learned codes. To do this:

- Press and hold the two outside buttons for about 20 seconds, until the red indicator blinks. Release the buttons, and proceed to step 1.
- If you are training the second or third button, go directly to step 1.

☒ HomeLink® Universal Transceiver*

HomeLink® is a registered trademark of Johnson Controls., Inc.

Before programming HomeLink to operate a garage door opener, confirm that the opener has an external entrapment protection system, such as an "electronic eye," or other safety and reverse stop features. If it does not, HomeLink may not be able to operate it.

Training a Button

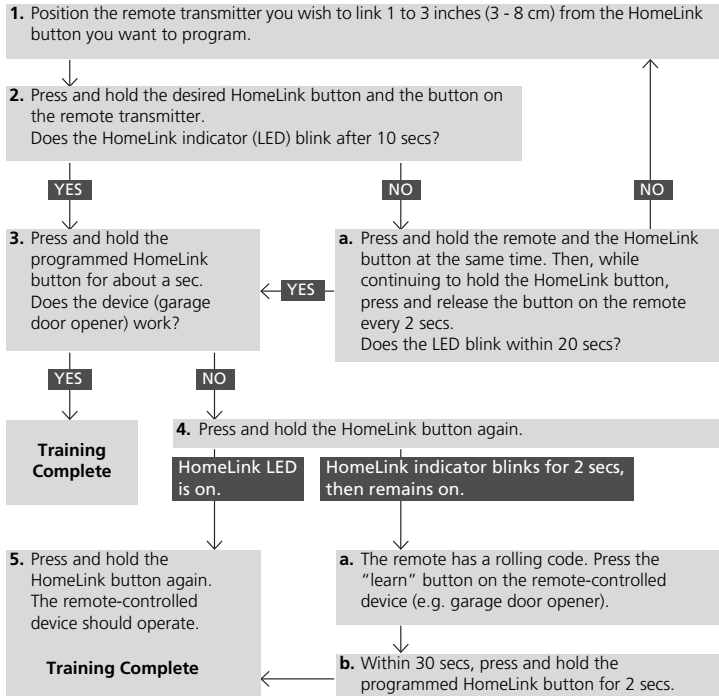

Retraining a Button

Retraining a Button
If you want to retrain a programmed button for a new device, you do not have to erase all button memory. You can replace the existing memory code using this procedure.

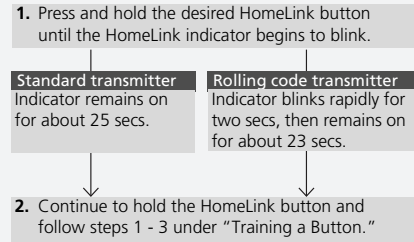

Erasing Codes
To erase all the codes, press and hold the two outside buttons until the HomeLink indicator begins to blink (about 10 to 20 secs). You should erase all codes before selling the vehicle.

If you have any problems, see the device's instructions, visit www.homelink.com, or call HomeLink at (800) 355-3515.

Models with navigation system

For models with the navigation system, see Navigation System Manual for how to operate the *Bluetooth*® HandsFreeLink®.

Models without navigation system

Bluetooth® HandsFreeLink® (HFL) allows you to place and receive phone calls using your vehicle's audio system, without handling your cell phone.

Using HFL

HFL Buttons

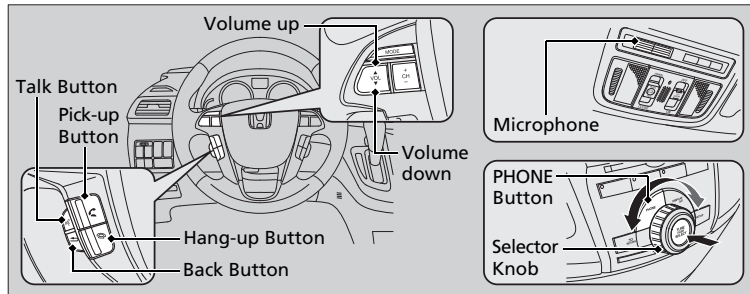



(Pick-up) button: Press to go directly to the **Phone** screen or to answer an incoming call.

(Hang-up) button: Press to end a call.

(Talk) button: Press to call a number with a stored voice tag.

(Back) button: Press to cancel a command.

PHONE button: Press to go directly to the **Phone** screen.

Selector knob: Rotate  to select an item on the screen, then press .

Bluetooth® HandsFreeLink®

To use HFL, you need a *Bluetooth*-compatible cell phone. For a list of compatible phones, pairing procedures, and special feature capabilities:

- U.S.: Visit www.handsfreelink.honda.com, or call (888) 528-7876.
- Canada: Visit www.handsfreelink.ca, or call (888) 528-7876.

Voice control tips

- Aim the vents away from the ceiling and close the windows, as noise coming from them may interfere with the microphone.
- Press and release the  button when you want to call a number using a stored voice tag. Speak clearly and naturally after a beep.
- If the microphone picks up voices other than yours, the command may be misinterpreted.
- To change the volume level, use the audio system's volume knob or the remote audio controls on the steering wheel.

State or local laws may prohibit the operation of handheld electronic devices while operating a vehicle.

HFL Status Display

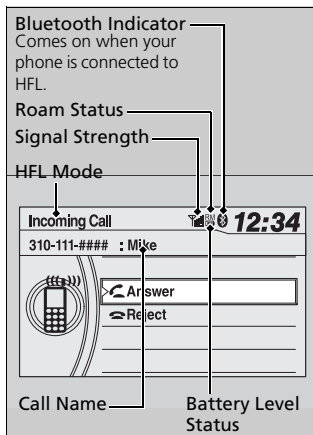

The audio/information screen shows call status and phone information.

Bluetooth® HandsFreeLink®

Bluetooth® Wireless Technology

The *Bluetooth*® word mark and logos are registered trademarks owned by *Bluetooth* SIG, Inc., and any use of such marks by Honda Motors Co., Ltd., is under license. Other trademarks and trade names are those of their respective owners.

HFL Limitations

An incoming call on HFL will interrupt the audio system when it is playing. It will resume when the call is ended.

HFL Status Display

The information that appears on the audio/information screen varies between phone models.

You can change the system language to English, French, or Spanish.

▶ **Customized Features** P. 101

HFL Menus

The ignition switch must be in ACCESSORY **I** or ON **II** to use HFL.

PHONE or 

Phone

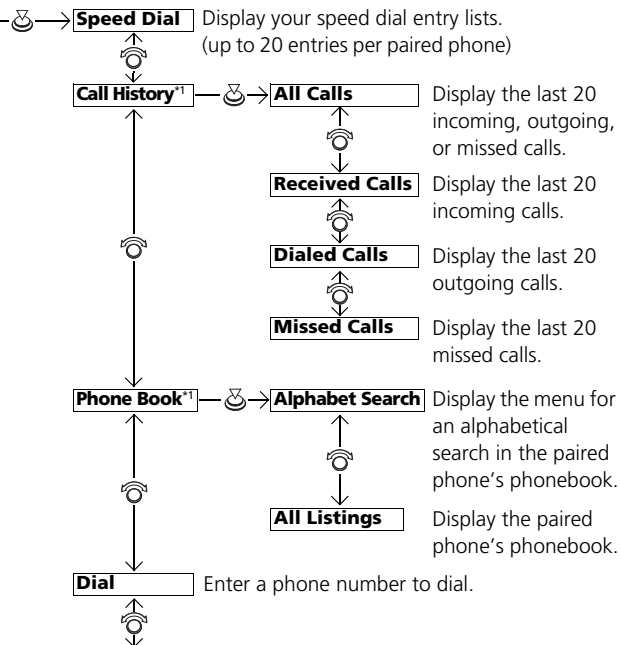

HFL Menus

To use HFL, you must first pair your *Bluetooth*-compatible cell phone to the system while the vehicle is parked.

*1: Appears only when a phone is connected to HFL.

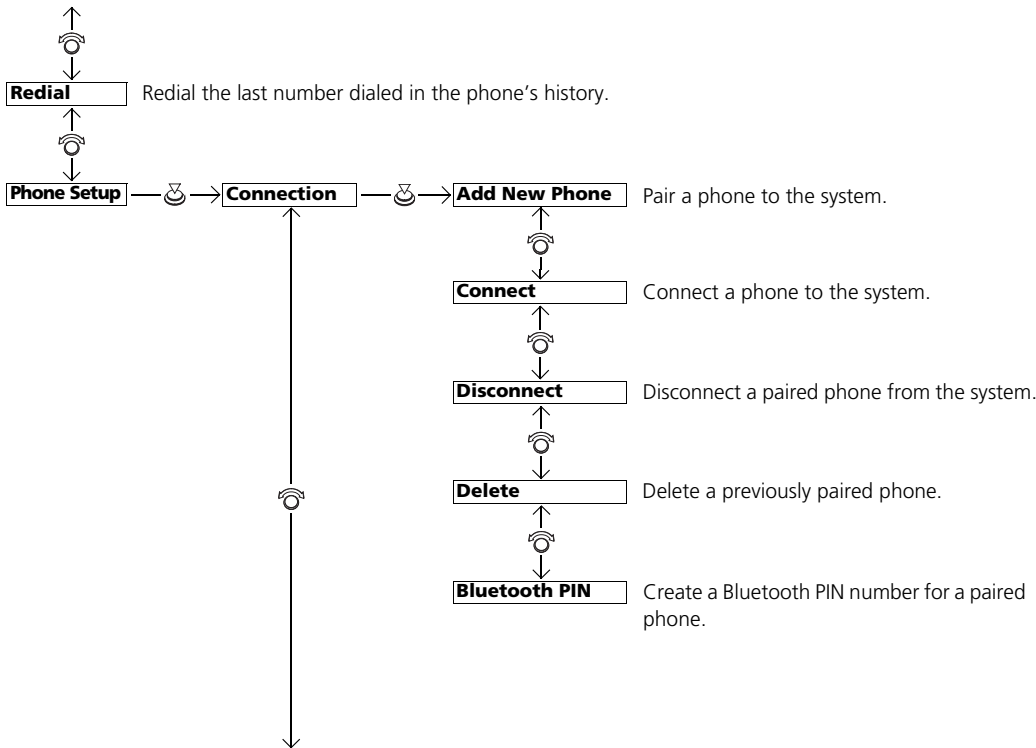

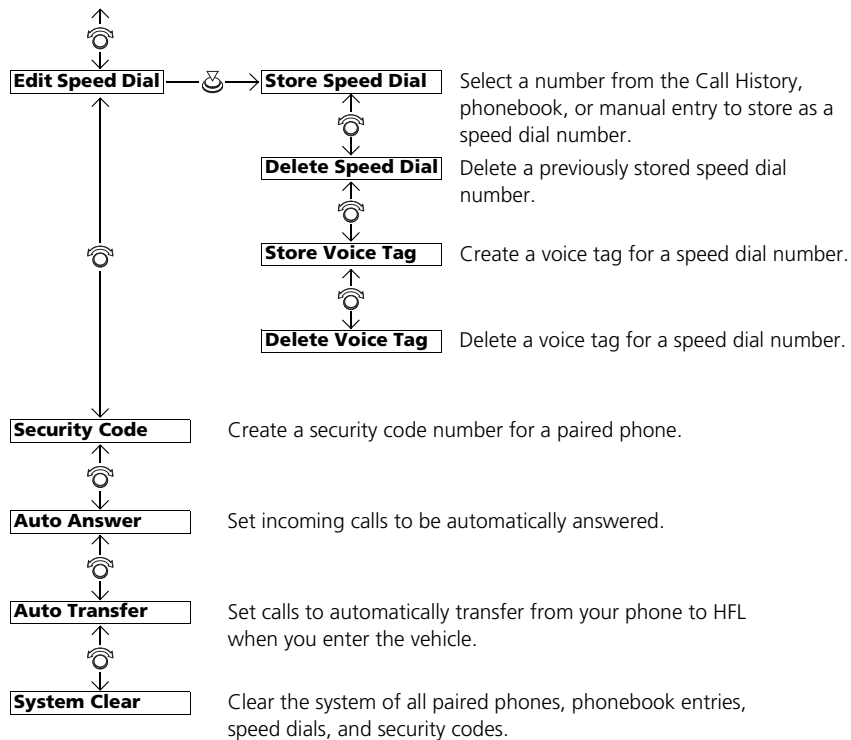

Phone Setup

■ To pair a cell phone (when there is no phone paired to the system)

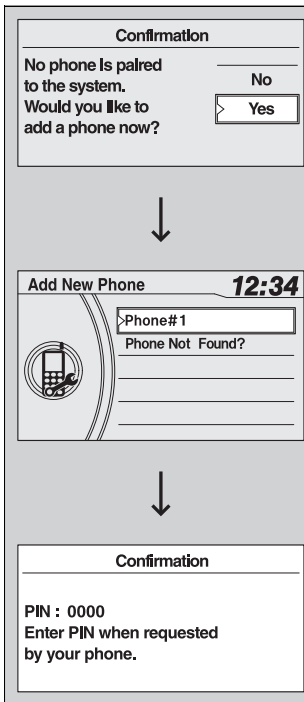

1. Press the **PHONE** button or the button.
2. Rotate to select **Yes**, then press .
3. Make sure your phone is in search or discoverable mode, then press .
 - ▶ HFL automatically searches for a Bluetooth device.

4. When your phone appears on the list, select it by pressing .
 - ▶ If your phone doesn't appear, select **Phone Not Found?** and search for Bluetooth devices using your phone. From your phone, select **HandsFreeLink**.

5. HFL gives you a four-digit pairing code to input on your phone. When your phone prompts you, input the four-digit pairing code.
6. You will receive a notification on the screen if pairing is successful.

» Phone Setup

Your *Bluetooth*-compatible phone must be paired to HFL before you can make and receive hands-free calls.







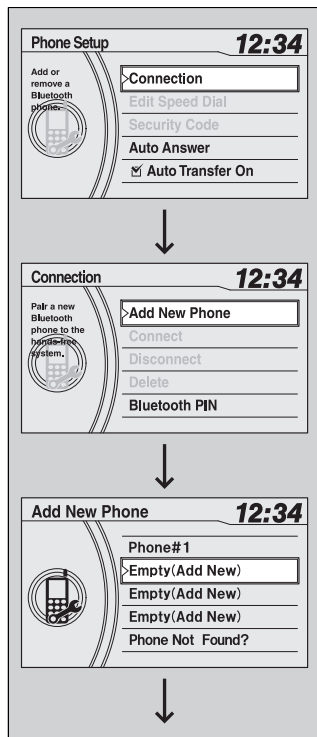

Phone Pairing Tips:

- You cannot pair your phone while the vehicle is moving.
- Up to six phones can be paired.
- Your phone's battery may drain faster when it is paired to HFL.
- If your phone is not ready for pairing or not found by the system within three minutes, the system will time out and returns to idle.

Continued

■ To pair a cell phone (when a phone has already been paired to the system)



1. Press the **PHONE** button or the  button.
2. Rotate  to select **Phone Setup**, then press .
3. Rotate  to select **Connection**, then press .
4. Rotate  to select **Add New Phone**, then press .
5. Rotate  to select **Empty (Add New)**, then press .

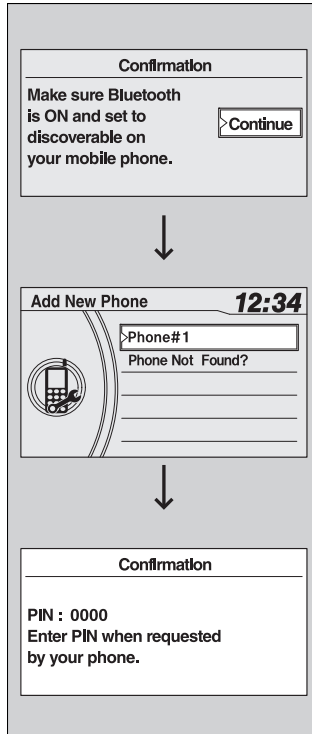

6. Make sure your phone is in search or discoverable mode, then press .
 - ▶ HFL automatically searches for a Bluetooth device.

7. When your phone appears on the list, select it by pressing .
 - ▶ If your phone doesn't appear, select **Phone Not Found?** and search for Bluetooth devices using your phone. From your phone, select **HandsFreeLink**.

8. HFL gives you a four-digit pairing code to input on your phone. When your phone prompts you, input the four-digit pairing code.
9. You will receive a notification on the screen if pairing is successful.

Continued

■ To change the *Bluetooth* PIN setting

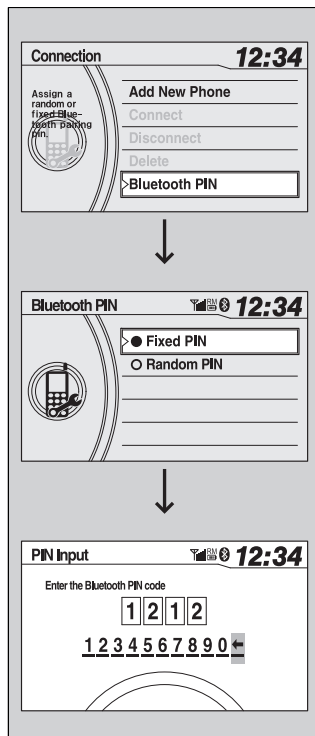

1. Press the **PHONE** button or the button.
 - ▶ Rotate to select **Phone Setup**, then press .
2. Rotate to select **Connection**, then press .
3. Rotate to select **Bluetooth PIN**, then press .
4. Rotate to select **Fixed PIN** or **Random PIN**, then press .
5. If you select **Fixed PIN**, enter a new Bluetooth PIN.
 - ▶ Rotate to select, then press . Rotate to select , then press to delete.

▶ To change the pairing code setting





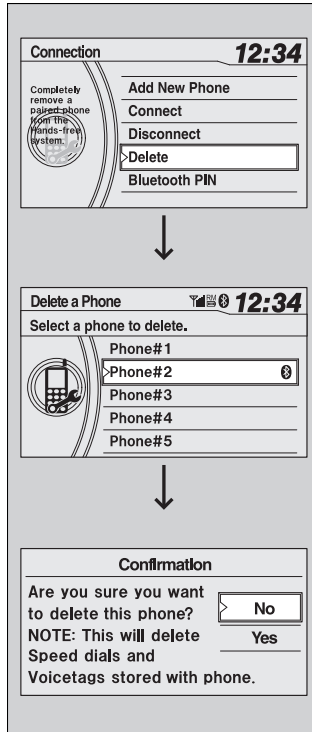

The default pairing code is **0000** until you change the setting.

To create your own, select **Fixed**, and delete the current code, then enter a new one.

For a randomly generated pairing code each time you pair a phone, select **Random**.

■ To delete a paired phone



1. Press the **PHONE** button or the  button.
2. Rotate  to select **Phone Setup**, then press .
 - ▶ Repeat the procedure to select **Connection**, then **Delete**.
3. Rotate  to select a phone you want to delete, then press .
 - ▶ The *Bluetooth* icon indicates the currently linked phone.
4. You will receive a confirmation message on the screen. Rotate  to select **Yes**, then press .
 - ▶ You will receive a notification on the screen if it is successful.

Continued

■ To Create a Security Code

You can protect each of the six cell phones with a security PIN.

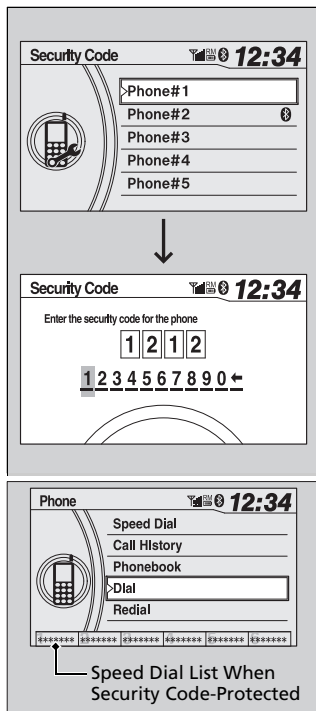

1. Press the **PHONE** button or the button.
2. Rotate to select **Phone Setup**, then press .
 - ▶ Repeat the procedure to select **Security Code**.
3. Select a phone you want to add a security code to.
 - ▶ Rotate to select a phone you want to add a security code to, then press .
4. Enter a new four-digit number.
 - ▶ Rotate to select, then press .
 - ▶ Rotate to select , then press to delete.

If the phone name you selected is security code protected the speed dial list becomes
*****.

▶▶ To Create a Security Code

If the phone is already security code protected, you need to enter the current security code before clearing the code or creating a new one.

Automatic Answering

You can choose when the HFL system automatically answers incoming calls.

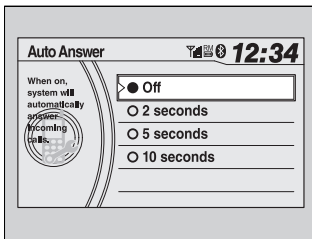

1. Press the **PHONE** button or the button.
2. Rotate to select **Phone Setup**, then press .
 - ▶ Repeat the procedure to select **Auto Answer**.
3. Rotate to select a mode you want, then press .

Automatic Transferring

If you get into the vehicle while you are on the phone, the call can be automatically transferred to HFL.

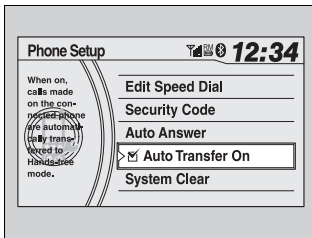



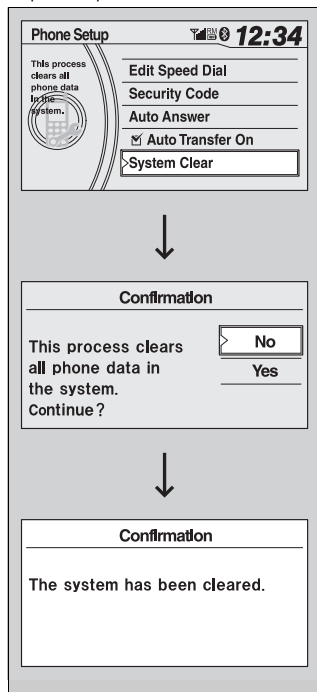

1. Press the **PHONE** button or the button.
2. Rotate to select **Phone Setup**, then press .
 - ▶ Repeat the procedure to select **Auto Transfer**.
3. Press to select On or Off.
 - ▶ The check box is checked when **Auto Transfer On** is selected. Select **Auto Transfer On** again to turn it off.

■ To Clear the System

Security codes, paired phones, all stored voice tags, all speed dial entries, and all imported phonebook data are erased.



1. Press the **PHONE** button or the  button.
2. Rotate  to select **Phone Setup**, then press .
 - ▶ Repeat the procedure to select **System Clear**.
3. You will receive a notification message on the screen. Rotate  to select **Yes**, then press .
4. You will receive a confirmation message on the screen.

Automatic Import of Cellular Phonebook and Call History

When your phone is paired, the contents of its phonebook and call history are automatically imported to HFL.

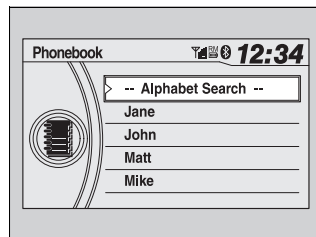

Automatic Import of Cellular Phonebook and Call History

When you select a person from the list in the cellular phonebook, you can see up to three category icons. The icons indicate what types of numbers are stored for that name.

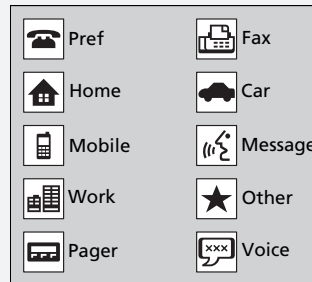

If a name has four or more numbers, ... appears instead of category icons.

On some phones, it may not be possible to import the category icons to HFL.







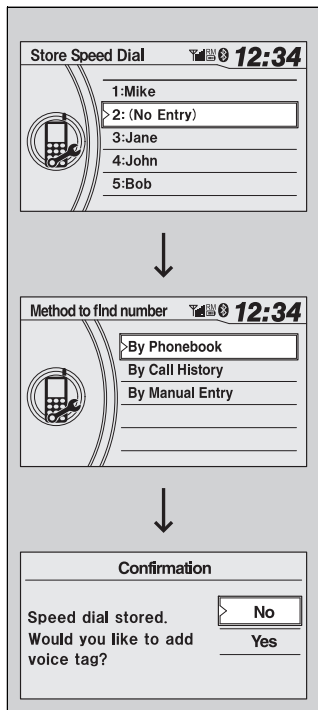



The phonebook is updated after every connection. Call history is updated after every connection or call.

Speed Dial

Up to 20 speed dial numbers can be stored per phone.



To store a speed dial number:

1. Press the **PHONE** button or the  button.
2. Rotate  to select **Phone Setup**, then press .
 - ▶ Repeat the procedure to select **Edit Speed Dial**, then **Store Speed Dial**.
3. Rotate  to select **No Entry**, then press .
4. Rotate  to select a place to choose a number from, then press .
 - By Phonebook:
 - ▶ Select a number from the linked cell phone's imported phonebook.
 - By Call History:
 - ▶ Select a number from the call history.
 - By Manual Entry:
 - ▶ Input the number manually.
5. When the speed dial is successfully stored, you are asked to create a voice tag for the number. Rotate  to select **Yes** or **No**, then press .
6. Using the  button, follow the prompts to say the name for the speed dial entry.

■ To add a voice tag to a stored speed dial number

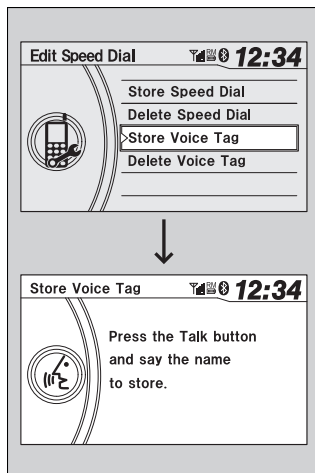





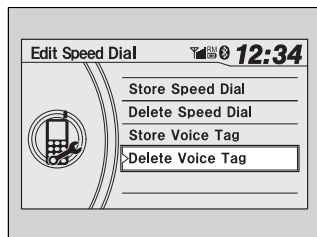

1. Press the **PHONE** button or the button.
2. Rotate to select **Phone Setup**, then press .
- ▶ Repeat the procedure to select **Edit Speed Dial**.
3. Select an existing speed dial entry.
4. Rotate to select **Store Voice Tag**, then press .
5. Using the button, follow the prompts to complete the voice tag.

» Speed Dial

Avoid using duplicate voice tags. Avoid using “home” as a voice tag. It is easier for HFL to recognize a longer name. For example, use “John Smith” instead of “John.”





■ To delete a voice tag

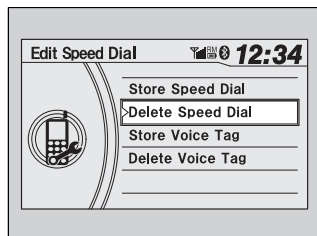

1. Press the **PHONE** button or the  button.
2. Rotate  to select **Phone Setup**, then press .
 - ▶ Repeat the procedure to select **Edit Speed Dial**.
3. Select an existing speed dial entry.
4. Rotate  to select **Delete Voice Tag**, then press .
5. You will receive a confirmation message on the screen.

■ To delete a speed dial number



1. Press the **PHONE** button or the  button.
2. Rotate  to select **Phone Setup**, then press .
 - ▶ Repeat the procedure to select **Edit Speed Dial**.
3. Select an existing speed dial entry.
4. Rotate  to select **Delete Speed Dial**, then press .
5. You will receive a confirmation message on the screen.

Making a Call

You can make calls by inputting any phone number, or by using the imported phonebook, call history, speed dial entries, or redial.

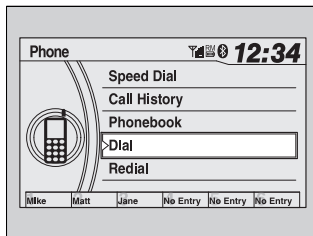

▶▶ Making a Call

Any voice-tagged speed dial entry can be dialed by voice from any screen.

Press the  button and follow the prompts.

The maximum range between your phone and vehicles is 30 feet (10 meters).







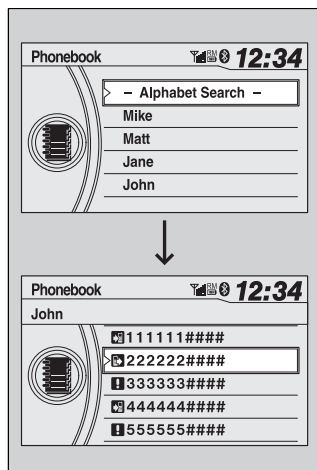

Once a call is connected, you can hear the voice of the person you are calling through the audio speakers.

Continued

■ To make a call using the imported phonebook

When your phone is paired, the contents of its phonebook are automatically imported to HFL.



1. Press the **PHONE** button or the  button.
2. Rotate  to select **Phonebook**, then press .
3. The phonebook is stored alphabetically. Rotate  to select the initial, then press .
4. Rotate  to select a name, then press .
5. Rotate  to select a number, then press .
 - ▶ Dialing starts automatically.

■ To make a call using a phone number

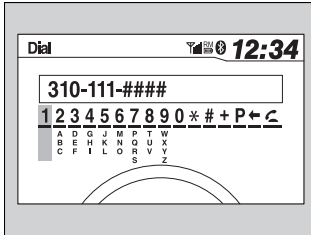

1. Press the **PHONE** button or the button.
2. Rotate to select **Dial**, then press .
3. Rotate to select a number, then press .
4. Rotate to select , then press .
 - ▶ Dialing starts automatically.

■ To make a call using redial

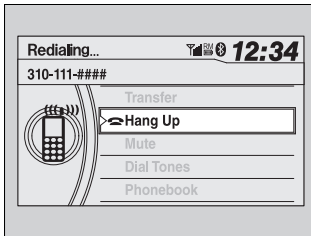

1. Press the **PHONE** button or the button.
2. Rotate to select **Redial**, then press .
 - ▶ Dialing starts automatically.

▶▶ To make a call using redial

Press and hold the button to redial the last number dialed in your phone's history.

■ To make a call using the call history

Call history is stored by **All Calls**, **Dialed Calls**, **Received Calls**, and **Missed Calls**.

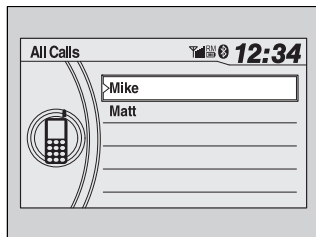

1. Press the **PHONE** button or the button.
2. Rotate to select **Call History**, then press .
3. Rotate to select **All Calls**, **Dialed Calls**, **Received Calls**, or **Missed Calls**, then press .
4. Rotate to select a number, then press .
 - ▶ Dialing starts automatically.

■ To make a call using a speed dial entry

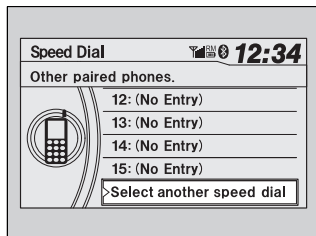

1. Press the **PHONE** button or the button.
2. Rotate to select **Speed Dial**, then press .
3. Rotate to select a paired number, then press .
 - ▶ Dialing starts automatically.

☒ To make a call using the call history

The call history displays the last 20 dialed, received, or missed calls.
(Appears only when a phone is connected to HFL.)

Some phones do not support **All Calls**.

☒ To make a call using a speed dial entry

On the **Phone** screen, the first six speed dials on the list can be directly selected by pressing the corresponding audio preset buttons (1-6).

Select **Select another speed dial** to view another paired phone's speed dial list.

You can make a call from that list using the currently connected phone.

Any voice-tagged speed dial entry can be dialed by voice from any screen. Press the button and follow the prompts.

Receiving a Call

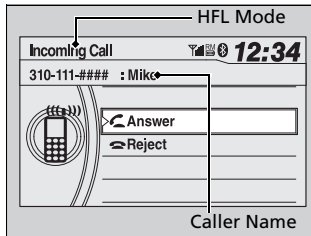

When there is an incoming call, an audible notification sounds (if activated) and the Incoming Call screen appears.

Press the  button to answer the call.

Press the  button to decline or end the call.

Receiving a Call

Call Waiting.

Press the  button to put the current call on hold to answer the incoming call.

Press the  button again to return to the current call.

Ignore the incoming call if you do not want to answer it.

Press the  button if you want to hang up the current call.

Options During a Call



The following options are available during a call.

Mute: Mute your voice.

Transfer: Transfer a call from HFL to your phone.

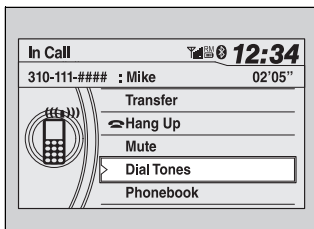
Dial Tones: Send numbers during a call. This is useful when you call an automated phone system.



1. To view the available options, press the **PHONE** button.
2. Rotate  to select the option, then press .

Options During a Call



Dial Tones: Available on some phones.

When you turn the ignition switch to ON **(II)**, the compass self-calibrates, and the compass display appears.

Compass Calibration

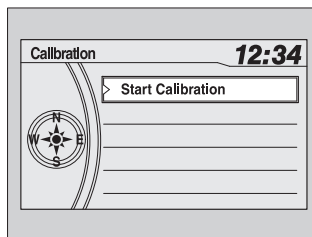
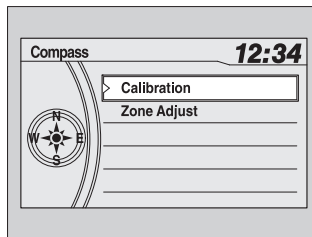
If the compass indicates the wrong direction, or the compass display blinks, you need to manually calibrate the system.



1. Turn the ignition switch to ON **(II)**.
2. Press and hold the **SETUP** button until the display shows the compass setting menu list.
3. Rotate  to select **Calibration**, then press .
4. When the display changes to **Start Calibration**, press .
5. Drive the vehicle slowly in two circles.
 - ▶ The compass starts to show a direction after the calibration. The CAL indicator goes off.

Compass*

Compass calibration can be affected under the following conditions:

- Driving near power lines or stations
- Crossing a bridge
- Passing a large vehicle, or driving near a large object that can cause a magnetic disturbance
- When accessories such as antennas and roof racks are mounted by magnets

Compass Calibration





Calibrate the compass in an open area.

While setting the compass:

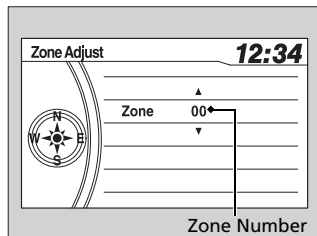
- The RETURN button returns to the previous screen.
- The SETUP button cancels the setting mode.

Compass Zone Selection



1. Turn the ignition switch to ON .
2. Press and hold the **SETUP** button until the display shows the compass setting menu list.
3. Rotate  to select **Zone Adjust**, then press . The display shows the current zone number.
4. Rotate  to select the zone number of your area (See Zone Map), then press .

Zone Map

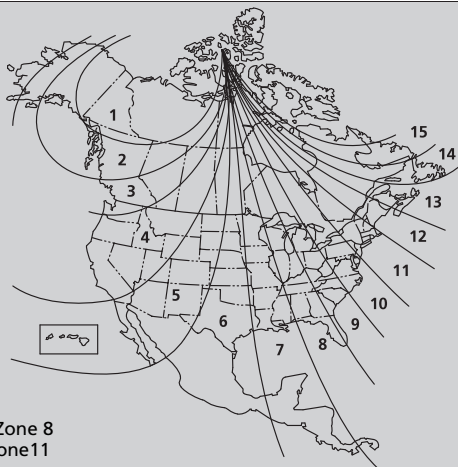

Guam Island: Zone 8
Puerto Rico: Zone 11

Compass Zone Selection

The zone selection is done to compensate the variation between magnetic north and true north.

If the calibration starts while the audio system is in use, the display returns to normal after the calibration is completed,



Driving

This chapter discusses driving, refueling, and information on items such as accessories.

Before Driving

Driving Preparation	280
Maximum Load Limit.....	283

Towing a Trailer

Towing Preparation.....	285
Driving Safely with a Trailer.....	289
Towing Your Vehicle.....	290

When Driving

Starting the Engine	291
Precautions While Driving.....	293
Automatic Transmission	294
Shifting.....	295

Cruise Control	297
VSA® (Vehicle Stability Assist), aka ESC (Electronic Stability Control), System	300
TPMS (Tire Pressure Monitoring System).....	302
Tire Pressure Monitoring System (TPMS) - Required Federal Explanation	303
BSI (Blind Spot Information) System*	306

Braking

Brake System	308
ABS (Anti-lock Brake System)	310
Brake Assist System.....	311

Parking Your Vehicle

When Stopped	312
Parking Sensor System*	313

Rearview Camera

.....	317
-------	-----

Refueling

Fuel Information	318
How to Refuel	319

Fuel Economy

Improving Fuel Economy	321
------------------------------	-----

Accessories and Modifications

Accessories	322
Modifications.....	322

* Not available on all models

Driving Preparation

Check the following items before you start driving.

Exterior Checks

- Make sure there are no obstructions on the windows, door mirrors, exterior lights, or other parts of the vehicle.
 - ▶ Remove any frost, snow, or ice.
 - ▶ Remove any snow on the roof, as this can slip down and obstruct your field of vision while driving. If frozen solid, remove ice once it has softened.
 - ▶ When removing ice from around the wheels, be sure not to damage the wheel or wheel components.
- Make sure the hood is securely closed.
 - ▶ If the hood opens while driving, your front view will be blocked.
- Make sure the tires are in good condition.
 - ▶ Check air pressure, and check for damage and excessive wear.
 - ▶ **Checking and Maintaining Tires** P. 362
- Make sure there are no people or objects behind or around the vehicle.
 - ▶ There are blind spots from the inside.

Exterior Checks

NOTICE

When doors are frozen shut, use warm water around the door edges to melt any ice. Do not try to force them open, as this can damage the rubber trim around the doors. When done, wipe dry to avoid further freezing.

Do not pour warm water into the key cylinder. You will be unable to insert key if the water freezes in the hole.

Heat from the engine and exhaust can ignite flammable materials left under the hood, causing a fire. If you've parked your vehicle for an extended period, inspect and remove any debris that may have collected, such as dried grass and leaves that have fallen or have been carried in for use as a nest by a small animal.

Also check under the hood for leftover flammable materials after you or someone else has performed maintenance on your vehicle.

Interior Checks

- Store or secure all items on board properly.
 - ▶ Carrying too much cargo, or improperly storing it, can affect your vehicle's handling, stability, stopping distance, and tires, and make it unsafe.
 - ✎ **Maximum Load Limit** P. 283
- Do not pile items higher than the seat height.
 - ▶ They can block your view and may be thrown forward in the event of sudden braking.
- Do not place anything in the front seat footwells. Make sure to secure the floor mat.
 - ▶ An object or unsecured floor mat can interfere with your brake and accelerator pedal operation while driving.
- If you have any animals on board, do not let them move around in the vehicle.
 - ▶ They may interfere with driving and a crash could occur.
- Securely close and lock all doors and the tailgate.
 - ✎ **Locking/Unlocking the Doors from the Inside** P. 113
- Adjust your seating position properly.
 - ▶ Adjust the head restraint, too.
 - ✎ **Adjusting the Seats** P. 153
 - ✎ **Adjusting the Head Restraints** P. 156
- Adjust the mirrors and steering wheel properly for your driving.
 - ▶ Adjust them while sitting in the proper driving position.
 - ✎ **Adjusting the Mirrors** P. 151
 - ✎ **Adjusting the Steering Wheel** P. 150

Interior Checks

The headlight aim is set by the factory, and does not need to be adjusted. However, if you regularly carry heavy items in the cargo area or tow a trailer, have the aiming readjusted at a dealer or by a qualified technician.

- Be sure items placed on the floor behind the front seats cannot roll under the seats.
 - They can interfere with the driver's ability to operate the pedals, the operation of the seats, or the operation of the sensors under the seats.
- Everyone in the vehicle must fasten their seat belt.
 - **Fastening a Seat Belt** P. 33
- Make sure that the indicators in the instrument panel come on when you start the vehicle, and go off soon after.
 - Always have a dealer check the vehicle if a problem is indicated.
 - **Indicators** P. 72

Maximum Load Limit

The maximum load for your vehicle is 1,340 lbs (608 kg).
See Tire and Loading Information label attached to the driver's doorjamb.

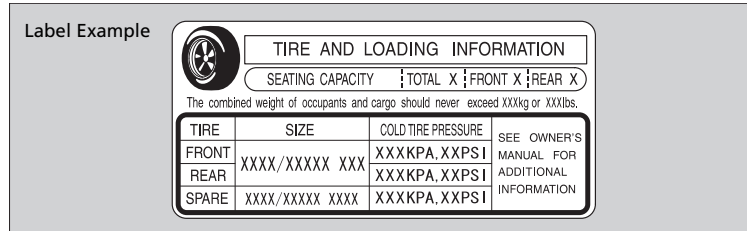

This figure includes the total weight of all occupants, cargo, and accessories, and the tongue load if you are towing a trailer.
Steps for Determining Correct Load Limit -

- (1) Locate the statement "The combined weight of occupants and cargo should never exceed XXX kg or XXX lbs." on your vehicle's placard.
- (2) Determine the combined weight of the driver and passengers that will be riding in your vehicle.
- (3) Subtract the combined weight of the driver and passengers from XXX kg or XXX lbs.
- (4) The resulting figure equals the available amount of cargo and luggage load capacity. For example, if the "XXX" amount equals 1,400 lbs. and there will be five 150 lb. passengers in your vehicle, the amount of available cargo and luggage load capacity is 650 lbs.
(1,400 - 750 (5 x 150) = 650 lbs.)

Continued

Maximum Load Limit

⚠ WARNING

Overloading or improper loading can affect handling and stability and cause a crash in which you can be hurt or killed.

Follow all load limits and other loading guidelines in this manual.

Gross Vehicle Weight Rating (GVWR):

The maximum allowable weight of the vehicle, all occupants, all accessories, all cargo, and the tongue load.

▶ Specifications P. 412

Gross Axle Weight Rating (GAWR):

The maximum allowable weight of the vehicle axle.

▶ Specifications P. 412

- (5) Determine the combined weight of luggage and cargo being loaded on the vehicle. That weight may not safely exceed the available cargo and luggage load capacity calculated in step 4.
- (6) If your vehicle will be towing a trailer, load from your trailer will be transferred to your vehicle. Consult this manual to determine how this reduces the available cargo and luggage load capacity of your vehicle.

In addition, the total weight of the vehicle, all occupants, accessories, cargo, and trailer tongue load must not exceed the Gross Vehicle Weight Rating (GVWR) or the Gross Axle Weight Rating (GAWR). Both are on a label on the driver's doorjamb.

Load Limits Example

Example 1

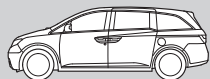

Max Load
1,340 lbs
(608 kg)



Passenger Weight
 $150 \text{ lbs} \times 2 = 300 \text{ lbs}$
 $(68 \text{ kg} \times 2 = 136 \text{ kg})$



Cargo Weight
1,040 lbs
(472 kg)

Example 2

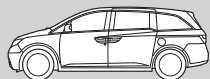

Max Load
1,340 lbs
(608 kg)



Passenger Weight
 $150 \text{ lbs} \times 5 = 750 \text{ lbs}$
 $(68 \text{ kg} \times 5 = 340 \text{ kg})$



Cargo Weight
590 lbs
(268 kg)

Towing Preparation

Towing Load Limits

Your vehicle can tow a trailer if you carefully observe the load limits, use the proper equipment, and follow the towing guidelines. Check the load limits before driving.

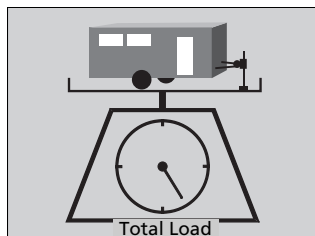

■ Total trailer weight

Do not exceed the maximum allowable weight of the trailer, cargo, and everything in or on it shown in the table.

Towing loads in excess of this can seriously affect vehicle handling and performance and can damage the engine and drivetrain.

Number of occupants	Equip with ATF cooler
2	3,500 lbs (1,587 kg)
3	3,350 lbs (1,520 kg)
4	3,200 lbs (1,451 kg)
5	3,050 lbs (1,383 kg)
6	2,900 lbs (1,315 kg)
7	1,450 lbs (658 kg)
8	Towing not recommended

Each weight limit is calculated based on the following conditions:

- Occupants fill seats from the front of the vehicle to the back
- Each occupant weighs 150 lbs (68 kg)
- Each occupant has 15 lbs (7 kg) of cargo in the cargo area

Any additional weight, cargo or accessories reduce the maximum trailer weight and maximum tongue load.

» Towing Load Limits

⚠ WARNING

Exceeding any load limit or improperly loading your vehicle and trailer can cause a crash in which you can be seriously hurt or killed.

Check the loading of your vehicle and trailer carefully before starting to drive.

Check if all loads are within limits at a public scale. If a public scale is not available, add the estimated weight of your cargo load to the weight of your trailer (as quoted by the manufacturer), and the tongue load.

Break-in Period

Avoid towing a trailer during your vehicle's first 600 miles (1,000 km).

Never exceed the gross weight ratings. Gross weight information

➤ **Vehicle Specifications** P. 412

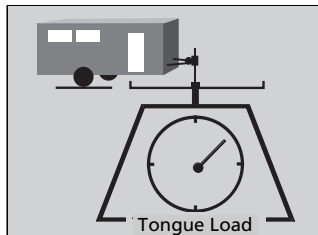

■ Tongue load

The weight of the tongue with a fully loaded trailer on the hitch should be approximately 10% of the total trailer weight.

- Excessive tongue load reduces front tire traction and steering control. Too little tongue load can make the trailer unstable and cause it to sway.
- To achieve a proper tongue load, start by loading 60% of the load toward the front of the trailer and 40% toward the rear. Readjust the load as needed.

■ Towing Equipment and Accessories

■ Hitches

The hitch must be of an approved type and properly bolted to the underbody.

■ Weight distribution hitches

A weight distributing hitch is not recommended for use with your vehicle. An improperly adjusted weight distributing hitch may reduce handling, stability, and braking performance.

■ Safety chains

Always use safety chains when you tow a trailer. Leave enough slack to allow the trailer to turn corners easily, but do not allow the chains to drag on the ground.

☒ Towing Equipment and Accessories

Make sure that all equipment is properly installed and maintained, and that it meets federal, state, province/territory, and local regulations.

Consult your trailer sales or rental agency if any other items are recommended or required for your towing situation.

The lighting and wiring of trailers can vary by type and brand. If a connector is required, it should only be installed by a qualified technician.

■ Trailer brakes

Recommended for any trailer with a total weight of 1,000 lbs (450 kg) or more: There are two common types of trailer brakes: surge and electric. Surge brakes are common for boat trailers, since the brakes will get wet. If you choose electric brakes, be sure they are electronically actuated. Do not attempt to attach trailer brakes to your vehicle's hydraulic system, as it will lower braking effectiveness and create a potential hazard.

■ Trailer light

Trailer lights and equipment must comply with federal, state, province/territory, and local regulations. Check with your local trailer sales or rental agency for the requirements in the area where you plan to tow.

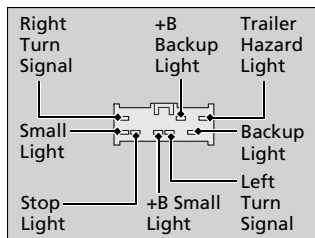

Your trailer lighting connector is located behind the left side panel in the cargo area. Each pin's purpose and wiring color code are shown in the image.

When using non-Honda trailer lighting harness and converter, get the connector and pins for your vehicle from a dealer.

■ Sway control

Recommended to use if your trailer tends to sway. Consult the trailer maker for what kind of sway control you need and how to install it.

■ **Automatic transmission cooler**

Install an additional ATF (automatic transmission fluid) cooler to help prevent the transmission from overheating, and damaging. You can get the additional ATF cooler at a dealer.

■ **Trailer mirrors**

Many states, provinces and territories require special exterior mirrors when towing a trailer. Install special mirrors whenever you cannot clearly see behind you, or if the trailer creates a blind spot.

Driving Safely with a Trailer

■ Things You Need To Know Before Towing a Trailer

- Have the trailer properly serviced and keep it in good condition.
- Make sure that all the weights and load in the vehicle and trailer are within limits.
 - ▶ **Towing Load Limits** P. 285
- Securely attach the hitch, safety chains, and other necessary parts to the trailer.
- Securely store all the items in and on the trailer so that they do not shift while driving.
- Check if the lights and brakes on the trailer are working properly.
- Check the pressure of the trailer tires, including the spare.

■ Towing Speeds and Gears

- Drive slower than normal.
- Obey posted speed limits for vehicles with trailer.
- Use the **[D]** when towing a trailer on level roads.

■ Turning and Braking

- Turn more slowly and with a wider turning arc than normal.
- Allow more time and distance for braking.
- Do not brake or turn suddenly.

▶▶ Driving Safely with a Trailer

Parking

In addition to the normal precautions, place wheel chocks at each of the trailer's tires.

When towing a trailer, we recommend that you carry a full-size spare wheel and tire for your vehicle and trailer. If you use the compact spare tire that came with your vehicle, it could adversely affect vehicle handling.

▶ **Specifications** P. 413

▶ **Changing a Flat Tire** P. 383

Remember to unhitch the trailer before changing a flat tire. Ask the trailer sales or rental agency where and how to store the trailer's spare tire.

■ Driving in Hilly Terrain

- Monitor your temperature gauge. If it nears the red (Hot) mark, turn off the heating and cooling system*/climate control system* and reduce speed. Pull to the side of the road safely to cool down the engine if necessary.
- Shift to the **D3** or **D4** position (depending on models) if the transmission shifts frequently.

Towing Your Vehicle

Your vehicle is not designed to be towed behind a motor home. If your vehicle needs to be towed in an emergency, refer to the emergency towing information.

📄 **Emergency Towing** P. 409

Starting the Engine

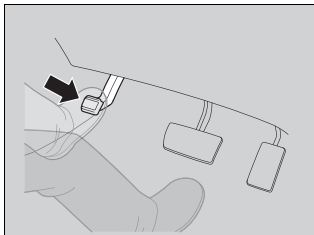

1. Make sure the parking brake is applied.

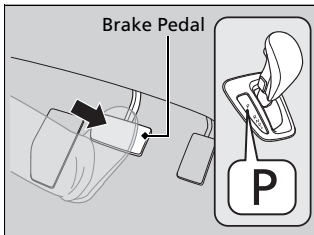

2. Check that the shift lever is in **P**, then depress the brake pedal.

▶ Although it is possible to start the vehicle in **N**, it is safer to start it in **P**.

Starting the Engine

Keep your foot firmly on the brake pedal when starting the engine.

The engine is harder to start in cold weather and in thinner air found at altitudes above 8,000 feet (2,400 meters).

When starting the engine in cold weather, turn off all electrical accessories such as the lights, heating and cooling system*/climate control system*, and rear defogger in order to reduce battery drain.

If you live in a region where winter is extremely cold, an engine block heater will improve starting and warming of the engine. If temperatures consistently below -22°F (-30°C) are expected, the coolant mixture should be charged to a higher concentration to prevent freezing. Consult a dealer for details.

If the exhaust system sounds abnormal or you can smell exhaust gas inside the vehicle, have your vehicle checked by a dealer. There may be a problem with the engine or exhaust system.

* Not available on all models

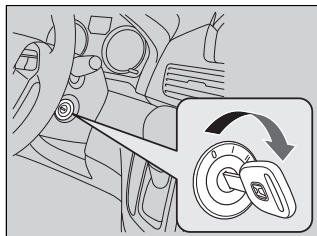

3. Turn the ignition switch to START **[III]** without depressing the accelerator pedal.

Starting to Drive

1. Keeping your right foot on the brake pedal, release the parking brake. Check that the parking brake indicator has gone off.
 ▶ **Parking Brake** P. 308
2. Put the shift lever in **[D]**. Select **[R]** when reversing.
3. Gradually release the brake pedal and gently depress the accelerator pedal to pull away.

Starting the Engine

Do not hold the key in START **[III]** for more than 15 seconds.

- If the engine does not start right away, wait for at least 10 seconds before trying again.
- If the engine starts, but then immediately stops, wait at least 10 seconds before repeating step 3 while gently depressing the accelerator pedal. Release the accelerator pedal once the engine starts.

The immobilizer system protects your vehicle from theft. If an improperly coded key (or other device) is used, the engine's fuel system is disabled.

▶ **Immobilizer System** P. 133

Precautions While Driving

In Rain

Avoid driving in deep water and on flooded roads. This can damage the engine or driveline, or cause electrical component failure.

Other Precautions

If there is a strong impact with something under the vehicle, stop in a safe location. Check the underside of the vehicle for damage or any fluid leaks.

»» Precautions While Driving

NOTICE

Do not operate the shift lever while pressing the accelerator pedal. You could damage the transmission.

If the ignition switch is turned to ACCESSORY [I] or LOCK [0] while driving, the engine will shut down and all steering and brake power assist functions will stop, making it difficult to control the vehicle.

Do not put the shift lever in [N], as you will lose engine braking (and acceleration) performance.

During the first 600 miles (1,000 km) of operation, avoid sudden acceleration or full throttle operation so as to not damage the engine or powertrain.

Avoid hard braking for the first 200 miles (300 km). You should also follow this when the brake pads are replaced.

Automatic Transmission

■ Creeping

The engine runs at a higher idle speed and creeping increases. Keep the brake pedal firmly depressed when stopped.

■ Kickdown

Quickly depressing the accelerator pedal while driving uphill may cause the transmission to drop to a lower gear, unexpectedly increasing vehicle speed. Depress the accelerator pedal carefully, especially on slippery roads and curves.

Shifting

Change the shift position in accordance with your driving needs.

■ Shift lever positions

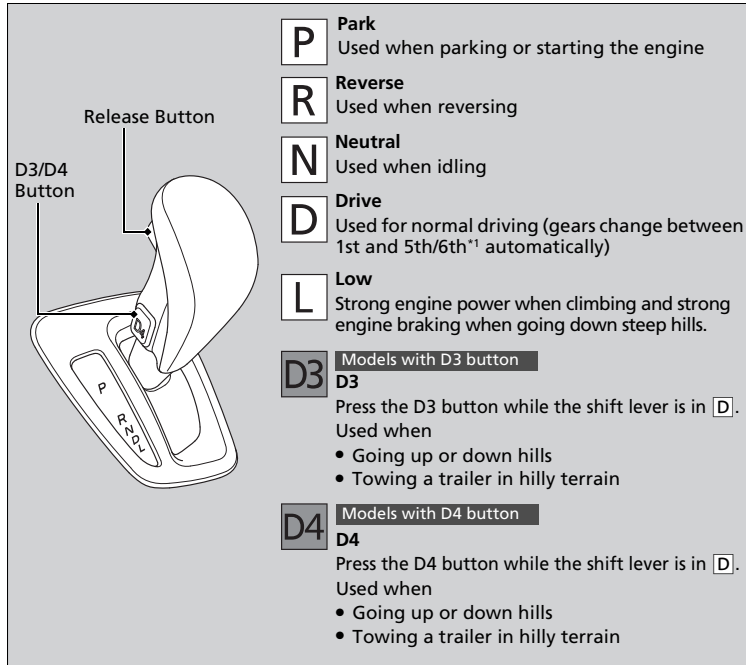

- P** **Park**
Used when parking or starting the engine
- R** **Reverse**
Used when reversing
- N** **Neutral**
Used when idling
- D** **Drive**
Used for normal driving (gears change between 1st and 5th/6th*1 automatically)
- L** **Low**
Strong engine power when climbing and strong engine braking when going down steep hills.
- D3** **Models with D3 button**
D3
Press the D3 button while the shift lever is in **D**.
Used when
 - Going up or down hills
 - Towing a trailer in hilly terrain
- D4** **Models with D4 button**
D4
Press the D4 button while the shift lever is in **D**.
Used when
 - Going up or down hills
 - Towing a trailer in hilly terrain

*1: Models with D4 button

▶▶ Shifting

You cannot turn the ignition switch to LOCK **[0]** and remove the key unless the shift lever is in **[P]**.

The vehicle may move forward very slightly even in **[N]** while the engine is cold. Depress the brake pedal firmly and, when necessary, apply the parking brake.

Shift Lever Operation

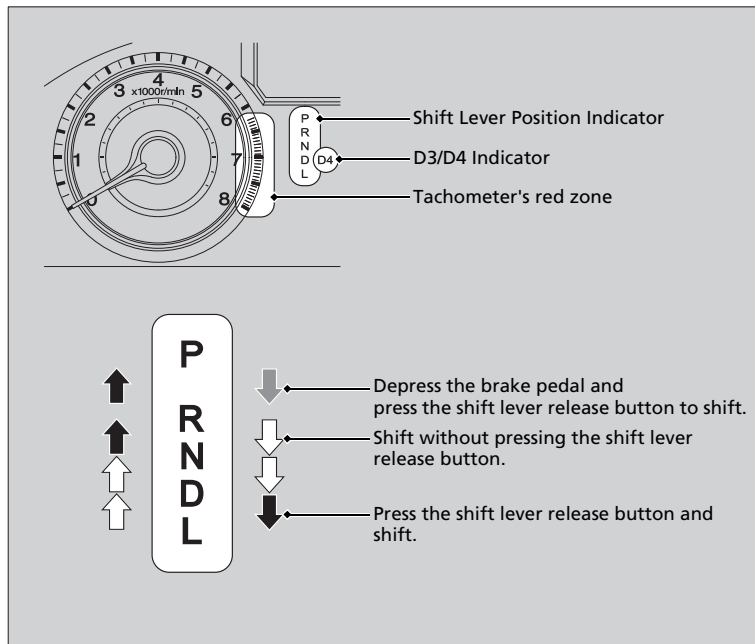

Shift Lever Operation

NOTICE

When you change the shift lever from **[D]** to **[R]** and vice versa, come to a complete stop and keep the brake pedal depressed. Operating the shift lever before the vehicle has come to a complete standstill can damage the transmission.

Use the shift lever position indicator to check the lever position before pulling away.

Whichever position the shift lever is in when driving, a blinking **[D]** indicator indicates a transmission problem. Avoid sudden acceleration and have the transmission checked by a dealer as soon as possible.

The fuel supply may be cut off if you drive at engine speeds in or over the tachometer's red zone (engine speed limit). If this happens, you may experience a slight jolt.

It may not be possible to operate the shift lever if the brake pedal is applied while the shift lever release button is held down. Depress the brake pedal first.

Cruise Control

Maintains a constant vehicle speed without having to keep your foot on the accelerator. Use cruise control on freeways or open roads where you can travel at a constant speed with little acceleration or deceleration.

When to use

- **Vehicle speed for cruise control:**
Desired speed in a range above roughly 25 mph (40 km/h) ~
- **Shift positions for cruise control:**
In **D**, **D3** or **D4** (depending on models)

Always keep sufficient distance between you and the vehicle in front of you.



How to use

- Press the **CRUISE** button on the steering wheel.

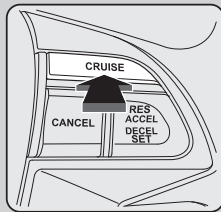

CRUISE MAIN is on in the instrument panel.
Cruise control is ready to use.

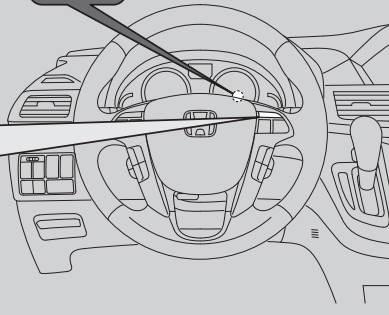

⌘ Cruise Control

⚠ WARNING

Improper use of the cruise control can lead to a crash.

Use the cruise control only when traveling on open highways in good weather.

It may not be possible to maintain a constant speed when driving uphill or downhill.

When not using cruise control:
Turn off cruise control by pressing the **CRUISE** button.

■ To Set the Vehicle Speed

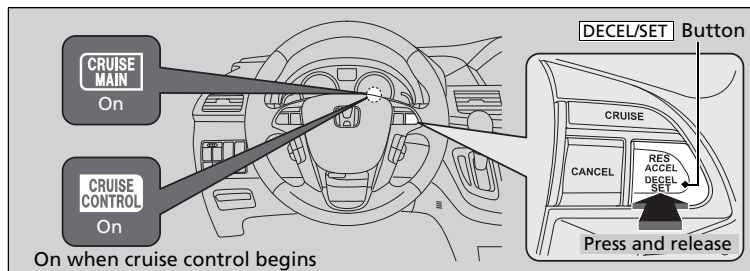

Take your foot off the pedal and press the **DECEL/SET** button when you reach the desired speed.

The moment you release the **DECEL/SET** button, the set speed is fixed, and cruise control begins. The **CRUISE CONTROL** indicator comes on.

■ To Adjust the Vehicle Speed

Increase or decrease the vehicle speed using the **RES/ACCEL** or **DECEL/SET** buttons on the steering wheel.

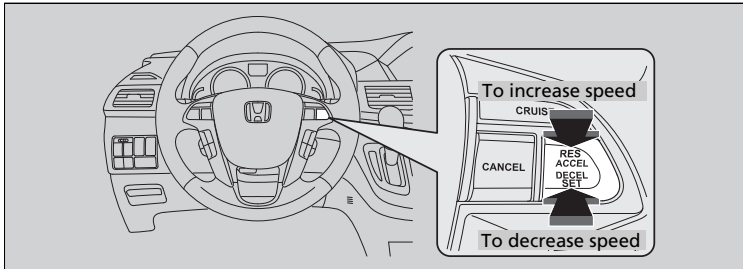

- Each time you press the button, the vehicle speed is increased or decreased by about 1 mph (1.6 km/h).
- If you keep the button pressed, the vehicle speed increases or decreases until you release it. This speed is then set.

■ To Cancel

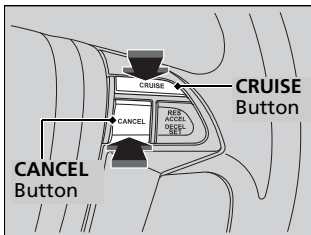

To cancel cruise control, do any of the following:

- Press the **CANCEL** button.
- Press the **CRUISE** button.
- Depress the brake pedal.

The **CRUISE CONTROL** indicator goes off.

▶▶ To Adjust the Vehicle Speed

You can set the vehicle speed using the **DECEL/SET** button on the steering wheel when adjusting the speed with the accelerator and brake pedals.

▶▶ To Cancel

Resuming the prior set speed:
After cruise control has been canceled, you can still resume the prior set speed by pressing the **RES/ACCEL** button while driving at a speed of at least 25 mph (40 km/h) or more.

You cannot set or resume in the following situations:

- When vehicle speed is less than 25 mph (40 km/h)
- When the **CRUISE** button is turned off

At vehicle speeds of 22 mph (35 km/h) or less, cruise control is canceled automatically.

VSA® (Vehicle Stability Assist), aka ESC (Electronic Stability Control), System

VSA® helps to stabilize the vehicle during cornering if the vehicle turns more or less than what was intended. It also assists in maintaining traction on slippery surfaces. It does so by regulating engine output and selectively applying the brakes.

VSA® Operation

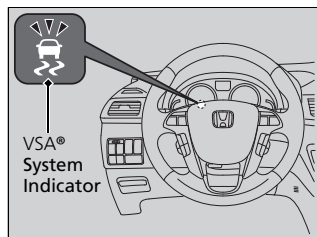

When VSA® activates, you may notice that the engine does not respond to the accelerator. You may also notice some noise from the hydraulic system. You will also see the indicator blink.

VSA® (Vehicle Stability Assist), aka ESC (Electronic Stability Control), System

The VSA® may not function properly if tire type and size are mixed. Make sure to use the same size and type of tire, and the air pressures as specified.

When the VSA® indicator comes on and stays on while driving, there may be a problem with the system. While this may not interfere with normal driving, have your vehicle checked by a dealer immediately.

VSA® cannot enhance stability in all driving situations and does not control the entire braking system. You still need to drive and corner at speeds appropriate for the conditions and always leave a sufficient margin of safety.

The main function of the VSA® system is generally known as Electronic Stability Control (ESC). The system also includes a traction control function.

VSA® On and Off

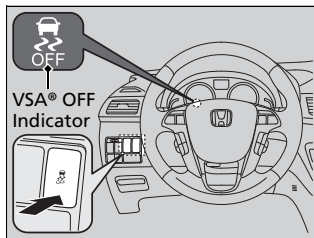

This button is on the driver side control panel. To turn the VSA® system on and off, press and hold it until you hear a beep.

VSA® will stop and the indicator will come on.

To turn it on again, press the  (VSA® OFF) button until you hear a beep.

VSA® is turned on every time you start the engine, even if you turned it off the last time you drove the vehicle.

» VSA® (Vehicle Stability Assist), aka ESC (Electronic Stability Control), System

Without VSA®, your vehicle will have normal braking and cornering ability, but it will not have VSA® traction and stability enhancement.

In certain unusual conditions when your vehicle gets stuck in shallow mud or fresh snow, it may be easier to free it with the VSA® temporarily switched off.

When the VSA® system is off, the traction control system is also off. You should only attempt to free your vehicle with the VSA® off if you are not able to free it when the VSA® is on.

Immediately after freeing your vehicle, be sure to switch VSA® on again. We do not recommend driving your vehicle with the VSA® and traction control systems switched off.

If the low tire pressure/TPMS, low tire pressure, or TPMS indicator comes on or blinks, the VSA® system comes on automatically. In this case, you cannot turn the system off by pressing the  button.

You may hear a motor sound coming from the engine compartment while system checks are being performed immediately after starting the engine or while driving. This is normal.

TPMS (Tire Pressure Monitoring System)

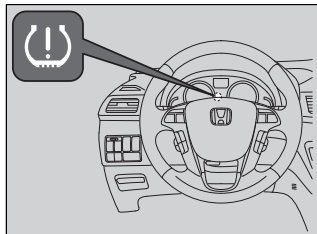

Models with information display

Monitors the tire pressure while you are driving. If your vehicle's tire pressure becomes significantly low, the low tire pressure indicator comes on.

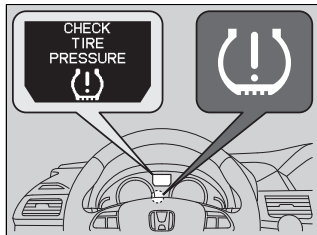

Models with multi-information display

Monitors the tire pressure while you are driving. If your vehicle's tire pressure becomes significantly low, the low tire pressure/TPMS indicator comes on and a message appears on the multi-information display.

CHECK TIRE PRESSURE is displayed when a tire has significantly low pressure.

TPMS (Tire Pressure Monitoring System)

Models with information display

Conditions such as low ambient temperature and altitude change directly affect tire pressure and can trigger the low tire pressure indicator to come on.

➤ **If the Low Tire Pressure Indicator Comes On** P. 401

Tire pressure checked and inflated in:

- Warm weather can become under-inflated in colder weather.
- Cold weather can become over-inflated in warmer weather.

The low tire pressure indicator will not come on as a result of over inflation.

Models with multi-information display

Conditions such as low ambient temperature and altitude change directly affect tire pressure and can trigger the low tire pressure/TPMS indicator to come on.

➤ **If the Low Tire Pressure/TPMS Indicator Comes On or Blinks** P. 402

Tire pressure checked and inflated in:

- Warm weather can become under-inflated in colder weather.
- Cold weather can become over-inflated in warmer weather.

The low tire pressure/TPMS indicator will not come on as a result of over inflation.

Tire Pressure Monitoring System (TPMS) - Required Federal Explanation

Each tire, including the spare (if provided), should be checked monthly when cold and inflated to the inflation pressure recommended by the vehicle manufacturer on the vehicle placard or tire inflation pressure label.

(If your vehicle has tires of a different size than the size indicated on the vehicle placard or tire inflation pressure label, you should determine the proper tire inflation pressure for those tires.)

As an added safety feature, your vehicle has been equipped with a tire pressure monitoring system (TPMS) that illuminates a low tire pressure telltale



when one or more of your tires is significantly under-inflated.

Accordingly, when the low tire pressure telltale illuminates, you should stop and check your tires as soon as possible, and inflate them to the proper pressure.

Driving on a significantly under-inflated tire causes the tire to overheat and can lead to tire failure. Under-inflation also reduces fuel efficiency and tire tread life, and may affect the vehicle's handling and stopping ability.

Please note that the TPMS is not a substitute for proper tire maintenance, and it is the driver's responsibility to maintain correct tire pressure, even if under-inflation has not reached the level to trigger illumination of the TPMS low tire pressure telltale.

Models with information display

Your vehicle has also been equipped with a TPMS malfunction indicator to indicate when the system is not operating properly. The TPMS malfunction indicator is provided by a separate telltale, which displays the symbol "TPMS" when illuminated.

When the malfunction indicator is illuminated,

A square icon with a black border containing the letters "TPMS" in a bold, sans-serif font.

the system may not be able to detect or signal low tire pressure as intended.

TPMS malfunctions may occur for a variety of reasons, including the installation of replacement or alternate tires or wheels on the vehicle that prevent the TPMS from functioning properly.

Always check the TPMS malfunction telltale after replacing one or more tires or wheels on your vehicle to ensure that the replacement or alternate tires and wheels allow the TPMS to continue to function properly.

Models with multi-information display

Your vehicle has also been equipped with a TPMS malfunction indicator to indicate when the system is not operating properly. The TPMS malfunction indicator is combined with the low tire pressure telltale. When the system detects a malfunction, the telltale will flash for approximately one minute and then remain continuously illuminated. This sequence will continue upon subsequent vehicle start-ups as long as the malfunction exists.

When the malfunction indicator is illuminated, the system may not be able to detect or signal low tire pressure as intended.

TPMS malfunctions may occur for a variety of reasons, including the installation of replacement or alternate tires or wheels on the vehicle that prevent the TPMS from functioning properly.

Always check the TPMS malfunction telltale after replacing one or more tires or wheels on your vehicle to ensure that the replacement or alternate tires and wheels allow the TPMS to continue to function properly.

BSI (Blind Spot Information) System*

Is designed to detect vehicles in specified alert zones adjacent to your vehicle, particularly in harder to see areas commonly known as “blind spots.”

When the system detects vehicles approaching from behind in adjacent lanes, the appropriate indicator comes on, providing assistance when you change lanes.

■ How the system works

- The shift lever is in **D** or **D4**.
- Your vehicle speed is between 6 mph (10 km/h) and 100 mph (160 km/h)

Alert zone range

- A: Approx. 1.6 ft. (0.5 m)
- B: Approx. 10 ft. (3 m)
- C: Approx. 10 ft. (3 m)

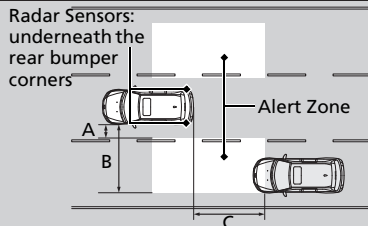

■ When the system detects a vehicle

BSI Alert Indicator: Located near the outside rearview mirror on both sides.

Comes on when:

- A vehicle enters the alert zone from behind to overtake you with a speed difference of no more than 31 mph (50 km/h) from your vehicle.
- You pass a vehicle with a speed difference of no more than 12 mph (20 km/h).

Blinks when:

You use the turn signal lever and change lanes in the direction of a detected vehicle.

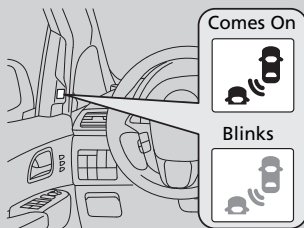

⚠ BSI (Blind Spot Information) System*

⚠ WARNING

Failure to visually confirm that it is safe to change lanes before doing so may result in a crash and serious injury or death. Do not rely only on the blind spot information system when changing lanes.

Always look in your mirrors, to either side of your vehicle, and behind you for other vehicles before changing lanes.

Important Safety Reminder

Like all assistance systems, BSI has limitations. Over reliance on BSI may result in a collision.

The system is for your convenience only. Even if an object is within the alert zone, the following situations may occur.

- The BSI alert indicator may not come on due to obstruction (splashes, etc.) even without the **BLIND SPOT NOT AVAILABLE** multi-information display appearing.
- The BSI alert indicator may come on even with the message appearing.

The BSI alert indicator may not come on under following conditions:

- A vehicle does not stay in the alert zone for more than two seconds.
- A vehicle is parked in a side lane.
- The speed difference between your vehicle and the vehicle you are passing is greater than 6 mph (10 km/h).
- An object not detected by the radar sensors approaches or passes your vehicle.

BSI On and Off

Press the BSI OFF button until you hear a beep to turn on and off the system. A message on the multi-information display appears for five seconds and indicates that the system is on or off.

When BSI is off, the BSI indicator in the instrument panel stays on.

BSI is in the previously selected on or off setting each time you start the engine.

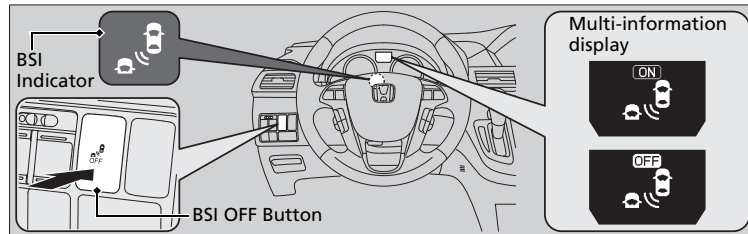

* Not available on all models

BSI (Blind Spot Information) System*

Turn the system off when towing a trailer. The system does not work properly for the following reasons:

- The added mass tilts the vehicle and changes the radar coverage.
- The trailer itself can be detected by the radar sensors, causing the BSI alert indicators to come on.

BSI may be adversely affected when:

- Objects (guard rails, poles, trees, etc.) are detected.
- An object that does not reflect radio waves well, such as a motorcycle, is in the alert zone.
- Driving on a curved road.
- A vehicle is moving from a far lane to the adjacent lane.
- The system picks up external electrical interference.
- The rear bumper or the sensors have been improperly repaired or the rear bumper has been deformed.
- The orientation of the sensors has been changed.
- In bad weather (Heavy rain, snow, and fog).

For a proper BSI use:

- Always keep the rear bumper corner area clean.
- Do not cover the rear bumper corner area with labels or stickers of any kind.
- Take your vehicle to a dealer if you need the rear bumper corner area or the radar sensors to be repaired, or the rear bumper corner area is strongly impacted.

Brake System

■ Parking Brake

Use the parking brake to keep the vehicle stationary when parking.

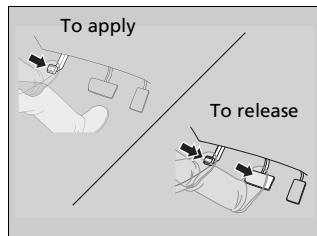

To apply:

Depress the parking brake pedal down with your foot.

To release:

1. Depress the brake pedal.
2. Depress the parking brake.

☒ Parking Brake

NOTICE

Release the parking brake fully before driving. The rear brakes and axle can be damaged if you drive with the parking brake applied.

If you start driving without fully releasing the parking brake, a buzzer sounds as a warning, and **RELEASE PARKING BRAKE** appears on the multi-information display*.

Always apply the parking brake when parking.

Foot Brake

Your vehicle is equipped with disc brakes at all four wheels. A vacuum power assist helps reduce the effort needed on the brake pedal. The brake assist system increases the stopping force when you depress the brake pedal hard in an emergency situation. The anti-lock brake system (ABS) helps you retain steering control when braking very hard.

➤ **Brake Assist System** P. 311

➤ **ABS (Anti-lock Brake System)** P. 310

Foot Brake

Check the brakes after driving through deep water, or if there is a buildup of road surface water. If necessary, dry the brakes by lightly depressing the pedal several times.

If you hear a continuous metallic friction sound when applying the brakes, the brake pads need to be replaced. Have the vehicle checked by a dealer.

Constantly using the brake pedal while going down a long hill builds up heat, which reduces the brake effectiveness. Apply engine braking by taking your foot off the accelerator pedal and downshifting to a lower gear.

Do not rest your foot on the brake pedal while driving, as it will lightly apply the brakes and cause them to lose effectiveness over time and reduce pad life. It will also confuse drivers behind you.

ABS (Anti-lock Brake System)

■ ABS

Helps prevent the wheels from locking up, and helps you retain steering control by pumping the brakes rapidly, much faster than you.

The electronic brake distribution (EBD) system, which is part of the ABS, also balances the front-to-rear braking distribution according to vehicle loading.

You should never pump the brake pedal. Let the ABS work for you by always keeping firm, steady pressure on the brake pedal. This is sometimes referred to as “stomp and steer.”

■ ABS operation

The brake pedal may pulsate slightly when the ABS is working. Keep holding the pedal firmly down. On dry pavement, you will need to press on the brake pedal very hard before the ABS activates. However, you may feel the ABS activate immediately if you are trying to stop on snow or ice.

When the vehicle speed goes under 6 mph (10 km/h), the ABS stops.

ⓘ ABS (Anti-lock Brake System)

NOTICE

The ABS may not function correctly if you use an incorrect tire type and size.

When the ABS indicator comes on while driving, there may be a problem with the system. While normal braking is not affected, there is a possibility of the ABS not operating. Have the vehicle checked by a dealer immediately.

The ABS does not reduce the time or distance it takes to stop the vehicle. It only helps with steering control during hard braking.

In the following cases, your vehicle may need more stopping distance than a vehicle without the ABS:

- When driving on rough road surfaces, including when driving on uneven surfaces, such as gravel or snow.
- When tire chains are installed.

You may hear a motor sound coming from the engine compartment while system checks are being performed immediately after starting the engine or while driving. This is normal.

Brake Assist System

Designed to assist the driver by generating greater braking force when you depress the brake pedal hard during emergency braking.

■ Brake assist system operation

Press the brake pedal firmly for more powerful braking.

When brake assist operates, the pedal may wiggle slightly and an operating noise may be heard. This is normal. Keep holding the brake pedal firmly down.

When Stopped

1. Depress the brake pedal firmly with the shift lever in **[D]**.
2. Firmly apply the parking brake.
3. Move the shift lever from **[D]** to **[P]**.
4. Turn off the engine.

Always set the parking brake firmly, in particular if you are parked on an incline.

⊗ Parking Your Vehicle

Do not park your vehicle near flammable objects, such as dry grass, oil, or timber. Heat from the exhaust can cause a fire.

⊗ When Stopped

NOTICE

The following can damage the transmission:

- Depressing the accelerator and brake pedals simultaneously.
- Holding the vehicle in place when facing uphill by depressing the accelerator pedal.
- Moving the shift lever into **[P]** before the vehicle stops completely.

Raise the wiper arms when snow is expected.

Parking Sensor System*

The corner and rear center sensors monitor obstacles around your vehicle, and the beeper and display let you know the approximate distance between your vehicle and the obstacle.

■ The sensor location and range

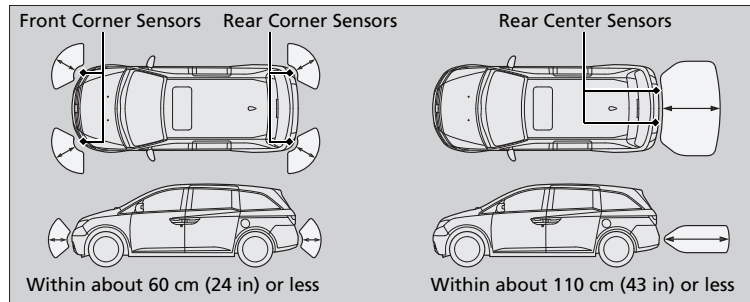

* Not available on all models

Continued

▣ Parking Sensor System*

Even when the system is on, always confirm if there is no obstacle near your vehicle before parking.

The system may not work properly when:

- The sensors are covered with snow, ice, mud, or dirt.
- The vehicle is on an uneven surface, such as grass, bumps, or a hill.
- The vehicle has been out in hot or cold weather.
- The system is affected by some electric devices that generate ultrasonic waves.
- Driving in bad weather.

The system may not sense:

- Thin or low objects.
- Sonic-absorptive materials, such as snow, cotton, or sponge.
- Objects directly under the bumper.

Do not put any accessories on or around the sensors.

■ When you activate the system

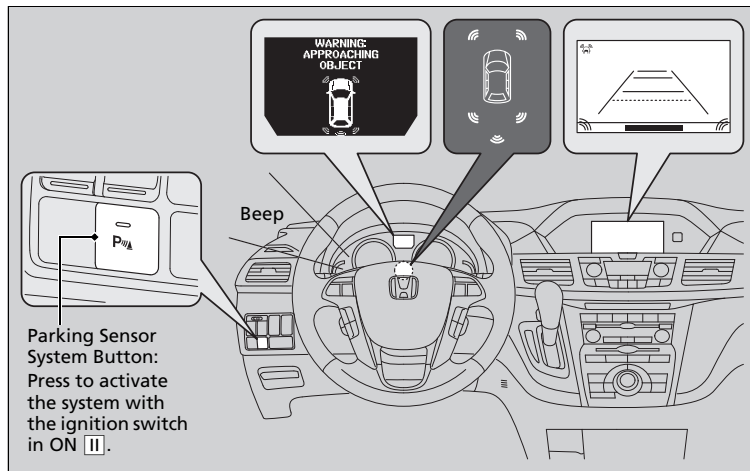

The indicator in the button comes on and the beeper sounds when the system is on.



The corner sensors start to detect an obstacle when the shift lever is in any position other than **P**, and the vehicle speed is less than 5 mph (8 km/h).

The rear center sensors start to detect an obstacle when the shift lever is in **R**, and the vehicle speed is less than 5 mph (8 km/h).

▣ Parking Sensor System*

When you turn the ignition switch to ON **II**, the system will be in the previously selected condition.

■ When the distance between your vehicle and obstacles behind becomes shorter

Length of the intermittent beep	Distance between the Bumper and Obstacle		Appropriate Indicator			Audio/navigation screen indicator color			
	Corner Sensors	Center Sensors	Instrument panel  Stays on	Multi-information display  Stays on	Audio/navigation screen  Blinks				
Long*1	—	About 43-28 in (110-70 cm)							Yellow
Short	About 24-18 in (60-45 cm)	About 28-22 in (70-55 cm)							Amber
Very short	About 18-14 in (45-35 cm)	About 22-18 in (55-45 cm)							Amber
Continuous	About 14 in (35 cm) or less	About 18 in (45 cm) or less	Red						

*1: At this stage, only the center sensors detect obstacles.

■ The parking sensor system on audio/navigation screen

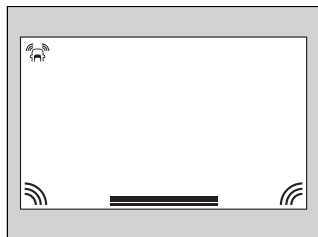

- An appropriate indicator blinks when there are any obstacles around the parking sensors. The color of the indicator changes in accordance with the distance between your vehicle and obstacles.
- An appropriate indicator stays on in red when there is a problem with the corresponding parking sensor.

Models without navigation system

➤ **Parking Sensor Indicator*** P. 77

Models without navigation system

➤ **Multi-Information Display Warning and Information Messages*** P. 85

■ Turning off All Rear Sensors

1. Make sure that the parking sensor system is not activated. Turn the ignition switch to LOCK [0].
2. Press and hold the parking sensor system button, and turn the ignition switch to ON [II].
3. Keep pressing the button for 10 seconds. Release the button when the indicator in the button flashes.
4. Press the button again. The indicator in the button goes off.
 - ▶ The beeper sounds twice. The rear sensors are now turned off.

To turn the rear sensors on again, follow the above procedure. The beeper sounds three times when the rear sensors come back on.

☒ Turning off All Rear Sensors

When you shift to [R], the indicator in the parking sensor system button blinks as a reminder that the rear sensors have been turned off.

About Your Rearview Camera

Models with navigation system

For models with the navigation system, see the Navigation System Manual.

Models without navigation system

The audio/information screen can display your vehicle's rear view.

The display automatically changes to a rear view when the shift lever is moved to

R.

Rearview Camera Display Area

Screen display

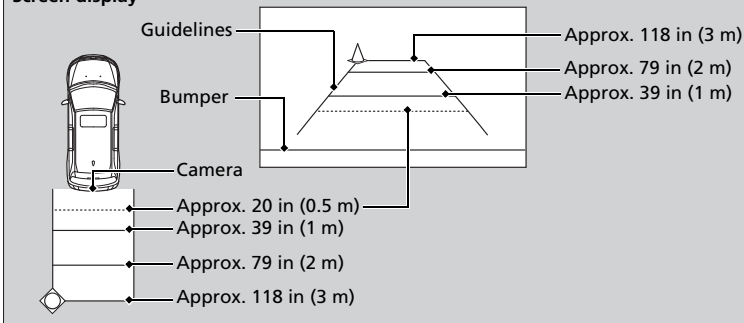

The rearview camera has a unique lens that makes objects appear closer or further than they actually are.

» About Your Rearview Camera

The rearview camera is view restricted. You cannot see the corner ends of the bumper or what is underneath the bumper. Its unique lens also makes objects appear closer or farther than they actually are.

Visually confirm that it is safe to drive before backing up. Do not rely on the rearview display which does not give you all information about conditions at the back of your vehicle.

Certain conditions (such as weather, lighting, and high temperatures) may also restrict the rear view. Use a soft, moist cloth to keep the lens clean and free of debris.

To turn the guide lines on or off, press and hold the **RETURN** button for about three seconds. If you turn the guide lines off, they remain off until you turn them back on.

Rotate  to adjust the brightness of the rearview camera.

Fuel Information

■ Fuel recommendation

Unleaded gasoline, pump octane number 87 or higher

Use of a lower octane gasoline can cause a persistent, heavy metallic knocking noise that can lead to engine damage.

■ Top tier detergent gasoline

Because the level of detergency and additives in gasoline vary in the market, Honda endorses the use of “TOP TIER Detergent Gasoline” where available to help maintain the performance and reliability of your vehicle. TOP TIER Detergent Gasoline meets a new gasoline standard jointly established by leading automotive manufacturers to meet the needs of today’s advanced engines.

☒ Fuel Information

NOTICE

We recommend quality gasoline containing detergent additives that help prevent fuel system and engine deposits. In addition, in order to maintain good performance, fuel economy, and emissions control, we strongly recommend the use of gasoline that does NOT contain harmful manganese-based fuel additives such as MMT, if such gasoline is available.

Use of gasoline with these additives may adversely affect performance, and cause the malfunction indicator lamp on your instrument panel to come on. If this happens, contact a dealer for service. Some gasoline today is blended with oxygenates such as ethanol. Your vehicle is designed to operate on oxygenated gasoline containing up to 10% ethanol by volume. Do not use gasoline containing methanol. If you notice any undesirable operating symptoms, try another service station or switch to another brand of gasoline.

Qualifying gasoline retailers will, in most cases, identify their gasoline as having met “TOP TIER Detergent Gasoline” standards at the retail location. This fuel is guaranteed to contain the proper level of detergent additives and be free of metallic additives. The proper level of detergent additives, and absence of harmful metallic additives in gasoline, help avoid build-up of deposits in your engine and emission control system.

For further important fuel-related information for your vehicle, or on information on gasoline that does not contain MMT, visit www.hondacars.com. In Canada, visit www.honda.ca for additional information on gasoline. For more information on top tier gasoline, visit www.toptiergas.com.

■ Fuel tank capacity: 21 US gal (79.5 liters)

How to Refuel

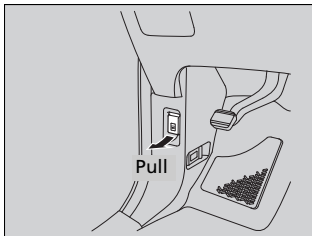

1. Stop your vehicle with the service station pump on the left side of the vehicle in the rear.
2. Turn off the engine.
3. Pull on the fuel fill door release handle under the lower left corner of the dashboard.
 - ▶ The fuel fill door opens.

▶▶ How to Refuel

⚠ WARNING

Gasoline is highly flammable and explosive. You can be burned or seriously injured when handling fuel.

- Stop the engine, and keep heat, sparks, and flame away.
- Handle fuel only outdoors.
- Wipe up spills immediately.

Continued

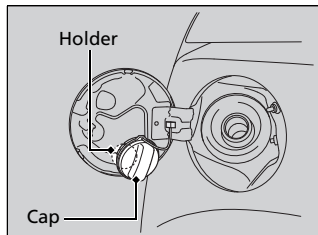
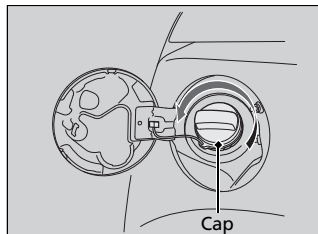

4. Remove the fuel fill cap slowly. If you hear a release of air, wait until this stops, then turn the knob slowly to open the fuel fill cap.

5. Place the fuel fill cap in the holder.

6. Insert the fuel filler nozzle fully.

▶ When the tank is full, the filler nozzle will click off automatically. This leaves space in the fuel tank in case the fuel expands with a change in the temperature.

7. After filling, replace the fuel fill cap, tightening it until you hear it click at least once.

▶ Shut the fuel fill door by hand.

How to Refuel

The filler nozzle automatically stops to leave space in the fuel tank so that fuel does not overflow as a result of changes in air temperature.

If the filler nozzle keeps turning off when the tank is not full, there may be a problem with the pump's fuel vapor recovery system. Try filling at another pump. If this does not fix the problem, consult a dealer.

Do not continue to add fuel after the nozzle has automatically stopped. Additional fuel can exceed the full tank capacity.

Improving Fuel Economy

Fuel economy depends on several conditions, including driving conditions, your driving habits, the condition of your vehicle, and loading. Depending on these and other conditions, you may or may not achieve the rated fuel economy of this vehicle.

Maintenance and Fuel Economy

You can optimize your fuel economy with proper maintenance of your vehicle. Always maintain your vehicle in accordance with the messages displayed on the information display*/multi-information display*.

- Use the recommended viscosity engine oil, displaying the API Certification Seal.
- Maintain the specified tire pressure.
- Do not load the vehicle with excess cargo.
- Keep your vehicle clean. A buildup of snow or mud on your vehicle's underside adds weight and increases wind resistance.

* Not available on all models

Improving Fuel Economy

Direct calculation is the recommended method to determine actual fuel consumed while driving.

Miles driven	÷	Gallons of fuel	=	Miles per Gallon		
100	×	Liters of fuel	÷	Kilometers driven	=	L per 100 km

In Canada, posted fuel economy numbers are established following a simulated test. For more information on how this test is performed, please visit <http://oee.nrcan.gc.ca/>

Accessories

When installing accessories, check the following:

- Do not install accessories on the windshield. They can obstruct your view and delay your reaction to driving conditions.
- Do not install accessories on the side pillars or across the side windows. Accessories installed in these areas may interfere with proper operation of the side curtain airbags.
- Be sure electronic accessories do not overload electrical circuits or interfere with proper operation of your vehicle.
 - ✎ **Fuses** P. 403
- Before installing any electronic accessory, have the installer contact a dealer for assistance. If possible, have a dealer inspect the final installation.

Modifications

Do not modify your vehicle or use non-Honda components that can affect its handling, stability, and reliability.

Overall vehicle performance can be affected. Always make sure all equipment is properly installed and maintained, and that it meets federal, state, province, territory, and local regulations.

Accessories and Modifications

WARNING

Improper accessories or modifications can affect your vehicle's handling, stability, and performance, and cause a crash in which you can be seriously hurt or killed.

Follow all instructions in this owner's manual regarding accessories and modifications.

Honda Genuine accessories are recommended to ensure proper operation on your vehicle.

Maintenance

This chapter discusses basic maintenance.



Before Performing Maintenance

Inspection and Maintenance	324
Safety When Performing Maintenance.....	325
Parts and Fluids Used in Maintenance Service	326

Maintenance Minder™

Maintenance Under the Hood

Maintenance Items Under the Hood	335
Opening the Hood	336
Recommended Engine Oil	337
Oil Check	338
Adding Engine Oil	339
Changing the Engine Oil and Oil Filter	340

Engine Coolant	342
Transmission Fluid	344
Brake Fluid	345
Power Steering Fluid Check	346
Refilling Window Washer Fluid	346

Replacing Light Bulbs

Checking and Maintaining Wiper Blades

Checking and Maintaining Tires

Checking Tires	362
Tire and Loading Information Label	363
Tire Labeling	363
DOT Tire Quality Grading (U.S. Vehicles).....	365
Wear Indicators.....	367

Tire Service Life	367
Tire and Wheel Replacement	368
Tire Rotation	369
Winter Tires	370

Battery

Remote Transmitter Care

Remote Control and Wireless

Headphone Care*

Heating and Cooling System*/Climate

Control System* Maintenance

Cleaning

Interior Care	377
Exterior Care.....	379

* Not available on all models

Inspection and Maintenance

For your safety, perform all listed inspections and maintenance to keep your vehicle in good condition. If you become aware of any abnormality (noise, smell, insufficient brake fluid, oil residue on the ground, etc.), have your vehicle inspected by a dealer. (Note, however, that service at a dealer is not mandatory to keep your warranties in effect.) Refer to the separate maintenance booklet for detailed maintenance and inspection information.

Types of Inspection and Maintenance

Daily inspections

Perform inspections before long distance trips, when washing the vehicle, or when refueling.

Periodic inspections

- Check the automatic transmission fluid level monthly.
 - ✎ **Automatic Transmission Fluid** P. 344
- Check the brake fluid level monthly.
 - ✎ **Brake Fluid** P. 345
- Check the tire pressure monthly. Examine the tread for wear and foreign objects.
 - ✎ **Checking and Maintaining Tires** P. 362
- Check the operation of the exterior lights monthly.
 - ✎ **Replacing Light Bulbs** P. 347
- Check the condition of the wiper blades at least every six months.
 - ✎ **Checking and Maintaining Wiper Blades** P. 358

Inspection and Maintenance

U.S. models

Maintenance, replacement, or repair of emissions control devices and systems may be done by any automotive repair establishment or individuals using parts that are “certified” to EPA standards.

According to state and federal regulations, failure to perform maintenance on the maintenance main items marked with # will not void your emissions warranties. However, all maintenance services should be performed in accordance with the intervals indicated by the information display*/multi-information display*.

✎ **Maintenance Service Items** P. 329, 333

If you want to perform complex maintenance tasks that require more skills and tools, you can purchase a subscription to the Service Express website at www.techinfo.honda.com.

✎ **Authorized Manuals** P. 421

If you want to perform maintenance yourself, make sure that you have the necessary tools and skills first. After performing maintenance, update the records in the separate maintenance booklet.

Safety When Performing Maintenance

Some of the most important safety precautions are given here. However, we cannot warn you of every conceivable hazard that can arise in performing maintenance. Only you can decide whether or not you should perform a given task.

Maintenance Safety

- To reduce the possibility of fire or explosion, keep cigarettes, sparks, and flames away from the battery and all fuel related parts.
- Never leave rags, towels, or other flammable objects under the hood.
 - Heat from the engine and exhaust can ignite them causing a fire.
- To clean parts, use a commercially available degreaser or parts cleaner, not gasoline.
- Wear eye protection and protective clothing when working with the battery or compressed air.
- Engine exhaust contains carbon monoxide, which is poisonous and can kill you.
 - Only operate the engine if there is sufficient ventilation.

Vehicle Safety

- The vehicle must be in a stationary condition.
 - Make sure your vehicle is parked on level ground, the parking brake is set, and the engine is off.
- Be aware that hot parts can burn you.
 - Make sure to let the engine and exhaust system cool thoroughly before touching vehicle parts.
- Be aware that moving parts can injure you.
 - Do not start the engine unless instructed, and keep your hands and limbs away from moving parts.

» Safety When Performing Maintenance

WARNING

Improperly maintaining this vehicle or failing to correct a problem before driving can cause a crash in which you can be seriously hurt or killed.

Always follow the inspection and maintenance recommendations according to the schedules in this owner's manual.

WARNING

Failure to properly follow maintenance instructions and precautions can cause you to be seriously hurt or killed.

Always follow the procedures and precautions in this owner's manual.

Parts and Fluids Used in Maintenance Service

The use of Honda genuine parts and fluids is recommended when maintaining and servicing your vehicle. Honda genuine parts are manufactured according to the same high quality standards used in Honda vehicles.

If the engine oil life is less than 15%, you will see the Maintenance Minder messages appear on the information display* or the multi-information display* every time you turn the ignition switch to ON **II**. The messages notify you when to change the engine oil, or when to bring your vehicle to a dealer for indicated maintenance services.

Models with information display

To Use Maintenance Minder™

Displaying the Engine Oil Life

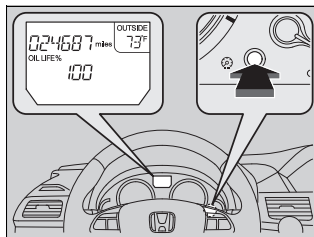

1. Turn the ignition switch to ON **II**.
2. Press the  (Select/Reset) knob repeatedly until the engine oil life appears on the information display.

The Maintenance Minder indicator () stays on in the instrument panel after the engine oil life becomes 0%. Have the indicated maintenance done by a dealer immediately.

Displaying the Engine Oil Life





Based on the engine operating conditions, the remaining engine oil life is calculated and displayed as a percentage.

Displayed Engine Oil Life (%)	Calculated Engine Oil Life (%)
100	100 to 91
90	90 to 81
80	80 to 71
70	70 to 61
60	60 to 51
50	50 to 41
40	40 to 31
30	30 to 21
20	20 to 16
15	15 to 11
10	10 to 6
5	5 to 1
0	0

* Not available on all models

Maintenance Minder Messages on the Information Display

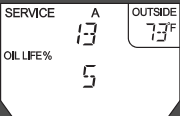
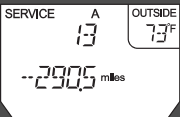
To switch the display, press the  (Select/Reset) knob.

Oil Life Display	Explanation	Information	Maintenance Minder Indicator
	The engine oil life indicator starts to appear along with other due soon maintenance item codes when the remaining oil life becomes 15 percent.	The engine oil is approaching the end of its service life.	 Starts to come on when the remaining engine oil life becomes 15 percent.
	The SERVICE message also starts to appear along with the engine oil life indicator and the maintenance item codes.	The engine oil has almost reached the end of its service life, and the maintenance items should be inspected and serviced as soon as possible.	It goes off when the display is switched.
	The remaining engine oil life has passed its service life, and a negative distance appears after driving over 10 miles (U.S. models) or 10 km (Canadian models). The negative distance on the display blinks.	The engine oil life has passed. The maintenance items must be inspected and serviced immediately.	 Stays on as a reminder even when the display is switched.

Maintenance Service Items

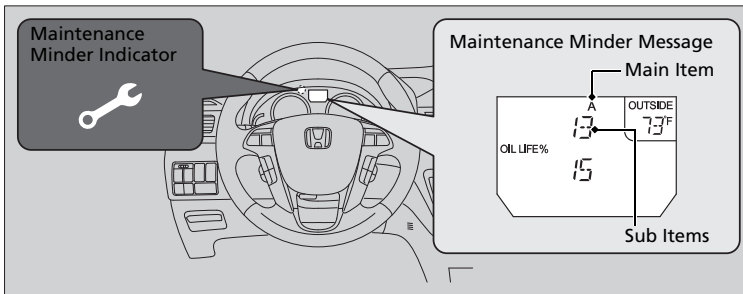

Maintenance Service Items

- Independent of the Maintenance Minder information, replace the brake fluid every 3 years.
- Inspect idle speed every 160,000 miles (256,000 km).
- Adjust the valves during services A, B, 1, 2, or 3 if they are noisy.

CODE	Maintenance Main Items
A	<ul style="list-style-type: none"> • Replace engine oil*¹
B	<ul style="list-style-type: none"> • Replace engine oil*¹ and oil filter • Inspect front and rear brakes/service as necessary • Check parking brake adjustment • Inspect tie rod ends, steering gearbox, and boots • Inspect suspension components • Inspect driveshaft boots • Inspect brake hoses and lines (Including ABS/VSA) • Inspect all fluid levels and condition of fluids • Inspect exhaust system# • Inspect fuel lines and connections#

*1: If a message **SERVICE** does not appear more than 12 months after the display is reset, change the engine oil every year.

#: See information on maintenance and emissions warranty.

CODE	Maintenance Sub Items
1	<ul style="list-style-type: none"> • Rotate tires
2	<ul style="list-style-type: none"> • Replace air cleaner element*² • Replace dust and pollen filter*³ • Inspect drive belt
3	<ul style="list-style-type: none"> • Replace transmission fluid
4	<ul style="list-style-type: none"> • Replace spark plugs • Replace timing belt and inspect water pump*⁴ • Inspect valve clearance
5	<ul style="list-style-type: none"> • Replace engine coolant

*2: If you drive in dusty conditions, replace the air cleaner element every 15,000 miles (24,000 km).

*3: If you drive primarily in urban areas that have high concentrations of soot in the air from industry and from diesel-powered vehicles, replace the dust and pollen filter every 15,000 miles (24,000 km).

*4: If you drive regularly in very high temperatures (over 110°F, 43°C), in very low temperatures (under 20°F, 29°C), replace every 60,000 miles/100,000 km.

Resetting the Display

Reset the engine oil life display if you have performed the maintenance service.

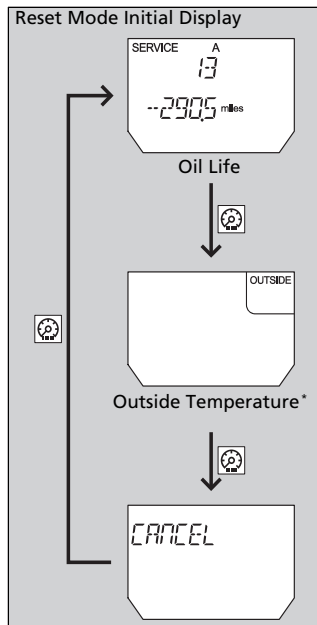

1. Turn the ignition switch to ON (II).
2. Press and hold the (Select/Reset) knob for 10 seconds or more.
 - The information display shows the reset mode initial display.
3. Select oil life with the knob.
4. Press and hold the knob for a few seconds to enter the oil life reset mode.
5. Press and hold the knob for five seconds or more.
 - The displayed maintenance items disappear and the engine oil life display will return to 100%.

Resetting the Display

NOTICE

Failure to reset the engine oil life after a maintenance service results in the system showing incorrect maintenance intervals, which can lead to serious mechanical problems.

The dealer will reset the engine oil life display after completing the required maintenance service. If someone other than a dealer performs maintenance service, reset the engine oil life display yourself.

Models with multi-information display

To Use Maintenance Minder™

■ Displaying the Engine Oil Life

1. Turn the ignition switch to ON .
2. Press the **SEL/RESET** button repeatedly until the engine oil life appears on the multi-information display.

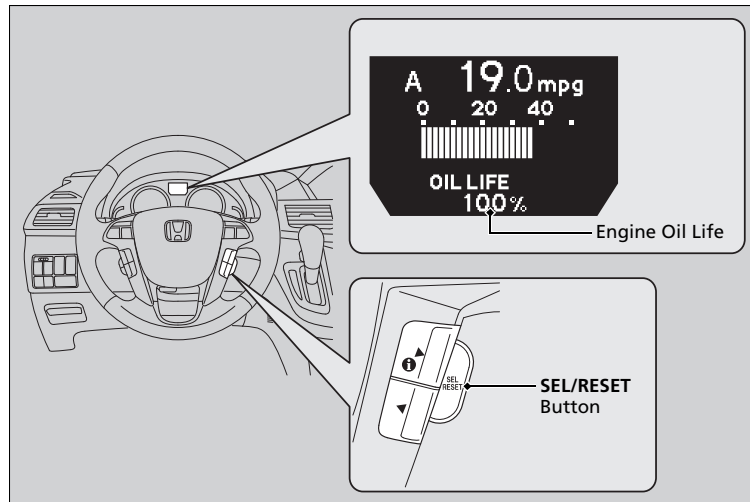

►► Displaying the Engine Oil Life and Maintenance Items







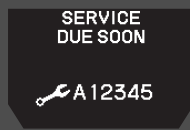
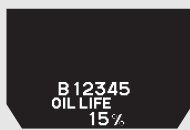

Based on the engine operating conditions, the remaining engine oil life is calculated and displayed as a percentage.

Displayed Engine Oil Life (%)	Calculated Engine Oil Life (%)
100	100 to 91
90	90 to 81
80	80 to 71
70	70 to 61
60	60 to 51
50	50 to 41
40	40 to 31
30	30 to 21
20	20 to 16
15	15 to 11
10	10 to 6
5	5 to 1
0	0

There is a list of maintenance main and sub items you can view on the multi-information display.

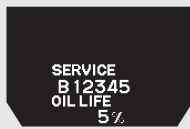
► **Maintenance Service Items** P. 333

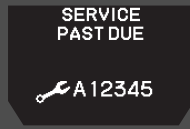
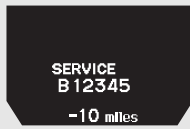
Maintenance Minder Messages on the Multi-Information Display

Maintenance Message	Oil Life Display	Explanation	Information
<p>SERVICE DUE SOON</p> 	<p>15%</p> 	<p>The remaining engine oil life is 15 to 6 percent. Once you switch the display by pressing the  /  (information) button, this message will go off.</p>	<p>The engine oil is approaching the end of its service life, and the maintenance items should be inspected and serviced soon.</p>
<p>SERVICE DUE NOW</p> 	<p>5%</p> 	<p>The remaining engine oil life is 5 to 1 percent. Press the  /  button to switch to another display.</p>	<p>The engine oil has almost reached the end of its service life, and the maintenance items should be inspected and serviced as soon as possible.</p>
<p>SERVICE PAST DUE</p> 	<p>Negative Distance</p> 	<p>The remaining engine oil life has passed its service life, and a negative distance appears after driving over 10 miles (U.S. models) or 10 km (Canadian models). Press the  /  button to switch to another display.</p>	<p>The engine oil life has passed. The maintenance items must be inspected and serviced immediately.</p>

The system message indicator (i) comes on along with the Maintenance Minder message.

Maintenance Service Items

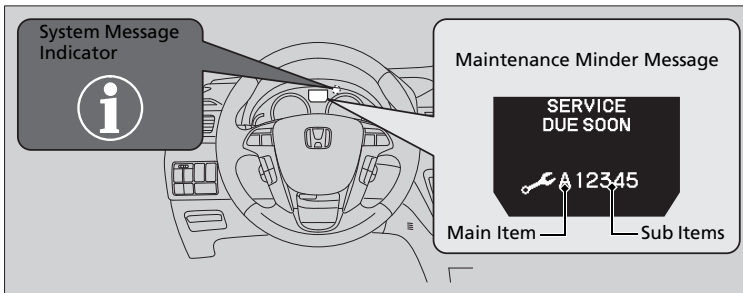

Maintenance Service Items

- Independent of the Maintenance Minder information, replace the brake fluid every 3 years.
- Inspect idle speed every 160,000 miles (256,000 km).
- Adjust the valves during services A, B, 1, 2, or 3 only if they are noisy.

CODE	Maintenance Main Items
A	<ul style="list-style-type: none"> • Replace engine oil*¹
B	<ul style="list-style-type: none"> • Replace engine oil*¹ and oil filter • Inspect front and rear brakes/service as necessary • Check parking brake adjustment • Inspect tie rod ends, steering gearbox, and boots • Inspect suspension components • Inspect driveshaft boots • Inspect brake hoses and lines (Including ABS/VSA) • Inspect all fluid levels and condition of fluids • Inspect exhaust system# • Inspect fuel lines and connections#

*1: If a message **SERVICE** does not appear more than 12 months after the display is reset, change the engine oil every year.

#: See information on maintenance and emissions warranty.

CODE	Maintenance Sub Items
1	<ul style="list-style-type: none"> • Rotate tires
2	<ul style="list-style-type: none"> • Replace air cleaner element*² • Replace dust and pollen filter*³ • Inspect drive belt
3	<ul style="list-style-type: none"> • Replace transmission fluid
4	<ul style="list-style-type: none"> • Replace spark plugs • Replace timing belt and inspect water pump*⁴ • Inspect valve clearance
5	<ul style="list-style-type: none"> • Replace engine coolant

*2: If you drive in dusty conditions, replace the air cleaner element every 15,000 miles (24,000 km).



*3: If you drive primarily in urban areas that have high concentrations of soot in the air from industry and from diesel-powered vehicles, replace the dust and pollen filter every 15,000 miles (24,000 km).

*4: If you drive regularly in very high temperatures (over 110°F, 43°C), in very low temperatures (under 20°F, 29°C), replace every 60,000 miles/100,000 km.

Resetting the Display

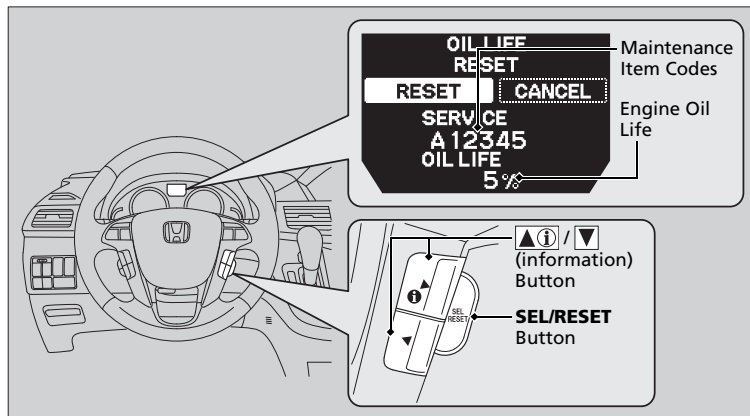
Reset the engine oil life display if you have performed the maintenance service.



1. Turn the ignition switch to ON .
 2. Display the engine oil life by repeatedly pressing the **SEL/RESET** button.
 3. Press and hold the **SEL/RESET** button for 10 seconds or more.
 - The oil life reset mode is displayed on the multi-information display.
 4. Select **RESET** with the  /  button, then press the **SEL/RESET** button.
 - The service code will disappear and the engine oil life display will return to 100%.
- To cancel the oil life reset mode, select **CANCEL**, then press the **SEL/RESET** button.

Resetting the Display

NOTICE

Failure to reset the engine oil life after a maintenance service results in the system showing incorrect maintenance intervals, which can lead to serious mechanical problems.

The dealer will reset the engine oil life display after completing the required maintenance service. If someone other than a dealer performs maintenance service, reset the engine oil life display yourself.

Maintenance Items Under the Hood

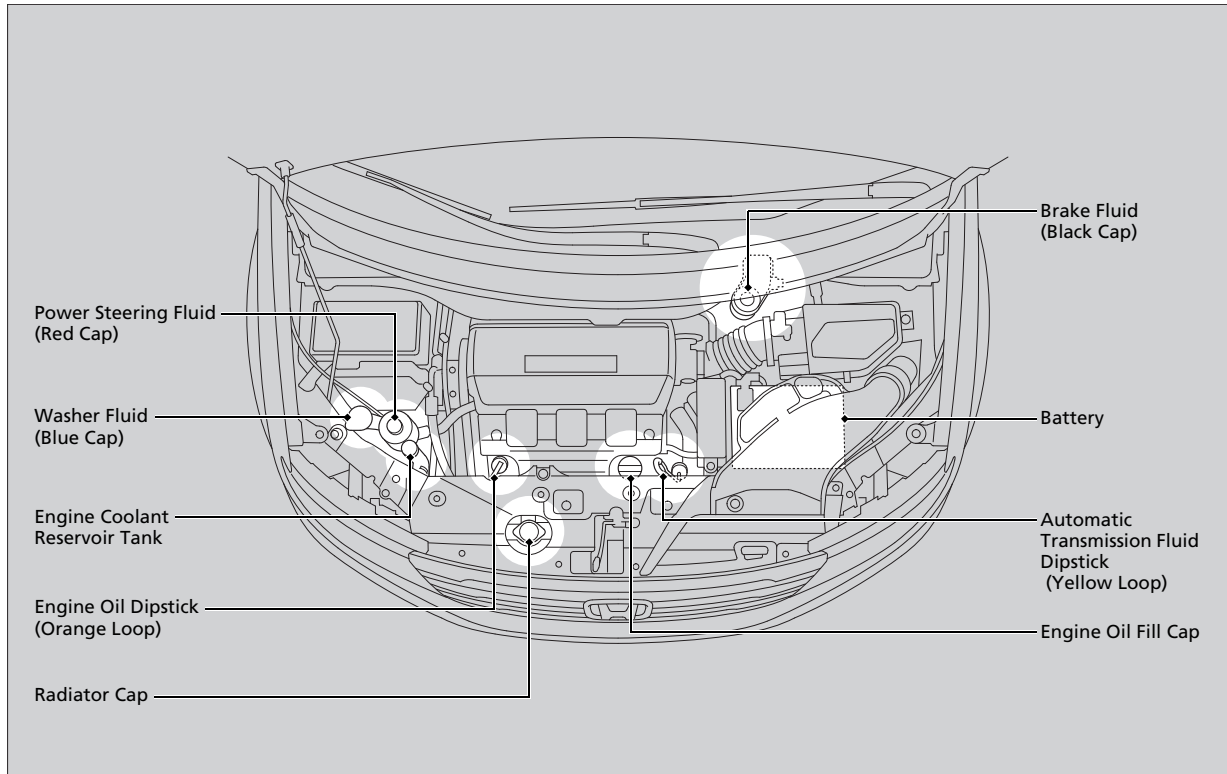

Opening the Hood

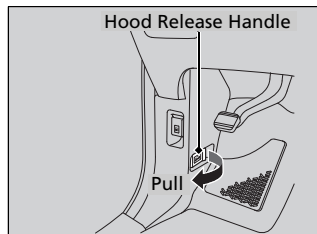

1. Park the vehicle on a level surface, and set the parking brake.
2. Pull the hood release handle under the lower left corner of the dashboard.
 - The hood will pop up slightly.

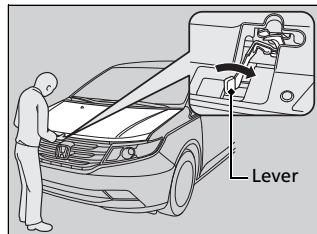

3. Slide the hood latch lever in the center of the hood to release the lock mechanism, and open the hood.

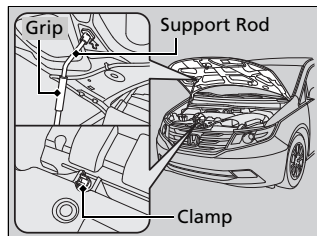

4. Remove the support rod from the clamp using the grip. Mount the support rod in the hood.

When closing, remove the support rod, and stow it in the clamp, then gently lower the hood. Remove your hand at a height of approximately 12 inches (30 cm) and let the hood close.

Opening the Hood

NOTICE

Do not open the hood when the wiper arms are raised. The hood will strike the wipers, and may damage either the hood or the wipers.

When closing the hood, check that the hood is securely latched.

If the hood latch lever moves stiffly, or if you can open the hood without lifting the lever, the latch mechanism should be cleaned and lubricated.

Recommended Engine Oil

- **Genuine Honda Motor Oil**
- **Premium-grade 0W-20 detergent oil with an API Certification Seal on the container.**



Oil is a major contributor to your engine's performance and longevity. If you drive the vehicle with insufficient or deteriorated oil, the engine may fail or be damaged.

This seal indicates the oil is energy conserving and that it meets the American Petroleum Institute's latest requirements.

Use a Genuine Honda Motor Oil or another commercial engine oil of suitable viscosity for the ambient temperature as shown.

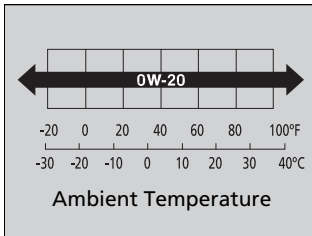

■ Synthetic oil

You may also use synthetic motor oil if it is labeled with the API Certification Seal and is the specified viscosity grade.

►► Recommended Engine Oil

Engine Oil Additives

Your vehicle does not require oil additives. In fact, they may adversely affect the engine performance and durability.

Oil Check

We recommend that you check the engine oil level every time you refuel.

Park the vehicle on level ground.

Wait approximately three minutes after turning the engine off before you check the oil.

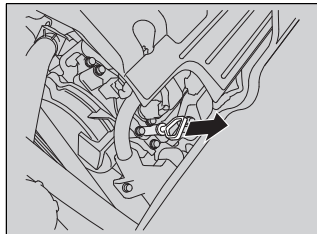

1. Remove the dipstick (orange loop).
2. Wipe the dipstick with a clean cloth or paper towel.
3. Insert the dipstick back all the way into its hole.

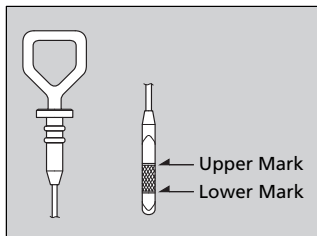

4. Remove the dipstick again, and check the level. It should be between the upper and lower marks. Add oil if necessary.

Oil Check

If the oil level is near or below the lower mark, slowly add oil being careful not to overfill.

Adding Engine Oil

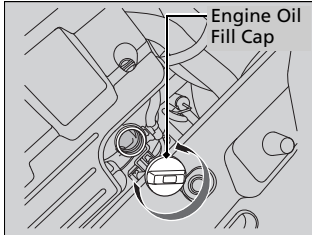

1. Unscrew and remove the engine oil fill cap.
2. Add oil slowly.
3. Reinstall the engine oil fill cap, and tighten it securely.
4. Wait for three minutes and recheck the engine oil dipstick.

►► Adding Engine Oil

If any oil spills, wipe it up immediately. Spilled oil may damage the engine compartment components.

NOTICE

Do not fill the engine oil above the upper mark. Overfilling the engine oil can result in leaks and engine damage.

Changing the Engine Oil and Oil Filter

You must change the engine oil and oil filter regularly in order to maintain the engine's lubrication. The engine may be damaged if they are not changed regularly.

Change the oil and filter in accordance with the maintenance message on the information display*/multi-information display*.

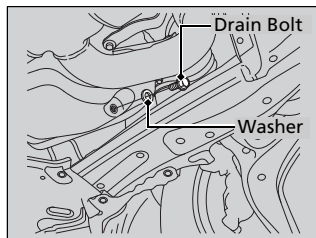

1. Run the engine until it reaches normal operating temperature, and then turn the engine off.
2. Open the hood and remove the engine oil fill cap.
3. Remove the drain bolt and washer from the bottom of the engine, and drain the oil into a suitable container.

Changing the Engine Oil and Oil Filter

NOTICE

You may damage the environment if you do not dispose of the oil in a suitable way. If you are changing the oil by yourself, appropriately dispose of the used oil. Put the oil in a sealed container and take it to a recycling center. Do not throw the oil away into a garbage can or onto the ground.

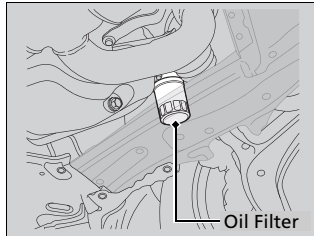

4. Remove the oil filter and dispose of the remaining oil.
5. Check that the filter gasket is not stuck to the engine contact surface.
 - If it is stuck, you must detach it.
6. Wipe away dirt and dust adhering to the contact surface of the engine block, and install a new oil filter.
 - Apply a light coat of new engine oil to the filter gasket.
7. Put a new washer on the drain bolt, then reinstall the drain bolt.
 - Tightening torque:
29 lbf·ft (39 N·m, 4.0 kgf·m)
8. Pour the recommended engine oil into the engine.
 - Engine oil change capacity (including filter):
4.5 US qt (4.3 L)
9. Reinstall the engine oil fill cap securely and start the engine.
10. Run the engine for a few minutes, and then check that there is no leak from the drain bolt or oil filter.
11. Stop the engine, wait for three minutes, and then check the oil level on the dipstick.
 - If necessary, add more engine oil.

✎ Changing the Engine Oil and Oil Filter

You will need a special wrench to replace the oil filter. You can buy this wrench from a dealer.

When installing the new oil filter, follow the instructions supplied with the oil filter.

Reinstall the engine oil fill cap. Start the engine. The low oil pressure indicator should go off within five seconds. If it does not, turn off the engine, and check your work.

Engine Coolant

Specified coolant: Honda Long Life Antifreeze/Coolant Type 2

This coolant is premixed with 50% antifreeze and 50% water. Do not add any straight antifreeze or water.

We recommend you check the engine coolant level every time you refuel. Check the reserve tank first. If it is completely empty, also check the coolant level in the radiator. Add the engine coolant accordingly.

Reserve Tank

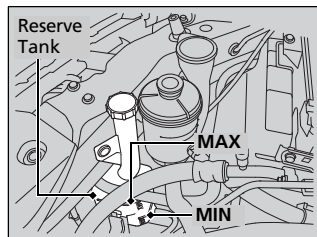

1. Check the amount of coolant in the reserve tank.

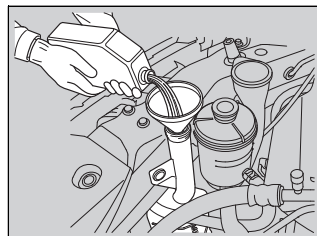

2. If the coolant level is below the **MIN** mark, add the specified coolant until it reaches the **MAX** mark.
3. Inspect the cooling system for leaks.

Engine Coolant

NOTICE

If temperatures consistently below -22°F (-30°C) are expected, the coolant mixture should be changed to a higher concentration. Consult a dealer for more information.

If Honda antifreeze/coolant is not available, you may use another major brand non-silicate coolant as a temporary replacement. Check that it is a high quality coolant recommended for aluminum engines. Continued use of any non-Honda coolant can result in corrosion, causing the cooling system to malfunction or fail. Have the cooling system flushed and refilled with Honda antifreeze/coolant as soon as possible.

Do not add rust inhibitors or other additives to your vehicle's cooling system. They may not be compatible with the coolant or with the engine components.

Radiator

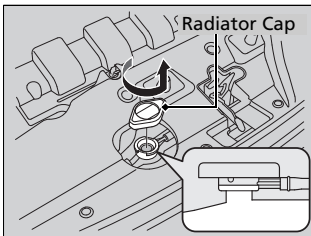

1. **Make sure the engine and radiator are cool.**
2. Turn the radiator cap counterclockwise and relieve any pressure in the coolant system. Do not push the cap down when turning.
3. Push down and turn the radiator cap counterclockwise to remove it.
4. The coolant level should be up to the base of the filler neck. Add coolant if it is low.
5. Put the radiator cap back on, and tighten it fully.
6. Pour coolant into the reserve tank until it reaches the **MAX** mark. Put the cap back on the reserve tank.

►► Radiator

⚠ WARNING

Removing the radiator cap while the engine is hot can cause the coolant to spray out, seriously scalding you.

Always let the engine and radiator cool down before removing the radiator cap.

NOTICE

Pour the fluid slowly and carefully so you do not spill any. Clean up any spills immediately; they can damage components in the engine compartment.

Transmission Fluid

Automatic Transmission Fluid

Specified fluid: Honda ATF DW-1 (automatic transmission fluid)

Check the fluid level when the engine is at normal operating temperature.

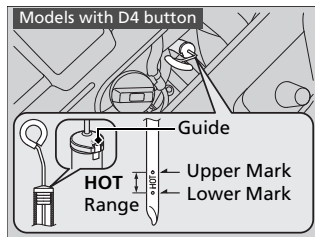
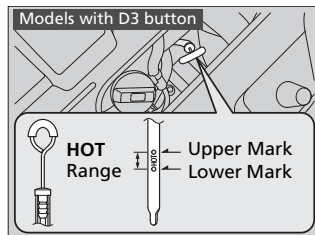

1. Park on level ground, and start the engine.
2. Wait until the radiator fan starts and then turn off the engine.
 - Perform step 3 after waiting for about 60 seconds (less than 90 seconds).
3. Remove the dipstick (yellow loop) from the transmission and wipe it with a clean cloth.
4. Insert the dipstick all the way back into the transmission securely, as shown in the image.

Models with D4 button

- Align the guides on the rubber cap and on the transmission, and push the dipstick all the way.
5. Remove the dipstick and check the fluid level.
 - It should be between the upper and lower marks in the **HOT** range.
 6. If the level is below the lower mark, add fluid into the dipstick hole to bring it to the level between the upper and lower marks, and have your vehicle checked by a dealer immediately.

Automatic Transmission Fluid

NOTICE

Do not mix Honda ATF DW-1 with other transmission fluids.

Using a transmission fluid other than Honda ATF DW-1 may adversely affect the operation and durability of your vehicle's transmission, and damage the transmission.

Any damage caused by using a transmission fluid that is not equivalent to Honda ATF DW-1 is not covered by Honda's new vehicle warranty.

NOTICE

Pour the fluid slowly and carefully so you do not spill any. Clean up any spills immediately; they can damage components in the engine compartment.

Brake Fluid

Specified fluid: Honda Heavy Duty Brake Fluid DOT 3

Use the same fluid for the brakes.

■ Checking the Brake Fluid

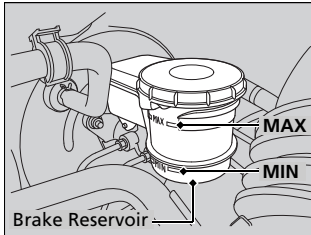

The fluid level should be between the **MIN** and **MAX** marks on the side of the reservoir.

» Brake Fluid

NOTICE

Brake fluid marked DOT 5 is not compatible with your vehicle's braking system and can cause extensive damage.

If the specified brake fluid is not available, you should use only DOT 3 or DOT 4 fluid from a sealed container as a temporary replacement.

Using any non-Honda brake fluid can cause corrosion and decrease the longevity of the system. Have the brake system flushed and refilled with Honda Heavy Duty Brake Fluid DOT 3 as soon as possible.

If the brake fluid level is at or below the **MIN** mark, have a dealer inspect for leaks or worn brake pads as soon as possible.

Power Steering Fluid Check

Specified fluid: Honda Power Steering Fluid

We recommend that you check the power steering fluid level every time you refuel. Check when the engine is not running.

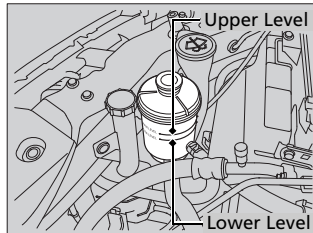

1. Look at the side of the reservoir. The fluid should be between the **UPPER LEVEL** and **LOWER LEVEL**.
2. Add power steering fluid if necessary to the **UPPER LEVEL** mark.
 - Inspect the system for a leak. If the fluid level goes below the **LOWER LEVEL** frequently, have the system inspected as soon as possible.

Refilling Window Washer Fluid

Check the amount of window washer fluid by looking at the reservoir.

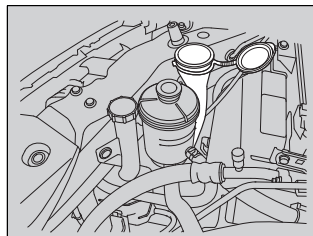

If the level is low, fill the washer reservoir.

Canadian models

If the washer fluid is low, the washer level indicator comes on.

Pour the washer fluid carefully. Do not overflow the reservoir.

Power Steering Fluid Check

NOTICE

Turning the steering wheel to full left or right lock and holding it there can damage the power steering pump.

NOTICE

Pour the fluid slowly and carefully so you do not spill any. Clean up any spills immediately; it could damage components in the engine compartment.

Refilling Window Washer Fluid

NOTICE

Do not use engine antifreeze or a vinegar/water solution in the windshield washer reservoir. Antifreeze can damage your vehicle's paint. A vinegar/water solution can damage the windshield washer pump.

Headlight Bulbs

When replacing, use the following bulbs.

High beam headlight: 60 W (HB3)

Low beam headlight: 55 W (H11 for halogen bulb type)

Low beam headlight: 35 W (D2S for high voltage discharge type)

High Beam Headlight

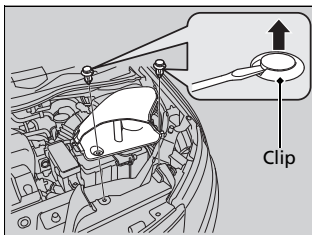

Driver's side

1. Remove the clips using a flat-tip screwdriver, then remove the upper part of the air intake duct.

Headlight Bulbs

NOTICE

Halogen bulbs get very hot when lit. Oil, perspiration, or a scratch on the glass can cause the bulb to overheat and shatter.

The headlight aim is set by the factory, and does not need to be adjusted. However, if you regularly carry heavy items in the cargo area or tow a trailer, have the aiming readjusted at a dealer or by a qualified technician.

The HB3 and H11 types are halogen bulbs. When replacing a bulb, handle it by its base, and protect the glass from contact with your skin or hard objects. If you touch the glass, clean it with denatured alcohol and a clean cloth.

The exterior lights' inside lenses (headlights, brake lights, etc.) may fog temporarily after a car wash or while driving in the rain. This does not impact the exterior light function. However, if you see a large amount of water or ice accumulated inside the lenses, have your vehicle inspected by a dealer.

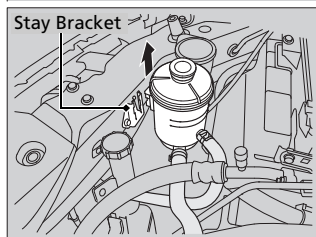
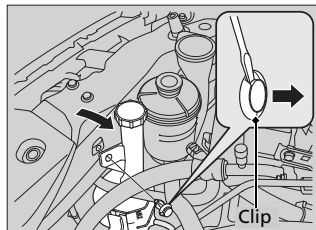

Passenger's side

1. Remove the clips using a flat-tip screwdriver, then remove the engine coolant reservoir out of its stay.

Remove the power steering reservoir from the stay bracket.

High Beam Headlight

Holding clip

Insert a flat-tip screwdriver, lift and remove the central pin to remove the clip.

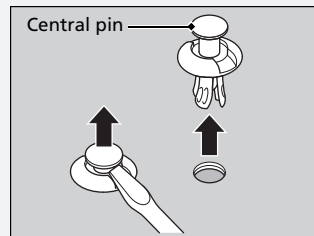

Insert the clip with the central pin raised, and push until it is flat.

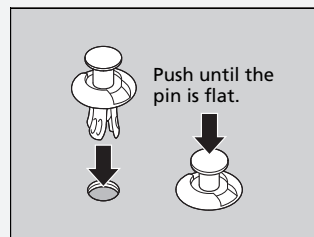

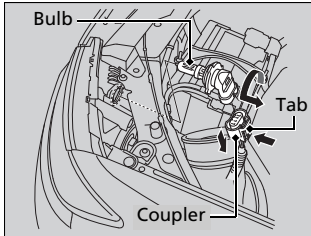

2. Remove the coupler.
 - ▶ It can be removed by pushing the tab.
3. Rotate the old bulb to the left to remove.
4. Insert a new bulb into the headlight assembly and turn it to the right.
5. Insert the coupler into the connector of the bulb.

Models with high voltage discharge tube bulbs

Low Beam Headlights

High voltage can remain in the circuit for a long period of time after the light is switched off. Do not attempt to inspect or replace the high voltage discharge type bulbs yourself. Ask a dealer to inspect and replace low beam headlights.

Models with halogen low beam headlight bulbs

Low Beam Headlights

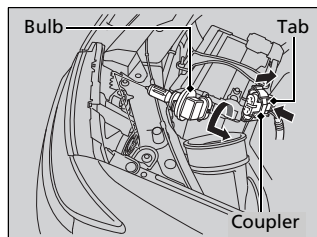

1. Remove the coupler.
 - It can be removed by pushing the tab.
2. Rotate the old bulb to the left to remove.
3. Insert a new bulb into the headlight assembly and turn it to the right.
4. Insert the coupler into the connector of the bulb.

Fog Light Bulbs*

When replacing, use the following bulbs.

Fog Light: 55 W (H11)

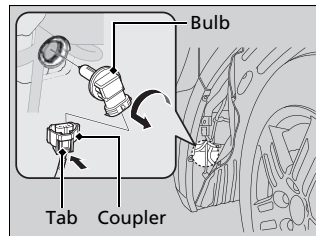
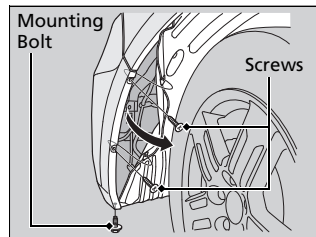

1. Turn the steering wheel all the way to the opposite side from the fog light being replaced.
Passenger side: Turn the steering wheel to the left.
Driver side: Turn the steering wheel to the right.
2. Remove the mounting bolt and screws, and pull the inner fender back.
3. Remove the coupler.
 ► It can be removed by pushing the tab.
4. Rotate the old bulb to the left to remove.
5. Insert a new bulb into the fog light assembly and turn it to the right.
6. Insert the coupler into the connector of the bulb.

► Fog Light Bulbs*

NOTICE

Halogen bulbs get very hot when lit. Oil, perspiration, or a scratch on the glass can cause the bulb to overheat and shatter.

The fog lights are halogen bulbs. When replacing a bulb, handle it by its plastic case, and protect the glass from contact with your skin or hard objects. If you touch the glass, clean it with denatured alcohol and a clean cloth.

* Not available on all models

Front Turn Signal/Parking/Side Marker Light Bulbs

When replacing, use the following bulbs.

Front Turn Signal/Parking/Side Marker Light: 28/8 W

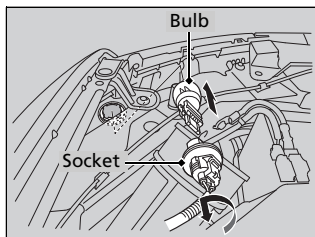

1. Turn the socket to the left and remove it.
2. Remove the old bulb and insert a new bulb.

Brake/Rear Side Marker/Taillight and Rear Turn Signal Light Bulbs

When replacing, use the following bulbs.

Brake/Rear Side Marker/Taillight: 21/5 W
Rear Turn Signal Light: 21 W (Amber)

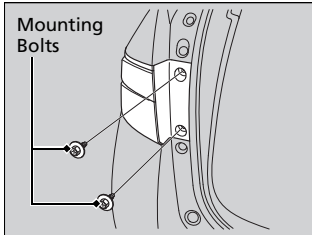

1. Remove the mounting bolts.

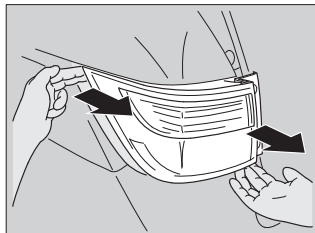

2. Place one hand on the outer corner of the taillight assembly and other hand on the lower edge of the taillight, near the cargo area.
3. Pull the outer corner of the taillight assembly toward you while supporting the assembly with the hand closest to the cargo area.
4. Turn the socket to the left and remove it.
5. Remove the old bulb and insert a new bulb.

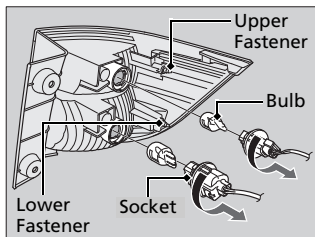

► Brake/Rear Side Marker/Taillight and Rear Turn Signal Light Bulbs

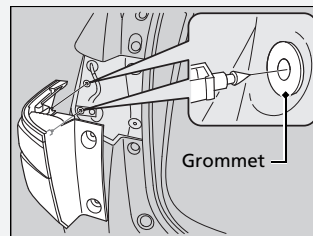

To reinstall, insert the fasteners into the grommets and push the assembly back into place.
► Do not reinstall the assembly if the grommets are loose or out of the holes. Contact a dealer to replace them.

Back-Up/Taillight Bulbs

When replacing, use the following bulbs.

Back-Up Light: 21 W
Taillight: 3CP

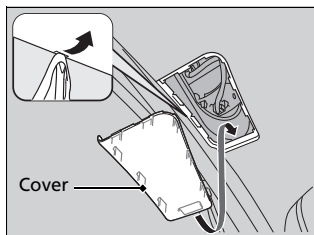

1. Remove the cover by prying on the edge of the cover using a flat-tip screwdriver.
 - ▶ Wrap the flat-tip screwdriver with a cloth to prevent scratches.

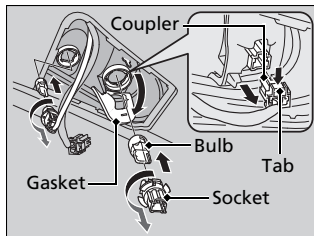

2. Remove the coupler.
 - ▶ It can be removed by pushing the tab.
3. Remove the base gasket.
4. Turn the socket to the left and remove it.
5. Remove the old bulb and insert a new bulb.

Rear License Plate Light Bulbs

When replacing, use the following bulbs.

Rear License Plate Light: 5 W

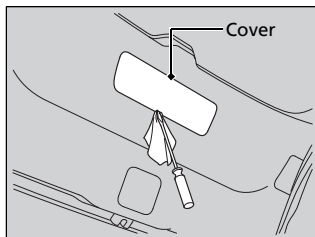

1. Remove the cover by prying on the edge of the cover using a flat-tip screwdriver.
 - Wrap the flat-tip screwdriver with a cloth to prevent scratches.

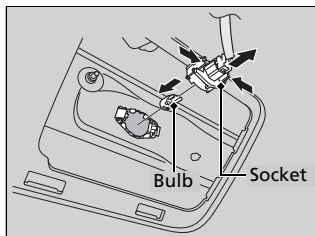

2. Remove the license plate light assembly by squeezing the tabs on both sides of the socket.
3. Remove the old bulb and insert a new bulb.

High-Mount Brake Light Bulb

When replacing, use the following bulb.

High-Mount Brake Light: 16 W

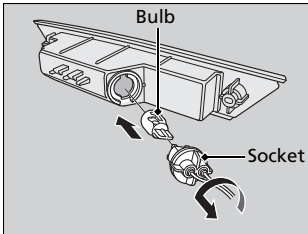
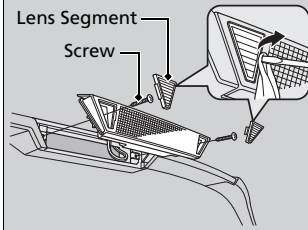

1. Remove the lens segment by prying on the edge using a flat-tip screwdriver.
 - ▶ Wrap the flat-tip screwdriver with a cloth to prevent scratches.
2. Turn the socket to the left and remove it.
3. Remove the old bulb and insert a new bulb.

Checking Wiper Blades

If the wiper blade rubber has deteriorated, it will leave streaks and the metal wiper arm may scratch the window glass.

Changing the Wiper Blade Rubber

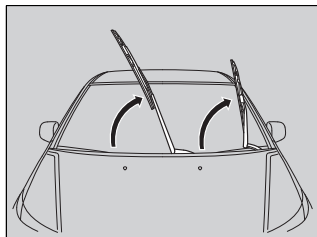

1. Lift the driver side wiper arm first, then the passenger side.

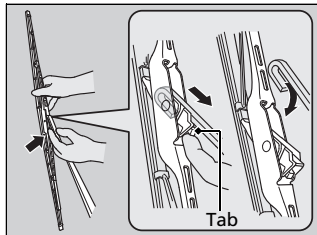

2. Press and hold the tab, then slide the blade from the wiper arm.

Changing the Wiper Blade Rubber

NOTICE

Avoid dropping the wiper arm; it may damage the windshield.

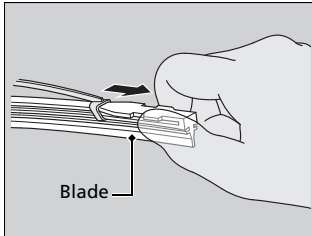

3. Slide the wiper blade out from its holder by pulling the tabbed end out.

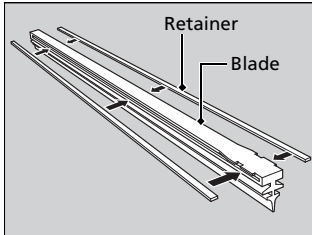

4. Remove the retainers from the rubber blade that has been removed, and mount to a new rubber blade.

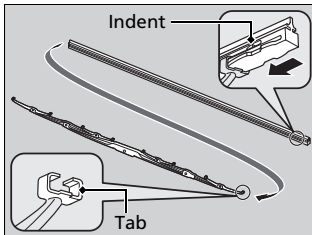

5. Slide the new wiper blade onto the holder from the bottom end.

▶ The tab on the holder should fit in the indent of the wiper blade.

6. Slide the wiper blade onto the wiper arm until it clicks.

7. Lower the passenger side wiper arm first, then the driver side.

Changing the Rear Wiper Blade Rubber

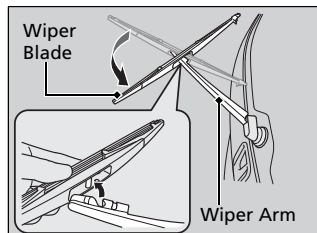

1. Raise the wiper arm off.
2. Pivot the bottom end of the wiper blade up until it comes off from the wiper arm.

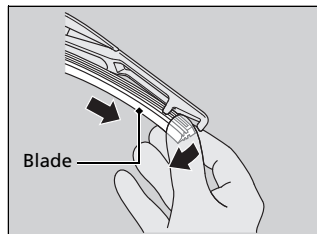

3. Slide the blade out of the wiper.

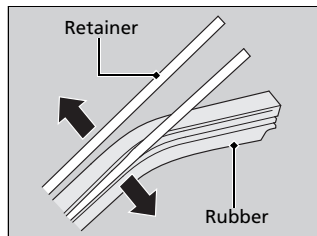

4. Remove the retainers from wiper blade and mount it to a new rubber blade.

Changing the Rear Wiper Blade Rubber

NOTICE

Avoid dropping the wiper arm, it may damage the rear window.

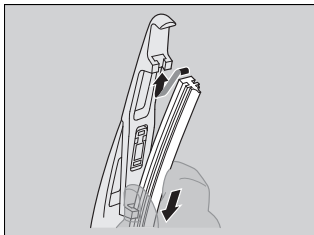

5. Slide the new wiper blade onto the holder.
 - ▶ Make sure it is engaged correctly, then install the wiper blade assembly onto the wiper arm.

Checking Tires

To safely operate your vehicle, your tires must be of the proper type and size, in good condition with adequate tread, and properly inflated.

■ Inflation guidelines

Properly inflated tires provide the best combination of handling, tread life, and comfort. Refer to the driver's doorjamb label or specification's page for the specified pressure.

Underinflated tires wear unevenly, adversely affect handling and fuel economy, and are more likely to fail from overheating.

Overinflated tires make your vehicle ride harshly, are more prone to road hazards, and wear unevenly.

Every day before you drive, look at each of the tires. If one looks lower than the others, check the pressure with a tire gauge.

At least once a month or before long trips, use a gauge to measure the pressure in all tires, including the spare. Even tires in good condition can lose 1 to 2 psi (10 to 20 kPa, 0.1 to 0.2 kgf/cm²) per month.

■ Inspection guidelines

Every time you check inflation, also examine the tires and valve stems.

Look for:

- Bumps or bulges on the side or in the tread. Replace the tire if you find any cuts, splits, or cracks in the side of the tire. Replace it if you see fabric or cord.
- Remove any foreign objects and inspect for air leaks.
- Uneven tread wear. Have a dealer check the wheel alignment.
- Excessive tread wear.

📖 **Wear Indicators** P. 367

- Cracks or other damage around valve stem.

📖 Checking Tires

⚠️ WARNING

Using tires that are excessively worn or improperly inflated can cause a crash in which you can be seriously hurt or killed.

Follow all instructions in this owner's manual regarding tire inflation and maintenance.

Measure the air pressure when tires are cold. This means the vehicle has been parked for at least three hours, or driven less than 1 mile (1.6 km). If necessary, add or release air until the specified pressure is reached.

If checked when hot, tire pressure can be as much as 4–6 psi (30–40 kPa, 0.3–0.4 kgf/cm²) higher than if checked when cold.

Have a dealer check the tires if you feel a consistent vibration while driving. New tires and any that have been removed and reinstalled should be properly balanced.

Tire and Loading Information Label

The label attached to the driver's doorjamb provides necessary tire and loading information.

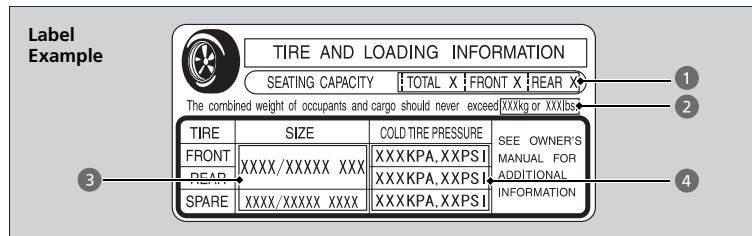

▶▶ Tire and Loading Information Label

The tire and loading information label attached to the driver's doorjamb contains:

- 1 The number of people your vehicle can carry.
- 2 The total weight your vehicle can carry. Do not exceed this weight.
- 3 The original tire sizes for front, rear, and spare.
- 4 The proper cold tire pressure for front, rear, and spare.

Tire Labeling

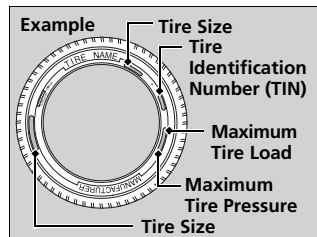

The tires that came on your vehicle have a number of markings. Those you should be aware of are described below.

■ Tire Sizes

Whenever tires are replaced, they should be replaced with tires of the same size.

▶▶ Tire Sizes

Following is an example of tire size with an explanation of what each component means.

P235/60 R18 102T

P: Vehicle type (P indicates passenger vehicle).

235: Tire width in millimeters.

60: Aspect ratio (the tire's section height as a percentage of its width).

R: Tire construction code (R indicates radial).

18: Rim diameter in inches.

102: Load index (a numerical code associated with the maximum load the tire can carry).

T: Speed symbol (an alphabetical code indicating the maximum speed rating).

■ Tire Identification Number (TIN)

The tire identification number (TIN) is a group of numbers and letters that look like the example in the side column. TIN is located on the sidewall of the tire.

■ Glossary of Tire Terminology

Cold Tire Pressure – The tire air pressure when the vehicle has been parked for at least three hours or driven less than 1 mile (1.6 km).

Load Rating – Means the maximum load that a tire is rated to carry for a given inflation pressure.

Maximum Inflation Pressure – The maximum tire air pressure that the tire can hold.

Maximum Load Rating – Means the load rating for a tire at the maximum permissible inflation pressure for that tire.

Recommended Inflation Pressure – The cold tire inflation pressure recommended by the manufacturer.

Treadwear Indicators (TWI) – Means the projections within the principal grooves designed to give a visual indication of the degrees of wear of the tread.

☒ Tire Identification Number (TIN)

DOT B97R FW6X 2209

DOT: This indicates that the tire meets all requirements of the U.S. Department of Transportation.

B97R: Manufacturer's identification mark.

FW6X: Tire type code.

22 09: Date of manufacture.

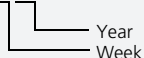

DOT Tire Quality Grading (U.S. Vehicles)

The tires on your vehicle meet all U.S. Federal Safety Requirements. All tires are also graded for treadwear, traction, and temperature performance according to Department of Transportation (DOT) standards. The following explains these gradings.

■ Uniform Tire Quality Grading

Quality grades can be found where applicable on the tire sidewall between tread shoulder and maximum section width.

■ Treadwear

The treadwear grade is a comparative rating based on the wear rate of the tire when tested under controlled conditions on a specified government test course. For example, a tire graded 150 would wear one and one-half (1 1/2) times as well on the government course as a tire graded 100. The relative performance of tires depends upon the actual conditions of their use, however, and may depart significantly from the norm due to variations in driving habits, service practices and differences in road characteristics and climate.

▣ Uniform Tire Quality Grading

For example:

Treadwear 200
Traction AA
Temperature A

All passenger car tires must conform to Federal Safety Requirements in addition to these grades.

■ Traction

The traction grades, from highest to lowest, are AA, A, B, and C. Those grades represent the tire's ability to stop on wet pavement as measured under controlled conditions on specified government test surfaces of asphalt and concrete. A tire marked C may have poor traction performance.

■ Temperature

The temperature grades are A (the highest), B, and C, representing the tire's resistance to the generation of heat and its ability to dissipate heat when tested under controlled conditions on a specified indoor laboratory test wheel. Sustained high temperature can cause the material of the tire to degenerate and reduce tire life, and excessive temperature can lead to sudden tire failure. The grade C corresponds to a level of performance which all passenger car tires must meet under the Federal Motor Vehicle Safety Standard No. 109. Grades B and A represent higher levels of performance on the laboratory test wheel than the minimum required by law.

⊗ Traction

Warning: The traction grade assigned to this tire is based on straight-ahead braking traction tests, and does not include acceleration, cornering, hydroplaning, or peak traction characteristics.

⊗ Temperature

Warning: The temperature grade for this tire is established for a tire that is properly inflated and not overloaded. Excessive speed, underinflation, or excessive loading, either separately or in combination, can cause heat buildup and possible tire failure.

Wear Indicators

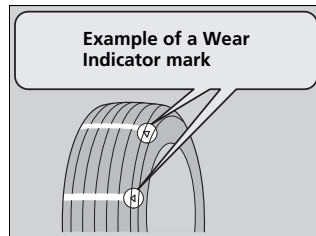

The groove where the wear indicator is located is 1/16 inch (1.6 mm) shallower than elsewhere on the tire. If the tread has worn so that the indicator is exposed, replace the tire.

Worn out tires have poor traction on wet roads.

Tire Service Life

The life of your tires is dependent on many factors, including driving habits, road conditions, vehicle loading, inflation pressure, maintenance history, speed, and environmental conditions (even when the tires are not in use).

In addition to regular inspections and inflation pressure maintenance, it is recommended that you have annual inspections performed once the tires reach five years old. All tires, including the spare, should be removed from service after 10 years from the date of manufacture, regardless of their condition or state of wear.

☒ Checking Tires

High speed driving

We recommend that you do not drive faster than the posted speed limits and conditions allow. If you drive at sustained high speeds (over 99 mph or 160 km/h), adjust the cold tire pressures as shown below to avoid excessive heat build up and sudden tire failure.

Tire Size	P235/65R17 103T
Pressure	Front: 33 psi (230 kPa, 2.3 kgf/cm ²) Rear: 35 psi (240 kPa, 2.4 kgf/cm ²)

Tire Size	P235/60R18 102T
Pressure	Front: 35 psi (240 kPa, 2.4 kgf/cm ²) Rear: 36 psi (250 kPa, 2.5 kgf/cm ²)

Tire and Wheel Replacement

Replace your tires with radials of the same size, load range, speed rating, and maximum cold tire pressure rating (as shown on the tire's sidewall). Using tires of a different size or construction can cause the ABS and VSA® (vehicle stability assist) system to work incorrectly.

It is best to replace all four tires at the same time. If that isn't possible, replace the front or rear tires in pairs.

If you replace a wheel, only use TPMS specified wheels approved for your vehicle. Make sure that the wheel's specifications match those of the original wheels.

📖 Tire and Wheel Replacement

WARNING

Installing improper tires on your vehicle can affect handling and stability. This can cause a crash in which you can be seriously hurt or killed.

Always use the size and type of tires recommended in this owner's manual.

Tire Rotation

Rotating tires according to the maintenance messages on the information display*/ multi-information display* helps to distribute wear more evenly and increase tire life.

■ Tires without rotation marks

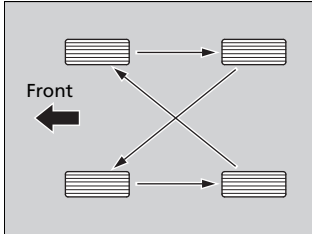

Rotate the tires as shown here.

■ Tires with rotation marks

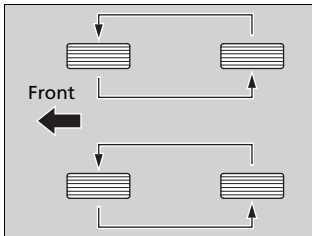

Rotate the tires as shown here.

☒ Tire Rotation

Tires with directional tread patterns should only be rotated front to back (not from one side to the other). Directional tires should be mounted with the rotation indication mark facing forward, as shown below.

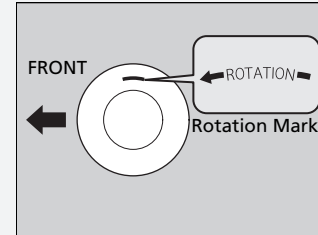

* Not available on all models

Winter Tires

If driving on snowy or frozen roads, mount all season marked “M+S” tires, snow tires, or tire chains; reduce speed; and maintain sufficient distance between vehicles when driving.

Be particularly careful when operating the steering wheel or brakes to prevent skidding.

Use tire chains, snow tires, or all season tires when necessary or according to the law.

When mounting, refer to the following points.

For winter tires:

- Select the size and load ranges that are the same as the original tires.
- Mount the tires to all four wheels.

For tire chains:

- Install them on the front tires only.
- Because your vehicle has limited tire clearance, we strongly recommend using the chains listed below:

Cable-type: SCC Super Z-6# SZ-429

- Follow the chain manufacturer's instruction when installing. Mount them as tightly as you can.
- Check that the chains do not touch the brake lines or suspension.
- Drive slowly.

Winter Tires

⚠ WARNING

Using the wrong chains, or not properly installing chains, can damage the brake lines and cause a crash in which you can be seriously injured or killed.

Follow all instructions in this owner's manual regarding the selection and use of tire chains.

NOTICE

Traction devices that are the wrong size or improperly installed can damage your vehicle's brake lines, suspension, body, and wheels. Stop driving if they are hitting any part of the vehicle.

When tire chains are mounted, follow the chain manufacturer's instructions regarding vehicle operational limits.

If your vehicle is equipped with summer tires, be aware that these tires are not designed for winter driving conditions. For more information, contact a dealer.

Checking the Battery

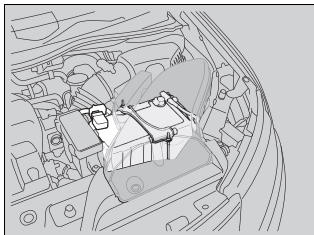

The battery condition is being monitored by the sensor on the negative terminal. If there is a problem with the sensor, the warning message on information display*/multi-information display* will let you know. Have your vehicle checked by a dealer.

Check the battery terminals for corrosion monthly.

If your vehicle's battery is disconnected or goes dead:

- The audio system is disabled.
 - **Reactivating the audio system** P. 196
- The clock resets.
 - **Setting the Clock** P. 108
- The navigation system* is disabled.
 - **Refer to the navigation system manual**

Charging the Battery

Disconnect both battery cables to prevent damaging your vehicle's electrical system. Always disconnect the negative (-) cable first, and reconnect it last.

* Not available on all models

ⓘ Battery

⚠ WARNING

The battery gives off explosive hydrogen gas during normal operation.

A spark or flame can cause the battery to explode with enough force to kill or seriously hurt you.

When conducting any battery maintenance, wear protective clothing and a face shield, or have a skilled technician do it.

WARNING: Battery post, terminals, and related accessories contain lead and lead compounds.
Wash your hands after handling.

When you find corrosion, clean the battery terminals by applying a baking powder and water solution. Clean terminals with a damp towel. Cloth/towel dry the battery. Coat the terminals with grease to help prevent future corrosion.

Replacing the Button Battery

If the indicator does not come on when the button is pressed, replace the battery.

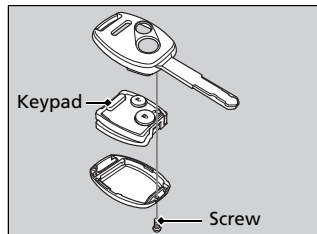

Battery type: CR1616

1. Unscrew the cover with a small Phillips-head screwdriver. Press a button to pry open the transmitter.
2. Open the keypad.
 - ▶ Separate the inner cover from the keypad by releasing the two tabs on the cover.
3. Make sure to replace the battery with the correct polarity.

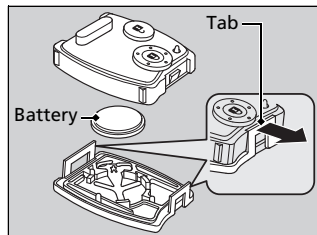

Replacing the Button Battery

NOTICE

An improperly disposed of battery can damage the environment. Always confirm local regulations for battery disposal.

Replacement batteries are commercially available or at a dealer.

Models with power sliding door

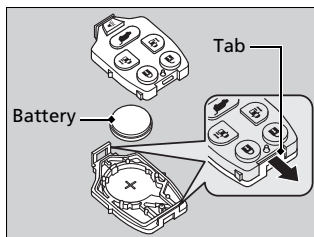
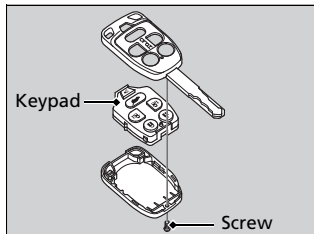

Battery type: CR2025

1. Unscrew the cover with a small Phillips-head screwdriver. Press a button to pry open the transmitter.
2. Open the keypad.
 - ▶ Separate the inner cover from the keypad by releasing the two tabs on the cover.
3. Make sure to replace the battery with the correct polarity.

» Replacing the Button Battery

NOTICE

An improperly disposed of battery can damage the environment. Always confirm local regulations for battery disposal.

Replacement batteries are commercially available or at a dealer.

Models with Rear Entertainment System

Replacing the Battery

Remote Control

If it takes several pushes on the remote control buttons to operate the rear entertainment system.

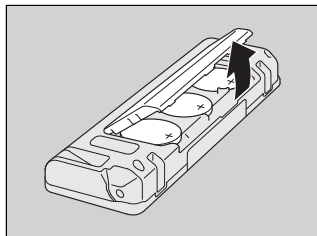

Battery type: BR3032

1. Remove the cover.
2. Make sure to replace the battery with the correct polarity.

Replacing the Battery

NOTICE

An improperly disposed of battery can damage the environment. Always confirm local regulations for battery disposal.

Replacement batteries are commercially available or at a dealer.

■ Wireless Headphone

If there is no sound coming from the wireless headphone, replace the battery.

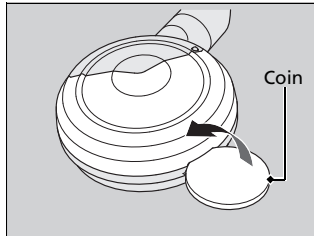

Battery type: AAA

1. To open the cover, insert a coin in the slot and twist it slightly to pry the cover away from the earpiece.
2. Make sure to replace the battery with the correct polarity.

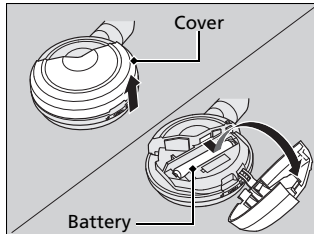

Dust and Pollen Filter

The heating and cooling system/climate control system is equipped with a dust and pollen filter that collects pollen, dust, and other debris in the air. The Maintenance Minder™ messages will let you know when to replace the filter.

We recommend that you replace the dust and pollen filter sooner when using your vehicle in areas with high concentrations of dust.

☒ Dust and Pollen Filter

If the airflow from the heating and cooling system/climate control system deteriorates noticeably, and the windows fog up easily, the filter may need to be replaced. Please contact a dealer for replacement.

Interior Care

Use a damp cloth with a mixture of mild detergent and warm water to remove dirt.
Use a clean cloth to remove detergent residue.

Cleaning Seat Belts

Use a soft brush with a mixture of mild soap and warm water to clean the seat belts.
Let the belts air dry. Wipe the openings of the seat belt anchors using a clean cloth.

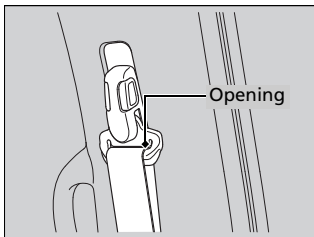

Interior Care

Do not spill liquids inside the vehicle.
Electrical devices and systems may malfunction if liquids are splashed on them.

Do not use silicone based sprays on electrical devices such as audio devices and switches.
Doing so may cause the items to malfunction or a fire inside the vehicle.

If a silicone based spray is inadvertently used on electrical devices, consult a dealer.

Depending on their composition, chemicals and liquid aromatics may cause discoloration, wrinkles, and cracking to resin-based parts and textiles.
Do not use alkali solvents or organic solvents such as benzene or gasoline.

After using chemicals, make sure to gently wipe them off using a dry cloth.

Do not place used cloths on top of resin based parts or textiles for long periods of time without washing.

Floor Mats

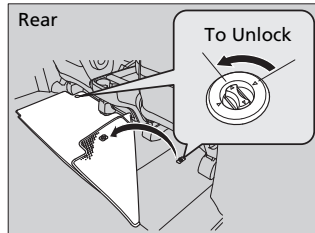
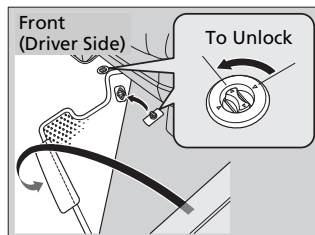

The front and second row passenger's floor mats hook over the floor anchors, which keep the mats from sliding forward. To remove a mat for cleaning, turn the anchor knobs to the unlock position. When reinstalling the mat after cleaning, turn the knobs to the lock position.

Do not put additional floor mats on top of the anchored mats.

Maintaining Genuine Leather*

Vacuum dirt and dust from the leather frequently. Pay close attention to the pleats and seams. Clean the leather with a soft cloth dampened with a 90% water and 10% neutral soap solution. Then buff it with a clean, dry cloth. Remove any dust or dirt on leather surfaces immediately.

Floor Mats

If you use any floor mats that were not originally provided with your vehicle, make sure they are designed for your specific vehicle, fit correctly, and are securely anchored by the floor anchors. Position the rear seat floor mat properly. If they are not properly positioned, the floor mat can interfere with the front seat functions.

Exterior Care

Dust off the vehicle body after you drive.

Regularly inspect your vehicle for scratches on painted surfaces. A scratch on a painted surface can result in body rust. If you find a scratch, promptly repair it.

■ Washing the Vehicle

Wash the vehicle regularly. Wash more frequently when driving in the following conditions:

- If driving on roads with road salt.
- If driving in coastal areas.
- If tar, soot, bird droppings, insects, or tree sap are stuck to painted surfaces.

■ Using an Automated Car Wash

Fold in the door mirrors. Make sure to follow the instructions indicated on the automated car wash.

■ Using High Pressure Cleaners

- Keep sufficient distance between the cleaning nozzle and the vehicle body.
- Take particular care around the windows. Standing too close may cause water to enter the vehicle interior. Do not spray water into the engine compartment.

▶▶ Washing the Vehicle

Do not spray water into the air intake vents or engine compartment. It can cause a malfunction.

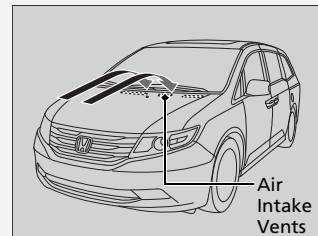

■ Applying Wax

A good coat of automotive body wax helps protect your vehicle's paint from the elements. Wax will wear off over time and expose your vehicle's paint to the elements, so reapply as necessary.

■ Maintaining the Bumpers and Other Resin Coated Parts

If you get gasoline, oil, engine coolant, or battery fluid on resin coated parts, they may be stained or the coating may peel. Promptly wipe it away using a soft cloth and clean water.

■ Cleaning the Window

Wipe using a glass cleaner.

■ Maintaining Aluminum Wheels*

Aluminum is susceptible to deterioration caused by salt and other road contaminants. Use a sponge and mild detergent to wipe away promptly. Be careful not to use harsh chemicals (including some commercial wheel cleaners) or a stiff brush. They can damage the clear coat of the aluminum alloy wheels that helps keep the aluminum from corroding and tarnishing.

⊗ Applying Wax

NOTICE

Chemical solvents and strong cleaners can damage the paint, metal, and plastic on your vehicle. Wipe up spills immediately.

⊗ Maintaining the Bumpers and Other Resin Coated Parts

Ask a dealer about the correct coating material when you want to repair the painted surface of the parts made of resin.

⊗ Cleaning the Window

Wires are mounted to the inside of the rear window. Wipe along the same direction as the wires with a soft cloth so as not to damage them.

Handling the Unexpected

This chapter explains how to handle unexpected troubles.

Tools	
Types of Tools.....	382
If a Tire Goes Flat	
Changing a Flat Tire.....	383
Engine Does Not Start	
Checking the Engine.....	392
Jump Starting	393
Shift Lever Does Not Move	395
Overheating	
How to Handle Overheating.....	396

Indicator, Coming On/Blinking	
If the Low Oil Pressure Indicator Comes On.....	398
If the Charging System Indicator Comes On.....	398
If the Malfunction Indicator Lamp Comes On or Blinks.....	399
If the Brake System Indicator Comes On.....	400
If the Low Tire Pressure Indicator Comes On.....	401
If the TPMS Indicator Comes On.....	401

If the Low Tire Pressure/TPMS Indicator Comes On or Blinks.....	402
Fuses	
Fuse Locations.....	403
Inspecting and Changing Fuses.....	408
Emergency Towing	409
When You Cannot Open or Close the Tailgate	410

Types of Tools

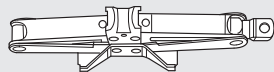
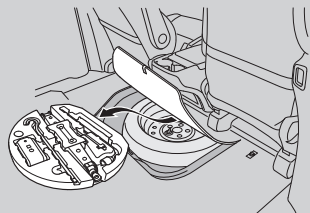

Jack



Bracket

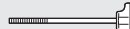

Mounting Wing Bolt (B)

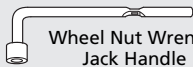

Wheel Nut Wrench/
Jack Handle



Mounting Wing Bolt (A)



Storage Bag

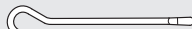

Jack Handle Bar

Types of Tools

The tools were stored under the second row seat.

Changing a Flat Tire

If a tire goes flat while driving, grasp the steering wheel firmly, and brake gradually to reduce speed. Then, stop in a safe place. Replace the flat tire with a compact spare tire. Go to a dealer as soon as possible to have the full-size tire repaired or replaced.

1. Park the vehicle on firm, level, non-slippery surface and apply the parking brake.
2. Move the shift lever to **[P]**.
3. Turn on the hazard warning lights and turn the ignition switch to LOCK **[0]**.

Changing a Flat Tire

Periodically check the tire pressure of the compact spare. It should be set to the specified pressure.
Specified Pressure: 60 psi (420 kPa, 4.2 kgf/cm²)

When driving with the compact spare tire, keep the vehicle speed under 50 mph (80 km/h). Replace with a full-size tire as soon as possible.

The compact spare tire and wheel in your vehicle are specifically for this model.

Do not use them with another vehicle.

Do not use another type of compact spare tire or wheel with your vehicle.

Do not mount tire chains on a compact spare tire. If a chain-mounted front tire goes flat, remove one of the full-size rear tires and replace it with the compact spare tire. Remove the flat front tire and replace it with the full-size tire that was removed from the rear. Mount the tire chains on the front tire.

U.S. models only

Do not use a puncture-repairing agent on a flat tire, as it can damage the tire pressure sensor.

Getting Ready to Replace the Flat Tire

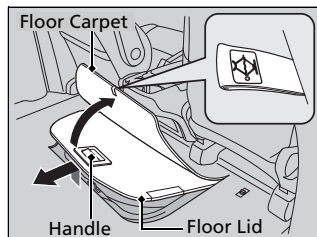

1. Remove the floor mat under the second row seat.

► **Floor Mats** P. 378

2. Pull up the floor carpet.

3. Lift up the floor lid using the handle and remove it.

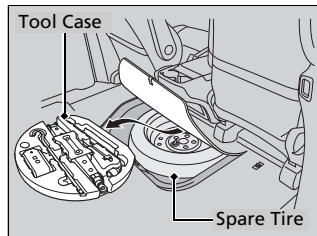

4. Take the tool case out of the spare tire well. Take the jack and wheel nut wrench out of the tool case.

5. Unscrew the wing bolt, and remove the spacer cone. Then, remove the spare tire.

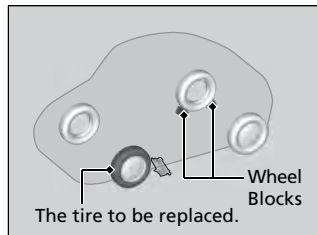

6. Place a wheel block or rock in front and rear of the wheel diagonal to the flat tire.

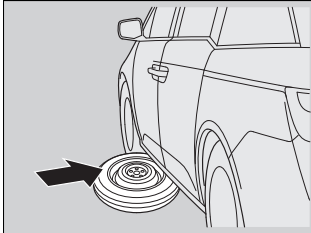

7. Place the compact spare tire (wheel side up) under the vehicle body, near the tire that needs to be replaced.

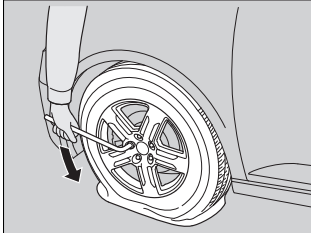

8. Loosen each wheel nut about one turn using the wheel nut wrench.

How to Set Up the Jack

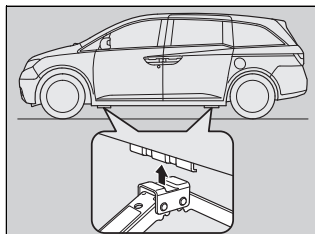

1. Place the jack under the jacking point closest to the tire to be changed.

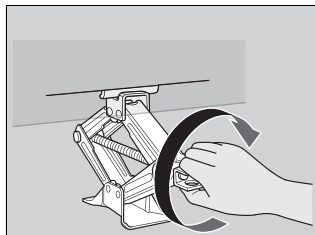

2. Turn the end bracket (as shown in the image) clockwise until the top of the jack contacts the jacking point.
 - Make sure that the jacking point tab is resting in the jack notch.

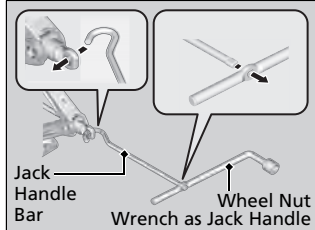

3. Raise the vehicle, using the jack handle bar and the jack handle, until the tire is off the ground.

How to Set Up the Jack

⚠ WARNING

The vehicle can easily roll off the jack, seriously injuring anyone underneath.

Follow the directions for changing a tire exactly, and never get under the vehicle when it is supported only by the jack.

Do not use the jack with people or luggage in the vehicle.

Use the jack provided in your vehicle. Other jacks may not support the weight ("load") or their shape may not match.

The following instructions must be followed to use the jack safely.

- Do not use while the engine is running.
- Use only where the ground is firm and level.
- Use only at the jacking points.
- Do not get in the vehicle while using the jack.
- Do not put anything on top of or underneath the jack.

Replacing the Flat Tire

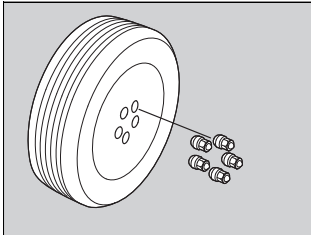

Models with aluminum wheels

1. Remove the wheel nuts and flat tire.

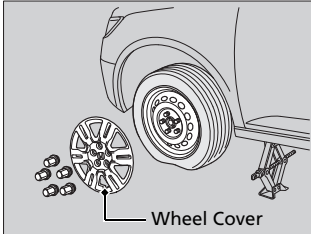

Models with wheel cover

1. Remove the wheel nuts, wheel cover, and flat tire.

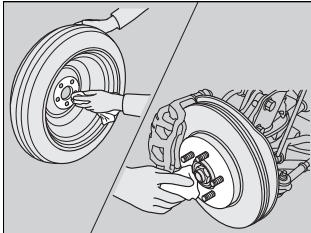

All models

2. Wipe the mounting surfaces of the wheel with a clean cloth.
3. Mount the compact spare tire.
4. Screw the wheel nuts until they touch the lips around the mounting holes, and stop rotating.

Replacing the Flat Tire

Do not over tighten the wheel nuts by applying extra torque using your foot or a pipe.

Models with wheel cover

Do not attempt to forcibly pry the wheel cover off with a screwdriver or other tool. The wheel cover cannot be removed without first removing the wheel nuts.

Continued

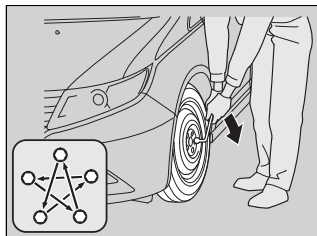

5. Lower the vehicle and remove the jack. Tighten the wheel nuts in the order indicated in the image. Go around, tightening the nuts, two to three times in this order.

Wheel nut torque:

94 lbf·ft (127 N·m, 13 kgf·m)

Storing the Flat Tire

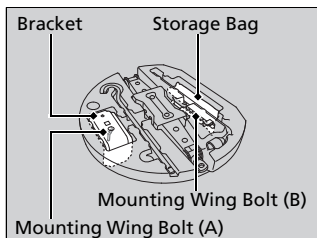

The storage bag, bracket, mounting wing bolt (A) and mounting wing bolt (B) are in the tool case.

1. Put the flat tire in the storage bag provided with your vehicle.

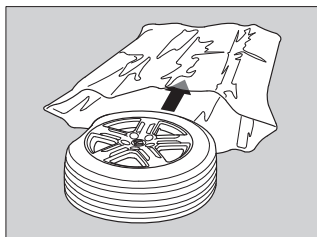

Storing the Flat Tire

⚠ WARNING

Loose items can fly around the interior in a crash and can seriously injure the occupants. Store the wheel, jack, and tools securely before driving.

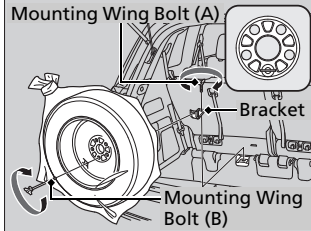
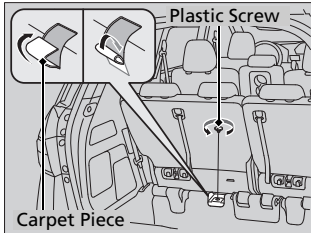

2. Pull down the U-shaped carpet piece, fold it, and tuck the end under the carpet.
3. Remove the plastic screw with a coin.
4. Install the bracket and the mounting wing bolt (A) on the attachment point, and tighten the bolt.
5. Install the flat tire on the bracket with the inside of the wheel facing toward you.
6. Install the mounting wing bolt (B) to the bracket through one of the five wheel nut holes, and tighten the bolt.
 - Poke a hole in the storage bag as needed.

■ **Storing a flat tire on the folded third row seat**

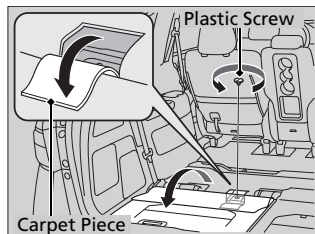

1. Turn over the flap on the left side of the cargo area floor.
2. Pull down the U-shaped carpet piece and remove the plastic screw with a coin.

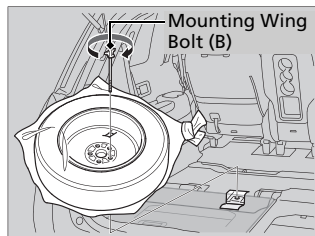

3. Place the flat tire face down on the attachment point.
4. Put the tire mounting wing bolt (B) in the attachment point through one of the five wheel nut holes, and tighten the bolt.
 - Poke a hole in the storage bag as needed.

TPMS and the Spare Tire

Models with information display

If you replace a flat tire with the spare tire, the low tire pressure indicator comes on while you are driving. After driving for a few miles (kilometers), the indicator will go off and the TPMS indicator comes on, but this is normal.

If you replace the tire with a specified regular tire, the low tire pressure or TPMS indicator will go off after a few miles (kilometers).

Models with multi-information display

If you replace a flat tire with the spare tire, the low tire pressure/TPMS indicator comes on while you are driving. After driving for a few miles (kilometers), the indicator will start blinking for a short time and then stay on. **CHECK TPMS SYSTEM** appears on the multi-information display, but this is normal.

If you replace the tire with a specified regular tire, the warning message on the multi-information display and the TPMS indicator will go off after a few miles (kilometers).

TPMS and the Spare Tire

The system cannot monitor the pressure of the spare tire. Manually check the spare tire pressure to be sure that it is correct.

Use TPMS specific wheels. Each is equipped with a tire pressure sensor mounted inside the tire behind the valve stem.

Checking the Engine

If the engine does not start, turn the ignition switch to START  and check the starter.

☒ Checking the Engine

If you must start the vehicle immediately, use an assisting vehicle to jump start it.

☒ **Jump Starting** P. 393

Starter condition	Checklist
<p>Starter doesn't turn or turns over slowly. The battery may be dead. Check each of the items on the right and respond accordingly.</p>	<p>Check brightness of the interior light. Turn on interior lights and check brightness.</p> <ul style="list-style-type: none">• If the interior lights are dim or do not come on at all ☒ Battery P. 371• If the interior lights come on normally ☒ Fuses P. 403
<p>The starter turns over normally but the engine doesn't start. There may be a problem with the fuse. Check each of the items on the right and respond accordingly.</p>	<p>Review the engine start procedure. Follow its instructions, and try to start the engine again. ☒ Starting the Engine P. 291</p> <p>Check the immobilizer system indicator. When the immobilizer system indicator is blinking, the engine cannot be started. ☒ Immobilizer System P. 133</p>
	<p>Check the fuel level. There should be enough fuel in the tank. ☒ Fuel Gauge P. 86</p>
	<p>Check the fuse. Check all fuses, or have the vehicle checked by a dealer. ☒ Inspecting and Changing Fuses P. 408</p>
	<p>If the problem continues: ☒ Emergency Towing P. 409</p>

Jump Starting Procedure

Turn off the power to electric devices, such as audio and lights. Turn off the engine, then open the hood.

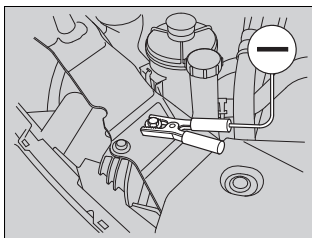
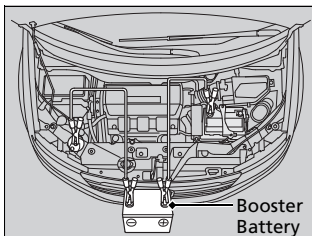

1. Connect the first jumper cable to your vehicle's battery \oplus terminal.
2. Connect the other end of the first jumper cable to the assisting vehicle's \oplus terminal.
▶ Use a 12-volt booster battery only.
3. Connect the second jumper cable to the assisting vehicle's \ominus terminal.
4. Connect the other end of the second jumper cable to the grounding point as shown.
Do not connect this jumper cable to any other part.
5. If your vehicle is connected to another vehicle, start the assisting vehicle's engine and increase its rpm slightly.
6. Attempt to start your vehicle's engine. If it turns over slowly, check that the jumper cables have good metal-to-metal contact.

Jump Starting

⚠ WARNING

A battery can explode if you do not follow the correct procedure, seriously injuring anyone nearby.

Keep all sparks, open flames, and smoking materials away from the battery.

Securely attach the jumper cables clips so that they do not come off when the engine vibrates. Also be careful not to tangle the jumper cables or allow the cable ends to touch each other while attaching or detaching the jumper cables.

Battery performance degrades in cold conditions and may prevent the engine from starting.

■ What to Do After the Engine Starts

Once your vehicle's engine has started, remove the jumper cables in the following order.

1. Disconnect the jumper cable from your vehicle's ground.
2. Disconnect the other end of the jumper cable from the assisting vehicle's battery \ominus terminal.
3. Disconnect the jumper cable from your vehicle's battery \oplus terminal.
4. Disconnect the other end of the jumper cable from the assisting vehicle's battery \oplus terminal.

Have your vehicle inspected by a nearby service station or a dealer.

Shift Lever Does Not Move

Follow the procedure below if you cannot move the shift lever out of the **P** position.

Releasing the Lock

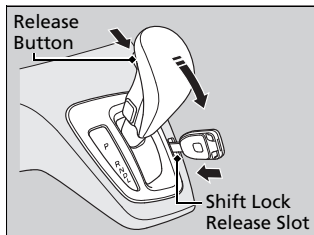
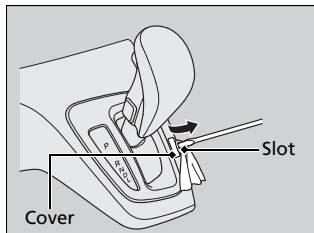

1. Set the parking brake.
2. Remove the key from the ignition switch.
3. Wrap a cloth around the tip of a small flat-tip screwdriver. Put it into the shift lock release slot as shown in the image, and remove the cover.
4. Insert the key into the shift lock release slot.
5. While pushing the key in, press the shift lever release button and place the shift lever into **N**.
 - ▶ The lock is now released. Have the shift lever checked by a dealer as soon as possible.

How to Handle Overheating

Overheating symptoms are as follows:

- The temperature gauge needle is at the **H** mark or the engine suddenly loses power.
- Steam or spray comes out of the engine compartment.

■ First thing to do

1. Immediately park the vehicle in a safe place.
2. Turn off all accessories and turn on the hazard warning lights.
 - ▶ **No steam or spray present:** Keep the engine running and open the hood.
 - ▶ **Steam or spray is present:** Turn off the engine and wait until it subsides. Then open the hood.

☒ How to Handle Overheating

⚠ WARNING

Steam and spray from an overheated engine can seriously scald you.

Do not open the hood if steam is coming out.

NOTICE

Continuing to drive with the temperature gauge needle at the **H** mark may damage the engine.

■ Next thing to do

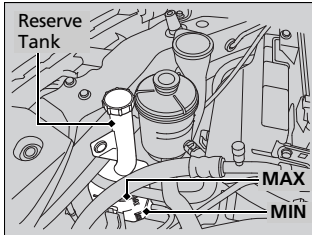

1. Check that the cooling fan is operating and stop the engine once the temperature gauge needle comes down.
 - ▶ If the cooling fan is not operating, immediately stop the engine.
2. Once the engine has cooled down, inspect the coolant level and check the cooling system components for leaks.
 - ▶ If the coolant level in the reserve tank is low, add coolant until it reaches the **MAX** mark.
 - ▶ If there is no coolant in the reserve tank, check that the radiator is cool. Cover the radiator cap with a heavy cloth and open the cap. If necessary, add coolant up to the base of the filler neck, and put the cap back on.

■ Last thing to do

Once the engine has cooled sufficiently, restart it and check the temperature gauge. If the temperature gauge needle has gone down, resume driving. If it has not gone down, contact a dealer for repairs.

▶▶ How to Handle Overheating

⚠ WARNING

Removing the radiator cap while the engine is hot can cause the coolant to spray out, seriously scalding you.

Always let the engine and radiator cool down before removing the radiator cap.

If the coolant is leaking, contact a dealer for repairs.

Use water as an emergency/temporary measure only. Have a dealer flush the system with proper antifreeze as soon as possible.

If the Low Oil Pressure Indicator Comes On



■ Reasons for the indicator to come on

Comes on when the engine oil pressure is low.

■ What to do as soon as the indicator comes on

1. Immediately park the vehicle on level ground in a safe place.
2. If necessary, turn the hazard warning lights on.

■ What to do after parking the vehicle

1. Stop the engine and let it sit for about three minutes.
2. Open the hood and check the oil level.
 - ▶ Add oil as necessary.
 - ▶ **Oil Check** P. 338
3. Start the engine and check the low oil pressure indicator.
 - ▶ The light goes out: Start driving again.
 - ▶ The light does not go out within 10 seconds: Stop the engine and contact a dealer for repairs immediately.

If the Charging System Indicator Comes On



■ Reasons for the indicator to come on

Comes on when the battery is not being charged.

■ What to do when the indicator comes on

Turn off the heating and cooling system*/climate control system*, rear defogger, and other electrical systems, and immediately contact a dealer for repairs.

☒ If the Low Oil Pressure Indicator Comes On

NOTICE

Running the engine with low oil pressure can cause serious mechanical damage almost immediately.

☒ If the Charging System Indicator Comes On

If you need to stop temporarily, do not turn off the engine. Restarting the engine may rapidly discharge the battery.

If the Malfunction Indicator Lamp Comes On or Blinks



■ Reasons for indicator lamp to come on or blink

- Comes on when there is a problem with the engine emissions control system, or the fuel fill cap is missing, or loose.
- Blinks when engine misfiring is detected.

■ What to do when the indicator lamp comes on

Avoid high speeds and immediately get your vehicle inspected at a dealer.

■ What to do when the indicator lamp blinks

Park the vehicle in a safe place with no flammable items and wait at least 10 minutes or more with the engine stopped until it cools.

■ Check/Tighten Fuel Cap Message

■ The message appears on when:

An evaporative system leak is detected. This may be caused by the fuel fill cap being loose or not being installed.

■ What to do when the message appears:

1. Stop the engine.
2. Check that the fuel fill cap is fully installed.
 - ▶ If not, loosen the cap, and then retighten it until it clicks at least once.
3. Drive for several days of normal driving.
 - ▶ The message should go off.

■ When the malfunction indicator lamp comes on

Malfunction indicator lamp comes on if the system continues to detect a leak of gasoline vapor. If this happens, check the fuel fill cap using the procedures described above.

▶▶ If the Malfunction Indicator Lamp Comes On or Blinks

NOTICE

If you drive with the malfunction indicator lamp on, the emissions control system and the engine could be damaged.

If the malfunction indicator lamp blinks again when restarting the engine, drive to the nearest dealer at 31 mph (50 km/h) or less. Have your vehicle inspected.

If the Brake System Indicator Comes On

U.S.



Canada



■ Reasons for the indicator to come on

- The brake fluid is low.
- There is a malfunction in the brake system.

■ What to do when the indicator comes on while driving

Press the brake pedal lightly to check pedal pressure.

- If normal, check the brake fluid level the next time you stop.
- If abnormal, take immediate action. If necessary, downshift the transmission to slow the vehicle using engine braking.

☒ If the Brake System Indicator Comes On

Have your vehicle repaired immediately.

It is dangerous to drive with low brake fluid. If there is no resistance from the brake pedal, stop immediately in a safe place. If necessary downshift the gears.

If the brake system indicator and ABS indicator come on simultaneously, the electronic brake distribution system is not working. This can result in vehicle instability under sudden braking.

Have your vehicle inspected by a dealer immediately.

Models with information display

If the Low Tire Pressure Indicator Comes On



■ Reasons for the indicator to come on

A tire pressure is significantly low. If the compact spare tire is installed, the indicator stays on for a while, then goes off after driving a few miles (kilometers).

■ What to do when the indicator comes on

Stop your vehicle in a safe place. Check the tire pressure and adjust the pressure to the specified level. The specified tire pressure is on a label on the driver side doorjamb.

Models with information display

If the TPMS Indicator Comes On

TPMS

■ Reasons for the indicator to come on

- Comes on when there is a problem with the TPMS.
- If the compact spare is installed, the indicator comes on after driving for a few miles (kilometers).

■ What to do when the indicator comes on

Have the tire inspected by a dealer as soon as possible. If the compact spare tire causes the indicator to come on, change the tire to a full-size tire. The indicator goes off after driving for a few miles (kilometers).

▶▶ If the Low Tire Pressure Indicator Comes On

NOTICE

Driving on an extremely underinflated tire can cause it to overheat. An overheated tire can fail. Always inflate your tires to the prescribed level.

Models with multi-information display

If the Low Tire Pressure/TPMS Indicator Comes On or Blinks



■ Reasons for the indicator to come on or blink

A tire pressure is significantly low. If there is a problem with the TPMS or the compact spare tire is installed, the indicator blinks for about one minute, and then stays on.

■ What to do when the indicator comes on

Stop your vehicle in a safe place. Check the tire pressure and adjust the pressure to the specified level. The specified tire pressure is on a label on the driver side doorjamb.

■ What to do when the indicator blinks

Have the tire inspected by a dealer as soon as possible. If the compact spare tire causes the indicator to blink, change the tire to a full-size tire. The indicator goes off after driving for a few miles (kilometers).

▶ If the Low Tire Pressure/TPMS Indicator Comes On or Blinks

NOTICE

Driving on an extremely underinflated tire can cause it to overheat. An overheated tire can fail. Always inflate your tires to the prescribed level.

Fuse Locations

If any electrical devices are not working, turn the ignition switch to LOCK **0** and check to see if any applicable fuse is blown.

Fuse locations are shown on the fuse box cover. Locate the fuse in question by the fuse number and box cover number.

■ Engine Compartment Fuse Box (Primary)

Located on the passenger's side, near the windshield washer reservoir. Push the tabs to open the box.

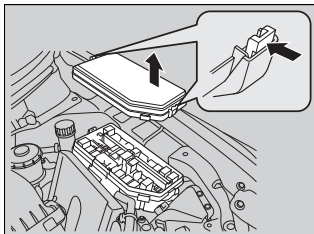

■ Circuit protected and fuse rating

	Circuit Protected	Amps
1	–	–
2	–	–
3	ACG FR	15 A
4	Washer	15 A
5	VB SOL	7.5 A
6	ECU FR	7.5 A
7	–	–
8	FI Sub	15 A
9	DBW	15 A
10	FI Main	15 A
11	Ignition Coil	15 A
12	–	–
13	FI ECU	7.5 A
14	–	–
15	Radio	20 A
16	Back Up	10 A
17	MG Clutch	7.5 A
18	Front Fog Lights*	20 A
19	–	–
20	Right Headlight High Beam	10 A
21	–	–
22	Small Lights	10 A
23	–	–
24	Left Headlight High Beam	10 A
25	–	–

	Circuit Protected	Amps
26	Right Headlight Low Beam	15 A
27	Left Headlight Low Beam	15 A
28	IGPS Oil Level	7.5 A
29	Cooling Fan	30 A
30	Sub Fan	30 A
31	Wiper Main	30 A

* Not available on all models

■ Engine Compartment Fuse Box (Secondary)

Located near the battery. Push the tabs to open the box.

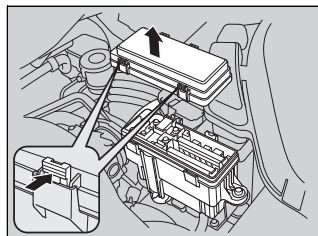

■ Circuit protected and fuse rating

	Circuit Protected	Amps
1	Battery	125 A
2-1	Fan Main	60 A
2-2	Passenger's Side Fuse Box 2	50 A
2-3	Rear Blower	30 A
2-4	FI Main	30 A
2-5	VSA Motor	40 A
2-6	Stop & Horn, Hazard	30 A
2-7	VSA FSR	30 A
2-8	Battery Management System Main	30 A
3-1	Driver's Side Fuse Box 2	50 A
3-2	IG1 Main	50 A
3-3	Rear Fuse Box 1	60 A
3-4	Passenger's Side Fuse Box 1	50 A
3-5	Driver's Side Fuse Box 1	50 A
3-6	Primary Under-hood Fuse Box Main	60 A
3-7	Front Blower	40 A
3-8	Passenger's Side Power Slide Door Motor*	40 A
4	-	-
5	-	-
6	Rear Window Defogger	40 A
7	-	-
8	Battery Management System	7.5 A

	Circuit Protected	Amps
9	Stop & Horn	20 A
10	Hazard	15 A
11	Interior Lights	7.5 A

■ Driver Side Fuse Box

Located under the dashboard.

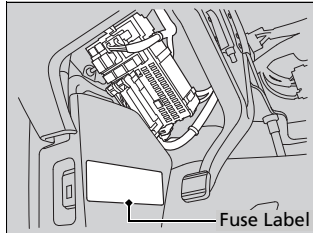

Fuse locations are shown on the label on the side panel.

Locate the fuse in question by the fuse number and label number.

■ Circuit protected and fuse rating

	Circuit Protected	Amps
1	Door Lock Motor 1 (Lock)	7.5 A
2	Door Lock Motor 2 (Lock)	7.5 A
3	Driver's Door Lock Motor (Lock)	7.5 A
4	Door Lock Motor 1 (Unlock)	7.5 A
5	Door Lock Motor 2 (Unlock)	7.5 A
6	Driver's Door Unlock	7.5 A
7	Door Lock Main	20 A
8	Not Used	–
9	Driver's Side Power Slide Door Closer*	20 A
10	Rear Fuse Box	15 A
11	Meter	7.5 A
12	Primary Under-hood Fuse Box	20 A
13	Accessory	7.5 A
14	STS	7.5 A
15	Driver's Power Seat Sliding	20 A
16	Moonroof*	20 A
17	Rear Left Power Window	20 A
18	–	–
19	Driver's Power Window	20 A
20	–	–
21	Fuel Pump	20 A
22	Passenger's Side Fuse Box	15 A
23	VSA	7.5 A

	Circuit Protected	Amps
24	ACG AS	7.5 A
25	STRLD	7.5 A
26	HAC	7.5 A
27	DRL	7.5 A
28	ACC Key Lock	7.5 A
29	Driver's Power Seat* Lumbar Support	7.5 A
30	TPMS	7.5 A
31	–	–
32	Driver's Power Seat Reclining	20 A
33	Driver's Side Power Slide Door Motor*	40 A
34	–	–

* Not available on all models

■ Passenger Side Fuse Box

Located on the lower side panel. Take off the cover to open.

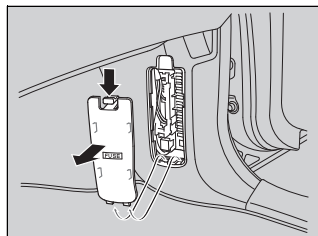

Fuse locations are shown on the fuse box cover.

Locate the fuse in question by the fuse number and box cover number.

■ Circuit protected and fuse rating

	Circuit Protected	Amps
1	Premium Amp*	30 A
2	Rear Right Power Window	20 A
3	ACM	10 A
4	–	–
5	Seat Heaters*	20 A
6	–	–
7	Front Passenger's Power Seat Sliding*	20 A
8	Front Passenger's Power Seat Reclining*	20 A
9	–	–
10	–	–
11	–	–
12	–	–
13	Passenger's Side Power Slide Door Closer*	20 A
14	Rear Accessory Power Socket	15 A
15	Front Accessory Power Socket*	15 A
16	–	–
17	–	–
18	Front Passenger's Power Window	20 A
19	SRS	10 A
20	ECU AS	7.5 A

	Circuit Protected	Amps
21	Auto Leveling Headlight*	7.5 A
22	–	–
23	OPDS	7.5 A
24	–	–
25	Instrument Panel Illumination	7.5 A
26	–	–
27	Front Accessory Power Socket	15 A
28	–	–

■ Rear Fuse Box

Located on the left side of cargo area. Remove the cover by prying on the edge of the cover using a flat-tip screwdriver.

- Wrap the flat-tip screwdriver with a cloth to prevent scratches.

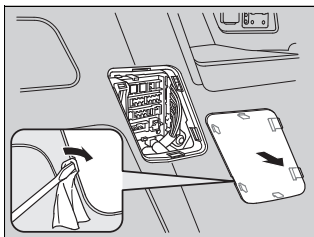

Fuse locations are shown on the fuse box cover.

Locate the fuse in question by the fuse number and box cover number.

■ Circuit protected and fuse rating

	Circuit Protected	Amps
1	Power Tailgate Closer*	20 A
2	Not Used	–
3	–	–
4	Tailgate*	10 A
5	Rear Left Door Lock	7.5 A
6	–	–
7	–	–
8	Not Used	–
9	Not Used	–
10	Not Used	–
11	Not Used	–
12	Rear Wiper	10 A
13	ECU RR	7.5 A
14	Power Tailgate Motor*	40 A
15	AC Inverter*	30 A
16	–	–
17	–	–
18	–	–

* Not available on all models

Inspecting and Changing Fuses

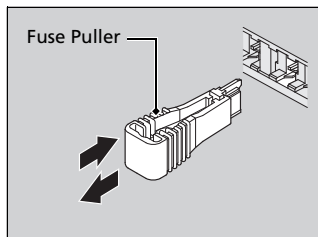
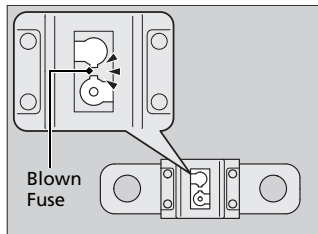
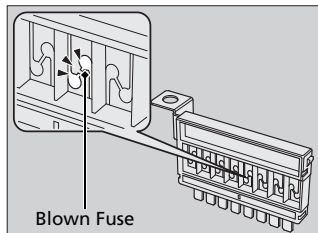

1. Turn the ignition switch to LOCK . Turn headlights and all accessories off.
2. Remove the fuse box cover.
3. Check the large fuse in the engine compartment.
 - ▶ If the fuse is blown, use a Phillips-head screwdriver to remove the screw and replace it with a new one.
4. Inspect the small fuses in the engine compartment and the vehicle interior.
 - ▶ If there is a burned out fuse, remove it with the fuse puller and replace it with a new one.

Inspecting and Changing Fuses

NOTICE

Replacing a fuse with one that has a higher rating greatly increases the chances of damaging the electrical system.

Replace fuse with a spare fuse of the same specified amperage.

Use the charts to locate the fuse in question and confirm the specified amperage on the fuse label.

► **Fuse Locations** P. 403

There is a fuse puller on the back of the engine compartment fuse box (primary) cover.

Call a professional towing service if you need to tow your vehicle.

■ Flat bed equipment

The operator loads your vehicle on the back of a truck.

This is the best way to transport your vehicle.

■ Wheel lift equipment

The tow truck uses two pivoting arms that go under the front tires and lift them off the ground. The rear tires remain on the ground. **This is an acceptable way to tow your vehicle.**

» Emergency Towing

NOTICE

Trying to lift or tow your vehicle by the bumpers will cause serious damage. The bumpers are not designed to support the vehicle's weight.

NOTICE

Improper towing such as towing behind a motorhome or other motor vehicle can damage the transmission.

Never tow your vehicle with just a rope or chain. It is very dangerous, since ropes or chains may shift from side to side or break.

When You Cannot Open or Close the Tailgate

If you cannot open or close the tailgate or power tailgate, use the following procedure.

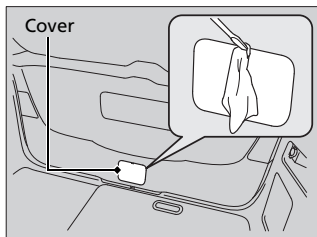

1. Use a flat-tip screwdriver and remove the cover on the back of the tailgate.
 - ▶ Wrap the flat-tip screwdriver with a cloth to prevent scratches.

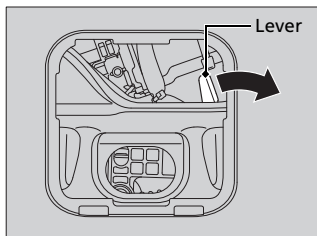

Models with power tailgate

2. To open the tailgate, push the tailgate while pushing the lever to the right.

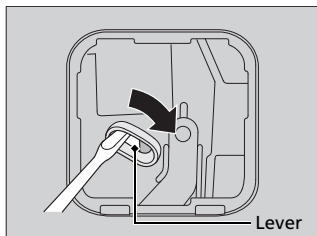

Models without power tailgate

2. To open the tailgate, push the tailgate while pushing down the lever with the flat-tip screwdriver.

When You Cannot Open or Close the Tailgate

What to do-Following up

After taking these steps, contact a dealer to have the vehicle checked.

When you open the tailgate from inside, make sure there is enough space around the tailgate, and it does not hit anyone or any object.

Information

This chapter includes your vehicle's specifications, locations of identification numbers, and other information required by regulation.

Specifications	412
Identification Numbers	
Vehicle Identification Number (VIN).....	414
Engine Number and Transmission Number.....	414
Devices that Emit Radio Waves	415
Reporting Safety Defects	416

Emissions Testing	
Testing of Readiness Codes.....	417
Warranty Coverages	419
Authorized Manuals	421
Customer Service Information	422
Gracenote® End User License Agreement	423

Vehicle Specifications

Model	Honda Odyssey	
No. of Passengers:		
Front	2	
Rear	2nd Row	3 (2 ^{*1})
	3rd Row	3
Total	8 (7 ^{*1})	
Weights:		
Gross Vehicle Weight Rating	U.S.: 6,019 lbs (2,730 kg) Canada: 2,730 kg	
Gross Axle Weight Rating (Front)	U.S.: 2,910 lbs (1,320 kg) Canada: 1,320 kg	
Gross Axle Weight Rating (Rear)	U.S.: 3,197 lbs (1,450 kg) Canada: 1,450 kg	
Gross Combined Weight Rating	U.S.: 8,477 lbs (3,845 kg) Canada: 3,845 kg	
Air Conditioning:		
Refrigerant Type	HFC-134a (R-134a)	
Charge Quantity	24.7 – 26.5 oz (700 – 750 g)	
Lubricant Type	ND-OIL8	

*1: LX model

Engine Specifications

Displacement	212 cu-in (3,471 cm ³)	
Spark Plugs	NGK DILZKR7A11G	
Fuel		
Fuel Type	Unleaded gasoline, Pump octane number of 87 or higher	
Fuel Tank Capacity	21 US gal (79.5 ℓ)	
Battery		
Capacity/Type	60AH(5)/72AH(20)	
Washer Fluid		
Tank Capacity	U.S.: 2.6 US qt (2.5 ℓ) Canada: 4.5 US qt (4.3 ℓ)	

Light Bulbs

Headlights (Low Beam)	35W (D2S) ^{*1}
	55W (H11)
Headlights (High Beam)	60W (HB3)
Fog Lights ^{*1}	55W (H11)
Front Turn Signal/Parking/Side Marker Lights	28/8W
Side Turn Signal Lights (on Door Mirrors) ^{*1}	LED
Brake/Rear Side Marker/Taillights	21/5W
Rear Turn Signal Lights	21W (Amber)
Back-Up Lights	21W
Tail-lights	3CP
High-Mount Brake Light	16W
Rear License Plate Lights	5W
Map Lights (Front)	8W
Map Lights (Rear)	5W
Cargo Area Light	8W
Vanity Mirror Lights	1.4W
Door Courtesy Lights	3.8W (2CP)
Glove Box Light	1.4W
Foot Light ^{*1}	LED

*1: Not available on all models

■ Brake Fluid

Specified	Honda Heavy Duty Brake Fluid DOT 3
-----------	------------------------------------

■ Automatic Transmission Fluid

Specified	Honda ATF DW-1 (automatic transmission fluid)
Capacity	Change 3.3 US qt (3.1 ℓ)

■ Engine Oil

Recommended	-Genuine Honda Motor Oil 0W-20 -API Premium-grade 0W-20 detergent oil
	Change 4.2 US qt (4.0 ℓ)
Capacity	Change including filter 4.5 US qt (4.3 ℓ)

■ Engine Coolant

Specified	Honda Long-Life Antifreeze/Coolant Type2
Ratio	50/50 with distilled water 1.93 US gal (7.3 ℓ)
Capacity	(change including the remaining 0.225 US gal (0.85 ℓ) in the reserve tank)

■ Tire

Regular	Size	P235/65R17 103T P235/60R18 102T*1
	Pressure psi(kPa kgf/cm ²)	33 (230 [2.3]) 35 (240 [2.4])*1
Compact Spare	Size	T135/80D17 103M
	Pressure psi(kPa kgf/cm ²)	60 (420 [4.2])
Wheel Size	Regular	17 x 7J
	Compact Spare	18 x 7J*1 17 x 4T

*1: Touring models

Vehicle Identification Number (VIN)

Your vehicle has a 17-digit vehicle identification number (VIN) used to register your vehicle for warranty purposes, and for licensing and insuring your vehicle. See the image below for the VIN locations.

Engine Number and Transmission Number

See the image below for the locations of your vehicle's engine number and transmission number.

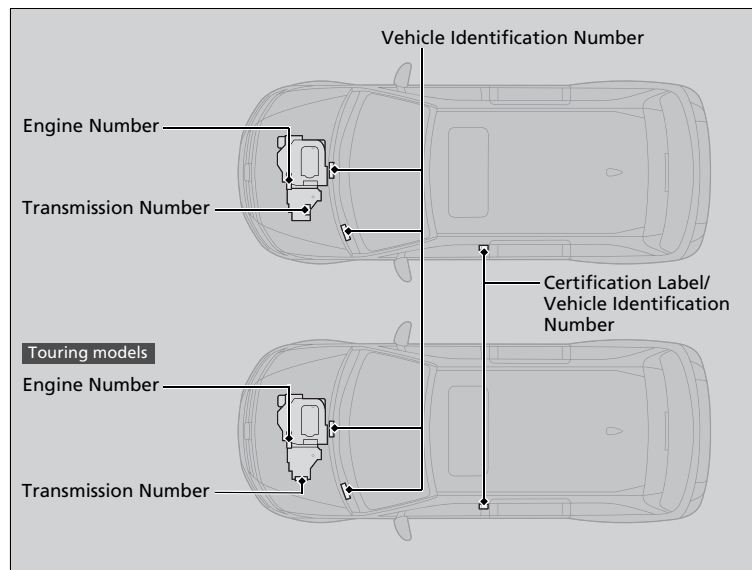

Devices that Emit Radio Waves

The following products and systems on your vehicle emit radio waves when in operation.

Audio System

Bluetooth® Audio

Bluetooth® HandsFreeLink®

HomeLink® Universal Transceiver

Immobilizer System

Parking Sensor System (Canadian models only)

Remote Transmitter

Tire Pressure Monitoring System (TPMS)

Models with Rear Entertainment System

Rear Entertainment System Remote Control

Each of the above complies with the appropriate requirements or the required standards of FCC (Federal Communications Commission) and Industry Canada Standard, described below:

As required by the FCC:

This device complies with Part 15 of the FCC rules. Operation is subject to the following two conditions: (1) This device may not cause harmful interference, and (2) this device must accept any interference received, including interference that may cause undesired operation.

Changes or modifications not expressly approved by the party responsible for compliance could void the user's authority to operate the equipment.

This device complies with Industry Canada Standard RSS-Gen/210/310. Operation is subject to the following two conditions: (1) this device may not cause interference, and (2) this device must accept any interference, including interference that may cause undesired operation of the device.

In the U.S.

If you believe that your vehicle has a defect which could cause a crash or could cause injury or death, you should immediately inform the National Highway Traffic Safety Administration (NHTSA) in addition to notifying American Honda Motor Co., Inc.

If NHTSA receives similar complaints, it may open an investigation, and if it finds that a safety defect exists in a group of vehicles, it may order a recall and remedy campaign. However, NHTSA cannot become involved in individual problems between you, your dealer, or American Honda Motor Co., Inc.

To contact NHTSA, you may call the Vehicle Safety Hotline toll-free at 1-888-327-4236 (TTY: 1-800-424-9153); go to <http://www.safercar.gov>; or write to: Administrator, NHTSA, 1200 New Jersey Avenue, SE., Washington, DC 20590. You can also obtain other information about motor vehicle safety from <http://www.safercar.gov>.

In Canada

If you believe that your vehicle has a defect which could cause a crash or could cause injury or death, you should immediately inform Honda Canada Inc. and you may also inform Transport Canada.

If Transport Canada receives similar complaints, it may open an investigation, and if it finds that a safety defect exists in a group of vehicles, it may lead to a recall and remedy campaign. However, Transport Canada cannot become involved in individual problems between you, your dealer, or Honda Canada Inc.

To contact Transport Canada's Defect Investigations and Recalls Division, you may call 1-800-333-0510. For more information on reporting safety defects or about motor vehicle safety, go to <http://www.tc.gc.ca/roadsafety>.

Testing of Readiness Codes

Your vehicle uses “readiness codes,” as part of its onboard self diagnostic system. Some states refer to these codes during testing to see if your vehicle’s emissions components are working properly. The codes may not be read if you go through the testing just after the battery has gone dead or been disconnected.

To check if they are set, turn the ignition switch to ON **[II]**, without starting the engine. The malfunction indicator lamp will come on for several seconds. If it then goes off, the readiness codes are set. If it blinks five times, the readiness codes are not set.

If you are required to have your vehicle tested before the readiness codes are ready, prepare the vehicle for retesting by doing the following:

1. Fill the gas tank to approximately 3/4 full.
2. Park the vehicle and leave the engine off for 6 hours or more.
3. Make sure the ambient temperature is between 40°F and 95°F (4°C and 35°C).
4. Start the engine without touching the accelerator pedal, and let it idle for 20 seconds.
5. Keep the vehicle in **[P]**. Increase the engine speed to 2,000 rpm, and hold it there until the temperature gauge rises to at least 1/4 of the scale (about 3 minutes).
6. Let the engine idle with your foot off the accelerator for 20 seconds.

Testing of Readiness Codes

The readiness codes are erased when the battery is disconnected, and set again only after several days of driving under a variety of conditions.

If a testing facility determines that the readiness codes are not set, you may be requested to return at a later date to complete the test.

If the testing facility determines the readiness codes are still not set, see a dealer.

7. Select a nearby, lightly traveled major highway where you can maintain a speed of 50 to 60 mph (80 to 97 km/h) for at least 20 minutes. Drive on the highway in **D**. Do not use cruise control. When traffic allows, drive for 90 seconds without moving the accelerator pedal. (Vehicle speed may vary slightly; this is okay.) If you cannot do this for a continuous 90 seconds because of traffic conditions, drive for at least 30 seconds, then repeat it two more times (for a total of 90 seconds).
8. Drive in city/suburban traffic for at least 10 minutes. When traffic conditions allow, let the vehicle coast for several seconds without using the accelerator pedal or the brake pedal.
9. Park the vehicle and leave the engine off for 30 minutes.

■ U.S. Owners

Your new vehicle is covered by these warranties:

New Vehicle Limited Warranty – covers your new vehicle, except for the emissions control systems and accessories, against defects in materials and workmanship.

Emissions Control Systems Defects Warranty and Emissions Performance Warranty – these two warranties cover your vehicle's emissions control systems. Time, mileage, and coverage are conditional. Please read your warranty booklet for exact information.

Seat Belt Limited Warranty – a seat belt that fails to function properly is covered by a limited warranty. Please read your warranty booklet for details.

Rust Perforation Limited Warranty – all exterior body panels are covered for rust-through from the inside for the specified time period with no mileage limit.

Accessory Limited Warranty – Honda accessories are covered under this warranty. Time and mileage limits depend on the type of accessory and other factors. Please read your warranty booklet for details.

Replacement Parts Limited Warranty – covers all Honda replacement parts against defects in materials and workmanship.

Replacement Battery Limited Warranty – provides prorated coverage for a replacement battery purchased from a dealer.

Replacement Muffler Lifetime Limited Warranty – provides coverage for as long as the purchaser of the muffler owns the vehicle.

Restrictions and exclusions apply to all these warranties. Please read the 2013 Honda warranty information booklet that came with your vehicle for precise information on warranty coverages. Your vehicle's original tires are covered by their manufacturer. Tire warranty information is in a separate booklet.

■ **Canadian Owners**

Please refer to the 2013 warranty manual that came with your vehicle.

The publications listed below can be purchased from Helm Incorporated. You can order a manual by phone at (800) 782-4356 (credit card orders only), or online at www.helminc.com.

Make an inquiry to Helm Inc. at (800) 782-4356 if you are interested in ordering other models' or other years' manuals.

Publication Form Number	Form Description
61TK802	2013 Honda Odyssey Service Manual
61TK802EL	2013 Honda Odyssey Electrical Troubleshooting Manual
61TK830	2011 Model Series Honda Odyssey Body Repair Manual
31TK8620	2013 Honda Odyssey Owner's Manual
31TK8820	2013 Honda Odyssey Navigation System Owner's Manual
31TK8M20	2013 Honda Odyssey Service History
31TK8A20	2013 Honda Odyssey Technology Reference Guide (LX/EX/EX-L/EX-L RES)
31TK8B20	2013 Honda Odyssey Technology Reference Guide (EX-L Navi)
31TK8C20	2013 Honda Odyssey Technology Reference Guide (Touring/Touring Elite)
HON-R	Order Form for Previous Years- Indicate Year and Model Desired

Authorized Manuals

Service Manual:

Covers maintenance and recommended procedures for repair to engine and chassis components. It is written for the journeyman technician, but it is simple enough for most mechanically inclined owners to understand.

Electrical Troubleshooting Manual:

Complements the Service Manual by providing in-depth troubleshooting information for each electrical circuit in your vehicle.

Body Repair Manual:

Describes the procedures involved in the replacement of damaged body parts.

For Canadian Owners:

Si vous avez besoin d'un Manuel du Conducteur en français, veuillez demander à votre concessionnaire de commander le numéro de pièce 33TK8C10

Honda dealership personnel are trained professionals.

They should be able to answer all your questions. If you encounter a problem that your dealership does not solve to your satisfaction, please discuss it with the dealership's service manager or general manager. If you are dissatisfied with the decision made by the dealership's management, contact Honda Customer Services.

U.S. Owners:

American Honda Motor Co., Inc.
Honda Automobile Customer Services
Mail Stop 500-2N-7A
1919 Torrance Blvd.
Torrance, CA 90501-2746
Tel: (800) 999-1009

Canadian Owners:

Honda Canada Inc.
Customer Relations
180 Honda Boulevard
Markham, ON
L6C 0H9
Tel: 1-888-9-HONDA-9
Fax: 1-877-939-0909
E-mail: Honda_cr@ch.honda.com

In Puerto Rico and the U.S. Virgin

Islands:

Bella International
P.O. Box 190816
San Juan, PR 00919-0816
Tel: (787) 620-7546

Customer Service Information

When you call or write, please give us the following information:

- Vehicle Identification Number
 - ▣ **Vehicle Identification Number (VIN)**
P. 414
- Date of purchase
- Odometer reading of your vehicle
- Your name, address, and telephone number
- A detailed description of the problem
- Name of the dealer who sold the vehicle to you

This application or device contains software from Gracenote, Inc. of Emeryville, California (“Gracenote”). The software from Gracenote (the “Gracenote Software”) enables this application to perform disc and/or file identification and obtain music-related information, including name, artist, track, and title information (“Gracenote Data”) from online servers or embedded databases (collectively, “Gracenote Servers”) and to perform other functions. You may use Gracenote Data only by means of the intended End-User functions of this application or device.

You agree that you will use Gracenote Data, the Gracenote Software, and Gracenote Servers for your own personal non-commercial use only. You agree not to assign, copy, transfer or transmit the Gracenote Software or any Gracenote Data to any third party. **YOU AGREE NOT TO USE OR EXPLOIT GRACENOTE DATA, THE GRACENOTE SOFTWARE, OR GRACENOTE SERVERS, EXCEPT AS EXPRESSLY PERMITTED HEREIN.**

You agree that your non-exclusive license to use the Gracenote Data, the Gracenote Software, and Gracenote Servers will terminate if you violate these restrictions. If your license terminates, you agree to cease any and all use of the Gracenote Data, the Gracenote Software, and Gracenote Servers. Gracenote reserves all rights in Gracenote Data, the Gracenote Software, and the Gracenote Servers, including all ownership rights. Under no circumstances will Gracenote become liable for any payment to you for any information that you provide. You agree that Gracenote, Inc. may enforce its rights under this Agreement against you directly in its own name.

Continued

Gracenote® End User License Agreement

Gracenote Music Recognition Service (CDDB)

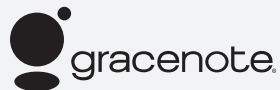

Music recognition technology and related data are provided by Gracenote®. Gracenote is the industry standard in music recognition technology and related content delivery. For more information, please visit www.gracenote.com.

When music is recorded to the HDD from a CD, information such as the recording artist and track name are retrieved from the Gracenote Database and displayed (when available). Gracenote may not contain information for all albums.

Gracenote is an internet-based music recognition service that allows artist, album, and track information from CDs to display on the HDD. More information about Gracenote is available at www.honda.com/ (in U.S.) or www.honda.ca (in Canada).

CD and music-related data from Gracenote, Inc., copyright© 2000 to present Gracenote.

The Gracenote service uses a unique identifier to track queries for statistical purposes. The purpose of a randomly assigned numeric identifier is to allow the Gracenote service to count queries without knowing anything about who you are. For more information, see the web page for the Gracenote Privacy Policy for the Gracenote service.

The Gracenote Software and each item of Gracenote Data are licensed to you “AS IS.” Gracenote makes no representations or warranties, express or implied, regarding the accuracy of any Gracenote Data from in the Gracenote Servers. Gracenote reserves the right to delete data from the Gracenote Servers or to change data categories for any cause that Gracenote deems sufficient. No warranty is made that the Gracenote Software or Gracenote Servers are error-free or that functioning of Gracenote Software or Gracenote Servers will be uninterrupted. Gracenote is not obligated to provide you with new enhanced or additional data types or categories that Gracenote may provide in the future and is free to discontinue its services at any time.

GRACENOTE DISCLAIMS ALL WARRANTIES EXPRESS OR IMPLIED, INCLUDING, BUT NOT LIMITED TO, IMPLIED WARRANTIES OF MERCHANTABILITY, FITNESS FOR A PARTICULAR PURPOSE, TITLE, AND NON-INFRINGEMENT. GRACENOTE DOES NOT WARRANT THE RESULTS THAT WILL BE OBTAINED BY YOUR USE OF THE GRACENOTE SOFTWARE OR ANY GRACENOTE SERVER. IN NO CASE WILL GRACENOTE BE LIABLE FOR ANY CONSEQUENTIAL OR INCIDENTAL DAMAGES OR FOR ANY LOST PROFITS OR LOST REVENUES.

copyright © 2000 to present Gracenote

Gracenote® End User License Agreement

Gracenote Software, copyright© 2000 to present Gracenote. One or more patents owned by Gracenote apply to this product and service. See the Gracenote website for a non-exhaustive list of applicable Gracenote patents.

Gracenote, CDDb, MusicID, MediaVOCS, the Gracenote logo and logotype, and the “Powered by Gracenote” logo are either registered trademarks or trademarks of Gracenote in the United States and/or other countries.

- A**
- ABS (Anti-lock Brake System) 310
 - AC Power Outlet 176
 - Accessories and Modifications 322
 - Accessory Power Sockets 175
 - Additives
 - Coolant 342
 - Engine Oil 337
 - Washer 346
 - Additives, Engine Oil 337
 - Adjusting
 - Armrest 167
 - Front Seats 153
 - Head Restraints 156
 - Mirrors 151
 - Rear Seats 161
 - Steering Wheel 150
 - Temperature 100
 - Air Conditioning System
 - (Climate Control System) 186
 - Changing the Mode 186
 - Defrosting the Windshield
 - and Windows 184
 - Dust and Pollen Filter 376
 - Recirculation/Fresh Air Mode 186
 - Sensors 191
 - Using Automatic Climate Control 186
 - Air Conditioning System
 - (Heating and Cooling System) 182
 - Cooling 184
 - Defrosting the Windshield
 - and Windows 184
 - Dust and Pollen Filter 376
 - Heating 183
 - Air Pressure 363, 413
 - Airbags 39
 - Advanced Airbags 45
 - After a Collision 43
 - Airbag Care 53
 - Event Data Recorder 22
 - Front Airbags (SRS) 42
 - Indicator 50, 76, 80
 - Passenger Airbag Off Indicator 51
 - Sensors 39
 - Side Airbag Cutoff System 48
 - Side Airbag Off Indicator 52
 - Side Airbags 46
 - Side Curtain Airbags 49
 - AM/FM Radio 200
 - Anti-lock Brake System (ABS) 310
 - Indicator 75
 - Armrest 167
 - Audio Remote Controls 198
 - Audio System 194
 - Adjusting the Sound 199
 - Auxiliary Input Jack 195
 - Error Messages 230
 - General Information 232
 - MP3/WMA/AAC 221
 - Reactivating 196
 - Recommended CDs 233
 - Recommended Devices 235
 - Remote Controls 198
 - Security Code 196
 - Theft Protection 196
 - USB Adapter Cable 195
 - USB Flash Drives 235
 - Audio/Information Display 91
 - Authorized Manuals 421
 - Auto Door Locking/Unlocking 115
 - Customize 116
 - Automatic Lighting 142
 - Automatic Transmission 294
 - Creeping 294
 - Fluid 344
 - Kickdown 294
 - Operating the Shift Lever 16, 296
 - Shift Lever Does Not Move 395
 - Shifting 295
 - Auxiliary Input Jack 195
 - Average Fuel Economy 88, 92, 99
 - Average Speed 92, 100
- B**
- Battery 371
 - Charging System Indicator 73, 398
 - Jump Starting 393
 - Maintenance (Checking the Battery) 371
 - Maintenance (Replacing) 372, 374
 - Belts (Seat) 30
 - Beverage Holders 173

- Blind Spot Information (BSI) System**..... 306
Bluetooth® Audio 225
Bluetooth® HandsFreeLink® 254
Booster Seats (For Children)..... 67
Brake System..... 308
 Anti-lock Brake System (ABS)..... 310
 Brake Assist System 311
 Fluid 345
 Foot Brake 309
 Indicator 72, 400
 Parking Brake 308
Brightness Control (Instrument Panel).... 146
BSI (Blind Spot Information) System..... 306
Bulb Replacement..... 347
 Back-Up/Taillight..... 355
 Brake/Rear Side Marker/Taillight and Rear Turn
 Signal Lights 353
 Fog Lights 351
 Front Turn Signal/Parking/
 Side Marker Lights 352
 Headlights 347
 High-Mount Brake Light 357
 Rear License Plate Light..... 356
Bulb Specifications..... 412
- C**
- Carbon Monoxide Gas**..... 68
Cargo Hooks..... 177
Carrying Cargo..... 281, 283
CD Library..... 211
CD Player..... 207
Center Pocket 172
Certification Label..... 414
Changing Bulbs 347
Charging System Indicator..... 73, 398
Child Safety..... 54
 Childproof Door Locks..... 114
Child Seat..... 54
 Booster Seats 67
 Child Seat for Infants..... 56
 Child Seat for Small Children..... 57
 Installing a Child Seat with a Lap/Shoulder
 Seat Belt..... 62
 Larger Children 66
 Rear-facing Child Seat 56
 Selecting a Child Seat..... 58
 Using a Tether..... 64
Childproof Door Locks 114
Cleaning the Exterior..... 379
Cleaning the Interior..... 377
Climate Control System..... 186
 Changing the Mode 186
 Defrosting the Windshield
 and Windows 187
 Dust and Pollen Filter..... 376
 Recirculation/Fresh Air Mode 186
 Sensors 191
 Using Automatic Climate Control 186
Clock..... 108
Coat Hooks 177
Compact Spare Tire..... 383, 413
Controls 107
Coolant (Engine) 342
 Adding to the Radiator 343
 Adding to the Reserve Tank 342
 Overheating 396
 Temperature Gauge 86
Creeping (Automatic Transmission)..... 294
Cruise Control 297
 Indicator 81
Cup Holders..... 173
Customer Service Information 422
Customized Features 101
- D**
- Daytime Running Lights** 143
Dead Battery 393
**Defrosting the Windshield
 and Windows** 184, 187
Devices that Emit Radio Waves..... 415
Dimming
 Headlights 141
 Rearview Mirror 151
Dipstick (Engine Oil) 338
Directional Signals (Turn Signal)..... 141
Display/Information Button 98
Door Mirrors..... 152
Doors 109
 Auto Door Locking..... 115
 Auto Door Unlocking 115
 Door and Tailgate Open Indicator 29, 77

Keys.....	109
Locking/Unlocking the Doors from the Inside.....	113
Locking/Unlocking the Doors from the Outside.....	111
Lockout Prevention System	112
DOT Tire Quality Grading	365
Driving	279
Automatic Transmission	294
Braking	308
Cruise Control	297
Shifting Gear	295
Starting the Engine	291
Driving Position Memory System	148
Dust and Pollen Filter	376

E

Elapsed Time	92, 99
Electronic Stability Control (ESC)	300
Emergency	409
Emissions Testing (Readiness Codes)	417
Engine	414
Coolant	342
Jump Starting	393
Oil	337
Starting.....	291
Switch Buzzer	140
Engine Coolant	342
Adding to the Radiator	343
Adding to the Reserve Tank	342

Overheating	396
Temperature Gauge	86
Engine Oil	337
Adding	339
Checking	338
Displaying Oil Life	327, 331
Low Oil Pressure Indicator.....	72, 398
Recommended Engine Oil.....	337

Exhaust Gas Hazard

(Carbon Monoxide)	68
Exterior Care (Cleaning)	379
Exterior Mirrors	152

F

Features	193
Filters	
Dust and Pollen	376
Oil	340
Flat Tire	383
Flip-up Trash Bag Ring	171
Floor Mats	378
Fluids	
Automatic Transmission.....	344
Brake.....	345
Engine Coolant.....	342
Power Steering	346
Windshield Washer.....	346
Fog Light Indicator	80
Folding Down the Rear Seats	161, 165
Foot Brake	309

Front Airbags (SRS)	42
Front Seats	153
Adjusting	153
Fuel	17, 318
Economy	321
Gauge.....	86
Instant Fuel Economy	88, 92, 99
Low Fuel Indicator	75
Range	88, 92, 99
Recommendation	318
Refueling.....	318
Fuel Economy	321
Fuel Fill Cap	17, 320
Message.....	399
Fuel Fill Door	17, 319
Fuses	403
Inspecting and Changing.....	408
Locations.....	403, 404, 405, 406, 407

G

Gasoline (Fuel)

Economy	321
Gauge.....	86
Information	318
Instant Fuel Economy	88, 92, 99
Low Fuel Indicator	75
Refueling.....	318
Gauges	86
Gear Shift Lever Positions	
Automatic Transmission	295

Glass (care).....	380
Glove Box.....	170
Grocery Bag Hooks.....	178

H

Halogen Bulbs.....	347, 351
Handling the Unexpected.....	381
HandsFreeLink® (HFL).....	254
Automatic Answering.....	265
Automatic Import of Cellular Phonebook and Call History.....	267
Automatic Transferring.....	265
HFL Buttons.....	254
HFL Menus.....	256
HFL Status Display.....	255
Making a Call.....	271
Options During a Call.....	276
Phone Setup.....	259
Receiving a Call.....	275
Speed Dial.....	268
To Clear the System.....	266
To Create a Security PIN.....	264
Hazard Warning Button.....	2
Head Restraints.....	156
Headlights.....	141
Aiming.....	347
Automatic Operation.....	142
Dimming.....	141, 143
Operating.....	141
Heaters (Seat).....	180

Heating and Cooling System.....	182
Cooling.....	184
Defrosting the Windshield and Windows.....	184
Dust and Pollen Filter.....	376
Heating.....	183
HFL (HandsFreeLink®).....	254
High Beam Indicator.....	79

I

Identification Numbers.....	414
Engine and Transmission.....	414
Vehicle Identification.....	414
Ignition Switch.....	140
Illumination Control.....	146
Knob.....	146
Immobilizer System.....	133
Indicator.....	80
Indicators.....	72
ABS (Anti-lock Brake System).....	75
BSI (Blind Spot Information) System.....	83
Charging System.....	73, 398
CRUISE CONTROL.....	81, 298
CRUISE MAIN.....	81, 297
Daytime Running Lights.....	77
Door and Tailgate Open.....	29, 77
Fog Light.....	80
Fuel Economy.....	81
Hazard Warning.....	79
High Beam.....	79

Immobilizer System.....	80
Lights On.....	79
Low Fuel.....	75
Low Oil Pressure.....	72, 398
Low Tire Pressure.....	78, 302
Low Tire Pressure/TPMS.....	78, 302, 303
Maintenance Minder.....	82, 327
Malfunction Indicator Lamp.....	73, 399
Parking Brake and Brake System.....	72, 400
Parking Sensor.....	77
Power Sliding Door.....	83
Power Tailgate.....	82
Seat Belt Reminder.....	31, 75
Security System Alarm.....	81
Shift Lever Position.....	74
Side Airbag Off.....	52, 80
Starter System.....	81
Supplemental Restraint System.....	50, 76
System Message.....	79
TPMS.....	78, 304
Transmission.....	74
Turn Signal.....	79
VSA® (Vehicle Stability Assist) System.....	76, 300
VSA® OFF.....	76, 301
Washer Level.....	82
Information.....	411
Information Display.....	87
Instant Fuel Economy.....	88, 92, 99
Instrument Panel.....	71
Brightness Control.....	146

Integrated Sunshades	181
Interior Lights	168
Interior Rearview Mirror	151

J

Jack (Wheel Nut Wrench)	386
Jump Starting	393

K

Key Number Tag	110
Keyless Lockout Prevention	112
Keys	109
Lockout Prevention	112
Master Keys	109
Number Tag	110
Rear Door Won't Open	114
Remote Transmitter	111
Types and Functions	109
Valet Key	110
Won't Turn	20
Kickdown (Automatic Transmission)	294

L

Language (HFL)	255
LATCH (Child Seats)	59
Lights	141, 347
Automatic	142
Bulb Replacement	347
Daytime Running Lights	143

Fog Lights	143
High Beam Indicator	79
Interior	168
Light Switches	141
Lights On Indicator	79
Turn Signals	141

Load Limits	283
Locking/Unlocking	109
Auto Door Locking/Unlocking	115
Childproof Door Locks	114
From Inside	113
From Outside	111
Keys	109
Using a Key	112
Lockout Prevention System	112
Low Battery Charge	398
Low Fuel Indicator	75
Low Oil Pressure Indicator	72, 398
Lower Anchors	59
Luggage (Maximum Load Limit)	283

M

Maintenance	323
Battery	371
Brake Fluid	345
Cleaning	377
Climate Control System	376
Coolant	342
Heating and Cooling System	376
Maintenance Minder™	327

Oil	338
Power Steering Fluid	346
Precautions	324
Radiator	343
Remote Control and Wireless Headphone	374
Remote Transmitter	372
Replacing Light Bulbs	347
Safety	325
Service Items	329, 333
Tires	362
Transmission Fluid	344
Under the Hood	335
Malfunction Indicator Lamp	73, 399

Map Lights	169
Maximum Load Limit	283
Meters, Gauges	86
Mirrors	151
Adjusting	151
Door	152
Exterior	152
Interior Rearview	151
Modifications (and Accessories)	322
Moonroof	139
MP3	207, 221
Multi-Information Display	98

N

Numbers (Identification)	414
---------------------------------------	-----

- O**
- Odometer 87, 99
 - Oil (Engine)** 337
 - Adding 339
 - Checking 338
 - Displaying Oil Life 327, 331
 - Low Oil Pressure Indicator 72, 398
 - Recommended Engine Oil 337
 - Viscosity 337
 - Opening/Closing**
 - Hood 336
 - Moonroof 139
 - Power Windows 136
 - Sliding Door 125
 - Tailgate 119
 - Outside Temperature Display 89, 100
 - Overheating 396
- P**
- Panic Mode 135
 - Parking 312
 - Parking Brake 308
 - Parking Brake and Brake System**
 - Indicator 72, 400
 - Parking Sensor System 313
 - Passenger Airbag Off Indicator 51
 - Passing Indicators 141
 - Power Sliding Door 127
 - Power Tailgate 121
 - Power Windows 136
- Precautions While Driving** 293
- Rain 293
- Pregnant Women** 37
- Puncture (Tire)** 383
- R**
- Radiator 343
 - Radio (AM/FM) 200
 - Radio Data System (RDS) 203
 - Range 88, 92, 99
 - RDS (Radio Data System) 203
 - Readiness Codes (Emissions Testing) 417
 - Rear Defogger/Heated Door Mirror**
 - Button 147
 - Rear Entertainment System** 236
 - Rear Seats (Folding Down)** 161, 165
 - Rearview Camera** 317
 - Rearview Mirror** 151
 - Refueling** 318
 - Fuel Gauge 86
 - Gasoline 318, 412
 - Low Fuel Indicator 75
 - Regulations 303, 365, 415
 - Remote Transmitter 111
 - Removable Center Console 170
 - Removing a Second Row Outer Seat** 162
 - Removing the Second Row**
 - Center Seat 164
 - Replacement**
 - Battery 372, 374
 - Bulbs 347
 - Fuses 403, 404, 405, 406, 407
 - Tires 368
 - Wiper Blade Rubber 358
- Reporting Safety Defects** 416
- Resetting a Trip Meter** 88, 99
- S**
- Safe Driving** 25
 - Safety Check** 29
 - Safety Labels** 69
 - Safety Message** 23
 - Seat Belts** 30
 - Adjusting the Shoulder Anchor 34, 35
 - Automatic Seat Belt Tensioners 32
 - Checking 38
 - Fastening 33
 - Installing a Child Seat with a Lap/Shoulder Seat Belt 62
 - Pregnant Women 37
 - Reminder 31
 - Warning Indicator 31, 75
 - Seat Heaters** 180
 - Seats** 153
 - Adjusting 153
 - Front Seats 153
 - Rear Seats 161
 - Seat Heaters 180

Security System	133	Starting the Engine	291	Inspection	362
Immobilizer System Indicator	80	Does Not Start	392	Labeling	363
Security System Alarm Indicator	81	Engine Switch Buzzer	140	Puncture (Flat Tire)	383
SEL/RESET Knob	87, 98	Jump Starting	393	Regulations	365
Select Lever	16, 295	Steering Wheel	150	Rotation	369
Operation	16, 296	Adjusting	150	Spare Tire	383, 413
Releasing	395	Stopping	312	Summer	370
Won't Move	395	Summer Tires	370	Tire Chains	370
Selecting a Child Seat	58	Sunglasses Holder	179	Wear Indicators	367
Selector Knob (Audio)	197	Supplemental Restraint System (SRS)	42	Winter	370
Setting the Clock	108	Switches		Tools	382
Shift Lever	16, 295	(Around the Steering Wheel)	2, 3, 140	Towing a Trailer	285
Shift Lever Position Indicator	74, 296	System Message Indicator	79	Equipment and Accessories	286
Shifting (Transmission)	295	T		Load Limits	285
Shoulder Anchor	34, 35	Tachometer	86	Towing Your Vehicle	
Side Airbags	46	Tailgate	119	Emergency	409
Cutoff System	48	Unable to Open	410	TPMS	
Off Indicator	48	Temperature		(Tire Pressure Monitoring System)	302
Side Curtain Airbags	49	Gauge	86	Indicator	78, 401, 402
Sliding Door	125	Outside Temperature Display	89, 100	Transmission	295
Power Sliding Door	127	Temperature Gauge	86	Automatic	295
Sliding the Second Row Outer Seats		Temperature Sensor	89, 100, 191	Fluid	344
Outward	163	Time (Setting)	108	Number	414
Snow Tires	370	Tire Pressure Monitoring System		Shift Lever Position Indicator	74, 296
Spare Tire	383, 413	(TPMS)	302	Trip Meter	88, 92, 99
Spark Plugs	412	Indicator	78, 401, 402	Troubleshooting	381
Specifications	412	Tires	362	Blown Fuse	403, 404, 405, 406, 407
Specified Fuel	318, 412	Air Pressure	363, 413	Brake Pedal Vibrates	20
Speedometer	86	Checking and Maintaining	362	Buzzer Sounds When Opening Door	21
SRS Airbags (Airbags)	42			Emergency Towing	409
				Engine Won't Start	392

Noise When Braking	21
Overheating.....	396
Puncture/Flat Tire.....	383
Select Lever Won't Move	395
Sliding Door Won't Open.....	20, 114
Warning Indicators	72
Tucking away the One-Motion Third row magic Seat.....	165
Turn Signals.....	141
Indicators (Instrument Panel).....	79
 U	
Unlocking the Doors.....	111
Unlocking the Front Doors from the Inside.....	113
USB Adapter Cable	194, 195
USB Flash Drives.....	235
 V	
Valet Key.....	110
Vanity Mirrors.....	5
Vehicle Identification Number.....	414
Vehicle Stability Assist (VSA®).....	300
Off Button	301
Off Indicator	76
System Indicator	76
Ventilation.....	182, 186
Viscosity (Oil).....	337, 413
VSA® (Vehicle Stability Assist).....	300

W

Wallpaper	94
Warning and Information Messages.....	84
Warning Indicator On/Blinking	398
Warning Labels.....	69
Warranties (Warranty Manual provided separately)	419
Watts.....	412
Wear Indicators (Tire)	367
Wheel Cover	387
Wheel Nut Wrench (Jack Handle)	386
Window Washers	144
Adding/Refilling Fluid	346
Switch.....	144
Windows (Opening and Closing)	136
Windshield.....	144
Cleaning	380
Defrosting	184, 187
Washer Fluid	346
Wiper Blades.....	358
Wipers and Washers.....	144
Winter Tires	370
Snow Tires	370
Tire Chains	370
Wipers and Washers.....	144
Checking and Replacing Wiper Blades	358
WMA	207, 221
Worn Tires	362