

**GMC**

**SIERRA HD**

2015

WE ARE PROFESSIONAL GRADE







**2015 GMC SIERRA HD.** At GMC, our engineers are never satisfied. That's precisely why they took the strongest, most powerful Sierra Heavy Duty pickups ever and used them as a starting point. The new 2015 Sierra 2500HD and 3500HD take proven powertrains and the new standard in quiet, comfortable truck interiors, pickup-first technologies and cargo box innovations to produce a premium-duty breed of Professional Grade trucks. It's just another example of what incredible thinking can help you achieve.







SIERRA 3500 DENALI HD WITH DUAL REAR WHEELS IN ONYX BLACK  
shown with available equipment.

INTERIOR | 2

EXTERIOR | 10

PERFORMANCE | 16

SECURITY | 24

SELECTION | 28





## A NEW STANDARD HAS QUIETLY BEEN ACHIEVED.

The redesigned cabin in the 2015 Sierra HD combines triple door seals, inlaid doors and other refinements throughout the truck to create our quietest HD pickups ever. Add premium materials, supportive seats and generous storage and you've set the new standard in heavy-duty truck interiors. Denali HD takes it a step further with heated and cooled Denali-embossed leather-trimmed front bucket seats, a heated leather-wrapped steering wheel, new soft-touch instrument panel with burnished aluminum trim and contrasting stitching.

**POWER-ADJUSTABLE PEDALS ALLOW YOU TO PERSONALIZE YOUR DRIVING POSITION.**

**GAIN QUICK FINGERTIP ACCESS TO VEHICLE INFORMATION WITH DENALI'S EXCLUSIVE CUSTOMIZABLE DRIVER DISPLAY.**

**ENJOY THE BOSE® PREMIUM 7-SPEAKER AUDIO SYSTEM AND VOICE-ACTIVATED NAVIGATION.<sup>1</sup>**

**STAY CHARGED WITH A NEW 110-VOLT OUTLET, A 12-VOLT OUTLET AND NOW UP TO SIX USB PORTS.<sup>2</sup>**

<sup>1</sup>Map coverage available in the United States, U.S. Virgin Islands, Puerto Rico and Canada. <sup>2</sup>Not compatible with all devices.









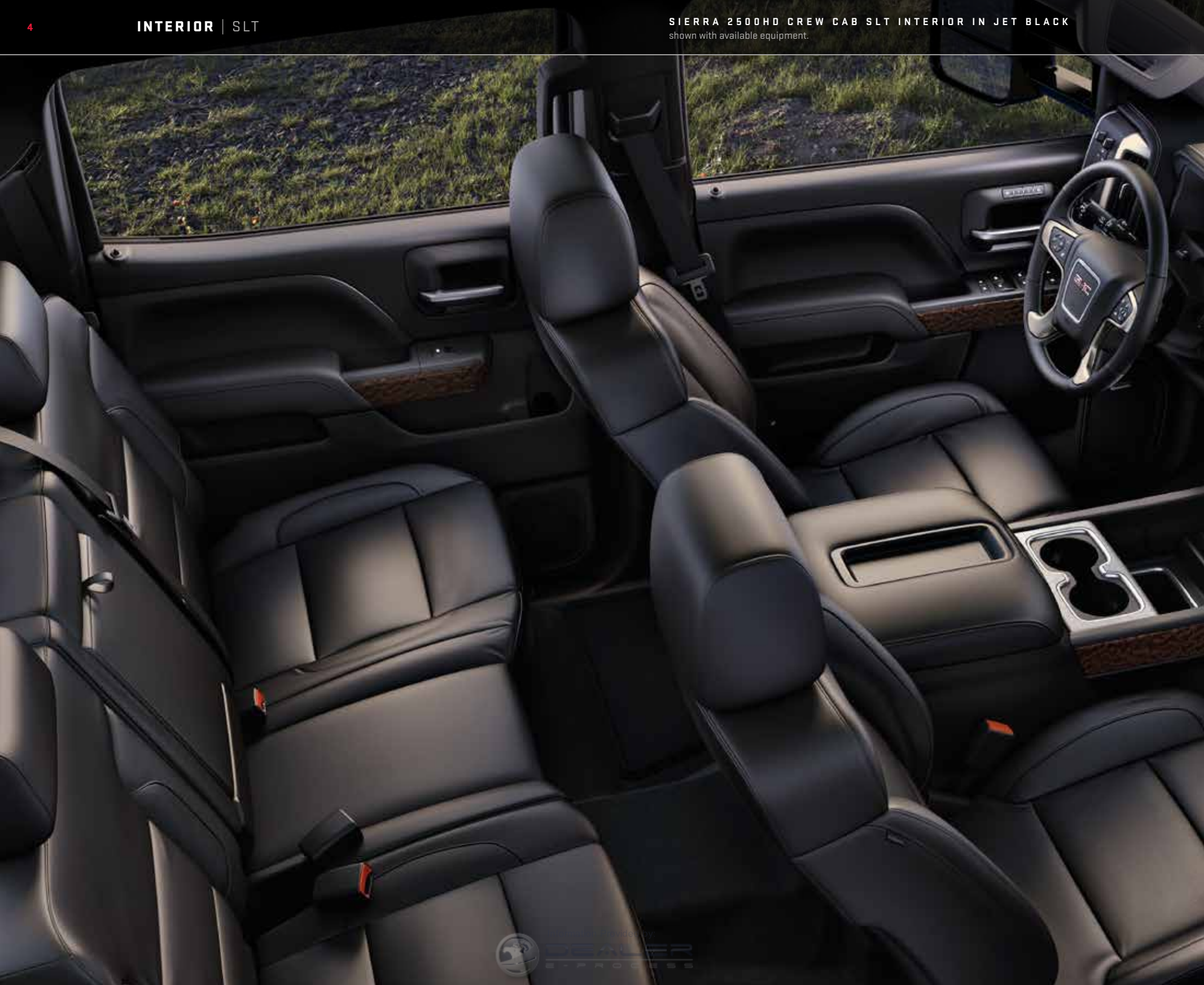





## EASE OF ACCESS DOESN'T TAKE A BACK SEAT.

---

Setting a design standard for truck interiors means SLE and SLT models surround you with premium, durable materials. It also means that Crew Cabs now offer nearly 2" of additional rear leg room, while new Double Cabs make getting into and out of the rear seat easier in tight places thanks to new forward-hinged rear doors.

**HARD WORK ISN'T WITHOUT ITS  
PLEASURES THANKS TO DAY-LONG  
COMFORT SEATS.**

**FOR MAXIMUM FLEXIBILITY  
AND CONVENIENCE, SIERRA HD  
OFFERS MOVABLE CUPHOLDERS,  
A SMARTPHONE HOLDER AND  
DUAL GLOVE BOXES.**

**NEW AVAILABLE CENTER FLOOR  
CONSOLE OFFERS PLENTY OF MOBILE  
OFFICE SPACE.**

**REFINED DOOR TRIM PANELS  
ARE REINFORCED FOR PREMIUM  
DURABILITY TO STAND UP TO  
EVERYDAY WEAR AND TEAR.**



## UP CLOSE AND PERSONAL.

The 2015 Sierra HD's all-new instrument panel puts controls where they're most visible—at your fingertips—and information at the sound of your voice, thanks to a new available 8" diagonal Color Touch Radio with IntelliLink<sup>1</sup> (a navigation system<sup>2</sup> is available as well) that responds to natural-speech voice commands. Sierra HD provides the latest technologies to help you work smarter and more efficiently. From available driver alert safety technologies to Denali's personalized driver display, you're surrounded by everything you need to perform your best.

SIERRA HD IS THE FIRST HEAVY-DUTY PICKUP TO OFFER FORWARD COLLISION ALERT AND LANE DEPARTURE WARNING.

KNOBS AND BUTTONS ARE LARGER TO ACCOMMODATE GLOVED HANDS, AND GAUGES ARE LED BACK-LIT.

HANDS ON THE AVAILABLE ALUMINUM-TRIMMED WHEEL WITH STEERING-WHEEL-MOUNTED CONTROLS.

CENTER-MOUNTED SWITCH BANK POSITIONS FUNCTIONAL CONTROLS WITHIN EASY REACH.



<sup>1</sup>Full functionality requires compatible Bluetooth® and smartphone. Some devices require USB connectivity. <sup>2</sup>Map coverage available in the United States, U.S. Virgin Islands, Puerto Rico and Canada.







## MIXES PLEASURE WITH BUSINESS.

Climb into Sierra HD and you'll find no shortage of supportive comfort, premium and durable materials, some of the industry's most advanced and personalized technologies and, of course, ample storage for all of your personal gear.



**CUSTOMIZABLE DRIVER DISPLAY** Sierra Denali's new 8" diagonal color Driver Information Center (DIC) lets you choose from a menu of display themes to select the information you see and how you see it. Steering-wheel-mounted controls provide fingertip access to vehicle functions.



**WELL CONNECTED** Available IntelliLink<sup>1</sup> is your seamless touch- and voice-activated connection to digital content. From the contacts and music playlists stored in your smartphone to a selection of on-screen apps like Pandora,<sup>®</sup> the screen provides instant access to the information and entertainment you want. It's also available with a voice-activated Navigation System.<sup>2</sup>



**SAFEGUARDS** The 2015 Sierra HD is the first heavy-duty full-size pickup to offer all three of these advanced safety features: Forward Collision Alert, Lane Departure Warning and the Safety Alert Driver Seat. Together, they help alert you to potential hazards on the road.





**ENERGIZED** Depending on the model you choose, a convenient power supply—up to six USB ports,<sup>3</sup> four auxiliary power outlets and a new available 110-volt outlet—keeps first- and second-row passengers connected and powered up.

**COMMAND CENTRAL** Access to controls and power sources is centrally located and within easy reach of the driver's seat. This array of switches and auxiliary controls puts important functions at your fingertips.

**CLEAR VISION** The available power-sliding rear window now offers a new defrost feature to improve visibility.

**CENTER CONSOLE STORAGE** An available center console storage compartment is designed to double as a file cabinet, so you'll have a place to keep hanging files, a laptop and other mobile devices.

**HANDS-ON** Keep your eyes on the road while activating available Bluetooth<sup>4</sup> phone functions. Available steering-wheel-mounted controls also allow you to play audio, change songs, set the cruise control and activate the available heated steering wheel.



**UPPER AND LOWER GLOVE BOXES** New twin glove boxes provide you and your passengers with personal storage areas.

**EASY ACCESS** Sierra HD now features improved rear-seat comfort and access by adding nearly 2" of leg room on Crew Cabs. Getting to the rear seat of the Double Cab is also easier in tight places, with new forward-hinged rear doors. On both models, the rear doors are bigger for easy entry to and exit from the second row.

<sup>1</sup>Full functionality requires compatible Bluetooth and smartphone. Some devices require USB connectivity. Data plan rates apply. <sup>2</sup>Map coverage available in the United States, U.S. Virgin Islands, Puerto Rico and Canada. <sup>3</sup>Not compatible with all devices. <sup>4</sup>Go to [gmttotalconnect.com](http://gmttotalconnect.com) to find out which phones are compatible with the vehicle.

## PREMIUM DETAILS. PREMIUM DUTY.

The Sierra 3500 Denali HD is the height of Professional Grade engineering, design and capability. For 2015, it adds a new purposeful design to help reduce wind noise for its quiet cabin, while offering the most innovative cargo box in its class thanks to smart features that let you customize the way you secure cargo. It also offers a maximum payload of over 6000 lbs<sup>1</sup> or maximum trailering of up to 22,900 lbs<sup>2</sup> with the available Duramax 6.6L V-8 Turbo Diesel.

**A COMMANDING PRESENCE IS ACHIEVED WITH THE ICONIC DENALI GRILLE.**

**NEW DENALI 6" CHROME ASSIST STEPS SERVE AESTHETIC AND PRACTICAL FUNCTIONS.**

**VERTICAL CAMPER-STYLE MIRRORS HELP WHEN TRAILERING A WIDE LOAD.**

**SIERRA OFFERS THE MOST INNOVATIVE CARGO BOX IN ITS CLASS TO HELP TAKE SOME OF THE WORK OUT OF WORK.**

<sup>1</sup>Requires 3500HD Crew Cab DRW 2WD with 6.0L V-8 engine. Maximum payload capacity includes weight of driver, passengers, optional equipment and cargo. <sup>2</sup>Requires 3500HD Crew Cab DRW 2WD with Duramax 6.6L V-8 Turbo Diesel. Maximum trailer weight ratings are calculated assuming a base vehicle, except for any option(s) necessary to achieve the rating, plus driver. The weight of other optional equipment, passengers and cargo will reduce the maximum trailer weight your vehicle can tow. See your GMC dealer for additional details.













## WORKS HARD. HARDLY BREAKS A SWEAT.

The first thing you notice about the Sierra 2500HD SLT is its new bold, sculpted design that looks smart and works efficiently. The new three-dimensional grille captures air to help cool the engine, while the rest flows smoothly around the truck. It also works hard with a maximum payload of over 3500 lbs<sup>1</sup> or, with the available Duramax 6.6L V-8 Turbo Diesel, a maximum trailering capacity of up to 14,500 lbs<sup>2</sup> with a conventional ball hitch, or up to 17,600 lbs<sup>3</sup> with a fifth-wheel or gooseneck hitch.

**NEW INLAID DOORS IMPROVE AERODYNAMICS AND REDUCE WIND NOISE.**

**TO HELP PREVENT DAMAGE, NEW RAIL PROTECTORS ARE BUILT INTO THE TOP OF THE BOX.**

**A NEW FRONT CHROME BUMPER PRODUCES A UNIQUE HD APPEARANCE.**

**SIERRA HD FEATURES NEW PROJECTOR-BEAM HEADLAMPS.**

<sup>1</sup>Requires 2500HD Double Cab Standard Box 2WD with 6.0L V-8 engine. Maximum payload capacity includes weight of driver, passengers, optional equipment and cargo. <sup>2</sup>Requires 2500HD Crew Cab Long Box 4WD with available Duramax 6.6L V-8 Turbo Diesel engine. Maximum trailer weight ratings are calculated assuming a base vehicle, except for any option(s) necessary to achieve the rating, plus driver. The weight of other optional equipment, passengers and cargo will reduce the maximum trailer weight your vehicle can tow. See your GMC dealer for additional details. <sup>3</sup>Requires 2500HD Double Cab Standard Box 2WD with available Duramax 6.6L V-8 Turbo Diesel engine. Maximum trailer weight ratings are calculated assuming a base vehicle, except for any option(s) necessary to achieve the rating, plus driver. The weight of other optional equipment, passengers and cargo will reduce the maximum trailer weight your vehicle can tow. See your GMC dealer for additional details.



DEALER  
STAFF PROCESS



**FORMED FOR FUNCTION** The wheel arch moldings are tightly integrated into the fenders to help protect the finish against chipping from stones and debris.



**ENGINEERED AIRFLOW** In addition to triple door seals and thicker windshield glass, Sierra's sculpted styling helps reduce wind noise to create a quieter cabin.

**SIGNATURE LIGHTING** In a GMC pickup first, Sierra introduces new projector-beam headlamps fully integrated into the grille surround. The lamps are further enhanced by available LED signature lighting (standard on SLT and Denali).

## THINKING INSIDE AND OUTSIDE THE BOX.

Let's get to work. To help you do just that, the new Sierra HD offers aerodynamic styling to deliver a quiet cabin as well as offering the most innovative cargo box in its class. The highlight of these Professional Grade innovations is the widely acclaimed CornerStep rear bumper.





**CORNERSTEP REAR BUMPER** Integrated into the corners, these new bumper steps—which no other competitor offers—make it easy to access the cargo box. The deep tread of the step is designed to accommodate large boots. On single-rear-wheel models, new hand assists built into the top of the side rails help give you a boost into the bed.

**LED UNDER-RAIL LIGHTS** Available LED lights are positioned under each side rail to make it easier to load or unload the box at night, or when it is enclosed by a tonneau cover.

**EZ-LIFT AND LOWER TAILGATE** Accessing the cargo box is now easier with the new available EZ-Lift and Lower Tailgate.

**UPPER TIE-DOWNS** Four new load-bearing upper tie-down hooks are standard. Rated at 250 lbs<sup>1</sup> each, they can be repositioned in several places around the box depending on the cargo being secured.

**ROLLED, NOT STAMPED** Unlike the stamped-steel approach of the other guys, we use a roll-formed process for Sierra HD's cargo bed for the same reason it's used on submarine hulls: it allows us to use higher-grade steel that's stronger, lighter and more durable.

**SPRAY-ON BEDLINER** To provide a permanent, non-skid surface, the available (standard on 2500 Denali HD) black liner covers the entire bed below the side rails, including the tailgate, front box top rail and lower tie-down hooks.

<sup>1</sup>Cargo and load capacity limited by weight and distribution.

## DURAMAX: POWER. DEPENDABILITY. PROVEN A MILLION TIMES OVER.

The new Sierra HD gets its heavy-duty power from proven sources, including the available Duramax 6.6L V-8 Turbo Diesel mated to the Allison® 6-speed automatic transmission. You'll find over 1 million Duramax diesels with Allison transmissions on the road today with over 100 billion real-world miles of experience. With 765 lb-ft of torque under your right foot, it delivers Professional Grade performance and a maximum highway range of up to 650 miles on a single fill-up.<sup>1</sup> If you prefer your power gasoline-fueled, Sierra HD comes standard with the force and efficiency of our 360-hp Vortec 6.0L V-8.

**-40°F**  
  
  
**3**  
 seconds

FOR FASTER STARTS IN COLD WEATHER, QUIETER OPERATION AND MAXIMUM EFFICIENCY, DIRECT INJECTION HELPS THE AVAILABLE DURAMAX DIESEL START IN AS LITTLE AS 3.0 SECONDS AT -40°F AND OPERATE AT NEARLY 30,000 PSI TO TURN HEAVY DIESEL FUEL INTO A FINE MIST, BURNING CLEANER AND FASTER WITH LOWER EMISSIONS AND GREATER POWER THAN THE PREVIOUS MODEL.

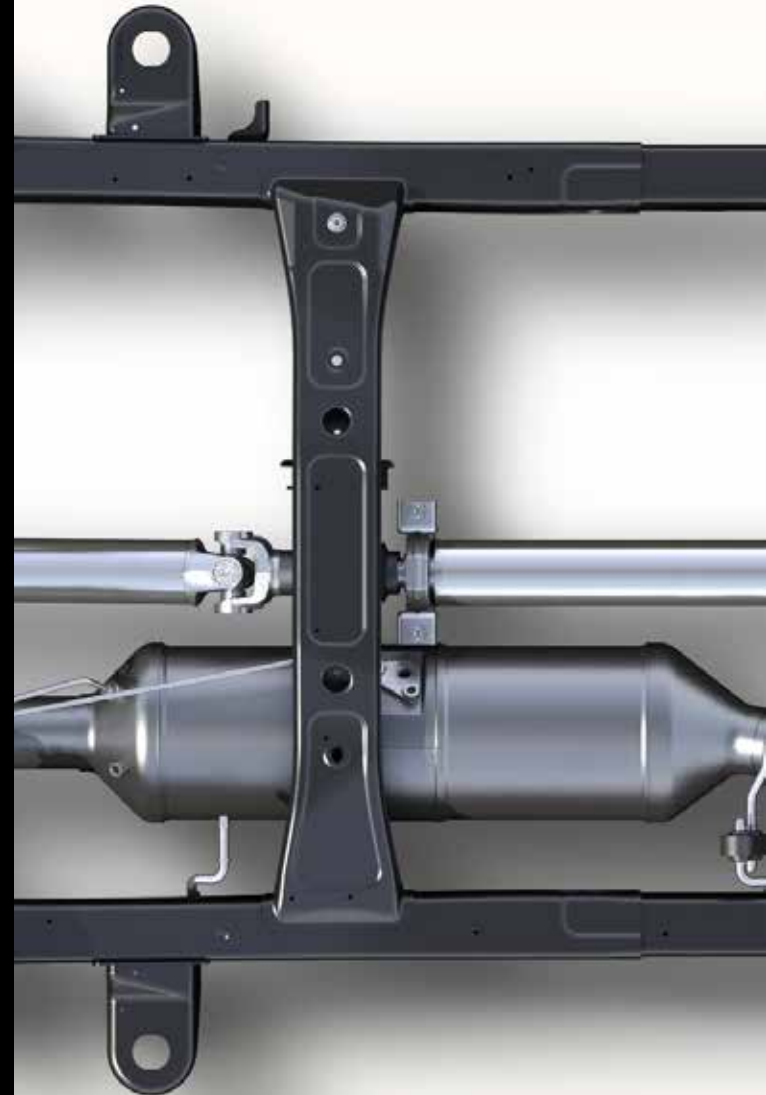

<sup>1</sup>Based on GM testing and fuel-tank capacity. Your range may be less.



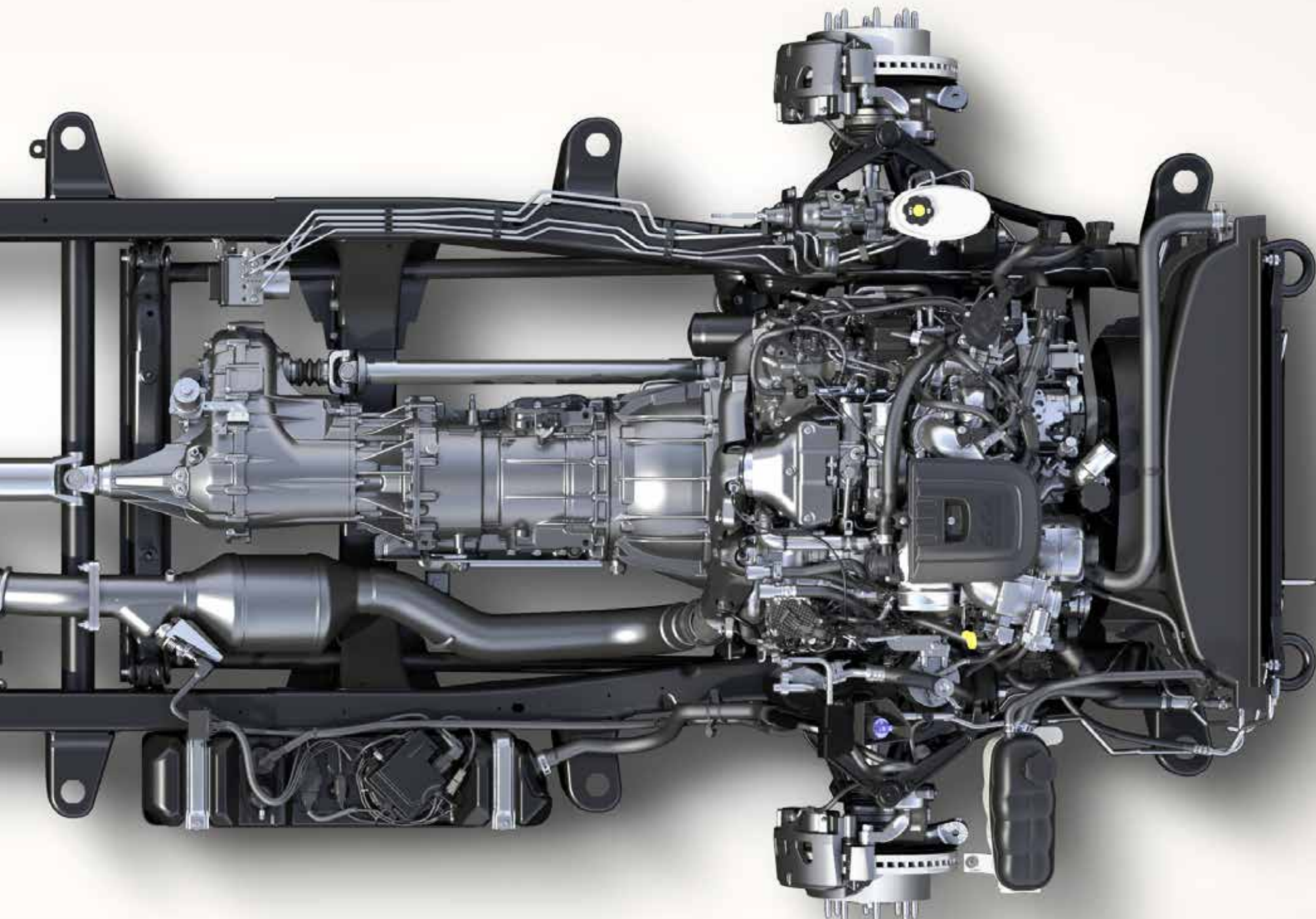

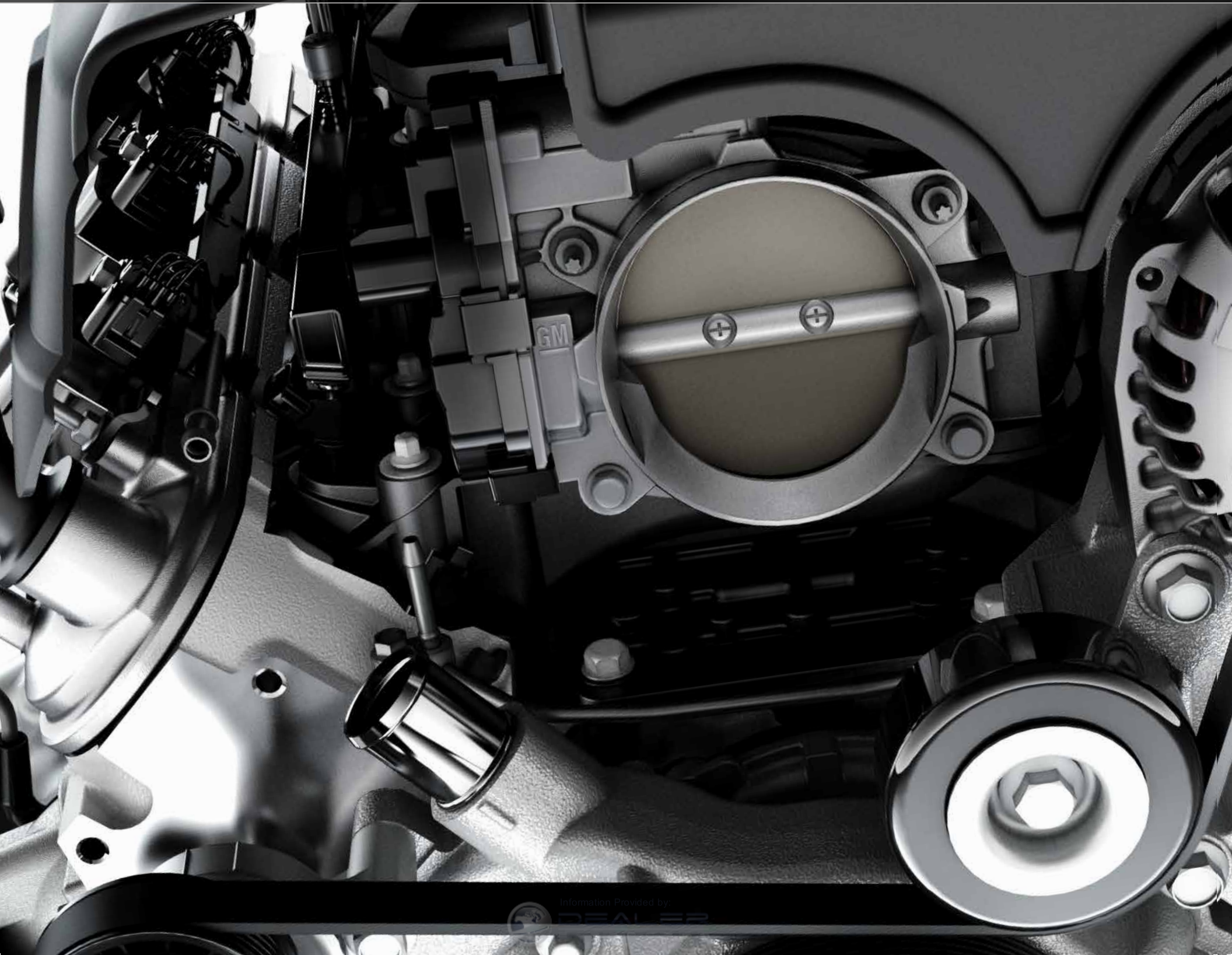





## VORTEC: GASOLINE OR NATURAL GAS? YES, PLEASE.

The new 2015 Sierra HD comes standard with the Vortec 6.0L V-8, an uncompromised source of power. Developed for heavy-duty performance, it's paired with a 6-speed heavy-duty automatic transmission to deliver a maximum fifth-wheel towing capacity of up to 14,800 lbs.<sup>1</sup> A bi-fuel version of the Vortec 6.0L that seamlessly switches between gasoline and Compressed Natural Gas (CNG) is available on single-rear-wheel HD models and can provide a driving range of up to 650 miles.<sup>2</sup> See your dealer for details and model availability.

**VARIABLE VALVE TIMING DELIVERS  
LOW-SPEED RESPONSIVENESS AND  
HIGH-SPEED POWER FOR PASSING  
OR TRAILERING.**

**ELECTRONIC THROTTLE CONTROL  
DELIVERS INSTANTANEOUS  
ACCELERATION.**

**MOVE THROUGH THE GEARS LIKE A  
MANUAL WITH THE CONVENIENCE OF  
AN AUTOMATIC, THANKS TO DRIVER  
SHIFT CONTROL.**

**THE GASOLINE VORTEC 6.0L V-8  
IS ALSO CAPABLE OF RUNNING ON  
E85 ETHANOL.<sup>3</sup>**

<sup>1</sup>Requires 2500HD Regular Cab DRW 2WD with Vortec 6.0L V-8 gasoline engine and 4.10 rear axle ratio. Maximum trailer weight ratings are calculated assuming a base vehicle, except for any option(s) necessary to achieve the ratings, plus driver. The weight of other optional equipment, passengers and cargo will reduce the maximum trailer weight your vehicle can tow. See your GMC dealer for additional details. <sup>2</sup>Estimated range based on GM testing and maximum fuel-tank capacity. Your range may be less. <sup>3</sup>E85 FlexFuel capability is not available in AZ, CA, CT, DE, MA, MD, ME, NJ, NY, OR, PA, RI, VT and WA. E85 is a combination of 85% ethanol and 15% gasoline. Go to [afdc.energy.gov/adfc/fuels](http://afdc.energy.gov/adfc/fuels) to see if there is an E85 station near you.





## MORE MUSCLE. LESS FAT.

---

Weight robs a truck of its power and efficiency. In Sierra HD, the strategic use of high-strength steels and other premium materials enabled engineers to create a new HD that is stronger and more capable than previous models.

**FULLY BOXED FRAME** The HD frame is engineered using high-strength steel for the fully boxed frame rails. The front frame segments are hydroformed to minimize weight without sacrificing strength, so Sierra HD has the strength and stiffness to tackle the toughest heavy-duty demands.

**EATON® HEAVY-DUTY DIFFERENTIAL** No other competitor in its class offers a fully automatic locking rear differential for on- and off-road use.





**HIGH-STRENGTH STEEL** To create a quiet cab, nearly two-thirds of the HD's cab structure is made from high-strength steels, including the pillars, roof rails and rocker panels. It's a fortress of strength that rests on hydraulic body mounts that enhance the smooth, comfortable ride.

**INDEPENDENT FRONT SUSPENSION** For ride comfort without sacrificing strength, Sierra HD has an independent front suspension designed specifically for the constant punishment of heavy-duty use. With the available Snow Plow Prep Package, Sierra HD achieves a Gross Front Axle Weight Rating of up to 6000 lbs.<sup>1</sup> This torsion-bar suspension design allows you to make seasonal ride-height adjustments in minutes with a single wrench.

**MULTILEAF REAR SPRINGS** Mounted to the rear frame are 3"-wide leaf springs that help achieve a best-in-class maximum payload rating of up to 7374 lbs.<sup>2</sup>

**POWERFUL BRAKING** Four-wheel, four-channel, antilock disc brakes (ABS) on all Sierra HD models help provide straight, more controlled stops by preventing wheel lock-up in most road conditions.

**HILL DESCENT CONTROL** Activated by pushing a button within easy reach on the instrument panel, Hill Descent Control is included on models with the Z71 Off-Road Suspension Package. It uses antilock braking to provide a smooth and controlled descent in rough terrain without having to touch the brake pedal.

<sup>1</sup>Capabilities and weight ratings are dependent upon model, engine, transmission and GVWR combinations. See your GMC dealer for details. <sup>2</sup>Requires 3500HD Regular Cab DRW 2WD with 6.0L V-8 engine. Maximum payload capacity includes weight of driver, passengers, optional equipment and cargo.



## A PULLING FORCE.

---

GMC Sierra HD is engineered to provide Professional Grade trailering capability as well as truck/trailer features to keep you comfortably in control. Whether you're headed out for work or recreation, Sierra HD offers a wide range of trailering capacities to meet your demands. Complete trailering ratings to help you make an informed purchase decision are listed on page 33.

**TRAILERING SUPREMACY** Select models offer an available class-leading 19,600 lbs<sup>1</sup> of conventional towing. And depending on model and equipment, 3500HD can tow a maximum of 23,200 lbs<sup>1</sup> with a fifth-wheel hitch.

<sup>1</sup>Maximum trailer weight ratings are calculated assuming a base vehicle, except for any option(s) necessary to achieve the rating, plus driver. The weight of other optional equipment, passengers and cargo will reduce the maximum trailer weight your vehicle can tow. See your GMC dealer for additional details.





**DIESEL EXHAUST BRAKE SYSTEM** The available Exhaust Brake System works with the Allison transmission's Tow/Haul mode and Automatic Grade Braking features to reduce the amount of conventional braking needed while towing or traveling downhill.

**TRAILER SWAY CONTROL** Keep both Sierra HD and your trailer heading in the same direction, automatically. Sensors help detect a swaying trailer, and the system helps bring it back in line by applying both the truck's and the trailer's brakes (when properly equipped).

**TRAILER BRAKE CONTROLLER** For control and easy monitoring of your trailer brakes, Sierra HD offers an available integrated trailer brake controller. It's located high and in easy reach of the steering wheel for quick adjustments and is included on Denali and 3500 models.

**REAR VISION CAMERA SYSTEM** The center screen serves as your monitor for the available Rear Vision Camera System. Its dynamic grid lines help when backing up or hitching a trailer.

**TOW/HAUL MODE** To accelerate when trailering or hauling heavy loads, Tow/Haul mode raises transmission upshift points. It also raises downshift points using engine compression to help slow your Sierra HD instead of merely braking.

**HILL START ASSIST** To give you extra time to switch from the brake pedal to the accelerator without rolling back when on an incline, Hill Start Assist holds the brakes momentarily or until you press the accelerator.



## WE'VE PLACED YOU AND THE COMPETITION ON ALERT.

The new Sierra HD raises the bar for pickup truck safety. Unlike its competitors, Sierra offers the new Driver Alert Package. It includes Forward Collision Alert, Lane Departure Warning and the Safety Alert Driver Seat. They provide a visual alert in the gauge cluster and allow you to choose from additional audible warnings or the Safety Alert Driver Seat, which uses vibrations to warn you.



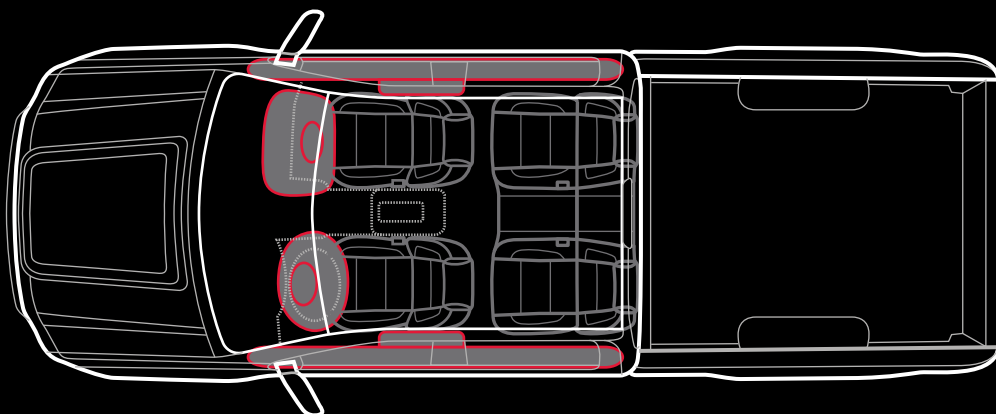

**SIX AVAILABLE AIR BAGS** Sierra HD offers up to six air bags\* (standard on 2500 and select 3500 models) including single-stage frontal air bags, head-curtain side-impact air bags with rollover protection and seat-mounted side-impact air bags.

**FORWARD COLLISION ALERT** To help prevent frontal crashes, this available technology alerts drivers when they are closing in on a vehicle ahead too quickly. The warning gives the driver critical additional time to react and potentially avoid a crash.

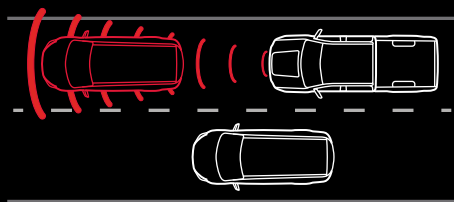

**SAFETY ALERT DRIVER SEAT** The available Safety Alert Driver Seat helps warn the driver of potential traffic danger using directional vibration pulses from the seat cushion. Works with Forward Collision Alert, Lane Departure Warning and Front and Rear Park Assist.



**LANE DEPARTURE WARNING** This available technology alerts the driver when Sierra HD drifts over a lane line without signaling while traveling at least 35 mph.

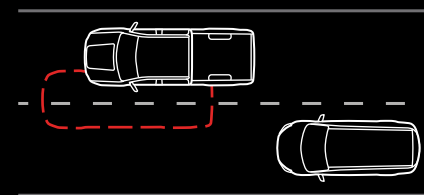

\*A NOTE ON CHILD SAFETY: Always use safety belts and the correct child restraint for the child's age and size, even with air bags. Even in vehicles equipped with the Passenger Sensing System, children are safer when properly secured in a rear seat in the appropriate infant, child or booster seat. Never place a rear-facing infant restraint in the front seat of any vehicle equipped with an active frontal air bag. See your vehicle Owner's Manual and child safety seat instructions for more safety information.



## GMC PRO GRADE PROTECTION. THE INDUSTRY'S BEST PICKUP COVERAGE.

---

Pro Grade Protection is standard on every 2015 Sierra HD. From scheduled maintenance to protecting your entire vehicle, you can drive with the knowledge that your operating costs have been reduced.

2-YEAR/24,000-MILE RECOMMENDED SCHEDULED MAINTENANCE,<sup>1</sup> INCLUDING DIESEL EXHAUST FLUID

3-YEAR/36,000-MILE BUMPER-TO-BUMPER LIMITED WARRANTY<sup>2</sup>

5-YEAR/100,000-MILE POWERTRAIN LIMITED WARRANTY<sup>2</sup>



## THERE WHEN YOU NEED US.



Standard for 6 months on most models, the OnStar Directions & Connections Plan<sup>3</sup> lets you speak to a live OnStar Advisor just by pressing the blue OnStar button in your vehicle.

**AUTOMATIC CRASH RESPONSE<sup>4</sup>** In many crashes, built-in sensors can automatically alert an OnStar Advisor who is immediately connected into your vehicle to see if you need help—even if you can't respond.

**CRISIS ASSIST** During severe weather or other crisis situations, OnStar can provide a quick, central point of contact when you need emergency assistance, navigation help or information.

**EMERGENCY SERVICES** One push of the red emergency button gives you a priority connection to an Advisor who can direct emergency service providers to your exact location.

**ROADSIDE ASSISTANCE<sup>5</sup>** If you need an emergency tow, lockout service or help with a flat tire, just push the blue OnStar button and an Advisor can direct help to your exact location—it's all a part of your OnStar subscription.

**SECURITY FEATURES<sup>6</sup>** Remote Door Unlock, Remote Horn and Lights and Stolen Vehicle Assistance provide help when you need it.

**HANDS-FREE CALLING<sup>7</sup> WITH VOICE COMMAND** Available OnStar Hands-Free Calling is a built-in service in case your cell phone is unavailable, out of range or has a low battery. Just push a button and say the number to make a call.

**TURN-BY-TURN NAVIGATION** Push your blue OnStar button and tell the Advisor where you want to go, and directions will be downloaded to your Sierra HD.

**ONSTAR eNAV WITH MAPQUEST.COM<sup>TM</sup>** Get a head start on a trip by checking out your destination on mapquest.com and then clicking the "Send" link. Directions will be sent to your Sierra HD.

**DESTINATION DOWNLOAD** With the optional Navigation System, an Advisor can download directions to your Sierra HD's navigation screen.

**ONSTAR REMOTELINK<sup>8</sup> KEY FOB SERVICES<sup>9</sup>** OnStar RemoteLink Key Fob Services are included for 5 years on OnStar-equipped 2014 and newer vehicles. Download the app and use RemoteLink services during the 6-month trial period and any consecutive periods with an OnStar plan. Includes remote door unlock and lock, remote start and stop<sup>10</sup> and remote horn and lights.

<sup>1</sup>Covers only scheduled oil changes with filter, four-wheel or single-rear-wheel tire rotations and 27-point inspections, according to your new vehicle's recommended maintenance schedule, for up to 2 years or 24,000 miles, whichever comes first. Does not include air filters. Maximum of four service events. See participating dealer for other restrictions and complete details. <sup>2</sup>Whichever comes first. See dealer for limited warranty details. <sup>3</sup>Visit onstar.com for coverage map, details and system limitations. OnStar acts as a link to existing emergency service providers. Services vary by model and conditions. <sup>4</sup>Visit onstar.com for vehicle availability, details and system limitations. OnStar acts as a link to existing emergency service providers. Not all vehicles may transmit all crash data. <sup>5</sup>Roadside service provided by Allstate Roadside Services. <sup>6</sup>Services vary by model and conditions. <sup>7</sup>OnStar Hands-Free Calling requires existing OnStar service contract and prepaid minutes. Not available in certain markets. Calls can be made in U.S. and Canada only. Visit onstar.com for coverage map, details and system limitations. <sup>8</sup>Available on select Apple<sup>®</sup> Android<sup>™</sup>, BlackBerry<sup>®</sup> and Windows<sup>®</sup> devices. Services vary by device, vehicle and conditions. Requires an active OnStar subscription, standard for 6 months. <sup>9</sup>Access is available for 5 years from the date of vehicle delivery and is transferable. Does not include any emergency services or other OnStar services. To cancel RemoteLink Key Fob Services, or if your vehicle is sold, it is important to contact an OnStar Advisor. See onstar.com/mobile for full details. <sup>10</sup>Requires factory-installed and enabled remote start.

ACCENTS



Axiom Aluminum



Burnish Aluminum



Mineral Caster Wood Tone



Grand Lace Wood Tone



Curly Wood Tone



Jet Black/  
Dark Ash Vinyl



Jet Black/  
Dark Ash Cloth



Jet Black/  
Jet Black Cloth

INTERIOR COLORS AND SEATING SURFACES

SIERRA

—

—

—

—

—

○

●

—

SLE

●

—

●<sup>1</sup>

●<sup>2</sup>

—

—

●

●

SLT

●

—

●<sup>1</sup>

●<sup>2</sup>

—

—

—

—

DENALI

—

●

—

—

●

—

—

—

KEY ● STANDARD ○ AVAILABLE — NOT AVAILABLE <sup>1</sup>With Cocoa/Dune interior color only. <sup>2</sup>With Jet Black and Jet Black/Dark Ash interior color only.

EXTERIOR COLORS



Cobalt Blue Metallic<sup>3</sup>

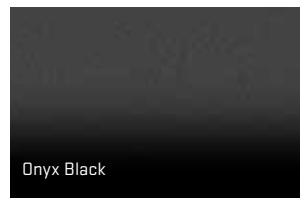

Onyx Black



Quicksilver Metallic

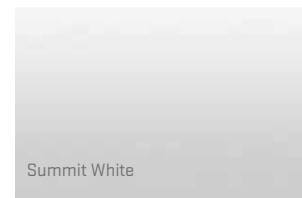

Summit White

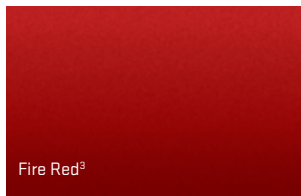

Fire Red<sup>3</sup>

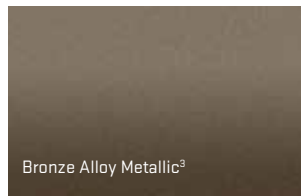

Bronze Alloy Metallic<sup>3</sup>



Iridium Metallic

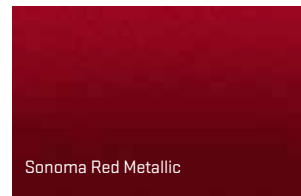









Sonoma Red Metallic

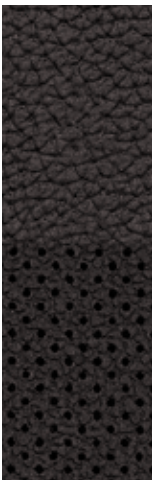

Stealth Gray Metallic<sup>3</sup>

<sup>3</sup>Not available on Denali. See your GMC dealer for more exterior color details and availability.

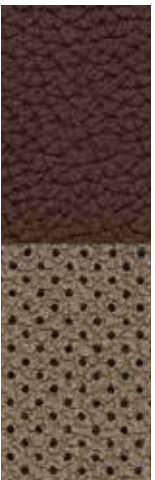

								
Cocoa/Dune Cloth	Jet Black/Jet Black Leather-Appointed	Jet Black/Dark Ash Leather-Appointed	Cocoa/Dune Leather-Appointed	Jet Black/Jet Black Perforated Leather-Appointed	Jet Black/Dark Ash Perforated Leather-Appointed	Cocoa/Dune Perforated Leather-Appointed	Jet Black/Jet Black Perforated Leather-Appointed with Unique Denali Accents	Cocoa/Dune Perforated Leather-Appointed with Unique Denali Accents
-	-	-	-	-	-	-	-	-
●	○	-	-	-	-	-	-	-
-	●	●	●	○	○	○	-	-
-	-	-	-	-	-	-	○	○

**WHEELS**

**2500HD**



17" PAINTED STEEL (PYN) STANDARD ON 2500HD SIERRA



17" MACHINED ALUMINUM (PYQ) STANDARD ON 2500HD SLE; AVAILABLE ON 2500HD SIERRA



20" POLISHED FORGED ALUMINUM (PYS) AVAILABLE ON 2500HD SLE AND SLT



18" PAINTED STEEL (PYT) STANDARD ON 3500HD SRW SIERRA; AVAILABLE ON 2500HD SIERRA



18" POLISHED FORGED ALUMINUM (PYR) STANDARD ON 2500HD SLT AND 3500HD SRW SLE AND SLT; AVAILABLE ON 2500HD SLE

**DENALI HD SRW**



18" POLISHED FORGED ALUMINUM (PYR) STANDARD ON 2500 AND 3500 DENALI HD SRW



20" POLISHED FORGED ALUMINUM (PYS) AVAILABLE ON 2500 DENALI HD

**3500HD DRW**



17" PAINTED STEEL (PYW) STANDARD ON 3500HD DRW SIERRA



17" PAINTED STEEL WITH CHROME OVERLAY (POB) STANDARD ON 3500HD DRW SLE AND SLT



17" POLISHED FORGED ALUMINUM (RS7) STANDARD ON 3500 DENALI HD DRW; AVAILABLE ON 3500HD DRW SLE AND SLT, CREW CAB ONLY

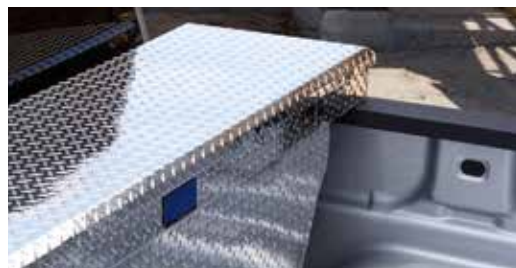

## TAKE YOUR HD PERSONALLY.

---

Engineered to the same standards as your Sierra HD, GMC Accessories range from functional enhancements like assist steps and bed protection to a stylish array of accents. Go ahead, equip your Sierra HD exactly the way you want.

**20" WHEELS** To lend a personal style to your Sierra HD, choose from these distinctive-looking aluminum or polished aluminum wheels.

**ASSIST STEPS** Make it easier to get in and out of your truck with stylish assist steps. Crafted from rust-resistant stainless steel, they are available in either chrome or black powder coat and in 6" oval or 3" round styles.

**TONNEAU COVERS** The soft cover shields cargo and easily rolls up to allow full access to the bed and is constructed with integrated crossbows. The hard cover is tri-folding and adds strong content protection and easy access to the cargo box.

**STATIONARY TOOLBOX** Diamond-patterned toolbox features a cover with dual gas shocks for smooth opening and closing, and it features the GMC logo.

**POLISHED EXHAUST TIPS** These chrome exhaust tips add a bold appearance and feature the GMC logo.

**CHROME RECOVERY HOOKS** Add functionality and enhance the appearance of your Sierra HD with chrome recovery hooks. These front hooks are for vehicle recovery only and cannot be used for towing. For more information, see your GMC Owner's Manual.

**BED LINERS** These molded plastic liners add a layer of durable protection and are custom designed for your specific bed size.

**BED PROTECTION PACKAGE** Shield the finish of the bed with a bed mat, tailgate liner and soft folding tonneau cover.

**CHROME PACKAGE** Add flare to your Sierra HD with 4" round chrome tubular assist steps, a polished exhaust tip and chrome recovery hooks.

**INTERIOR PROTECTION PACKAGE** Protect the cabin and the bed of your Sierra HD with all-weather floor mats and a rubber bed mat.



**SIERRA HD SPECIFICATIONS**

CARGO DIMENSIONS <sup>1</sup>			
DIMENSIONS	STANDARD BOX	LONG BOX SRW	LONG BOX DRW
Cargo Volume	61.0 cu. ft.	76.3 cu. ft.	76.3 cu. ft.
Inside Width at Floor (in.)	51.0	51.0	51.0
Box Length at Floor (in.)	78.9	97.8	97.8
Inside Box Height (in.)	21.2	21.2	21.3
EXTERIOR DIMENSIONS	REGULAR CAB	DOUBLE CAB	CREW CAB
Height (in.)	77.3-77.9 <sup>2</sup>	77.6-78.1 <sup>2</sup>	77.8-78.3 <sup>2</sup>
Overall Length (in.)			
Standard Box	–	230.0	239.5
Long Box	224.4	248.9	258.4
INTERIOR DIMENSIONS (in.)	REGULAR CAB	DOUBLE CAB	CREW CAB
Head Room (front/rear)	42.8/–	42.8/38.6	42.8/40.5
Leg Room (front/rear)	45.2/–	45.2/34.6	45.2/40.9
Shoulder Room (front/rear)	66.0/–	64.8/64.3	64.8/64.3
Hip Room (front/rear)	60.7/–	60.7/60.2	60.7/60.2
WHEELBASE (in.)	REGULAR CAB	DOUBLE CAB	CREW CAB
Standard Box	–	144.2	153.7
Long Box	133.6	158.1	167.7
STANDARD TECHNICAL DATA			
Series / Drive Type	2WD	4WD	
BRAKES <small>All models: Power 4-wheel antilock braking system</small>	14" diameter 4-wheel disc	14" diameter 4-wheel disc	
STEERING	Power recirculating ball	Power recirculating ball	
FUEL TANK CAPACITY <small>(Approx. gals.)</small>	36.0	36.0	
ALTERNATOR (amps)	150	150	
MAXIMUM GVWR <sup>3</sup> <small>(Gross Vehicle Weight Rating, lbs)</small>	VORTEC 6.0L V-8/DURAMAX 6.6L V-8 TURBO DIESEL		
	REGULAR CAB	DOUBLE CAB	CREW CAB
2500HD			
Standard Box	–/–	9500/10,000	9500/10,000
Long Box	9500/9900	9500/10,000	9900/10,000
3500HD			
SRW	10,700/11,400	11,000/11,600	11,000/11,600
DRW	13,500/13,025	13,025/13,025	13,025/13,025

<sup>1</sup>Cargo and load capacity limited by weight and distribution. <sup>2</sup>Depending on model and tire size selected. <sup>3</sup>When properly equipped; includes weight of vehicle, passengers, cargo and equipment.

## SIERRA HD SPECIFICATIONS (CONTINUED)

## SIERRA HD SPECIFICATIONS

## ENGINES

	VORTEC 6.0L V-8 VVT (L96)	6.0L V-8 VVT (LC8) Bi-Fuel Compressed Natural Gas (CNG)	DURAMAX 6.6L V-8 TURBO DIESEL (LML)
FUEL TYPE	Gasoline (FlexFuel)	Gasoline/CNG	Diesel (B20 Biodiesel capable)
CAPACITY	6.0 liters (364 cu. in.)	6.0 liters (364 cu. in.)	6.6 liters (402 cu. in.)
SAE NET HORSEPOWER @ RPM	360@5400	360@5400 (Gas) 301@5000 (CNG)	397@3000
SAE NET TORQUE (LB-FT) @ RPM	380@4200	380@4200 (Gas) 333@4200 (CNG)	765@1600
ENGINE/MODEL AVAILABILITY			
Regular Cab	●	○ <sup>1</sup>	○
Double Cab	●	○	○
Crew Cab	●	○	○

## SIERRA HD SUSPENSIONS

FRONT SUSPENSIONS<sup>2</sup>

## INDEPENDENT TORSION BAR-2500HD/3500HD

STANDARD FRONT AXLE/ SPRING CAPACITY (lbs)	2WD	4WD
Regular Cab	4400/4400	4400/4400
Double Cab	4400/4400	4400/4800
Crew Cab	4400/4400	4800/4800

REAR SUSPENSIONS<sup>2</sup>

## SEMI-ELLIPTICAL MULTILEAF-2500HD/3500HD-SRW/3500HD-DRW

REAR AXLE/SPRING CAPACITY (lbs)	2WD	4WD
Regular Cab	6200/7050/9825	6200/7050/9825
Double Cab	6200/7050/9375	6200/7050/9375
Crew Cab	6200/7050/9375	6200/7050/9375

KEY ● STANDARD ○ AVAILABLE - NOT AVAILABLE

<sup>1</sup>Available fall 2014. See your dealer for more details and model availability. <sup>2</sup>Capacities and weight ratings are dependent on model, engine, transmission and GVWR combinations. See your GMC dealer for details.



**CONVENTIONAL TRAILER WEIGHT RATINGS<sup>3</sup>**

Model	Engine	Axle Ratio	GCWR <sup>4</sup>	2500HD Standard Box 2WD SRW	2500HD Long Box 2WD SRW	3500HD Standard Box 2WD SRW	3500HD Long Box 2WD SRW	3500HD Long Box 2WD DRW	2500HD Standard Box 4WD SRW	2500HD Long Box 4WD SRW	3500HD Standard Box 4WD SRW	3500HD Long Box 4WD SRW	3500HD Long Box 4WD DRW
Regular Cab	Vortec 6.0L V-8	4.10	20,500	-	13,000	-	13,000	14,200	-	13,000	-	13,000	13,900
	Duramax 6.6L V-8 Turbo Diesel	3.73	24,500	-	13,000	-	-	-	-	13,000	-	13,000	-
		3.73	30,500	-	-	-	-	-	-	-	-	-	-
Double Cab	Vortec 6.0L V-8	4.10	20,500	13,000	13,000	-	13,000	13,800	13,000	13,000	-	13,000	13,500
	Duramax 6.6L V-8 Turbo Diesel	3.73	24,500	13,000	13,000	-	13,000	-	13,000	13,000	-	13,000	-
		3.73	30,500	-	-	-	-	16,500	-	-	-	-	-
Crew Cab	Vortec 6.0L V-8	4.10	20,500	13,000	13,000	13,000	13,000	13,700	13,000	13,000	13,000	13,000	13,300
	Duramax 6.6L V-8 Turbo Diesel	3.73	24,500	13,000	13,000	13,000	13,000	-	13,000	14,500	13,000	15,000	-
		3.73	30,500	-	-	-	-	16,500	-	-	-	-	-

SRW-Single Rear Wheel DRW-Dual Rear Wheel

**FIFTH-WHEEL/GOOSENECK TRAILER WEIGHT RATINGS<sup>3</sup>**

Model	Engine	Axle Ratio	GCWR <sup>4</sup>	2500HD Standard Box 2WD SRW	2500HD Long Box 2WD SRW	3500HD Standard Box 2WD SRW	3500HD Long Box 2WD SRW	3500HD Long Box 2WD DRW	2500HD Standard Box 4WD SRW	2500HD Long Box 4WD SRW	3500HD Standard Box 4WD SRW	3500HD Long Box 4WD SRW	3500HD Long Box 4WD DRW
Regular Cab	Vortec 6.0L V-8	4.10	20,500	-	14,800	-	14,600	14,200	-	14,500	-	14,300	13,900
	Duramax 6.6L V-8 Turbo Diesel	3.73	24,500	-	17,900	-	-	-	-	17,600	-	17,500	-
		3.73	30,500	-	-	-	-	-	-	-	-	-	-
Double Cab	Vortec 6.0L V-8	4.10	20,500	14,500	14,400	-	14,200	13,800	14,200	14,100	-	13,900	13,500
	Duramax 6.6L V-8 Turbo Diesel	3.73	24,500	17,600	17,500	-	17,500	-	17,300	17,200	-	17,200	-
		3.73	30,500	-	-	-	-	23,000	-	-	-	-	-
Crew Cab	Vortec 6.0L V-8	4.10	20,500	14,300	14,200	14,100	14,000	13,700	14,000	13,800	13,900	13,700	13,300
	Duramax 6.6L V-8 Turbo Diesel	3.73	24,500	17,400	17,300	17,400	17,300	-	17,100	16,400	17,100	16,900	-
		3.73	30,500	-	-	-	-	22,900	-	-	-	-	-

SRW-Single Rear Wheel DRW-Dual Rear Wheel <sup>3</sup>Maximum trailer weight ratings are calculated assuming a base vehicle, except for any option(s) necessary to achieve the rating, plus driver. The weight of other optional equipment, passengers and cargo will reduce the maximum trailer weight your vehicle can tow. See your GMC dealer for additional details. <sup>4</sup>Gross Combined Weight Rating. When properly equipped, includes weight of the vehicle and trailer combination, including the weight of driver, passengers, fuel, optional equipment and cargo in the vehicle and trailer.

**AXLE RATINGS AND PLOW WEIGHTS**
**FRONT GROSS AXLE WEIGHT RATING (FGAWR) WITH SNOW PLOW PREP PACKAGE (4WD MODELS ONLY)**

NOTE: All models are capable of up to 100 lbs maximum of permanently attached snow plow mounting hardware.

Model	Engine RPD	Engine Type	2500HD SRW	3500HD SRW	3500HD DRW
Regular Cab	L96	Gas	5200	5600	5600
	LML	Diesel	6000	6000	6000
Double Cab Standard Box/ Long Box	L96	Gas	5200/5600	-/5600	-/5600
	LML	Diesel	6000/6000	-/6000	-/6000
Crew Cab Standard Box/ Long Box	L96	Gas	5200/5600	5600/5600	-/5600
	LML	Diesel	6000/6000	6000/6000	-/6000

**MAXIMUM PLOW WEIGHTS<sup>5</sup> (4WD MODELS ONLY)**

Model	Engine RPD	Engine Type	2500HD SRW	3500HD SRW	3500HD DRW
Regular Cab	L96	Gas	900	1000	1000
	LML	Diesel	975	975	925
Double Cab Standard Box/ Long Box	L96	Gas	775/1000	-/1000	-/1000
	LML	Diesel	825/775	-/800	-/775
Crew Cab Standard Box/ Long Box	L96	Gas	725/950	1000/950	-/925
	LML	Diesel	775/700	800/725	-/700

SRW-Single Rear Wheel DRW-Dual Rear Wheel <sup>5</sup>Maximum weight (lbs) of removable snow plow blade and blade hardware. Maximum plow weights based on a vehicle with average manufacturer option content and 150 lbs each for driver and one additional front-seat occupant. Additional equipment and occupants will reduce maximum plow weight. Rear compensating weight may be required to maintain front axle weight below 65% of total vehicle weight when equipped with snow plow. Consult your snow plow manufacturer for specific compensating weight recommendation.

## SIERRA HD SPECIFICATIONS (CONTINUED)

MAXIMUM PAYLOAD <sup>1</sup>														
Model	Engine	GVWR <sup>2</sup>	2500HD Standard Box 2WD SRW	2500HD Long Box 2WD SRW	3500HD Standard Box 2WD SRW	3500HD Long Box 2WD SRW	3500HD Long Box 2WD DRW	2500HD Standard Box 4WD SRW	2500HD Long Box 4WD SRW	3500HD Standard Box 4WD SRW	3500HD Long Box 4WD SRW	3500HD Long Box 4WD DRW		
Regular Cab	Vortec 6.0L V-8	9300	-	3760/3105 <sup>3</sup>	-	-	-	-	-	-	-	-		
		9500	-	-	-	-	-	-	3633/2953 <sup>3</sup>	-	-	-		
		10,400	-	-	-	4682/4018 <sup>3</sup>	-	-	-	-	-	-		
		10,700	-	-	-	-	-	-	-	-	4660/4005 <sup>3</sup>	-		
		13,400	-	-	-	-	-	-	-	-	-	6952		
		13,500	-	-	-	-	-	7374	-	-	-	-		
	Duramax 6.6L V-8 Turbo Diesel	9900	-	3501	-	-	-	-	-	3174	-	-	-	
		11,400	-	-	-	-	-	-	-	-	-	4600	-	
		13,025	-	-	-	-	-	-	-	-	-	-	5817	
	Double Cab	Vortec 6.0L V-8	9500	3671/3016 <sup>3</sup>	3559/2905 <sup>3</sup>	-	-	-	3379/2724 <sup>3</sup>	3274/2620 <sup>3</sup>	-	-	-	
10,700			-	-	-	4593/3938 <sup>3</sup>	-	-	-	-	-	-		
11,000			-	-	-	-	-	-	-	-	-	4617/3963 <sup>3</sup>	-	
13,025			-	-	-	-	-	6450	-	-	-	-	6170	
Duramax 6.6L V-8 Turbo Diesel		10,000	3312	3200	-	-	-	-	3020	2915	-	-	-	
		11,200	-	-	-	-	4333	-	-	-	-	-	-	
		11,600	-	-	-	-	-	-	-	-	-	4457	-	
		13,025	-	-	-	-	-	5690	-	-	-	-	5410	
		Crew Cab	Vortec 6.0L V-8	9500	3441/2786 <sup>3</sup>	3340/2685 <sup>3</sup>	-	-	-	3152/2493 <sup>3</sup>	-	-	-	-
				9900	-	-	-	-	-	-	3388/2733 <sup>3</sup>	-	-	-
10,500	-			-	4319/3664 <sup>3</sup>	-	-	-	-	-	-	-		
10,700	-			-	-	4387/3732 <sup>3</sup>	-	-	-	-	-	-		
10,800	-			-	-	-	-	-	-	-	4324/3669 <sup>3</sup>	-		
11,000	-			-	-	-	-	-	-	-	-	4348/3694 <sup>3</sup>		
Duramax 6.6L V-8 Turbo Diesel	13,025	-	-	-	-	-	6308	-	-	-	-	5965		
	10,000	3082	2981	-	-	-	-	2793	2628	-	-	-		
	11,100	-	-	4159	-	-	-	-	-	-	-	-		
	11,400	-	-	-	4327	-	-	-	-	-	-	-		
	11,500	-	-	-	-	-	-	-	-	4264	-	-		
	11,600	-	-	-	-	-	-	-	-	-	4188	-		
	13,025	-	-	-	-	-	5548	-	-	-	-	5205		

<sup>1</sup>Maximum payload capacity includes weight of driver, passengers, optional equipment and cargo. <sup>2</sup>Gross Vehicle Weight Rating (GVWR). When properly equipped; includes weight of vehicle, passengers, cargo and equipment. <sup>3</sup>Maximum payload capacity when equipped with the available Vortec 6.0L V-8 CNG engine (LC8). Regular Cab, Denali HD and all 3500HD models available fall 2014. See your dealer for more details and model availability.

TRIM LEVELS

CONFIGURATIONS	SIERRA	SLE	SLT	DENALI
REGULAR CAB	○	○	-	-
DOUBLE CAB	○	○	○	-
CREW CAB	○	○	○	○
2WD	○	○	○	○
4WD	○	○	○	○

MECHANICAL

<b>AIR CLEANER</b> High capacity	●	●	●	●
<b>ALTERNATOR</b> 150 amps	●	●	●	●
220 amps. Included with the Snow Plow Prep Package when Vortec 6.0L V-8 VVT SFI is ordered. Requires Vortec 6.0L VVT SFI V-8 or 6.0L V-8 Bi-Fuel Compressed Natural Gas (CNG) engine.	○	○	○	○
Dual, 150 amps each. Included with the Snow Plow Prep Package when Duramax 6.6L V-8 Turbo Diesel is ordered. Requires Duramax 6.6L V-8 Turbo Diesel engine.	○	○	○	○
<b>AUXILIARY EXTERNAL TRANSMISSION OIL COOLER</b>	●	●	●	●
<b>AUXILIARY EXTERNAL ENGINE OIL COOLER</b>	●	●	●	●
<b>BATTERY</b> Heavy-duty maintenance-free with rundown protection and retained accessory power	●	●	●	●
<b>AUXILIARY BATTERY</b> 730 Cold Cranking Amps (CCA). Requires Vortec 6.0L VVT SFI V-8 engine.	○	○	○	○
<b>BRAKES</b> 4-wheel disc with 4-wheel antilock	●	●	●	●
<b>COLD-WEATHER PROVISIONS</b> Includes front radiator grille and front bumper openings cover. Requires Duramax 6.6L V-8 Turbo Diesel engine.	○	○	○	○
<b>EATON® HEAVY-DUTY AUTOMATIC LOCKING REAR DIFFERENTIAL</b> Included and only available with Trailering Equipment Package on 2500HD models with Sierra trim. Standard on 3500HD pickup models.	○	●	●	●
<b>FRAME</b> Fully boxed with hydroformed front section	●	●	●	●
<b>ENGINE</b> Vortec 6.0L V-8 VVT FlexFuel with SFI	●	●	●	●
6.0L V-8 VVT Bi-Fuel CNG. Restrictions apply. Regular Cab, Denali HD and all 3500HD models available fall 2014. See your dealer for more details and model availability.	○	○	○	○
Duramax 6.6L V-8 Turbo Diesel with direct injection and B20 biodiesel capability	○	○	○	○
<b>ENGINE BLOCK HEATER</b> Required with Duramax 6.6L V-8 Turbo Diesel	○	○	○	○
<b>EXHAUST</b> Aluminized stainless-steel muffler and tailpipe	●	●	●	●
<b>EXHAUST BRAKE</b> Switch activated. Included and only available with Duramax 6.6L V-8 Turbo Diesel.	○	○	○	○
<b>HIGH IDLE SWITCH</b>	○	○	○	○
<b>INTEGRATED TRAILER BRAKE CONTROLLER</b> Included on all 3500HD models	○	●	●	●
<b>STABILITRAK STABILITY CONTROL SYSTEM</b> Includes Proactive Roll Avoidance, traction control, electronic trailer sway control and Hill Start Assist	●	●	●	●
<b>STEERING</b> Power, recirculating ball	●	●	●	●
<b>SUSPENSION</b> Front independent with torsion bars. Includes 51-mm twin-tube shock absorbers and 33-mm front stabilizer bar.	●	●	●	●
Rear multileaf springs, semielliptical with urethane jounce bumpers	●	●	●	●
<b>TRANSMISSION</b> 6L90-E 6-speed automatic. Includes Tow/Haul mode, Cruise Grade Braking and Powertrain Grade Braking.	●	●	●	●
Allison® 1000 Series 6-speed automatic. Includes Tow/Haul mode and electronic Powertrain Grade Braking. Requires Duramax 6.6L V-8 Turbo Diesel.	○	○	○	○
<b>TRANSFER CASE</b> 2-speed with 2.72-to-1 low-range, floor-mounted shifter (4WD models only)	●	-	-	-
Electronic shift rotary dial controls 2-speed and 2.72-to-1 low-range (4WD models only)	-	●	●	●
<b>TRAILER WIRING PROVISIONS</b> For camper, fifth-wheel and gooseneck trailer. Includes additional 7-way wiring harness routed to front of pickup box. Not available with 6.0L V-8 Bi-Fuel CNG engine.	○	○	○	○
<b>REAR AXLE</b> 4.10 ratio. Standard and only available on Vortec 6.0L V-8 or 6.0L V-8 Bi-Fuel CNG engine.	●	●	●	●
3.73 ratio. Requires Duramax 6.6L V-8 Turbo Diesel.	○	○	○	○

INSTRUMENTATION AND CONTROLS

<b>DRIVER INFORMATION CENTER</b> With 3.5" diagonal monochromatic display. Provides warning messages, odometer, trip odometer and basic vehicle information.	●	-	-	-
With 4.2" diagonal color display. Includes driver personalization, warning messages, odometer, trip odometer and vehicle information.	-	●	●	-
8" color customizable display	-	-	-	●
<b>POWER-ADJUSTABLE PEDALS</b> On SLE models, included and only available with SLE Convenience Package. Not available on Regular Cab.	-	○	●	●
<b>110-VOLT POWER OUTLET</b> In-cabin, 3-prong, household-style outlet. Included and only available with Convenience Package on Sierra trim. On SLE, included and only available with the SLE Preferred Package.	○	○	○	●

KEY ● STANDARD ○ AVAILABLE - NOT AVAILABLE

TRIM LEVELS

<b>STEERING WHEEL</b> Polyurethane with cruise controls	●	-	-	-
Leather-wrapped with audio and cruise controls	-	●	●	-
Heated and leather-wrapped with audio and cruise controls	-	-	○	●
<b>STEERING COLUMN</b> Tilt-Wheel, manual operation	●	●	●	-
Tilt-Wheel and telescopic manual operation	-	○	○	●

SEATING

<b>SEATS</b> Front 3-passenger cloth 40/20/40 split bench with driver and front-passenger manual recline, manual driver lumbar control and outboard head restraints. Includes center fold-down armrest with storage.	●	-	-	-
Front 3-passenger vinyl 40/20/40 split bench with driver and front-passenger manual recline and outboard head restraints. Includes center fold-down armrest with storage.	○	-	-	-
Front 3-passenger cloth 40/20/40 split bench with driver and front-passenger manual recline and outboard head restraints. Includes center fold-down armrest and lockable storage compartment in lower seat cushion.	-	●	-	-
Front 3-passenger leather-appointed 40/20/40 split bench with heated seat cushions and seatbacks. Not available on Regular Cab models. Requires Jet Black interior trim.	-	○	-	-
Front 3-passenger leather-appointed 40/20/40 split bench with 10-way power seat adjusters. Includes power lumbar control, heated seat cushions and seatbacks, 2-position driver memory (does not apply to lumbar adjuster) and adjustable head restraints.	-	-	●	-
Front cloth bucket seats with 10-way driver-seat power adjuster, 6-way passenger-seat power adjuster, heated seat cushions and seatbacks, adjustable head restraints, floor console and storage pockets	-	○	-	-
Front leather-appointed bucket seats with 10-way power seat adjusters including power lumbar control, heated seat cushions and seatbacks, 2-position driver memory (does not apply to lumbar adjuster), adjustable head restraints and floor console and storage pockets	-	-	○	-
Seat adjuster, driver 10-way power. Requires bench seat. Included and only available with SLE Preferred Package.	-	○	-	-
Heated driver and front-passenger cloth seating. Requires SLE Preferred Package and cloth 40/20/40 split bench seat.	-	○	-	-
Heated and cooled perforated leather-appointed front bucket seats. Included with Driver Alert Package. On Denali, includes embossed Denali on front seats and 12-way driver and front-passenger power adjuster, including power lumbar control.	-	-	○	●
Folding rear 3-passenger bench. Double Cab models only. Includes child seat top tether anchor.	●	-	-	-
Folding rear 60/40 split 3-passenger bench. Includes child seat top tether anchor. Double and Crew Cab models only.	-	●	●	●

INTERIOR DETAILS

<b>AUXILIARY SWITCH BANK</b> Includes 4 upfitter switches	○	-	-	-
<b>CLIMATE CONTROL</b> Single-zone manual air conditioning	●	●	-	-
Dual-zone automatic climate control. On SLE, included and only available with SLE Preferred Package. Not available on Regular Cab models.	-	○	●	●
<b>CRUISE CONTROL</b>	●	●	●	●
<b>DEFROSTER</b> Rear-window electric. On SLE, included and only available with SLE Preferred Package or SLE Convenience Package.	○	○	●	●
<b>DOOR LOCKS</b> Power	●	●	●	●
<b>FLOOR COVERING</b> Color-keyed carpeting with rubberized vinyl floor mats. (Double Cab and Crew Cab models include second-row floor mats.)	○	●	●	●
Graphite-colored rubberized vinyl	●	○	-	-
<b>REAR PARK ASSIST</b> Ultrasonic. On Double Cab and Crew Cab models, included and only available with SLE Convenience Package.	-	○	-	-
<b>FRONT AND REAR PARK ASSIST</b> Ultrasonic. On SLE, requires Regular Cab and Driver Alert Package.	-	○	○	●
<b>REAR VISION CAMERA SYSTEM WITH DYNAMIC GRID LINES</b>	-	●	●	●
<b>REMOTE START</b> On SLE, included and only available with SLE Preferred Package	-	○	●	●
<b>REMOTE KEYLESS ENTRY</b> Included and only available with Convenience Package on Sierra trim	○	●	●	●
<b>REARVIEW MIRROR</b> With manual day/night adjustment	●	●	-	-
With inside rearview auto-dimming feature. Included and only available with outside heated, power-adjustable vertical camper mirrors on 2500HD SLE and 3500HD with Sierra trim.	○	○	●	●
<b>SILL PLATES</b> Bright accent	-	-	-	●
<b>SUNROOF</b> Power sliding with express-open. Crew Cab models only. Not available with provisions for roof-mounted lamps or Snow Plow Prep Package.	-	-	○	○
<b>UNIVERSAL HOME REMOTE</b> On SLE, included and only available with SLE Convenience Package. Not available on Regular Cab models, provisions for roof-mounted lamps or Snow Plow Prep Package.	-	○	●	●
<b>WINDOWS</b> Manual. Standard on Regular Cab with Sierra trim only.	●	-	-	-
Power with driver express-up and -down and express-down on all other windows.	●	●	●	●
Power rear sliding with rear defroster. Not available on Regular Cab models, provisions for roof-mounted lamps or Snow Plow Prep Package.	-	○	○	●





TRIM LEVELS	SIERRA	SLE	SLT	DENALI
<b>OPTION PACKAGES</b>				
<b>SIERRA CONVENIENCE PACKAGE</b> Includes outside heated power-adjustable mirrors, Remote Keyless Entry, 100-volt AC power outlet, LED cargo box lighting, deep-tinted glass and power windows on Regular Cab models	○	—	—	—
<b>SLE CONVENIENCE PACKAGE</b> Includes power-adjustable pedals, Rear Park Assist and rear-window defogger. When provisions for cab roof-mounted lamps/beacon or Snow Plow Prep Package are ordered, the Universal Home Remote will not be included. Not available on Regular Cab models.	—	○	—	—
<b>SLE PREFERRED PACKAGE</b> Includes driver 10-way power seat adjuster with front 40/20/40 split-bench seat only. Also includes Remote Vehicle Starter System, front fog lamps, rear-window defogger and 110-volt power outlet. When provisions for cab roof-mounted lamps/beacon or Snow Plow Prep Package are ordered, the Universal Home Remote will not be included. Also includes Universal Home Remote and dual-zone automatic climate control on Double Cab and Crew Cab models.	—	○	—	—
<b>DRIVER ALERT PACKAGE</b> Includes Lane Departure Warning, Forward Collision Alert and Safety Alert Driver Seat. Also includes Front and Rear Park Assist. On SLT trim, requires heated and cooled driver and front-passenger seating, full-feature leather-appointed bucket seats and manual tilt and telescoping steering column. On SLE trim, requires Regular Cab with Jet Black Cloth interior, SLE Preferred Package and Tilt and Telescopic Steering Column. On 3500HD models, requires front-seat-mounted side-impact and front and rear head curtain side-impact air bags. <sup>1</sup>	—	○	○	○
<b>Z71 OFF-ROAD SUSPENSION PACKAGE</b> Includes Hill Descent Control, underbody shields, monotube Rancho® shocks and Z71 front fender emblems. SRW models only.	—	○	○	○
<b>TRAILERING EQUIPMENT PACKAGE</b> Includes trailer hitch platform 2.5" with a 2.0" insert, 7-wire harness with independent fused trailering circuits mated to a 7-way sealed connector to hook up parking lamps, back-up lamps, turn signals, an electric brake lead, battery and a ground. Connector also includes the 4-way blade-style connector. 2500HD models include automatic locking rear differential and trailer brake controller. Included on 3500HD models. Not available with rear bumper delete.	○	●	●	●
<b>SNOW PLOW PREP PACKAGE</b> Includes power feed for back-up and roof emergency light, 220-amp alternator with Vortec 6.0L V-8 (dual 150-amp included with Duramax 6.6L V-8 Turbo Diesel), forward lamp wiring harness, provisions for cab roof-mounted lamps/beacon, Underbody Shield Package and increased Front Gross Axle Weight Rating (FGAWR). 4WD models only. See your dealer for details.	○	○	○	○
<b>UNDERBODY SHIELD PACKAGE</b> Includes frame-mounted shields, front underbody shield starting behind front bumper and running to first cross member, protecting front underbody, oil pan, differential case and transfer case. Included and only available with Snow Plow Prep Package or Z71 Off-Road Suspension Package.	○	○	○	●
<b>PROVISIONS FOR CAB-MOUNTED LAMPS/BEACON</b> Includes instrument panel-mounted switch and electrical wiring tucked beneath the headliner for body upfitter to connect a body-mounted warning or emergency lamp. Included with Snow Plow Prep Package. Not available with Universal Home Remote, power sliding rear window or power sunroof.	○	○	○	○
<b>ENTERTAINMENT / COMMUNICATION / NAVIGATION</b>				
<b>4.2" DIAGONAL COLOR RADIO</b> Includes AM/FM, USB ports; <sup>2</sup> auxiliary jack and SD card slot	●	—	—	—
<b>4.2" DIAGONAL COLOR RADIO WITH INTELLILINK<sup>3</sup></b> Includes AM/FM/CD, USB ports; <sup>2</sup> SD card slot, auxiliary jack, Bluetooth <sup>4</sup> streaming audio for music and select phones, hands-free smartphone integration, Pandora <sup>5</sup> internet radio and voice-activated technology for radio and phone	○	●	—	—
<b>8" DIAGONAL COLOR TOUCH RADIO WITH INTELLILINK<sup>3</sup></b> Includes AM/FM/SiriusXM <sup>6</sup> (standard for 3 months), USB ports; <sup>2</sup> SD card slot, auxiliary jack, Bluetooth <sup>4</sup> streaming audio for music and select phones, hands-free smartphone integration, Pandora <sup>5</sup> internet radio and voice-activated technology for radio, phone and customizable themes. Not available on Regular Cab models.	—	●	●	—
<b>8" DIAGONAL COLOR TOUCH RADIO WITH NAVIGATION<sup>7</sup></b> Includes all features of 8" diagonal Color Touch Radio with IntelliLink <sup>3</sup> plus Navigation feature. Not available on Regular Cab models.	—	○	○	●
Single-slot CD/MP3 player. On Regular Cab models, requires 4.2" diagonal Color Touch Radio with IntelliLink <sup>3</sup>	○	●	●	●
<b>6-SPEAKER AUDIO SYSTEM</b> 4-speaker on Regular Cab Sierra model	●	●	●	—
Bose <sup>8</sup> premium audio system with 6 speakers (7-speaker system including subwoofer when ordered with bucket seats)	—	—	○	●
<b>BLUETOOTH<sup>4</sup> FOR PHONE</b> Personal cell phone connectivity to vehicle audio system. On Sierra trim, included and only available with 4.2" diagonal Color Touch Radio with IntelliLink <sup>3</sup>	○	●	●	●
<b>ONSTAR<sup>9</sup></b> Directions & Connections Plan. 6-month subscription.	○	●	●	●
<b>SIRIUSXM<sup>6</sup> SATELLITE RADIO</b> Including 3 trial months of service. On Sierra trim, requires 4.2" diagonal Color Touch Radio with IntelliLink <sup>3</sup> and OnStar. <sup>7</sup>	○	●	●	●

KEY ● STANDARD ○ AVAILABLE — NOT AVAILABLE

TRIM LEVELS	SIERRA	SLE	SLT	DENALI
<b>EXTERIOR STYLING AND FUNCTIONALITY</b>				
<b>ASSIST STEPS</b> Chromed tubular with 6" rectangular design. Included on 3500HD SLT trim with dual rear wheels only.	○	○	○	●
<b>BUMPER</b> Front, chrome	●	●	●	—
Rear, chrome with CornerStep bumper	●	●	●	—
Front, body-color	—	—	—	●
Rear, body-color with CornerStep bumper	—	—	—	●
<b>ROOF MARKER LAMPS</b> Included with Dual Rear Wheel models. Optional on Single Rear Wheels models.	○	○	○	○
<b>CARGO BDX</b> Movable tie-downs, high-mounted (4)	●	●	●	●
Box rail caps	●	●	●	●
<b>DOOR HANDLES</b> Black	●	—	—	—
Body-color	—	●	—	—
Chrome	—	—	●	●
<b>FOG LAMPS</b> Front, halogen. On SLE, included and only available with SLE Preferred Package.	—	○	●	●
<b>GRILLE SURROUND</b> Chrome	●	●	●	●
Chrome-accented center	—	●	●	—
Chrome with unique Denali accents	—	—	—	●
<b>GLASS</b> Solar-Ray tinted	●	—	—	—
Solar-Ray deep-tinted. Included and only available with Convenience Package on Sierra trim.	○	●	●	●
<b>LIGHTS</b> Halogen projector-beam. Includes LED signature lighting on SLT and Denali.	●	●	●	●
Under-rail LED lighting, cargo box. Included and only available with Convenience Package on Sierra trim.	○	●	●	●
<b>MOLDINGS</b> Bodyside, body color	—	—	●	—
Bodyside, chrome	—	—	●	●
<b>RECOVERY HOOKS</b> Front frame-mounted (black)	●	●	●	●
<b>SPRAY-ON BEDLINER</b> On Denali, standard on 2500 and available on 3500 models	○	○	○	●
<b>TAILGATE</b> Locking	●	—	—	—
Locking with EZ-Lift and Lower Tailgate feature	—	●	●	●
<b>TIRE CARRIER</b> Outside spare, winch-type. Includes lock.	●	●	●	●
<b>WHEELHOUSE LINERS</b> Rear. Single Rear Wheel Double Cab and Crew Cab models only.	—	—	●	●
<b>WIPERS</b> Front intermittent	●	●	●	●
<b>OUTSIDE MIRRORS</b>				
Manual-folding, black (2500HD models only)	●	—	—	—
Heated, power-adjustable, manual-folding, black (2500HD models only). On Sierra trim, included and only available with Sierra Convenience Package.	○	●	—	—
Heated, power-adjustable/power-folding. With integrated turn signal indicators, security approach lamps, driver-side auto-dimming and puddle lamps; chrome caps. Not available on 3500HD models.	—	—	●	●
<b>VERTICAL CAMPER</b> Manual-folding with lower convex spotter glass. Standard on 3500HD models. Available on 2500HD models.	○	—	—	—
Heated, power-adjustable with integrated turn signal indicators; manual-folding/extension; black (convex glass is not heated or power-adjustable). On Sierra trim, requires Convenience Package. Standard on 3500HD SLE, SLT and Denali models.	○	○	○	○
<b>SAFETY AND SECURITY</b>				
<b>AIR BAG<sup>1</sup></b> Single-stage frontal for driver and front passenger	●	●	●	●
Front-seat-mounted side-impact driver and right front-passenger air bags for thorax and pelvis protection. Included on all 2500HD and select 3500HD models. See your dealer for more details and availability.	○	○	○	●
Front and rear head curtain side-impact air bags for all onboard seating positions. Included on all 2500HD models.	○	○	○	●
<b>DAYTIME RUNNING LAMPS</b> With automatic lamp control	●	●	●	●
<b>LANE DEPARTURE WARNING AND FORWARD COLLISION ALERT</b> Included and only available with Driver Alert Package. On SLE, requires Regular Cab.	—	○	○	○
<b>SAFETY ALERT DRIVER SEAT</b> Included and only available with Driver Alert Package. On SLE, requires Regular Cab.	—	○	○	○
<b>THEFT DETERRENT SYSTEM</b> Unauthorized entry. Included and only available with remote vehicle starter system on SLE.	—	○	●	●
<b>TIRE PRESSURE MONITORING SYSTEM</b> Does not monitor spare tire. Included on 2500HD models only.	●	●	●	●

<sup>1</sup>A NOTE ON CHILD SAFETY: Always use safety belts and the correct child restraint for your child's age and size, even with air bags. Even in vehicles equipped with the Passenger Sensing System, children are safer when properly secured in a rear seat in the appropriate infant, child or booster seat. Never place a rear-facing infant restraint in the front seat of any vehicle equipped with an active frontal air bag. See your vehicle Owner's Manual and child safety seat instructions for more safety information. <sup>2</sup>Not compatible with all devices. <sup>3</sup>Full functionality requires compatible Bluetooth and smartphone. Some devices require USB connectivity. Data plan rates apply. <sup>4</sup>Go to gmtotalconnect.com to find out which phones are compatible with the vehicle. <sup>5</sup>If you subscribe after your trial period, subscriptions are continuous until you call SiriusXM to cancel. See SiriusXM Customer Agreement for complete terms at siriusxm.com. Other fees and taxes will apply. All fees and programming subject to change. For more information about NavTraffic, visit siriusxm.com/navtraffic. For more information about TravelLink, visit siriusxm.com/travelink. XM satellite service is available only to those in the 48 contiguous USA and DC. Sirius, XM and all related marks and logos are trademarks of SiriusXM Radio, Inc. <sup>6</sup>Map coverage available in the United States, Puerto Rico and Canada. <sup>7</sup>OnStar services require vehicle electrical system (including battery), wireless service and GPS satellite signals to be available and operating for features to function properly. OnStar acts as a link to existing emergency service providers. Not all vehicles may transmit all crash data. Subscription Service Agreement required. Call 1-888-4ONSTAR (466-7827) or visit onstar.com for OnStar's Terms and Conditions, Privacy Policy, details and system limitations.



### THE INDUSTRY'S BEST PICKUP COVERAGE

For 2015, Sierra HD comes with the Pro Grade Protection Plan, which includes 2-year/24,000-mile recommended scheduled maintenance,<sup>1</sup> including diesel exhaust fluid, 3-year/36,000-mile bumper-to-bumper limited warranty<sup>2</sup> and 5-year/100,000-mile powertrain limited warranty,<sup>2</sup> Roadside Assistance and Courtesy Transportation.

Starting with the owner orientation—and full tank of gas—you receive when you take possession of your Sierra HD to the **24-Hour Roadside Assistance, Courtesy Transportation and Travel Benefits**, you receive a portfolio of owner privileges that lasts throughout your warranty. For expert product information, Roadside Assistance or other services, call 1-800-GMC-8782.

**TRAVEL BENEFITS AND ROADSIDE ASSISTANCE** Available around the clock: trip routing service, a program for reimbursement for trip interruption due to necessary warranty repairs, towing, flat tire change, jump-starts and more for 5 years or 100,000 miles (whichever comes first).

**COURTESY TRANSPORTATION** Available at participating dealers: shuttle service, reimbursement of certain public transportation or fuel expenses for overnight warranty repairs and courtesy rental for overnight work repairs. See your dealer for details.

**GMC OWNER CENTER** A complimentary, one-stop resource to enhance your GMC ownership experience. It's easy to sign up. Just go to [gm.com/gmownercenter/gmc](http://gm.com/gmownercenter/gmc).

### ONSTAR



OnStar is a core asset of your Sierra HD. Benefiting from more than a decade of innovative development, it is both a highly advanced technology—fully integrated within the vehicle—and a warm human service. Standard on most Sierra HD models are 6 months of the OnStar Directions & Connections Plan, including the convenience of available Hands-Free Calling.<sup>3</sup> It also offers Automatic Crash Response, Stolen Vehicle Assistance, link to Emergency Services, Roadside Assistance, Remote Door Unlock, OnStar Vehicle Diagnostics, Crisis Assist and Remote Horn and Lights. OnStar services require vehicle electrical system (including battery), wireless service and GPS satellite signals to be available and operating for features to function properly. OnStar acts as a link to existing emergency service providers. Not all vehicles may transmit all crash data. Visit [onstar.com](http://onstar.com) for coverage maps, details and system limitations. Services vary with conditions.

### SIRIUSXM SATELLITE RADIO



SiriusXM Satellite Radio<sup>4</sup> is standard on most Sierra HD models. It includes 3 trial months of service. SiriusXM Satellite Radio makes your drive come alive with commercial-free music channels from virtually every genre, artist-dedicated channels, live performances and more. Tune in to live play-by-play from the biggest sports, exclusive entertainment from top personalities, compelling talk, hilarious comedy, world-class news, local traffic and weather and family-friendly programming. Welcome to the world of satellite radio. Visit [siriusxm.com](http://siriusxm.com) for details.

### GMC CERTIFIED SERVICE



**Certified Service** To help your Sierra HD live up to its performance promise, GMC Certified Service—found exclusively at your GMC dealer—is there. With all the engineering excellence in Sierra HD, GM-trained technicians have the expertise to care for all of it.

### ADDITIONAL NOTES

**A NOTE ON CHILD SAFETY** Always use safety belts and the correct child restraint for your child's age and size, even with air bags. Even in vehicles equipped with the Passenger Sensing System, children are safer when properly secured in a rear seat in the appropriate infant, child or booster seat. Never place a rear-facing infant restraint in the front seat of any vehicle equipped with an active frontal air bag. See your vehicle Owner's Manual and child safety seat instructions for more safety information.

**TRAILERING AND OFF-ROAD INFORMATION** Please carefully review the Owner's Manual for important safety information about trailering or off-road driving in your vehicle.

**IMPORTANT WORDS ABOUT THIS CATALOG** We have tried to make this catalog comprehensive and factual. We reserve the right, however, to make changes at any time, without notice, in prices, colors, materials, equipment, specifications, models and availability. Specifications, dimensions, measurements, ratings and other numbers in this catalog and other printed materials provided at the dealership or affixed to vehicles are approximates based upon design and engineering drawings and prototypes and laboratory tests. Your vehicle may differ due to variations in manufacture and equipment. Since some information may have been updated since the time of printing, please check with your GMC dealer for complete details. GMC reserves the right to lengthen or shorten the model year for any product for any reason, or to start and end model years at different times. All competitive claims are based on the latest information available at the time of printing and GM Large Pickup segment.

**FLEET ORDERS** Some standard content may be deleted with fleet orders. See dealer for details.

**ENGINES** GMC products are equipped with engines produced by GM Powertrain or other suppliers to GM worldwide. The engines in GMC products may also be used in other GM makes and models.

**GMC.COM** See more of Sierra HD on our Web site: [gmc.com](http://gmc.com). More photos and information; hot links to related subjects; convenient dealer locator; pricing guide, spec out your own vehicle. Or call 1-800-GMC-8782.

**AN IMPORTANT NOTE ABOUT ALTERATIONS AND WARRANTIES** Installations or alterations to the original equipment vehicle (or chassis) as distributed by General Motors are not covered by the General Motors New-Vehicle Limited Warranty. The special body company, assembler, equipment installer or upfitter is solely responsible for warranties on the body or equipment and any alterations (or any effect of the alterations) to any of the parts, components, systems or assemblies installed by GM. General Motors is not responsible for the safety or quality of design features, materials or workmanship of any alterations by such suppliers.

**NEW-VEHICLE LIMITED WARRANTY** All GMC Sierra HD models come with a fully transferable, no-deductible 5-year/100,000-mile (whichever comes first) Powertrain Limited Warranty. GM vehicles registered in the USA are also covered for 3 years or 36,000 miles (whichever comes first). Coverage includes tires and towing to your nearest GMC dealership. Repairs will be made to correct any vehicle defect and most warranty repairs will be made at no charge. In addition, rust-through corrosion will be covered for 6 years or 100,000 miles (whichever comes first). Sierra HD also comes with a 2-year/24,000-mile (whichever comes first) recommended maintenance schedule plan.<sup>1</sup> See dealer for details.

**ASSEMBLY** GMC vehicles and their components are assembled or produced by different operating units of General Motors, its subsidiaries or suppliers to GM worldwide. We sometimes find it necessary to produce GMC vehicles with different or differently sourced components than originally scheduled. Since some options may be unavailable when your vehicle is assembled, we suggest that you verify that your vehicle includes the equipment you ordered or, if there are changes, that they are acceptable to you.

**GMMOBILITY.COM** [1-800-323-9935] GM Mobility offers financial assistance for eligible adaptive equipment to make automotive travel easier for persons with disabilities or special transportation needs. To learn more about special GM Mobility offers, visit [gmmobility.com](http://gmmobility.com).

**GMCARDMEMBERSERVICES.COM** Did you know about the family of reward credit cards that can help you get a great deal on a new GM car, light-duty truck, SUV or crossover? With a GM reward card, you accrue earnings on every credit card purchase to use toward the purchase or lease of an eligible new GM vehicle. With three cards to choose from, you're sure to find one that suits you.

<sup>1</sup>Covers only scheduled oil changes with filter, four-wheel or single-rear-wheel tire rotations and 27-point inspections, according to your new vehicle's recommended maintenance schedule for up to 2 years or 24,000 miles, whichever comes first. Does not include air filters. Maximum of four service events. See participating dealer for other restrictions and complete details. <sup>2</sup>Whichever comes first. See dealer for limited warranty details. <sup>3</sup>Visit [onstar.com](http://onstar.com) for coverage map, details and system limitations. OnStar Hands-Free Calling requires existing OnStar service contract and prepaid minutes. Not available in certain markets. Calls can be made in U.S. and Canada only. <sup>4</sup>If you subscribe after your trial period, *subscriptions are continuous until you call SiriusXM to cancel*. See SiriusXM Customer Agreement for complete terms at [siriusxm.com](http://siriusxm.com). Other fees and taxes will apply. All fees and programming subject to change. For more information about NavTraffic, visit [siriusxm.com/navtraffic](http://siriusxm.com/navtraffic). XM satellite service is available only to those in the 48 contiguous USA and DC.

©2014 General Motors. All rights reserved. GM, the GM logo, GMC, the slogans, emblems, vehicle model names, vehicle body designs and other marks appearing in this catalog are the trademarks and/or service marks of General Motors, its subsidiaries, affiliates or licensors. Facebook is a registered trademark of Facebook, Inc. Twitter is a registered trademark of Twitter, Inc. YouTube is a registered trademark of Google, Inc. Sirius, XM and all related marks and logos are trademarks of SiriusXM Radio, Inc.





15GMSRARC

