



ACCESSES KEY

This locks and unlocks the locks on the vehicle and starts the engine.



REMOTE CONTROL Central unlocking



Press this button to unlock all of your vehicle's doors.

The direction indicators flash twice.

Central locking



Press this button to lock all of your vehicle's doors.

The direction indicators flash once.
If one of the doors is open or is not closed correctly, the central locking will not work.

Deadlocking

A second press on the closed padlock on the remote control within five seconds after locking changes the locking to deadlocking.

This is confirmed by fixed lighting of the direction indicators for approximately two seconds.

Deadlocking renders the exterior and interior door opening handles inoperative: do not leave anyone inside the vehicle when it is deadlocked.

If deadlocking is activated from inside the vehicle using the remote control, it will change to normal locking when the vehicle is started.

Folding/unfolding the key



Press this button to release the key from its housing.

To fold the key, press this chromed button then fold the key into the housing.

If you do not press the button, the mechanism may be damaged.

Good practice

Take care not to allow the remote control to come into contact with grease, dust, rain or a damp environment.

A heavy object attached to the key (keyring, ...) weighing on the shaft of the key in the switch, may cause a malfunction.

REMOTE CONTROL

Changing the battery

Battery ref.: CR1620/3 volts.

The information "battery flat" is given by an audible signal, accompanied by a message on the display.

To replace the battery, unclip the casing using a coin at the ring.

If the remote control does not work after the battery has been changed, re-programme the remote control.

There is a risk of damage if the replacement battery does not conform.

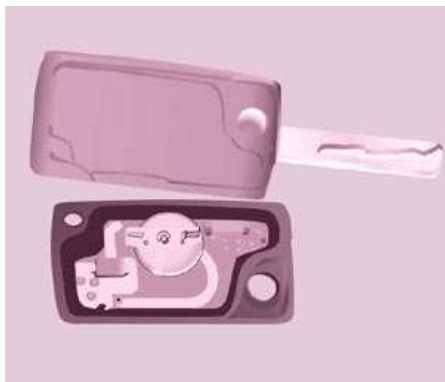

Programming the remote control

Following changing of the remote control battery or disconnection of the vehicle battery, the remote control may have to be reprogrammed.

Wait at least one minute before using the remote control.

Insert the key in the ignition switch with the buttons (padlocks) of the remote control facing you.

Switch on the ignition.

Press the locking padlock for at least five seconds within the next ten seconds.

Switch off the ignition.

Wait at least one minute before using the remote control.

The remote control is now working again.

Use only identical batteries or batteries of an equivalent type to those recommended by CITROËN dealers.

Do not discard the remote control batteries, they contain metals which are harmful to the environment.

Deposit them at a CITROËN dealership, or at any other approved collection point.

ELECTRONIC IMMOBILISER

All of the keys contain an electronic immobiliser device.

This device locks the engine supply system. It is activated automatically when the key is removed from the ignition.

After the ignition is switched on, a dialogue is established between the key and the electronic immobiliser system.

The metal part of the key must be unfolded correctly for correct dialogue to take place.

If you lose your keys

Visit a CITROËN dealer with the vehicle's V5 registration document and your identification document.

A CITROËN dealer will be able to retrieve the key code and the transponder code so that a replacement key can be ordered.

Good practice

Do not make any modifications to the electronic immobiliser system.

Operating the remote control, even when it is in your pocket, may result in involuntary unlocking of the doors.

The simultaneous use of other high frequency equipment (mobile telephones, domestic alarms...), may interfere with the operation of the remote control temporarily.

The remote control does not operate while the key is in the ignition, even if the ignition is off.

As a safety precaution (with children on board), remove the key from the ignition when leaving the vehicle, even for a short time.

When purchasing a second-hand vehicle:

- have the keys memorised by a CITROËN dealer to ensure that the keys in your possession are the only ones which can start the vehicle.



ALARM

If fitted on your vehicle, this provides two types of protection:

- exterior protection: it sounds if a front/rear door or the bonnet is opened.
- interior protection: it sounds if the volume inside the passenger compartment changes (breaking of a window or a movement inside the vehicle).

If your vehicle is fitted with a separation partition, the interior protection is not active in the load space.

Locking the vehicle with complete alarm

Setting the alarm

- Switch off the ignition and get out of the vehicle.
- Set the alarm within five minutes of getting out of the vehicle, by locking or deadlocking using the remote control. The red diode, located on the button, flashes once per second.

Disarming

- Unlock the vehicle with the remote control or switch on the ignition, the red diode goes out.

Locking the vehicle with exterior protection only

If, while you are away from the vehicle, you wish to leave a window partially open or a pet inside the vehicle, you should choose exterior protection only.

- Switch off the ignition.



- In the next ten seconds, press the button until the red diode is on continuously.
- Get out of the vehicle.
- Within the next five minutes, set the alarm by locking or deadlocking using the remote control (the red diode flashes once a second).

Triggering

The siren sounds, the direction indicators flash for approximately 30 seconds and the red diode flashes rapidly.

- To switch it off, insert the key and switch on the ignition.

When the alarm has been triggered ten times in succession (when triggered for the eleventh time) it is deactivated. Repeat the rules for setting the alarm.

Locking the vehicle without alarm

- Insert the key in the lock on the driver's door and lock it.

Do not set the alarm when washing your vehicle.

Failure of the remote control

When the alarm is set but the remote control does not operate:

- Unlock the doors with the key and open the door. The alarm is triggered.
- Switch on the ignition in the next ten seconds. The alarm is disarmed.

Incorrect operation

When the ignition is switched on, if the red diode remains on for ten seconds, there is a fault in the siren connection. Contact a CITROËN dealer to have the system checked.

Automatic setting of the alarm

Depending on the country in which the vehicle is sold, the alarm is set automatically approximately 2 minutes after the last door is closed.

To prevent triggering of the alarm when a door is opened, it is imperative to press the remote control unlocking button again.



Do not make any modifications to the alarm system as this could cause faults.



FRONT DOORS

From the outside

Use the remote control to lock/unlock the vehicle.

Insert the metal part of the key in the lock on the driver's side if the remote control does not work.



From the inside

Use the door opening control to unlock and open the door concerned.



SLIDING SIDE DOORS

From the outside

Pull the handle towards you then towards the rear and open the side door guiding the rearward sliding to beyond the point of resistance to hold it open.

A mechanical system prevents opening of the left-hand side door when the fuel filler flap is open.



From the inside

Unlock the side door using this handle and open it, guiding the rearward sliding to the point of resistance. Pass this point to hold the door open.

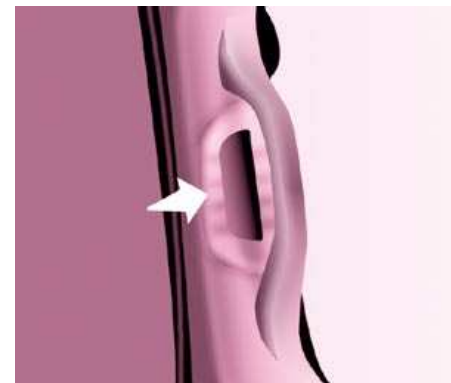

Close the side door using the handle to start the sliding and pass the point of resistance. Then, use the shaped recess at the top of the door pillar to guide the door until it locks.

Do not use the grab handle to slide the door.



Good practice

Take care not to block the guide space on the floor to allow the door to slide correctly.

If your vehicle is parked on a slope, guide the sliding of the side door. In fact, the door could open or close more rapidly due to the slope of the ground and could cause injury.

For safety and operation reasons, do not drive with the sliding side doors open.

TAILGATE

From outside

Locking/unlocking is by means of the remote control.

To open, press the control below the trim then raise the tailgate.

A pull strap is available to close the tailgate in the high position.

Guide the closing of the tailgate to the balance point of its travel then apply a final press on the tailgate to close it fully.

From inside

Emergency control

In the event of a central unlocking operating fault, this permits unlocking of the tailgate from the inside.

Insert a small screwdriver in the opening, between the door and the floor. To unlock the lock, move the catch to the left then push the tailgate.



Tailgate screen

The opening rear screen allows you to access the rear of the vehicle directly, without having to open the tailgate.

Opening

After unlocking the vehicle using the remote control or the key, press the control and raise the rear screen to open it.

Closing

Close the rear screen by pressing the centre of the glass until it is fully closed.

The tailgate and tailgate screen cannot both be open at the same time, to prevent damage to the glass and the screen itself.



HINGED REAR DOORS

The hinged rear doors are asymmetrical (2/3 - 1/3), with the smaller door on the right. They are fitted with a central lock.

From outside

To open, pull the handle towards you.



Pull the lever to open the right-hand door.

To close, start with the right-hand door then close the left-hand door.

With the roof rear flap, the rear bumper has been strengthened to serve as a footrest on accessing the vehicle.



Practice

It is possible to drive with the right-hand door open to make the transportation of long loads easier. The left-hand door is kept closed by the distinctive "yellow" lock, positioned at the base of the door. This closed door must not be used as a load retainer.

Driving with the right-hand door open is a special dispensation. Comply with the usual safety indications to attract the attention of other drivers.



Opening to approximately 180°

A check strap system permits extension of the opening from approximately 90° to approximately 180°.

Pull the yellow control when the door is open.

The check strap will re-attach automatically on closing.



From inside

Pull the handle towards you to open the left-hand door.



REAR ROOF FLAP

This rear roof flap is only compatible with the hinged doors.

To open the rear roof flap:

- raise the black paddle of the toggle,
- relieve the toggle by pressing the rear roof flap (downwards) then release the hook,
- lift the rear roof flap,
- pass the point of resistance to secure the rear roof flap using the support struts.

To close the rear roof flap:

- check that the support bar is secured correctly,
- lower the rear roof flap,
- while pressing the rear roof flap (downwards), take hold of the two loops of the spring then place the hook in its housing,



- lower the black paddle to secure the rear roof flap.

Securing the rear roof flap places it on the seal correctly and guarantees sealing without noise.

Support bar

A support bar is provided for transporting long loads, after opening the rear roof flap.

Fold back the support bar by lifting the lever.

Support it to the door pillar.

Support the long loads to be transported, lift them and reposition the support bar with one hand.

Ensure that it is secured correctly by pressing the handle downwards past the point of resistance and secure the loads firmly.

The side supports can be used as hooking points.

i The rear bumper has been strengthened to serve as a footrest on entering the vehicle.

Never drive without the support bar in place.

i The rear doors only lock when the support bar is installed.

When the rear roof flap is open, take care when driving where height is restricted.

Never rest loads directly on the rear doors.

Comply with the usual indications, to attract the attention of other drivers.



CENTRAL LOCKING



An initial press permits central locking of the vehicle, when all of the doors are closed.

A second press permits central unlocking of the vehicle.

The control is inactive when the vehicle has been locked using the remote control or the key from the outside.

The doors can still be opened from the inside.

The control diode:

- flashes when the doors are locked with the vehicle stationary and the engine off,
- comes on when the doors are locked and from the time the ignition is switched on.

Protection against attack

Locking while driving

When the vehicle moves off, as soon as you reach approximately 6 mph (10 km/h), the system locks the doors. A noise characteristic of central locking is heard. The diode on the control on the fascia central control panel comes on.

During the journey, opening a door results in complete unlocking of the vehicle.

In the event of a serious impact, the doors are unlocked automatically to permit access by the emergency services.

Activating/deactivating the function



With the ignition on, press and hold this button to activate or deactivate the function.

Door open warning light



If this warning light comes on, check that all of your vehicle's doors are closed correctly.



INSTRUMENTS AND CONTROLS

INSTRUMENT PANEL

Dials

1. Distance recorder in kilometres/miles.
2. Display.
3. Fuel level, coolant temperature.
4. Rev counter.
5. Trip distance recorder/service indicator zero reset.
6. Instrument panel lighting rheostat.



Displays

- Speed limiter/cruise control.
- Kilometres/Miles travelled.
- Service indicator, engine oil level indicator, total kilometres/miles.
- Presence of water in the diesel filter.
- Diesel pre-heating.

Screens

The information is presented on board the vehicle in different display formats according to the vehicle's equipment.



Instrument panel without display

ADJUSTING THE TIME

Centre console without display



To adjust the time of the clock, use the left-hand button on the instrument panel then carry out the operations in the following order:

- turn to the left: the minutes flash,
- turn to the right to increase the minutes (hold the button to the right for rapid scrolling),
- turn to the left: the hours flash,

- turn to the right to increase the hours (hold the button to the right for rapid scrolling),
- turn to the left: 24 H or 12 H is displayed,
- turn to the right to select 24 H or 12 H,
- turn to the left to complete the time adjustment.

After approximately 30 seconds without any action, the display returns to the normal display.



Centre console with display





The display - time sequence is linked according to model (version). The access to the "Date" adjustment is only active when the model version offers a date in words.











To adjust the time and date indicated on the display, refer to the "Adjusting the date and time" section of chapter 9.

WARNING LAMPS

Each time the vehicle is started: a series of warning lamps comes on applying a self-test check. They switch off almost immediately. When the engine is running: the warning lamp becomes a warning if it remains on continuously or flashes. This initial warning may be accompanied by an audible signal and a message which appears on the display. Do not ignore these warnings.





Warning lamp		is	indicates	Solution - action
	STOP	lit, associated with another warning lamp and accompanied by a message on the display.	major faults linked with the "Brake fluid level", "Engine oil pressure and temperature", "Coolant temperature", "Electronic brake force distribution" and "Power steering" warning lights.	You must stop, park and switch off the ignition. Have the fault checked by a CITROËN dealer.
	Handbrake/ Brake fluid level/EBFD	lit.	that the handbrake is applied or has not been released fully.	Releasing the handbrake switches off the warning lamp.
		lit.	a low brake fluid level.	Top up using a fluid recommended by CITROËN.
		remaining on even though the level is correct and associated with the ABS warning lamp.	a failure of the electronic brake force distribution.	You must stop, park and switch off the ignition. Have the fault checked by a CITROËN dealer.
	Engine oil pressure and temperature	lit while driving.	insufficient pressure or a high temperature.	Park and switch off the ignition then allow to cool. Visually check the level. Chapter 6, "Levels" section.
		remaining on, even though the level is correct.	a major fault.	Have the fault checked by a CITROËN dealer.







Warning lamp		is	indicates	Solution - action
	Coolant temperature and level	lit with needle in the red zone.	an abnormal increase in temperature.	Park and switch off the ignition then allow to cool. Visually check the level.
		flashing.	a drop in the coolant level.	Chapter 6, "Levels" section. Consult a CITROËN dealer.
	Service	lit temporarily.	minor faults or warnings.	Consult the warnings log on the display or on the screen. If your vehicle is equipped with a trip computer or a screen: refer to the "Audio equipment - Trip computer" section of chapter 9. Consult a CITROËN dealer.
		remaining on.	major faults.	
	Driver's seat belt not fastened	lit then flashing.	the driver has not fastened his seat belt.	Pull the strap then insert the tongue in the buckle.
		accompanied by an audible signal then remains on.	the vehicle is moving with the driver's seat belt not fastened.	Check that the seat belt is fastened by pulling the strap. Chapter 4, "Seat belts" section.

Warning lamp		is	indicates	Solution - action
	Front/side air bag	flashing or remaining on.	a failure of an air bag.	Have the system checked by a CITROËN dealer without delay. Chapter 4, "Air bags" section.
	Front passenger air bag disarmed	lit.	the intentional disarming of this air bag in the presence of a rear-facing child seat.	Chapter 4, "Air bags-child safety" section.
	Low fuel level	lit with gauge needle in the red zone.	that the fuel reserve is being used.	Fill up with fuel without delay. The evaluation of the fuel reserve is a parameter which is sensitive to the style of driving, the profile of the road, the time elapsed and the distance travelled from the time the warning lamp comes on.
		flashing.	cutting off of the supply following a serious impact.	Restore the supply. Chapter 6, "Fuel" section.
	EOBD emission control system	flashing or remaining on.	a failure of the system.	There is a risk of damage to the catalytic converter. Have the system checked by a CITROËN dealer.
	Battery charge	lit.	a fault in the charging circuit.	Check the battery terminals, ... Chapter 7, "Battery" section.
		flashing.	placing of the active functions on standby (economy mode).	Chapter 7, "Battery" section.
		remaining on, in spite of the checks.	a faulty circuit, an ignition or injection malfunction.	Have the fault checked by a CITROËN dealer.







Instruments and controls

32

Warning lamp		is	indicates	Solution - action
	Power steering	lit.	a malfunction of the system.	The vehicle retains conventional steering without assistance. Have the system checked by a CITROËN dealer.
	Door open detection	lit and accompanied by a message on the display.	that a door is not closed correctly.	Check that all of the doors are closed.
	ABS	remaining on.	a failure of the anti-lock braking system.	The vehicle retains conventional braking. Consult a CITROËN dealer.
	ESP	flashing.	triggering of the ASR or ESP regulation.	The system optimises drive and permits improvement of the directional stability of the vehicle. Chapter 4, "Driving safety" section.
		remaining on.	a malfunction of the system. E.g.: under-inflation of the tyres.	E.g.: check the pressure of the tyres. Have the system checked by a CITROËN dealer. (Wheel speed sensor, hydraulic block, ...).
		remaining on with the diode on the button (on the fascia) lit.	deactivation of the system at the request of the driver.	Operation of the system is deactivated. Reactivation is automatic above 30 mph (50 km/h) or after pressing the button (on the fascia).

Warning lamp	is	indicates	Solution - action	
	Particle emission filter	lit.	a malfunction of the particle emission filter (diesel additive level, risk of clogging, ...).	Have the filter checked by a CITROËN dealer. Chapter 6, "Levels" section.
	Dipped headlamps/Daytime lights	lit.	a manual selection or automatic lighting.	Turn the ring on the lights stalk to the second position.
	Main beam headlamps		lighting of the dipped headlamps from the time the ignition is switched on: daytime lights (depending on the country in which the vehicle is sold).	Chapter 3, "Steering wheel controls" section.
	Direction indicators		flashing with buzzer.	pulling of the stalk towards you.
	Front fog lamps	lit.	a change of direction via the lights stalk, to the left of the steering wheel.	To the Right: control to be pushed upwards. To the Left: control to be pushed downwards.
	Rear fog lamps	lit.	a manual selection.	The fog lamps only operate if the side lights or dipped headlamps are on.
	Rear fog lamps	lit.	a manual selection.	The fog lamps only operate if the side lights or dipped headlamps are on. In conditions of normal visibility, take care to switch them off to avoid breaking the law. "This light is a dazzling red."

Instruments and controls

Warning lamp on the display		is	indicates	Solution - action
	Cruise control	lit.	cruise control selected.	Manual selection. Chapter 3, "Steering wheel controls" section.
	Speed limiter	lit.	speed limiter selected.	Manual selection. Chapter 3, "Steering wheel controls" section.
	Diesel pre-heating	lit.	climatic conditions requiring pre-heating.	Wait until the warning light is switched off before operating the starter.
	Presence of water in the diesel filter	lit and accompanied by a message on the display.	water in the diesel filter.	Have the filter bled by a CITROËN dealer without delay. Chapter 6, "Checks" section. According to country.
	Service spanner	lit.	that a service will be due shortly.	Refer to the list of checks in the Maintenance and Warranty Guide. Have the service carried out by a CITROËN dealer.
	Time	flashing.	adjustment of the time.	Use the left-hand button on the instrument panel. Chapter 2, at the beginning of the "Instruments and controls" section.



FUEL GAUGE

The fuel level is tested each time the key is turned to the "running" position.

The gauge is positioned on:

- **1**: the fuel tank is full, approximately 60 litres.
- **0**: the reserve is now being used, the warning light comes on continuously. The reserve when the warning first comes on is approximately 8 litres.

 Refer to the "Fuel" section of chapter 6.



COOLANT TEMPERATURE

The needle is positioned before the red zone: normal operation.

In arduous conditions of use or hot climatic conditions, the needle may move close to the red graduations.

What you should do if the needle enters the red zone:

Reduce your speed or let the engine run at idle.

What you should do if the warning light comes on:

- stop immediately, switch off the ignition. The fan may continue to operate for a certain time up to approximately 10 minutes,
- wait for the engine to cool down in order to check the coolant level and top it up if necessary.

As the cooling system is pressurised, follow this advice in order to avoid any risk of scalding:

- wait at least one hour after switching off the engine before carrying out any work,
- unscrew the cap by 1/4 turn to allow the pressure to drop,
- when the pressure has dropped, check the level on the expansion bottle,
- if necessary, remove the cap to top up.

If the needle remains in the red zone, have the system checked by a CITROËN dealer.

 Refer to the "Levels" section of chapter 6.

EMISSION CONTROL



EOBD (European On Board Diagnosis) is a diagnostics system which complies with, among others, the standards concerning authorised emissions of:

- CO (carbon monoxide),
- HC (unburnt hydrocarbons),
- NOx (nitrogen oxides) or particles, detected by oxygen sensors placed upstream and downstream of the catalytic converters.

Therefore, the driver is warned of any malfunction of this emission control system by the lighting of this specific warning light on the instrument panel.

There is a risk of damage to the catalytic converter. Have it checked by a CITROËN dealer.

TYRE UNDER-INFLATION DETECTION

Sensors check the tyre pressure during driving (speed higher than 12 mph [20 km/h]) and trigger a warning in the event of a malfunction or puncture.



Any anomaly detected (flat or punctured tyre, malfunction of a sensor) is indicated by visual and audible information and is accompanied by a message on the display.

Flat tyre

Check the tyre pressure as soon as possible.

Puncture

Stop immediately, avoiding any sudden movement of the steering wheel and the brakes.

Change the damaged (punctured or very deflated) tyre, and have the tyre pressure checked as soon as possible.



Refer to the "Changing a wheel" section of chapter 7.

If the damaged tyre is temporarily stored inside the vehicle, it will again emit this message to remind you of the necessity of having it repaired. This will prevent another warning of the same type being displayed.

Sensor(s) not detected

Under-inflation detection is absent from one (or several) tyre(s). Contact a CITROËN dealer to replace the faulty sensor(s).

This message is also displayed when one of the tyres is away from the vehicle (being repaired) or when a wheel without a sensor is fitted.

All repairs and changing of tyres on a wheel fitted with this system must be carried out by a CITROËN dealer.

The tyre under-inflation detection system is a driving aid which does not take the place of vigilance or the responsibility of the driver.

This system does not remove the need to have the tyre pressure checked regularly (including the spare wheel), to ensure that the dynamic performance of the vehicle remains at its best and to avoid premature wear of the tyres, in particular in the case of arduous driving (heavy load, high speed).

The system may temporarily be disturbed by radio broadcasts on a frequency close to it.

SERVICE INDICATOR

This programme's service intervals according to the use of the vehicle.

Operation

A few moments after the ignition has been switched on, the spanner indicating a service operation lights up; the display for the total distance recorder tells you (in round figures) the distance remaining before the next service.

The points at which a service is due are calculated from the last indicator zero reset.

The point at which a service is due is determined by two parameters:

- the distance travelled,
- the time which has elapsed since the last service.

i The distance remaining before the next service may be weighted by the time factor, depending on the driver's driving habits.

More than 1 000 miles/km before the next service is due

Example: 4 800 miles/km remain before the next service is due. When the ignition is switched on and for a few seconds, the display shows:



A few seconds after the ignition is switched on, the oil level is displayed, then the total distance recorder resumes normal operation showing the total and trip distances.

Less than 1 000 miles/km before the next service is due

Each time the ignition is switched on and for a few seconds, the spanner flashes and the number of miles/kilometres remaining is displayed:



A few seconds after the ignition is switched on, the oil level is displayed, then the total distance recorder resumes normal operation and the spanner remains lit. This indicates that a service should be carried out shortly.

Service overdue



Each time the ignition is switched on and for a few seconds, the spanner flashes and the excess distance is displayed.

i With the engine running the spanner remains lit until the service has been carried out.

First of the two terms reached: the spanner also lights up if the two-year interval has elapsed.

Zero re-set

Your CITROËN dealer carries out this operation after each service.

However, if you carry out the service yourself, the re-set procedure is as follows:

- switch off the ignition,
- press and hold the trip recorder reset button,
- switch on the ignition.

The display begins a countdown.

When the display shows "**=0**", release the button; the spanner disappears.

 After this operation, if you wish to disconnect the battery, lock the vehicle and wait for at least five minutes, otherwise the zero re-set will not be registered.

Engine oil level indicator

When the ignition is switched on, the engine oil level is indicated for a few seconds, after the service information.



Oil level correct



Lack of oil

Flashing of "**OIL**", linked with the service warning light, accompanied by an

audible signal and a message on the display, indicates a lack of oil which could damage the engine.

If the lack of oil is confirmed by a check using the dipstick, it is essential that the level is topped up.



Oil level gauge fault

Flashing of "**OIL --**" indicates a malfunction of the engine oil level gauge.

Consult a CITROËN dealer.



The level read will only be correct if the vehicle is on level ground and the engine has been off for more than 15 minutes.



Dipstick

A = maximum, never exceed this level as a surplus of oil may damage the engine.

Contact a CITROËN dealer without delay.

B = minimum, top up the level via the oil filler cap, using the type of oil suited to your engine.

Trip recorder zero reset button



With the ignition on, press the button until the zeros appear.

Lighting rheostat



With the lights on, press the button to vary the intensity of the lighting of the instruments and controls. When the lighting reaches the minimum (or maximum) setting, release

the button then press it again to increase (or reduce) the brightness.

As soon as the lighting is of the required brightness, release the button.



5-speed - reverse gear gearbox

GEARBOX

To change gear easily, always press the clutch pedal fully.

To prevent the mat from becoming caught under the pedal:

- ensure that the mat and its fixings on the floor are positioned correctly,
- never fit one mat on top of another.

When driving, avoid leaving your hand on the gear knob as the force exerted, even if slight, may wear the internal components of the gearbox over time.

To engage reverse gear, wait until the vehicle is stationary then push the gear lever to the right then down.

The lever should be moved slowly to reduce the noise on engaging reverse gear.



STEERING WHEEL ADJUSTMENT

When the vehicle is stationary, unlock the steering wheel by pulling the lever.

Adjust the height and depth of the steering wheel, then lock by pushing the lever fully.

Starting and stopping

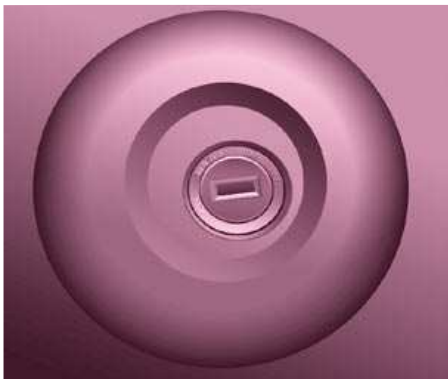

STARTING AND STOPPING

Running and accessories position.

To unlock the steering, turn the steering wheel gently while turning the key, without forcing. In this position, certain accessories can be used.

Starting position.

The starter is operated, the engine turns over, release the key.

STOP position: steering lock.

The ignition is off. Turn the steering wheel until the steering locks. Remove the key.

Good practice when starting



Door or bonnet open warning light

If this comes on, a door or the bonnet is not closed correctly, check!



Diesel pre-heating warning light

If the temperature is high enough, the warning light comes on for less than one second, you can start without waiting.

In cold weather, wait for this warning light to switch off then operate the starter (Starting position) until the engine starts.

Good practice when stopping

Minimise engine and gearbox wear

When switching off the ignition, let the engine run for a few seconds to allow the turbocharger (Diesel engine) to return to idle.

Do not press the accelerator when switching off the ignition.

There is no need to engage a gear after parking the vehicle.

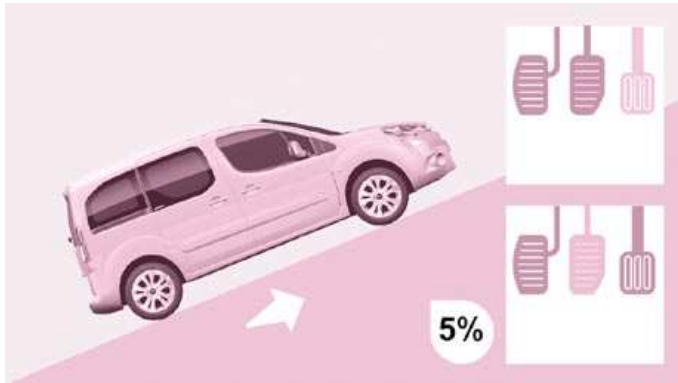

HILL START ASSISTANCE

This function, linked with the ESP, makes hill starts easier and is activated in the following conditions:

- the vehicle must be stationary, engine running, foot on the brake,
- the gradient of the road must be steeper than 5 %,
- uphill, the gearbox must be in neutral or in a gear other than reverse,
- downhill, reverse gear must be engaged.

The HHC (Hill Holder Control) or Hill Start Assistance function is a driving comfort feature. It is not an automatic vehicle parking function or an automatic handbrake.

Operation

With the brake pedal and clutch pedal pressed, from the time you release the brake pedal you have approximately 2 seconds before the vehicle starts to roll back and without using the handbrake within which to move off.

During the moving off phase, the function is deactivated automatically, gradually releasing the braking pressure. During this phase, the typical noise of mechanical disengaging of the brakes can be heard, indicating the imminent movement of the vehicle.

The hill start assistance is deactivated in the following situations:

- when the clutch pedal is released,
- when the handbrake is applied,
- when the engine is switched off,
- when the engine stalls.

Anomaly



If a malfunction of the system occurs, this warning light comes on accompanied by an audible signal and confirmed by a message on the display. Contact a CITROËN dealer to have the system checked.

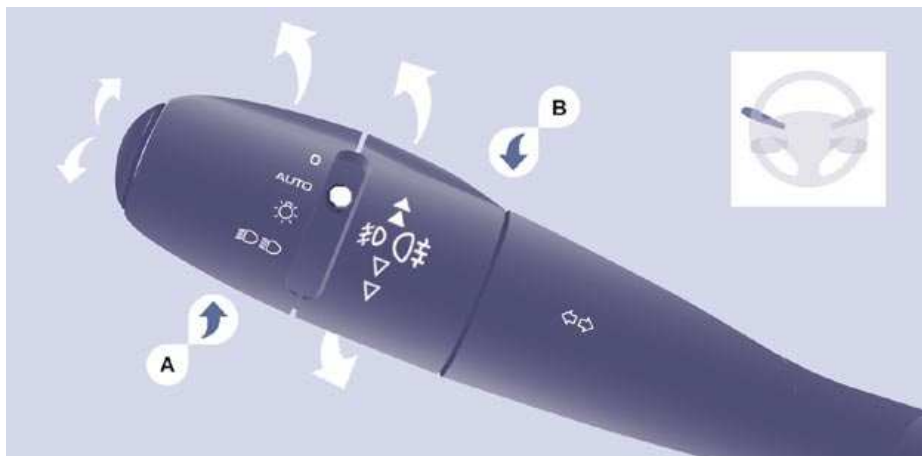

DIRECTION INDICATORS (green flashing)



Left: downwards passing the point of resistance.
Right: upwards passing the point of resistance.

"Motorway" function

Press the control up or down to flash the corresponding direction indicator three times.

LIGHTING CONTROL

Front and rear lights

Selection is by turning ring A.

 Checking by means of the indicator lights on the instrument panel is described in the "Instruments and controls" section of chapter 2.



Lights off



Automatic lights



Side lights



Dipped beam (green)
Main beam (blue)

Dipped beam/main beam change

Pull the stalk fully towards you.

Lights-on buzzer

When the ignition is switched off, when the driver's door is opened, a buzzer sounds if you have left your lights on.

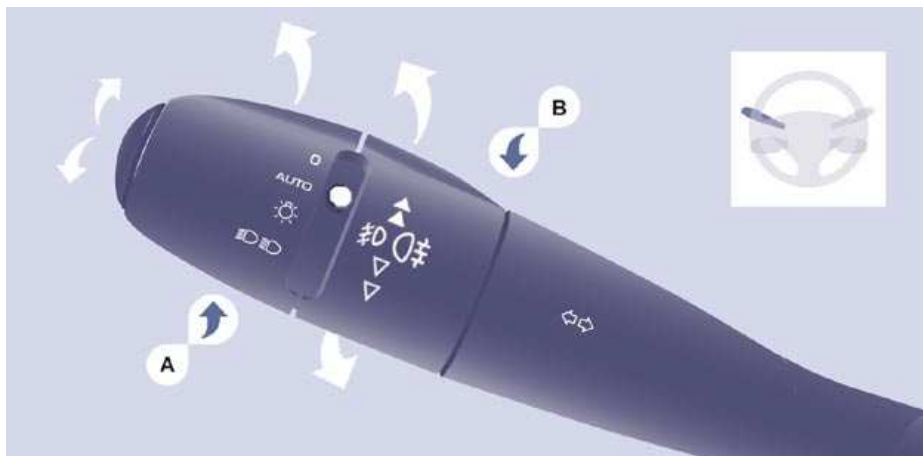

DIRECTION INDICATORS (green flashing)



Left: downwards passing the point of resistance.
Right: upwards passing the point of resistance.

"Motorway" function

Press the control up or down to flash the corresponding direction indicator three times.

LIGHTING CONTROL

Front and rear lights

Selection is by turning ring **A**.

 Checking by means of the indicator lights on the instrument panel is described in the "Instruments and controls" section of chapter 2.



Lights off



Automatic lights



Side lights



Dipped beam (green)
Main beam (blue)

Dipped beam/main beam change

Pull the stalk fully towards you.

Lights-on buzzer

When the ignition is switched off, when the driver's door is opened, a buzzer sounds if you have left your lights on.

Front and rear fog lamps

Rotate ring **B** forwards to switch on and rearwards to switch off. The status is confirmed by the light on the instrument panel.

These operate with the side lights and the dipped beam headlamps.



Front fog lamps (green, 1st rotation of the ring forwards).



Rear fog lamps (amber, 2nd rotation of the ring forwards).

To switch off the front and rear fog lamps, turn the ring rearwards twice in succession.

In clear weather or in rain, both day and night, rear fog lamps dazzle and are prohibited.

i Do not forget to switch them off when they are no longer needed.

Automatic switching on of the lights switches off the rear fog lamps, but the front fog lamps remain on.

Daytime lights

Depending on the country in which the vehicle is sold, the vehicle may be equipped with daytime lights. The dipped headlamps come on when the vehicle is started.



This warning light comes on on the instrument panel.

i The instruments and controls (instrument panel, display, air conditioning control panel, ...) are only lit on switching to the automatic switching on of the lights mode or when the lights are switched on manually.

Automatic switching on of the lights



The side lights and dipped beam headlamps switch on automatically if the light is poor, or during operation of the windscreen wipers. They switch off as soon as the light becomes bright enough or the windscreen wipers stop.

This function is not compatible with the daytime lights.

i In foggy weather or in snow, the brightness sensor can detect sufficient light. As a consequence, the lights will not come on automatically.

👁 If necessary, you must switch on the dipped headlamps manually.

Do not cover the brightness sensor located on the windscreen, behind the mirror. It is used for the automatic switching on of the lights and for the automatic wipers.

Activation

Turn the ring to the **AUTO** position. The activation of this function is accompanied by a message on the display.

Deactivation

Turn the ring forwards or rearwards. The deactivation of this function is accompanied by a message on the display.

The function is deactivated temporarily when you use the manual lights stalk.

Steering wheel controls



If the brightness sensor does not function correctly, the lights come on accompanied by the service warning light, an audible signal and a message on the display.

Consult a CITROËN dealer.

Guide-me-home lighting

The temporary maintaining of the dipped headlamps lighting, with the ignition off, makes the driver's exit easier when the light is poor.

Manual operation

- With the ignition off, "flash" the headlamps within one minute after switching off the ignition.

The guide-me-home lighting switches off automatically after a set time.

Automatic operation



Activate the function via the "Vehicle config" menu.

+ Refer to the "Display flow chart" section of chapter 9.



HEADLAMP BEAM

Depending on the load in your vehicle, the beam setting must be adjusted.

- 0** - No load.
- 1** - Partial load.
- 2** - Average load.
- 3** - Maximum authorised load.

Initial setting is position 0.

Steering wheel controls



If the brightness sensor does not function correctly, the lights come on accompanied by the service warning light, an audible signal and a message on the display.

Consult a CITROËN dealer.

Guide-me-home lighting

The temporary maintaining of the dipped headlamps lighting, with the ignition off, makes the driver's exit easier when the light is poor.

Manual operation

- With the ignition off, "flash" the headlamps within one minute after switching off the ignition.

The guide-me-home lighting switches off automatically after a set time.

Automatic operation



Activate the function via the "Vehicle config" menu.

 Refer to the "Display flow chart" section of chapter 9.



HEADLAMP BEAM

Depending on the load in your vehicle, the beam setting must be adjusted.

- 0** - No load.
- 1** - Partial load.
- 2** - Average load.
- 3** - Maximum authorised load.

Initial setting is position 0.

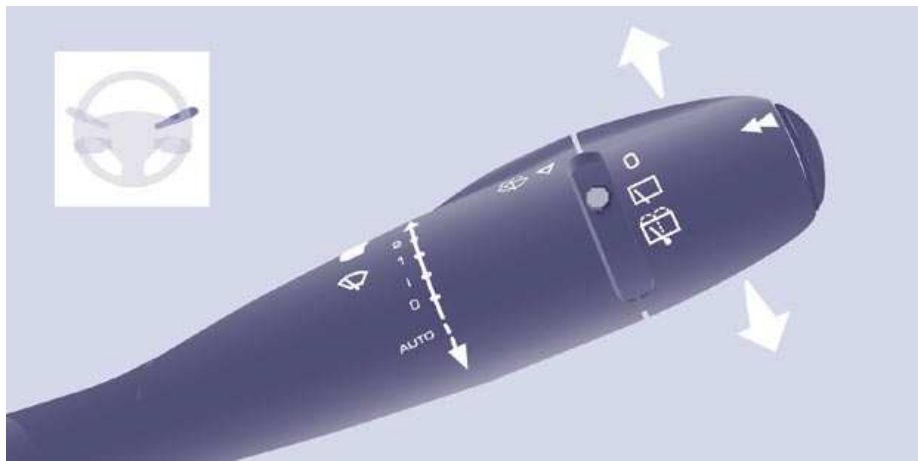

WINDSCREEN WIPER STALK

Manual windscreen wipers

- 2 Fast wipe (heavy rain).
- 1 Normal wipe (moderate rain).
- I Intermittent wipe.
- 0 Off.
- ↓ Single wipe (press downwards).

In the Intermittent position, the wiping speed is in proportion to the vehicle speed.

Whenever the ignition has been switched off for more than one minute, with the windscreen wiper stalk in position 2, 1 or I, the stalk must be reactivated:

- move the stalk to any position,
- then move it back to the required position.

Automatic windscreen wipers



Do not cover the rain sensor, located in the centre of the windscreen, behind the mirror.

In the **AUTO** position, the windscreen wipers operate automatically and adapt their speed to the intensity of the rainfall. When not in **AUTO** mode, for the other positions, refer to the manual windscreen wipers section.

Activation

Press the control downwards. Activation of the function is accompanied by a message on the display.

The automatic windscreen wipers function must be reactivated if the ignition has been switched off for more than one minute, by pressing the stalk downwards.

Deactivation/Switching off

Place the windscreen wipers stalk in position I, 1 or 2. Deactivation of the function is accompanied by a message on the display.

In the event of malfunction of the automatic windscreen wipers, the windscreen wipers will operate in intermittent mode.

Contact a CITROËN dealer to have the system checked.



When using an automatic car wash, switch off the ignition to avoid triggering of the automatic wiping.

In winter, it is advisable to wait for the windscreen to completely clear of ice before operating the automatic wipe.

Steering wheel controls

Wash-wipe and headlamp wash

Pull the stalk towards you, the wash-wipe is accompanied by a timed sweep of the wipers.

The headlamp wash is linked with the wash-wipe, it is triggered if the dipped headlamps are on.

 To top up the levels, refer to the "Levels" section of chapter 6.

Special position of the windscreen wipers

In the minute following switching off of the ignition, any action on the stalk positions the wipers against the windscreen uprights.

This action enables you to position the wiper blades for winter parking, cleaning or replacement.

 Refer to the "Changing a windscreen wiper blade" section of chapter 7.

To park the wipers in their normal position after this has been done, switch on the ignition and move the stalk.

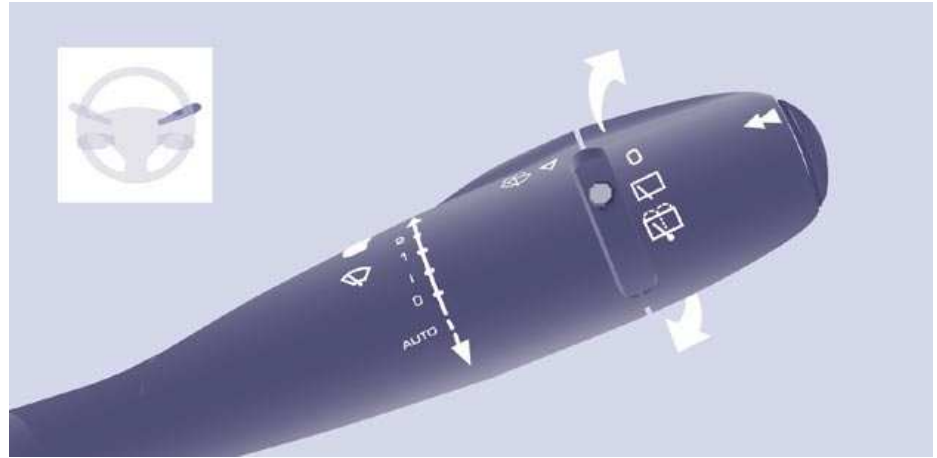

Rear windscreen wiper



Turn the ring to the first notch.

Rear windscreen wash



Turn the ring past the first notch: the windscreen wash then the windscreen wiper operate for a fixed time.

 In winter, in the event of a considerable amount of snow or ice, switch on the rear screen demister. Once de-icing is complete, remove the snow or ice which has accumulated on the rear wiper blade. You can then operate the rear windscreen wiper.



CRUISE CONTROL "CRUISE"

"This is the speed at which the driver wishes to drive".

This aid to driving in free-flowing traffic enables the vehicle to maintain the speed programmed by the driver, unless a steep gradient makes this impossible.

In order for it to be programmed or activated, the vehicle speed must be greater than 25 mph (40 km/h) with at least 4th gear engaged.

This cruise control shows the function selection status on the instrument panel and displays the programmed speed:

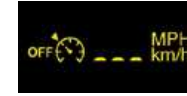

Function selected, displaying of the "Cruise Control" symbol.



Function deactivated, **OFF** (example at 65 mph (107 km/h)).



Function activated (example at 65 mph (107 km/h)).



Vehicle speed above (e.g. 70 mph (118 km/h)), the programmed speed is displayed flashing.



Operating fault detected, **OFF** - the dashes flash.

Steering wheel controls



Selecting the function

- Place the switch in the **CRUISE** position. The cruise control is selected but is not yet active and no speed has been programmed.



Temporary exceeding of the speed

It is possible to **accelerate** and drive momentarily at a speed greater than the programmed speed. The value programmed flashes.

When the accelerator pedal is released, the vehicle will return to the programmed speed.



Reactivation

- Following deactivation of the cruise control, press this button. Your vehicle will return to the last programmed speed. Alternatively, you can repeat the "first activation" procedure.



First activation/ programming a speed

- Reach the chosen speed by pressing the accelerator.
- Press the **SET -** or **SET +** button.

This programmes/activates the reference speed and the vehicle will maintain this speed.

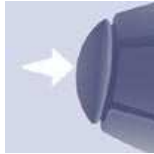

Deactivation (off)

- Press this button or the brake or clutch pedal.

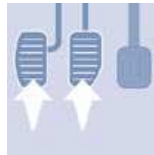



Changing the programmed speed

There are two methods of memorising a speed higher than the previous one:

Without using the accelerator:

- press the **Set +** button.

A brief press increases the speed by 1 mph (km/h).

A maintained press increases the speed in steps of 5 mph (km/h).

Using the accelerator:

- exceed the memorised speed until the speed required is reached,
- press the **Set +** or **Set -** button.

To memorise a speed lower than the previous one:

- press the **Set -** button.

A brief press decreases the speed by 1 mph (km/h).

A maintained press decreases the speed in steps of 5 mph (km/h).



Switching the function off

- Place the dial in position **0** or switch off the ignition to switch everything off.

Cancelling the programmed reference speed

When the vehicle becomes stationary, after switching off the ignition, the system no longer memorises a speed.



Operating fault

The programmed speed is cleared then replaced by three dashes. Contact a CITROËN dealer to have the system checked.

Good practice

When changing the programmed reference speed by means of a maintained press, pay attention as the speed can increase or decrease rapidly.

Do not use the cruise control on slippery roads or in heavy traffic.

In the event of a steep slope, the cruise control cannot prevent the vehicle from exceeding the programmed speed.

In any event, the cruise control cannot replace the need to observe the speed limits, nor can it replace the need for vigilance and responsibility on the part of the driver.

It is advisable to leave your feet near the pedals.

To avoid any jamming under the pedals:

- ensure that the mat and its fixings on the floor are positioned correctly,
- never place one mat on top of another.



SPEED LIMITER "LIMIT"

"This is the selected speed which the driver does not wish to exceed".

This selection is made with the engine running while stationary or with the vehicle moving. The minimum speed which can be programmed is 20 mph (30 km/h).

The speed of the vehicle responds to the pressure of the driver's foot as far as the accelerator pedal point of resistance which indicates that the programmed speed has been reached.

However, pressing the pedal beyond this point of resistance to the floor permits exceeding of the programmed speed. To resume use of the limiter, simply reduce the pressure on the accelerator pedal gradually and return to a speed below that programmed.

The operating actions may be carried out when stationary, with the engine running, or with the vehicle moving.

This speed limiter shows the function selection status on the instrument panel and displays the programmed speed:



Function selected, displaying of the "Speed Limiter" symbol.



Function deactivated, last programmed speed - **OFF** (example at 65 mph (107 km/h)).



Function activated (example at 65 mph (107 km/h)).



Vehicle speed above (example 70 mph (118 km/h)), the programmed speed is displayed flashing.



Operating fault detected, **OFF** - the dashes flash.



Selecting the function

- Place the dial in the **LIMIT** position. The limiter is selected but is not yet active. The display indicates the last programmed speed.



Programming a speed

A speed can be programmed without activating the limiter but with the engine running.

To memorise a speed higher than the previous one:

- press the **Set +** button.

A brief press increases the speed by 1 mph (km/h).

A maintained press increases the speed in steps of 5 mph (km/h).

To memorise a speed lower than the previous one:

- press the **Set -** button.

A brief press decreases the speed by 1 mph (km/h).

A maintained press decreases the speed in steps of 5 mph (km/h).

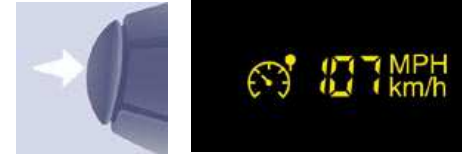

Activation/Deactivation (off)

Pressing this button once activates the limiter, pressing the button again deactivates it (OFF).

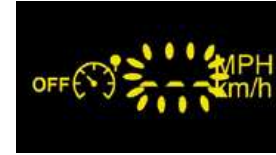

Exceeding the programmed speed

Pressing the accelerator pedal in order to exceed the programmed speed will have no effect unless you press the pedal **firmly** beyond the **point of resistance**.

The limiter is deactivated temporarily and the programmed speed flashes.

To return to the limiter function, reduce your speed to below the programmed speed.

Flashing of the speed

The speed flashes:

- following forcing of the accelerator point of resistance,
- when the limiter cannot prevent an increase in the vehicle speed due to the profile of the road or on a steep descent,
- in the event of sharp acceleration.

Switching the function off

- Place the dial in position **0** or switch off the ignition to switch the system off.

The last programmed speed remains in the memory.

Operating fault

The programmed speed is cleared then replaced by three dashes. Contact a CITROËN dealer to have the system checked.

Good practice

In any event, the speed limiter cannot replace the need to observe speed limits, nor can it replace the need for vigilance and responsibility on the part of the driver.

Always pay attention to the profile of the road and sharp acceleration and stay in complete control of your vehicle.

To avoid any jamming under the pedals:

- ensure that the mat and its fixings on the floor are positioned correctly,
- never place one mat on top of another.



Heating control panel



Air conditioning control panel

VENTILATION

Manual adjustments:

Temperature

Control positioned:



in the blue zone, triggers cool air,



in the red zone, triggers heating of the interior ambient air.

Air flow



The force of the blown air at the vents varies from 1 to the strongest 4. Position 0 switches it off. Remember to adjust this control in order to reach the ambient air comfort level.

Air distribution

The air supply distribution is determined by the following symbols:



the side vents and the central vents,



the footwells,



the windscreen and the footwells,



the windscreen.



The air distribution can be modulated by placing the control in the intermediate positions, marked "•".

Ventilation

Intake of exterior air



The diode on the button is off. This is the preferred operating position.

Recirculation of interior air



The diode on the button is lit. Recirculation temporarily prevents exterior odours and smoke from entering the passenger compartment.

Used with the setting of the force of blown air (from 1 to 4), recirculation enables you to obtain the required ambient air comfort level more quickly with both hot or cold settings.

This position should only be temporary. When your ambient air comfort level has been reached, return to the intake of exterior air position to permit renewal of the air in the passenger compartment and avoid misting. This operating mode is preferable.

Air conditioning A/C

The air conditioning can only operate with the engine running.



Pressing the button triggers the operation of the air conditioning, the diode is lit. Pressing the button again switches the function off and the diode is switched off.

The air conditioning does not operate if the air flow is set to 0.



DE-ICING AND DEMISTING

Manual mode



Direct the control to this air distribution setting.



Direct the control to this temperature setting.



Increase the air flow setting.



Press the air conditioning.



Returning to exterior air intake open permits renewal of the air in the passenger compartment (diode off).

De-icing the rear screen and/or mirrors



Pressing this button, with the engine running, activates the rapid demisting - de-icing of the rear screen and/or electric mirrors.

This function switches off:

- when the button is pressed,
- when the engine is switched off,
- automatically to prevent excessive energy consumption.

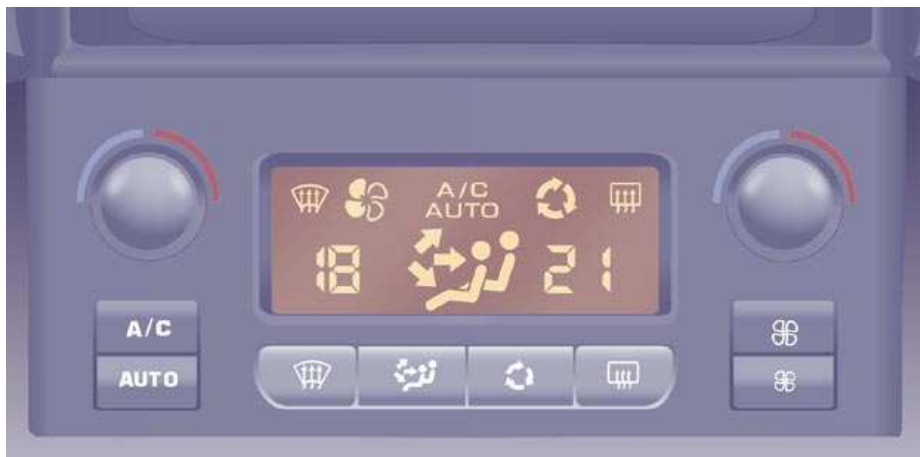

AUTOMATIC AIR CONDITIONING WITH SEPARATE ADJUSTMENTS FOR THE DRIVER AND PASSENGER

Good practice

For maximum cooling or heating of the passenger compartment, it is possible to exceed the value 15 by turning until LO is displayed or the value 27 by turning until HI is displayed.

On entering the vehicle, the inside temperature may be much colder (or warmer) than is comfortable. There is no advantage in changing the value displayed in order to quickly reach the level of comfort required. The system will use its maximum performance to reach the comfort value set.

Automatic operation

AUTO comfort programme

This is the normal air conditioning system operating mode.

AUTO Press this button, the **AUTO** symbol is displayed. In accordance with the comfort value selected, the system controls the distribution, the flow and the intake of air to guarantee comfort and a sufficient circulation of air in the passenger compartment. No further action on your part is required.

When the engine is cold, to prevent an excessive diffusion of cold air, the air diffuser will reach its optimum level gradually.

For your comfort, the settings are stored when the ignition is switched off and are reinstated the next time the vehicle is started.

The automatic function will no longer be maintained if you change a setting manually (AUTO is cleared).

Driver or passenger side comfort value

The value indicated on the display corresponds to a level of comfort and not a temperature in degrees Celsius or Fahrenheit.



Turn this control to the left or to the right to decrease or increase the value. A setting around the value 21 provides optimum comfort. However, depending on your requirements, a setting between 18 and 24 is usual.



Do not cover the sunshine sensor located on the fascia.

Manual operation

You can, according to your requirements, make a different selection from that offered by the system by changing a setting. The other functions will still be controlled automatically. Pressing the **AUTO** button restores fully automatic operation.



Air distribution

Pressing this button several times in succession directs the air flow towards:

- the windscreen,
- the windscreen and footwells,
- the footwells,
- the side vents, central vents and footwells,
- the side vents and central vents.



Air flow

Press the **small fan** button to reduce the flow or the **large fan** button to increase the flow.

On the display, the blades of the fan fill when the flow is increased.



Deactivating the system

Press the air flow **small fan** button until the fan symbol disappears from the display.

This action deactivates all of the system's functions, with the exception of the air recirculation and rear screen demisting (if fitted on your vehicle). Your comfort setting is no longer maintained and is switched off.

For your comfort, do not deactivate the system for long periods.



Pressing the **large fan** button or the **AUTO** button reactivates the system with the values set before it was deactivated.



Intake of exterior air/ Recirculation of interior air

Press this button to recirculate the interior air. The recirculation symbol is displayed.

Recirculation prevents exterior odours and smoke from entering the passenger compartment. Avoid prolonged operation in interior air recirculation mode (risk of condensation, odour and humidity). Pressing this button again activates the intake of exterior air.



Switching the air conditioning On/Off

Press this button, the **A/C** symbol is displayed and the air conditioning is activated.

Pressing this button again switches off the air cooling.



The ventilation outlet, located in the glove box, diffuses cool air (if the air conditioning is on) regardless of the reference temperature requested in the passenger compartment and regardless of the exterior temperature.



DE-ICING AND DEMISTING

Automatic mode: visibility programme

The comfort programme (AUTO) may not be sufficient to quickly demist or de-ice the windows (humidity, several passengers, ice).

In this case, select the visibility programme. The visibility programme indicator light comes on.

It activates the air conditioning, the air flow and provides optimum distribution of the ventilation to the windscreen and side windows.

It deactivates the air recirculation.

GOOD PRACTICE

Vents

"Leave them open"

For optimum distribution and diffusion of hot or cool air in the passenger compartment, there are adjustable central and side vents which can be directed sideways (right or left) or vertically (up or down). For your comfort while driving, do not close them and direct the flow of air towards the windows instead.

Air vents in the footwells and directed towards the windscreen complete the equipment.

Do not block the vents located at the windscreen or the air extractor located in the boot.

Dust filter, odour filter (activated carbon)

This filter traps certain dust and limits odours.

Ensure that this filter is in good condition and have all of the filter elements replaced regularly.



Refer to the "Checks" section of chapter 6.

Air conditioning

In all seasons, the air conditioning should only be used with the windows closed. However, if the interior temperature remains high after a prolonged period parked in the sun, do not hesitate to ventilate the passenger compartment for a few minutes.

Use the AUTO mode as much as possible as it permits optimised control of all of the functions: air flow, passenger compartment comfort temperature, air distribution, air intake mode or air recirculation in the passenger compartment.

Operate the air conditioning system for 5 to 10 minutes, once or twice a month, to keep it in perfect working order.

It is normal that the condensation created by the air conditioning system results in a flow of water which may form a puddle under the vehicle when parked.

If the system does not produce cold air, do not use it and contact a CITROËN dealer.



FRONT SEATS

The following adjustments are available:

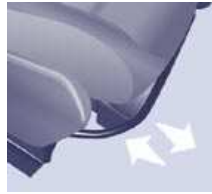

1 - Forwards/backwards adjustment

Lift the bar and slide the seat forwards or backwards.



2 - Seat back angle adjustment

With your back pressed against the seat back, move the lever forwards and set the required angle.



3 - Driver's seat height adjustment

To raise the seat, pull the control upwards then take your weight off the seat cushion.

To lower the seat, pull the control upwards then push on the seat cushion.



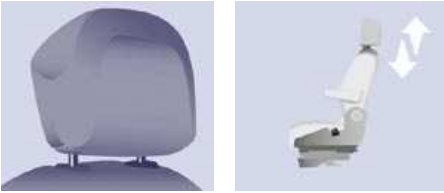

Head restraint height adjustment

To raise the head restraint, slide it vertically upwards.

To lower the head restraint, press the button and slide the head restraint vertically downwards.

The adjustment is correct when the upper edge of the head restraint is level with the top of the head.

To remove the head restraint, press the button and pull the head restraint upwards.

To re-install the head restraint, engage the rods in the holes making sure they are aligned with the seat back.



Never drive with the head restraints removed; they must be in place and correctly adjusted.

Adjustable armrest

To access the vertical position, raise the armrest until it locks.

Lower the armrest to return it to a position for use.

To remove the armrest, press the release button from the vertical position and move aside the armrest.

To put the armrest back in place, clip it in the vertical position.

If the vehicle is fitted with the additional console and an armrest, to fold the passenger seat to the table position remove the console or the armrest.

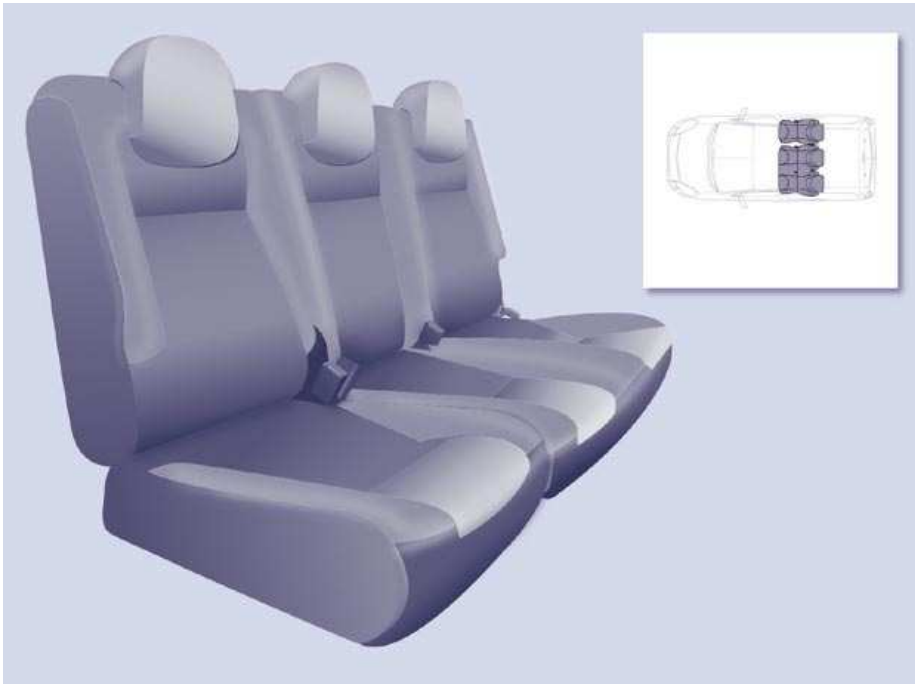

REAR BENCH SEAT

The 1/3 - 2/3 rear bench seat is fitted with "comma" head restraints.

Each 1/3 - 2/3 section can be folded fully, then removed individually.

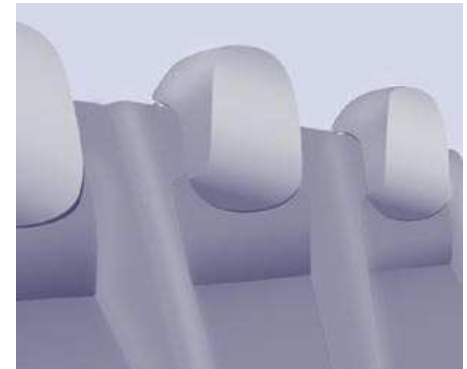

Head restraint

High position: lift and raise the head restraint.

Low position: press on the head restraint to lower it.

To remove the head restraint, after raising it press the tab and lift the head restraint.

To install the head restraint, engage the rods of the head restraint in the holes keeping it in line with the seat back.

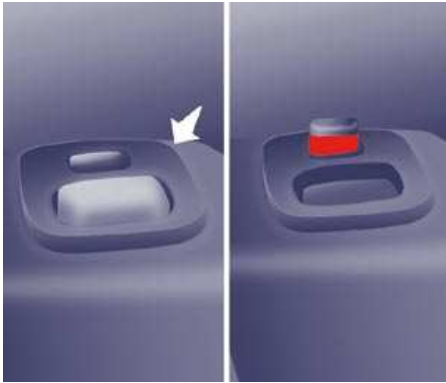

Fully folded position

Example of operations for the 1/3 section. They are identical for the 2/3 section.

- Place the head restraints in the low position.
- If necessary, move the front seats forward.
- Press the grey control located on the upper part of the seat back.
- Fold the seat back onto the seat cushion.

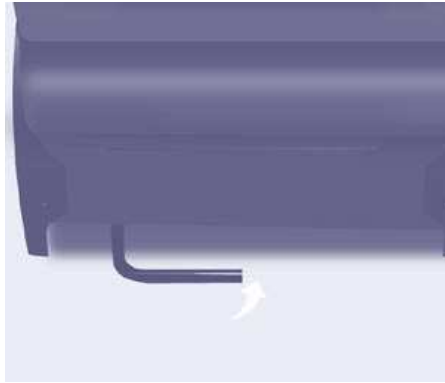

- Raise the grey control bar, located at the rear of the seat cushion.

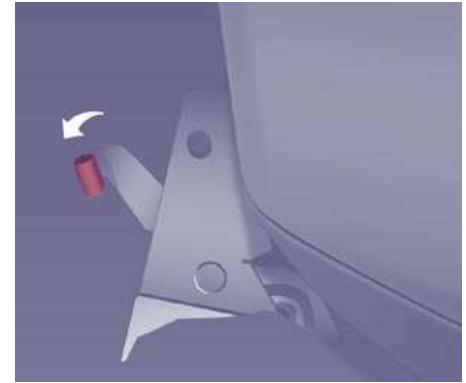

Putting back in place

Press the red control and tilt the entire seat rearwards until it locks.

Raise the seat back.

The seat is locked correctly when the red control (at the top of the seat back) is no longer visible.

Check that the seat is locked on the floor securely when it is returned to the sitting position.



- Tilt the entire seat forward.

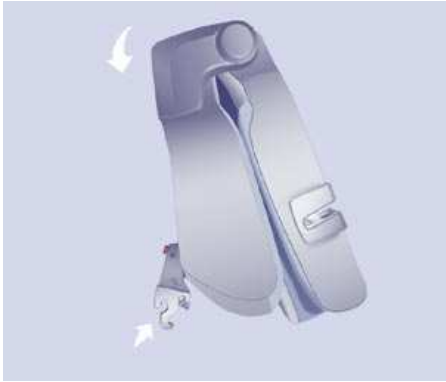

Removing the bench seat

- If necessary, move the front seats forward.
- Place the bench seat (1/3 section and/or 2/3 section) in the fully folded position.

+ Refer to the "fully folded position" described on the previous page.

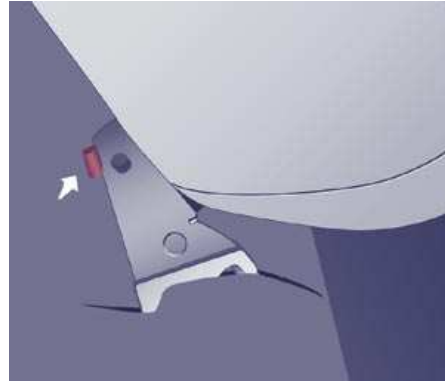

- Press the red lever, in the centre of the vehicle, to release the front feet.
- Tilt the entire seat rearwards by approximately 45° without releasing the lever.
- Release the lever.
- Lift the bench seat **vertically** to the limit of the anchorages.
- Straighten bench seat by tilting it forwards then lift it.

Refitting the bench seat

- Offer up the bench seat (1/3 section and/or 2/3 section) vertically.
- Place the hooks between the two bars.
- Fold the bench seat rearwards.

+ To return the bench seat (1/3 section and/or 2/3 section) to the "passenger transportation" position, refer to the "fully folded position" described on the previous page.

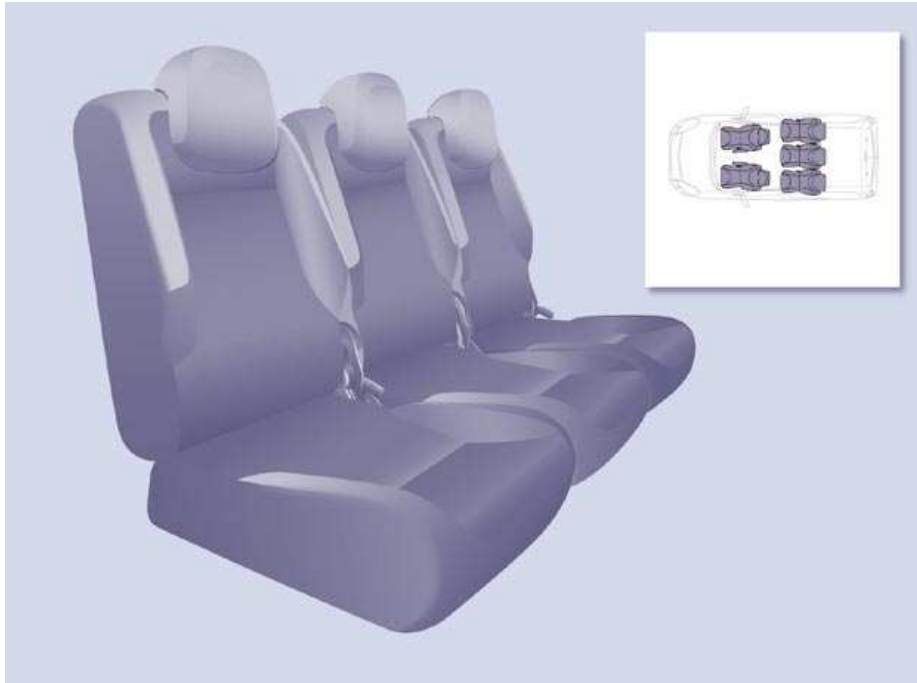

REAR SEATS (5 SEAT VERSION)

The three independent rear seats are fitted with "comma" head restraints.

The back of the centre seat, folded onto the seat cushion, has a shell which serves as a table with cup holder.

Each seat can be removed individually. Each time a seat is returned to the sitting position or after removing then refitting a seat, check that it is locked on the floor securely.

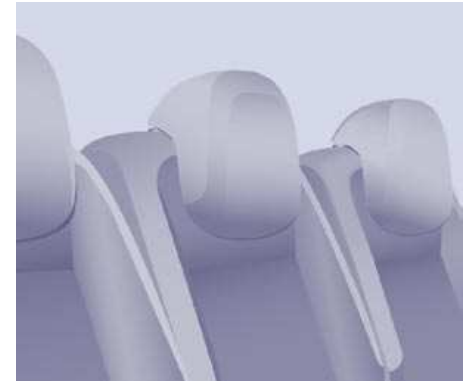

Head restraint

High position: lift and raise the head restraint.

Low position: press on the head restraint to lower it.

To remove the head restraint, after raising it press the tab and lift the head restraint.

To install the head restraint, engage the rods of the head restraint in the holes keeping it in line with the seat back.

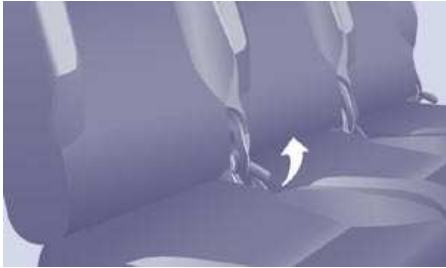

Adjusting the angle of the seat back

- Operate the control and adjust the angle of the seat back.



Placing the seat back in the table position

- Pull the control to fold the seat back onto the seat cushion.

Do not place hard or heavy objects on the table. They could become dangerous projectiles in the event of sharp braking or impact.

Returning the seat back to the sitting position

- Release the seat back by pulling the control, then return it to its original position.

When returning the seat back to the sitting position, ensure that it is locked securely.

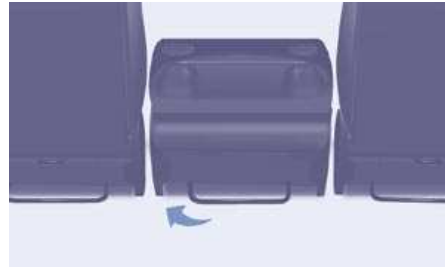

Placing the seat in the fully folded position

- Pull the control to place the seat back in the table position.
- Raise the bar located behind the seat to release the rear anchoring points.
- Tilt the entire seat forwards, until it locks.

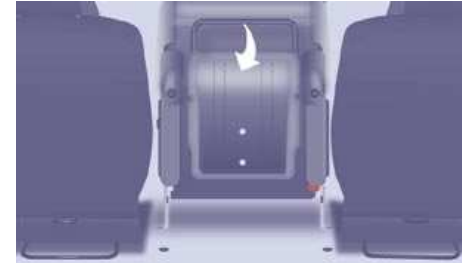

Returning the seat to its original position

- Push the red control.
- Fold back the seat to fix the rear anchoring points.
- Raise the seat back by pulling the control.

Check that the entire seat is anchored securely.



Red control.



Fully folded.



Anchorage.

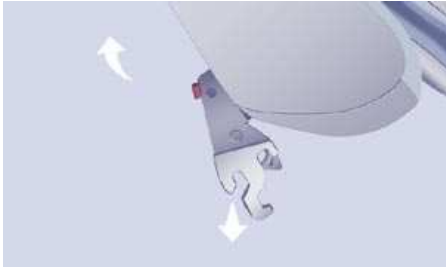

Removing the seat

- If necessary, move the front seats forward and lower the head restraint.
- Place the seat in the fully folded position.

 Refer to the "fully folded position" described on the previous page.

- Press the red lever to release the front feet.
- Tilt the entire seat rearwards by approximately 45° without releasing the lever.
- Release the lever.
- Lift the seat **vertically** to the limit of the anchorages.
- Straighten the seat by tilting it forwards then lift it.

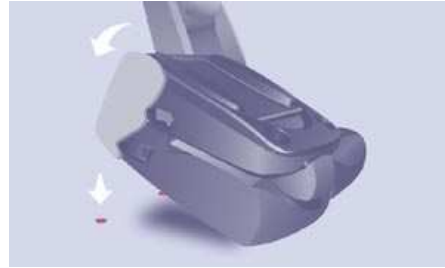

Putting the seat back in place

- Tilt the seat forward by 45°.
- Place the hooks between the two bars.
- Fold back the seat to fix the rear anchoring points.
- Pull the control to return the seat back to its initial position.
- Raise the head restraint.

Check that no object is obstructing the anchoring recesses or preventing correct locking of the seats.

Good practice

Following the various operations:

- do not remove a head restraint without storing it and fix it to a support,
- ensure that the passengers can always access the seat belts and fasten them easily,
- a passenger must never take his seat without adjusting and fastening his seat belt.



REAR SEATS (7 SEAT VERSION)

The seats of row 2 and row 3 are independent and adjustable.

Each seat can be removed and must be replaced in the specified position, indicated by a symbol on its label.



Head restraint

This is of the "comma" type.

High position: press the tab, lift and raise the head restraint.

Low position: push the tab and press the top of the head restraint to lower it.

To remove the head restraint: place it in the high position, lift it, then remove it. Store it inside the vehicle, securing it firmly.

To install the head restraint: engage the rods of the head restraint in the holes keeping it in line with the seat back.

Seats

68



Types of Row 2 seat

Left-hand side seat

Centre seat

Right-hand side seat



Types of Row 3 seat

Left-hand side seat

Right-hand side seat

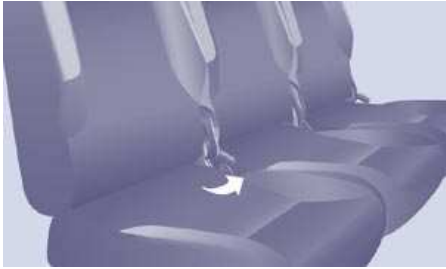

Row 2 seat adjustments

Adjusting the angle of the seat back

- Operate the control and adjust the angle.

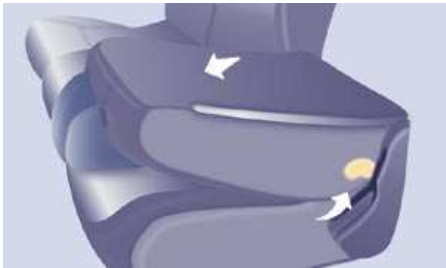

Placing the seat in the table position

- Lower the head restraint fully.
- Operate the control to fold the seat back onto the seat cushion.

Returning the seat back to the sitting position

- Release the seat back by pulling the control, then return it to its original position.

Ensure that the entire seat is anchored securely.



Placing the seat in the fully folded position

- Place the seat in the table position.
- Pull the red strap, located behind the seat, to release the feet of the seat from their anchorage on the floor.
- Tilt the entire seat forwards.



Returning the seat to its original position

- Fold back the entire seat.

i Before folding the seat, ensure that:

- in row 3, no passenger's foot is at one of the seat anchorages on the floor,
- the seat is locked securely on the floor,
- the seat belt is available for the passenger.



Row 3 seat adjustments

Placing the seat back in the table position

- Lower the head restraint fully.
- Operate the control to fold the seat back onto the seat cushion.

Returning the seat back to the sitting position

- Release the seat back by pulling the control, then return it to its original position.

Ensure that the entire seat is anchored securely.



Placing the seat in the fully folded position

- Place the seat in the table position.
- Raise the bar fitted with a red strap, located behind the seat, to release feet of the seat from their anchorage on the floor.
- Tilt the entire seat forwards.

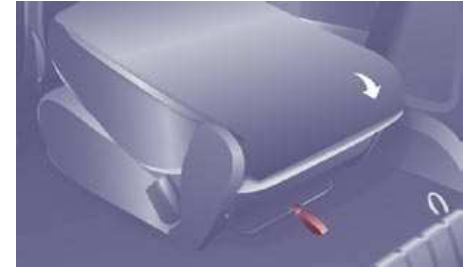

Returning the seat to its original position

- Push the red control.
- Fold back the entire seat.



Ensure that:

- the seat is locked securely on the floor,
- the seat belt is available for the passenger.



Entering, exiting from row 3

Entering

- Place the row 2 seat in the table position.



-  Before folding it back, ensure that the feet of the passenger in row 3 are not obstructing the row 2 seat anchoring points.



- Pull the red strap to place the seat in the fully folded position.
- Tilt the entire seat forwards.



- Tilt it to the fully folded position to allow access.



Exiting

- Lower the head restraint fully.
- Operate the yellow control, located on the back of the row 2 seat back.
- Fold the seat back to the table position.

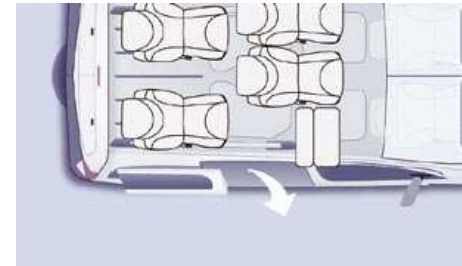

- Exit via the side door.

-  Ensure that the stored centre seat belt is placed correctly in its strengthener in the headlining.

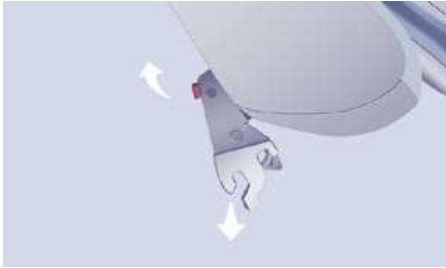

Handling the Row 2 seat

Removing the seat

- If necessary, move the front seats forward.
- Lower the head restraint.
- Place the seat in the fully folded position.
- Tilt the entire seat forwards then lift it.

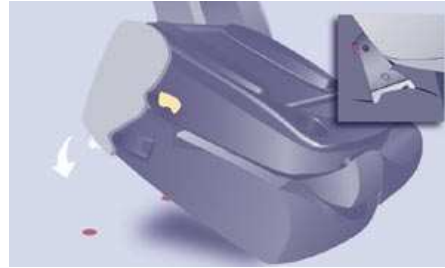

Repositioning the seat

The label on the seat indicates the position in which it must be installed.

- Place the hooks of the front feet between the two bars.
- Fold back the seat to fix the rear anchoring points.
- Operate the control to raise the seat back to its initial position.
- Raise the head restraint.



- 👁 Ensure that no object or foot of a passenger seated in the rear is obstructing the anchoring recesses or preventing correct locking of the seat.

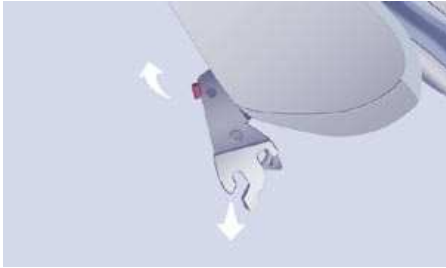

Handling the Row 3 seat

Removing the seat

- Lower the head restraint.
- Place the seat in the fully folded position.
- Tilt the entire seat forwards.
- On each side, take hold of the uprights of the folded seat, tilting it forward slightly, and lift it.

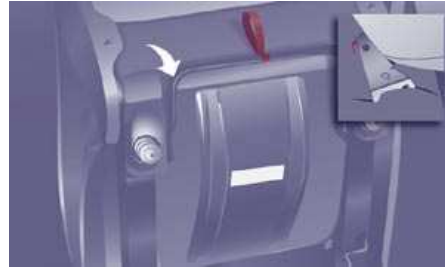

Repositioning the seat

The label on the seat indicates the position in which it must be installed.

- Place the hooks of the front feet between the two bars.
- Ensure that no object or foot is obstructing the rear anchoring recesses and that the seat belt is positioned correctly and available.
- Fold back the seat to fix its rear anchoring feet.
- Operate the control to raise the seat back to its initial position.
- Raise the head restraint.

Good practice

Do not place hard or heavy objects on the seat backs forming a table, they could become dangerous projectiles in the event of sharp braking or impact.

Following the various operations:

- do not remove a head restraint without storing it, fix it to a support in the vehicle,
- ensure that the passengers can always access the seat belts and fasten them easily,
- a passenger must never take his seat without adjusting and fastening his seat belt.
- a passenger seated in row 3 must ensure that he does not obstruct the row 2 seat anchoring recesses.

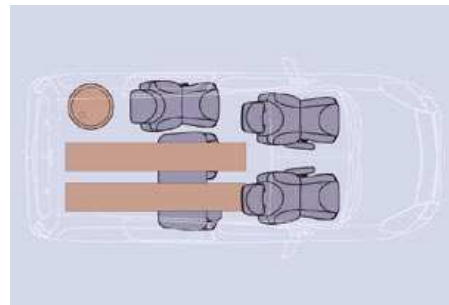
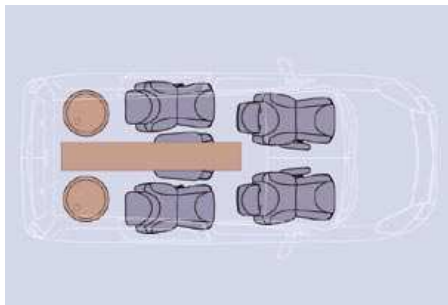
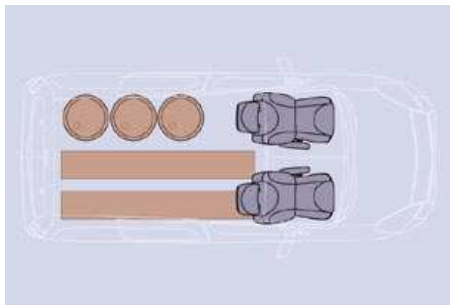
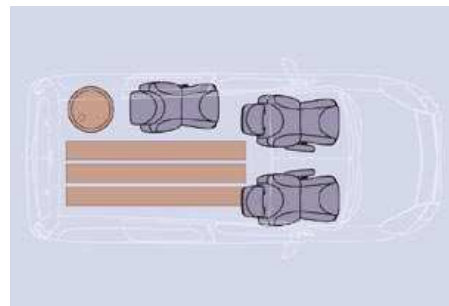
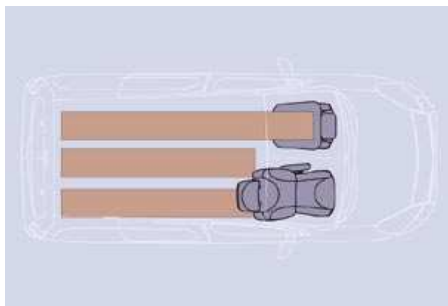
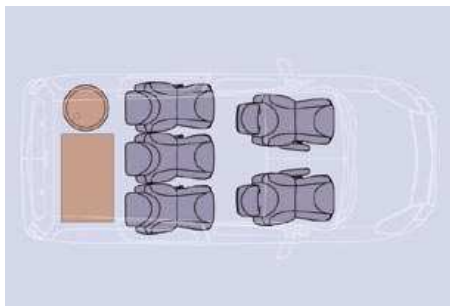

ADJUSTMENTS AND DIFFERENT CONFIGURATIONS OF THE SEATS

5 seat layouts

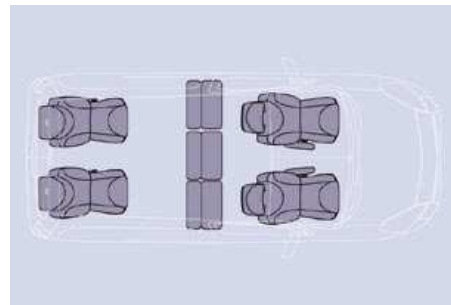
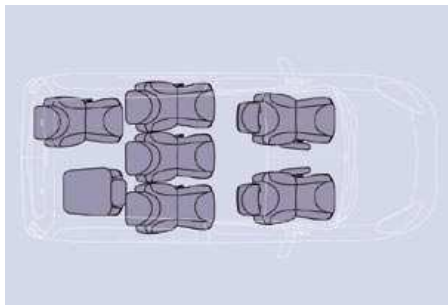
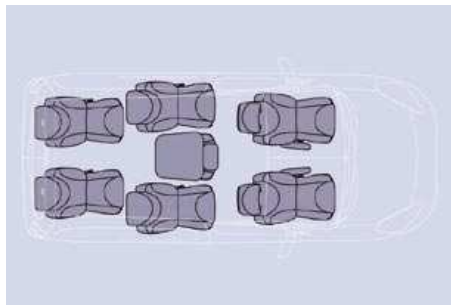
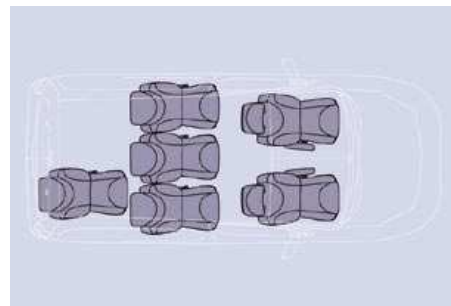
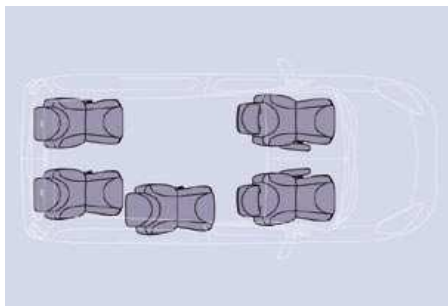
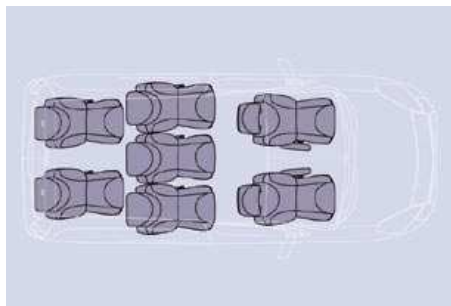

7 seat layouts



The various operations must be carried out while stationary.

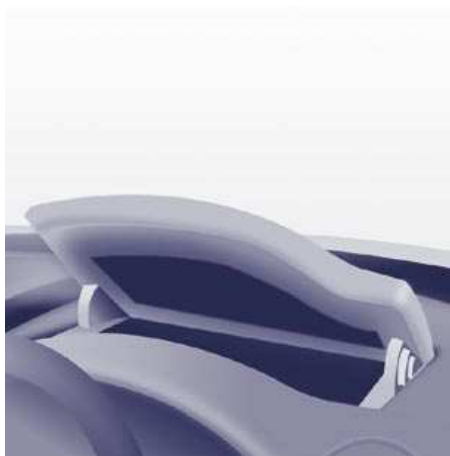

FRONT FITTINGS

Upper storage compartment

This is located on the fascia, behind the steering wheel.

A recess makes lifting of the lid easier when opening. Guide it to its rest position.

To close, guide the lid then press the centre gently.

Any liquid which could spill risks causing an electrical short circuit and therefore a potential fire.

1. Lower glove box

An auxiliary socket is located in the glove box (cable not supplied) for the connection of portable equipment (MP3 player, ...).

2. Storage tray and bottle holder (1.5 L)

3. Side storage compartment

4. Bag hook

Only hang flexible bags which are not too heavy on this hook.

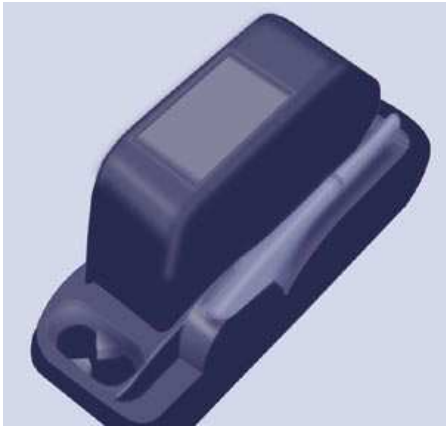

Central storage console

This console offers an appreciable additional storage area: it can be removed and clips onto a base which also incorporates two cup holders at the rear.

Ensure that the object (bottle, can...) placed in the cup holder is retained securely and does not risk being dislodged while driving.

Any liquid which could spill presents a risk of damage on contact with the instrument panel and centre console controls.

Take care.



Overhead storage unit

This is located above the sun visors and can accommodate various objects (a jumper, file, gloves...).

The openings concealed by the sun visors allow you to see and access the objects stored in the overhead storage unit.

The maximum weight permitted in the overhead storage unit is 5 Kg.

Do not place objects in this storage unit which could present a risk to the occupants.

Sun visor

To prevent dazzle from ahead, fold the sun visor down.

A pocket is provided in the driver's sun visor for storing toll cards, tickets, ...



Drawers under seats

Your vehicle may be fitted with a drawer, under each front seat.



Storage compartment under seats

Storage compartments are available, with or without lid, in the floor under the front seats.

To gain access to them, move the seat forward. The lid must be lifted from the rear of the seat.

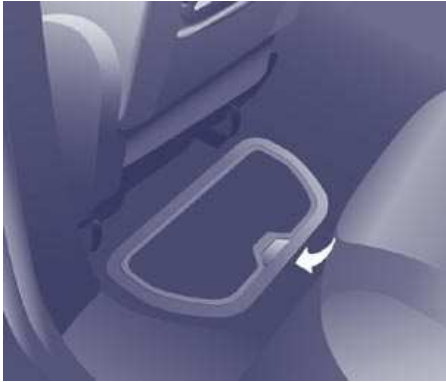

SEATING AREA LAYOUT

Floor boxes

Two boxes are available, located under the rear passenger footwells.

To open them, slide your fingers into the recess and lift the lid.



Aircraft style tables

To put the table in place, pull it upwards and fold it down.

As a safety precaution, above a high pressure, the table is designed to unhook.

To put it back in place, with the table vertical, engage one side then the other, forcing slightly.

Do not place hard or heavy objects on the table. They could become dangerous projectiles in the event of sharp braking or impact.

A bag hook is provided on the side of each table.



Side blinds

Side blinds may be available on the sliding side doors.

Pull the side blind by the tab to install it. To avoid damaging the blind when opening the door, check that the tab is hooked securely.

 Always guide the blind slowly using the tab, both when raising and when lowering.



MODUTOP ROOF

The multifunction roof extends the overhead storage unit. It consists of the following components:



Storage compartments

Storage compartments are provided on each side of the roof. The maximum weight is 6 Kg.

The translucent base assists with finding objects stored inside.

Do not store objects which could present a risk to the occupants.



Courtesy lamp

The operation of the courtesy lamp is identical to that of the front courtesy lamp.

 Refer to the "Comfort and Safety" section of chapter 3, "Courtesy lamps" part.



From inside

Rear box

This roof box can be accessed from the rear seats and the boot. From the rear seats, slide the flaps to open.



From outside

From the boot, place your thumb on the recess then pull the handle to open.



Open carefully to prevent objects stored in this interior roof box from falling out.

The maximum authorised weight is 10 Kg.



Vents

A 3-position control allows you to adjust the quantity of air discharged. The temperature of the air diffused by these vents is identical to that selected for the front vents. These vents are also fitted with a fragrance diffuser.



SCENTED AIR FRESHENER

The scented air freshener diffuses a fragrance in the passenger compartment from the roof console vents.

Adjusting the flow

Turn the chromed button to adjust the diffusion:

- to the left to decrease,
- to the right to increase.

To stop the diffusion, turn the chromed button fully to the left.



Removing the scented air freshener

- Press the button down while turning it a quarter of a turn to the left to the stop.
- Remove the scented air freshener from the roof console.
- Replace the cartridge.

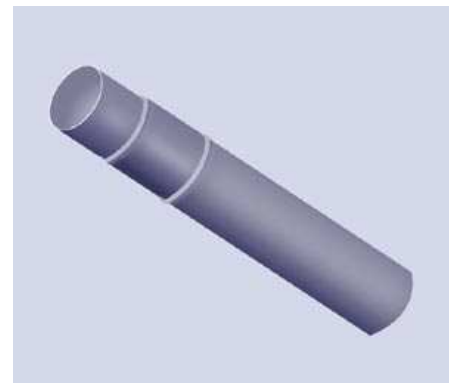
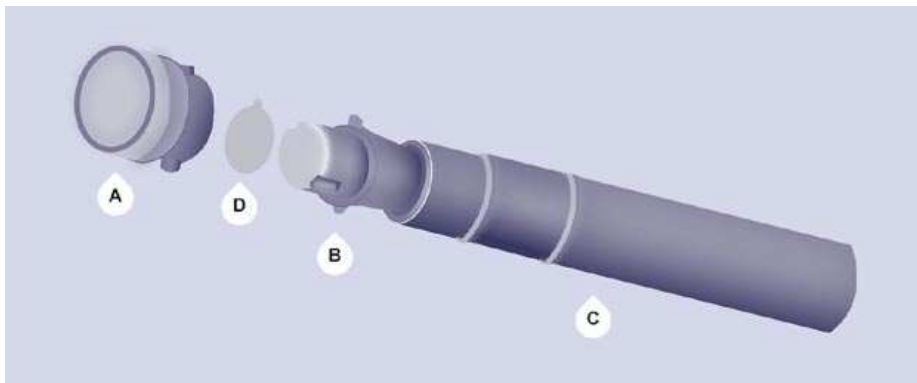

Replacing a cartridge

The scented air freshener refill consists of a cartridge **B** and its sealing case **C**.

- Remove the protective film **D**.
- Place the head of the cartridge **B** on the button **A** of the scented air freshener.
- Turn it a quarter of a turn to lock it on the button and remove the case.
- Insert the scented air freshener in its location.

You can change the cartridges at any time and store cartridges which have already been started in their original case.

The scented air freshener button **A** is independent of the cartridge.

The cartridges are supplied without the button **A**.

The scented air freshener button **A** can only be fixed on the multifunction roof console with a cartridge.

Therefore, always retain button **A** and a cartridge.

The cartridges are available from CITROËN dealers.

Inserting the scented air freshener

After fitting or changing the cartridge:

- Put the scented air freshener back in place in its location.
- Turn it a quarter of a turn to the right.

Good practice

As a safety precaution, only use the cartridges provided for this purpose. Do not dismantle the cartridges.

Keep the cartridge sealing cases which are used as packaging when the cartridges are not in use.

Never try to refill the cartridges with fragrances other than those recommended by the CITROËN network.

Keep out of reach of children and animals. Avoid contact with the skin and eyes. If swallowed, consult a doctor and show him the packaging or product label.

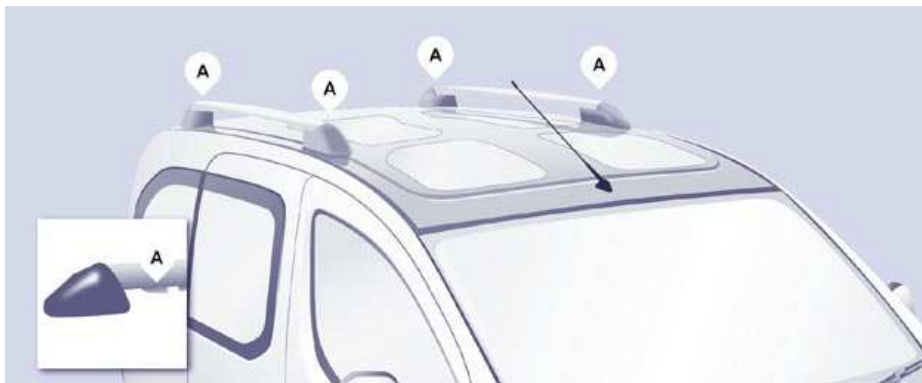

Modutop roof BARS

These two longitudinal Modutop roof bars can be removed.

The maximum authorised weight on each bar is 35 kg.

Recommendations for loading on the roof:

- Open the protective covers.
- Use the screwdriver (stored in the tool kit under the right-hand seat) to remove the 4 bolts.
- Turn the bars 90° placing the hollow parts towards the front.
- Tighten the 4 bolts.
- Close the protective covers.
- Use the strap passages **A** only to secure the load firmly.



In all cases, the load must rest on the non-slip bands provided for this purpose and must not touch the roof or the glazing of the roof.

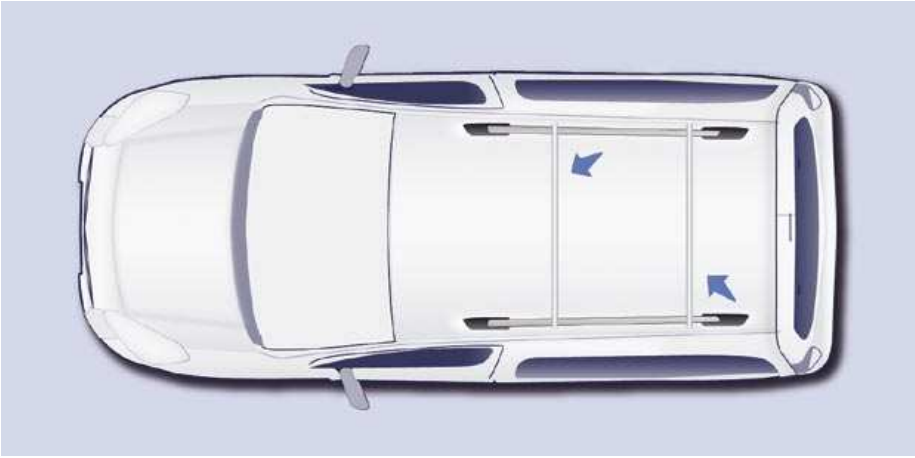

ROOF BARS

If you install transverse bars on these bars, refer to the weight values indicated by the manufacturer but do not exceed 75 Kg.

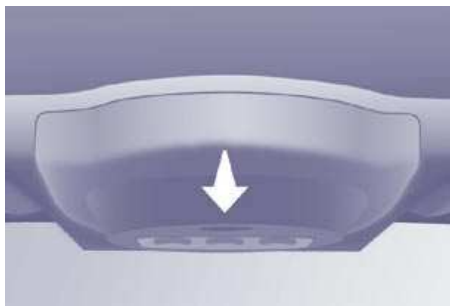

Front courtesy light



Rear courtesy light

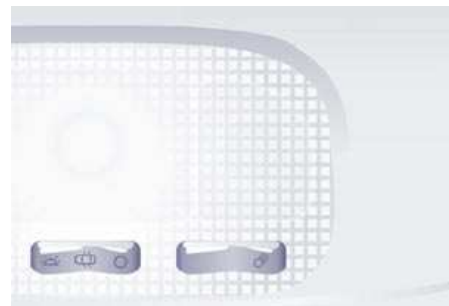

Front individual reading lights

COURTESY LIGHTS

Automatic switching on/off

The front courtesy light comes on when the key is removed from the ignition, when the vehicle is unlocked, when one of the front doors is opened and for location of the vehicle using the remote control.

It switches off gradually after the ignition is switched on and when the vehicle is locked.



Permanently on, ignition on.



Front seats: comes on when one of the front doors is opened.



Rear seats: comes on when one of the rear doors is opened.

If the doors remain open for a few minutes, the courtesy lights are switched off.



Permanently off.



These are switched on and off by means of a manual switch, with the ignition on.



TORCH (5 SEAT VERSION)

A removable torch, incorporated in the wall of the boot, carries out two functions:

- boot light,
- torch.

The boot light operates automatically when the boot is opened.

The torch operates with NiMH type storage batteries.

Observe the polarities when fitting these storage batteries.

Using the torch

Remove it from its location by pulling from the top.

Press the switch, located on the back of the torch, to switch it on or off.

The retaining clip allows you to position the torch for precise use (for example, lighting while changing a wheel).

Storing the torch

Always put the torch back starting by positioning the lower part in its location. If it is not engaged correctly it may not charge and may not come on when the boot is opened.

Putting the torch back in place switches it off automatically if it has not been switched off already.

The torch has a maximum operating time of 45 minutes and charges within a few hours while driving.

Never replace the storage batteries with conventional batteries.

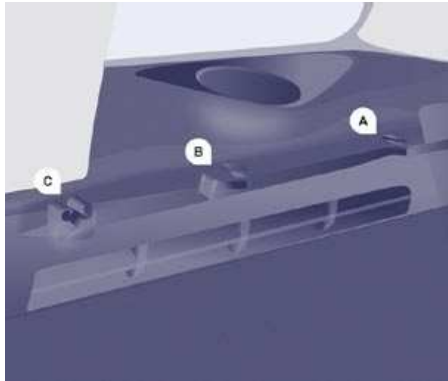

LOAD SPACE COVER (5 SEAT VERSION)

This rigid shelf conceals the objects stored in the boot.

Folding

From the boot, fold the half-shelf, raising it to detach it from the notch **C**.

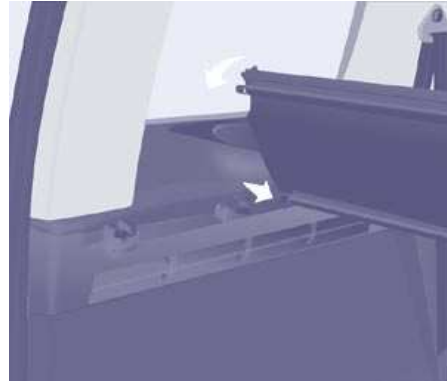

Removing

Fold the load space cover.
Detach it from the notches **A** and **B** pulling it towards you.
Raise it and remove the assembly.

Refitting

Place the load space cover in front of **A** and **B**.
Push it forwards to insert the lugs in the notches.
Unfold and clip into the notches **C**.



Storing (according to version)

A location is provided in the back of the rear seats to accommodate the load space cover folded onto itself.
Slide it vertically between the side guides located at mid seat back height.
Insert the hinge first, with the free flaps turned upwards.

This rigid load space cover can form a shelf. However, for safety reasons, do not place objects on it which could become dangerous projectiles in the event of sharp braking or rear impact.



12 Volt socket (120 W Max)

It is advisable to limit the use of this socket to avoid discharging the battery.

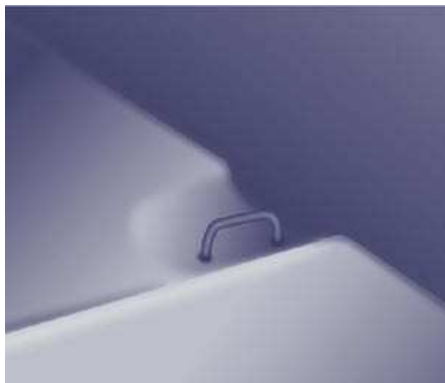

Stowing rings

Use these rings to secure loads on the floor.



Protective net

Open the cover located in the hook support.
 Fix the top of the net in the notches, having first turned the bar 1/4 of a turn.
 Ensure that the end of the bar engages correctly in the metal part of its location.
 Fix the straps in the locations provided on the floor.
 Tighten the net using the straps.

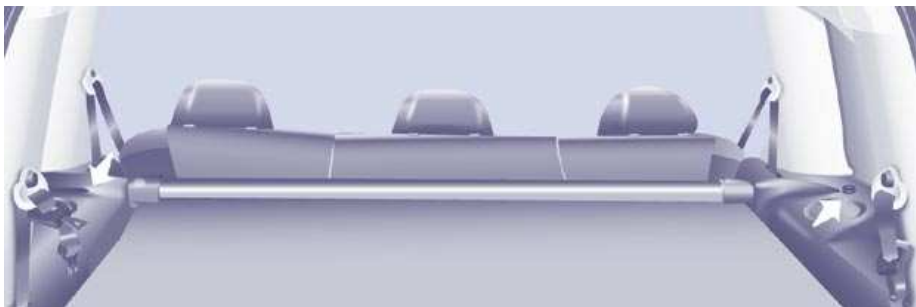

REAR FITTINGS (7 SEAT VERSION)

Cup holder

Any liquid carried in a cup (mug or other) on board which could spill, presents a risk.
Take care.

12 volt socket (120 W max)

It is advisable to limit the use of this socket to avoid discharging the battery.



Stowing rings

Use the stowing rings on the floor to secure and retain your loads firmly.
The seat belt anchorages must not be used for this purpose.



It is recommended that the load is immobilised by securing it firmly using the stowing rings on the floor.

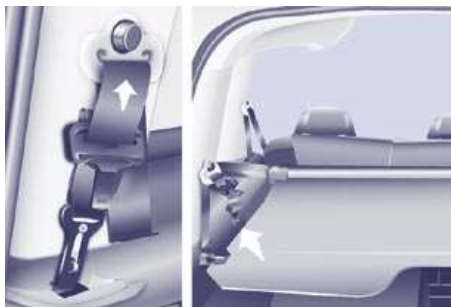

Seat belts

Ensure that the centre seat belt is rolled up correctly in its strengthener on the roof.

Prevent the row 3 seat belt buckles from knocking by raising them as close as possible to the stowages, located on the roof.

The seat belt buckle attachment rings on each side of the boot must not be used to retain loads.

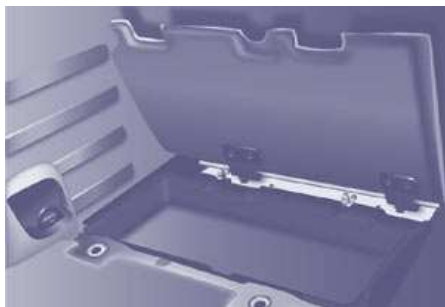

Storage flaps

Raise the corresponding flap.

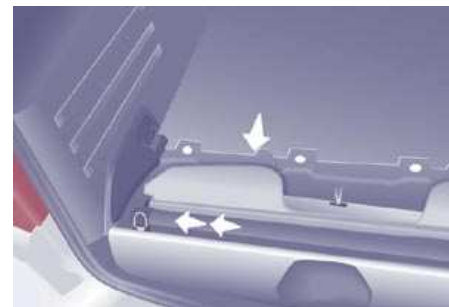

Next to the boot sill, the recess is intended to receive the roller tube containing the load space cover.

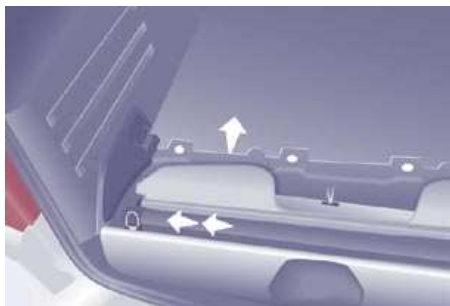

LOAD SPACE SCREEN, LOAD SPACE COVER

The load space screen is a load space cover of the blind type with roller. Take care not to place heavy objects on the

To install it

Place the row 3 seats in the fully folded position.
Raise the storage flap at the boot sill.
Take hold of the roller in the centre and compress it towards the left-hand pillar.
Raise the assembly.

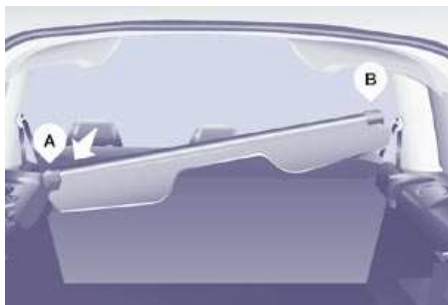
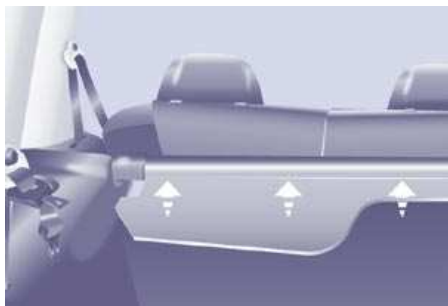

Position the load space screen so as to present the rear load space cover flaps towards you.
Engage the left-hand lug of the roller in the support **A**.

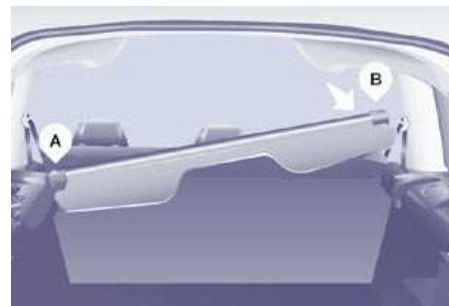

Compress then place the right-hand lug facing the support **B**.
Release to engage the roller in its support.
Unroll the load space cover to the rear side pillars.
Engage the ends in the rear notches to keep it taut.

i The roller is fitted with three flaps permitting concealment of the boot, whether the row 2 seats are in the normal position or the comfort position.

Each flap has two clips which are hooked on the base of each head restraint.

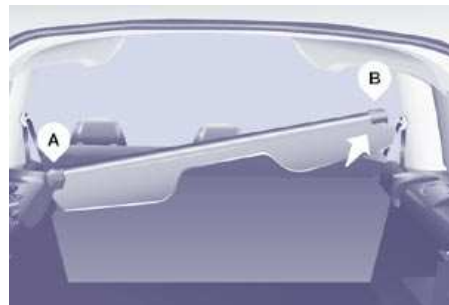

To remove it

From the boot, pull the load space cover towards you to release it from the side pillars.

Guide the load space cover as it rolls up.

Remove the clips of the three flaps from the base of each row 2 head restraint.

Compress the roller to the left to remove it from the support **B**.

Raise it and pivot it forwards.

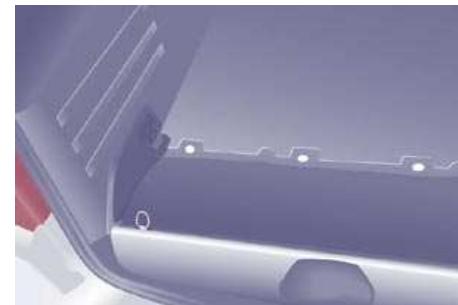
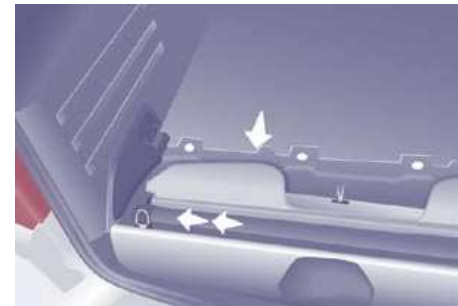

To store it

Store it in the recess at the boot sill, with the two rear flaps uppermost.

First, compress the load space screen to the left.

Release.

Arrange the two flaps and close the storage flap.



INTERIOR RACK

The interior rack consists of two bars to be installed at the top of the space leaving the lower area of the passenger compartment free.

It permits the transportation of long loads (2 metres maximum) with the doors or tailgate closed. The long load must rest on the overhead storage compartment and the two bars.

The two interior bars are covered with rubber and incorporate a strap passage to secure the loaded objects. However, be sure to comply with the loads and weights permitted.



Maximum load: 10 kilogrammes per bar.

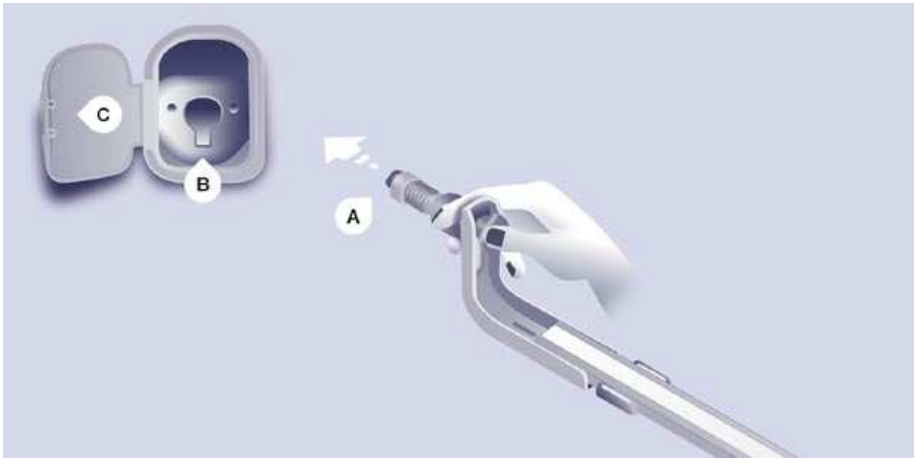

Fitting the bars

- Unclip the plastic covers **C**.
- Unscrew the knurled wheels located at the ends of the bars fully.
- Take hold of the bar by the ends to slide them towards the inside to retract them.
- Extract the metal end piece **A** taking hold of the end of the bar like a syringe.
- Insert the end piece **A** on one side then lower it to fix it in the base of the notch **B**.
- Carry out the same operations on the other side.
- Ensure that they are engaged correctly at the base of the notch.
- Tighten the knurled wheels and check the tightening by pushing the bar sideways.

To remove, proceed in the reverse order.

Storing

When the bars are not in use:

- partially loosen the knurled wheels,
- lift the bar slightly,
- pivot it upwards by 180°,
- tighten the knurled wheel.

Good practice

In the event of a front impact, the rack is disengaged to avoid injury to the occupants of the vehicle. The slight clearance observed in the bar is linked with this safety disengagement.

Do not loosen or place the bars in a position other than those described above.

The load on the rack must rest on the overhead storage compartment and be strapped using the strap passages provided on the bars.

The bars are not grab handles for the passengers.

i The interior rack is not compatible with the Modutop roof.

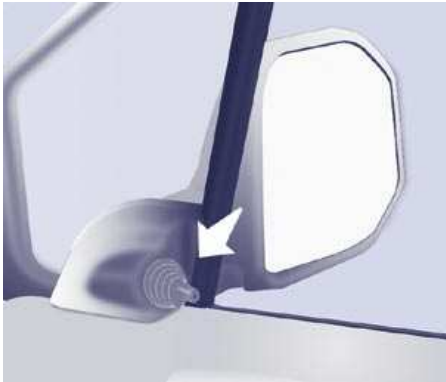

MIRRORS

Manual exterior mirrors

Move the lever in all four directions to adjust.

When the vehicle is parked, the exterior mirrors can be folded back manually.

The mirrors are not equipped with automatic de-icing.

Electric exterior mirrors

- Move the control to the right or to the left to select the corresponding mirror.
- Move the control in all four directions to adjust.
- Return the control to the central position.

Electric folding/unfolding

The mirrors can be folded or unfolded electrically from the inside, with the vehicle parked and the ignition on:

- Place the control in the central position.
- Turn the control downwards.

Heated mirrors

The electric mirrors can be heated.



Press the rear screen de-icing button.

Forced folding

If the mirror casing has come out of its initial location, with the vehicle stationary reposition the mirror casing manually or use the electric folding control.



Manual interior mirror

The interior mirror has two positions:

- day (normal),
- night (anti-dazzle).

To change from one to the other, push or pull the lever on the lower edge of the mirror.

Areas for toll cards/car park tickets

The athermic windscreen has two non-reflective zones located either side of the base of the interior mirror.

They are intended for affixing toll cards and/or car park tickets.



MONITORING MIRROR

This mirror, placed on top of the central mirror, enables the driver or front passenger to observe all the rear seats.

Fitted on its own ball joint, its manual adjustment is simple and provides a view of the rear interior of the vehicle.

It can also be adjusted for improved visibility during manoeuvres or when overtaking.



REAR WINDOWS

To partially open the rear windows, tilt the lever and push it fully to lock the windows in the open position.



Manual interior mirror

The interior mirror has two positions:

- day (normal),
- night (anti-dazzle).

To change from one to the other, push or pull the lever on the lower edge of the mirror.

Areas for toll cards/car park tickets

The athermic windscreen has two non-reflective zones located either side of the base of the interior mirror.

They are intended for affixing toll cards and/or car park tickets.



MONITORING MIRROR

This mirror, placed on top of the central mirror, enables the driver or front passenger to observe all the rear seats.

Fitted on its own ball joint, its manual adjustment is simple and provides a view of the rear interior of the vehicle.

It can also be adjusted for improved visibility during manoeuvres or when overtaking.



REAR WINDOWS

To partially open the rear windows, tilt the lever and push it fully to lock the windows in the open position.



ELECTRIC WINDOWS

1. Driver's electric window control
 2. Passenger electric window control
- There are two operating modes:

Manual mode

Press or pull the control, without passing the point of resistance. The window stops when you release the control.

Automatic mode

Press or pull the control, beyond the point of resistance. The window opens or closes fully when the control is released. Pressing the control again stops the movement of the window.

The electrical functions of the electric windows are deactivated:

- approximately 45 seconds after the ignition is switched off,
- after one of the front doors is opened, if the ignition is off.

Safety auto-reverse

When the window rises and meets an obstacle, it stops and partially lowers.

Reinitialisation

Following reconnection of the battery, or in the event of a malfunction, the safety auto-reverse function must be reinitialised.

Lower the window fully, then raise it, it will rise in steps of a few centimetres each time the control is pressed. Repeat the operation until the window is fully closed.

Continue to press the control for at least one second after the window closed position has been reached. The safety auto-reverse does not operate during these operations.

Good practice

If the electric windows meet an obstacle during operation, you must reverse the movement of the window. To do this, press the control concerned.

When the driver operates the passenger electric window controls, he must ensure that no one is preventing correct closing of the windows.

The driver must ensure that the passengers use the electric windows correctly.

Be aware of children when operating the windows.

Following several consecutive closing/opening operations of the electric window control, a protection system is triggered which only authorises closing of the window. After closing, wait approximately 40 minutes. Once this time has elapsed, the control becomes operational again.



DRIVING SAFETY

HAZARD WARNING LIGHTS

Press this button, the direction indicators flash.

They can operate with the ignition off.

The hazard warning lights should only be used in dangerous situations, when stopping in an emergency or when driving in unusual conditions.

Automatic lighting of hazard warning lights

When braking in an emergency, depending on the force of deceleration, the hazard warning lights come on automatically. They switch off automatically the first time you accelerate.

It is also possible to switch them off by pressing the button on the fascia.

HORN

Press the centre of the steering wheel.



HANDBRAKE

Applying

Pull the handbrake to immobilise your vehicle.

Check that the handbrake is applied firmly before leaving the vehicle.



If the handbrake is still on or has not been released properly, this is indicated by this warning light which comes on on the instrument panel.

When parking on a slope, direct your wheels towards the pavement and pull the handbrake.

There is no advantage in engaging a gear after parking the vehicle, particularly if the vehicle is loaded.

Releasing

Pull the handle and press the button to lower the handbrake.

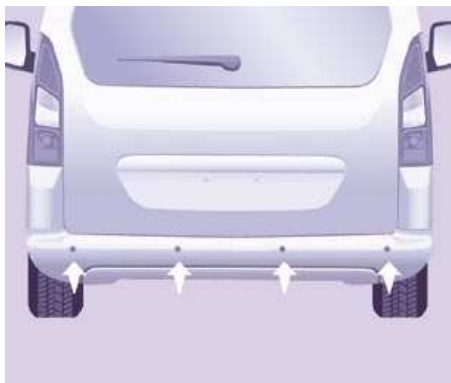

REAR PARKING ASSISTANCE

The audible and/or visual rear parking assistance consists of four proximity sensors, installed in the rear bumper. The sensors detect any obstacle which enters the field: person, vehicle, tree, fence, behind the vehicle during the manoeuvre.

Certain objects detected at the beginning of the manoeuvre will no longer be detected at the end of the manoeuvre due to the blind spots between and below the sensors.

Examples: stake, roadworks cone or pavement post.

Engage reverse gear

An audible signal confirms the activation of the system by engaging reverse gear.

The proximity information is indicated by an audible signal which becomes more rapid as the vehicle approaches the obstacle. When the distance between the rear of the vehicle and the obstacle is less than approximately thirty centimetres, the audible signal becomes continuous.

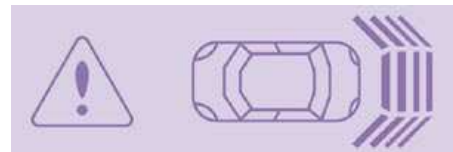

Display on the screen

Stop the assistance

Change to neutral.



Activation/Deactivation



You can activate or deactivate the system by pressing this button.

The activation or deactivation of the system is stored when the vehicle stops.

Operating fault

In the event of an operating fault, when reverse gear is engaged the diode on the button comes on, accompanied by an audible signal and a message on the display. Consult a CITROËN dealer.

Good practice

In bad weather or in winter, ensure that the sensors are not covered with mud, ice or snow.

The system will be deactivated automatically if a trailer is being towed or if a bicycle carrier is fitted (vehicle fitted with a towbar or bicycle carrier recommended by CITROËN).

The parking assistance cannot, in any circumstances, take the place of the vigilance and responsibility of the driver.

Driving safety

ANTI-LOCK BRAKING SYSTEM (ABS - EBFD)

The ABS and EBFD (electronic brake force distribution) systems improve the stability and manoeuvrability of your vehicle on braking, in particular on poor or slippery surfaces.

The ABS prevents locking of the wheels, the EBFD provides control of the braking pressure wheel by wheel.

Good practice

The anti-lock braking system comes into operation automatically when there is a risk of wheel lock. It does not reduce the braking distance.

On very slippery surfaces (ice, oil, etc...) the ABS may increase the braking distance. When braking in an emergency, do not hesitate to press the brake pedal firmly, without releasing the pressure, even on a slippery surface, you will then be able to continue to manoeuvre the vehicle to avoid an obstacle.

Normal operation of the ABS may be felt by slight vibration of the brake pedal.

When changing wheels (tyres and rims), ensure that these are recommended by CITROËN.



If this warning light comes on, accompanied by an audible signal and a message on the display, it indicates a malfunction of the ABS which could result in a loss of control of the vehicle on braking.



If this warning light comes on, together with the brake and STOP warning lights, accompanied by an audible signal and a message on the display, it indicates a malfunction of the electronic brake force distribution which could result in a loss of control of the vehicle on braking.

Stop immediately.

In both cases, contact a CITROËN dealer.

EMERGENCY BRAKING ASSISTANCE SYSTEM (EBA)

In an emergency, this system enables the optimum braking pressure to be reached more quickly, press the pedal firmly without releasing it.

It is triggered by the speed at which the brake pedal is activated.

This alters the resistance of the brake pedal under your foot.

To prolong the operation of the emergency braking assistance system: keep your foot on the brake pedal.



TRACTION CONTROL (ASR) AND DYNAMIC STABILITY CONTROL (ESP)

These systems are linked and complement the ABS.

The ASR system is very useful for maintaining optimum drive and avoiding losses of control of the vehicle on acceleration.

The system optimises drive to prevent the wheels skidding, by acting on the brakes of the drive wheels and on the engine. It also allows the directional stability of the vehicle to be improved on acceleration.

Use the ESP to hold your course without attempting to countersteer.

If there is a variation between the trajectory followed by the vehicle and that required by the driver, the ESP system automatically acts on the engine and the brake of one or more wheels, in order to put the vehicle back on course.

Operation of the ASR and ESP systems



The luminous diode flashes when the ASR or ESP is triggered.

Disarming the ASR/ESP systems

In certain exceptional conditions (starting the vehicle when stuck in mud or snow, or on loose ground...), it could prove useful to disarm the ASR and ESP systems to make the wheels spin and regain grip.

- Press the button, located on the centre console.
- The indicator light comes on: the ASR and ESP systems no longer act.

They engage again:

- automatically above 30 mph (50 km/h),
- manually by pressing the button again.

Operating check



When a malfunction of the systems occurs, the indicator light comes on, accompanied by an audible signal and a message on the display.

Contact a CITROËN dealer to have the system checked.

The warning light may also come on if the tyres are under-inflated. Check the pressure of each tyre.

Good practice

The ASR/ESP systems offer increased safety during normal driving, but should not incite the driver to take risks or to drive at high speed.

The operation of these systems is ensured if the recommendations of the manufacturer regarding the wheels (tyres and rims), the braking components, the electronic components and the fitting and repair procedures within the CITROËN network are observed.

After an impact, have these systems checked by a CITROËN dealer.

Seat belts



SEAT BELTS

Height adjustment

Squeeze the control with the return and slide the assembly on the driver's seat side and on the individual passenger seat side.

Fastening

Pull the strap, then insert the tongue into the buckle.

Check that the seat belt is fastened correctly by pulling the strap.

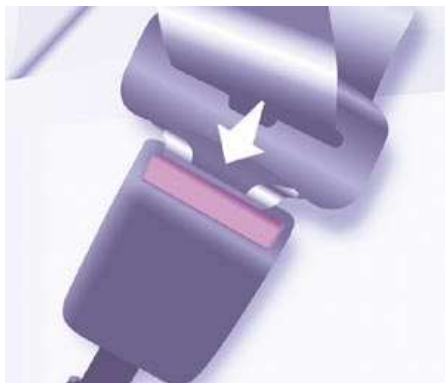

Unfastening

Press the red button.

Driver's seat belt not fastened warning light



When the vehicle is started, this warning light comes on if the driver has not fastened his seat belt.

Good practice

The driver must ensure that passengers use the seat belts correctly and that they are all strapped in securely before moving off.

Wherever you are seated in the vehicle, always fasten your seat belt, even for short journeys.

The seat belts are fitted with an inertia reel which automatically adjusts the length of the strap to your size.

Do not use accessories (clothes pegs, clips, safety pins, etc.) which permit a clearance with the seat belt straps.

Ensure that the seat belt is rolled up correctly after use.

After folding or moving a seat or a rear bench seat, ensure that the seat belt is rolled up correctly and that the buckle is ready to accommodate the tongue.

Depending on the nature and seriousness of any impact, the pretensioning device may be triggered before and independently of inflation of the air bags. It instantly tightens the seat belts against the body of the occupants.

Triggering of the pretensioners is accompanied by a slight discharge of harmless smoke and a noise, due to the activation of the pyrotechnic cartridge incorporated in the system.

The force limiter reduces the pressure of the seat belt against the body of the occupants.

The pretensioning seat belts are active when the ignition is switched on.

The inertia reels are fitted with a device which automatically locks the strap in the event of a collision or emergency braking or if the vehicle rolls over.

You can unfasten the seat belt by pressing the red button on the buckle. Guide the seat belt after unfastening.

The air bag warning light comes on if the pretensioners are triggered. Consult a CITROËN dealer.

In order to be effective, a seat belt must:

- restrain one person only,
- must not be twisted, check by pulling in front of you with an even movement,
- be tightened as close to the body as possible.

The upper part of the seat belt should be positioned in the hollow of the shoulder.

The lap part should be placed as low as possible on the pelvis.

Do not invert the seat belt buckles as they will not fulfil their role completely. If the seats are fitted with armrests, the lap part of the seat belt should always pass under the armrest.

Check that the seat belt is fastened correctly by pulling the strap firmly.

Recommendations for children:

- use a suitable child seat if the passenger is less than 12 years old or shorter than one metre fifty,
- never allow a child to travel on your lap, even with the seat belt fastened.

 For further information regarding child seats, refer to the "Children on board" section of chapter 4.

In accordance with current safety regulations, your CITROËN dealer guarantees all work or any checks, from testing to maintenance, on your seat belt equipment.

Have the seat belts checked regularly (even after a minor impact) by a CITROËN dealer: they must not show any signs of wear, cutting or fraying and they must not be transformed or modified.

 Clean the seat belt straps with soapy water or a textile cleaning product, sold by CITROËN dealers.

Front seat belts

The front seats are fitted with pretensioners and force limiters.

Rear seat belts (5 seat version)

The rear seats are fitted with three-point inertia reel seat belts.

Seat belts

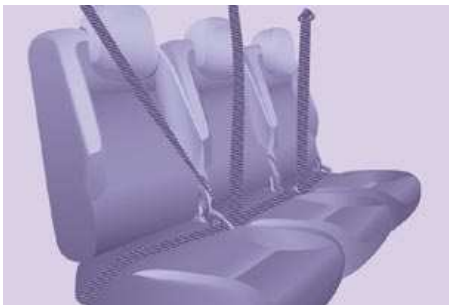

Rear seat belts (7 seat version)

In row 2

The three seats are fitted with three-point inertia reel seat belts. When folding the side seats or the seat backs to the table position, avoid trapping the strap of the centre seat belt.

When handling the side seats (removing/installing) or when accessing row 3, avoid hooking the centre seat belt.

Ensure that the centre seat belt is rolled up correctly in its strengthener on the roof.



In row 3

The two seats are fitted with three-point inertia reel seat belts.

Do not attach the seat belts to the stowing rings marked with a red cross, represented on the label.

Take care to hook the seat belts correctly on the rings provided for this purpose.

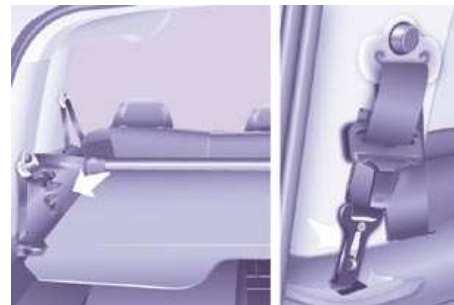

The row 3 seat belts which are not in use can be stored to clear the load space and make use of the load space cover easier.

Hook the snap hook in the location provided on the rear pillar trim.



AIR BAGS

The air bags have been designed to maximise the safety of the occupants in the event of a serious collision; they work in conjunction with the force limiting seat belts.

In the event of a serious collision, the electronic detectors record and analyse the front and side impacts suffered in the impact detection zones:

- in the event of a serious impact, the air bags inflate instantly and protect the occupants of the vehicle. Immediately after the impact, the air bags deflate rapidly, so that they do not hinder the visibility of the occupants nor their possible exit from the vehicle.

- in the event of a minor or rear impact and in certain roll-over conditions, the air bags will not be deployed; the seat belt alone is sufficient to provide maximum protection in these situations.

The seriousness of the collision depends on the nature of the obstacle and the speed of the vehicle at the moment of impact.

i Air bags only operate when the ignition is switched on.

This equipment only operates once. If a second impact occurs (during the same or a subsequent accident), the air bag will not operate.

The triggering of an air bag or air bags is accompanied by a slight discharge of harmless smoke and a noise, due to the activation of the pyrotechnic cartridge incorporated in the system.

This smoke is not harmful, but sensitive individuals may experience some irritation.

The noise of the detonation may result in a slight loss of hearing for a short time.



+ It is imperative that the passenger air bag is disarmed if a child seat is installed facing rearwards. Refer to the "Children on board" section of chapter 4.

Good practice

Sit in a normal upright position.

Wear a correctly adjusted seat belt.

Do not leave anything between the occupants and the air bags (a child, pet, object...). This could hamper the operation of the air bags or injure the occupants.

After an accident or if the vehicle has been stolen or broken into, have the air bag systems checked.

All work on the air bag system is strictly forbidden unless it is carried out by qualified personnel of the CITROËN network.

Even if all of the precautions mentioned are observed, a risk of injury or of minor burns to the head, chest or arms when an air bag is triggered cannot be ruled out. In fact, the bag inflates almost instantly (within a few milliseconds) then deflates within the same time discharging the hot gas via openings provided for this purpose.

Side air bags

Only put recommended covers on the seats. These will not hinder inflation of the side air bags. Consult a CITROËN dealer.

Do not fix or glue anything to the seat backs. This could cause injury to the chest or arms when the side air bag inflates.

Do not sit with the upper part of the body any nearer to the door than necessary.

Front air bags

Do not drive holding the steering wheel by its spokes or resting your hands on the centre part of the wheel.

Do not allow passengers to place their feet on the fascia, they risk serious injury if the air bag is triggered.

Smoke as little as possible as deployment of the air bags can cause burns or the risk of injury from a cigarette or pipe.

Never remove or pierce the steering wheel or hit it violently.

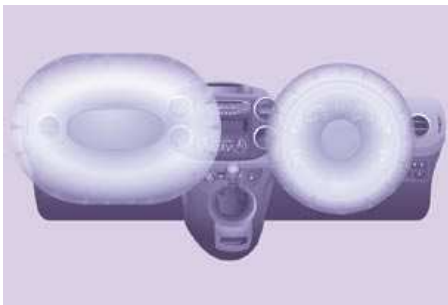

Front air bags

The front air bags are incorporated in the centre of the steering wheel for the driver and in the fascia for the front passenger.

Activation

They are deployed simultaneously, unless the passenger's front air bag has been disarmed, in the event of a serious front impact applied to all or part of the front impact zone **A** in the longitudinal centreline of the vehicle on a horizontal plane directed from the front towards the rear of the vehicle.

The front air bag inflates between the front occupant of the vehicle and the fascia to cushion his forward movement.



Disarming

The passenger's front air bag alone can be disarmed:

- **With the ignition switched off**, insert the key into the passenger air bag disarming switch,
- turn it to the off **"OFF"** position,
- then remove the key keeping the slot in this position.



The air bag warning light on the instrument panel is lit throughout the period of disarming.

 To ensure the safety of your child, it is essential to disarm the passenger air bag when you install a rear-facing child seat on the front passenger seat. Otherwise, the child would risk being killed or seriously injured if the air bag were to inflate.

Reactivation

In the **"OFF"** position, the passenger air bag will not be triggered in the event of an impact.

As soon as the child seat is removed, turn the air bag slot to the **"ON"** position to re-activate the air bag and thus ensure the safety of your passenger in the event of an impact.

Front air bag fault



If this warning light comes on, accompanied by an audible signal and a message on the display, consult a CITROËN dealer to have the system checked.



If the two air bag warning lights are lit continuously, do not install a rear-facing child seat. Consult a CITROËN dealer.



AIR BAGS

The air bags have been designed to maximise the safety of the occupants in the event of a serious collision; they work in conjunction with the force limiting seat belts.

In the event of a serious collision, the electronic detectors record and analyse the front and side impacts suffered in the impact detection zones:

- in the event of a serious impact, the air bags inflate instantly and protect the occupants of the vehicle. Immediately after the impact, the air bags deflate rapidly, so that they do not hinder the visibility of the occupants nor their possible exit from the vehicle.

- in the event of a minor or rear impact and in certain roll-over conditions, the air bags will not be deployed; the seat belt alone is sufficient to provide maximum protection in these situations.

The seriousness of the collision depends on the nature of the obstacle and the speed of the vehicle at the moment of impact.

Air bags

i Air bags only operate when the ignition is switched on.

This equipment only operates once. If a second impact occurs (during the same or a subsequent accident), the air bag will not operate.

The triggering of an air bag or air bags is accompanied by a slight discharge of harmless smoke and a noise, due to the activation of the pyrotechnic cartridge incorporated in the system.

This smoke is not harmful, but sensitive individuals may experience some irritation.

The noise of the detonation may result in a slight loss of hearing for a short time.



+ It is imperative that the passenger air bag is disarmed if a child seat is installed facing rearwards. Refer to the "Children on board" section of chapter 4.

Good practice

Sit in a normal upright position.

Wear a correctly adjusted seat belt.

Do not leave anything between the occupants and the air bags (a child, pet, object...). This could hamper the operation of the air bags or injure the occupants.

After an accident or if the vehicle has been stolen or broken into, have the air bag systems checked.

All work on the air bag system is strictly forbidden unless it is carried out by qualified personnel of the CITROËN network.

Even if all of the precautions mentioned are observed, a risk of injury or of minor burns to the head, chest or arms when an air bag is triggered cannot be ruled out. In fact, the bag inflates almost instantly (within a few milliseconds) then deflates within the same time discharging the hot gas via openings provided for this purpose.

Side air bags

Only put recommended covers on the seats. These will not hinder inflation of the side air bags. Consult a CITROËN dealer.

Do not fix or glue anything to the seat backs. This could cause injury to the chest or arms when the side air bag inflates.

Do not sit with the upper part of the body any nearer to the door than necessary.

Front air bags

Do not drive holding the steering wheel by its spokes or resting your hands on the centre part of the wheel.

Do not allow passengers to place their feet on the fascia, they risk serious injury if the air bag is triggered.

Smoke as little as possible as deployment of the air bags can cause burns or the risk of injury from a cigarette or pipe.

Never remove or pierce the steering wheel or hit it violently.



Side air bags

This is a system which protects the driver and front passenger in the event of a serious side impact in order to limit the risk of injury to the chest.

Each side air bag is incorporated in the front seat back frame, on the door side.

Activation

It is triggered unilaterally in the event of a serious side impact applied to all or part of the side impact zone **B**, perpendicular to the longitudinal centreline of the vehicle on a horizontal plane and directed from the outside towards the inside of the vehicle.

The side air bag inflates between the front occupant of the vehicle and the corresponding door trim pad.

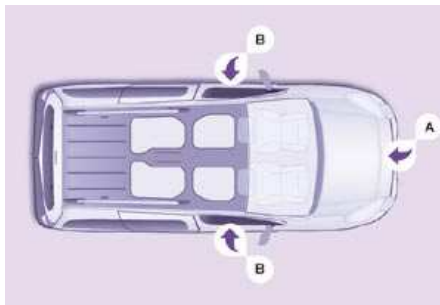

Impact detection zones

- A.** Front impact zone.
- B.** Side impact zone.



In the event of a minor impact or bump on the side of the vehicle or if the vehicle rolls over, the air bag may not be triggered.

Operating fault



If this warning light comes on on the instrument panel, accompanied by an audible signal and a message on the display, contact a

CITROËN dealer to have the system checked. The air bags may no longer be triggered in the event of a serious impact.

Curtain air bags

This is a system which protects the driver and passengers (with the exception of the centre seat of row 2) in the event of a serious side impact in order to limit the risk of head injuries.

Each curtain air bag is incorporated in the pillars and the upper part of the passenger compartment.

Activation

It is triggered at the same time as the corresponding side air bag in the event of a serious side impact applied to all or part of the side impact zone **B**, perpendicular to the longitudinal centreline of the vehicle on a horizontal plane and directed from the outside towards the inside of the vehicle.

The curtain air bag inflates between the front or rear occupant of the vehicle and the windows.

GENERAL POINTS RELATING TO CHILD SEATS

Although one of CITROËN's main criteria when designing your vehicle, the safety of your children also depends on you.

For maximum safety, please follow these precautions:

- all children under the age of 12 or less than one metre fifty tall must travel in approved child seats suited to their weight, on seats fitted with a seat belt or ISOFIX mountings.
- statistically, the safest seats in your vehicle for the transportation of children are the rear seats,
- a child weighing less than 9 kg must travel in the "rearwards-facing" position both in the front and in the rear,
- the passenger must not travel with a child on his lap.

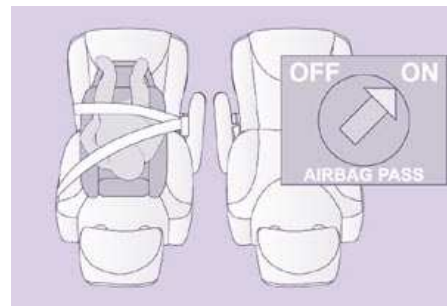
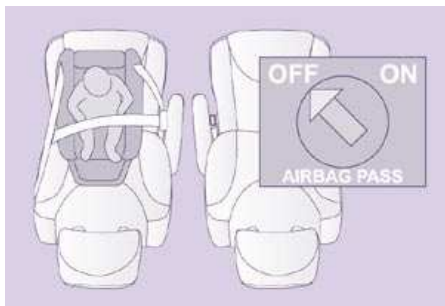

INSTALLING A CHILD SEAT USING A THREE POINT SEAT BELT

"Rearwards-facing"

Recommended on the rear seats up to the age of 2.

When a "rearwards-facing" child seat is installed on the front passenger seat, it is essential that the passenger air bag is disarmed. Otherwise, the child would risk being seriously injured or killed if the air bag were to inflate.

"Forwards-facing"

Recommended on the rear seats over the age of 2.

When a "forwards-facing" child seat is installed on the front passenger seat, leave the passenger air bag armed.

i The rules for transporting children are specific to each country. Consult the current legislation in your country.

Please consult the list of seats approved in your country. The isofix mountings, the rear seats, the passenger air bag and the disarming of this air bag depend on the version sold.



+ Refer to chapter 4, "Air bags" section.

i The child seats function and the passenger air bag disarming function are common to the entire CITROËN range.

If the passenger air bag is not disarmed, the installation of a "rearwards-facing" child seat in the front is strictly prohibited.

UNIVERSAL CHILD SEATS RECOMMENDED BY CITROËN

CITROËN offers a complete range of recommended child seats which are secured using a three point seat belt:

Group 0: from birth to 10 kg

Group 0+: from birth to 13 kg



L1

"ROMER Baby-Safe Plus"

Installed in the rear-facing position

Groups 1, 2 and 3: from 9 to 36 kg



L2

"KIDDY Life"

Use of the restraining cushion is compulsory for the transportation of young children (from 9 to 18 kg).

Groups 2 and 3: from 15 to 36 kg



L3

"RECARO Start"



L4



"KLIPPAN Optima"

From the age of 6 years (approximately 22 kg), the booster is used on its own.

L3: to install this seat in row 2, remove the head restraints.

INSTALLING CHILD SEATS ATTACHED USING THE SEAT BELT

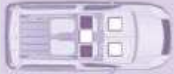
In accordance with European regulations, this table indicates the options for installing child seats secured using a seat belt and universally approved in accordance with the weight of the child and the seat in the vehicle.

Seat			Weight of the child and indicative age			
			Under 13 kg (groups 0 (a) and 0+) Up to approx 1 year	From 9 to 18 kg (group 1) 1 to 3 years approx	From 15 to 25 kg (group 2) 3 to 6 years approx	From 22 to 36 kg (group 3) 6 to 10 years approx
Row 1 (b)		Passenger seat	U	U	U	U
Row 2 (d) 5 and 7 seats)		Side seats	U	U	U	U
		Centre seat	U	U	U	U
Row 3 (c, d) (7 seats)			U	U	U	U

a: Group 0: from birth to 10 kg.

b: consult the legislation in force in your country before installing your child on this seat.

c: the seats in row 2 must be folded.

d: the head restraints of the seats in row 2 and row 3 must be removed for more secure fitting of the child seat.

U: seat suitable for the installation of a child seat secured using a seat belt and universally approved, "rear facing" and/or "forward facing".

ADVICE ON CHILD SEATS

The incorrect installation of a child seat in a vehicle compromises the child's protection in the event of an accident.

Remember to fasten the seat belts or the child seat harnesses **keeping the slack** in relation to the child's body **to a minimum**, even for short journeys.

For optimum installation of the "forward facing" child seat, ensure that the back of the child seat is in contact with the back of the vehicle's seat and that the head restraint does not cause any discomfort.

If the head restraint has to be removed, ensure that it is stored or attached securely to prevent it from being thrown around the vehicle in the event of sharp braking.

Children under the age of 10 must not travel in the "forward facing" position on the front passenger seat, unless the rear seats are already occupied by other children, cannot be used or are absent.

Disarm the passenger air bag when a "rear facing" child seat is installed on the front seat.

Otherwise, the child would risk being seriously injured or killed if the air bag were to inflate.

As a safety precaution, do not leave:

- one or more children alone and unsupervised in a vehicle,
- a child or an animal in a vehicle which is exposed to the sun, with the windows closed,
- the keys within reach of children inside the vehicle.

To prevent accidental opening of the doors, use the "Child Lock".

Take care not to open the rear windows by more than one third.

To protect young children from the rays of the sun, fit side blinds to the rear windows.

Installing a booster seat

The chest part of the seat belt must be positioned on the child's shoulder without touching the neck.

Ensure that the lap part of the seat belt passes correctly over the child's thighs. CITROËN recommends the use of a booster seat which has a back, fitted with a seat belt guide at shoulder level.

CHILD LOCK



This prevents opening of the side doors from the inside.

Manual mode

A label indicates the location of the child lock.

- Open fully past the point of resistance.
- Tilt the lever, located on the rear section of the door.

Electric mode



With the ignition on, press this button. The diode comes on.

Warning: this system is independent of the central locking control.

Always remove the ignition key when leaving the vehicle, even for a short time.

It is advisable to check the activation of the child lock each time the ignition is switched on.

In the event of a serious impact the electric child lock is deactivated automatically.



+ Refer to chapter 4, "Air bags" section.

i The child seats function and the passenger air bag disarming function are common to the entire CITROËN range.

If the passenger air bag is not disarmed, the installation of a "rearwards-facing" child seat in the front is strictly prohibited.

UNIVERSAL CHILD SEATS RECOMMENDED BY CITROËN

CITROËN offers a complete range of recommended child seats which are secured using a three point seat belt:

Group 0: from birth to 10 kg

Group 0+: from birth to 13 kg



L1

"ROMER Baby-Safe Plus"

Installed in the rear-facing position

Groups 1, 2 and 3: from 9 to 36 kg



L2

"KIDDY Life"

Use of the restraining cushion is compulsory for the transportation of young children (from 9 to 18 kg).

Groups 2 and 3: from 15 to 36 kg



L3

"RECARO Start"



L4

"KLIPPAN Optima"

From the age of 6 years (approximately 22 kg), the booster is used on its own.

L3: to install this seat in row 2, remove the head restraints.

ISOFIX CHILD SEAT RECOMMENDED BY AND APPROVED FOR YOUR VEHICLE**ISOFIX RÖMER Duo Plus** (size category **B1**)**Group 1: from 9 to 18 kg**

Installed in the forward facing position.
Fitted with an upper strap to be secured on the ISOFIX upper ring,
referred to as the TOP TETHER.
Three seat body angles: sitting, reclining, lying.

This child seat can also be used on seats which are not fitted with ISOFIX mountings.

In this case, it must be attached to the vehicle seat using the three point seat belt.

Follow the instructions for fitting the child seat given in the seat manufacturer's installation guide.

SUMMARY TABLE FOR THE INSTALLATION OF ISOFIX CHILD SEATS

In accordance with European regulations, this table indicates the options for the installation of ISOFIX child seats on the vehicle seats fitted with ISOFIX mountings.

In the case of the universal and semi-universal ISOFIX child seats, the child seat's ISOFIX size category, determined by a letter from **A** to **G**, is indicated on the child seat next to the ISOFIX logo.

		Weight of the child/indicative age									
Type of ISOFIX child seat		Less than 10 kg (group 0) Up to 6 months approx		Less than 10 kg (group 0) Less than 13 kg (group 0+) Up to 1 year approx			From 9 to 18 kg (group 1) From 1 to 3 years approx				
		Infant car seat		"rear facing"			"rear facing"		"forward facing"		
ISOFIX size category		F	G	C	D	E	C	D	A	B	B1
Row 1	Passenger seat	X		IL-SU			IL-SU		IUF, IL-SU		
Row 2 (5 and 7* seats)	Side seats	IL-SU		IL-SU			IL-SU		IUF, IL-SU		
	Centre seat	Non-isofix seat									
Row 3 (7 seats)	Seats	Non-isofix seats									

IUF: Seat suitable for the installation of an ISOFIX child seat of the universal category. "Forward facing" ISOFIX child seats fitted with an upper strap secured to the upper ring of the vehicle seats equipped with ISOFIX mountings.

IL-SU: Seat suitable for the installation of a semi-universal ISOFIX child seat. "Forward facing" ISOFIX child seats.

X: Seat not suitable for the installation of an ISOFIX seat of the size category indicated.

* In the 7 seat version, the **three** seats of row 2 must be present when child seats are installed.

"ISOFIX" MOUNTINGS

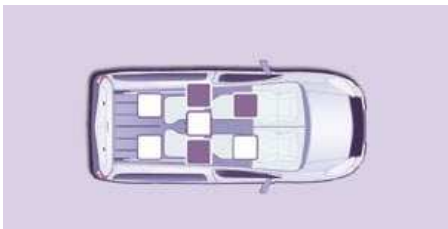

Your vehicle has been approved in accordance with the new ISOFIX regulation.

The mountings comprise three rings for each seat:

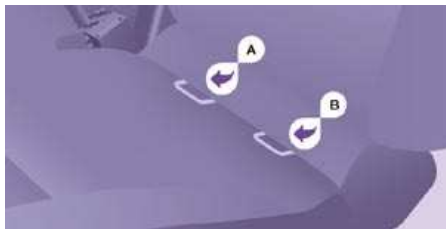

- two front rings **A** and **B**, located between the vehicle seat back and cushion,



- a rear ring **C**, located on the back of the vehicle's seat back, for securing the upper strap referred to as the TOP TETHER.



Isfix seat with support

ISOFIX child seats fitted with a support (which rests on the floor of your vehicle) cannot be installed on rear seats equipped with floor boxes (under the footwells).

This ISOFIX mounting system guarantees you fast, reliable and safe fitting of the child seat in your vehicle on the side seats.

The ISOFIX child seats are fitted with two locks which are secured easily on the two front rings.

Some also have an upper strap which is attached to the rear ring **C**.



To attach this strap, raise the vehicle seat's head restraint then pass the hook between its rods.

Then fix the hook on the rear ring and tighten the upper strap.

ADVICE ON CHILD SEATS

The incorrect installation of a child seat in a vehicle compromises the child's protection in the event of an accident.

Remember to fasten the seat belts or the child seat harnesses **keeping the slack** in relation to the child's body **to a minimum**, even for short journeys.

For optimum installation of the "forward facing" child seat, ensure that the back of the child seat is in contact with the back of the vehicle's seat and that the head restraint does not cause any discomfort.

If the head restraint has to be removed, ensure that it is stored or attached securely to prevent it from being thrown around the vehicle in the event of sharp braking.

Children under the age of 10 must not travel in the "forward facing" position on the front passenger seat, unless the rear seats are already occupied by other children, cannot be used or are absent.

Disarm the passenger air bag when a "rear facing" child seat is installed on the front seat.

Otherwise, the child would risk being seriously injured or killed if the air bag were to inflate.

As a safety precaution, do not leave:

- one or more children alone and unsupervised in a vehicle,
- a child or an animal in a vehicle which is exposed to the sun, with the windows closed,
- the keys within reach of children inside the vehicle.

To prevent accidental opening of the doors, use the "Child Lock".

Take care not to open the rear windows by more than one third.

To protect young children from the rays of the sun, fit side blinds to the rear windows.

Installing a booster seat

The chest part of the seat belt must be positioned on the child's shoulder without touching the neck.

Ensure that the lap part of the seat belt passes correctly over the child's thighs. CITROËN recommends the use of a booster seat which has a back, fitted with a seat belt guide at shoulder level.

CHILD LOCK



This prevents opening of the side doors from the inside.

Manual mode

A label indicates the location of the child lock.

- Open fully past the point of resistance.
- Tilt the lever, located on the rear section of the door.

Electric mode



With the ignition on, press this button. The diode comes on.

Warning: this system is independent of the central locking control.

Always remove the ignition key when leaving the vehicle, even for a short time.

It is advisable to check the activation of the child lock each time the ignition is switched on.

In the event of a serious impact the electric child lock is deactivated automatically.



TOWING A TRAILER, CARAVAN, BOAT, ETC...

+ For more information about weights, refer to the administrative documents (V5 registration document, ...) or to the "Weights" section of chapter 8.

Driving advice

A towed vehicle must free wheel: gearbox in neutral.

Distribution of loads

Distribute the load in the trailer so that the heaviest objects are as close as possible to the axle and the nose weight is close to the maximum authorised without, however, exceeding it.

Cooling

Towing a trailer on a slope increases the coolant temperature.

As the fan is electrically controlled, its cooling capacity is not dependent on the engine speed.

On the contrary, use a high gear to lower the engine speed and reduce your speed.

In all cases, pay attention to the coolant temperature.

Good Practice

In certain cases of particularly arduous use (towing the maximum load up a steep slope in high temperatures), the engine automatically limits its power. In this case, the automatic cutting off of the air conditioning allows the engine power to be recovered.



If the coolant temperature warning light comes on, stop the vehicle and switch off the engine as soon as possible.

 See the "Levels" section of chapter 6.

 Tyres: check the tyre pressures of the towing vehicle (see the "Identification features" section of chapter 8) and of the trailer, observing the recommended pressure.

Brakes

Towing increases the braking distance. Drive at a moderate speed, change down early and brake gradually.

Side wind

Sensitivity to side wind is increased. Drive smoothly and at a moderate speed.

ABS/ESP

The ABS or ESP systems only control the vehicle, not the trailer or caravan.

Rear parking assistance

The assistance does not function while the vehicle is towing.

Towbar

We recommend the use of original CITROËN towbars and their harnesses, which have been tested and approved from the design stage of your vehicle, and that you entrust the fitting of this equipment to a CITROËN dealer.

If this equipment is not fitted by a CITROËN dealer, it is imperative that it is fitted using the electrical pre-equipment installed at the rear of the vehicle and in accordance with the manufacturer's instructions.

In accordance with the general instructions a reminder of which has been given above, we draw your attention to the risk linked with fitting a towbar or electrical accessory not recommended by CITROËN. Fitting such equipment could result in the failure of your vehicle's electronic system. Please contact a CITROËN dealer for information before fitting this type of equipment.

Equipment



OTHER ACCESSORIES

These accessories and parts, having been tested and approved for reliability and safety, are all adapted to your vehicle. A wide range of recommended accessories and original parts is offered.

A further range is also available, structured around comfort, leisure and maintenance:

Anti-theft alarm, window engraving, first aid kit, high visibility jacket, rear parking assistance, warning triangle, ...

Seat covers compatible with air bags for the front seats, bench seat, rubber mats, carpet mats, snow chains, blinds, tailgate bicycle carrier, ...

To prevent the mat from becoming caught under the pedals:

- ensure that the mat and its fixings are positioned correctly,
- never fit one mat on top of another.

Audio equipment, hands-free kit, speakers, CD changer, navigation, ...

Regardless of the audio and telematic equipment offered on the market, the technical constraints linked with the fitting of equipment of these product groups mean that the special features of the equipment and its compatibility with the capacities of your vehicle's standard equipment must be taken into account. Please ask a CITROËN dealer for further information before fitting such equipment.

Maximum weights on bars

- ModutopTransverse bars on longitudinal bars: 75 Kg (these bars are not compatible with the Modutop roof).

Installing radiocommunication transmitters

You are advised to contact a CITROËN dealer before installing accessory radiocommunication transmitters with external aerial on your vehicle.

The CITROËN network will inform you of the characteristics (frequency band, maximum output power, aerial position, specific conditions of installation) of the transmitters which can be fitted, in accordance with the Motor Vehicle Electromagnetic Compatibility Directive (2004/104/EC).

Front mud flaps, rear mud flaps, 15/17 inch alloy wheels, wheelarch trim, leather steering wheel, ...

Screenwash, interior and exterior cleaning and maintenance products, spare bulbs, ...

 The fitting of electrical equipment or accessories which are not recommended by CITROËN may result in a failure of your vehicle's electronic system. Please note this specific warning. You are advised to contact a dealer to be shown the range of recommended equipment or accessories.

Depending on the country in which the vehicle is sold, it is compulsory to have a high visibility jacket, warning triangle and spare bulbs available in the vehicle.

"Active Fleet Data" telematic unit

Connected directly to the heart of the vehicle (multiplexed network: "Full CAN"), the telematic unit, by means of a "ready to use" service, permits the sending in real time of information such as:

- distance travelled,
- distance remaining before the next service,
- warnings and faults (oil level, coolant level, oil temperature, coolant temperature, etc...).

This enables "Fleet" managers to optimise the monitoring and management of their professional vehicles.

Depending on country, contact a CITROËN dealer for further information.

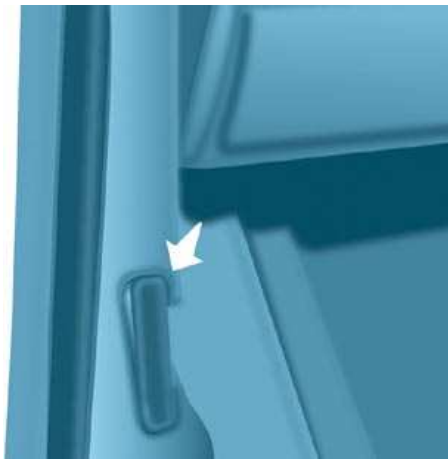

OPENING THE BONNET

On the inside

Pull the lever under the fascia panel towards you. The bonnet is unlocked.



On the outside

Raise the bonnet slightly by reaching in a flat hand, palm down, to make access to the lever easier. With this hand, push the lever to the left. Raise the bonnet.



Bonnet strut

Secure the strut in its location, identified by a sticker on the left-hand panel side of the vehicle, to hold the bonnet open.

Before closing the bonnet, put the strut back in its clip without using excessive force.

To close

Lower the bonnet and release it at the end of its travel. Check that the bonnet is locked.

Avoid manoeuvring the bonnet in strong winds.

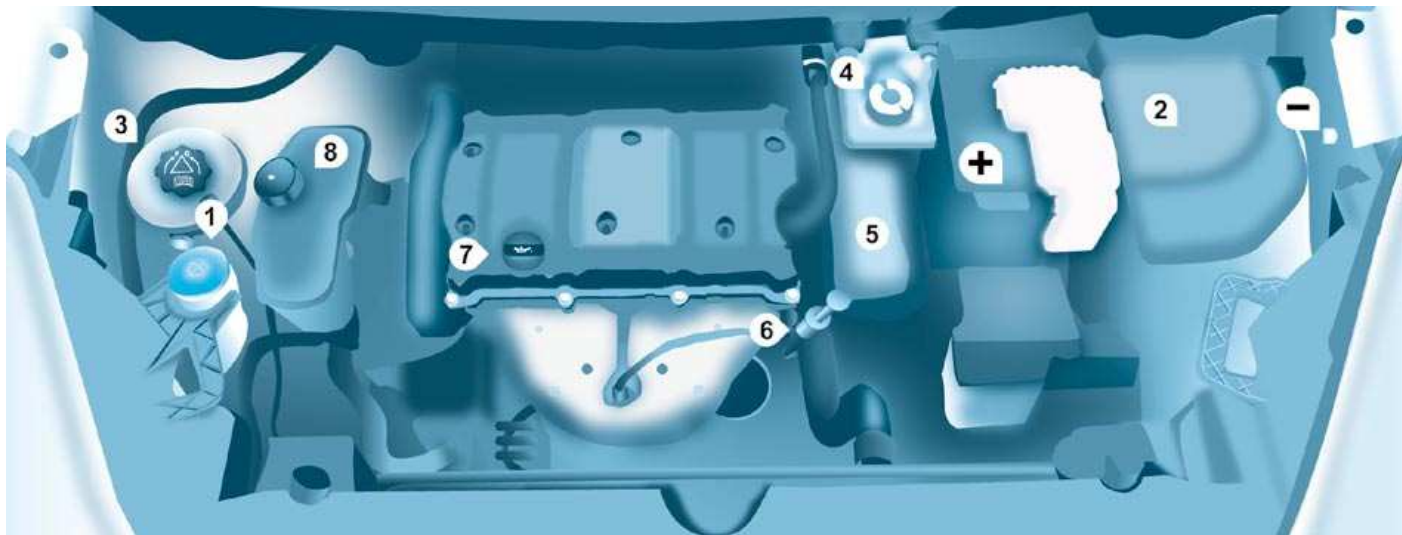

PETROL ENGINE

Take care when working under the bonnet.

- | | | |
|-------------------------------|--------------------------------------|------------------------------------|
| 1. Windscreen wash reservoir. | 4. Brake and clutch fluid reservoir. | 7. Engine oil filler cap. |
| 2. Fuse box. | 5. Air filter. | 8. Power steering fluid reservoir. |
| 3. Engine coolant reservoir. | 6. Dipstick. | |

i Battery connections:

- + Positive metal point.
- Negative metal point (earth).

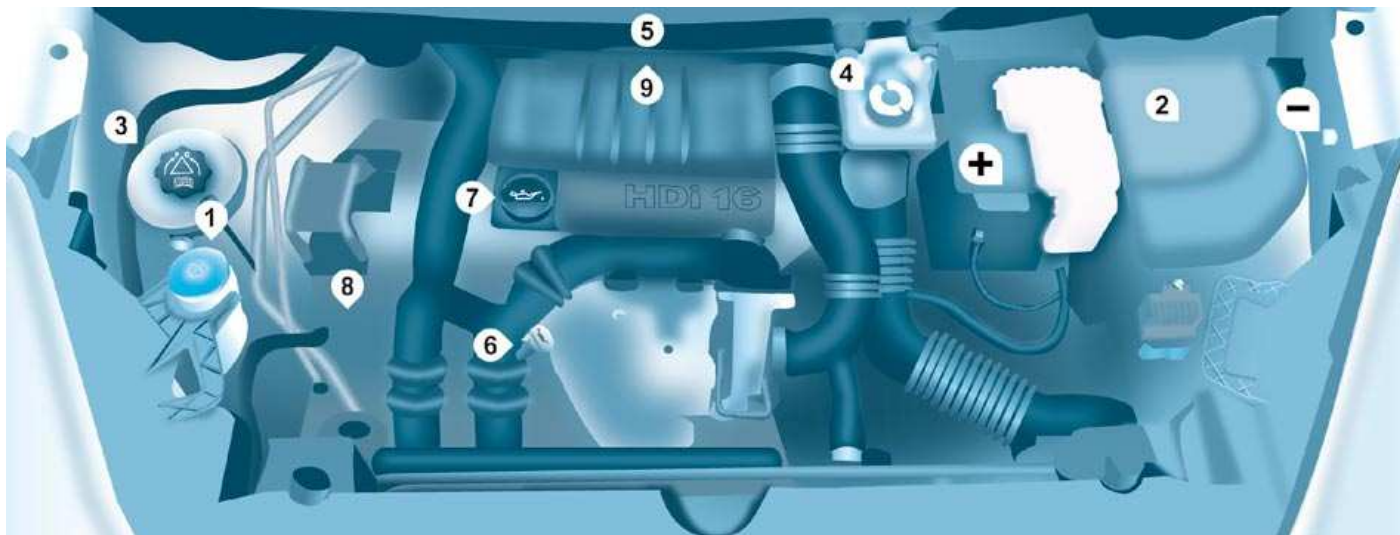

DIESEL ENGINE

Take care when working under the bonnet.

- | | | |
|-------------------------------|--------------------------------------|------------------------------------|
| 1. Windscreen wash reservoir. | 4. Brake and clutch fluid reservoir. | 7. Engine oil filler cap. |
| 2. Fuse box. | 5. Air filter. | 8. Power steering fluid reservoir. |
| 3. Engine coolant reservoir. | 6. Dipstick. | 9. Priming pump. |

i Battery connections:

- + Positive metal point.
- Negative metal point (earth).

Levels

LEVELS

i These regular maintenance operations will keep your vehicle in good running order. Consult the instructions at a CITROËN dealer or in the servicing booklet enclosed in the handbook pack.

👁 If you have to remove/refit the engine style cover, handle it with care to avoid damaging the fixing clips.

Oil level

Check the level regularly and top up between changes. The maximum consumption is 0.5 litre per 600 miles (1 000 km).

Check the level with the vehicle level, engine cold, using the dipstick.

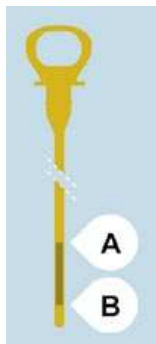

Dipstick

There are two marks on the dipstick:

A = maximum

If you fill past this mark, consult a CITROËN dealer.

B = minimum

Never allow the level to fall below this mark.

To maintain the reliability of engines and emission control systems, the use of additives in engine oil is prohibited.



Oil change

It is imperative that this is carried out at the intervals specified and the viscosity grade of the oil selected must fulfil the requirements in accordance with the manufacturer's servicing schedule. Consult the instructions at a CITROËN dealer.

Remove the dipstick before filling.

Check the level after filling (never exceed the max mark).

Screw the cap back onto the sump before closing the bonnet.

Viscosity selection

In all cases, the oil selected must meet the manufacturer's requirements.



Changing the brake fluid

The brake fluid must be changed at the intervals stated, according to the manufacturer's servicing schedule.

Use fluids recommended by the manufacturer, which fulfil DOT4 standards.

The level must be between the MIN and MAX marks on the reservoir.

If fluid has to be added frequently, this indicates a failure which must be checked by a CITROËN dealer as soon as possible.

Warning lights

+ Checking by means of the warning lights on the instrument panel is described in chapter 2, refer to the "Instruments and controls" section.

Cooling system

Only use the fluid recommended by the manufacturer.

Otherwise, you risk seriously damaging your engine.

When the engine is warm, the temperature of the coolant is controlled by the engine fan. As this fan can operate with the ignition key removed and because the cooling system is pressurised, wait for at least one hour after the engine has stopped before carrying out any work.

Slacken the cap by 1/4 of a turn to release the pressure to prevent any risk of scalding. When the pressure has dropped, remove the cap and top up the level with coolant.

If fluid has to be added frequently, this indicates a failure which must be checked by a CITROËN dealer as soon as possible.

Topping up

The level must be between the MIN and MAX marks on the expansion bottle. If more than 1 litre of fluid is required to top up the level, have the system checked by a CITROËN dealer.

Power steering fluid level

The vehicle must be parked on level ground with the engine cold. Unscrew the cap integrated with the gauge and check the level which must be between the MIN and MAX marks.

Windscreen wash and headlamp wash level

For best quality cleaning and for your safety, we would advise that you use products of the CITROËN range.

For optimum cleaning and to avoid freezing, this fluid must not be topped up or replaced with water.

Capacity of the screenwash reservoir: approximately 4.5 litres.

If your vehicle is fitted with headlamp washers, the capacity of the reservoir is 7.5 litres.



Diesel additive level (Diesel with particle emission filter)

The minimum level of this additive is indicated by lighting of the service warning light, accompanied by an audible signal and a message on the display.

When this occurs with the engine running it is due to the start of saturation of the particle emission filter (exceptionally prolonged urban type driving conditions: low speed, long traffic jams, ...).

In order to regenerate the filter, you are advised to drive at a speed higher than 40 mph (60 km/h) for at least five minutes as soon as possible, when traffic conditions permit (until the message disappears and the service warning light is switched off).

During regeneration of the particle emission filter, relay noise may be heard under the fascia.

If the message is still displayed and if the service warning light remains on, consult a CITROËN dealer.

Topping up

It is imperative that this additive is topped up by a CITROËN dealer without delay.

Used oil

Avoid prolonged contact of used oil with the skin.

Brake fluid is harmful to health and very corrosive.

Do not dispose of used oil, brake fluid or coolant into drains or into the ground but into the containers dedicated to this use at CITROËN dealer.

Checks

CHECKS

Battery

At the start of winter, have your battery checked by a CITROËN dealer.

Brake pads

Brake pad wear depends on the style of driving, in particular for vehicles which are used in town, over short distances. It may be necessary to check the thickness of the pads, even between services.

Unless there is a leak on the circuit, a drop in the brake fluid level indicates that the brake pads are worn.

Brake disc/drum wear status

For any information relating to checking the brake disc/drum wear status, consult a CITROËN dealer.

Handbrake

Where the handbrake travel is too great or there is a reduction in the performance of the system, the handbrake should be adjusted, even between services.

Have the system checked by a CITROËN dealer.



Carbon filter and passenger compartment filter

An access flap below the glove box permits replacement of the filters.

The carbon filter permits continuous and effective filtering of dust.

If the passenger compartment filter becomes clogged, this may reduce the performance of the air conditioning system and generate unpleasant odours.

We recommend the use of a combined passenger compartment filter. By means of its second special active filter, it contributes to the purification of the air breathed by the occupants and the cleanness of the passenger compartment (reduction of allergic symptoms, unpleasant odours and greasy deposits).

Refer to the servicing booklet to find out the replacement interval for these components.

Depending on the environment (dusty atmosphere...) and the use of the vehicle (urban driving...), change them twice as often if necessary.

Oil filter

Change the filter regularly in accordance with the servicing schedule.

Particle emission filter (Diesel)

It is imperative that particle emission filter maintenance is carried out by a CITROËN dealer.

On acceleration after the vehicle has been running for a prolonged period at very low speed or at idle, you may, in exceptional circumstances, notice the emission of water vapour at the exhaust. This water vapour does not have any adverse effect on vehicle handling or the environment.

Bleeding the water contained in the diesel filter



If this warning light comes on, bleed the filter. Otherwise bleed regularly each time the engine is drained.

To evacuate the water, unscrew the bleed screw located on the filter.

Operate until all of the water in the transparent pipe has been drained out then tighten the bleed screw.

HDi engines use advanced technology. All work requires a special qualification which is guaranteed by a CITROËN dealer.

According to country.

Manual gearbox

Have the level checked in accordance with the manufacturer's servicing schedule.

i To check the main levels and certain components, in accordance with the manufacturer's servicing schedule, refer to the pages of the servicing booklet which correspond to your vehicle's engine.

👁 Only use products recommended by CITROËN or products of equivalent quality and characteristics.

In order to optimise the operation of units as important as the braking circuit, CITROËN selects and offers specific products.

In order to avoid damaging the electrical units, high pressure washing to clean the engine compartment is strictly prohibited.

Fuel



The fuel tank must be filled **with the engine off**.

- Open the fuel filler flap.
- Insert the key, then turn it a quarter turn.
- Remove the cap and hook it onto the clip located on the inside of the flap.

A label affixed to the inside of the flap reminds you of the type of fuel to be used.

When filling the fuel tank, do not continue after the 3rd cut-off of the nozzle. This could cause malfunctions.

The capacity of the fuel tank is approximately 60 litres.

- After filling the fuel tank, lock the cap and close the flap.

FILLING WITH FUEL

Low fuel level



When the minimum fuel tank level is reached, this warning light comes on.

You then have **approximately 8 litres** of fuel remaining. Fill up without delay to avoid running out of fuel.

When filling with fuel, a mechanical system prevents opening of the left-hand side door. When the fuel filler flap is open, ensure that no one tries to slide this door.

Once the flap has been closed, the sliding side door may jam, push the door to close it then open it.

FUEL CIRCUIT DISARMED

In a serious collision, a mechanism automatically prevents fuel from reaching the engine.



The flashing of this warning light is accompanied by a message on the display.

Check that there is no odour or leakage of fuel outside the vehicle and re-establish the fuel supply:

- switch off the ignition (STOP position).
- remove the key.
- put the key back in the ignition.
- switch on the ignition and start.

DIESEL REPRIMING PUMP

If you should run out of fuel, it is necessary to re-prime the circuit:

- fill the fuel tank with at least five litres of diesel,
- squeeze and release the manual re-priming pump, under the bonnet under the protective cover,
- operate the starter until the engine starts.



Refer to the "Under the bonnet" section of chapter 6.

BATTERY

To charge the battery using a battery charger

- Disconnect the battery,
- Follow the instructions for use given by the battery charger manufacturer,
- Reconnect starting with the negative (-) terminal,
- Check that the terminals and connectors are clean. If they are covered with sulphate (white or greenish deposit), disconnect them and clean them.

To start the vehicle from another battery

- Connect the red cable to the positive (+) terminals of the two batteries,
- Connect one end of the green or black cable to the negative (-) terminal of the slave battery,
- Connect the other end of the green or black cable to an earth point on the broken down vehicle as far as possible from the battery,
- Operate the starter, let the engine run,
- Wait for the engine to return to idle, then disconnect the cables.

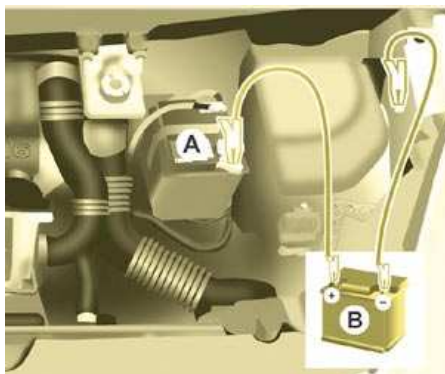

i It is advisable to disconnect the battery if the vehicle is not to be used for a period of more than one month.

Before disconnecting the battery, you must wait for 2 minutes after switching off the ignition.

Never disconnect a terminal when the engine is running.

Never charge a battery without first disconnecting the terminals.

After every reconnection of the battery, switch on the ignition and wait 1 minute before starting to allow the electronic systems to be initialised. If slight difficulties are experienced after this, please contact a CITROËN dealer.

After changing bulbs, wait approximately 3 minutes before reconnecting the battery.

ECONOMY MODE

After the engine has stopped, with the key in the ignition position, certain functions (windscreen wiper, electric windows, courtesy lights, audio equipment, etc.) can only be used for a cumulative duration of thirty minutes, to prevent discharging of the battery.

Once the thirty minutes are over, the active functions are put on standby and the battery warning light flashes accompanied by a message on the display.

To resume the use of these functions immediately, start the engine and let it run for a few minutes.

The time available will then be double the time for which the engine was left running. However, this time will always be between five and thirty minutes.

A flat battery will prevent the engine from starting.

Changing a wheel

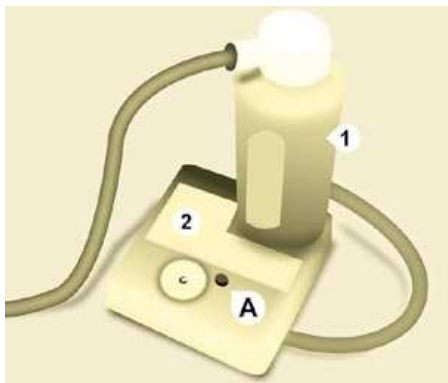

PUNCTURE REPAIR KIT

The kit is located in one of the two storage compartments located under the front seats.

It is a complete system consisting of a compressor and an incorporated filling product.

Using the kit

1. Tick the deflated wheel on the speed limitation sticker then affix the sticker to the vehicle's steering wheel to remind you that a wheel is in temporary use.
2. Clip the bottle **1** on the compressor **2**.
3. Connect the bottle **1** to the valve of the tyre to be repaired.
4. Take care to unwind the compressor pipe before connecting it to the bottle.
5. Connect the power lead to one of the vehicle's 12 V sockets.
6. Switch on the compressor by pressing button **A** until the tyre pressure reaches 2.0 bars. If this pressure cannot be reached, the tyre cannot be repaired.
7. Remove and store the compressor.
8. Drive immediately, for a few miles (kilometres), at reduced speed, to fill the puncture.
9. Adjust the pressure using the compressor in accordance with the recommendation for the vehicle and check that the leak is filled correctly (no further loss of pressure).
10. Drive at reduced speed (50 mph [80 km/h]). The tyre must be examined and repaired by a professional as soon as possible.

After use, the bottle can be stored in a plastic bag, supplied in the kit, to avoid staining your vehicle with traces of fluid.



Warning: the bottle of gel contains ethylene-glycol, a product which is harmful if swallowed and which causes irritation to the eyes.

Keep it out of reach of children.

After use, do not discard the bottle into the environment, take it to a CITROËN dealer or to an organisation responsible for its collection.

This kit is available from CITROËN dealers.



CHANGING A WHEEL

1. PARKING THE VEHICLE

- It is imperative that you ensure that the occupants get out of the vehicle and wait in a safe location.
- If possible, park the vehicle on level, stable and non-slippery ground.
- Apply the handbrake, switch off the ignition and engage first or reverse gear.

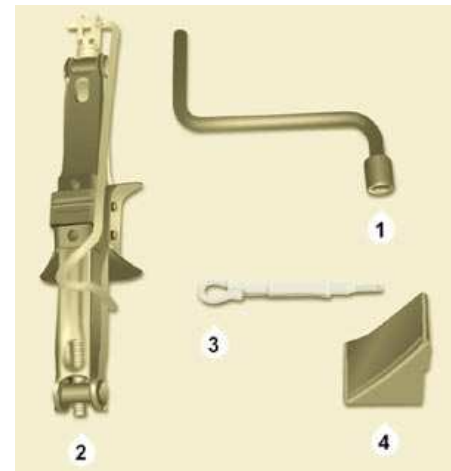
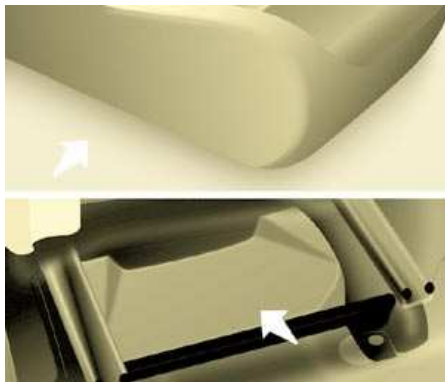

2. TOOLS

- Open the lid of the storage compartment located under the seat on the right-hand side. If necessary, move the seat forward to access the storage compartment from the rear.
- Unscrew the nut then take out the jack and the wheelbrace.

1. Wheelbrace.
2. Jack.
3. Alloy wheel embellisher remover.
4. Chock.

The jack and the tool kit are specific to your vehicle. Do not use them for other purposes.

- If available, place a chock under the wheel diagonally opposite the one to be changed.

If the vehicle is fitted with a towbar; it is sometimes necessary to raise the vehicle slightly to make it easier to remove the spare wheel from its carrier.

On certain types of ground and/or if considerable loads are being transported, call a CITROËN dealer.

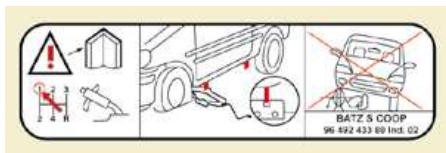

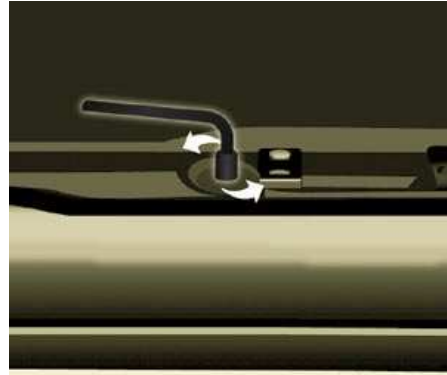

3. SPARE WHEEL

- Open the rear doors to gain access to the spare wheel.
- Unscrew the bolt using the wheelbrace until the carrier is lowered fully.
- Detach the carrier from the hook and place the spare wheel near the wheel to be changed.



4. OPERATING PROCEDURE

- Remove the trim pulling it using the embellisher remover.
- Loosen the wheel bolts and start unscrewing them.
- Place the jack in contact with the locating point provided, the one which is closest to the wheel to be changed. Ensure that the jack is straight and that the base of the jack is fully in contact with the ground.
- Extend the jack to lift the wheel clear of the ground.
- Resume and complete the unscrewing of the wheel bolts.
- Remove the bolts and remove the wheel.

Do not extend the jack until you have started unscrewing the bolts on the wheel to be changed and have placed the chock under the wheel diagonally opposite.

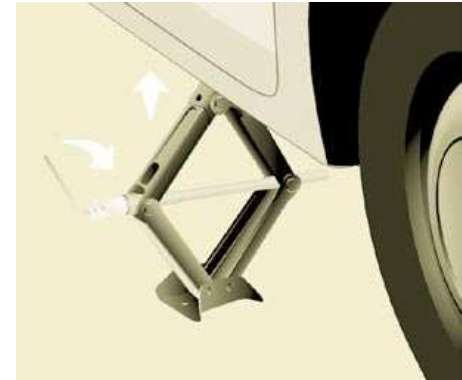

Anti-theft bolts

If your vehicle is fitted with wheels with alloy rims:

- Each wheel has an anti-theft bolt.
- These bolts can be loosened using your anti-theft socket (given to you in delivery of your vehicle) and the wheelbrace.

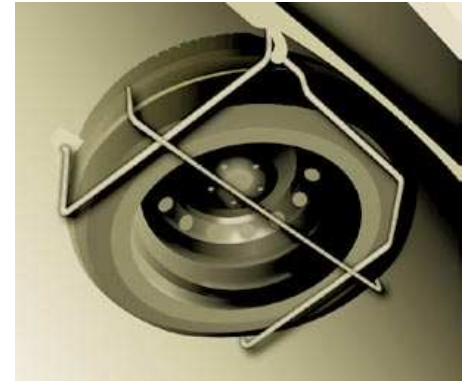
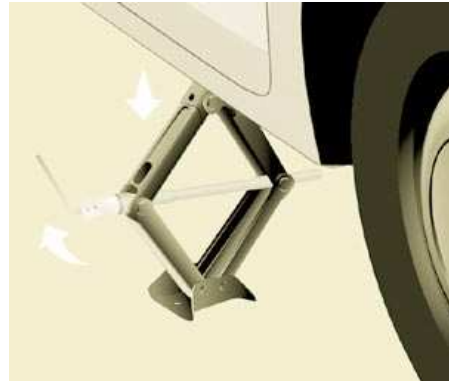

5. FITTING THE SPARE WHEEL

- Position the wheel on the hub and start tightening the bolts by hand.
- Carry out an initial tightening of the bolts using the wheelbrace.
- Lower the vehicle completely by folding the jack, then remove the jack.
- Tighten the bolts again using the wheelbrace, tighten them fully without forcing them.
- Place the wheel to be repaired in the carrier.
- Secure the carrier on the hook then raise the carrier using the bolt and the wheelbrace.



Never go underneath a vehicle that is supported only by a jack (use a ramp). Never use a screwdriver in place of the wheelbrace.

6. REFITTING THE REPAIRED WHEEL

The wheel is refitted as described in step 5, not forgetting to refit the wheel trim.

+ Refer to the "Identification features" section of chapter 8 to locate the tyre label.

+ Refer to the "Instruments and controls" section of chapter 2, "Tyre under-inflation detection" part, for recommendations after changing a wheel fitted with a tyre under-inflation detection sensor.

i The spare wheel is not designed to be used over long distances. Have the tightening of the bolts and the tyre pressure checked by a CITROËN dealer as soon as possible. Also, have the original wheel repaired and refitted by a CITROËN dealer as soon as possible.



REMOVABLE SNOW SCREEN

According to country, the removable snow screen is installed on the lower part of the front bumper to prevent the accumulation of snow at the radiator cooling fan.

i Do not forget to remove the snow screen when the exterior temperature is higher than 10 °C (no risk of snowfall) and when towing.

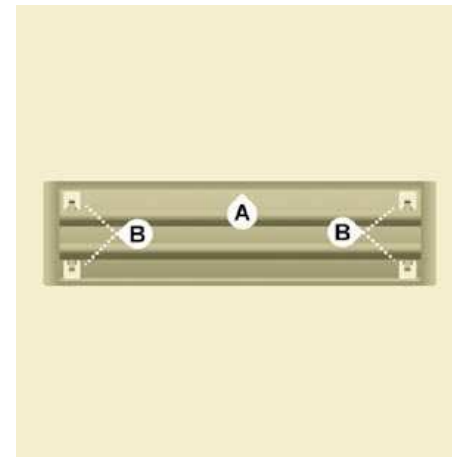

FITTING

- Offer up the snow screen facing its centring pin **A** on the front bumper.
- Put it in place by pressing at each clip **B** located in the four corners.

REMOVAL

- Pass a screwdriver into the hole located near each of the clips.
- Use the screwdriver as a lever to unclip the four clips **B** in turn.

6. REFITTING THE REPAIRED WHEEL

The wheel is refitted as described in step 5, not forgetting to refit the wheel trim.

+ Refer to the "Identification features" section of chapter 8 to locate the tyre label.

+ Refer to the "Instruments and controls" section of chapter 2, "Tyre under-inflation detection" part, for recommendations after changing a wheel fitted with a tyre under-inflation detection sensor.

i The spare wheel is not designed to be used over long distances. Have the tightening of the bolts and the tyre pressure checked by a CITROËN dealer as soon as possible. Also, have the original wheel repaired and refitted by a CITROËN dealer as soon as possible.



REMOVABLE SNOW SCREEN

According to country, the removable snow screen is installed on the lower part of the front bumper to prevent the accumulation of snow at the radiator cooling fan.

i Do not forget to remove the snow screen when the exterior temperature is higher than 10 °C (no risk of snowfall) and when towing.

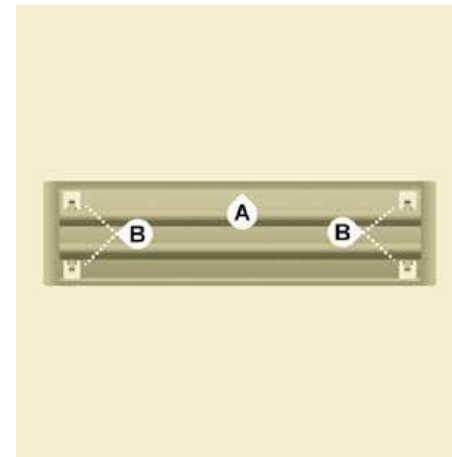

FITTING

- Offer up the snow screen facing its centring pin **A** on the front bumper.
- Put it in place by pressing at each clip **B** located in the four corners.

REMOVAL

- Pass a screwdriver into the hole located near each of the clips.
- Use the screwdriver as a lever to unclip the four clips **B** in turn.

Changing a bulb

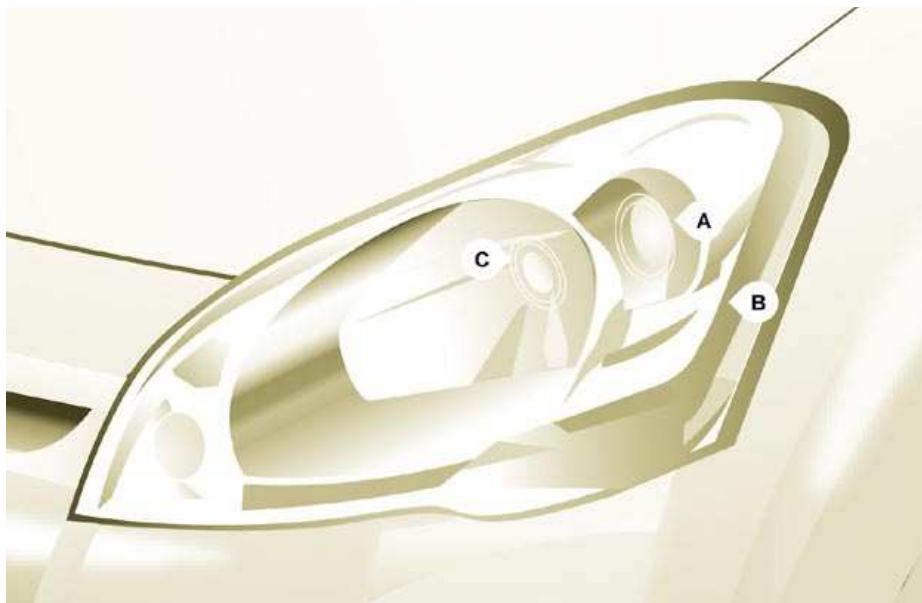

CHANGING A BULB

Open the bonnet. To access the bulbs, reach behind the headlamp unit. Carry out the operations in reverse order to refit each bulb and check that the bonnet is closed securely.

 Halogen bulbs must be changed with the headlamp off. Wait a few minutes (risk of serious burns). Do not touch the bulb directly with your fingers, use lint-free cloths. It is normal for condensation to form inside the headlamps. Regular use of the vehicle eliminates this misting.

The bulbs must be changed with the ignition off or with the battery disconnected. Wait approximately 3 minutes after changing the bulb before reconnecting the battery. Check that the lights operate correctly after each operation.

High pressure washing

 When using this type of washing on stubborn dirt, do not persist on the headlamps, the lights and their surround to avoid damaging their coating and their seal.

Types of bulb

Various types of bulb are installed on your vehicle. To remove them:

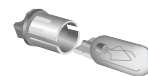

Type A

Entirely glass bulb: pull gently as it is fitted by pressure.

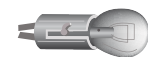

Type B

Bayonet bulb: press on the bulb then turn it anticlockwise.



Type C

Halogen bulb: release the retaining spring from its housing.



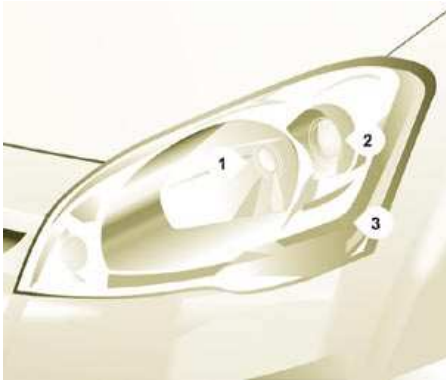

FRONT LIGHTS

1. Dipped headlamps/Main beam headlamps

Type C, H4 - 55 W

- Remove the centre cover by pulling the flexible rubber tab.
- Disconnect the electrical connector.
- Release the retaining tab.
- Change the bulb taking care to align the metal part with the grooves on the light.
- Reposition the retaining tab.
- Ensure that the cover is refitted correctly over its entire periphery to guarantee sealing.

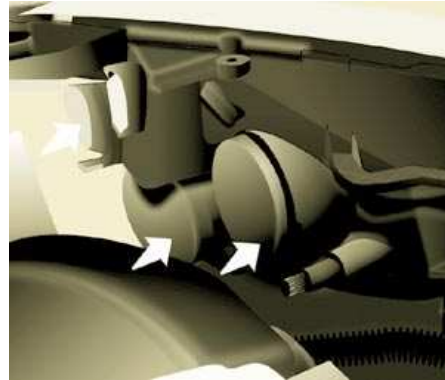

2. Side lights

Type A, W 5 W - 5 W

- Remove the cover by pulling the flexible rubber tab.
- Remove the bulb holder fitted by pressure by pulling the connector.
- Change the bulb.
- Ensure that the cover is refitted correctly over its entire periphery to guarantee sealing.

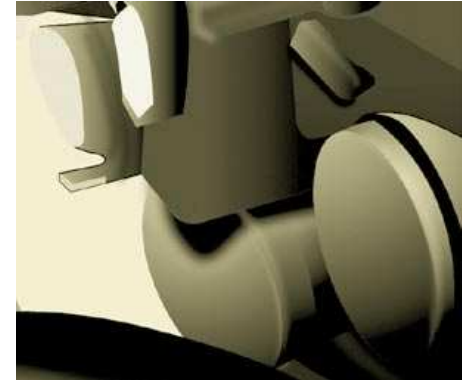

3. Direction indicators

Type B, PY 21 W - 21 W (amber)

- Remove the cover by pulling the flexible rubber tab.
- Turn the bulb holder a quarter turn anticlockwise.
- Remove the bulb by pressing it lightly while turning it anticlockwise.
- Change the bulb.
- Ensure that the cover is refitted correctly over its entire periphery to guarantee sealing.

Changing a bulb

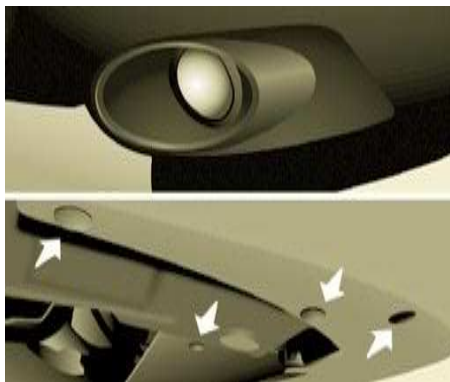

4. Fog lamps

Type C, H1 - 55 W

- Remove the fog lamp by removing the bolt, which can be accessed via the hole provided for this purpose in the bumper, using a Torx® 30 screwdriver.
- Remove the three mud guard fixing clips, located below the bumper.
- Move the mud guard upwards.
- Unclip the fog lamp by squeezing the clip to release it.
- Remove the fog lamp from the outside.
- Turn the yellow cover a 1/4 turn to open.
- Separate the clips which secure the base of bulb on each side to release the bulb.
- Remove the bulb by pulling, keeping it straight.
- Insert the new bulb, re-tighten the clips around the base of the bulb and carry out the operations in reverse order to put the light unit and the bumper back in position.



SIDE REPEATER

Type A, WY 5 W (amber)

- Push the repeater towards the rear and disengage it by pulling the front.
- Consult a CITROËN dealer to obtain a new repeater which is a fully moulded part.
- To refit, engage the repeater towards the rear and bring it towards the front.



Front/Rear

COURTESY LIGHTS

Type A, 12 V 5 W - 5 W

- Unclip the lens by sliding a screwdriver in the slots on each side of the courtesy light.
- Pull the bulb and change it.
- Clip the lens in its housing and ensure that it is secured correctly.

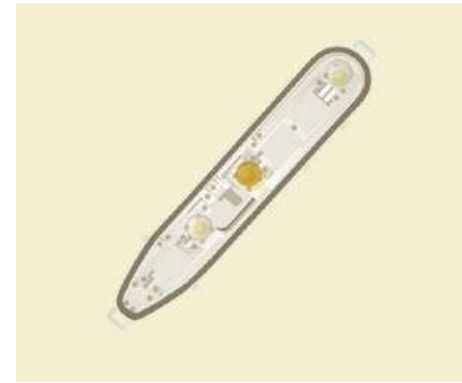
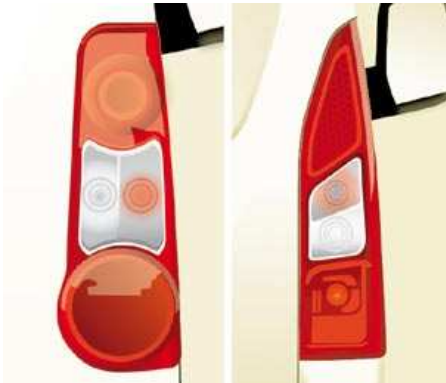

REAR LIGHTS

For further information concerning the bulbs, refer to the "Types of bulb".

1. Brake lights/side lights

Type B, P21/5 W - 21/5 W

2. Direction indicators

Type B, PY 21 W - 21 W (amber)

3. Reversing lights

Type B, P21 W - 21 W

4. Fog lamps

Type B, P21 W - 21 W

- Identify the faulty bulb then open the rear doors to 180°. Refer to the "Accesses" section of chapter 2.
- Remove the two fixing bolts using the screwdriver stored in the tool kit under the right-hand seat.
- Pull the light unit from the outside.
- Holding the light, disconnect the electrical connector.

- Move aside the 4 tabs then extract the bulb holder.
- Remove the faulty bulb by pressing it lightly while turning it anticlockwise.
- Change the bulb.

When removing the light unit:

- with tailgate, pull the light unit towards the centre of the vehicle,
- with hinged doors, pull the light unit towards you.

i When refitting, take care to reposition the tabs and the supply wire correctly to avoid trapping the wire.

After changing the rear direction indicator bulb, the reinitialisation time is more than approximately 2 minutes.

High pressure washing



When using this type of washing on stubborn dirt, do not persist on the headlamps, the lights and their surround to avoid damaging their coating and their seal.

Changing a bulb

142

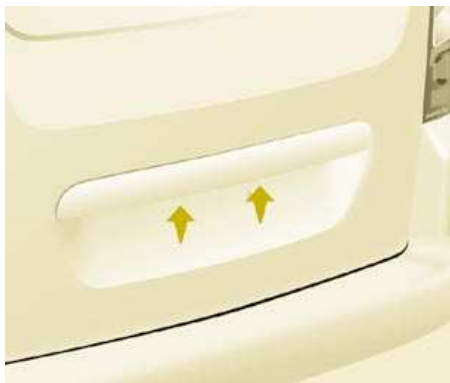

NUMBER PLATE LIGHTS

Type A, W 5 W - 5 W

With tailgate

- Move aside the plastic lens using a screwdriver.
- Change the bulb.
- Replace the plastic lens and press on it.

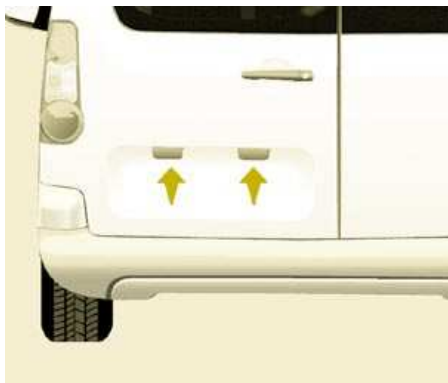

With hinged doors

- Unclip the interior trim.
- Disconnect the connector by moving aside its tab.
- Turn the bulb holder a quarter turn anticlockwise.
- Change the bulb.
- Put the bulb holder back in place and reconnect the connector.
- Put the trim back in place.

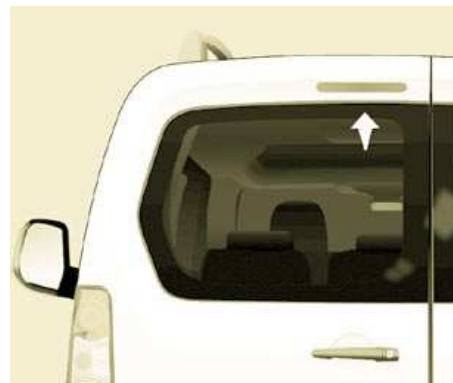

THIRD BRAKE LIGHT

Type A, W 16 W - 16 W

- Unscrew the two nuts.
- Push the pins.
- If necessary, disconnect the connector to remove the light.
- Change the bulb.

CHANGING A FUSE

The fuse boxes are placed:

- in the lower part of the fascia on the left-hand side (behind the cover),
- under the bonnet (near the battery).

The indications communicated are only those fuses which can be changed by the user using the pliers and the spare fuses, located behind the fascia storage compartment on the right-hand side. For any other work, visit a CITROËN dealer.

i For professionals: for complete information concerning the fuses and relays, consult the "Methods" diagram via the Network.

CITROËN will not accept responsibility for the cost incurred in repairing your vehicle or for rectifying the malfunctions resulting from the installation of accessories not supplied and not recommended by the CITROËN network and not installed in accordance with its instructions, in particular when the combined consumption of all of the additional equipment connected exceeds 10 milliamperes.



Removing and fitting a fuse

Before replacing a fuse, the cause of the incident must be found and rectified.

- Use the pliers.

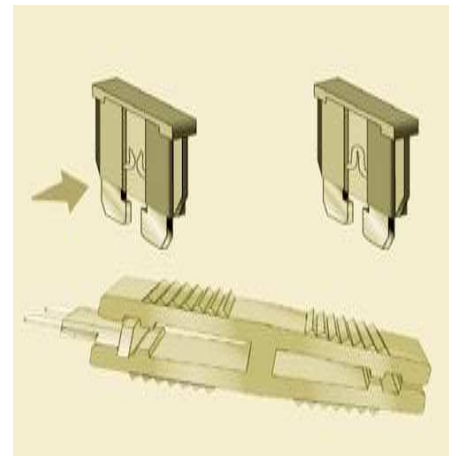

Always replace a faulty fuse with a fuse of the same rating.

Changing a fuse

FASCIA FUSES

Tilt the cover to gain access to the fuses.

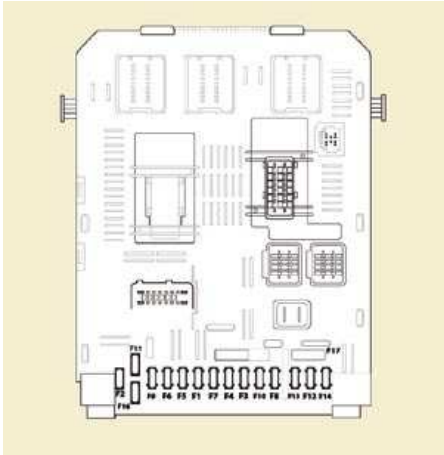

Fuses F	Amperes A	Allocation
1	15	Rear wiper
2	-	Spare
3	5	Air bag
4	10	Air conditioning, diagnostic socket, mirror control, headlamp beam
5	30	Electric windows
6	30	Locks
7	5	Rear courtesy light, front map reading light, roof console
8	20	Audio equipment, CD changer, display, tyre under-inflation detection, alarm and siren
9	30	Front and rear 12 V socket
10	15	Central column
11	15	Low current ignition switch
12	15	Rain and brightness sensor, air bag
13	5	Instrument panel
14	15	Parking assistance, automatic air conditioning controls, hands-free kit
15	30	Locks
16	-	Spare
17	40	Rear screen/mirrors de-icing

PASSENGER COMPARTMENT FUSES

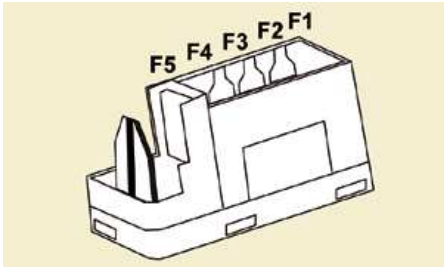

Fuses F	Amperes A	Allocation
1	-	Spare
2	20	Heated seats
3	-	Spare
4	15	Folding mirrors relay
5	15	Refrigeration equipment socket relay

Changing a fuse

FUSES UNDER THE BONNET

After opening the bonnet, unclip and tilt the corresponding box to gain access to the fuses.

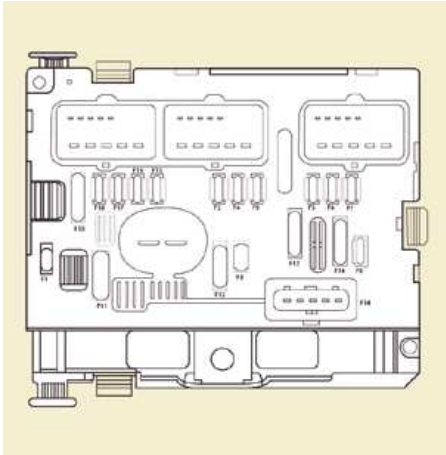

Fuses F	Amperes A	Allocation
1	20	Engine management
2	15	Horn
3	10	Front and rear wash-wipe pump
4	20	Headlamp wash pump
5	15	Engine components
6	10	Steering wheel angle sensor, ESP
7	10	Brake switch, clutch switch
8	25	Starter
9	10	Headlamp beam motor, parc management unit
10	30	Engine components
11	40	Spare
12	30	Wipers
13	40	Built-in systems interface
14	30	Pump
15	10	Right-hand main beam headlamp
16	10	Left-hand main beam headlamp
17	15	Right-hand dipped headlamp
18	15	Left-hand dipped headlamp



CHANGING A WINDSCREEN WIPER BLADE

Placing the wiper blades in the special position

- Less than a minute after switching off the ignition, press the wipers stalk downwards to position the wiper blades along the windscreen uprights (special position).

Changing a front wiper blade

- Lift the wiper arm.
- Unclip the blade and remove it.
- Fit the new blade.
- Push back the wiper arm.

To return the windscreen wipers to their normal position, switch on the ignition and operate the wipers stalk.

Changing the rear wiper blade

- Lift the wiper arm, then unclip the blade and remove it.
- Fit the new blade and push back the wiper arm.

Having your vehicle towed

148

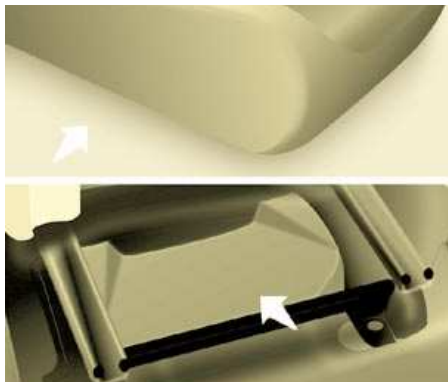

BEING TOWED

The towing eye is stored in the tool kit, located under the right-hand seat.

Without lifting (4 wheels on the road)

You should always use a towbar.



From the front

- Unclip the cover by pressing the bottom part.
- Screw in the removable towing eye until it locks.

From the rear

- Unclip the cover using a coin or the flat part of the towing eye,
- Screw in the removable towing eye until it locks.

Lifting (2 wheels on the road only)

It is preferable to raise the vehicle using professional lifting equipment.



- i** When towing with the engine switched off, there is no braking or steering assistance.

Vehicles fitted with a manual gearbox (diesel version)

In the case of vehicles fitted with a manual gearbox, the gear lever must be in the neutral position, failure to observe this special condition may result in damage to certain braking components and the absence of braking assistance when the engine is started again.



DIMENSIONS (MM)

L	Overall length		4 380
H	Overall height		1 801 - 1 862
A	Wheelbase		2 728
B	Front overhang		925
C	Rear overhang		727
D	Width over panels:	without mirrors	1 810
		with mirrors	2 112
E	Width of front tracks		1 505 - 1 507
F	Width of rear tracks		1 554 - 1 556
-	Length of the loading surface to the seat	Row 2	990
		Row 2, seat fully folded	1 343
		With front passenger seat folded	3 000

Dimensions

152

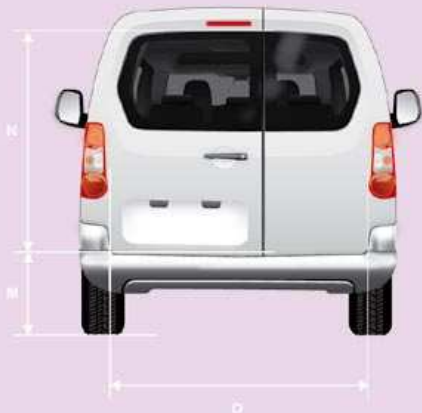

		REAR DOORS (mm)		
M	Max threshold with 205/65 R15 tyre and tailgate trim	582		
		Hinged doors		Tailgate
		Small	Large	
N	Useful opening height (under panel)	1 118		1 313
O	Width	495	543	1 582



		SLIDING SIDE DOORS (mm)
P	Useful height	1 009
Q	Useful width	650
-	Height under raised tailgate	1 892

Weights

WEIGHTS AND TOWED LOADS (KG)

General points

For further information, consult your registration certificate.

In each country, it is imperative that the towed loads authorised by local legislation are complied with. To find out your vehicle's towing capacities and its gross train weight, consult a CITROËN dealer.

The speed of a towing vehicle must not exceed 60 mph (100 km/h) (comply with the legislation in force in your country).

The braked towed weight with load transfer can be increased, on condition that the equivalent of this load is removed from the vehicle so that the GTW is not exceeded. Warning: towing using a lightly loaded towing vehicle may have an adverse effect on its road holding.

The GTW and towed load values indicated are valid up to a maximum altitude of 1 000 metres; the towed load mentioned must be reduced by 10 % for each additional 1 000 metres.

High exterior temperatures may result in a reduction in the performance of the vehicle in order to protect the engine; when the exterior temperature is higher than 37 °C, limit the towed weight.

The kerb weight is equal to the weight without load + driver (75 kg) + fuel tank filled to 90 %.

GTW: gross train weight

GVW: gross vehicle weight

MOM: kerb weight

CVA: vertical load on the towbar

Weights						Model codes		
Number of seats	Engine	GTW	GVW	MOM	CVA combi	Body type	Engine code	Gearbox
5	1.6 Petrol 90	2 925	2 025	1 472	50	7J	NFR	C
	1.6 Petrol 110	3 025	2 025	1 502	55		NFU	
	1.6 HDi 75	2 940	2 040	1 482	50		9HT	
	1.6 HDi 92	3 040	2 040	1 482	55		9HX	
	1.6 HDi 92 PEF	3 065	2 065	1 504	55		9HZ	
	1.6 HDi 110 PEF	3 065	2 065	1 504	55		9HV	
7	1.6 Petrol 110	3 025	2 150	1 588	70		NFU	
	1.6 HDi 92	3 040	2 170	1 599	70		9HX	
	1.6 HDi 92 PEF	3 065	2 190	1 614	70		9HZ	
	1.6 HDi 110 PEF	3 065	2 190	1 614	70		9HV	

ENGINES AND GEARBOX

	Petrol		Diesel			
	NFR	NFU	9HT	9HX	9HZ	9HV
TVV						
Name	1.6 Petrol	1.6 Petrol	1.6 HDi	1.6 HDi	1.6 HDi PEF	1.6 HDi PEF
Power (hp)	90	110	75	92	92	110
EU standard maximum power (kW/DIN)	66	80	55	66	66	80
Engine speed (rpm)	6 000	5 800	3 500	4 000	4 000	4 000
Cubic capacity (cm ³)	1 587	1 587	1 560	1 560	1 560	1 560
Gearbox - manual	5	5	5	5	5	5
Bore x stroke (mm)	78.5 x 82	78.5 x 82	75 x 88.3	75 x 88.3	75 x 88.3	75 x 88.3
EU standard max torque (Nm)	132	147	185	215	215	240
Max power engine speed (rpm)	2 500	4 000	1 750	1 750	1 750	1 750
Fuel	Unleaded		Diesel			
Particle emission filter	-	-	-	-	Yes	Yes
Catalytic converter	Yes	Yes	Yes	Yes	Yes	Yes

Diesel - Petrol engines

156

	FUEL CONSUMPTION					
	Petrol		Diesel			
TVV	NFR	NFU	9HT	9HX	9HZ	9HV
Name	1.6 Petrol	1.6 Petrol	1.6 HDi	1.6 HDi	1.6 HDi PEF	1.6 HDi PEF
Power(hp)	90	110	75	92	92	110
Urban mpg (l/100 km)	26.2 (10.8)	26.2 (10.8)	40.4 (7.0)	40.4 (7.0)	41.5 (6.8)	41.5 (6.8)
Extra-urban mpg (l/100 km)	41.5 (6.8)	41.5 (6.8)	56.5 (5.0)	56.5 (5.0)	57.6 (4.9)	57.6 (4.9)
Mixed mpg (l/100 km)	34.4 (8.2)	34.4 (8.2)	49.6 (5.7)	49.6 (5.7)	50.4 (5.6)	50.4 (5.6)
Emission of CO ₂ by mass (g/km)	195	195	150	150	147	147

Consumption values correct at time of printing. These consumption values were established in accordance with Directive 80/1268/CEE. They may vary depending on the style of driving, traffic conditions, weather conditions, the load in the vehicle, the maintenance of the vehicle and the use of the accessories.

Quality of the fuel used for petrol engines

The petrol engines are perfectly compatible with E5 type petrol biofuels (containing 5 % ethanol), conforming to European standard EN 228.

E85 type fuels (containing up to 85 % ethanol) are reserved exclusively for vehicles marketed for the use of this type of fuel (BioFlex vehicles). The quality of the ethanol must comply with European standard EN 15376.

For Brazil only, special vehicles are marketed to run on fuels containing up to 100 % ethanol (type E100).

Quality of the fuel used for Diesel engines

The Diesel engines are perfectly compatible with biofuels which conform to current and future European standards (diesel fuel which complies with standard EN 590 mixed with a biofuel which complies with standard EN 14214) which can be distributed at the pumps (possible incorporation of 0 to 7 % Fatty Acid Methyl Ester).

The use of any other type of (bio) fuel (vegetable or animal oils, domestic fuel...) is strictly prohibited (risk of damage to the engine and fuel circuit).

Identification features



IDENTIFICATION FEATURES

A. Manufacturer's plate.

B. Serial number.

This is engraved on the front right wheelarch.

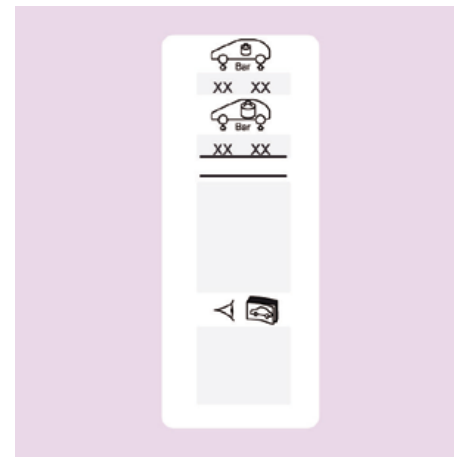

C. Tyres and paint colour reference.

The label **C**, on the front door gives:

- the wheel and tyre sizes,
- the brands of tyres approved by the manufacturer,
- the tyre pressures (the tyre pressure must be checked when the tyre is cold, at least once a month),
- the paint colour reference.

Audio system

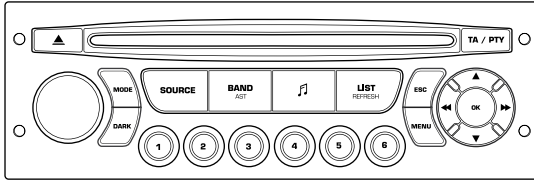

The audio system is coded in such a way that it will only operate in your vehicle. If it is to be installed in another vehicle, contact a CITROËN dealer for configuration of the system.



For safety reasons, the driver must carry out operations which require prolonged attention while the vehicle is stationary.
When the engine is off, and in order to prevent discharging of the battery, the audio system may switch off after a few minutes.

CONTENTS

- **01 First steps** pg. 9.2
- **02 General menu** pg. 9.3
- **03 Audio** pg. 9.4
- **04 USB Player** pg. 9.7
- **05 Bluetooth functions** pg. 9.10
- **06 Control short-cuts** pg. 9.12
- **07 Configuration** pg. 9.13
- **08 Display flow chart** pg. 9.14
- **Frequently asked questions** pg. 9.16

01 FIRST STEPS



1. On/Off and volume adjustment.
2. CD eject.
3. Selection of the display on the screen from the modes: Audio (AUDIO), Trip Computer (TRIP) and Telephone (TEL) functions.
4. Selection of the source: radio, audio CD/MP3 CD, CD changer, USB, Jack connection, Streaming.
5. Selection of the FM1, FM2, FMast and AM wavebands.
6. Setting the audio options: front/rear balance, left/right balance, loudness, sound ambiances.
7. Displaying of the list of local stations, of the tracks on the CD or of the MP3 directories.
8. Abandon current operation.
9. TA (Traffic Announcement) function on/off. Long press: access to the PTY (Types of radio programme) mode.
10. Confirmation.
11. Automatic search for a lower/higher frequency. Selection of previous/next CD, MP3 or USB track.
12. Selection of a lower/higher radio frequency. Selection of the previous/next CD. Selection of the previous/next MP3 directory. Selection of the previous/next USB equipment directory/genre/artist/playlist.
13. Displaying of the general menu.
14. Buttons 1 to 6:
Selection of a stored radio station.
Selection of a CD in the CD changer.
Long press: storing of a station.
15. The DARK button changes the display on the screen to improve driving comfort at night.
1st press: lighting of the top banner only.
2nd press: displaying of a black screen.
3rd press: return to the standard display.

GENERAL MENU 02

AUDIO FUNCTIONS:
radio, CD, USB, options.

TELEPHONE:
Bluetooth, pairing, call
management and transmission of
.mp3 files.

> MONOCHROME SCREEN C



TRIP COMPUTER: entering distance,
warnings, status of functions.

PERSONALISATION-CONFIGURATION:
vehicle parameters, display, languages.

> MONOCHROME SCREEN A



For a detailed global view of the
menus available, refer to the
"Display flow charts" section of
this chapter.

03 AUDIO



The external environment (hills, buildings, tunnels, basement car parks) may block reception, including in RDS mode. This is a normal effect of the way in which radio waves are transmitted and does not indicate any failure of the audio equipment.

RADIO SELECTING A STATION

1



Press the SOURCE button several times in succession and select the radio.



2



Press the BAND AST button to select a waveband: FM1, FM2, FMast, AM.



3



Briefly press one of the buttons to carry out an automatic search of the radio stations.

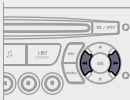

4



Press one of the buttons to carry out a manual search of the radio stations.

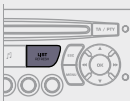





Press the LIST REFRESH button to display the list of stations received locally (30 stations maximum). To update this list, press for more than two seconds.

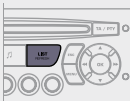

RDS

1



Press the MENU button.

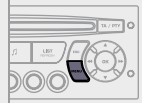

2

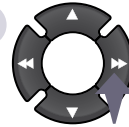

Select AUDIO FUNCTIONS then press OK.

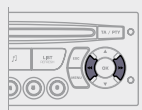

3

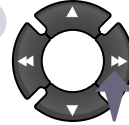

Select the FM WAVEBAND PREFERENCES function then press OK.

FM WAVEBAND PREFERENCES

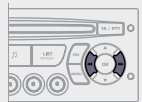

4

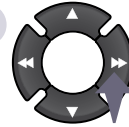

Select ACTIVATE FREQUENCY FOLLOWING (RDS) then press OK. RDS appears on the display.

ACTIVATE FREQUENCY FOLLOWING (RDS)

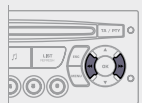

!

The RDS, if displayed, enables you to continue listening to the same station by automatic retuning to alternative frequencies. However, in certain conditions, coverage of an RDS station may not be assured throughout the country as radio stations do not cover 100 % of the territory. This explains the loss of reception of the station during a journey.

CD PLAYING A CD



Insert circular compact discs only.
Some anti-pirating systems, on original discs or CDs copied using a personal recorder, may cause faults which are no reflection on the quality of the original player.
Without pressing the EJECT button, insert a CD in the player, play begins automatically.

1



To play a disc which has already been inserted, press the SOURCE button several times in succession and select CD.

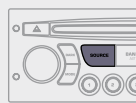

2



Press one of the buttons to select a track on the CD.
Press the LIST REFRESH button to display the list of tracks on the CD.
Press and hold one of the buttons for fast forward or rewind play.

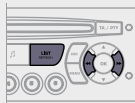

MP3 CD PLAYING AN MP3 COMPILATION



Insert an MP3 compilation in the player.
The audio equipment searches for all of the music tracks, which may take anything between a few seconds and several tens of seconds, before play begins.



On a single disc, the CD player can read up to 255 MP3 files spread over 8 directory levels. However, it is advisable to keep to a limit of two levels to reduce the access time before the CD is played. While the CD is being played, the directory flow chart is not followed. All of the files are displayed on a single level.

1



To play a disc which has already been inserted, press the SOURCE button several times in succession and select CD.

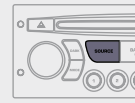

2



Press one of the buttons to select a track on the CD.
Press the LIST REFRESH button to display the list of directories of the MP3 compilation.
Press and hold one of the buttons for fast forward or rewind play.

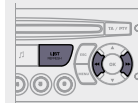

MP3 CD INFORMATION AND ADVICE



The MP3 format, an abbreviation of MPEG 1.2 & 2.5 Audio Layer 3, is an audio compression standard which permits the recording of several tens of music files on a single disc. The playing and displaying of an MP3 compilation may depend on the recording programme and/or the parameters used.



In order to be able to play a recorded CDR or CDRW, when recording select standards ISO 9660 level 1.2 or Joliet.

If the disc is recorded in another format, it may not be played correctly.

It is recommended that the same recording standard is always used for an individual disc, with as low a speed as possible for optimum sound quality.

In the particular case of a multi-session CD, the Joliet standard is recommended.



The audio equipment will only play files with the extension ".mp3". No other type of file (.wma, .mp4...) can be played.



It is advisable to restrict file names to 20 characters without using special characters (e.g.: " " ? ; ù) to avoid any playing or displaying problems.

AUDIO/MP3 CD CHANGER* PLAYING A CD

1

Insert the CDs in a multislot changer one by one.

On a single slot changer, press LOAD, select the number of the CD, then insert the CD or press and hold LOAD and insert the CDs one by one.



Press the SOURCE button several times in succession and select CD CHANGER.



2

Press one of the buttons on the numeric keypad to select the corresponding CD.

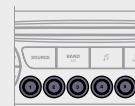

3

Press one of the buttons to select a track on the CD.
Press and hold one of the buttons for fast forwards or rewind play.

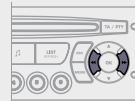

* According to availability on the vehicle.

04 USB Player

USING THE USB SOCKET

1

This unit consists of a USB port and a Jack socket. It reads audio file formats (.mp3, .ogg, .wma, .wav...) which are transmitted from portable equipment such as a digital player or a USB stick to your Audio system to be listened to via the vehicle's speakers.



2

USB stick (1.1, 1.2 and 2.0) or Ipod® of generation 5 or later:

- the playlists accepted are of the type m3u, .pls, .wpl.,
- the Ipod® lead is essential,
- navigation through the file base is by means of the steering wheel controls,
- the battery of the portable equipment can charge automatically.



3

Other Ipod® players of earlier generations and players using the MTP protocol:

- play via Jack-Jack lead only (not supplied),
- navigation through the file base is from the portable equipment.



The list of compatible equipment is available from CITROËN dealers.

CONNECTING A USB STICK

1

Connect the stick to the socket, directly or using a lead. If the audio equipment is switched on, the USB source is detected as soon as it is connected. Play begins automatically after a delay which depends on the capacity of the USB stick.

The file formats recognised are .mp3 (mpeg1 layer 3 only), .wma (standard 9 only), .wav and .ogg.



!

The system puts together playlists (temporary memory) created over a period which depends on the capacity of the USB equipment.

The other sources are available during this time.

The playlists are updated each time the ignition is switched off or each time a USB stick is connected.

When connecting for the first time, the tracks are classified by folder. When you reconnect, the classification system selected previously is retained.

04 USB Player

USING THE USB SOCKET

2

Press and hold LIST to display the different classifications. Select by Folder/Artist/Genre/Playlist, press OK to select the classification required, then press OK again to confirm.

OK



- by Folder: all folders containing audio files recognised on the peripheral device, classified in alphabetical order without following the flow chart.
- by Artist: all of the artist names defined in the ID3 Tags, classified in alphabetical order.
- by Genre: all of the genres defined in the ID3 Tags.
- by Playlist: in accordance with the playlists recorded on the USB device.

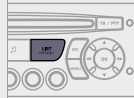

3



Press LIST briefly to display the list of Folders/Genres/Artists/Playlists on the USB equipment. Navigate through the list using the left/right and up/down buttons. Confirm the selection by pressing OK.

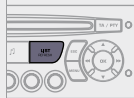

4



Press one of these buttons to gain access to the previous/next track on the classification list currently being played. Press and hold one of the buttons for fast forward or rewind play.

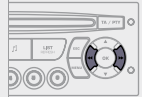

5



Press one of these buttons to gain access to the previous/next Genre, Folder, Artist or Playlist on the classification list currently being played.

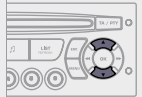

CONNECTING AN IPOD® VIA THE USB SOCKET

1

The lists available are Artist, Genre and Playlist (as defined on the iPod®). Selection and Navigation are described in steps 1 to 5 above.

!

Do not connect a hard disc or USB devices other than audio equipment to the USB socket. This could damage your installation.

USING THE AUXILIARY INPUT (AUX) JACK SOCKET OR RCA SOCKET (according to vehicle)



The auxiliary input, JACK and RCA, permits the connection of portable equipment (MP3 player...).



Do not connect a single piece of equipment via the USB socket and the JACK socket at the same time.

1

Connect the portable equipment (MP3 player...) to the JACK socket or to the audio sockets (white and red, RCA type) using a suitable cable (not supplied).



2



Press the SOURCE button several times in succession and select AUX.

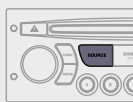

ADJUSTING THE VOLUME OF THE AUXILIARY SOURCE

1

First adjust the volume of your portable equipment.



2



Then adjust the volume of your audio equipment.



The controls are displayed and managed via the portable equipment.



05 BLUETOOTH FUNCTIONS



The services offered depend on the network, the SIM card and the compatibility of the Bluetooth equipment used.

Consult your telephone's manual and your operator to find out which services are available to you. A list of mobile telephones which offer the best range of services is available from the network. Consult a CITROËN dealer.

BLUETOOTH TELEPHONE SCREEN C



PAIRING A TELEPHONE



For safety reasons and because they require prolonged attention on the part of the driver, the operations for pairing of the Bluetooth mobile telephone with the Bluetooth hands-free system of your audio equipment must be carried out with the vehicle stationary and the ignition on.

1



Press the MENU button.

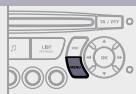

2

Activate the telephone's Bluetooth function.



3



In the menu, select:
- Bluetooth telephone function - Audio
- Bluetooth configuration
- Perform a Bluetooth search



4

A window is displayed with "Searching...".

5

The first 4 telephones recognised are displayed in this window.



The TELEPHONE menu permits access to the following functions in particular: Directory*, Call list, Pairing management.

* if your telephone hardware is fully compatible.

6

Select the telephone to be connected from the list. Only one telephone can be connected at a time.

7

A virtual keypad is displayed on the screen: enter a code with at least 4 digits. Confirm by pressing Ok.



8

A message is displayed on the screen of the telephone chosen: to accept the pairing, enter the same code on the telephone, then confirm by pressing Ok. If pairing fails, the number of attempts is not limited.



9

"Pairing of Name_telephone successful" appears on the screen.

10

The automatic connection authorised is only active after the telephone has been configured. The directory and the call list can be accessed after the synchronisation period.

The pairing can also be initiated from the telephone.

BLUETOOTH AUDIO STREAMING (AVAILABLE DURING THE YEAR)

RECEIVING A CALL

- 1 An incoming call is announced by a ring and a superimposed display on the multifunction screen.

- 2  Select the YES tab on the display using the buttons and confirm by pressing OK.

YES

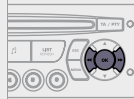

- 2  Press the steering wheel control OK to accept the call.



MAKING A CALL

- 1 From the Bluetooth telephone function Audio menu, select Manage the telephone call then call, call list or directory.

- 2 Press the end of the steering wheel control for more than two seconds to gain access to your directory.
Or
To dial a number, use your telephone's keypad, with the vehicle stationary.

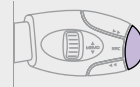

Wireless transmission of the telephone's music files via the audio equipment. The telephone must be able to manage the appropriate bluetooth profiles (Profiles A2DP/AVRCP).

- 1 Initiate the pairing between the telephone and the vehicle. This pairing can be initiated from the vehicle's telephone function menu or via the telephone's keypad. See steps 1 to 10 on the previous pages. During the pairing phase, the vehicle must be stationary with the key in the ignition.



- 2 Select the telephone to be connected from the telephone function menu.
The Audio system connects to a newly paired telephone automatically.



3

Activate the streaming source by pressing the SOURCE button*. The tracks to be played can be controlled as usual via the buttons on the Radio control panel and the steering wheel controls**. The contextual information can be displayed on the screen.

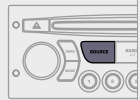

* In certain cases, playing of the Audio files must be initiated from the keypad.

** If the telephone supports the function.

06 CONTROL SHORT-CUTS

STEERING WHEEL CONTROLS

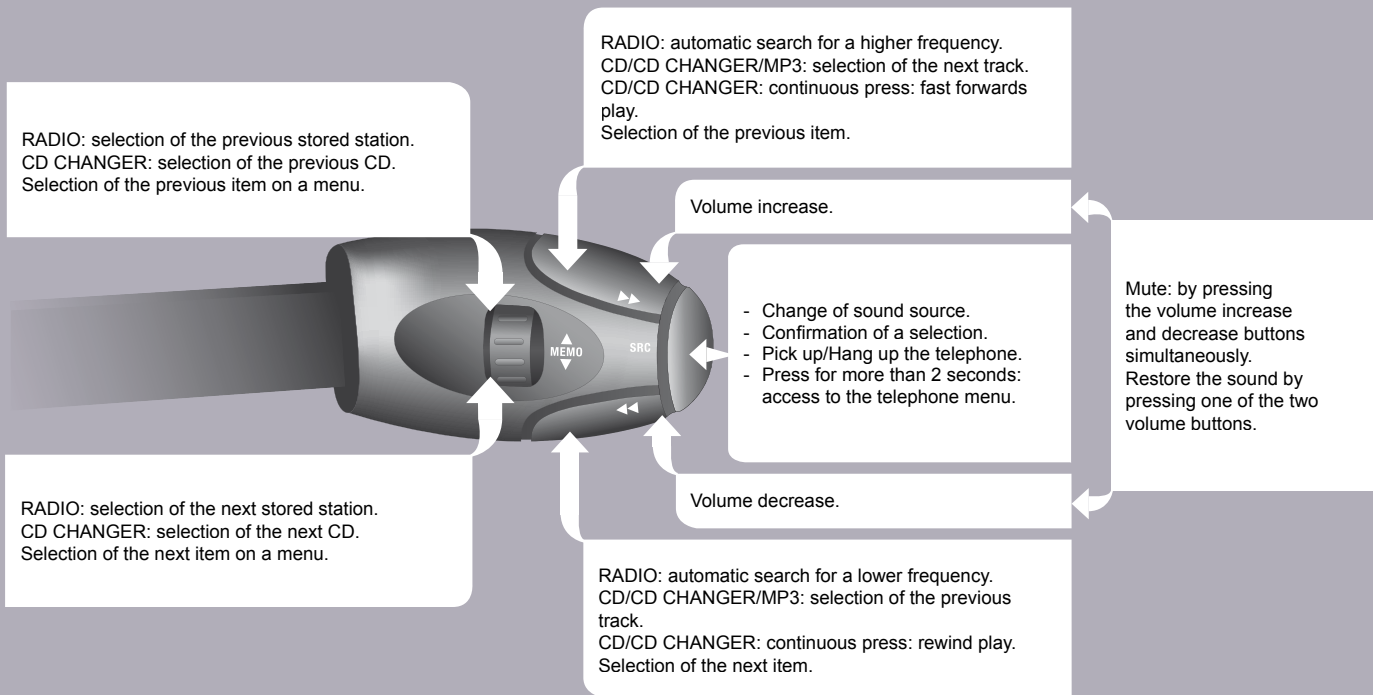

07 CONFIGURATION



ADJUSTING THE DATE AND TIME SCREEN C

1



Press the MENU button.

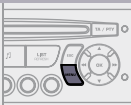

2



Using the arrows, select the PERSONALISATION CONFIGURATION function.



PERSONALISATION CONFIGURATION

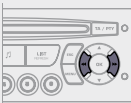

3



Press to confirm the selection.

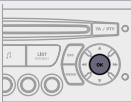

4



Using the arrows, select the DISPLAY CONFIGURATION function.

DISPLAY CONFIGURATION

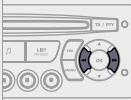

5



Press to confirm the selection.



6



Using the arrows, select the ADJUST DATE AND TIME function.

ADJUST DATE AND TIME



7



Press to confirm the selection.

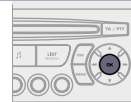

8



Adjust the settings one by one confirming by pressing the OK button. Next select the OK tab on the screen then confirm.

OK

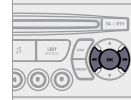

08 DISPLAY FLOW CHART

monochrome A



- 1 MAIN FUNCTION
- 2 CHOICE A
- 3 Choice A1
- 3 Choice A2
- 2 CHOICE B...

1 RADIO-CD

2 RDS SEARCH

2 REG MODE

2 CD REPEAT

2 RANDOM PLAY

1 VEHICLE CONFIG*

2 REV WIPE ACT

2 GUIDE LAMPS

1 OPTIONS

2 DIAGNOSTICS

3 consult

3 abandon

1 UNITS

2 TEMPERATURE: °CELSIUS/°FAHRENHEIT

2 FUEL CONSUMPTION: KM/L - L/100 - MPG

1 DISPLAY ADJUST

2 YEAR

2 MONTH

2 DAY

2 HOUR

2 MINUTES

2 12 H/24 H MODE

1 LANGUAGES

2 FRANCAIS

2 ITALIANO

2 NEDERLANDS

2 PORTUGUES

2 PORTUGUES-BRASIL

2 DEUTSCH

2 ENGLISH

2 ESPANOL

monochrome C



Press the OK dial to gain access to short-cut menus according to the display on the screen:

RADIO

1 activate/deactivate RDS

1 activate/deactivate REG mode

1 activate/deactivate radiotext

CD/MP3 CD

1 activate/deactivate Intro

1 activate/deactivate track repeat

1 Audio CD/Changer: the entire CD

1 MP3 CD/MP3 Changer: the entire current folder

1 activate/deactivate random play

1 Audio CD/Changer: the entire CD

1 MP3 CD: the entire current folder

1 MP3 Changer: all of the folders

USB

1 activate/deactivate track repeat

1 current folders/artist/genre/playlist

1 activate/deactivate random play

1 current folders/artist/genre/playlist

* The parameters vary according to vehicle.

08 DISPLAY FLOW CHART

monochrome A



- 1 MAIN FUNCTION
- 2 CHOICE A
- 3 Choice A1
- 3 Choice A2
- 2 CHOICE B...

1 RADIO-CD

2 RDS SEARCH

2 REG MODE

2 CD REPEAT

2 RANDOM PLAY

1 VEHICLE CONFIG*

2 REV WIPE ACT

2 GUIDE LAMPS

1 OPTIONS

2 DIAGNOSTICS

3 consult

3 abandon

1 UNITS

2 TEMPERATURE: °CELSIUS/°FAHRENHEIT

2 FUEL CONSUMPTION: KM/L - L/100 - MPG

1 DISPLAY ADJUST

2 YEAR

2 MONTH

2 DAY

2 HOUR

2 MINUTES

2 12 H/24 H MODE

1 LANGUAGES

2 FRANCAIS

2 ITALIANO

2 NEDERLANDS

2 PORTUGUES

2 PORTUGUES-BRASIL

2 DEUTSCH

2 ENGLISH

2 ESPANOL

monochrome C



Press the OK dial to gain access to short-cut menus according to the display on the screen:

RADIO

1 activate/deactivate RDS

1 activate/deactivate REG mode

1 activate/deactivate radiotext

CD/MP3 CD

1 activate/deactivate Intro

1 activate/deactivate track repeat

1 Audio CD/Changer: the entire CD

1 MP3 CD/MP3 Changer: the entire current folder

1 activate/deactivate random play

1 Audio CD/Changer: the entire CD

1 MP3 CD: the entire current folder

1 MP3 Changer: all of the folders

USB

1 activate/deactivate track repeat

1 current folders/artist/genre/playlist

1 activate/deactivate random play

1 current folders/artist/genre/playlist

* The parameters vary according to vehicle.

08 DISPLAY FLOW CHART monochrome C



1 AUDIO FUNCTIONS

2 FM BAND PREFERENCES

3 alternative frequencies (RDS)

4 activate/deactivate

3 regional mode (REG)

4 activate/deactivate

3 radio-text information (RDTXT)

4 activate/deactivate

2 PLAY MODES

3 album repeat (RPT)

4 activate/deactivate

3 track random play (RDM)

4 activate/deactivate



1 TRIP COMPUTER

2 ENTER DISTANCE TO DESTINATION

2 WARNING LOG

2 STATUS OF FUNCTIONS



1 PERSONALISATION-CONFIGURATION

2 DEFINE THE VEHICLE PARAMETERS*

2 DISPLAY CONFIGURATION

3 video brightness adjustment

4 normal video

4 inverse video

4 brightness (- +) adjustment

3 date and time adjustment

3 day/month/year adjustment

4 hour/minute adjustment

4 choice of 12 h/24 h mode

3 choice of units

4 l/100 km - mpg - km/l

4 °Celsius/°Fahrenheit

2 CHOICE OF LANGUAGE



1 BLUETOOTH TELEPHONE

1 BLUETOOTH CONFIGURATION

2 Connect/Disconnect a device

3 Telephone function

3 Audio Streaming function

2 Consult the paired device

2 Delete a paired device

2 Perform a Bluetooth search

1 CALL

2 Calls list

3 Directory

1 MANAGE THE TELEPHONE CALL

2 Terminate the current call

2 Activate private mode

* The parameters vary according to vehicle.

FREQUENTLY ASKED QUESTIONS

The table below groups together the answers to the most frequently asked questions concerning your Audio system.

QUESTION	RESPONSE	SOLUTION
There is a difference in sound quality between the different audio sources (radio, CD, CD changer...).	For optimum sound quality, the audio settings (Volume, Bass, Treble, Ambience, Loudness) can be adapted to the different sound sources, which may result in audible differences when changing source (radio, CD, CD changer...).	Check that the audio settings (Volume, Bass, Treble, Ambience, Loudness) are adapted to the sources listened to. It is advisable to set the AUDIO functions (Bass, Treble, Front-Rear Balance, Left-Right Balance) to the middle position, select the musical ambience "None" and set the loudness correction to the "Active" position in CD mode or to the "Inactive" position in radio mode.
The CD is ejected automatically or is not played by the player.	<p>The CD is inserted upside down, is unplayable, does not contain any audio data or contains an audio format which the player cannot play.</p> <p>The CD is protected by an anti-pirating protection system which is not recognised by the audio equipment.</p>	<ul style="list-style-type: none"> - Check that the CD is inserted in the player the right way up. - Check the condition of the CD: the CD cannot be played if it is too damaged. - Check the content in the case of a recorded CD: consult the advice in the "Audio" section. - The audio equipment's CD player does not play DVDs. - Due to inadequate quality, certain recorded CDs will not be played by the audio system.
The CD player sound is poor.	The CD used is scratched or of poor quality.	Insert good quality CDs and store them in suitable conditions.
	The audio equipment settings (bass, treble, ambiances) are unsuitable.	Set the treble or bass level to 0, without selecting an ambience.

QUESTION	RESPONSE	SOLUTION
The stored stations do not function (no sound, 87.5 Mhz is displayed...)	An incorrect waveband is selected.	Press the BAND AST button to return to the waveband (AM, FM1, FM2, FMAST) on which the stations are stored.
The traffic announcement (TA) is displayed. I do not receive any traffic information.	The radio station is not part of the regional traffic information network.	Tune to a radio station which broadcasts traffic information.
The quality of reception of the radio station listened to gradually deteriorates or the stored stations do not function (no sound, 87.5 Mhz is displayed...).	The vehicle is too far from the transmitter used by the station listened to or there is no transmitter in the geographical area through which the vehicle is travelling.	Activate the RDS function to enable the system to check whether there is a more powerful transmitter in the geographical area.
	The environment (hills, buildings, tunnels, basement car parks...) block reception, including in RDS mode.	This phenomenon is normal and does not indicate a failure of the audio equipment.
	The aerial is absent or has been damaged (for example when going through a car wash or into an underground car park).	Have the aerial checked by a CITROËN dealer.
Sound cut-outs of 1 to 2 seconds in radio mode.	During this brief sound cut-out, the RDS searches for any frequency permitting better reception of the station.	Deactivate the RDS function if the phenomenon is too frequent and always on the same route.
With the engine off, the audio equipment switches off after a few minutes of use.	When the engine is switched off, the audio equipment operating time depends on the battery charge. The switch-off is normal: the audio equipment switches to economy mode and switches off to prevent discharging of the vehicle's battery.	Start the vehicle's engine to increase the battery charge.
The message "the audio system is overheated" appears on the display.	In order to protect the installation if the surrounding temperature is too high, the audio equipment switches to an automatic thermal protection mode leading to a reduction of the volume or stopping of the playing of the CD.	Switch the audio system off for a few minutes to allow the system to cool.

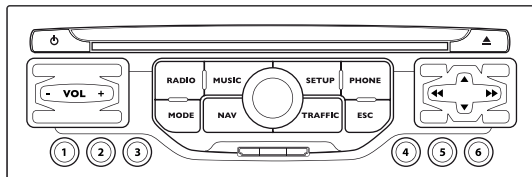

MyWay

MULTIMEDIA AUDIO EQUIPMENT/BLUETOOTH TELEPHONE
GPS EUROPE BY SD CARD

CONTENTS

- **01 First steps** pg. 9.19
- **02 General operation** pg. 9.21
- **03 Navigation - Guidance** pg. 9.23
- **04 Traffic information** pg. 9.30
- **05 Radio** pg. 9.31
- **06 Music media players** pg. 9.32
- **07 Bluetooth telephone** pg. 9.35
- **08 Configuration** pg. 9.37
- **09 Steering wheel controls** pg. 9.39
- **10 Display flow charts** pg. 9.40
- **Frequently asked questions** pg. 9.43



The MyWay is protected in such a way that it will only operate in your vehicle. If it is to be installed in another vehicle, contact a CITROËN dealer for configuration of the system.



For safety reasons, it is imperative that the driver carries out operations which require prolonged attention while the vehicle is stationary. When the engine is switched off and to prevent discharging of the battery, the MyWay switches off following the activation of the Energy Economy mode.



Certain functions described in this handbook will become available during the course of the year.

FIRST STEPS 01

MY WAY CONTROL PANEL

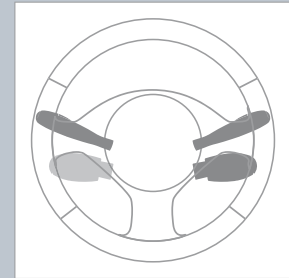
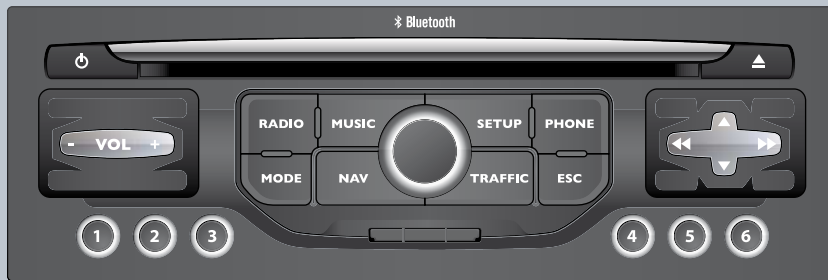

01 FIRST STEPS

MY WAY CONTROL PANEL

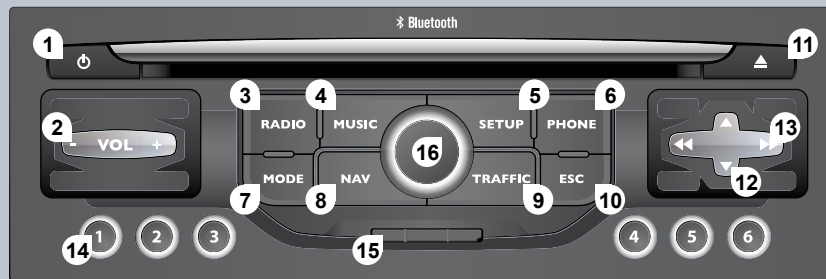

1. Engine not running
 - Short press: on/off.
 - Long press: CD pause, mute for the radio.
2. Volume adjustment.
- 3-4 Long press: access to the settings: front/rear and left/right balance, bass/treble, equalizer, loudness, automatic volume adjustment, initialise the settings.
3. Access to the RADIO menu. Displaying of the list of stations.
4. Access to the MUSIC menu. Displaying of the tracks.
5. Access to the SETUP menu.
 - Long press: access to the GPS coverage and the demonstration mode.
6. Access to the PHONE menu. Displaying of the call list.
7. Access to the MODE menu.
 - Selection of the successive displaying of: Radio, Map, NAV (if navigation is in progress), Telephone (if a conversation is in progress), Trip Computer.
 - Long press: displaying of a black screen (DARK).
8. Access to the NAVIGATION menu. Displaying of the last destinations.
9. Access to the TRAFFIC menu. Displaying of the current traffic alerts.
10. ESC: abandon the operation in progress.
11. CD eject.
12. Selection of the previous/next radio station from the list.
 - Selection of the previous/next CD.
 - Selection of the previous/next MP3 directory.
 - Selection of the previous/next page of a list.
13. Selection of the previous/next radio station.
 - Selection of the previous/next CD or MP3 track.
 - Selection of the previous/next line of a list.
14. Buttons 1 to 6:
 - Selection of the stored radio station.
 - Selection of the CD in the CD changer.
 - Long press: storing of the current radio station.
15. SD card reader.
16. Dial for selection on the display on the screen and according to the context of the menu.
 - Short press: confirmation.

GENERAL OPERATION 02

Press the MODE button several times in succession to gain access to the following menus:

RADIO/MUSIC MEDIA PLAYERS



TELEPHONE

(If a conversation is in progress)



TRIP COMPUTER

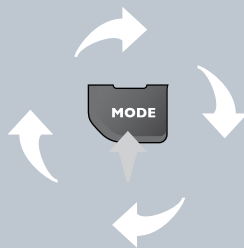

FULL SCREEN MAP



NAVIGATION (If guidance is in progress)



SETUP:

system language, date and time, display, vehicle parameters, units and system parameters, DEMONSTRATION MODE.



TRAFFIC:

TMC information and messages



For maintenance of the display, the use of a soft, non-abrasive cloth (spectacles cloth) is recommended, without any additional product.



For a detailed global view of the menus available, refer to section 10.

02 GENERAL OPERATION

DISPLAY ACCORDING TO THE CONTEXT



A press on the OK dial to permits access to short-cut menus according to the display on the screen.

NAVIGATION (IF GUIDANCE IS IN PROGRESS):

- 1 ABORT GUIDANCE
- 1 REPEAT ADVICE
- 1 BLOCK ROAD
- 1 ROUTE INFO
 - 2 show dest.
 - 2 trip info
 - 3 route type
 - 3 avoidance criteria
 - 3 satellites
 - 2 zoom/scroll
- 1 VOICE ADVICE
- 1 ROUTE OPTIONS

TRIP COMPUTER:

- 1 ALERT LOG
- 1 STATUS OF FUNCTIONS

TELEPHONE:

- 1 END CALL
- 1 HOLD CALL
- 1 DIAL
- 1 DTMF TONES
- 1 PRIVATE MODE
- 1 MICRO OFF

MUSIC MEDIA PLAYERS:

- 1 TA
- 1 PLAY OPTIONS
 - 2 normal
 - 2 random track
 - 2 repeat folder
 - 2 track intro
- 1 SELECT MUSIC

RADIO:

- 1 IN FM MODE
 - 2 TA
 - 2 RDS
 - 2 radiotext
 - 2 regional prog. (REG)
 - 2 AM
- 1 IN AM MODE
 - 2 TA
 - 2 refresh AM list
 - 2 FM

FULL SCREEN MAP:

- 1 ABORT/RESUME GUIDANCE
- 1 SET DESTINATION
- 1 POIS NEARBY
- 1 POSITION INFO
- 1 MAP SETTINGS
- 1 ZOOM/SCROLL

03 NAVIGATION - GUIDANCE

SELECTING A DESTINATION

Insert the SD card in the front panel reader and leave it there to use the Navigation functions.
The navigation SD card data must not be changed.
The map data updates are available from CITROËN dealers.

1

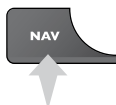

Press the NAV button.

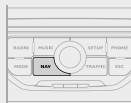

The list of the last 20 destinations appears under the NAVIGATION MENU function.

2



Press the NAV button again or select the NAVIGATION MENU function and press the dial to confirm.

NAVIGATION MENU

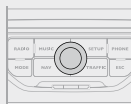

3



Select the DESTINATION INPUT function and press the dial to confirm.

DESTINATION INPUT



4



Select the NEW DESTINATION INPUT function and press the dial to confirm.

NEW DESTINATION INPUT



5



Once the country has been selected, turn the dial and select the town function. Press the dial to confirm.

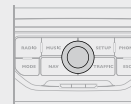

6



Select the letters of the town one by one confirming each time by pressing the dial.

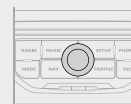

A pre-set list (by entering the first few letters) of the towns in the country selected can be accessed via the LIST button on the virtual keypad.



During guidance, pressing the end of the lights stalk repeats the last guidance instruction.

7



Turn the dial and select OK.
Press the dial to confirm.



9



Then select **START ROUTE GUIDANCE** and press the dial to confirm.

DEMARRER GUIDAGE

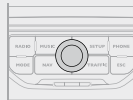

To speed up the process, the post code can be entered directly after selecting the **POST CODE** function.
Use the virtual keypad to enter the letters and digits.

10



Select the route type:
FAST ROUTE, **SHORT ROUTE** or **OPTIMISED ROUTE** and press the dial to confirm.



8



Repeat steps 5 to 7 for the **STREET** and **N°** functions.



It is also possible to select a destination **FROM ADDRESS BOOK** or **FROM LAST DESTINATIONS**.

FROM ADDRESS BOOK **FROM LAST DESTINATIONS**



Select the **SAVE TO ADDRESS BOOK** function to record the address entered in a directory file. Press the dial to confirm the selection.
MyWay permits the recording of up to 4 000 contact files.



You can zoom in/zoom out on the map using the dial.
It is possible to scroll the map or select its orientation via the short-cut menu of the **FULL SCREEN MAP**. Press the dial then select **MAP SETTINGS** or **ZOOM/SCROLL** and confirm.

03 NAVIGATION - GUIDANCE

ROUTE OPTIONS

The route selected by the MyWay audio/telephone depends directly on the route options. Changing these options may change the route completely.

1

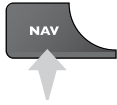

Press the NAV button.

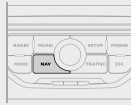

2



Press the NAV button again or select the NAVIGATION MENU function and press the dial to confirm.

NAVIGATION MENU



3



Select the ROUTE OPTIONS function and press the dial to confirm.

ROUTE OPTIONS



4



Select the ROUTE TYPE function and press the dial to confirm. This function allows you to change the route type.

ROUTE TYPE



5



Select the ROUTE DYNAMICS function. This function provides access to the TRAFFIC INDEPENDENT or SEMI-DYNAMIC options.

ROUTE DYNAMICS

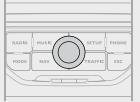

6



Select the AVOIDANCE CRITERIA function. This function provides access to the AVOID options (motorways, toll roads, ferries).

AVOIDANCE CRITERIA



7



Turn the dial and select the RECALCULATE function to take into account the route options selected. Press the dial to confirm.

RECALCULATE



ADDING A STOPOVER

Stopovers can be added to the route once the destination has been selected.

1

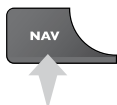

Press the NAV button.

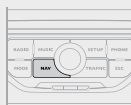

2



Press the NAV button again or select the NAVIGATION MENU function and press the dial to confirm.

NAVIGATION MENU



3



Select the STOPOVERS function and press the dial to confirm.

STOPOVERS



4



Select the ADD A STOPOVER function (5 stopovers maximum) and press the dial to confirm.

ADD A STOPOVER

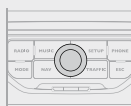

5



Enter a new address, for example.

ADDRESS INPUT

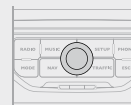

6



Once the new address has been entered, select OK and press the dial to confirm.

OK

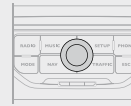

7



Select RECALCULATE and press the dial to confirm.

RECALCULATE

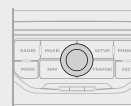

The stopover must be completed or deleted in order for the guidance to continue to the next destination. Otherwise, the MyWay will always return you to the previous stopover.

03 NAVIGATION - GUIDANCE

SEARCHING FOR POINTS OF INTEREST

The points of interest (POIs) indicate all of the service locations in the vicinity (hotels, various businesses, airports...).

1 Press the NAV button.

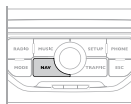
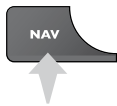

2 Press the NAV button again or select the NAVIGATION MENU function and press the dial to confirm.



NAVIGATION MENU



3 Select the SEARCH POINTS OF INTEREST function and press the dial to confirm.



SEARCH POINTS OF INTEREST

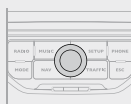

4 Select the POI NEARBY function to search for POIs around the vehicle.



POI NEARBY



5 Select the POI NEAR DESTINATION function to search for POIs near the point of arrival of the route.



POI NEAR DESTINATION

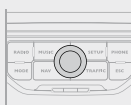

6 Select the POI IN CITY function to search for POIs in the city required. Select the country then enter the name of the city using the virtual keypad.



POI IN CITY



A list of cities present in the country selected can be accessed via the LIST button on the virtual keypad.

7 Select the POI IN COUNTRY function to search for POIs in the country required.



POI IN COUNTRY



8 Select the POI NEAR ROUTE function to search for POIs near the route.



POI NEAR ROUTE





























03 NAVIGATION - GUIDANCE







Zooming in on this icon shows the new POIs.



List of POIs

-  Service station
-  LPG station
-  Garage
-  CITROËN
-  Motor racing circuit
-  Covered car park
-  Car park
-  Rest area
-  Hotel
-  Restaurant
-  Refreshment area
-  Picnic area
-  Cafeteria

-  Airport
-  Railway station
-  Bus station
-  Port
-  Industrial estate
-  Supermarket
-  Bank
-  Vending machine
-  Tennis court
-  Swimming pool
-  Golf course
-  Winter sports resort
-  Theatre

-  Cinema
-  Camp site
-  Theme parks
-  Hospital
-  Pharmacy
-  Police station
-  School
-  Post office
-  Museum
-  Tourist information
-  Automatic speed camera*
-  Red light camera*
-  Hazardous location*

03 NAVIGATION - GUIDANCE

NAVIGATION SETTINGS

Contact a CITROËN dealer for details of the procedure for obtaining the HAZARDOUS LOCATION POIs.

The updating of the HAZARDOUS LOCATION POIs requires an SDHC (High Capacity) compatible reader.

1

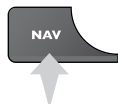

Press the NAV button.

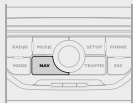

2



Press the NAV button again or select the NAVIGATION MENU function and press the dial to confirm.

NAVIGATION MENU

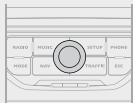

3



Select the SETTINGS function and press the dial to confirm.

SETTINGS

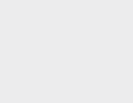

4



Select the NAVI VOLUME function and turn the dial to set the volume of each voice synthesiser (traffic information, alert messages...).

NAVI VOLUME



5



Select the POI CATEGORIES ON MAP function to select the POIs to be displayed on the map by default.

POI CATEGORIES ON MAP



6



Select HAZARDOUS LOCATION POIs to gain access to the DISPLAY ON MAP, VISUAL ALERT and SOUND ALERT functions.

HAZARDOUS LOCATION POIs



04 TRAFFIC INFORMATION

CONFIGURE THE FILTERING AND DISPLAYING OF THE TMC MESSAGES

The filters are independent and their results are cumulative. We recommend a filter on the route and a filter around the vehicle of:

- 2 miles (3 km) or 3 miles (5 km) for a region with heavy traffic,
- 6 miles (10 km) for a region with normal traffic,
- 30 miles (50 km) for long journeys (motorway).

1



Press the TRAFFIC button.



The list of TMC messages appears under the TRAFFIC MENU sorted in order of proximity.

2



Press the TRAFFIC button again or select the TRAFFIC MENU function and press the dial to confirm.

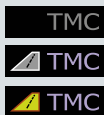
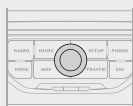

The TMC icon, at the bottom left of the screen, may appear in 3 different forms:

- No TMC station available,
- TMC station available, no message on route,
- TMC station available and messages on route (if guidance is active).

3



Select the filter of your choice:

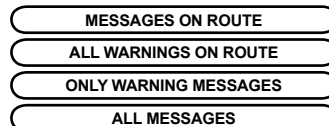

The messages appear on the map and on the list. To exit, press ESC.

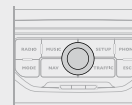

4



Select the GEOGRAPHICAL FILTER (NONE) function and press the dial to confirm.

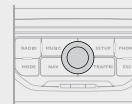

5



On the list which appears, select the distance radius required in accordance with the route. Press the dial to confirm the selection.

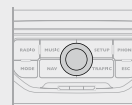

05 RADIO

The external environment (hill, building, tunnel, underground car park...) may interfere with the reception, including in RDS following mode. This phenomenon is a normal result of the way in which radio waves are transmitted and does not in any way indicate a failure of the audio equipment.

SELECTING A STATION

1



Press the RADIO button to display the list of stations received locally sorted in alphabetical order. Select the station required by turning the dial and press to confirm.

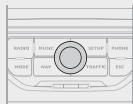

While listening to the radio, press one of the buttons to select the previous or next station on the list.

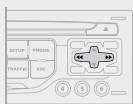

A long press of one of the buttons starts the automatic search for a station with a lower or higher frequency.

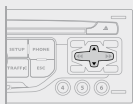

Press one of the buttons on the numeric keypad for more than 2 seconds to store the current station. Press the button on the numeric keypad to recall the stored radio station.

RDS - REGIONAL MODE - TRAFFIC INFO

1



When the current radio station is displayed on the screen, press the dial.



2

The radio source short-cuts menu appears and provides access to the following short-cuts:

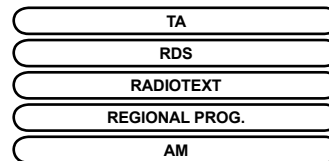

3



Select the function required and press the dial to confirm to gain access to the corresponding settings.



The RDS, if displayed, allows you to continue listening to the same station by means of the frequency following. However, in certain conditions, this RDS station cannot be followed throughout the entire country as radio stations do not cover 100 % of the territory. This explains the loss of reception of the station during a journey.

06 MUSIC MEDIA PLAYERS

CD, MP3/WMA CD, MP3/WMA SD CARD INFORMATION AND ADVICE

If the GPS is used, the navigation SD card must remain in the MyWay audio/telephone reader. In this case, it is not possible to play an SD card containing MP3 files.



The MP3 format, an abbreviation of MPEG 1,2 & 2.5 Audio Layer 3 and the WMA format, an abbreviation of Windows Media Audio and the property of Microsoft, are audio compression standards which permit the recording of several tens of music files on a single disc.



The audio equipment will only play audio files with the extension ".mp3" with a speed of between 8 Kbps and 320 Kbps and the extension ".wma" with a speed of between 5 Kbps and 384 Kbps. It also supports the VBR (Variable Bit Rate) mode. No other type of file (.mp4, .m3u...) can be played.



In order to be able to play a recorded CDR or CDRW, when recording it is preferable to select the ISO 9660 level 1, 2 or Joliet standard.

If the disc is recorded in another format it may not be played correctly.

It is recommended that the same recording standard is always used for an individual disc, with as low a speed as possible (4x maximum) for optimum sound quality.

In the particular case of a multi-session CD, the Joliet standard is recommended.



It is advisable to restrict file names to 20 characters, without using of special characters (e.g.: " " ? ; ù) to avoid any playing and displaying problems.



During play, exit the SD Card mode before removing the SD card from its reader.



To avoid any risk of theft, remove the SD card when you leave your vehicle with the roof down.

SELECTING/PLAYING MUSIC CD, MP3/WMA CD, MP3/WMA SD CARD

1



Press the MUSIC button.

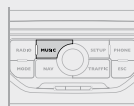

4



Select the music source required:
CD, MP3/WMA CD, MP3/WMA SD
CARD... Press the dial to confirm.
Play begins.

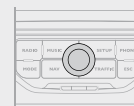

!

The list of tracks or MP3/WMA files appears under MUSIC MENU.

5



Press the up or down button to select
the next/previous folder.

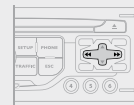

2



Press the MUSIC button again or
select the MUSIC MENU function and
press the dial to confirm.

MUSIC MENU



6



Press one of the buttons to select a
music track.
Press and hold one of the buttons for
fast forward or rewind play.



3



Select the SELECT MUSIC function
and press the dial to confirm.

SELECT MUSIC



The playing and displaying of an MP3/WMA compilation may depend on the recording programme and/or the parameters used. We recommend the ISO 9660 recording standard.

06 MUSIC MEDIA PLAYERS

USING THE EXTERNAL DEVICE (AUX) AUDIO/RCA CABLE NOT SUPPLIED

1

Connect the portable equipment (MP3/WMA player...) to the audio sockets (white and red, RCA type) in the glove box using a JACK/RCA audio cable.

2



Press the MUSIC button then press it again or select the MUSIC MENU function and press the dial to confirm.



3



Select the EXTERNAL DEVICE function and press the dial to activate it.

EXTERNAL DEVICE



4



Select the AUX music source and press the dial to confirm. Play begins automatically.

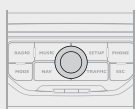

!

The displaying and management of the controls are operated via the portable equipment.

CD CHANGER PLAYING A CD (NOT MP3/WMA COMPATIBLE)



1



Insert one or more CDs in the changer. Press the MUSIC button.

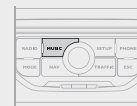

2



Press the MUSIC button again or select the MUSIC MENU function and press the dial to confirm.

MUSIC MENU



3



Select the SELECT MUSIC function and press the dial to confirm.

SELECT MUSIC

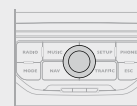

4



Select the CD CHANGER music source and press the dial to confirm.

CD CHANGER



5



Press one of the buttons on the numeric keypad to select the corresponding CD.



07 BLUETOOTH TELEPHONE



CONNECTING A TELEPHONE

The services available depend on the network, the SIM card and the compatibility of the Bluetooth equipment used. Refer to your telephone's manual and your operator to check which services you have access to. A list of mobile telephones which offer the best range of services is available from dealers.



For safety reasons and because they require prolonged attention on the part of the driver, the operations for pairing the Bluetooth mobile telephone to the hands-free system of the MyWay must be carried out with the vehicle stationary and the ignition on.

1

Activate the telephone's Bluetooth function. The last telephone connected is reconnected automatically.



2



Press the PHONE button.

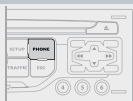

3



Select the TELEPHONE MENU function and press the dial to confirm.

TELEPHONE MENU



The list of telephones connected previously (4 maximum) appears on the multifunction display. Select the telephone required for a new connection.

4



For a first connection, select SEARCH PHONE and press the dial to confirm. Then select the name of the telephone.

SEARCH PHONE

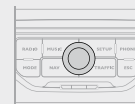

5



Enter the authentication code on the telephone. The code to be entered is displayed on the screen.

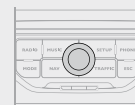

i

Once the telephone has been connected, MyWay can synchronise the address book and the call list. This synchronisation may take a few minutes.

1



To change the telephone connected, press the PHONE button, then select TELEPHONE MENU and press the dial to confirm.



2



Select CONNECT PHONE. Select the telephone and press to confirm.

CONNECT PHONE

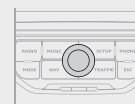

RECEIVING A CALL

1

An incoming call is announced by a ring and a superimposed display on the multifunction display.

2



Select the YES tab to accept or NO to refuse and confirm by pressing the dial.

YES NO



3



To hang up, press the PHONE button or press the dial and select END CALL then confirm by pressing the dial.

END CALL



Press the end of the steering wheel control to accept the call or end the call in progress.



MAKING A CALL

1



Press the PHONE button.

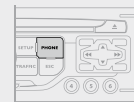

The list of the last 20 calls made and received in the vehicle appears under TELEPHONE MENU. You can select a number and press the dial to make the call.

2



Select the TELEPHONE MENU function and press the dial to confirm.

TELEPHONE MENU



3



Select DIAL NUMBER, then dial the telephone number using the virtual keypad.

DIAL NUMBER



It is also possible to select a number from the address book. You can select DIAL FROM ADDRESS BOOK. MyWay permits the recording of up to 4 000 entries.



Press the end of the steering wheel control for more than two seconds to gain access to the address book.

08 CONFIGURATION

SETTING THE DATE AND TIME

This function provides access to the options: SYSTEM LANGUAGE, DATE AND TIME, DISPLAY (BRIGHTNESS, COLOUR, MAP COLOUR), VEHICLE PARAMETERS, UNITS, SYSTEM PARAMETERS.

1



Press the SET UP button.

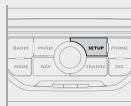

2



Select the DATE AND TIME function and press the dial to confirm.

DATE AND TIME



3



Select the SET DATE AND TIME function and press the dial to confirm.

SET DATE AND TIME



4



Set the parameters one by one using the direction arrows by means of the dial.

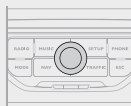

5



Select the DATE FORMAT function and press the dial to confirm.

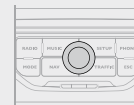

6



Confirm the format required using the dial.
Select the TIME FORMAT function and press the dial to confirm.



Confirm the format required using the dial.
Pressing the SET UP button for more than 2 seconds permits access to:

DESCRIPTION OF THE UNIT

GPS COVERAGE

DEMO MODE

TRIP COMPUTER/VEHICLE PARAMETERS

VEHICLE DIAGNOSTICS



- The "vehicle" tab:
The range, the current consumption and the distance remaining.
- The "1" (route 1) tab with:
The average speed, the average consumption and the distance travelled calculated over route "1".
- The "2" (route 2) tab with the same functions for a second route.



Each press of the button at the end of the wipers stalk displays the various trip computer data in succession, according to the display.



A FEW DEFINITIONS



Range: displays the distance which can be travelled with the remaining fuel detected in the tank, in relation to the average consumption over the last few miles (kilometres).

This displayed value may vary significantly following a change in the vehicle speed or the relief of the route.

When the range falls below 20 miles (30 km), dashes are displayed. After filling with at least 5 litres of fuel, the range is recalculated and is displayed when it exceeds 60 miles (100 km).

If, whilst driving, dashes are displayed continuously in place of the digits, contact a CITROËN dealer.

Current consumption: only calculated and displayed above 20 mph (30 km/h).

Average consumption: this is the average quantity of fuel consumed since the last trip computer zero reset.

Distance travelled: calculated since the last trip computer zero reset.

Distance remaining to the destination: calculated with reference to the final destination, entered by the user. If guidance is activated, the navigation system calculates it as a current value.

Average speed: this is the average speed calculated since the last trip computer zero reset (ignition on).

09 FIRST STEPS

STEERING WHEEL CONTROLS

RADIO: selection of the next stored station.
MP3/WMA SD CARD: selection of the next directory.
CD CHANGER: selection of the next CD.
Selection of the next entry in the address book.

RADIO: change to the next radio station on the list.
Long press: automatic search for a higher frequency.
CD/MP3 SD CARD/CD CHANGER: selection of the next track.
CD/MP3 SD CARD/CD CHANGER: continuous press: fast forward play.

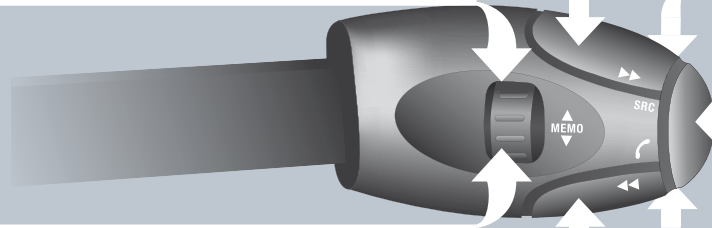

Volume increase.

- Change the sound source.
- Make a call from the address book.
- Pick up/Hang up the telephone.
- Press for more than 2 seconds: access to the address book.

Mute: by pressing the volume increase and decrease buttons simultaneously.
Restore the sound: by pressing one of the two volume buttons.

Volume decrease.

RADIO: selection of the previous stored station.
MP3/WMA SD CARD: selection of the previous directory.
CD CHANGER: selection of the previous CD.
Selection of the previous entry in the address book.

RADIO: change to the previous radio station on the List.
Long press: automatic search for a lower frequency.
CD/MP3 SD CARD/CD CHANGER: selection of the previous track.
CD/MP3 SD CARD/CD CHANGER: continuous press: fast backward play.

10 DISPLAY FLOW CHARTS



1 MAIN FUNCTION

- 2 CHOICE A
- 3 choice A1
- 3 choice A2
- 2 CHOICE B...



1 "TRAFFIC" MENU

- 2 MESSAGES ON ROUTE
- 2 ONLY WARNINGS ON ROUTE
- 2 ALL WARNING MESSAGES
- 2 ALL MESSAGES
- 2 GEOGRAPHICAL FILTER
- 3 none
- 3 within 2 miles (3 km)
- 3 within 3 miles (5 km)
- 3 within 6 miles (10 km)
- 3 within 30 miles (50 km)



1 "MUSIC" MENU

- 2 SELECT MUSIC
- 2 SOUND SETTINGS
- 3 balance/fader
- 3 bass/treble
- 3 equalizer
- 4 none
- 4 classical
- 4 jazz
- 4 rock/pop
- 4 techno
- 4 vocal
- 3 loudness
- 3 initialise sound settings



1 "RADIO" MENU

- 2 WAVEBAND
- 3 FM
- 3 AM
- 2 MANUAL TUNE
- 2 SOUND SETTINGS
- 3 balance/fader
- 3 bass/treble
- 3 equalizer
- 4 none
- 4 classical
- 4 jazz
- 4 rock/pop
- 4 techno
- 4 vocal
- 3 loudness
- 3 initialise sound settings



1 "NAVIGATION" MENU

2 ABORT/RESUME GUIDANCE

2 DESTINATION INPUT

3 address input

4 country

4 city

4 street

4 number

4 start route guidance

4 post code

4 add to address book

4 intersection

4 city district

4 geo position

4 MAP

3 navigate HOME

3 choose from address book

3 choose from last destinations

2 STOPOVERS

3 add stopover

4 address input

4 navigate HOME

4 choose from address book

4 choose from last destinations

3 rearrange route

3 replace stopover

3 delete stopover

3 recalculate

4 fast route

4 short route

4 optimised route

2 POI SEARCH

3 POI nearby

3 POI near destination

3 POI in city

3 POI in country

3 POI near route

2 ROUTE OPTIONS

3 route type

4 fast route

4 short route

4 optimised route

2 SETTINGS

3 route dynamics

4 traffic independent

4 semi-dynamic

3 avoidance criteria

4 avoid motorways

4 avoid toll roads

4 avoid ferries

3 recalculate

PHONE

1 "TELEPHONE" MENU

2 DIAL NUMBER

2 DIAL FROM ADDRESS BOOK

2 CALL LIST

2 CONNECT PHONE

3 search phone

3 phones connected

4 disconnect phone

4 rename phone

4 delete pairing

4 delete all pairings

4 show details

2 SETTINGS

3 select ring tone

3 phone/ring tone volume

3 enter mailbox number

SETUP

1 SETUP

2 SYSTEM LANGUAGE

3 deutsch

3 english

3 espanol

3 français

3 italiano

3 nederlands

3 polski

3 portuguese

2 DATE AND TIME

3 set date and time

3 date format

3 time format

2 DISPLAY

3 brightness

3 colour

4 pop titanium

4 toffee

4 blue steel

4 technogrey

4 dark blue

3 map colour

4 day mode for map

4 night mode for map

4 auto. day/night for map

2 VEHICLE PARAMETERS

3 vehicle information

4 alert log

4 status of functions

2 UNITS

3 temperature

4 celsius

4 fahrenheit

3 Distance

4 km and l/100

4 km and km/l

4 miles (mi) and MPG

2 SYSTEM PARAMETERS

3 factory reset

3 software version

3 automatic scrolling

FREQUENTLY ASKED QUESTIONS

The table below groups together the answers to the most frequently asked questions concerning the MyWay.

QUESTION	RESPONSE	SOLUTION
<p>There is a difference in sound quality between the different audio sources (radio, CD, CD changer...).</p>	<p>For optimum sound quality, the audio settings (Volume, Bass, Treble, Ambience, Loudness) can be adapted to the different sound sources, which may result in audible differences when changing source (radio, CD, CD changer...).</p>	<p>Check that the audio settings (Volume, Bass, Treble, Ambience, Loudness) are adapted to the sources listened to. It is advisable to set the AUDIO functions (Bass, Treble, Front-Rear Balance, Left-Right Balance) to the middle position, select the musical ambience "None" and set the loudness correction to the "Active" position in CD mode or to the "Inactive" position in radio mode.</p>
<p>The CD is ejected automatically or is not played by the player.</p>	<p>The CD is inserted upside down, is unplayable, does not contain any audio data or contains an audio format which the player cannot play.</p> <p>The CD is protected by an anti-pirating protection system which is not recognised by the audio equipment.</p>	<ul style="list-style-type: none"> - Check that the CD is inserted in the player the right way up. - Check the condition of the CD: the CD cannot be played if it is too damaged. - Check the content in the case of a recorded CD: consult the advice in the Audio section. - The audio equipment's CD player does not play DVDs. - Due to inadequate quality, certain recorded CDs will not be played by the audio system. - The CD changer does not play MP3 CDs.
<p>The CD player sound is poor.</p>	<p>The CD used is scratched or of poor quality.</p>	<p>Insert good quality CDs and store them in suitable conditions.</p>
	<p>The audio equipment settings (bass, treble, ambiances) are unsuitable.</p>	<p>Set the treble or bass level to 0, without selecting an ambience.</p>

QUESTION	RESPONSE	SOLUTION
<p>The quality of reception of the radio station listened to gradually deteriorates or the stored stations do not function (no sound, 87.5 Mhz is displayed...).</p>	<p>The vehicle is too far from the transmitter used by the station listened to or there is no transmitter in the geographical area through which the vehicle is travelling.</p>	<p>Activate the RDS function to enable the system to check whether there is a more powerful transmitter in the geographical area.</p>
	<p>The environment (hills, buildings, tunnels, basement car parks...) block reception, including in RDS mode.</p>	<p>This phenomenon is normal and does not indicate a failure of the audio equipment.</p>
	<p>The aerial is absent or has been damaged (for example when going through a car wash or into an underground car park).</p>	<p>Have the aerial checked by a CITROËN dealer.</p>
<p>Sound cut-outs of 1 to 2 seconds in radio mode.</p>	<p>During this brief sound cut-out, the RDS searches for any frequency permitting better reception of the station.</p>	<p>Deactivate the RDS function if the phenomenon is too frequent and always on the same route.</p>
<p>With the engine off, the audio equipment switches off after a few minutes of use.</p>	<p>When the engine is switched off, the audio equipment operating time depends on the battery charge. The switch-off is normal: the audio equipment switches to economy mode and switches off to prevent discharging of the vehicle's battery.</p>	<p>Start the vehicle's engine to increase the battery charge.</p>

QUESTION	RESPONSE	SOLUTION
<p>The TRAFFIC INFO box is ticked. However, certain traffic jams along the route are not indicated in real time.</p>	<p>On starting, it is several minutes before the system begins to receive the traffic information.</p>	<p>Wait until the traffic information is being received correctly (displaying of the traffic information symbols on the map).</p>
	<p>In certain countries, only major routes (motorways, ...) are listed for the traffic information.</p>	<p>This phenomenon is normal. The system is dependent on the traffic information available.</p>
<p>The time taken to calculate a route sometimes seems longer than usual.</p>	<p>The performance of the system may slow down temporarily if a CD/DVD is being copied onto the Jukebox at the same time as a route is being calculated.</p>	<p>Wait until the CD/DVD has been copied or stop the copying before starting the guidance function.</p>
<p>The altitude is not displayed.</p>	<p>On starting, the initialisation of the GPS may take up to 3 minutes to receive more than 4 satellites correctly.</p>	<p>Wait until the system has started up completely. Check that there is a GPS coverage of at least 4 satellites (long press on the MENU button, then select AUDIO/TELEPHONE DIAGNOSTICS, then GPS COVERAGE).</p>
	<p>Depending on the geographical environment (tunnel, ...) or the weather, the conditions of reception of the GPS signal may vary.</p>	<p>This phenomenon is normal. The system is dependent on the conditions of reception of the GPS signal.</p>
<p>The route calculation is not successful.</p>	<p>The exclusion criteria may conflict with the current location (exclusion of toll roads on a toll motorway).</p>	<p>Check the exclusion criteria.</p>
<p>There is a long waiting time after inserting a CD or SD card.</p>	<p>When a new medium is inserted, the system reads a certain amount of data (directory, title, artist, etc.). This may take a few seconds.</p>	<p>This phenomenon is normal.</p>
<p>I cannot connect my Bluetooth telephone.</p>	<p>The telephone's Bluetooth function may be deactivated or the equipment may not be visible.</p>	<ul style="list-style-type: none"> - Check that your telephone's Bluetooth function is activated. - Check that your telephone is visible.

04 HANDS-FREE KIT



MATCHING A TELEPHONE DISPLAY C



For safety reasons and because they require prolonged attention on the part of the driver, the operations for matching of the Bluetooth mobile telephone with the audio equipment hands-free kit must be carried out with the vehicle stationary and the ignition on.

- 1 Activate the telephone's Bluetooth function and carry out a search of the Bluetooth accessories present for the telephone.



- 2 Select the accessory which corresponds to the name of the vehicle, a superimposed configuration display appears on the multifunction display.



- 3 Enter the vehicle's authentication code (=1234). Depending on the telephone, you may be asked to enter this code before the superimposed configuration display appears.



- 5 Select the YES tab on the display using the buttons then confirm by pressing OK.



YES

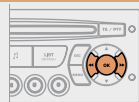

The services offered by the hands-free kit depend on the network, the SIM card and the compatibility of the Bluetooth equipment used.

Consult your telephone's manual and your operator to find out which services are available to you. A list of mobile telephones which offer the best range of services is available from the network. Consult a CITROËN dealer.

Refer to the end of the "Correct use of the hands-free kit telephone" section.

RECEIVING A CALL

- 1 An incoming call is announced by a ring and a superimposed display on the multifunction display.

2



Select the YES tab on the display using the buttons and confirm by pressing OK.

YES

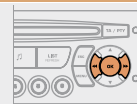

Press the end of the steering wheel stalk to accept the call.



MAKING A CALL



Press the end of the steering wheel stalk for more than two seconds to access your directory.



1

To dial a number, use the keypad on your telephone.



Correct use of the hands-free kit telephone

The matching of a new Bluetooth mobile telephone does not work while the vehicle is being driven.

For safety reasons and because they require prolonged attention on the part of the driver, the operations for matching the Bluetooth mobile telephone with the audio equipment hands-free kit must be carried out with the vehicle stationary and the ignition on.

How many mobile telephones can be stored in the audio equipment.

Up to 4 different mobile telephones can be stored. The mobile telephone stored as 1 will be connected first, then number 2, ...

Is it possible to scroll through the phone book contacts more quickly than line by line.

The controls << >> on the control panel or on the steering wheel control permit direct access to the first contact recorded starting with the next/previous letter of the alphabet.

Are all of the numbers associated with a contact displayed on the audio equipment display.

A maximum of 4 different numbers for one contact in Vcard format are displayed: "Home", "Work", "Mobile" and "Car".