

4 - FAMILIARISATION



INSTRUMENTS AND CONTROLS

1. Speaker (tweeter).
2. Windscreen demisting vents.
3. Controls:
 - Electric windows.
 - Demisting of rear door windows.
 - Air conditioning.
4. Central locking button.
5. Multifunction display or clock.
6. Hazard lights button.
7. Central adjustable heating/ventilation vents.
8. Lights and direction indicators stalk.
9. Speed limiter/cruise control.
10. Instrument panel.
11. Driver's air bag
Horn.
12. Windscreen wash-wipe stalk.
13. Audio equipment steering wheel control.
14. Steering lock and ignition.
15. Fuse box.
16. Passenger air bag disarming control.
17. Alarm.
18. Steering wheel adjustment control.
19. Passenger's electric mirror control.
20. Headlamp height adjustment.
21. Heated seats control.
22. Handbrake.
23. Lighter.
24. Removable ashtray.
25. Gear lever.
26. Storage.
27. Heating/air conditioning controls.
28. Audio RD3.
29. Lower glove box.
30. Upper glove box or passenger air bag.
31. Bonnet release.
32. Side adjustable heating/ventilation vents.
33. Side window de-icing/demisting vents.

6 - FAMILIARISATION



THE KEYS

The keys allow you to switch on the ignition and operate the passenger air bag disarming switch, as well as to independently operate the locks on the doors and the fuel filler cap.

Central locking

From the front doors, the keys allow you to lock and unlock all of the doors. If one of the doors is open, it is impossible to operate the central locking.

The remote control performs the same functions at a distance.

The remote control

Locking

Press button **A** to lock the vehicle. This is confirmed by fixed lighting of the direction indicators for approximately two seconds.

Unlocking

Press button **B** to unlock the vehicle. This is confirmed by rapid flashing of the direction indicators.

Locating the vehicle

To locate your vehicle, previously locked, in a car park:

- ☞ press button **A**, the courtesy lights come on and the direction indicators flash for a few seconds.

STARTING

STOP position (S):

The ignition is off. To release the steering wheel slightly, turn the steering wheel slightly while turning the key, without forcing it.

Accessories position (A):

The ignition is off but the accessories can be used.

On position (M):

The ignition is on.

Starting position (D):

Operates the starter. Release the key when the engine has started. Never operate the starter while the engine is running.





**STEERING WHEEL STALKS
LIGHTING**

Front and rear lights (ring A)



Lights off



Side lights



Dipped headlamps/
Main beam headlamps



Vehicles fitted with a rear fog lamp (ring B)

Turn the ring forwards.



Vehicles fitted with front fog lamps and a rear fog lamp (ring B)

Front fog lamps (1st turn of the ring forwards).

Front fog lamps and rear fog lamp (2nd turn of the ring forwards).

To switch off: turn the ring rearwards.



WINDSCREEN WIPERS

Front

- 2** Rapid wipe (heavy rain).
- 1** Normal wipe (moderate rain).
- I** Intermittent wipe.
- 0** Off.
- ↓ Single wipe.

Windscreen wash-wipe: pull the stalk towards you.

Rear

Off



Intermittent wipe



Wash-wipe





FRONT SEATS

1. Head restraint height adjustment.



Never travel with the head restraints removed.

2. Armrest.
3. Seat back angle adjustment.
4. Forwards-backwards adjustment.
5. Storage drawer (passenger).

AIR BAGS

Front air bags

These are folded in the centre of the steering wheel for the driver and in the fascia for the front passenger. They are deployed simultaneously, except in cases where the passenger air bag is disarmed.

Precautions regarding the passenger air bag

- ☞ disarm the air bag if you install a rear-facing child seat,
- ☞ activate the air bag for an adult passenger.



Disarming the passenger air bag

- ☞ **With the ignition off**, insert the ignition key into the passenger air bag switch **1** and turn it to the **"OFF"** position.
- ☞ As soon as you remove the child seat, turn the air bag switch to the **"ON"** position to activate the air bag again.

Disarming check



With the ignition switched on (2nd notch), illumination of this warning light indicates that the passenger air bag is disarmed (switch in the **"OFF"** position).

The warning light remains on throughout the duration of disarming.



Side air bags

Side air bags are incorporated into the front seat back frame, on the door side.

They are deployed independently of each other, on whichever side the collision occurs.



ELECTRIC WINDOWS

1. Driver's electric window.
2. Passenger's electric window.

Manual mode:

- ☞ Press the switch. The window stops as soon as the switch is released.

Automatic mode (driver):

- ☞ Press and hold the switch. One touch completely opens or closes the window.



EXTERIOR MIRRORS

- ☞ Move the manual control **3** in all four directions to adjust.

Electric control for the passenger's side mirror

- ☞ From the driver's seat, adjust in all four directions by operating the control **4**.



STEERING WHEEL HEIGHT ADJUSTMENT

- ☞ When stationary, push the control **A** forwards to unlock the steering wheel.
- ☞ Adjust the height of the steering wheel.
- ☞ Lock it by pulling control **A** towards you fully.



SPEED LIMITER

This limiter indicates the status of selection of the function on the instrument panel and displays the programmed speed. The minimum speed which can be programmed is at least 18 mph (30 km/h).

It prevents exceeding of the speed programmed by the driver, this function remains active regardless of any action on the brake or clutch pedals. On the other hand, pressing the accelerator pedal to the point of resistance does not have any effect.

It is possible to exceed the programmed speed temporarily by pressing the accelerator firmly beyond this point of resistance.

The operating actions must be carried out with the engine running.



CRUISE CONTROL

The cruise control has a display on the instrument panel to indicate the programmed reference speed.

It enables the vehicle to maintain the reference speed programmed by the driver.





In order for it to be programmed or activated, the vehicle speed must be greater than 25 mph (40 km/h) with at least fourth gear engaged.



If the vehicle is fitted with a speed limiter and cruise control, these functions cannot be activated at the same time.

12 - FAMILIARISATION



HEATING

| N° | Symbol | Function |
|----|---|---|
| 1 |  | Air conditioning control. |
| 2 |  | Air flow adjustment and air intake control. |
| 3 |  | Temperature adjustment. |
| 4 |  | Air distribution adjustment. |



» 36

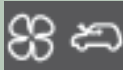









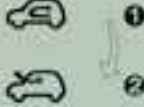

AIR CONDITIONING

| N° | Symbol | Function |
|----|--|---|
| 1 |  | Air flow adjustment. |
| 2 |  | Air flow adjustment and air intake control. |
| 3 |  | Temperature adjustment. |
| 4 |  | Air distribution adjustment. |

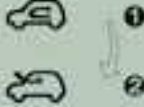

» 38

RECOMMENDED INTERIOR SETTINGS

| I require... | Heating or Manual air conditioning | | | | |
|-----------------------|---|---|--|---|---|
| | Air distribution | Air flow | Air recirculation/ Intake of exterior air | Temperature | Manual AC |
| HOT |  |  |  |  | — |
| COLD |  |  |  |  | A/C |
| DEMISTING DE-ICING |  |  |  |  | ON  |

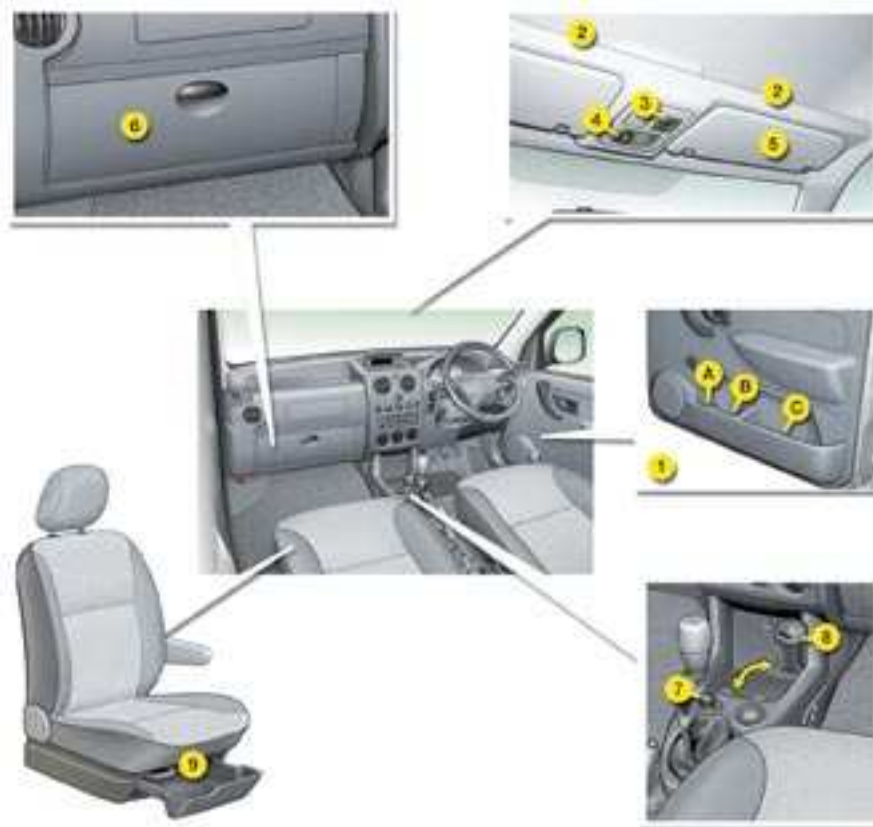

FRONT LAYOUT

1. Storage compartments in the doors.
 - A. Bottle holder.
 - B. Can holder.
 - C. Storage compartment.
2. Overhead storage.
3. Map reading light.
4. Courtesy light.
5. Sun visors.
6. Glove box.
7. Lighter.
8. Removable ashtray.
9. Storage drawer (passenger).

REAR LAYOUT



1. Load space cover.
2. High load retaining net.
3. Stowing rings.
4. Side door storage compartment.
5. Trays between the front and rear seats.
6. Seat back storage pockets.



Stowing rings

For greater safety, always ensure that the loads transported are secured firmly.

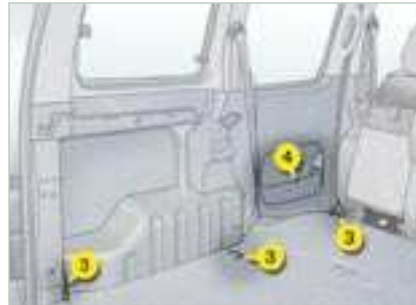

FILLING WITH FUEL



This operation must be carried out with **the engine switched off**.

☞ Insert the key then turn it to the left.

☞ Remove the cap.

A label indicates which type of fuel to use.

When you fill your tank, do not continue after the third cut-off of the pump. This could cause engine malfunctions.

The capacity of the tank is approximately 55 litres for petrol engines and 60 litres for Diesel engines.



Low fuel level warning light

From the time this light comes on, you have enough fuel left to cover **approximately 30 miles (50 km)**.

Note: the right-hand sliding side door cannot be opened while the fuel tank cap is removed.

OPENING THE BONNET



Inside the vehicle: Pull the control on the left-hand side, under the fascia panel.



Outside the vehicle: Lift the control, raise the bonnet and secure the strut to keep the bonnet open.

18 - INSTRUMENTS, CONTROLS and DISPLAYS

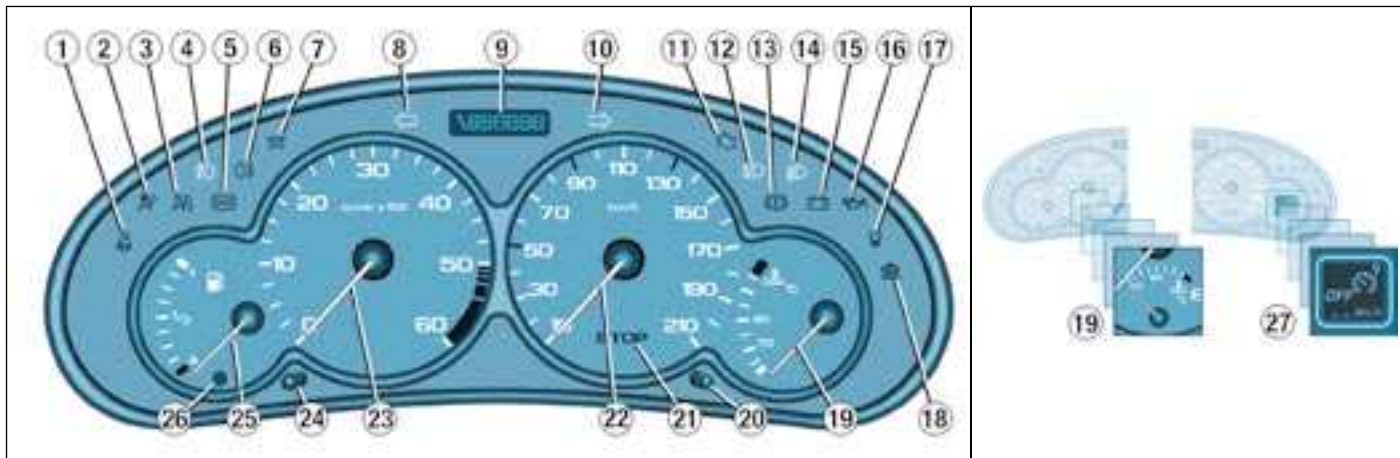

INSTRUMENT PANEL: PETROL - DIESEL

1. Seat belt not fastened warning light
2. Front and side air bags warning light
3. Passenger air bag disarmed warning light
4. Front fog lamps indicator light
5. Anti-lock braking system (ABS) warning light
6. Rear fog lamp indicator light
7. Diesel pre-heat warning light
8. Left hand direction indicator
9. Total distance recorder, service indicator and engine oil level indicator
10. Right hand direction indicator
11. Emission control system warning light
12. Main beam headlamps indicator light
13. Handbrake, low brake fluid level and electronic brake force distribution warning light
14. Dipped beam headlamps indicator light
15. Battery charge warning light
16. Engine oil pressure and temperature warning light
17. Water in diesel filter warning light
18. Low coolant level warning light
19. Coolant temperature indicator
20. Total distance recorder button
21. Central (STOP) warning light
22. Speedometer*
23. Rev counter
24. Lighting rheostat button
25. Fuel level indicator
26. Low fuel level warning light
27. Speed limiter/cruise control display

* Version indicating kilometres, according to country.

INSTRUMENTS AND CONTROLS

A permanently lit warning light or one flashing, with the engine running, indicates an operating fault of the unit concerned. The illumination of certain warning lights may be accompanied by an audible signal and a message on the display. Do not ignore this warning: consult a CITROËN dealer as soon as possible.

If the central STOP warning light comes on when you are driving, stop your vehicle immediately, where it is safe to do so.

Central (STOP) warning light

Linked to the warning lights:

- "engine oil pressure and temperature",
- "low coolant level",
- "handbrake",
- "low brake fluid level",
- "electronic brake force distribution system fault".

Linked with the "coolant temperature" indicator.

You must stop if the light flashes with the engine running.

Consult a CITROËN dealer.



Engine oil pressure and temperature warning light

Linked to the central (STOP) warning light.

You must stop.

This warning light indicates one of the following:

- insufficient oil pressure indicated by the message "**Oil pressure insufficient**" on the display.
- a lack of oil in the lubrication circuit. Top up the level.
- an oil temperature which is too high. To lower the oil temperature, reduce your speed.

Lighting of the warning light is accompanied by an audible signal.

Consult a CITROËN dealer.



Low engine coolant level warning light

Linked to the central (STOP) warning light.

This comes on for a few seconds when the ignition is switched on.

Lighting of this warning light is accompanied by an audible signal and the message "**Top up engine fluid level**" on the display.

You must stop.

Wait for the engine to cool before topping up the level.

The cooling circuit is pressurised.

In the event of breakdown and to **prevent any risk of burns**, unscrew the cap by two turns to allow the pressure to drop.

When the pressure has dropped, remove the cap and top up the level.

Consult a CITROËN dealer.



Handbrake, low brake fluid level and Electronic Brake Force Distribution system fault warning light

Linked to the central (STOP) warning light.

This comes on each time the ignition is switched on.

Lighting of this warning light is accompanied by an audible signal and a message on the display indicating the cause of the warning:

- "**Handbrake on**", if the handbrake is applied or not fully released.
- "**Brake fluid level low**" if there is an excessive drop in brake fluid level (if the warning light remains on even when the handbrake is released).
- "**Braking fault**" is displayed together with the ABS warning light, indicating a malfunction of the Electronic Brake Force Distribution system. **You must stop.**

Consult a CITROËN dealer.



Anti-lock braking system (ABS) warning light

This comes on for a few seconds each time the ignition is switched on.

If the warning light remains on or comes on above 8 mph (12 km/h), this indicates an ABS malfunction.

However, the vehicle retains conventional servo-assisted braking.

Lighting of this warning light, accompanied by an audible signal and the message "**ABS fault**" on the display, indicates an ABS fault.

Consult a CITROËN dealer.



Battery charge warning light

This comes on for a few seconds when the ignition is switched on. Lighting of this warning light, when the engine is running, accompanied by an audible signal and the message "**Battery charge fault**" on the display, indicates one of the following:

- faulty operation of the charging circuit,
- slack battery or starter terminals,
- a cut or slack alternator belt,
- an alternator failure.

Consult a CITROËN dealer.



Emission control system warning light

This comes on for a few seconds each time the ignition is switched on.

If it comes on with the engine running, accompanied by an audible signal and the message on the display:

- "**Antipollution fault**", this indicates a failure of the emission control system
- "**Catalytic converter fault**", this indicates a malfunction of the injection or ignition system. There is a risk of damage to the catalytic converter (petrol engine only).

Consult a CITROËN dealer.



Diesel engine pre-heat warning light

Wait until the warning light goes out before starting the engine.

If the temperature is high enough, the warning light comes on for less than one second. You can start the engine without waiting.



Low fuel level warning light

This comes on for a few seconds when the ignition is switched on.

When the ignition is on, it is accompanied by an audible signal and the message "**Fuel level low**" on the display.

If it flashes with the fuel gauge needle in the lowest position, when the ignition is on, this indicates a malfunction of the fuel gauge.

When this warning light first comes on, you have enough fuel left to drive **approximately 30 miles (50 km)**.

Capacity of the tank:

- approximately 55 litres for petrol engines,
- approximately 60 litres for Diesel engines.



Water in diesel filter indicator*

There is a risk of damage to the injection system.

Consult a CITROËN dealer as soon as possible.

* According to country.



Seat belt not fastened warning light*

When the ignition is switched on, this indicator light comes on if the driver has not fastened his seat belt.

Above 12 mph (20 km/h), the warning light flashes for two minutes. Once the two minutes have elapsed, the warning light remains on until the driver fastens his seat belt.



Passenger air bag disarmed warning light*

Lighting of this warning light is accompanied by the message "**Passenger air bag deactivated**" on the display.

If the passenger air bag is disarmed, the warning light comes on when the ignition is switched on and it remains on.

Always consult a CITROËN dealer if the warning light flashes.



Front and side air bags warning light

This comes on for a few seconds when the ignition is switched on.

With the engine running, illumination of this warning light accompanied by an audible signal and the message "**Air bag fault**" on the multifunction display, indicates a fault in the air bags.

Consult a CITROËN dealer.

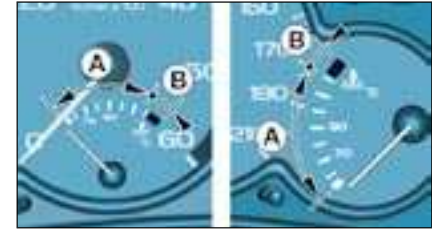

Coolant temperature indicator

- needle in zone **(A)**, the temperature is correct,
- needle in zone **(B)**, the temperature is too high. The central **STOP** warning light flashes, accompanied by an audible signal and the message "**Engine coolant temp. too high**" on the display.

You must stop.

Consult a CITROËN dealer.

* According to country.



Seat belt not fastened warning light*

When the ignition is switched on, this indicator light comes on if the driver has not fastened his seat belt.

Above 12 mph (20 km/h), the warning light flashes for two minutes. Once the two minutes have elapsed, the warning light remains on until the driver fastens his seat belt.



Passenger air bag disarmed warning light*

Lighting of this warning light is accompanied by the message "**Passenger air bag deactivated**" on the display.

If the passenger air bag is disarmed, the warning light comes on when the ignition is switched on and it remains on.

Always consult a CITROËN dealer if the warning light flashes.



Front and side air bags warning light

This comes on for a few seconds when the ignition is switched on.

With the engine running, illumination of this warning light accompanied by an audible signal and the message "**Air bag fault**" on the multifunction display, indicates a fault in the air bags.

Consult a CITROËN dealer.

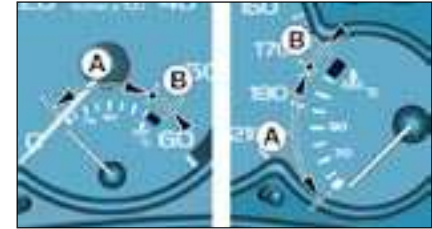

Coolant temperature indicator

- needle in zone **(A)**, the temperature is correct,
- needle in zone **(B)**, the temperature is too high. The central **STOP** warning light flashes, accompanied by an audible signal and the message "**Engine coolant temp. too high**" on the display.

You must stop.

Consult a CITROËN dealer.

* According to country.

22 - INSTRUMENTS, CONTROLS and DISPLAYS

INSTRUMENT PANEL DISPLAY

After switching on the ignition, three functions are shown in succession:

- service indicator,
- engine oil level indicator,
- total distance recorder/total and trip distances.

Note: the total and trip distances are displayed for 30 seconds when the ignition is switched off, on opening the driver's door, as well as on locking and unlocking the vehicle.

Service indicator

This is a visual reminder of when the next service is due. This service is to be carried out according to the manufacturer's servicing schedule.

Operation

As soon as the ignition is switched on and for 5 seconds, the spanner symbolising "service operation" is lit. The trip recorder display shows the distance remaining (in round figures) before the next service.

Example: 4,800 miles/km remain before the next service is due. When the ignition comes on and for 5 seconds the display shows:



5 seconds after the ignition is switched on, the total distance recorder resumes normal operation and the display shows the total or trip distances.



The distance remaining before the next service is less than 500 miles (1,000 km).

Example: 400 miles (900 km) remain before the next service is due.

When switching on the ignition and for 5 seconds, the display shows:



5 seconds after the ignition is switched on, the total distance recorder resumes normal operation and the symbol remains lit.

This indicates that a service should be carried out shortly. The display shows the total or trip distances.

The service is overdue.

Each time the ignition is switched on and for 5 seconds, the symbol and the excess distance flash.

Example: the service is overdue by 300 miles/km. The service should be carried out very shortly.

When the ignition is switched on and for 5 seconds, the display shows:



5 seconds after the ignition is switched on, the total distance recorder resumes normal operation and the symbol remains lit. The display shows the total or trip distances.

Note: the spanner lights if the two-year interval has been exceeded.

Resetting the service indicator



Your CITROËN dealer carries out this operation after each service.

The reset procedure is as follows:

- Switch off the ignition.
- Press and hold button 1.
- Switch on the ignition.

The display begins a 10 second count-down.

- Keep button 1 pressed for 10 seconds.

The display shows [= 0] and the spanner disappears.

Engine oil level indicator

When the ignition is switched on, the engine oil level is indicated for approximately 10 seconds, after the service information.

Surplus of oil



Flashing of the six squares and displaying of "max" indicate a surplus of oil which could damage the engine.

If the surplus of oil is confirmed by a check using the dipstick, contact a CITROËN dealer without delay.

Lack of oil



Flashing of the six segments and displaying of "min" indicate a lack of oil which could damage the engine.

If the lack of oil is confirmed by a check using the dipstick, it is essential that the level is topped up.

Oil level indicator fault



Flashing of the six segments indicates a malfunction of the oil level indicator.

There is a risk of damage to the engine. Consult a CITROËN dealer.

The level read on the dipstick or on the indicator will only be correct if the vehicle is on level ground and the engine has been off for more than 15 minutes.

Total distance recorder



Briefly pressing button **1** alternates between the total and trip distance displays.

To reset the trip recorder to zero, when it is displayed press button **1** until zeros appear.

LIGHTING RHEOSTAT



With the lights on, press the button to vary the intensity of the lighting of the instruments and controls. When the lighting reaches the minimum (or maximum) setting, release the button then press it again to increase (or reduce) the brightness.

As soon as the lighting is of the required brightness, release the button.

CLOCK



Button **1**: hour adjustment

Button **2**: minute adjustment

Press and hold the button for rapid advance.

DISPLAY A

This displays the following information:

- the time,
- the date,
- the audio system displays,
- a door check (e.g.: "left front door open"),
- warning messages (e.g. "remote control battery flat") or information messages (e.g. "economy mode active"), displayed temporarily.

Adjusting the parameters display A

Press and hold button **A** for two seconds to access the settings; the data flashes, indicating it is ready to be modified.

Then, each press of button **A** scrolls through the various data in the following order:

- language of information displayed,
- hours (12 then 24 hour mode),
- minutes,
- year,
- month,
- day.

Pressing button **B** alters the value of the parameter selected. Press and hold for rapid advance (return to start after the last possible value).





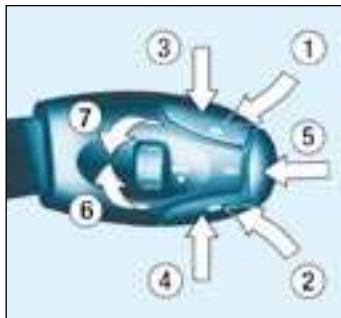

After 7 seconds with no action, the standard display returns; the modified data is now recorded.

26 - AUDIO EQUIPMENT

AUDIO RD3



| Stalk movement | Function |
|-------------------------------|--|
| 1 - Press (behind) | Increase volume |
| 2 - Press (behind) | Decrease volume |
| 1 + 2 - Simultaneous press | Sound cut-off (mute); restoring of the sound by pressing any button |
| 3 - Press | Automatic search of higher frequencies (radio) Selection of the next track (CD) |
| 4 - Press | Automatic search of lower frequencies (radio) Selection of the previous track (CD) |
| 5 - Press the end | Change of source (radio/CD) |
| 6 - Rotation (clockwise) | Selection of next station stored in memory (radio) |
| 7 - Rotation (anti-clockwise) | Selection of previous station stored in memory (radio) |

| Button | | Function |
|---------------|---|---|
| A | | Radio on/off. |
| B | - | Decrease volume. |
| C | + | Increase volume. |
| D | RDS | RDS function on/off. |
| | | Press for more than 2 seconds: regional following mode on/off. |
| E | TA | Traffic information priority on/off. |
| | | Press for more than 2 seconds: PTY function on/off. |
| H |  | Increase the setting of the functions associated with button |
| I |  | Decrease the setting of the functions associated with button H . |
| J |  | Réglage inférieur des fonctions associées à la touche H . |
| L |  | Manual and automatic search of higher frequency. |
| | | Selection of next CD track and PTY (radio). |
| M | MAN | Manual/automatic operation of buttons L and N . |
| N |  | Manual and automatic search of lower frequency. |
| | | Selection of previous CD track and PTY (radio). Selection of previous CD track and PTY (radio). |
| Q | CD | Selection of CD. |
| | | Press for more than 2 seconds: shuffle. |
| R | Radio | Selection of radio. Selection of FM1, FM2, FMast and AM wavebands. |
| | | Press for more than 2 seconds: automatic storing of stations in memory (autostore). |
| S |  | Ejection of CD. |
| 1 to 6 | 12 34 56 | Selection of station stored in memory. |
| | | Press for more than 2 seconds: storing of a station in memory. |

GENERAL FUNCTIONS



On/off

With the ignition key in the accessories or ignition position, press button **A** to switch the set on or off.

The set can operate for 30 minutes without the vehicle ignition being switched on.

Anti-theft system

The audio system is coded in such a way that it can operate only on your vehicle. It would not function if fitted to another vehicle.

The anti-theft system is automatic and requires no action on your part.

ADJUSTING THE VOLUME



Press button **C** to increase the volume, or button **B** to decrease it.

Continuous pressure on buttons **C** and **B** allows a gradual adjustment of the volume.

AUDIO SETTINGS



Press button **H** several times in succession to access the bass (**BASS**), treble (**TREB**), loudness (**LOUD**), fader (**FAD**), balance (**BAL**) and automatic volume correction.

Exit from audio mode is automatic after a few seconds without pressing any button, or by pressing button **H** after configuration of the automatic volume correction.

Note: bass and treble settings are specific to each source. It is possible to set them differently for radio, cassette (**RB3**), CD (**RD3**) and CD changer.

Adjusting the bass



When "**BASS**" is displayed, press button **I** or **J** to vary the setting.

- "**BASS -9**" for a minimum bass setting,
- "**BASS 0**" for a normal setting,
- "**BASS +9**" for a maximum bass setting.

Adjusting the treble

When "**TREB**" is displayed, press button **I** or **J** to vary the setting.

- "**TREB -9**" for a minimum treble setting,
- "**TREB 0**" for a normal setting,
- "**TREB +9**" for a maximum treble setting.

Adjusting the loudness

This function automatically emphasises bass and treble tones. Press button **I** or **J** to switch the function on or off.

Adjusting the front/rear sound distribution (Fader)

When "**FAD**" is displayed, press button **I** or **J**.

Button **I** increases the volume in the front.

Button **J** increases the volume in the rear.

Adjusting the right/left sound distribution (Balance)

When "**BAL**" is displayed, press button **I** or **J**.

Button **I** increases the volume on the right-hand side.

Button **J** increases the volume on the left-hand side.

Automatic volume correction

This function enables the volume to be automatically adjusted depending on the level of noise produced by the speed of the vehicle.

Press buttons **I** or **J** to switch the function on or off.

RADIO

Notes on radio reception

Your car radio is subject to phenomena which do not affect domestic radio sets. Both AM (MW/LW) and FM reception are subject to various forms of interference. This is no reflection on the quality of the equipment, but is due to the nature of the signals and the way in which they are transmitted.

On MW/LW, interference may be noticed when passing under high voltage power lines or bridges, or in tunnels.

On FM, interference may be the result of increasing distance from the transmitter, deflection of the signals by obstacles (mountains, hills, buildings, etc.), or of being in an area which is not covered by a transmitter.

Selecting radio mode



Press button **R**.

Selecting a waveband

Briefly press button **R** to select the FM1, FM2, FMast and AM wavebands.

Adjusting the front/rear sound distribution (Fader)

When "**FAD**" is displayed, press button **I** or **J**.

Button **I** increases the volume in the front.

Button **J** increases the volume in the rear.

Adjusting the right/left sound distribution (Balance)

When "**BAL**" is displayed, press button **I** or **J**.

Button **I** increases the volume on the right-hand side.

Button **J** increases the volume on the left-hand side.

Automatic volume correction

This function enables the volume to be automatically adjusted depending on the level of noise produced by the speed of the vehicle.

Press buttons **I** or **J** to switch the function on or off.

RADIO

Notes on radio reception

Your car radio is subject to phenomena which do not affect domestic radio sets. Both AM (MW/LW) and FM reception are subject to various forms of interference. This is no reflection on the quality of the equipment, but is due to the nature of the signals and the way in which they are transmitted.

On MW/LW, interference may be noticed when passing under high voltage power lines or bridges, or in tunnels.

On FM, interference may be the result of increasing distance from the transmitter, deflection of the signals by obstacles (mountains, hills, buildings, etc.), or of being in an area which is not covered by a transmitter.

Selecting radio mode



Press button **R**.

Selecting a waveband

Briefly press button **R** to select the FM1, FM2, FMast and AM wavebands.

30 - AUDIO EQUIPMENT

Automatic station search



Briefly press button **L** or **N** to search for the station immediately above or below. By continuing to press the button in the direction selected, you will obtain continuous scrolling of the frequency.

The scrolling stops at the first station found as soon as the button is released.

If the **TA** traffic information programme is selected, only stations broadcasting this type of programme are selected.

Searching for a station occurs first in "**LO**" sensitivity (selection of the most powerful transmitters) during scanning of the waveband, then in "**DX**" sensitivity (selection of the weakest and most distant transmitters).

To make a direct search in "**DX**" sensitivity, press button **L** or **N** twice.

Manual station search

Press the "**MAN**" button.

Briefly press button **L** or **N** to increase or decrease the frequency displayed.

By continuing to press the button in the direction selected, you will obtain continuous scrolling of the frequency.

The scrolling stops at the first station found as soon as the button is released.

Pressing the "**MAN**" button again returns you to automatic station search.

Manual storing of stations in the memory

Select the station required.

Press one of the buttons "**1**" to "**6**" for more than two seconds.

The sound stops then becomes audible again, confirming that the station has been stored in the memory.

Automatic storing of FM stations in the memory (autostore)



Press and hold button **R** for more than two seconds.

Your radio automatically stores the 6 stations with the strongest signal in **FM**. These stations are stored in the FMast waveband.

If it is not possible to find 6 stations, the remaining memories are empty.

Recalling stations stored in the memory

For each waveband, briefly press buttons "**1**" to "**6**" to recall the corresponding station.

RDS

Using the RDS (Radio Data System) function on FM

Radio Data System allows you to continue listening to the same station, whatever frequency it is using for the region you are going through.



Briefly press the "RDS" button to switch the function on or off.

The multi-function display will show:

- "RDS" if the function is selected.
- "(RDS)" if the function is selected but not available.

RDS station following

The display indicates the name of the station selected. The radio is continually searching for the station which has the best reception and which is transmitting the same programme.

Traffic information programme



Press the "TA" button to switch the function on or off.

The multi-function display will show:

- "TA" if the function is selected,
- "(TA)" if the function is selected but not available.

Any traffic information flash will be given priority, whatever source you are listening to (radio, cassette, CD or CD changer).

If you wish to interrupt a message, press the "TA" button; this switches the function off.

Note: the volume of traffic information announcements is independent of the volume of normal radio listening. You can adjust it using the volume button. The setting will be stored and will be used when the next messages are broadcast.

Regional following mode (REG)

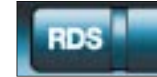

When they are part of a network, certain stations broadcast regional programmes in the various areas they serve. With regional following mode you can keep listening to the same programme.

Press the "RDS" button for more than two seconds to switch the **REG** function on or off.

32 - AUDIO EQUIPMENT

PTY function

This allows you to listen to stations broadcasting a specific type of programme (news, culture, sport, rock, etc.).



With **FM** selected, press the "**TA**" button for more than two seconds to switch this function on or off.

To search for a **PTY** programme:



- select the **PTY** function,
- briefly press button **L** or **N** to scroll down the list of the various types of programmes offered,
- when the programme of your choice is displayed, keep button **L** or **N** pressed for more than two seconds to carry out an automatic search (after an automatic search the **PTY** function is switched off).

In **PTY** mode the different types of programmes can be stored in the memory. To do this, press the pre-selection buttons "**1**" to "**6**" for more than two seconds. Briefly press the corresponding button to recall the type of programme stored in the memory.

EON system

This connects stations which are part of the same network. It enables the broadcast of traffic information, by a station that is part of the same network as the station to which you are listening.

This service is available when you have selected the **TA** traffic information programme or the **PTY** function.

COMPACT DISC

Selecting CD mode



After insertion of a disc, printed face upwards, the player starts automatically.

If a disc is already inserted, press button **Q**.

Ejection of a disc

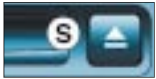

Press button **S** to eject the disc from the player.

Selecting a track



Press button **L** to select the next track.

Press button **N** to return to the start of the current track or to select the previous track.

Accelerated play

Keep button **L** or **N** pressed for forwards or backwards accelerated play.

Accelerated play stops as soon as the button is released.

Shuffle

When the CD player is selected, keep button **Q** pressed for two seconds. The tracks will be played in random sequence. Pressing the button again for two seconds returns you to normal play.

Shuffle mode is de-activated each time the audio system is switched off.



The use of copied compact discs may cause faults.

Insert circular compact discs only.



VENTILATION

1. Windscreen de-icing or demisting vents.
2. Front window de-icing or demisting vents.
3. Side vents.
4. Centre vents.
5. Air outlets to front footwells.

Advice on operation

Select the air distribution most suited to your requirements and the climatic conditions.

Gradually adjust the temperature setting for your comfort.

Position the air control in the "Outside Air" position.

For perfectly even air distribution, take care not to obstruct the exterior air intake grille and the vents. Check that the passenger compartment filter is in good condition.

When the engine is cold, to prevent too great a distribution of cold air, the ventilation will increase to its optimum level gradually.

In order to be effective, the air conditioning (**A/C** button), should only be used with the windows closed.

If the interior temperature remains very high following a prolonged period parked in the sun, do not hesitate to ventilate the passenger compartment for a few minutes.

The air conditioning system does not contain chlorine and does not present any danger to the ozone layer.

Operate the air conditioning system for 5 to 10 minutes, once or twice a month, to keep it in perfect working order.

The water created by the air conditioning condensation is discharged via an opening provided for this purpose. Therefore, a puddle of water may form underneath the vehicle when stationary.

If the system does not produce cold air, do not use it and contact a CITROËN dealer.



De-icing the rear windows and mirrors

With the engine running, pressing the control de-ices the rear windows and mirrors.

It switches off automatically after approximately twelve minutes.

Pressing the control again switches the de-icing system on again for twelve minutes.

It is possible to switch off the de-icing by pressing the control before the twelve minutes have elapsed.



HEATING

1. Air flow adjustment



Turn the control from position **1** to position **4** to obtain an air flow sufficient to ensure your comfort.

2. Air flow adjustment and air intake control



Turn the control from position **1** to position **4** to obtain an air flow sufficient to ensure your comfort.



Intake of exterior air.

This is the normal operating position.



Passenger compartment isolation.

This position prevents exterior odours and smoke entering the passenger compartment.

As soon as possible, position the control in the exterior air intake position to prevent misting of the windows.

3. Temperature adjustment

To be adjusted to your requirements.

From blue (exterior temperature) to red (hot).



Windscreen, side windows and footwells.



Footwells.

These settings are recommended for cold climates.

4. Air distribution adjustment



Windscreen and side windows (de-icing/demisting).

To quickly de-ice or demist the windscreen and side windows:

- position the air intake control in the "Outside Air" position,
- turn the temperature and air flow controls to maximum,
- close the centre vents.



Centre and side vents.

This setting is recommended for high temperatures.



AIR CONDITIONING

1. Air conditioning control

The air conditioning is designed to operate in all seasons. In summer, it enables the temperature to be lowered and in winter, above 0 °C, it increases the effectiveness of the demisting.



Press the switch to activate the air conditioning. The indicator light comes on.

The air conditioning does not operate while the air flow adjustment control is in the minimum position.

Note: to optimise the operation of the air conditioning, leave the vents open.

2. Air flow adjustment and air intake control



Turn the control from position 1 to position 4 to obtain an air flow sufficient to ensure your comfort.



Intake of exterior air.

This is the normal operating position.



Recirculation of interior air.

This position prevents exterior odours and smoke entering the passenger compartment.

Used simultaneously with the air conditioning, recirculation enables both heating and cooling performance to be improved.

Used without the air conditioning, recirculation may result in misting of the windows.

As soon as possible, position the control in the exterior air intake position.

3. Temperature adjustment

To be adjusted to your requirements. From blue (cold when the air conditioning is on) to red (hot).

4. Air distribution adjustment



Windscreen and side windows (de-icing/demisting).

To quickly de-ice or demist the windscreen and side windows:

- turn the temperature and air flow controls to maximum,
- close the centre vents,
- position the air intake control in the "Outside Air" position,
- start the air conditioning.



Windscreen, side windows and footwells.



Footwells.

These settings are recommended for cold climates.



Centre and side vents.

This setting is recommended for high temperatures.

Additional heater

Vehicles which are fitted with an HDI engine may be fitted with automatic additional heating to improve your comfort.

When the engine is idling or the vehicle is stationary, it is quite normal to notice a high-pitched whistling noise and a slight emission of smoke and odour.

40 - SEATS



FRONT SEATS

1. Head restraint height adjustment

To raise or lower the restraint, slide it.

The adjustment is correct when the upper edge of the head restraint is level with the top of the head.

To remove the head restraint, place it in the top position, press the tabs and pull it upwards.

To put it back in position, locate the stems of the restraint in the holes, taking care to keep them in line with the seat back.



Never drive with the head restraints removed; they must be in place and correctly adjusted.

2. Armrests

These can be folded back.

3. Seat back angle adjustment



A. Turn the knob.



B. Pull the lever (version with one sliding side door only).

4. Forwards-backwards adjustment

Lift the control and slide the seat forwards or backwards.

5. Storage drawer (version with passenger air bag)

There is a storage drawer under the front passenger seat.

To open it, lift it and pull.



Do not place heavy objects in the drawers.

6. Heated seats switch

Press the switch. The temperature is controlled automatically.

Pressing the switch again stops operation.

Note: the command for activation of heating of the seat(s) remains memorised for two minutes after the ignition has been switched off.



7. Access to rear seats (version with one sliding side door only)

Lift the control to fold the seat back and move the seat forwards.

On repositioning, the seat returns to its initial position (driver's side).



No person or object must prevent the seat from returning to its initial position; return to this position is necessary for the seat to lock in place.

42 - SEATS



MULTIFUNCTION PASSENGER SEAT

To fold the seat back:

Pull the control 1 upwards and tilt the seat back.

This provides a flat surface, recesses for drinks and a strap for retaining documents.

To fold the seat fully:

Pull the control 2 upwards and tilt the whole seat.

It is not necessary to remove the head restraint.

This provides access to a box which enables you to store objects so that they cannot be seen from outside the vehicle.

If your vehicle is not fitted with a load blocking partition, it can accommodate long objects (up to 2.10 m).

These must be placed on the front edge of the floor and secured using the rear bar of the boot or using the lashing rings.

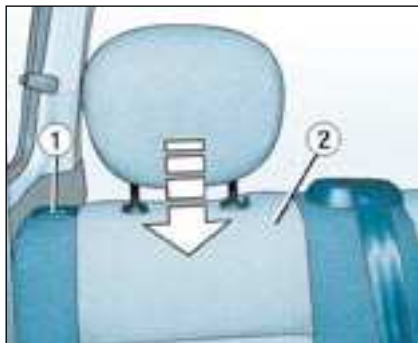

REAR BENCH SEAT

To fold the rear bench seat:

- lower the head restraint,
- press control **1** to unlock the seat back **2**,

- fold the seat back **2** onto the seat,
- place the seat in the "folded" position.

When repositioning:

- tilt the folded seat rearwards,
- lift the seat back,
- check that the seat is locked correctly.

Take care not to trap the seat belts.

GENERAL POINTS RELATING TO CHILD SEATS

Although one of CITROËN's main criteria when designing your vehicle, the safety of your children also depends on you.

For maximum safety, please follow these precautions:

- **all children under the age of 12 or less than one metre fifty tall must travel in approved child seats suited to their weight,** on seats fitted with a seat belt or ISOFIX mountings*.
- **a child weighing less than 9 kg must travel in the "rearwards-facing" position in the front.**

INSTALLING A CHILD SEAT USING A THREE POINT SEAT BELT

"Rearwards-facing"

When a "rearwards-facing" child seat is installed on the **front passenger seat**, it is essential that the passenger air bag* is disarmed. Otherwise, **the child would risk being seriously injured or killed if the air bag were to inflate.**

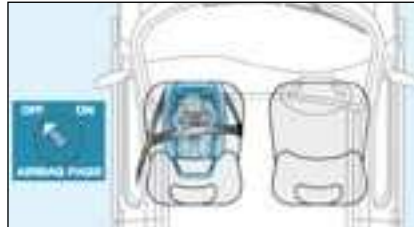

"Forwards-facing"

When a "forwards-facing" child seat is installed on the **front passenger seat**, adjust the vehicle's seat to the intermediate longitudinal position with the seat back upright and leave the passenger air bag armed.

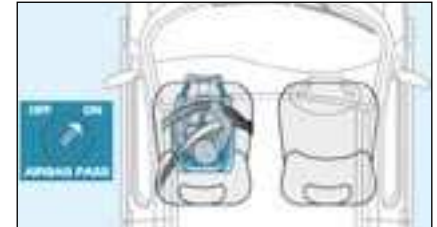

Intermediate longitudinal position

* The rules for transporting children are specific to each country. Consult the current legislation in your country.



ADVICE ON CHILD SEATS

The incorrect installation of a child seat in a vehicle compromises the child's protection in the event of an accident.

Remember to fasten the seat belts or the child seat harnesses **keeping the slack** in relation to the child's body to a minimum, even for short journeys.

For optimum installation of the "forward facing" child seat, ensure that the back of the child seat is in contact with the back of the vehicle's seat and that the head restraint does not cause any discomfort.

If the head restraint has to be removed, ensure that it is stored or attached securely to prevent it from being thrown around the vehicle in the event of sharp braking.

Children under the age of 10 must not travel in the "forward facing" position on the front passenger seat, unless the rear seats are already occupied by other children, cannot be used or are absent.

Disarm the passenger air bag when a "rear facing" child seat is installed on the front seat. Otherwise, the child would risk being seriously injured or killed if the air bag were to inflate.

Installing a booster seat

The chest part of the seat belt must be positioned on the child's shoulder without touching the neck.

Ensure that the lap part of the seat belt passes correctly over the child's thighs.

CITROËN recommends the use of a booster seat which has a back, fitted with a seat belt guide at shoulder level.

As a safety precaution, do not leave:

- one or more children alone and unsupervised in a vehicle,
- a child or an animal in a vehicle which is exposed to the sun, with the windows closed,
- the keys within reach of children inside the vehicle.



To prevent accidental opening of the doors, use the "Child lock".

Take care not to open the rear windows by more than one third.

To protect young children from the rays of the sun, fit side blinds on the rear windows.



Passenger air bag OFF

CHILD SEATS RECOMMENDED BY CITROËN

CITROËN offers a complete range of recommended child seats which are **secured using a three point seat belt**:

Group 0: from birth to 10 kg
Group 0+: from birth to 13 kg



L1
 "ROMER Baby-Safe Plus"
 Installed in the rear-facing position

Groups 1, 2 and 3: from 9 to 36 kg



L2
 "KIDDY Life"
 For the safety of young children (from 9 to 18 kg), CITROËN recommends use of the restraining cushion.

Groups 2 and 3: from 15 to 36 kg







L3
 "RECARO Start"



L4
 "KLIPPAN Optima"
 From the age of 6 years (approximately 22 kg), the booster is used on its own.

INSTALLING CHILD SEATS SECURED USING THE SEAT BELT

In accordance with European regulations, this table indicates the options for the installation of child seats secured using the seat belt and universally approved **(a)**, in accordance with the weight of the child and the seat in the vehicle:

| Seat | | Weight of the child and indicative age | | | |
|--|---|--|--|---|--|
| | | Below 13 kg (groups 0 (b) and 0+) Up to 1 year approx | From 9 to 18 kg (group 1) From 1 to 3 years approx | From 15 to 25 kg (group 2) From 3 to 6 years approx | From 22 to 36 kg (group 3) From 6 to 10 years approx |
| Front passenger seat (c) |  | U | U | U | U |
|  Rear side seat |  | U | U | U | U |
|  Rear centre seat |  | U | U | U | U |

(a) Universal child seat: child seat which can be installed in all vehicles using the seat belt.

(b) Group 0: from birth to 10 kg.

(c) Consult the legislation in force in your country before installing your child on this seat.

U Seat suitable for the installation of a child seat secured using a seat belt and universally approved, "rear facing" and/or "forward facing".



ADVICE ON CHILD SEATS

The incorrect installation of a child seat in a vehicle compromises the child's protection in the event of an accident.

Remember to fasten the seat belts or the child seat harnesses **keeping the slack** in relation to the child's body to a minimum, even for short journeys.

For optimum installation of the "forward facing" child seat, ensure that the back of the child seat is in contact with the back of the vehicle's seat and that the head restraint does not cause any discomfort.

If the head restraint has to be removed, ensure that it is stored or attached securely to prevent it from being thrown around the vehicle in the event of sharp braking.

Children under the age of 10 must not travel in the "forward facing" position on the front passenger seat, unless the rear seats are already occupied by other children, cannot be used or are absent.

Disarm the passenger air bag when a "rear facing" child seat is installed on the front seat. Otherwise, the child would risk being seriously injured or killed if the air bag were to inflate.

Installing a booster seat

The chest part of the seat belt must be positioned on the child's shoulder without touching the neck.

Ensure that the lap part of the seat belt passes correctly over the child's thighs.

CITROËN recommends the use of a booster seat which has a back, fitted with a seat belt guide at shoulder level.

As a safety precaution, do not leave:

- one or more children alone and unsupervised in a vehicle,
- a child or an animal in a vehicle which is exposed to the sun, with the windows closed,
- the keys within reach of children inside the vehicle.



To prevent accidental opening of the doors, use the "Child lock".

Take care not to open the rear windows by more than one third.

To protect young children from the rays of the sun, fit side blinds on the rear windows.



"ISOFIX" MOUNTINGS

Your vehicle has been approved in accordance with the **ISOFIX regulation**.

The seats, represented below, are fitted with regulation ISOFIX mountings:



These are two rings located between the seat back and the seat cushion.

This ISOFIX mounting system guarantees reliable, safe and fast fitting of the child seat in your vehicle.



The **ISOFIX child seats** are fitted with two locks which are secured easily on these rings.



ISOFIX CHILD SEAT RECOMMENDED BY CITROËN AND APPROVED FOR YOUR VEHICLE

Isfix KIDDY

Group 0+: from birth to 13 kg

Group 1: from 9 to 18 kg



Installed in the rear facing position,
on the rear side seat only.

Installed in the forwards facing position.

The body of this child seat must be in contact with the back of the vehicle's front seat.

It is imperative that the vehicle's front seat is adjusted to the intermediate longitudinal position.

This child seat can also be used on seats which are not fitted with ISOFIX mountings.

In this case, it is compulsory to secure the child seat to the vehicle's seat using the three-point seat belt.

Follow the instructions for fitting the child seat indicated in the seat manufacturer's installation guide.



SEAT BELTS

Seat belt height adjustment:

To lower or raise: slide the control downwards or upwards.

Locking the seat belts

Pull the strap, then insert the end into the buckle.

Check that the seat belt is fastened correctly by pulling the strap.



Unfastening the seat belts

Press the button on the buckle.

Front seat belts with pre-tensioner

Safety in the event of frontal impacts has been improved by the introduction of pre-tensioning seat belts for the front seats.

Depending on the seriousness of the impact, the pre-tensioning system instantly tightens the seat belts and pulls them against the bodies of the occupants.

The pre-tensioning seat belts are armed when the ignition is on.



Rear seat belts

The rear seats are fitted with three-point inertia reel seat belts (two-part rear seat, 1/3 - 2/3).



The driver must ensure that the passengers use the seat belts correctly and that they are all properly restrained before setting off.

Wherever you are seated in the vehicle, always fasten your seat belt, even for short journeys.

Do not invert the seat belt buckles as they will not fulfil their role fully.

If the seats have armrests*, the lap part of the seat belt must always pass under the armrest.

The seat belts are fitted with an inertia reel permitting automatic adjustment of the length of the strap to your size. The seat belt is stored automatically when not in use.

Before and after use, ensure that the seat belt is rolled up correctly.

The lower part of the strap must be positioned as low as possible on the pelvis.

The upper part must be positioned in the hollow of the shoulder.

The inertia reels are fitted with an automatic locking device which comes into operation in the event of a collision, on emergency braking or if the vehicle rolls over. You can release the device by pulling rapidly on the strap and releasing it.

In order to be effective, a seat belt:

- must be tightened as close to the body as possible,
- must restrain one adult only,
- must not bear any trace of cuts or fraying,
- must be pulled in front of you with a smooth movement, checking that it does not twist,
- must not be transformed or modified to avoid altering its performance.

In accordance with current safety regulations, all repairs and checks must be carried out by a CITROËN dealer who guarantees that the work is carried out correctly.

Have your seat belts checked regularly by a CITROËN dealer and particularly if the straps show signs of damage.

Clean the seat belt straps with soapy water or a textile cleaning product, sold by CITROËN dealers.



After folding or moving a seat or rear bench seat, ensure that the seat belt is positioned and rolled up correctly.

Recommendations for children:

- use a suitable child seat if the passenger is less than 12 years old or shorter than one metre fifty,
- do not use the strap-guide* when a child seat is installed.
- never use the same seat belt to secure more than one person,
- never allow a child to travel on your lap.

Depending on the nature and seriousness of the impacts, the pre-tensioning device may be triggered before and independently of the air bags. Triggering of the pre-tensioners is accompanied by a slight emission of harmless smoke and a noise, due to the activation of the pyrotechnic cartridge incorporated in the system.

In all cases, the air bag warning light comes on.

Following an impact, have the seat belts system checked, and if necessary replaced, by a CITROËN dealer.

* According to model.

KEYS

The keys allow you to switch on the ignition and operate the passenger air bag disarming switch as well as to independently operate the locks on the doors and the fuel filler cap.

Central locking

From the front doors, the keys allow you to lock and unlock the doors.

If one of the doors is open, the central locking does not work.

The remote control performs the same functions at a distance.



Remote control

Locking

Press button **A** to lock the vehicle.

This is confirmed by fixed lighting of the direction indicators for approximately two seconds.

Unlocking

Press button **B** to unlock the vehicle.

This is confirmed by rapid flashing of the direction indicators.

Note: if the vehicle is locked and unlocking is activated inadvertently, unless the doors are opened within 30 seconds, the vehicle will lock automatically.

Locating your vehicle

To locate your vehicle, if you have locked it, in a car park:

- ☞ press button **A**, the courtesy lights come on and the direction indicators flash for a few seconds.



Changing the battery of the remote control

CR 2016/3 volt battery.

The information "battery flat" is given by an audible signal accompanied by the message **"Remote control battery flat"** on the screen.

To change the battery, unclip the casing using a coin at the ring.

If the remote control does not work after the battery has been changed, re-programme the remote control.

Programming the remote control

- ☞ Switch off the ignition.
- ☞ Switch the ignition on again.
- ☞ Press button **A** immediately for a few seconds.
- ☞ Switch off the ignition and remove the remote control key from the ignition lock. The remote control is now working again.

ELECTRONIC ENGINE IMMOBILISER

This locks the engine control system as soon as the ignition has been switched off and therefore prevents starting of the vehicle by anyone who does not have the key.

The ignition key has an electronic chip which has a special code. When the ignition is switched on, the code must be recognised for the vehicle to start.

If the system does not function correctly, the central locking button indicator light, situated in the centre of the fascia, flashes rapidly when the ignition is switched on (2nd notch), accompanied by an audible signal and a message on the display.

In this case your vehicle will not start.

Contact a CITROËN dealer as soon as possible.

Key in ignition

A buzzer sounds on opening the driver's door, if the key has been left in the ignition.



Make a careful note of the number of each key. This number is coded on the label attached to the key.

The high frequency remote control is a sensitive system; do not operate it while it is in your pocket as there is a possibility that it may unlock the vehicle, without you being aware of it.

The remote control does not operate when the key is in the ignition, even when the ignition is switched off, except for reprogramming.

Do not operate the deadlocking function if there is anyone inside the vehicle.

Driving with the doors locked may make access to the passenger compartment by the emergency services more difficult in an emergency.

As a safety precaution (with children on board), remove the key from the ignition when you leave the vehicle, even for a short time.

Do not repeatedly press the buttons of your remote control out of range of your vehicle.

You run the risk of stopping it from working and the remote control would have to be reprogrammed.

When purchasing a second-hand vehicle, have the key codes memorised by a CITROËN dealer, to ensure that the keys in your possession are the only ones which can start the vehicle.

Do not make any modifications to the electronic engine immobiliser system.

If the keys are lost

Visit a CITROËN dealer with the vehicle's V5 registration certificate and your personal identification documents.

The CITROËN network will be able to retrieve the key code and the transponder code to order a replacement key.

KEYS

The keys allow you to switch on the ignition and operate the passenger air bag disarming switch as well as to independently operate the locks on the doors and the fuel filler cap.

Central locking

From the front doors, the keys allow you to lock and unlock the doors.

If one of the doors is open, the central locking does not work.

The remote control performs the same functions at a distance.



Remote control

Locking

Press button **A** to lock the vehicle.

This is confirmed by fixed lighting of the direction indicators for approximately two seconds.

Unlocking

Press button **B** to unlock the vehicle.

This is confirmed by rapid flashing of the direction indicators.

Note: if the vehicle is locked and unlocking is activated inadvertently, unless the doors are opened within 30 seconds, the vehicle will lock automatically.

Locating your vehicle

To locate your vehicle, if you have locked it, in a car park:

- ☞ press button **A**, the courtesy lights come on and the direction indicators flash for a few seconds.



Changing the battery of the remote control

CR 2016/3 volt battery.

The information "battery flat" is given by an audible signal accompanied by the message **"Remote control battery flat"** on the screen.

To change the battery, unclip the casing using a coin at the ring.

If the remote control does not work after the battery has been changed, re-programme the remote control.

Programming the remote control

- ☞ Switch off the ignition.
- ☞ Switch the ignition on again.
- ☞ Press button **A** immediately for a few seconds.
- ☞ Switch off the ignition and remove the remote control key from the ignition lock. The remote control is now working again.



THE ALARM SYSTEM*

The alarm offers two types of protection:

- **exterior protection:** the alarm sounds if **a door, the boot or the bonnet is opened**;
- **interior protection:** the alarm sounds if there is a variation in the **volume inside the vehicle (breaking of a window or movement inside the vehicle)**.

Setting the alarm

Switch the ignition off and get out of the vehicle.

Activate the alarm within five minutes following your exit from the vehicle, by locking using the remote control key (the red indicator light on the switch **1**, which can be seen from the outside, flashes once a second).

When the alarm is triggered, the siren sounds and the direction indicators flash for thirty seconds.

After it has been triggered, the alarm becomes operational again.

Note: if you wish to lock your vehicle without setting the alarm, lock it using the key in the door lock.

Warning

If, on setting the alarm, a door, the boot or the bonnet are not closed correctly, the siren sounds for a moment.

Close the vehicle correctly to set the alarm.

If the interior protection alarm is triggered ten times in succession, it is disarmed automatically. It must be set again in order for it to operate correctly.

Disarming the alarm

Unlock the vehicle using the remote control key (the red indicator light on the switch **1** goes out).

Note: if the warning light flashes, it is a sign that the alarm has been triggered in your absence.

To stop it, switch on the ignition.

Note: when the alarm is set, but the remote control no longer works:

- ☞ unlock the doors using the key and open the door; the alarm is triggered;
- ☞ switch the ignition on within ten seconds; the alarm is disarmed.

To set the alarm with exterior protection only.

If, while you are away from the vehicle, you wish to leave a window partially open or a pet inside the vehicle, you need to select exterior protection only:

- Switch off the ignition.
- Press the button **2** until the light **1** comes on continuously.
- Get out of the vehicle.
- Press the locking button of the remote control.
- The doors lock.
- The red light on the switch flashes once a second.

Malfunction

When the ignition is switched on, fixed lighting of the red indicator light, located in the centre of the fascia, indicates a siren connection fault.

Contact a CITROËN dealer to have the system checked.



Do not make any modifications to the alarm system, this could cause malfunctions.

* According to country.

ELECTRONIC ENGINE IMMOBILISER

This locks the engine control system as soon as the ignition has been switched off and therefore prevents starting of the vehicle by anyone who does not have the key.

The ignition key has an electronic chip which has a special code. When the ignition is switched on, the code must be recognised for the vehicle to start.

If the system does not function correctly, the central locking button indicator light, situated in the centre of the fascia, flashes rapidly when the ignition is switched on (2nd notch), accompanied by an audible signal and a message on the display.

In this case your vehicle will not start.

Contact a CITROËN dealer as soon as possible.

Key in ignition

A buzzer sounds on opening the driver's door, if the key has been left in the ignition.



Make a careful note of the number of each key. This number is coded on the label attached to the key.

The high frequency remote control is a sensitive system; do not operate it while it is in your pocket as there is a possibility that it may unlock the vehicle, without you being aware of it.

The remote control does not operate when the key is in the ignition, even when the ignition is switched off, except for reprogramming.

Do not operate the deadlocking function if there is anyone inside the vehicle.

Driving with the doors locked may make access to the passenger compartment by the emergency services more difficult in an emergency.

As a safety precaution (with children on board), remove the key from the ignition when you leave the vehicle, even for a short time.

Do not repeatedly press the buttons of your remote control out of range of your vehicle.

You run the risk of stopping it from working and the remote control would have to be reprogrammed.

When purchasing a second-hand vehicle, have the key codes memorised by a CITROËN dealer, to ensure that the keys in your possession are the only ones which can start the vehicle.

Do not make any modifications to the electronic engine immobiliser system.

If the keys are lost

Visit a CITROËN dealer with the vehicle's V5 registration certificate and your personal identification documents.

The CITROËN network will be able to retrieve the key code and the transponder code to order a replacement key.

FRONT DOORS AND SLIDING SIDE DOORS

Opening the doors from outside



Front doors



Side doors

Opening the doors from inside



Front doors

The driver's door opening control permits complete unlocking of the vehicle.

Locking/Unlocking from the inside

Front doors

To lock, lower button **A**.

The closing control of one of the front doors permits complete locking of the vehicle.

To unlock and open, lift button **A** and pull the handle towards you.

The driver's door opening control permits complete unlocking of the vehicle.



Side doors

Sliding side doors



The side door opening/closing control only controls the door concerned.

To close, push the control **B** forwards and slide the door.

To open, pull the control **B** rearwards and slide the door.



From the inside, the sliding side door is opened and closed using the handle.

A point of resistance at the end of the opening travel secures the door in the open position.



If the fuel tank cap is removed, the right-hand side door cannot be opened.

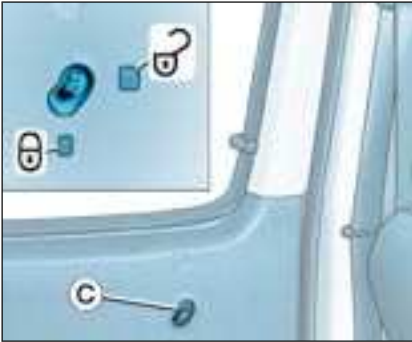

Locking from the inside

Lower or raise control **C** to lock or unlock from the inside.



Locking from the inside

Pressing control **D** operates the central locking, when the doors are closed.

Unlocking from the inside

Press control **D**.

It is **still** possible to open the doors from the inside.

Notes:

- doors locked and ignition off: the indicator light flashes,
- doors locked and ignition on: the indicator light remains on.

Automatic central locking

Your vehicle can lock automatically while driving (speed greater than 6 mph (10 km/h)). You can activate or deactivate this function.

Activation

Press and hold control **D**.

Activation of the function is accompanied by an audible signal and a message on the display.

Deactivation

Press and hold control **D**.

Deactivation of the function is accompanied by an audible signal.



Side door child lock

This prevents opening of the side door from the inside.

Turn the control a quarter turn using the ignition key.

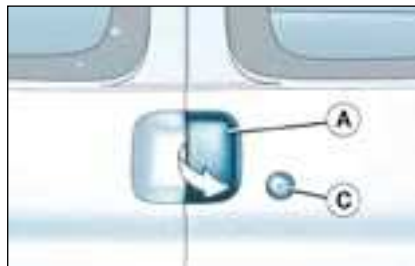

REAR DOORS

Opening the doors from outside

To open, pull the rear right door handle **A** towards you and open the rear left door by pulling the lever **B** on the inside.

You can unlock the rear doors by inserting the key in the lock **C**.

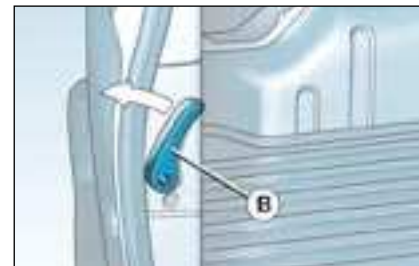



Side door child lock

This prevents opening of the side door from the inside.

Turn the control a quarter turn using the ignition key.

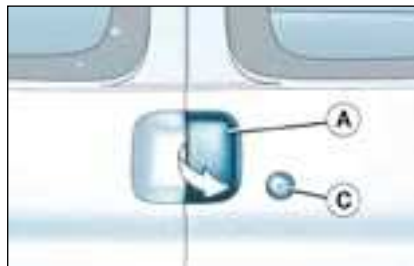

REAR DOORS

Opening the doors from outside

To open, pull the rear right door handle **A** towards you and open the rear left door by pulling the lever **B** on the inside.

You can unlock the rear doors by inserting the key in the lock **C**.





Opening the doors from inside

The rear door opening controls only unlock these doors.

To open, lift lever **D**.

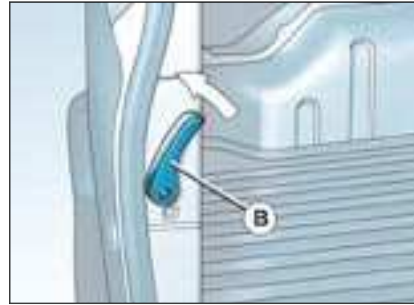

To open the other door, push lever **B**.

Note: when closing from the inside, close the right-hand door first ensuring that lever **B** is in the vertical position then close the left-hand door.

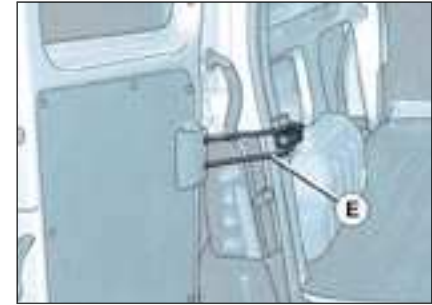

Opening the rear doors to 180°

To open the rear doors to 180°, release the check strap **E** towards you when the door is partially open.

When closing the door, the check strap hooks itself in place again automatically.



OPENING THE BONNET

Inside the vehicle: pull the handle on the left-hand side, under the fascia.

Outside the vehicle: lift the catch and raise the bonnet.



BONNET STRUT

Secure the strut to hold the bonnet open.

Before closing the bonnet, replace the strut in its housing.

To close

Lower the bonnet and release it at the end of its travel.

Check that the bonnet is locked.



FILLING WITH FUEL

Low fuel level



When the minimum fuel level in the tank is reached, this warning light comes on.

You have enough fuel remaining to drive for approximately 30 miles (50 km).

The engine must be switched off when filling with fuel.

☞ Insert the key then turn it to the left.

☞ Remove the cap.

A label reminds you which type of fuel to use.

When you fill your tank, do not continue after the third cut-off of the pump. This could cause your vehicle to malfunction.

The capacity of the tank is approximately 55 litres for petrol engines and 60 litres for Diesel engines.

☞ After filling the tank, lock the cap.



When the cap is removed, the right-hand sliding side door cannot be opened.

The key cannot be removed from the lock until the cap has been replaced on the fuel tank.



LIGHTS STALK

Front and rear lights

Selection is by turning ring **A**.



Lights off



Side lights



Dipped/main beam headlamps

Dipped/Main beam change

Pull the stalk towards you.

Note: with the ignition off, when the driver's door is opened, a buzzer sounds if you have left your lights on.

Front fog lamps and rear fog lamp

Rotate the ring forwards to switch on and backwards to switch off. The status is confirmed by the indicator light on the instrument panel.



Vehicles fitted with a rear fog lamp only (ring B)

Rotate the ring forwards.

This only operates with the dipped/main beam headlamps.



Vehicles fitted with front fog lamps and a rear fog lamp (ring B)

Front fog lamps (first rotation of the ring forwards).

Front and rear fog lamps (2nd rotation of the ring forwards).

Note: to switch off the rear fog lamp and the front fog lamps, turn the ring backwards twice in succession.

"Follow-me-home" lighting

In poor light, or at night, if you leave your vehicle, the side lights and dipped headlamps may remain on for approximately one minute.

To activate this function:

- place the key in the **STOP** position,
- place the lights stalk in position **0**,
- flash the headlamps,
- exit the vehicle and lock it.

Direction indicators (flashers)



Left: downwards.

Right: upwards.



In good or rainy weather, both day and night, the front fog lamps and the rear fog lamp are dazzling and are prohibited.

Do not forget to switch them off when they are no longer needed.

WINDSCREEN WIPER STALK

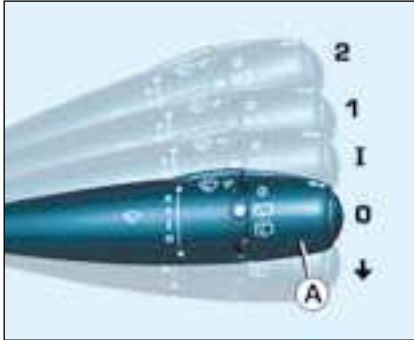

Windscreen wipers

- 2 Fast wipe (heavy rain).
- 1 Normal wipe (moderate rain).
- I Intermittent wipe.
- 0 Off.
- ↓ Single wipe (press downwards).

Operation

In position **1** or **2**, when the vehicle stops, the windscreen wiper changes to a lower wiping speed, then resumes its initial speed when the vehicle starts again.

In the Intermittent position, the wiping speed is proportional to the speed of the vehicle.

Windscreen and headlamp wash (according to country)

Pull the windscreen wiper stalk towards you. The windscreen wash then the windscreen wipers operate for a fixed period.

The headlamp wash is also activated, **if the headlamps are on.**



Rear windscreen wiper

Turn ring **A** to the first notch. The wiping speed is inversely proportional to the speed of the vehicle.

Automatic rear windscreen wiping

- ☞ place the front wipers stalk in a position other than **0**,
- ☞ engage reverse gear,
- ☞ the rear wiper operates with intermittent wiping.

Note: if a bicycle carrier is used, contact a CITROËN dealer to have this function disarmed.



Rear windscreen wash

Turn ring **A** past the first notch: the windscreen wash then the windscreen wiper operate for a fixed time.



In winter, in the event of a considerable amount of snow or ice, switch on the rear window demister. Once de-icing is complete, remove the snow or ice which has accumulated on the rear wiper blade. You can now operate the rear windscreen wiper.



ELECTRIC WINDOWS

1. Driver's electric window switch

2. Passenger electric window switch

You have two options:

- **Manual operation:**

Press switch **1**. The window stops as soon as the switch is released.

- **Automatic operation (driver):**

Press and hold switch **1**. One touch completely opens or closes the window.

Automatic closing only operates when the engine is running.



Always remove the ignition key when leaving the vehicle, even for a short time.

If an obstacle is encountered while the electric windows are in use, you must reverse the movement of the window. To do this, press the switch concerned.

When the driver operates the passenger electric window switches, he must ensure that no one is preventing correct closing of the windows.

The driver must ensure that passengers use the electric windows correctly.

Be aware of children when operating the windows.



REAR WINDOWS

To partially open the rear windows, tilt the lever and push it fully to lock the windows in the open position.

62 - VISIBILITY



THE EXTERIOR MIRRORS

Manual mirrors

Move the lever in all four directions to adjust.

When the vehicle is parked, the exterior mirrors can be folded back manually.

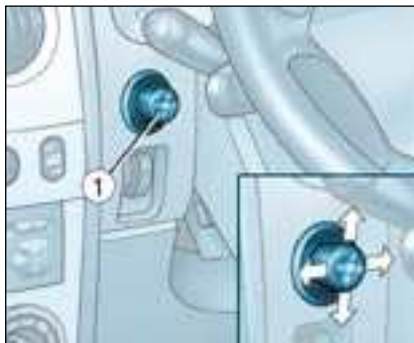

Passenger side exterior mirror electric control

From the driver's seat, move the control 1 in all four directions to adjust.

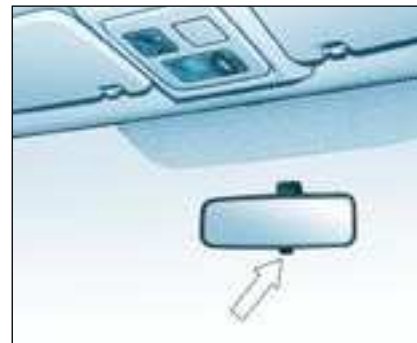

THE MANUAL INTERIOR MIRROR

The interior mirror has two positions:

- day (normal),
- night (anti-dazzle).

To change from one to the other, push or pull the lever on the lower edge of the mirror.

64 - COMFORT AND SAFETY



FRONT LAYOUT

1. Storage in the doors

- A. Bottle holder.
- B. Can holder.
- C. Storage compartment.

2. Overhead storage

Maximum load: **5 kg**.

3. Map reading lights

Turn the dial to the right or to the left to switch them on.

Place the dial in the centre to switch them off.



4. Courtesy lights



Permanently off.



On entering the vehicle:

- they come on when the vehicle is unlocked or when a door is opened,
- they switch off after approximately 30 seconds with the doors closed, or when the ignition is switched on.

On leaving the vehicle:

- they come on when the key is removed from the ignition (timing of approximately 30 seconds) or when a door is opened,
- they switch off after approximately 30 seconds with all of the doors closed, or immediately when the vehicle is locked.

In this position, the courtesy light may flash while driving if a door is not closed correctly.

If a door is open, it will switch off automatically after approximately 10 minutes or when the ignition is switched on.



Permanently on when the key is in the accessories position or the ignition is on.

5. Sun visors

6. Glove box

7. Lighter

It permits the connection of a telephone charger, a baby's bottle warmer, ...

8. Removable ashtray

Pull the cover to open the ashtray. To empty, after opening, remove it by pulling upwards.

9. Storage drawer (passenger)

To open the drawer, lift it slightly and pull it forwards.



HEADLAMP ADJUSTMENT

Depending on the load in your vehicle, it is recommended that the headlamp beam is adjusted.



- 0** - With no load.
- 1** - With partial load.
- 2** - With average load.
- 3** - With maximum authorised load.



- 0** - 1 or 2 people in the front seats.
- - 3 people.
- 1** - 5 people.
- 2** - 5 people + maximum authorised load.
- 3** - Driver + maximum authorised load.

Initial setting is position 0.

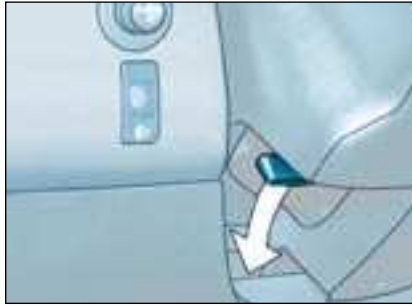

STEERING WHEEL HEIGHT ADJUSTMENT

When stationary, lower the handle to unlock the steering wheel.

Adjust to the desired height and lift the handle to lock the steering wheel.

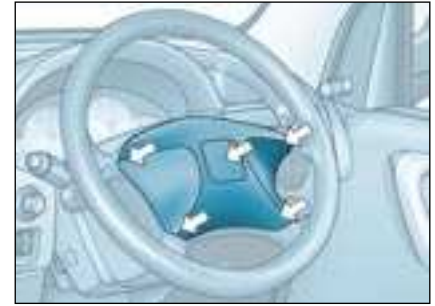

HORN



Press one of the spokes or the centre of the steering wheel.



HAZARD WARNING LIGHTS

Press the button, the direction indicators flash.

They can operate with the ignition off.



LASHING RINGS

Use the 6 lashing rings on the luggage compartment floor to secure your loads.

You can use suitable load retainers (half-height partitions, grille, etc.) supplied by the CITROËN network.



It is recommended that the load is immobilised by securing it firmly using the lashing rings on the floor.

68 - COMFORT AND SAFETY



REAR LAYOUT

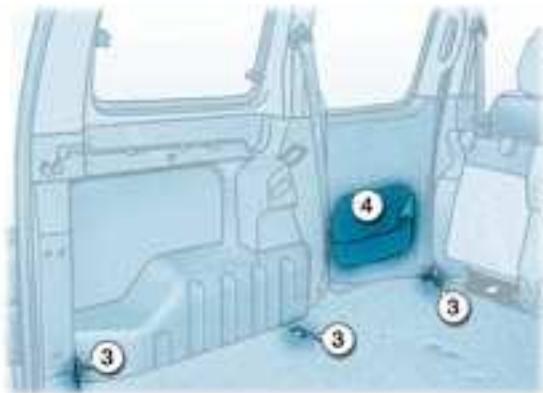

1. Trays between the front and rear seats

2. Load-space cover

To install it:

- position the front ends of the load space cover on its support and press gently to put it in place,
- unfold the load space cover fully,
- position the rear ends of the load space cover on its support and press gently to put it in place.

To remove it:

- unclip the rear ends,
- fold the load space cover fully,
- unclip the front ends and remove the load space cover.

To store it, fold it like an accordion.
Do not roll it.

3. Stowing rings

4. High load retaining net

The high load retaining net can be fitted behind the front or rear seats.

Open the covers **A** of the corresponding upper fastenings.

Fit the ends of the metal bar in these fastenings.

Secure the two net strap hooks behind the front seats, with the rear seat folded, or in the stowing rings **B** on the floor.

The rings are located directly below the corresponding upper fastenings.

Pull the two straps **C** taut.

5. Side door storage compartments

6. Seat back storage pockets

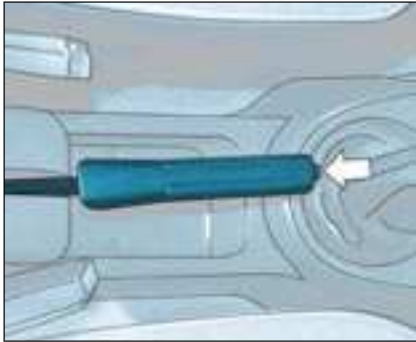

HANDBRAKE

Applying

When parking, pull the handbrake to immobilise your vehicle.

Releasing

Pull the handle and press the button to release the handbrake.



Illumination of this warning light and of the **STOP** warning light, accompanied by an audible signal (while the vehicle is moving), indicates that the handbrake is still applied or has not been released fully.

ANTI-LOCK BRAKING SYSTEM (ABS) AND THE ELECTRONIC BRAKE FORCE DISTRIBUTION (EBFD)

The ABS, in conjunction with the electronic brake force distribution, increases the stability and manoeuvrability of your vehicle on braking, in particular on poor or slippery road surfaces.

Note: when changing wheels (tyres and rims), make sure that these are approved.

The anti-lock braking system comes into operation automatically when there is a risk of wheel lock.



When this warning light comes on, accompanied by a buzzer, it indicates that there is a malfunction of the ABS, which can cause a loss of control of the vehicle when braking.



When this warning light comes on, connected to the **STOP** and **ABS** warning lights, it indicates that there is a malfunction of the electronic brake force distribution, which can cause a loss of control of the vehicle when braking.

Stop immediately.

In both cases, consult a CITROËN dealer.

Normal operation of the ABS may make itself felt by slight vibrations of the brake pedal.

In emergency braking, press very firmly without releasing the pressure.



SPEED LIMITER

The operating actions must be carried out when stationary, with the engine running, or with the vehicle moving.

The status of the function is displayed on the instrument panel in accordance with the following sequences:



Function selected, displaying of the "Speed Limiter" symbol.



Function deactivated, last programmed speed - OFF (example at 66 mph (107 km/h)).



Function activated (example at 66 mph (107 km/h)).



Vehicle speed above 66 mph (107 km/h), the programmed speed is displayed flashing.



Operating fault detected, OFF - the dashes flash.



Selecting the function

- ☞ Place the dial in the **LIMIT** position. The limiter is selected but is not yet active. The display indicates dashes or the last programmed speed.



Programming a speed

A speed can be programmed without activating the limiter but with the engine running.

- ☞ A brief or extended press of the **SET** - button decreases the speed.
- ☞ A brief or extended press of the **SET +** button increases the speed.



Activation/deactivation (off)

When you have programmed your speed, pressing this button once activates the limiter and the programmed speed is displayed, pressing the button again deactivates it (OFF).



Exceeding the programmed speed

Pressing the accelerator pedal in order to exceed the programmed speed will have no effect unless you press the pedal **firmly** beyond the **point of resistance**.

The limiter is deactivated temporarily and the programmed speed which is still displayed flashes.

To return to the limiter function, reduce your speed to the programmed speed or below.



Switching the function off

- ☞ Place dial in position **0** or switch off the ignition to switch the system off. The last programmed speed remains in the memory.



In any event, the speed limiter cannot replace the need to observe speed limits, nor can it replace the need for vigilance and responsibility on the part of the driver.

The driver must always pay attention to the profile of the road, take care on sharp acceleration and remain in perfect control of his vehicle.

To prevent the mat from becoming trapped under the pedals:

- ensure that the mat and its fixings are positioned correctly,
- never fit one mat on top of another.

Flashing of the speed

The speed flashes:

- following forcing of the accelerator point of resistance,
- when the limiter cannot prevent an increase in the vehicle speed due to the profile of the road or on a steep descent,
- in the event of sharp acceleration.



Operating fault

In the event of a limiter malfunction, a message is displayed on the multi-function display accompanied by an audible signal.

The programmed speed is cleared and the dashes flash for a few seconds.

Contact a CITROËN dealer to have the system checked.



CRUISE CONTROL

The cruise control maintains a constant vehicle speed programmed by the driver.

In order for it to be programmed or activated, the vehicle speed must be greater than 25 mph (40 km/h) with at least fourth gear engaged.

If the vehicle is fitted with a speed limiter and cruise control, these functions cannot be activated at the same time.

The cruise control has a display on the instrument panel to indicate the programmed reference speed.

The status of the function is displayed on the instrument panel in accordance with the following sequences:



Function selected, displaying of the "Cruise Control" symbol.



Function deactivated, OFF (example at 66 mph (107 km/h)).



Function activated (example at 66 mph (107 km/h)).



Vehicle speed above (e.g. 73 mph (118 km/h)), the programmed speed is displayed flashing.



Operating fault detected, OFF - the dashes flash.



Selecting the function

- ☞ Place the switch in the **CRUISE** position. The cruise control is selected but is not yet active and no speed has been programmed.



First activation/programming a speed

- ☞ Reach the chosen speed by pressing the accelerator.
- ☞ Press the **SET** - or **SET +** button.

This programmes the reference speed and the vehicle will maintain this speed.



Temporary exceeding of the speed

It is possible to **accelerate** and drive momentarily at a speed greater than the programmed speed. The value programmed flashes.

When the accelerator pedal is released, the vehicle will return to the programmed speed.



Deactivation (off)

- ☞ Press this button or the brake or clutch pedal.



Reactivation

- ☞ Following deactivation of the cruise control, press this button.

Your vehicle will return to the last programmed speed.

Alternatively, you can repeat the "first activation" procedure.



Changing the programmed reference speed

When the speed is displayed:

- ☞ press **SET +** button to increase it.
- ☞ press the **SET -** button to decrease it.



Switching the function off

- ☞ Place the dial in position **0** or switch off the ignition to switch everything off.

Cancelling the programmed reference speed

When the vehicle becomes stationary, after switching off the ignition, the system no longer memorises a speed.



Operating fault

In the event of a cruise control malfunction, a message is displayed on the multifunction display accompanied by an audible signal.

The programmed speed is cleared and the dashes flash for a few seconds.

Contact a CITROËN dealer to have the system checked.



When changing the programmed reference speed by means of a maintained press, pay attention as the speed can increase or decrease rapidly.

Do not use the cruise control on slippery roads or in heavy traffic.

In the event of a steep slope, the cruise control cannot prevent the vehicle from exceeding the programmed speed.

In any event, the cruise control cannot replace the need to observe the speed limits, nor can it replace the need for vigilance and responsibility on the part of the driver.

It is advisable to leave your feet near the pedals.

To prevent the mat from becoming trapped under the pedals:

- ensure that the mat and its fixings are positioned correctly,
- never fit one mat on top of another.

AIR BAGS

The air bags have been designed to maximise the safety of the occupants in the event of serious collisions. They work in conjunction with the force-limiting seat belts. The electronic detectors register and analyse any abrupt deceleration of the vehicle in the impact detection zones (see diagram): if the triggering threshold is reached, the air bags inflate instantly and protect the occupants of the vehicle.

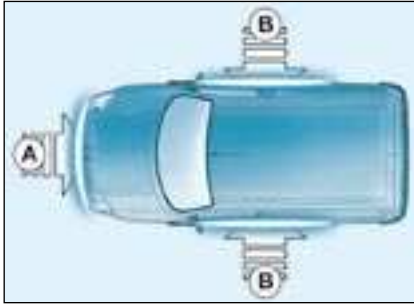

Impact detection zones

- A.** Front impact zone.
- B.** Side impact zone.

Immediately after the impact, the air bags deflate rapidly so that they do not hinder the visibility of the occupants nor their exit if necessary from the vehicle.

The air bags are not deployed in the case of minor impacts, rear impacts or in certain roll-over conditions. The seat belt is sufficient to ensure maximum protection in these situations. The seriousness of a collision depends on the nature of the obstacle and the speed of the vehicle at the moment of the collision.

Air bags only operate when the ignition is switched on.



Note: the gas escaping from the air bags can be a minor irritant.



FRONT AIR BAGS

These are folded in the centre of the steering wheel for the driver and in the fascia for the front passenger. They are deployed simultaneously, except in cases where the passenger air bag is disarmed, in the event of a serious front impact applied in the impact zone **A** in the longitudinal centreline of the vehicle, on a horizontal plane and from the rear of the vehicle towards the front. The air bag inflates between the front occupant of the vehicle and the fascia to cushion his forward movement. The air bags therefore limit the risk of injury to the head and chest.

Front air bag malfunction



If this warning light comes on, accompanied by an audible signal, contact a CITROËN dealer to have the system checked. The air bags may no longer be triggered in the event of a serious impact.



Disarming the passenger air bag

To ensure the safety of your child, it is essential to disarm the passenger air bag when you install a rear-facing child seat on the front passenger seat. Otherwise, the child would risk being killed or seriously injured if the air bag were to inflate.

- ☞ **With the ignition switched off**, insert the key into the passenger air bag disarming switch **1**, turn it to the **"OFF"** position, then remove the key keeping the slot in this position.



The air bag warning light on the instrument panel is lit throughout the period of disarming.

In the **"OFF"** position, the passenger air bag will not be triggered in the event of an impact.

As soon as the child seat is removed, turn the air bag slot to the **"ON"** position to re-activate the air bag and thus ensure the safety of your passenger in the event of an impact.

Disarming check



This is confirmed by an indicator light, accompanied by a message on the display.

With the ignition on (2nd notch), illumination of this warning light indicates that the passenger air bag is disarmed (switch in the **"OFF"** position).



If the two air bag warning lights are lit continuously, do not install a rear-facing child seat. Consult a CITROËN dealer.



SIDE AIR BAGS

The side air bags are incorporated into the front seat backs on the door side.

The triggering of these air bags requires a serious side impact applied in the side impact zone **B**, perpendicular to the longitudinal centreline of the vehicle, on a horizontal plane and from the outside of the vehicle towards the inside. The side air bag inflates between the front occupant of the vehicle and the door trim pad. It therefore limits the risk of injury to the chest.

Air bags malfunction



If this warning light comes on, accompanied by an audible signal, contact a CITROËN dealer to have the system checked. The air bags may no longer be triggered in the event of a serious impact.



For the front and side air bags to be fully effective, observe the following safety rules:

- Wear a correctly adjusted seat belt.
- Sit in a normal upright position.
- Do not leave anything between the occupants and the air bags (child, animal, object, ...).
This could hamper the operation of the air bags or injure the occupants.
- All work on the air bag systems is strictly prohibited unless it is carried out by qualified personnel of the CITROËN network.
- After an accident or if the vehicle has been stolen or broken into, have the air bag systems checked.

Front air bags

- Do not drive holding the steering wheel by its spokes or resting your hands on the centre part of the wheel.
- Passengers must not place their feet on the fascia.
- Smoke as little as possible; deployment of the air bags can cause burns or the risk of injury from a cigarette or pipe.
- Never remove or pierce the steering wheel or hit it violently.

Side air bags

- Only put approved covers on the front seats. Consult a CITROËN dealer.
- Do not fix or glue anything to the front seat backs. This could cause injury to the chest or arms when the side air bag inflates.
- Do not sit with the upper part of the body any nearer to the door than necessary.



SIDE AIR BAGS

The side air bags are incorporated into the front seat backs on the door side.

The triggering of these air bags requires a serious side impact applied in the side impact zone **B**, perpendicular to the longitudinal centreline of the vehicle, on a horizontal plane and from the outside of the vehicle towards the inside. The side air bag inflates between the front occupant of the vehicle and the door trim pad. It therefore limits the risk of injury to the chest.

Air bags malfunction



If this warning light comes on, accompanied by an audible signal, contact a CITROËN dealer to have the system checked. The air bags may no longer be triggered in the event of a serious impact.



For the front and side air bags to be fully effective, observe the following safety rules:

- Wear a correctly adjusted seat belt.
- Sit in a normal upright position.
- Do not leave anything between the occupants and the air bags (child, animal, object, ...).
This could hamper the operation of the air bags or injure the occupants.
- All work on the air bag systems is strictly prohibited unless it is carried out by qualified personnel of the CITROËN network.
- After an accident or if the vehicle has been stolen or broken into, have the air bag systems checked.

Front air bags

- Do not drive holding the steering wheel by its spokes or resting your hands on the centre part of the wheel.
- Passengers must not place their feet on the fascia.
- Smoke as little as possible; deployment of the air bags can cause burns or the risk of injury from a cigarette or pipe.
- Never remove or pierce the steering wheel or hit it violently.

Side air bags

- Only put approved covers on the front seats. Consult a CITROËN dealer.
- Do not fix or glue anything to the front seat backs. This could cause injury to the chest or arms when the side air bag inflates.
- Do not sit with the upper part of the body any nearer to the door than necessary.

Front air bag malfunction



If this warning light comes on, accompanied by an audible signal, contact a CITROËN dealer to have the system checked. The air bags may no longer be triggered in the event of a serious impact.



Disarming the passenger air bag

To ensure the safety of your child, it is essential to disarm the passenger air bag when you install a rear-facing child seat on the front passenger seat. Otherwise, the child would risk being killed or seriously injured if the air bag were to inflate.

- ☞ **With the ignition switched off**, insert the key into the passenger air bag disarming switch **1**, turn it to the **"OFF"** position, then remove the key keeping the slot in this position.



The air bag warning light on the instrument panel is lit throughout the period of disarming.

In the **"OFF"** position, the passenger air bag will not be triggered in the event of an impact.

As soon as the child seat is removed, turn the air bag slot to the **"ON"** position to re-activate the air bag and thus ensure the safety of your passenger in the event of an impact.

Disarming check



This is confirmed by an indicator light, accompanied by a message on the display.

With the ignition on (2nd notch), illumination of this warning light indicates that the passenger air bag is disarmed (switch in the **"OFF"** position).



If the two air bag warning lights are lit continuously, do not install a rear-facing child seat. Consult a CITROËN dealer.

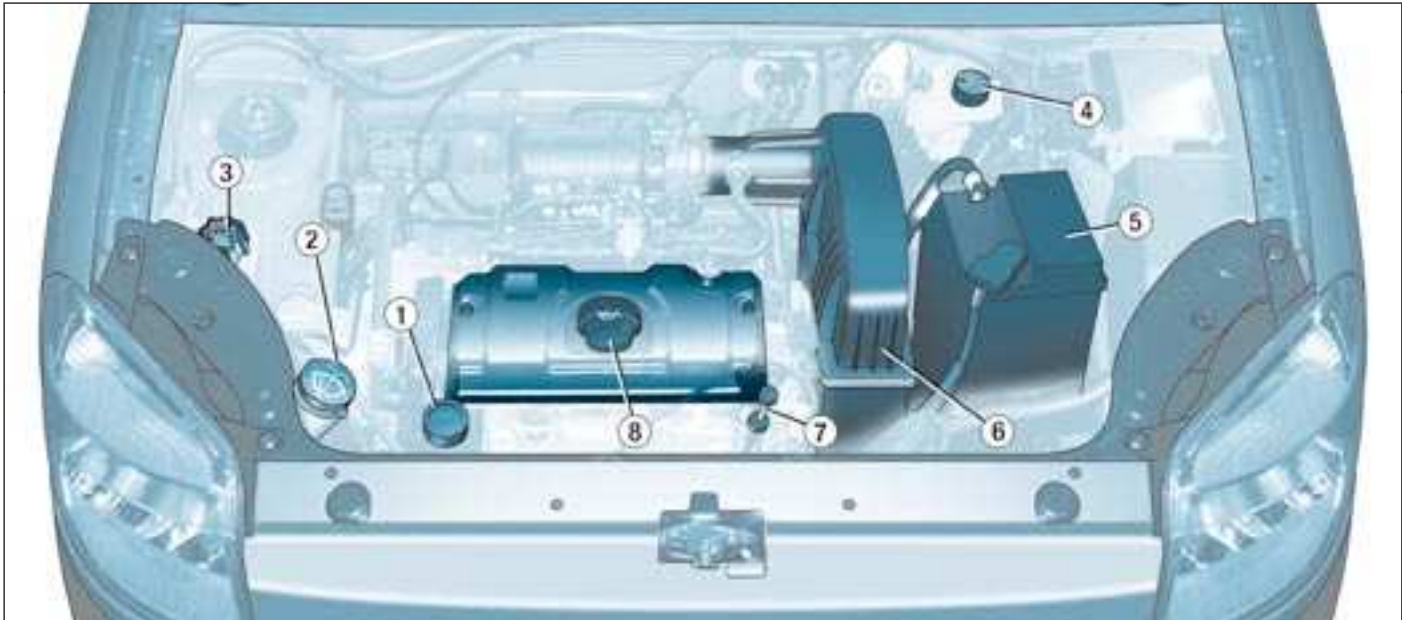

1.4 LITRE PETROL ENGINE

- | | | |
|---|--------------------------|-------------------------|
| 1. Power steering reservoir | 4. Brake fluid reservoir | 7. Dipstick |
| 2. Windscreen and headlamp wash reservoir | 5. Battery | 8. Engine oil reservoir |
| 3. Coolant reservoir | 6. Air filter | |

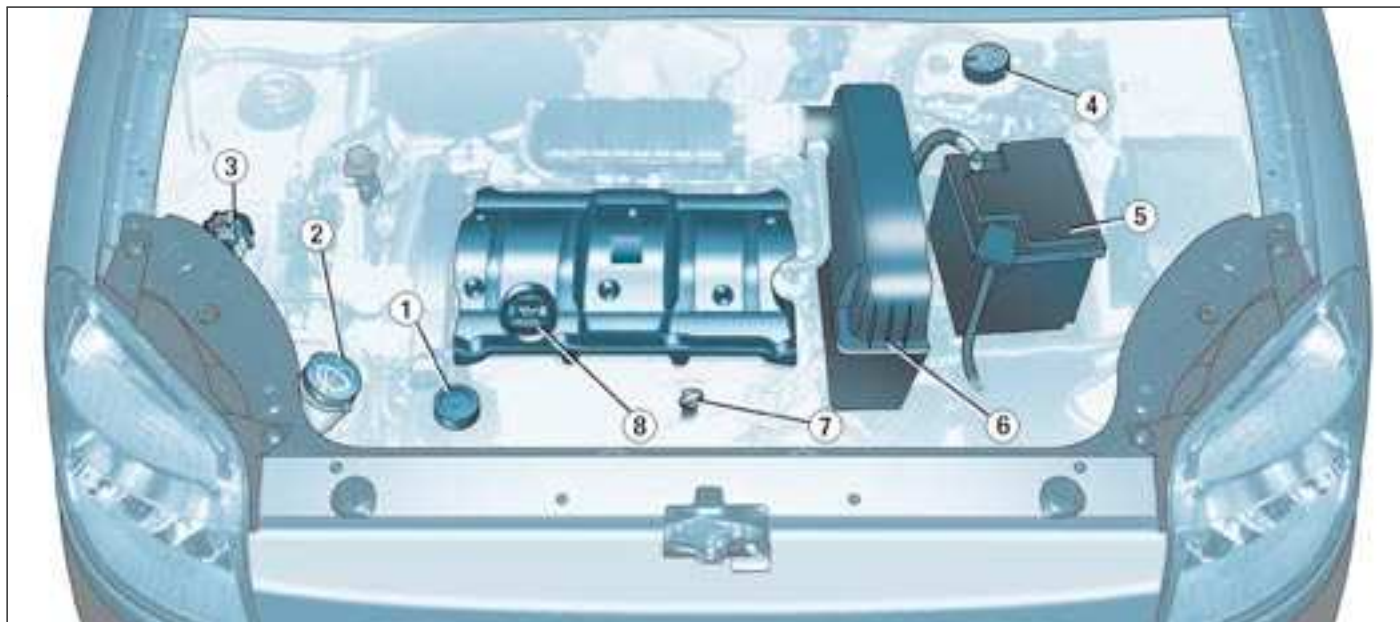

1.6 LITRE PETROL ENGINE

- | | | |
|---|--------------------------|-------------------------|
| 1. Power steering reservoir | 4. Brake fluid reservoir | 7. Dipstick |
| 2. Windscreen and headlamp wash reservoir | 5. Battery | 8. Engine oil reservoir |
| 3. Coolant reservoir | 6. Air filter | |



1.9 LITRE DIESEL ENGINE

- | | | |
|---|--------------------------|-------------------------|
| 1. Power steering reservoir | 4. Brake fluid reservoir | 7. Dipstick |
| 2. Windscreen and headlamp wash reservoir | 5. Battery | 8. Engine oil reservoir |
| 3. Coolant reservoir | 6. Air filter | |

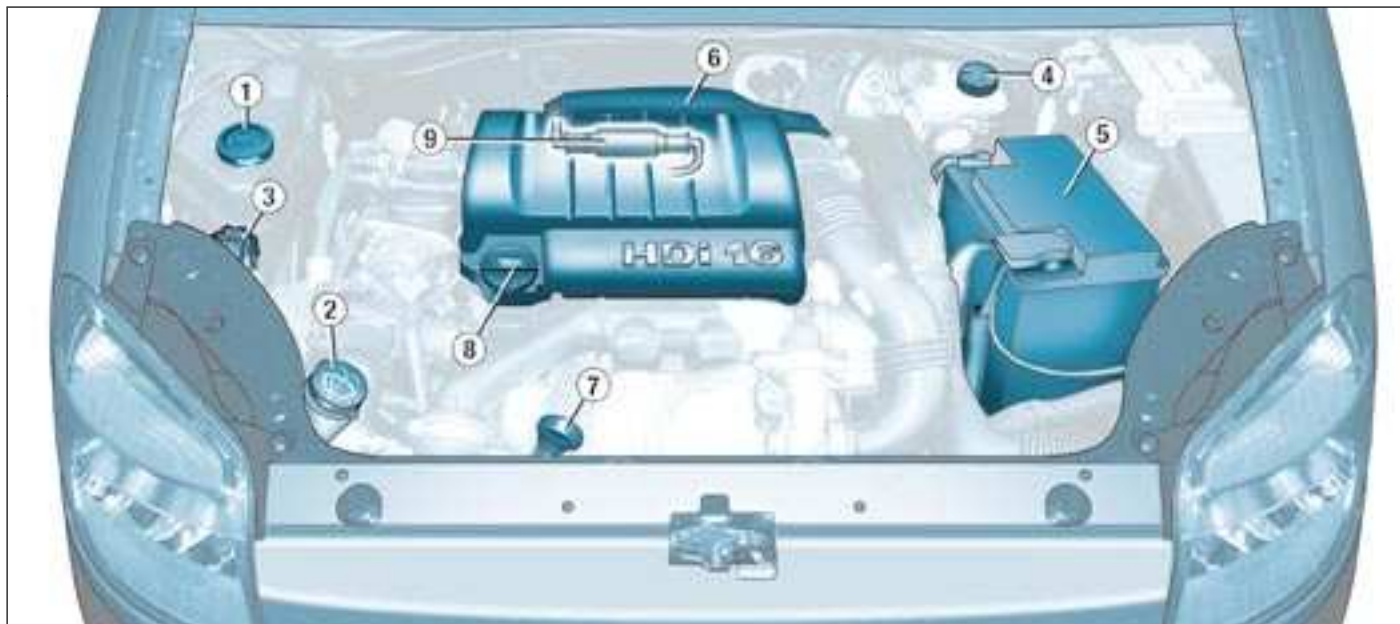

1.6 LITRE TURBO DIESEL HDI ENGINE

- | | | |
|--|---------------------------|--------------------------|
| 1. Power steering reservoir. | 4. Brake fluid reservoir. | 7. Dipstick. |
| 2. Windscreen/headlamp wash reservoir. | 5. Battery. | 8. Engine oil reservoir. |
| 3. Coolant reservoir. | 6. Air filter. | 9. Priming pump. |

CHECKING THE LEVELS

Oil level

☞ Check the level regularly and top up between changes. The maximum consumption is 0.5 l per 600 miles (1 000 km).

Check the level with the vehicle level, engine cold, using the oil level gauge on the instrument panel or the dipstick.

Dipstick

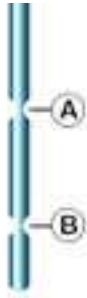

There are two marks on the dipstick:

A = maximum

Never fill past this mark.

B = minimum

To maintain the reliability of engines and emission control systems, the use of additives in engine oil is prohibited.

Oil change

According to the information given in the servicing booklet.

Note: avoid used oil coming into prolonged contact with the skin. Empty the used oil into the containers intended for this purpose in the CITROËN network.

Viscosity selection

In all cases, the oil selected must meet the manufacturer's requirements.

Brake fluid level:

The brake fluid must be changed according to the manufacturer's servicing schedule.

Use fluids recommended by the manufacturer, which fulfil DOT4 standards.

Note: brake fluid is harmful to health and very corrosive. Avoid all contact with the skin.

Cooling system

Use the fluid recommended by the manufacturer.

When the engine is warm, the temperature of the coolant is controlled by the engine fan. As this fan can operate with the ignition key removed and because the cooling system is pressurised, wait for at least one hour after the engine has stopped before carrying out any work.

Slacken the cap by two turns to release the pressure to prevent any risk of scalding. When the pressure has dropped, remove the cap and top up the level.

Note: the coolant does not need to be changed.

For vehicles equipped with a particle filter, the engine fan may operate after the ignition has been switched off, even when the engine is cold.

Used oil

Do not dispose of used oil, brake fluid or coolant into drains or onto the ground.

Power steering reservoir

☞ Open the reservoir, with the engine at ambient temperature. The level should always be above the MIN. mark and close to the MAX. mark.

Windscreen and headlamp wash level

For best quality cleaning and for your safety, we would advise that you use products recommended by CITROËN.

For optimum cleaning and to prevent freezing, this fluid must not be topped up or replaced with water.

CHECKS

Battery

At the start of winter, have your battery checked by a CITROËN dealer.

Air filter and passenger compartment filter

Have the filter elements replaced regularly. **If you drive in dusty conditions, change them twice as often.**

Brake pads

Brake pad wear depends on the style of driving, in particular for vehicles which are used in town, over short distances.

It may be necessary to check the thickness of the pads, even between services.

Disc and drum wear status

For any information relating to checking the disc and drum wear status, contact a CITROËN dealer.

Handbrake

Where the handbrake travel is too great or there is a reduction in the performance of the system, the handbrake should be adjusted, even between services.

Have the system checked by a CITROËN dealer.

Oil filter

Change the filter regularly, in accordance with the servicing schedule.

Manual gearbox

This does not require an oil change. Check the level in accordance with the manufacturer's servicing schedule.

To check the main levels and certain components, in accordance with the manufacturer's servicing schedule, refer to the pages of the servicing booklet which correspond to your vehicle's engine.



Only use products recommended by CITROËN or products of equivalent quality and specifications.

To ensure best performance from components as important as the power steering and the braking system, CITROËN selects and offers quite specific products.

To prevent damage to the electrical units, avoid washing the engine.

RUNNING OUT OF FUEL (DIESEL)

If you should run out of fuel, it is necessary to re-prime the circuit:

- fill the fuel tank with at least five litres of diesel,
- squeeze and release the manual re-priming pump, under the bonnet under the protective cover, until fuel appears in the transparent pipe,
- operate the starter until the engine starts.

FUEL SUPPLY CUT-OFF (PETROL)

In a serious collision, a mechanism prevents fuel from reaching the engine.

To re-establish the fuel supply, press the switch on the corner of the front right-hand suspension assembly, under the bonnet.

CHANGING A WHEEL

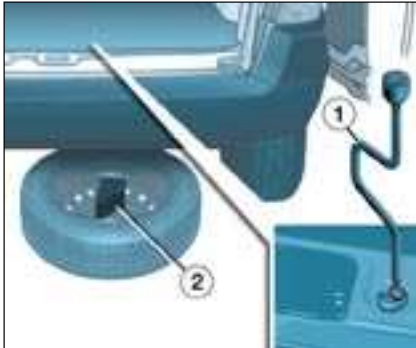

Access to the spare wheel and the jack

The wheel is located outside the vehicle, under the rear floor, supported by a metal carrier.



- Remove the jack and the wheelbrace **1**, secured behind the driver's seat.



- Remove the jack and the wheelbrace **1** secured in an interior housing above the rear right wheel.

- Using the wheelbrace **1**, slacken the spare wheel carrier retaining bolt, located on the inside near the closing system.
- Lift the carrier to release the hook rearwards, then lower it.
- Remove the chock **2** located in the spare wheel.

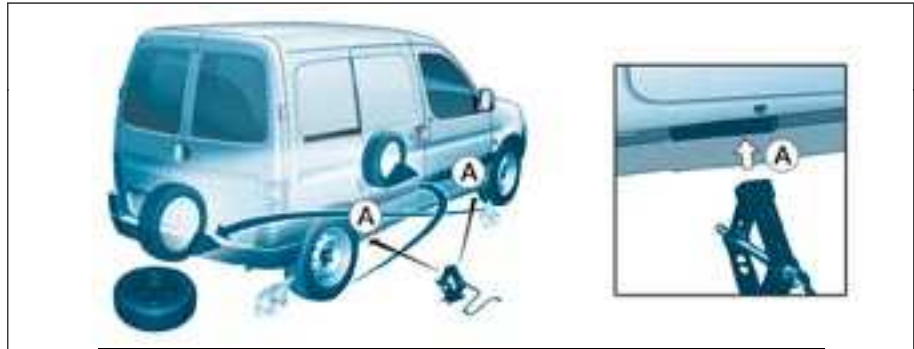

Parking the vehicle

- If possible, park the vehicle on level, stable and non-slippery ground.
- Apply the handbrake, switch off the ignition and engage first or reverse gear.

Removing a wheel

- Chock the rear of the wheel diagonally opposite the wheel to be changed, using the chock **2**.
- Remove the wheel trim using the wheelbrace **1**, by pulling at the valve passage hole.
- Slacken the wheel bolts.
- Place the jack under the locating point on the sub-frame **A** that is closest to the wheel to be changed. Ensure that the entire surface of the jack base plate is in contact with the ground.
- Extend the jack, completely unscrew the bolts and remove the wheel.

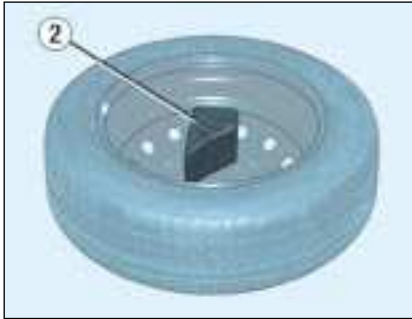

Refitting the wheel

- After positioning the wheel, lightly pre-tighten the bolts using the wheelbrace.
- Compress the jack and release it.
- Fully tighten the bolts using the wheelbrace.
- Replace the trim, starting at the valve passage hole, and press it on using the palm of the hand.



Replacing the wheel in the carrier

- Replace the chock 2 in the wheel.
- Replace the wheel in the carrier.
- Lift the wheel then the carrier and reposition the hook.
- Do not forget to fully tighten the spare wheel carrier retaining bolt.
- Stow the wheelbrace 1 and the jack.



For your safety, always change a wheel:

- on level, stable and non slippery ground,
- with the handbrake applied,
- with first or reverse gear engaged,
- with the vehicle chocked,
- making absolutely sure that the occupants get out of the vehicle and wait in a safe location.

Never go underneath the vehicle when it is raised using the jack only.

The jack and the tool kit are specific to your vehicle. Do not use them for other purposes.

After changing the wheel

- Have the tightening of the bolts and the pressure of the spare tyre checked as soon as possible by a CITROËN dealer.
- Have the punctured tyre repaired and replace it on the vehicle as soon as possible.

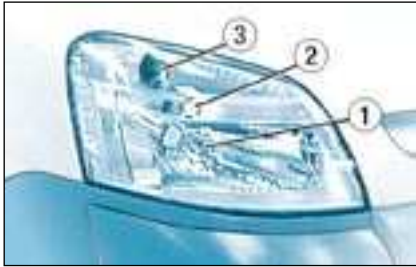

CHANGING A BULB

Front lights

1. Dipped beam headlamps/Main beam headlamps (H4 - 60/55 W)

- Turn and remove the protector **A**.
- Disconnect the connector.
- Unclip the spring.
- Remove and replace bulb.



2. Side lights (W 5 W)

- Turn and remove the protector **A**.
- Pull the bulb holder rearwards.
- Change the bulb.



3. Direction indicators (PY 21 W amber)

- Turn the bulb holder **B** a quarter turn and remove it.
- Change the bulb.

Note: in certain weather conditions (low temperatures, humidity), **the presence of condensation on the inside of the headlamp glass is normal**; it disappears a few minutes after the lights have been switched on.



Only use H4 bulbs manufactured by:

- GE/TUNGSRAM,
- PHILIPS,
- OSRAM,

to avoid damaging the headlamps.

These meet the anti-UV (ultra-violet) specifications necessary for the correct operation and reliability of the headlamps.



The headlamps are fitted with a polycarbonate lens coated with a protective varnish. You are strongly advised to avoid cleaning them using a dry or abrasive cloth and using detergent products or solvents.

Use a soft, damp cloth.

High pressure washing: when using this type of washing on stubborn dirt, do not persist on the headlamps, the lights and their surround to avoid damaging their coating and their seal.

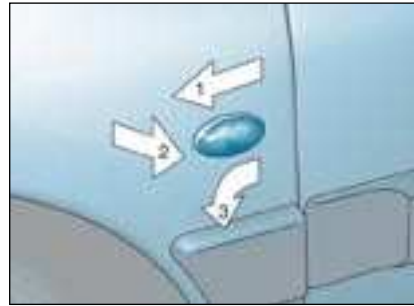

Direction indicator side repeaters (WY 5 W amber)

- Push the transparent cover forwards or rearwards and release it.
- Turn the bulb holder a quarter turn.
- Change the bulb.



Amber coloured bulbs (direction indicators and side repeaters) must be replaced by bulbs of identical specification and colour.

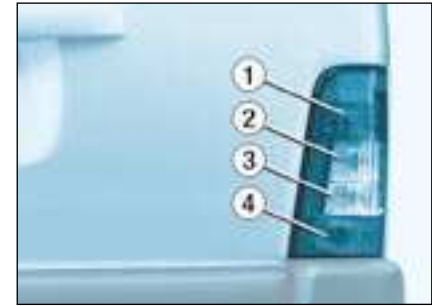

Rear lights

1. Fog lamp (P21 W).
2. Direction indicators (P21 W).
3. Reversing lights (P21 W).
4. Brake lights/Side lights (P21/5 W).

High pressure washing: when using this type of washing on stubborn dirt, do not persist on the headlamps, the lights and their surround to avoid damaging their coating and their seal.



Only use H4 bulbs manufactured by:

- GE/TUNGSRAM,
- PHILIPS,
- OSRAM,

to avoid damaging the headlamps.

These meet the anti-UV (ultra-violet) specifications necessary for the correct operation and reliability of the headlamps.



The headlamps are fitted with a polycarbonate lens coated with a protective varnish. You are strongly advised to avoid cleaning them using a dry or abrasive cloth and using detergent products or solvents.

Use a soft, damp cloth.

High pressure washing: when using this type of washing on stubborn dirt, do not persist on the headlamps, the lights and their surround to avoid damaging their coating and their seal.

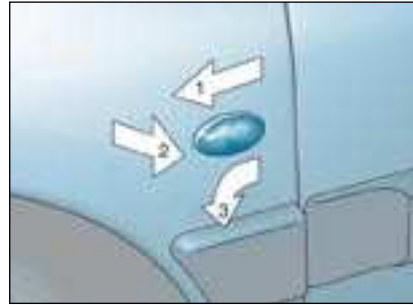

Direction indicator side repeaters (WY 5 W amber)

- Push the transparent cover forwards or rearwards and release it.
- Turn the bulb holder a quarter turn.
- Change the bulb.



Amber coloured bulbs (direction indicators and side repeaters) must be replaced by bulbs of identical specification and colour.

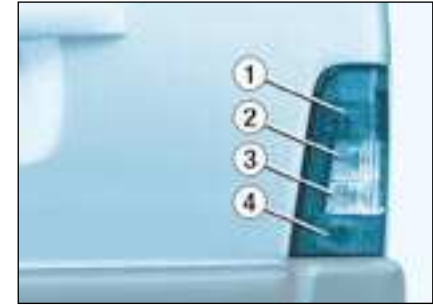

Rear lights

1. Fog lamp (P21 W).
2. Direction indicators (P21 W).
3. Reversing lights (P21 W).
4. Brake lights/Side lights (P21/5 W).

High pressure washing: when using this type of washing on stubborn dirt, do not persist on the headlamps, the lights and their surround to avoid damaging their coating and their seal.



- Open the rear door.
- Unscrew the nut **A**.
- Push the light unit gently towards the interior of the vehicle to unclip the two side retaining clips,
- Remove the light unit and disconnect it.
- Unclip the bulb holder by pressing the tabs **B**,
- Change the faulty bulb.



Number plate lights (W 5 W)

- ☞ Insert a thin screwdriver into one of the external holes of the lens.
- ☞ Push it outwards to unclip it.
- ☞ Remove the lens.
- ☞ Change the faulty bulb.

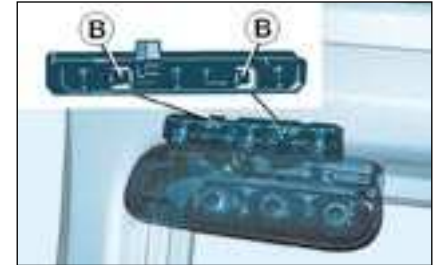

Third brake light (rear left door) (W 5 W)

- ☞ Remove the housing cover by pressing the tab **A** (round section) at the end of the light.
 - ☞ Pull the housing cover rearwards.
 - ☞ Squeeze the two tabs **B** to remove the bulb holder.
 - ☞ Pull the faulty bulb and change it.
- To refit, proceed in the reverse order.

CHANGING A FUSE

The fuse boxes are located under the fascia and in the engine compartment.



Fascia fuse box

Unclip the cover to gain access to the fuses.

The spare fuses and the pliers **B** are secured on the inside of the cover **A**.

Removing and fitting a fuse

Before changing a fuse, the cause of the fault must be found and remedied. The fuse numbers are indicated on the fuse box.

Use the pliers **B**.

Always replace a faulty fuse with a fuse of the same rating (two fuse types according to manufacturer - see images).

Correct



Incorrect



Pliers B



CHANGING A FUSE

The fuse boxes are located under the fascia and in the engine compartment.



Fascia fuse box

Unclip the cover to gain access to the fuses.

The spare fuses and the pliers **B** are secured on the inside of the cover **A**.

Removing and fitting a fuse

Before changing a fuse, the cause of the fault must be found and remedied. The fuse numbers are indicated on the fuse box.

Use the pliers **B**.

Always replace a faulty fuse with a fuse of the same rating (two fuse types according to manufacturer - see images).

Correct



Incorrect



Pliers B



92 - PRACTICAL INFORMATION

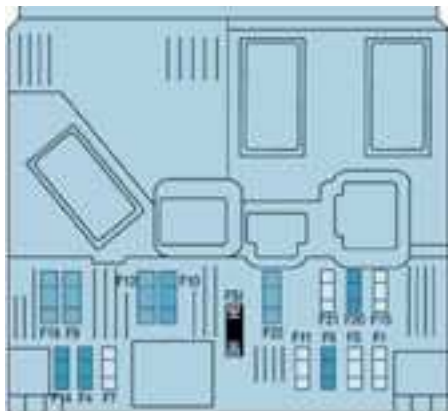

| Fuse N° | Rating | Functions |
|---------|--------|--|
| 1 | 15 A | Rear wiper. |
| 4 | 20 A | Multi-function display - Instrument panel - Audio equipment - Steering wheel controls. |
| 5 | - | Not used. |
| 6 | 10 A | Diagnostic socket. |
| 7 | - | Not used. |
| 9 | 30 A | Heated seats. |
| 10 | 40 A | Rear windows and mirrors demisting. |
| 11 | - | Not used. |
| 12 | 30 A | Front electric windows. |
| 14 | 10 A | Engine fuse box - Steering wheel controls. |
| 15 | 15 A | Instrument panel - Multi-function display - Audio equipment. |
| 16 | 30 A | Locking/unlocking controls for doors, bonnet and boot. |
| 20 | 10 A | Right-hand brake light. |
| 21 | 15 A | Left-hand brake light. |
| 22 | 20 A | Front courtesy light - Map reading light - Lighter - Electric mirror. |



The electrical circuit of your vehicle is designed to operate with standard or optional equipment.

Before installing other electrical equipment or accessories in your vehicle, consult a CITROËN dealer.

Some electrical accessories or the way in which they are fitted may have an adverse effect on the operation of your vehicle (its electronic control circuits, the audio circuit and the electrical charging circuit).

CITROËN declines any responsibility for expenses incurred through the repair of your vehicle or for any malfunctions resulting from the installation of auxiliary accessories, not supplied and not recommended by CITROËN and not installed in accordance with its instructions, in particular for any equipment the power consumption of which exceeds 10 milliamps.

The maxi fuses provide additional protection for the electrical systems. Any work on these fuses must be carried out by a CITROËN dealer.

Engine compartment fuse box

To gain access to the box in the engine compartment (next to the battery), unclip the cover.

After carrying out work, close the cover very carefully.

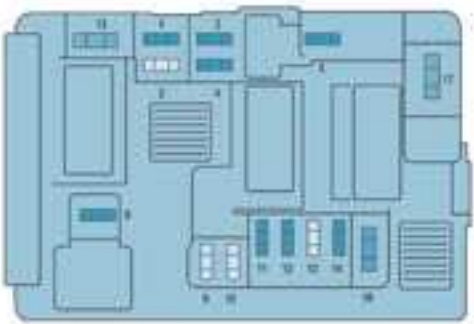

| Fuse N° | Rating | Functions |
|---------|--------|--|
| 1 | 10 A | Pre-heat unit (diesel) - Brake and clutch switches - Reversing lights. |
| 2 | 15 A | Fuel pump. |
| 3 | 10 A | ABS control unit. |
| 4 | 10 A | Engine control unit. |
| 5 | - | Not used. |
| 6 | 15 A | Front fog lamps. |
| 7 | 20 A | Headlamp wash pump. |
| 8 | 20 A | Fan assembly relay - Engine control unit. |
| 9 | 15 A | Left-hand dipped beam. |
| 10 | 15 A | Right-hand dipped beam. |
| 11 | 10 A | Left-hand main beam. |
| 12 | 10 A | Right-hand main beam. |
| 13 | 15 A | Horn. |
| 14 | 10 A | Front and rear windscreen wash pumps. |
| 15 | 30 A | Oxygen sensor - Air flow sensor. |
| 16 | 30 A | Air pump relay. |
| 17 | 30 A | Front windscreen wiper. |
| 18 | 40 A | Air conditioning fan. |

BATTERY

To charge the battery using a battery charger:

- Disconnect the battery,
- Follow the instructions for use given by the battery charger manufacturer,
- Reconnect starting with the negative (-) terminal,
- Check that the terminals and connectors are clean. If they are covered with sulphate (white or greenish deposit), disconnect them and clean them.

To start the vehicle from another battery:

- Connect the red cable to the positive (+) terminals of the two batteries,
- Connect one end of the green or black cable to the negative (-) terminal of the slave battery,
- Connect the other end of the green or black cable to an earth point on the broken down vehicle as far as possible from the battery (for example, right-hand engine mounting).

Operate the starter, let the engine run. Wait for the engine to return to idle, then disconnect the cables.

It is advisable to disconnect the battery if the vehicle is not to be used for a period of more than one month.

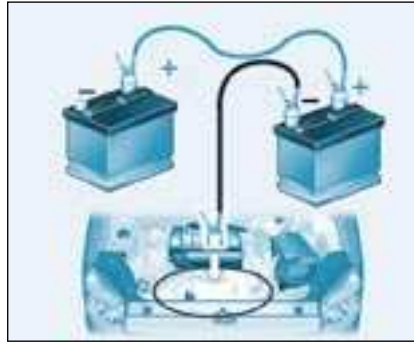

Before disconnecting the battery, you must wait 2 minutes after switching off the ignition. Never disconnect a terminal when the engine is running.

Never charge a battery without first disconnecting the terminals.

Close the windows and the roof before disconnecting the battery.

After every reconnection of the battery, switch on the ignition and wait 1 minute before starting to allow the electronic systems to be initialised. If slight difficulties are experienced after this, please contact a CITROËN dealer.

ECONOMY MODE FUNCTION

After the engine has stopped, with the key in the "accessories" position, certain functions (windscreen wiper, electric windows, courtesy lights, audio equipment, etc.) can only be used for a combined duration of approximately thirty minutes, to prevent discharging the battery.

Once the thirty minutes are over, a switching to economy mode message appears on the multi-function display and the active functions are put on standby.

These functions are reactivated automatically next time the vehicle is driven.

In order to resume the use of these functions immediately, the engine must be started and left to run for a few minutes.

The time available to you will then be double the duration for which the engine is left running. However, this period will always be between five and thirty minutes.



A flat battery prevents the engine from starting.

FITTING AUDIO EQUIPMENT

Your vehicle is equipped with certain factory-fitted audio equipment:

- roof aerial,
- coaxial aerial cable,
- basic interference suppression,
- supply to front speakers and tweeters,
- two 8-way connectors.

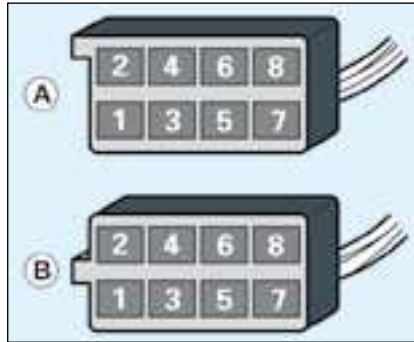

FITTING SPEAKERS

The factory-fitted equipment allows the fitting of:

- 35 mm diameter tweeters in the fascia,
- 165 mm diameter speakers in the front doors.

Making the connections

- A1: -
A2: - Digital control (manufacturer)
A3: - Digital control (manufacturer)
A4: - Audio equipment multiplexing (manufacturer)
A5: -
A6: (+ve) Accessories
A7: (+ve) Permanent
A8: (-ve) Earth
B1: (+)
B2: (-)
B3: (+) Front right speaker and tweeter
B4: (-) Front right speaker and tweeter
B5: (+) Front left speaker and tweeter
B6: (-) Front left speaker and tweeter
B7: (+)
B8: (-)



Contact a CITROËN dealer before fitting audio equipment or speakers in your vehicle.

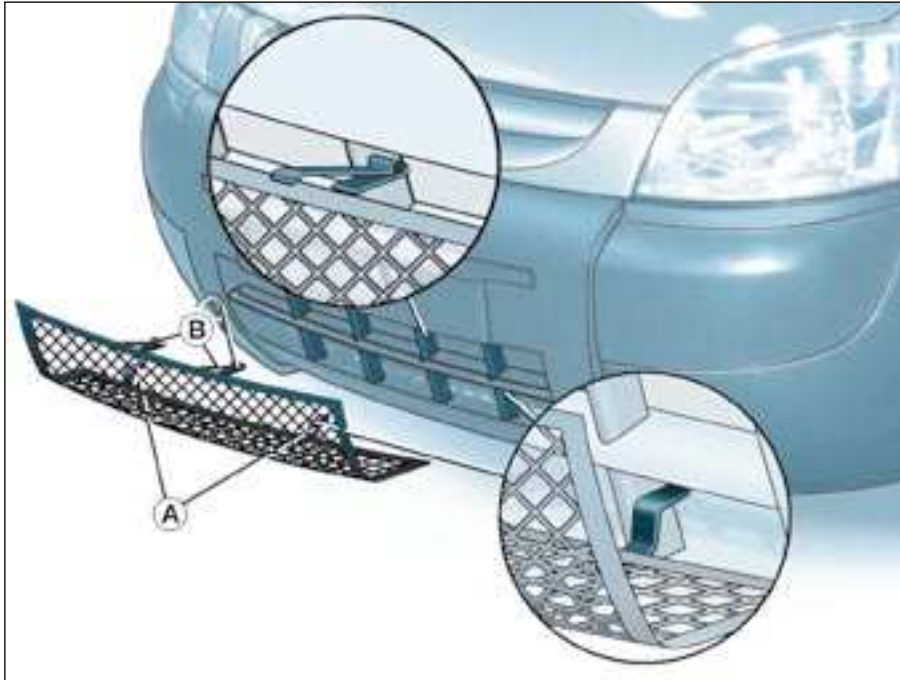

SNOW SCREEN*

The snow screen is installed on the lower part of the front bumper to prevent the accumulation of snow at the radiator cooling fan.

Remove the snow screen:

- when the exterior temperature is higher than 10 °C,
- when towing,
- for speeds higher than 75 mph (120 km/h).

FITTING

- ☞ Offer up the snow screen facing the front bumper.
- ☞ Put it in place positioning the lower clips **A** in the bumper.
- ☞ Press the snow screen at each upper clip **B**.

REMOVAL

- ☞ Press the two upper clips **B** and pull the snow screen.

* As an accessory or according to country.



TOWING YOUR VEHICLE

Without lifting (four wheels on the ground)

You must always use a towbar.

From the front or the rear

Attach the towbar to the towing eye.

By lifting (two wheels only on the ground)

It is preferable to lift the vehicle by the wheels.



Never use the radiator cross-member.

When towing another vehicle, it must freewheel.

Place the gearbox in "neutral".

Failure to observe this instruction may result in damage to certain braking components and the absence of braking assistance when the engine is started again.

TOWING A TRAILER, CARAVAN, BOAT, ETC.

We recommend the use of original CITROËN towbars and their harnesses that have been tested and approved from the design stage of your vehicle and that the fitting of the towbar is entrusted to a CITROËN dealer.

If the towbar is not fitted by a CITROËN dealer, it is imperative that it is fitted using the electrical pre-equipment installed at the rear of the vehicle, in accordance with the manufacturer's instructions.

Your vehicle is primarily designed for transporting people and luggage but it may also be used for towing a trailer.

Driving with a trailer subjects the towing vehicle to more significant stress and its driver must be particularly careful.

Air density decreases with altitude, thus reducing engine performance. Above 1 000 metres, the maximum towing load must be reduced by 10 % and so on for every 1 000 metres of altitude.

Driving advice

Distribution of loads: Distribute the load in the trailer so that the heaviest items are as close as possible to the axle and the nose weight approaches the maximum permitted without exceeding it.

Cooling: Towing a trailer on a slope increases the temperature of the coolant.

As the fan is electrically controlled, its cooling capacity is not dependent on the engine speed.

On the contrary, use a high gear to lower the engine speed and reduce your speed.

The maximum towing load on a long slope depends on the gradient and the outside temperature.

In all cases, pay attention to the coolant temperature.

In certain cases of particularly arduous use (towing the maximum load on a steep gradient in high temperatures), switching off the air conditioning permits the recovery of engine power and therefore an increase in the towing capacity.

If the warning light comes on, stop the vehicle and switch off the engine as soon as possible.

Tyres: Check the tyre pressures of the towing vehicle and of the trailer, observing the recommended pressures.

Braking: Towing increases the braking distance.

Lights: Check the electrical signalling on the trailer.

Side wind: Take into account the increased sensitivity to side wind.



ACCESSORIES

These accessories and parts, having been tested and approved for reliability and safety, are all adapted to your vehicle. A wide range of recommended accessories and original parts is offered.

Range of professional equipment

Load retainers (all models).

Loading roller.

Towbar, towbar harness: trailer towbar which must be fitted by the CITROËN network.

Separation partitions and grilles, smooth, non-slip wooden protective floor.

Protective grilles.

Range of comfort, leisure and maintenance equipment

Anti-theft alarm, window engraving, first aid kit, high visibility safety jacket, rear parking assistance, warning triangle, ...

Front seat covers compatible with air bags, bench, rubber mats, carpet mats, snow chains, blind, tailgate bicycle carrier, roof bars (max load 120 kg), transverse roof bars (max load 100 kg), ...

To prevent the mat from becoming caught under the pedals:

- ensure that the mat and its fixings are positioned correctly,
- never fit one mat on top of another.

Audio equipment, hands-free kit, speakers, CD changer, navigation, ...

Regardless of the audio and telematic equipment offered on the market, the technical constraints linked with the fitting of equipment of these families of products mean that the special features of the equipment and its compatibility with the capacities of the your vehicle's standard equipment must be taken into account. Please contact a CITROËN dealer for information before fitting such equipment.

Installation of radiocommunication transmitters

Before installing accessory radiocommunication transmitters with an

external aerial on your vehicle, you are advised to contact a representative of the CITROËN marque.

The CITROËN Network will inform you of the specifications (frequency band, maximum output power, aerial position, specific installation conditions) of the transmitters which can be fitted, in accordance with the Motor Vehicle Electromagnetic Compatibility Directive (2004/104/CE).

Front mud flaps, rear mud flaps, 15/17 inch alloy wheels, wheelarch trim, leather steering wheel, ...

Screenwash, interior and exterior cleaning and maintenance products, replacement bulbs, ...



The fitting of electrical equipment or accessories which are not recommended by Automobiles CITROËN may result in the failure of your vehicle's electronic system. Please note this specific warning. You are advised to contact a representative of the Marque to be shown the range of recommended equipment and accessories.

Depending on the country in which the vehicle is sold or operated, it is compulsory to have a high visibility safety jacket, warning triangle and replacement bulbs available in the vehicle.

PETROL ENGINES AND GEARBOXES



| Model codes | GBKFWC GCKFWC GJKFWC | GJNFUC |
|--------------------------------------|----------------------------|-------------------|
| ENGINES | 1.4 litre | 1.6 litre |
| Cubic capacity (cm ³) | 1 360 | 1 587 |
| Bore x stroke (mm) | 75 x 77 | 78.5 x 82 |
| EU standard maximum power (kW) | 55 | 80 |
| Maximum power at engine speed (rpm) | 5 500 | 5 800 |
| EU standard maximum torque (Nm) | 120 | 147 |
| Maximum torque at engine speed (rpm) | 3 400 | 4 000 |
| Fuel | Ron 95 - Ron 98 | Ron 95 - Ron 98 |
| Catalytic converter | Yes | Yes |
| Gearbox | Manual (5 speed) | Manual (5 speed) |
| Oil capacity (in litres) | | |
| Engine (with cartridge replacement) | 3 (1) - 3.25 (2) | 3.2 (1) - 3.4 (2) |
| Gearbox - Final drive | 2 | 2 |

(1) Draining by gravity - (2) Draining by suction

DIESEL ENGINES AND GEARBOXES

| Model codes | GB9HWC GC9HWC GJ9HWC | GB9HXC GC9HXC GJ9HXC | GBWJYB GCWJYB GJWJYB |
|--------------------------------------|----------------------------|----------------------------|----------------------------|
| ENGINES | 1.6 litre Turbo HDI | 1.6 litre Turbo HDI | 1.9 litre |
| Cubic capacity (cm ³) | 1 560 | 1 560 | 1 867 |
| Bore x stroke (mm) | 75 x 88.3 | 75 x 88.3 | 82.2 x 88 |
| EU standard maximum power (kW) | 55.2 | 66.2 | 51 |
| Maximum power at engine speed (rpm) | 4 000 | 4 000 | 4 600 |
| EU standard maximum torque (Nm) | 175 | 215 | 125 |
| Maximum torque at engine speed (rpm) | 1 750 | 1 750 | 2 500 |
| Fuel | Diesel | Diesel | Diesel |
| Catalytic converter | Yes | Yes | Yes |
| Gearbox | Manual (5 speed) | Manual (5 speed) | Manual (5 speed) |
| Oil capacity (in litres) | | | |
| Engine (with cartridge replacement) | 3.75 | 3.8 | 4.8 |
| Gearbox - Final drive | 1.9 | 1.9 | 1.9 |

CONSUMPTION IN LITRES/100 KM (IN ACCORDANCE WITH DIRECTIVE 80/1268/CEE)

| | Engine | Gearbox | Model codes | Version | Urban driving | Inter-urban | Mixed | Emission of CO ₂ by weight (g/km) |
|---|----------------------------|---------|---------------|---------------|---------------|-------------|-------|--|
|  | 1.4 litre | Manual | GBKFWC | 600 kg | 9.9 | 6.3 | 7.5 | 175 |
| | | | GCKFWC | 800 kg | 9.9 | 6.3 | 7.5 | 175 |
| | 1.6 litre Turbo HDI | Manual | GB9HWC | 600 kg | 6.7 | 4.7 | 5.4 | 140 |
| | | | GC9HWC | 800 kg | 6.7 | 4.7 | 5.4 | 140 |
| | 1.6 litre Turbo HDI | Manual | GB9HXC | 600 kg | 6.8 | 4.6 | 5.4 | 140 |
| | | | GC9HXC | 800 kg | 6.8 | 4.6 | 5.4 | 140 |
| | 1.9 litre | Manual | GBWJYB | 600 kg | 9.3 | 5.7 | 7.0 | 184 |
| | | | GCWJYB | 800 kg | 9.3 | 5.7 | 7.0 | 184 |
|  | 1.4 litre | Manual | GJKFWC | | 9.6 | 6.2 | 7.4 | 175 |
| | 1.6 litre | Manual | GJNFUC | | 9.7 | 6.2 | 7.5 | 177 |
| | 1.6 litre Turbo HDI | Manual | GJ9HWC | | 6.7 | 4.7 | 5.4 | 143 |
| | 1.6 litre Turbo HDI | Manual | GJ9HXC | | 6.7 | 4.7 | 5.4 | 143 |
| | 1.9 litre | Manual | GJWJYB | | 8.8 | 5.7 | 6.9 | 181 |

The consumption values presented here correspond to the values communicated at the time of printing. These consumption values were established in accordance with directive 80/1268/CEE. They may vary depending on the style of driving, traffic conditions, weather conditions, the load in the vehicle, the maintenance of the vehicle and the use of the accessories.

PETROL WEIGHTS AND TOWING LOADS (IN KG) FOR LIGHT VAN

| Engine | 1.4 litre | |
|-----------------------------------|-----------|--------|
| Gearbox | Manual | Manual |
| Model codes | GBKFWC | GCKFWC |
| Version | 600 kg | 800 kg |
| • Kerb weight | 1 055 | 1 055 |
| • Gross vehicle weight (GVW) | 1 655 | 1 855 |
| • Gross train weight (GTW) | 2 555 | 2 755 |
| • Unbraked trailer | 500 | 500 |
| • Braked trailer (within GTW) | 900 | 900 |
| • Recommended nose weight | 70 | 70 |
| • Recommended weight on roof rack | 100 | 100 |

The GTW and towing load values indicated are valid up to a maximum altitude of 1 000 metres; the towing load mentioned must be reduced by 10 % for each additional 1 000 metres.

The speed of a towing vehicle must not exceed 60 mph (100 km/h) (comply with the legislation in force in your country).

High exterior temperatures may result in a reduction in the performance of the vehicle in order to protect the engine; when the exterior temperature is above 37 °C, limit the towed load.



DIESEL WEIGHTS AND TOWING LOADS (IN KG) FOR LIGHT VAN

| Engine | 1.6 litre Turbo HDI | | 1.9 litre | |
|-----------------------------------|---------------------|--------|-----------|--------|
| Gearbox | Manual | Manual | Manual | Manual |
| Model codes | GB9HWC | GC9HWC | GBWJYB | GCWJYB |
| | GB9HXC | GC9HXC | | |
| Version | 600 kg | 800 kg | 600 kg | 800 kg |
| • Kerb weight | 1 130 | 1 130 | 1 206 | 1 206 |
| • Gross vehicle weight (GVW) | 1 730 | 1 930 | 1 805 | 1 955 |
| • Gross train weight (GTW) | 2 830 | 3 030 | 2 855 | 3 055 |
| • Unbraked trailer | 500 | 500 | 500 | 500 |
| • Braked trailer (within GTW) | 1 100 | 1 100 | 1 050 | 1 100 |
| • Recommended nose weight | 70 | 70 | 70 | 70 |
| • Recommended weight on roof rack | 100 | 100 | 100 | 100 |

The GTW and towing load values indicated are valid up to a maximum altitude of 1 000 metres; the towing load mentioned must be reduced by 10 % for each additional 1 000 metres.

The speed of a towing vehicle must not exceed 60 mph (100 km/h) (comply with the legislation in force in your country).

High exterior temperatures may result in a reduction in the performance of the vehicle in order to protect the engine; when the exterior temperature is above 37 °C, limit the towed load.



PETROL WEIGHTS AND TOWING LOADS (IN KG) FOR LUDOSPACE

| Engine | 1.4 litre | 1.6 litre |
|-----------------------------------|-----------|-----------|
| Gearbox | Manual | Manual |
| Model codes | GJKFWC | GJNFUC |
| • Kerb weight | 1 197 | 1 254 |
| • Gross vehicle weight (GVW) | 1 780 | 1 840 |
| • Gross train weight (GTW) | 2 680 | 2 940 |
| • Unbraked trailer | 540 | 540 |
| • Braked trailer (within GTW) | 900 | 1 100 |
| • Recommended nose weight | 70 | 70 |
| • Recommended weight on roof rack | 100 | 100 |

The GTW and towing load values indicated are valid up to a maximum altitude of 1 000 metres; the towing load mentioned must be reduced by 10 % for each additional 1 000 metres.

The speed of a towing vehicle must not exceed 60 mph (100 km/h) (comply with the legislation in force in your country).

High exterior temperatures may result in a reduction in the performance of the vehicle in order to protect the engine; when the exterior temperature is above 37 °C, limit the towed load.



DIESEL WEIGHTS AND TOWING LOADS (IN KG) FOR LUDOSPACE

| Engine | 1.6 litre Turbo HDI | 1.6 litre Turbo HDI | 1.9 litre |
|-----------------------------------|---------------------|---------------------|-----------|
| Gearbox | Manual | Manual | Manual |
| Model codes: | GJ9HWC | GJ9HXC | GJWJYB |
| • Kerb weight | 1 269 | 1 240 | 1 240 |
| • Gross vehicle weight (GVW) | 1 880 | 1 880 | 1 840 |
| • Gross train weight (GTW) | 2 980 | 2 980 | 2 940 |
| • Unbraked trailer | 540 | 540 | 500 |
| • Braked trailer (within GTW) | 1 100 | 1 100 | 1 100 |
| • Recommended nose weight | 70 | 70 | 70 |
| • Recommended weight on roof rack | 100 | 100 | 100 |

The GTW and towing load values indicated are valid up to a maximum altitude of 1 000 metres; the towing load mentioned must be reduced by 10 % for each additional 1 000 metres.

The speed of a towing vehicle must not exceed 60 mph (100 km/h) (comply with the legislation in force in your country).

High exterior temperatures may result in a reduction in the performance of the vehicle in order to protect the engine; when the exterior temperature is above 37 °C, limit the towed load.

EXTERIOR DIMENSIONS (IN MM)



| | Light van | Ludospace |
|----------|----------------|----------------|
| A | 2 693 | |
| B | 4 137 | |
| C | 836 | |
| D | 608 | |
| E | 570 | 550 |
| F | 1 440 | 1 440 or 1 452 |
| G | 1 960 | |
| H | 1 796 to 1 819 | 1 810 |
| I | 1 420 | 1 420 or 1 436 |
| J | 1 724 | |



**INTERIOR DIMENSIONS (IN MM) LIGHT VAN**

| | |
|----------|-------|
| K | 1 155 |
| L | 1 320 |
| M | 1 190 |
| N | 1 190 |
| O | 568 |
| P | 1 340 |





INTERIOR DIMENSIONS (IN MM) LUDOSPACE



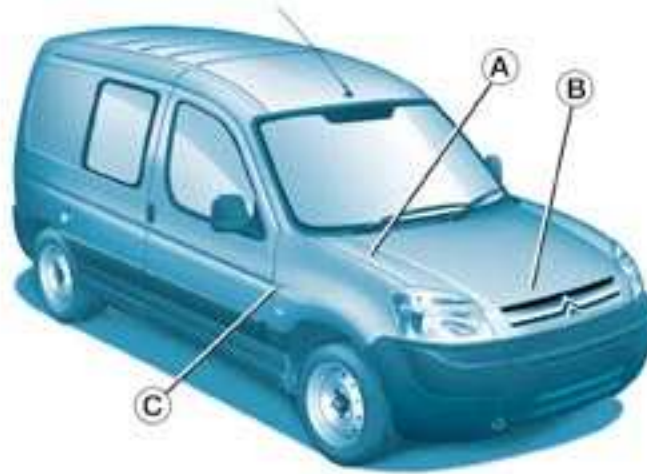

IDENTIFICATION FEATURES

A. Manufacturer's label (under the bonnet, on the front right wing).

B. Serial number on the bodywork (under the bonnet, on the right-hand crossmember).

C. Tyres and paint colour reference.

The label C on the driver's door pillar, near the hinges, gives:

- the wheel and tyre sizes,
- the tyre pressures: **(tyre pressure checks must be carried out cold, at least every month),**
- the paint colour reference.