

# Rider's Manual

## F 800 ST



BMW Motorrad



The Ultimate Riding  
Machine

## Motorcycle data/dealership details

### Motorcycle data

---

Model

---

Vehicle identification number

---

Colour code

---

Date of first registration

---

Registration number

### Dealership details

---

Person to contact in Service department

---

Ms/Mr

---

Phone number

---

Dealership address/phone number (company stamp)

## Welcome to BMW

We congratulate you on your choice of a motorcycle from BMW and welcome you to the community of BMW riders.

Familiarise yourself with your new motorcycle so that you can ride it safely and confidently in all traffic situations.

Please read this Rider's Manual carefully before starting to use your new BMW motorcycle. It contains important information on how to operate the controls and how to make the best possible use of all your BMW's technical features.

In addition, it contains information on maintenance and care to help you maintain your motorcycle's reliability and safety, as well as its value.

If you have questions concerning your motorcycle, your authorised

BMW Motorrad dealer will gladly provide advice and assistance.

We hope that you will enjoy riding your BMW and that all your journeys will be pleasant and safe.

BMW Motorrad.

## Table of Contents

You can also consult the index at the end of this Rider's Manual if you want to find a particular topic or item of information.

### **1 General instructions ..... 5**

Overview ..... 6

Abbreviations and symbols ..... 6

Equipment ..... 7

Technical data ..... 7

Currency ..... 7

### **2 General views ..... 9**

General view, left side ..... 11

General view, right side ..... 13

Underneath the seat ..... 14

Underneath the battery-com-

partment cover ..... 15

Handlebar fitting, left ..... 16

Handlebar fitting, right ..... 17

Instrument cluster ..... 18

Headlight ..... 19

### **3 Status indicators ..... 21**

Standard status

indicators ..... 22

Status indicators with on-

board computer<sup>OE</sup> ..... 23

Status indicators with

tyre-pressure monitoring

(RDC)<sup>OE</sup> ..... 24

Standard warnings ..... 24

Warnings issued by the on-

board computer (OE) ..... 29

ABS status indicators<sup>OE</sup> ..... 29

RDC status indicators<sup>OE</sup> ..... 32

Anti-theft alarm warnings

(OE) ..... 36

### **4 Operation ..... 37**

Ignition switch and steering

lock ..... 38

Electronic immobiliser

(EWS) ..... 39

Clock ..... 40

Odometer and tripmeters .... 40

On-board computer<sup>OE</sup> ..... 41

Tyre pressure monitoring

RDC<sup>OE</sup> ..... 46

Lights ..... 47

Turn indicators ..... 48

Hazard warning flashers ..... 49

Emergency off switch (kill

switch) ..... 50

Grip heating<sup>OE</sup> ..... 51

Clutch ..... 51

Brakes ..... 52

Mirrors ..... 52

Spring preload ..... 52

Damping ..... 54

Tyres ..... 54

Headlight ..... 55

Seat ..... 56

Helmet holder ..... 56

### **5 Riding ..... 59**

Safety instructions ..... 60

Checklist ..... 62

Starting ..... 62

Running in ..... 64

Brakes ..... 65

Parking your motorcycle ..... 67

Refuelling .....	68	Front-wheel stand.....	102	Running gear.....	127
<b>6 Engineering details.....</b>	<b>71</b>	Rear-wheel stand .....	103	Brakes .....	128
Brake system with BMW Mo-		Bulbs.....	104	Wheels and tyres.....	128
torrad ABS <sup>OE</sup> .....	72	Jump starting .....	110	Electrics.....	130
Tyre pressure monitoring		Battery .....	112	Frame.....	132
RDC <sup>OE</sup> .....	74	<b>9 Care.....</b>	<b>117</b>	Dimensions .....	132
<b>7 Accessories .....</b>	<b>75</b>	Care products.....	118	Weights .....	133
General instructions .....	76	Washing motorcycle.....	118	Riding specifications .....	133
Power socket .....	76	Cleaning easily damaged		<b>11 Service .....</b>	<b>135</b>
Luggage .....	77	components.....	118	BMW Motorrad service.....	136
Case <sup>OA</sup> .....	78	Paint care .....	119	BMW Motorrad service	
Topcase <sup>OA</sup> .....	81	Protective wax coating .....	120	quality .....	136
<b>8 Maintenance .....</b>	<b>85</b>	Laying up the motor-		BMW Motorrad Service	
General instructions .....	86	cycle .....	120	Card: on-the-spot break-	
On-board toolkit service		Restoring motorcycle to		down assistance .....	136
kit .....	86	use .....	120	BMW Motorrad service net-	
Engine oil .....	87	<b>10 Technical data .....</b>	<b>121</b>	work.....	137
Brake system, general.....	88	Troubleshooting chart.....	122	Maintenance work.....	137
Brake pads .....	89	Threaded fasteners .....	123	Confirmation of mainten-	
Brake fluid.....	91	Engine .....	124	ance work .....	138
Coolant.....	93	Fuel .....	125	Confirmation of service.....	143
Clutch.....	95	Engine oil .....	125		
Tyres.....	95	Clutch.....	126		
Rims .....	95	Transmission.....	126		
Wheels .....	96	Rear-wheel drive .....	127		



## General instructions

Overview .....	6
Abbreviations and symbols .....	6
Equipment .....	7
Technical data .....	7
Currency .....	7

## Overview

Chapter 2 of this Rider's Manual will provide you with an initial overview of your motorcycle. All maintenance and servicing work on the motorcycle is documented in Chapter 10. This record of the maintenance work you have had performed on your motorcycle is a precondition for generous treatment of goodwill claims.

When the time comes to sell your BMW, please remember to hand over this Rider's Manual; it is an important part of the motorcycle.

## Abbreviations and symbols



Indicates warnings that you must comply with for reasons of your safety and the safety of others, and to protect your motorcycle against damage.



Specific instructions on how to operate, control, adjust or look after items of equipment on the motorcycle.



Indicates the end of an item of information.



Instruction.



Result of an activity.



Reference to a page with more detailed information.



Indicates the end of a passage relating to specific accessories or items of equipment.



Tightening torque.



Item of technical data.

**OE** Optional extra  
The motorcycles are assembled complete with all the BMW optional extras originally ordered.

**OA** Optional accessory  
You can obtain optional accessories through your authorised BMW Motorrad dealer; optional accessories have to be retrofitted to the motorcycle.

**EWS** Electronic immobiliser (Elektronische Wegfahrsicherung).

**DWA** Anti-theft alarm (Diebstahlwarnanlage)

**ABS** Anti-lock brake system

**RDC** Tyre pressure control (ReifenDruck-Control)



## Equipment

When you ordered your BMW motorcycle, you chose various items of custom equipment. This Rider's Manual describes optional extras (OE) offered by BMW and selected optional accessories (OA). This explains why the manual may also contain descriptions of equipment which you have not ordered. Please note, too, that your motorcycle might not be exactly as illustrated in this manual on account of country-specific differences. If your BMW was supplied with equipment not described in this Rider's Manual, you will find these features described in separate manuals.

## Technical data

All dimensions, weights and power ratings stated in the Rider's Manual are quoted to the standards and comply with the tolerance requirements of the Deutsche Institut für Normung e.V. Versions for individual countries may differ.

## Currency

The high safety and quality standards of BMW motorcycles are maintained by constant development work on designs, equipment and accessories. Because of this, your motorcycle may differ from the information supplied in the Rider's Manual. Nor can BMW Motorrad entirely rule out errors and omissions. We hope you will appreciate that no claims can be entertained on the basis of the data, illustrations or descriptions in this manual.



## General views

General view, left side .....	11
General view, right side .....	13
Underneath the seat .....	14
Underneath the battery-compartment cover .....	15
Handlebar fitting, left .....	16
Handlebar fitting, right .....	17
Instrument cluster .....	18
Headlight .....	19



## General view, left side

- 1 Adjuster for headlight beam throw (underneath the instrument cluster) (⇒ 55)
- 2 Seat lock (⇒ 56)
- 3 Engine-oil filler neck and oil dipstick (⇒ 87)

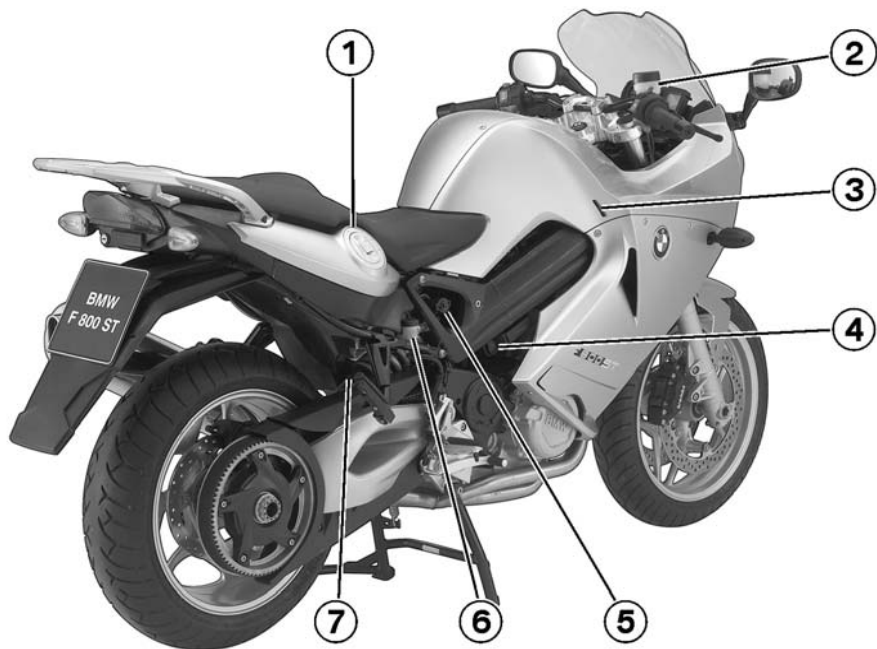

## General view, right side

- 1 Fuel filler neck (➡ 68)
- 2 Brake-fluid reservoir, front (➡ 91)
- 3 Coolant-level indicator (➡ 93)
- 4 Power socket (➡ 76)
- 5 Adjuster for spring preload, rear (➡ 52)
- 6 Brake-fluid reservoir, rear (➡ 92)
- 7 Adjuster for damping characteristic, rear suspension (➡ 54)

## Underneath the seat

- 1 Table of tyre pressures
- 2 Screwdriver blade, cross-head/Torx 25
- 3 Screwdriver handle
- 4 Rider's Manual
- 5 Helmet holder (➔ 56)
- 6 Location of first-aid kit (OA)
- 7 On-board toolkit service kit (➔ 86)
- 8 Tool for adjusting spring preload (➔ 52)

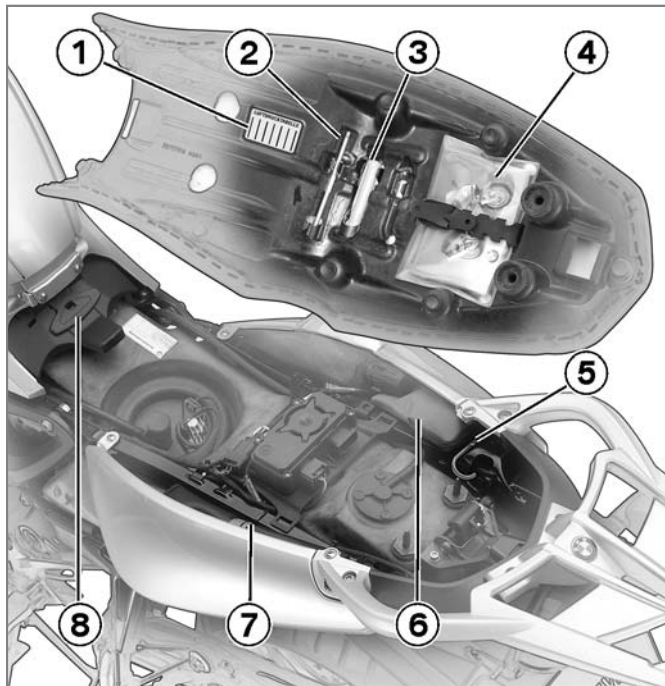



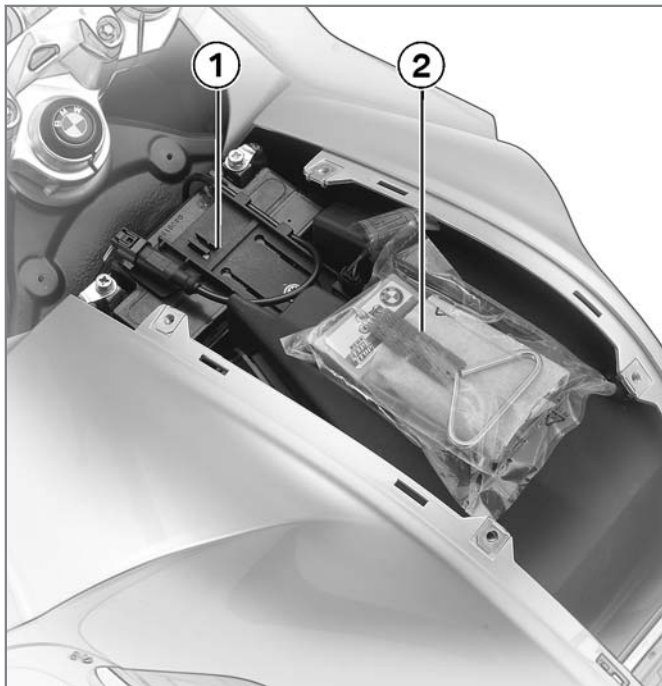

## Underneath the battery-compartment cover

- 1 Battery (→ 112)
- 2 Location of puncture-repair kit (OA)

## Handlebar fitting, left

- 1 Operating the on-board computer<sup>OE</sup> (➔ 41)
- 2 Horn
- 3 Flashing turn indicators, left (➔ 48), Hazard warning flashers (➔ 49)
- 4 High-beam headlight and headlight flasher (➔ 47)

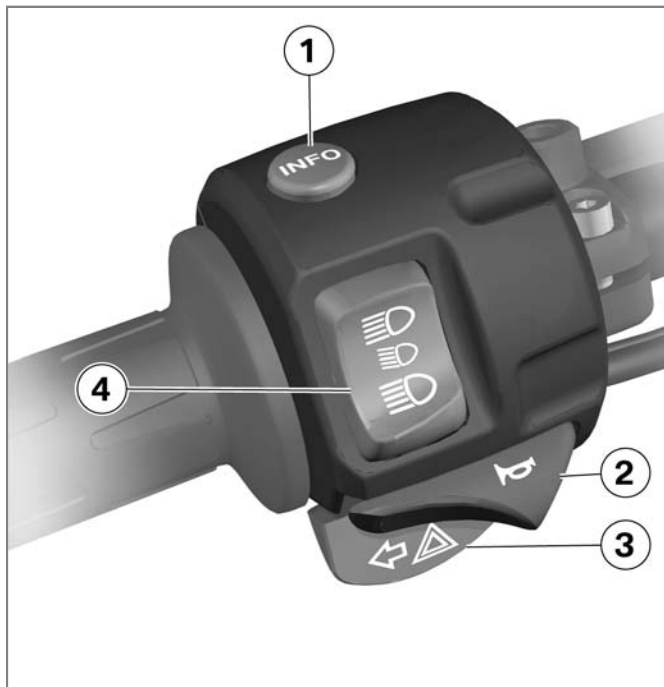



## Handlebar fitting, right

- 1 Emergency off switch (kill switch) (➔ 50)
- 2 Starter button (➔ 62)
- 3 Grip heating<sup>OE</sup> (➔ 51)
- 4 Flashing turn indicators, right (➔ 48), Hazard warning flashers (➔ 49)
- 5 Cancel button, flashing turn indicators (➔ 49), Pushbutton, cancel hazard warning flashers (➔ 50)

## Instrument cluster

- 1 Telltale lights (➡ 22)
- 2 Speedometer
- 3 Operation of the stopwatch<sup>OE</sup> (➡ 44)  
Set the clock (➡ 40)
- 4 Multifunction display (➡ 22)
- 5 Select readings (➡ 40)  
Reset the tripmeter (➡ 41)
- 6 Telltale light, anti-theft alarm (OE), Sensor for instrument lighting, RPM redline warning
- 7 Rev. counter

 The instrument-cluster lighting has automatic day and night switchover. ◀

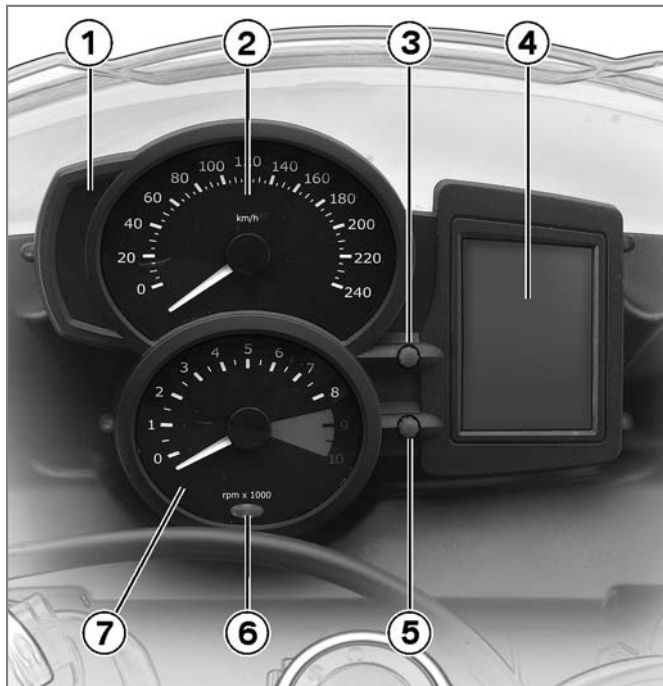

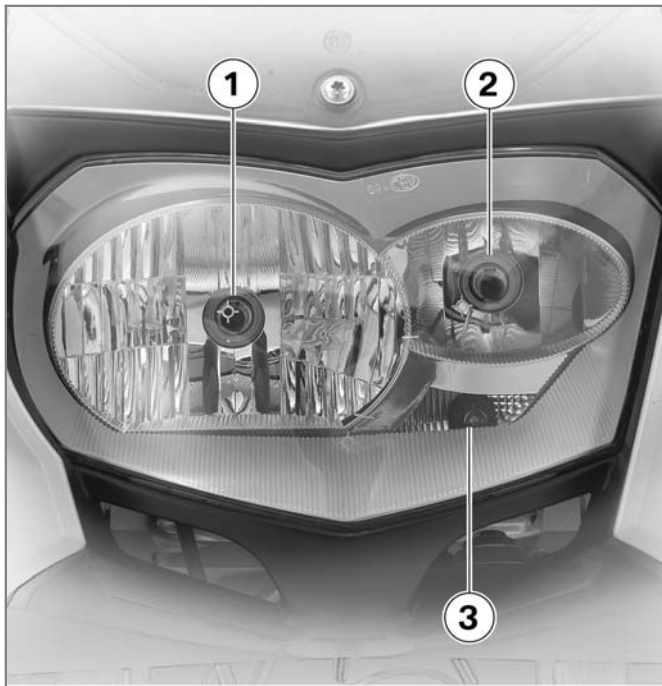

## Headlight

- 1 Low-beam headlight
- 2 High-beam headlight
- 3 Side lights



## Status indicators

Standard status indicators .....	22
Status indicators with on-board computer <sup>OE</sup> .....	23
Status indicators with tyre-pressure monitoring (RDC) <sup>OE</sup> .....	24
Standard warnings .....	24
Warnings issued by the on-board computer (OE) .....	29
ABS status indicators <sup>OE</sup> .....	29
RDC status indicators <sup>OE</sup> .....	32
Anti-theft alarm warnings (OE) .....	36

## Standard status indicators

### Multifunction display

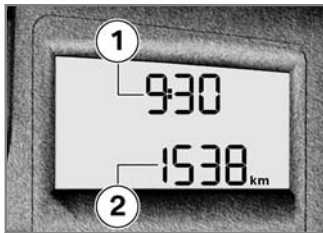

- 1 Clock (➡ 40)
- 2 Odometer and tripmeters (➡ 40)

## Telltale lights

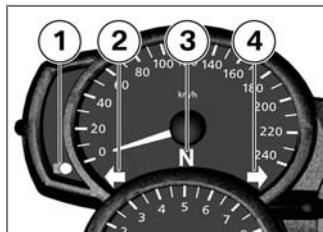

- 1 High-beam headlight
- 2 Flashing turn indicators, left
- 3 Idle
- 4 Flashing turn indicators, right

## Service-due indicator

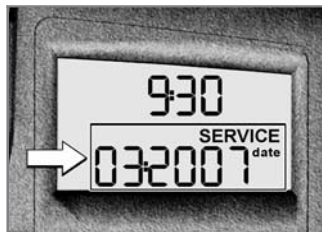

If the next service is due in less than one month, the date for the next service is shown briefly after the Pre-Ride Check completes. The month is shown as a two-digit number and the year as a four-digit number, with a colon as separator, so in this example the next service is due in March 2007.



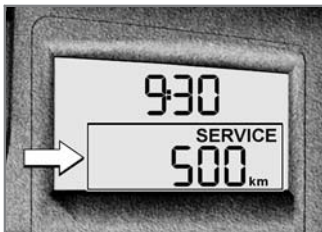

If the motorcycle covers long distances in the course of the year, under certain circumstances it might be necessary to have it serviced at a date in advance of the forecast due date. If the countdown distance to the odometer reading at which a service will be due is less than 1000 km, the distance is counted down in steps of 100 km and is shown briefly after the Pre-Ride Check completes.

If service is overdue, the due date or the odometer reading at which service was due is accom-

panied by the 'General' warning light showing yellow. The word "Service" remains permanently visible.

▶ If the service-due indicator appears more than a month in advance of the actual due date or if the word "Service" does not show permanently even though a service is overdue, the date stored in memory in the instrument cluster is incorrect and must be set. This situation can occur if the battery was disconnected for a prolonged period of time.

If you want to have the date set consult a specialist workshop, preferably an authorised BMW Motorrad dealer. ◀

## Status indicators with on-board computer<sup>OE</sup>

### Multifunction display

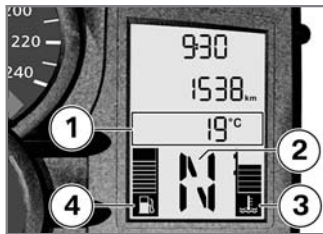

- 1 Status-indicator panel of the on-board computer<sup>OE</sup> (⇒ 41)
- 2 Gear indicator (⇒ 23)
- 3 Coolant temperature (⇒ 24)
- 4 Fuel capacity (⇒ 24)

### Gear indicator

**N** The gear engaged or N for neutral appears on the display.

**N** If no gear is engaged, the 'neutral' telltale light also lights up.

### Coolant temperature

 The horizontal bars above the temperature symbol indicate the coolant temperature.

### Fuel capacity

 The horizontal bars above the fuel-pump symbol indicate the remaining quantity of fuel. The top bar is larger than the others and the quantity of fuel it represents is correspondingly larger.

When the fuel in the tank is topped up the gauge briefly shows the original level, before the reading is updated.

## Status indicators with tyre-pressure monitoring (RDC)<sup>OE</sup>

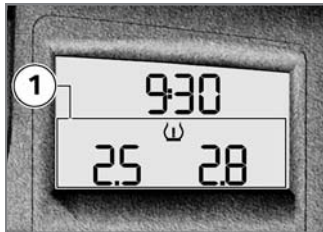

**1** Tyre pressures alternate with the odometer readings<sup>OE</sup> (→ 46)

## Standard warnings

### Mode of presentation

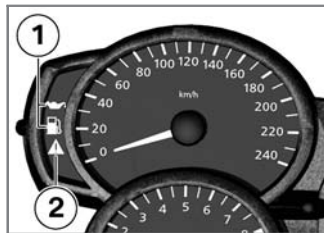

Warnings are indicated by the warning lights **1** or by the 'General' warning light **2** showing in combination with a text warning or a warning symbol in the multifunction display. The 'General' warning light shows red or yellow, depending on the urgency of the warning.

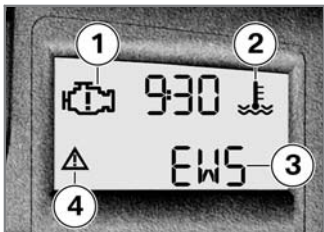











The possible warnings are listed on the next page.

Warning symbols **1** and **2** can appear on the multifunction display. Text warnings such as **3**, for example, appear in the odometer panel and are accompanied by warning-triangle symbol **4**.

If two or more warnings occur at the same time, all the appropriate warning lights and warning symbols appear. You can call up text warnings to alternate with the odometer readings (➡ 40). The status of the 'General' warning light matches the most urgent warning.

## Warnings, overview

		<b>Meaning</b>		
	Lights up yellow		Appears on the display	Electronic immobiliser active (➡ 27)
		EWS appears on the display.		
	Lights up			Fuel down to reserve (➡ 27)
	Lights up red		Temperature symbol flashes.	Coolant temperature too high (➡ 27)
	Lights up yellow		Appears on the display	Engine in emergency-operation mode (➡ 27)
	Flashes			Insufficient engine oil pressure (➡ 28)
	Lights up yellow		Appears on the display	Bulb defective (➡ 28)
		LAMP appears on the display.		

### Electronic immobiliser active



General warning light shows yellow.



Warning-triangle symbol appears on the display.

EWS appears on the display.

The key being used is not authorised for starting, or communication between key and engine electronics is disrupted.

- Remove all other vehicle keys from the same ring as the ignition key.
- Use the reserve key.
- Have the defective key replaced, preferably by an authorised BMW Motorrad dealer.

### Fuel down to reserve



Warning light for fuel down to reserve shows.



Lack of fuel can result in the engine misfiring and cutting out unexpectedly. Misfiring can damage the catalytic

converter; a hazardous situation can result if the engine cuts out unexpectedly.

Do not run the fuel tank dry.◀

The fuel tank contains no more than the reserve quantity of fuel.

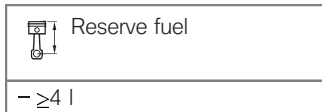

- Refuelling (➔ 68)

### Coolant temperature too high



General warning light shows red.



The temperature symbol flashes.



Continuing to ride when the engine is overheated could result in engine damage.

You must comply with the instructions below.◀

If the coolant level is too low.

- Check the coolant level (➔ 93)
- If the coolant level is too low:
- Topping up coolant (➔ 93)

The coolant temperature is too high.

- If possible, ride in the part-load range to cool down the engine.
- In traffic jams, switch off the engine, but leave the ignition switched on so that the radiator or fan continues to operate.
- If the coolant temperature is frequently too high, have the fault rectified as soon as possible by a specialist workshop, preferably an authorised BMW Motorrad dealer.

### Engine in emergency-operation mode



General warning light shows yellow.



Engine symbol appears on the display.



The engine is running in emergency operating mode.

Engine power might be reduced and this can cause hazardous situations, particularly if you attempt to overtake other road users.

Engine power level might be lower than normal: adapt your style of riding accordingly. ◀

The engine control unit has diagnosed a fault. In exceptional cases, the engine stops and refuses to start. Otherwise, the engine runs in emergency operating mode.

- You can continue to ride, but bear in mind that the usual engine power might not be available.
- Have the fault rectified as quickly as possible by a specialist workshop, preferably

an authorised BMW Motorrad dealer.

### Insufficient engine oil pressure



Warning light for engine-oil pressure flashes.

The oil pressure in the lube-oil system is too low. Stop immediately and switch off the engine if the warning light shows.



The insufficient oil pressure warning does not fulfil the function of an oil gauge. The only way of checking whether the oil level is correct is to check with the oil dipstick. ◀

A low oil level is one reason why a warning indicating insufficient oil pressure is issued.

- Check the engine oil level (➡ 87)
- Top up the engine oil (➡ 88)

If the oil level is too low:

If the engine oil level is correct:



Riding when engine-oil pressure is low can result in engine damage.

Do not continue your journey. ◀

- Have the fault rectified as quickly as possible by a specialist workshop, preferably an authorised BMW Motorrad dealer.

### Bulb defective



General warning light shows yellow.



Warning-triangle symbol appears on the display.

LAMP appears on the display.



A defective bulb places your safety at risk because it is easier for other users to oversee the motorcycle.

Replace defective bulbs as soon as possible; always carry a

complete set of spare bulbs if possible. ◀

Low-beam headlight, parking light, rear-light, brake-light or turn-indicator bulb defective.

- Visually inspect to ascertain which bulb is defective.
- Replacing high-beam/low-beam headlight bulb (➡ 105)
- Replacing parking-light bulb (➡ 106)
- Replacing the brake light and rear light bulbs (➡ 108)
- Replacing turn indicator bulbs, front or rear (➡ 109)

## Warnings issued by the on-board computer (OE)

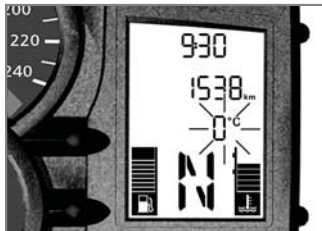

The ambient-temperature reading flashes.

The air temperature measured at the motorcycle is lower than 3 °C.

 The ice warning does not mean that there is no risk of black ice forming at measured temperatures above 3 °C. Always take extra care and think well ahead when temperatures are low; remember that the

danger of black ice is particularly high on bridges and where the road is in the shade. ◀

- Ride carefully and think well ahead.

## ABS status indicators<sup>OE</sup>

### Mode of presentation

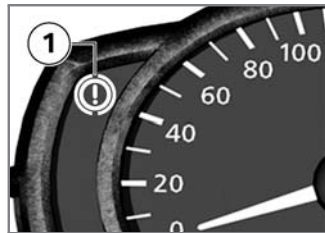

ABS warnings are indicated by ABS warning light **1**.

The way in which the ABS warning light indicates status can differ in some countries.





Possible national variant.

The detailed descriptions relating to BMW Motorrad ABS start on page (➔ 72), and you will find an overview listing the possible warnings on the next page.



## Warnings, overview

	Meaning
 Flashes	Self-diagnosis not completed (➡ 32)
 Lights up	ABS fault (➡ 32)

### Self-diagnosis not completed



ABS warning light flashes.

The ABS function is not available, because self-diagnosis did not complete. The motorcycle has to move forward a few metres for the wheel sensors to be tested.

- Pull away slowly. Bear in mind that the ABS function is not available until self-diagnosis has completed.

### ABS fault



ABS warning light shows.

The ABS control unit has detected a fault. The ABS function is not available.

- You can continue to ride. Bear in mind that the ABS function is not available. Bear in mind the more detailed information

on situations that can lead to an ABS fault (➔ 73).

- Have the fault rectified as quickly as possible by a specialist workshop, preferably an authorised BMW Motorrad dealer.

### RDC status indicators<sup>OE</sup>

#### Mode of presentation

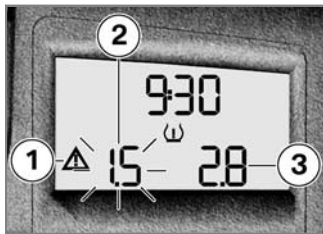

Warning symbol **1** indicates a critical tyre pressure, and the corresponding reading for the front tyre pressure **2** or the rear tyre pressure **3** flashes.











If the critical value is close to the limit of the permissible tolerance range, the reading is accompanied by the 'General' warning light showing yellow. If the tyre pressure registered by the sensor is outside the permissible tolerance range, the 'General' warning light shows red.

The detailed descriptions relating to BMW Motorrad RDC start on page (➔ 74), and you will find an overview listing the possible warnings on the next page.

## Warnings, overview

### Meaning

 Lights up yellow	 Appears on the display The critical tyre pressure flashes	Tyre pressure close to limit of permitted tolerance (➡ 34)
 Flashes red	 Appears on the display The critical tyre pressure flashes	Tyre pressure outside permitted tolerance (➡ 34)
	"--" or "-- --" appears on the display	Signal transmission disrupted (➡ 34)
 Lights up yellow	 Appears on the display "--" or "-- --" appears on the display	Sensor defective or system error (➡ 35)
 Lights up yellow	 Appears on the display RdC appears on the display.	Battery of tyre-pressure sensor weak (➡ 35)

### Tyre pressure close to limit of permitted tolerance



General warning light shows yellow.



Warning-triangle symbol appears on the display.

The critical tyre pressure flashes. Measured tyre pressure is close to the limit of permitted tolerance.

- Correct the tyre pressure as stated on the inside cover of the Rider's Manual.



The tyre-pressures listed on the inside cover are temperature-compensated; the reference tyre temperature for these readings is always 20 °C. The procedure for correctly tyre pressures when the tyres are not at this reference temperature is as follows:

Calculate the difference between the specified value stated in the Rider's Manual and the reading

shown by the RDC system. Use the public air line at a petrol station or motorway service area to adjust the tyre pressure by this amount. ◀

### Tyre pressure outside permitted tolerance



General warning light flashes red.



Warning-triangle symbol appears on the display.

The critical tyre pressure flashes. Measured tyre pressure is outside permitted tolerance.

- Check the tyre for damage and to ascertain whether the motorcycle can be ridden with the tyre in its present condition.

If the motorcycle can be ridden with the tyre in its present condition:



Incorrect tyre pressures impair the motorcycle's handling characteristics.

If tyre pressure is incorrect it is essential to adapt your style of riding accordingly. ◀

- Correct the tyre pressure at the earliest possible opportunity.
- Have the tyre checked for damage by a specialist workshop, preferably an authorised BMW Motorrad dealer.

If you are unsure whether the motorcycle can be ridden with the tyre in its present condition:

- Do not continue your journey.
- Notify the breakdown service.
- Have the tyre checked for damage by a specialist workshop, preferably an authorised BMW Motorrad dealer.

### Signal transmission disrupted

"--" or "-- --" appears on the display.

The motorcycle has not yet accelerated past the threshold of approximately 30 km/h. The RDC sensors do not start transmitting signals until the motorcycle reaches a speed above this threshold (➡ 74).

- Increase speed above this threshold observe the RDC readings. Assume that a permanent fault has not occurred unless the 'General' warning light comes on to accompany the symptoms. Under these circumstances:
- Have the fault rectified by a specialist workshop, preferably an authorised BMW Motorrad dealer.

Wireless communication with the RDC sensors has been disrupted. Possible causes include radio-communication systems operating in the vicinity and interfering

with the link between the RDC control unit and the sensors.

- Move to another location and observe the RDC readings. Assume that a permanent fault has not occurred unless the 'General' warning light comes on to accompany the symptoms. Under these circumstances:
- Have the fault rectified by a specialist workshop, preferably an authorised BMW Motorrad dealer.

### **Sensor defective or system error**



General warning light shows yellow.



Warning-triangle symbol appears on the display.

"---" or "--- ---" appears on the display.

Motorcycle is fitted with wheels not equipped with RDC sensors.

- Fit wheels and tyres equipped with RDC sensors.

One or two RDC sensors have failed.

- Have the fault rectified by a specialist workshop, preferably an authorised BMW Motorrad dealer.

A system error has occurred.

- Have the fault rectified by a specialist workshop, preferably an authorised BMW Motorrad dealer.

### **Battery of tyre-pressure sensor weak**



General warning light shows yellow.



Warning-triangle symbol appears on the display.

RdC appears on the display.

▶ This error message appears only briefly after the pre-ride check completes. ◀

The integral battery in the tyre-pressure sensor has lost a significant proportion of its original capacity. There is no assurance of how long the tyre pressure monitoring system can remain operational.

- Seek the advice of a specialist workshop, preferably an authorised BMW Motorrad dealer.

## Anti-theft alarm warnings (OE)



General warning light shows yellow.



The text warning dWA appears, accompanied by a warning-triangle symbol to indicate that this is a warning.

▶ This error message appears only briefly after the pre-ride check completes. ◀

The integral battery in the anti-theft alarm has lost its entire original capacity. There is no assurance that the anti-theft alarm will be operational if the motorcycle's battery is disconnected.

- Seek the advice of a specialist workshop, preferably an authorised BMW Motorrad dealer.

## Operation

Ignition switch and steering lock . . . . .	38	Spring preload . . . . .	52
Electronic immobiliser (EWS) . . . . .	39	Damping . . . . .	54
Clock . . . . .	40	Tyres . . . . .	54
Odometer and tripmeters . . . . .	40	Headlight . . . . .	55
On-board computer <sup>OE</sup> . . . . .	41	Seat . . . . .	56
Tyre pressure monitoring RDC <sup>OE</sup> . . . . .	46	Helmet holder . . . . .	56
Lights . . . . .	47		
Turn indicators . . . . .	48		
Hazard warning flashers . . . . .	49		
Emergency off switch (kill switch) . . . . .	50		
Grip heating <sup>OE</sup> . . . . .	51		
Clutch . . . . .	51		
Brakes . . . . .	52		
Mirrors . . . . .	52		

## Ignition switch and steering lock

### Keys

You receive one master key and one spare key. Please consult the information on the electronic immobiliser (EWS) if a key is lost or mislaid (➔ 39).

Ignition switch and steering lock, tank filler cap lock and seat lock are all operated with the same key.

with OA Case and with OA Topcase:

If you wish you can arrange to have the cases and the top-case fitted with locks that can be opened with this key as well. Consult a specialist workshop, preferably an authorised BMW Motorrad dealer.<

## Switching on ignition



- Turn the key to position **1**.
  - » Side light and all function circuits switched on.
  - » Engine can be started.
  - » Pre-ride check is performed. (➔ 63)

with OE BMW Motorrad ABS:

- Turn the key to position **1**.
  - » ABS self-diagnosis is performed in addition to the checks outlined above. (➔ 64)<

## Switching off ignition

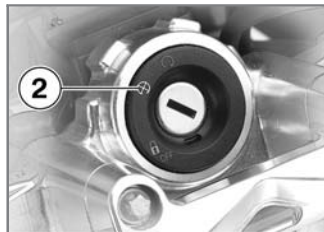

- Turn the key to position **2**.
  - » Lights switched off.
  - » Handlebars not locked.
  - » Key can be removed.
  - » Electrically powered accessories remain operational for a limited period of time.
  - » The battery can be recharged via the on-board socket.



## Locking handlebars



- Turn the handlebars all the way to the left
- Turn the key to position **3**, while moving the handlebars slightly.
  - » Ignition, lights and all function circuits switched off.
  - » Handlebars locked.
  - » Key can be removed.

## Electronic immobiliser (EWS)

### Protection against theft

The electronic immobiliser helps protect your BMW motorcycle from theft, and this enhanced security is at your disposal without any need for you to set parameters or activate additional systems. The engine of a motorcycle fitted with this electronic immobiliser can be started only with the keys that belong to the vehicle. You can also have your authorised BMW Motorrad dealer bar individual keys, for example if a particular key goes missing. The engine cannot be started with a key that has been barred.

### In-key electronics

The motorcycle's electronics exchange certain continuously changing signals with the electronics in the key; these signals

are specific to your motorcycle and they are transmitted via the ring aerial in the ignition lock. The ignition is not enabled for starting until the key has been recognised as "authorised" for your motorcycle.

▶ A spare key attached to the same ring as the ignition key used to start the engine could "irritate" the electronics, in which case the enabling signal for starting is not issued. The EWS warning appears in the multifunction display. Always keep the spare key separately from the ignition key.◀

### Replacement and extra keys

You can obtain replacement/extra keys only through an authorised BMW Motorrad dealer. The keys are part of an integrated security system, so the dealer is under an obligation to check the

legitimacy of all applications for replacement/extra keys. If you want to have a lost key barred, you have to bring with you all the other keys that belong to the motorcycle. A key that has been barred can subsequently be cleared and reactivated for use.

## Clock

### Setting clock



Attempting to set the clock while riding the motorcycle can lead to accidents.

Set the clock only when the motorcycle is stationary.◀

- Switch on the ignition.

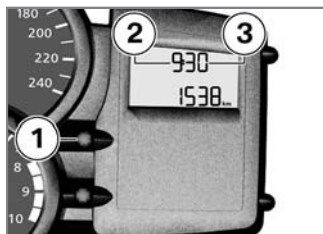

- Press and hold down button **1**.
  - » Hours reading **2** flashes.
- Press button **1**.
  - » The hours reading increments by one each time you press the button.
- Press and hold down button **1**.
  - » Minutes reading **3** flashes.
- Press button **1**.
  - » The minutes reading increments by one each time you press the button.
- Either press and hold down button **1** or wait without pressing any button.

» The clock is now set and the time appears on the display.

## Odometer and tripmeters

### Selecting readings

- Switch on the ignition. with OE On-board computer:

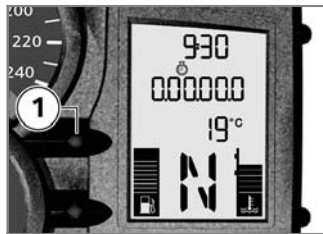

- If necessary, use button **1** to switch from the stopwatch to the odometer.◀



- Press button 2.



The display starts with the current value and each time the button is pressed it moves one step through the following sequence:

- Total distance covered

- Tripmeter 1 (Trip I)
- Tripmeter 2 (Trip II)
- Tyre pressures (OE)
- Warnings, if applicable

### Resetting tripmeter

- Switch on the ignition.
- Select the desired tripmeter.

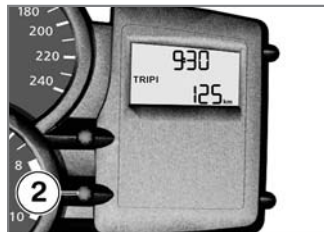

- Press and hold down button 2.
  - » The tripmeter is reset to zero.

## On-board computer<sup>OE</sup>

### Selecting readings

- Switch on the ignition.



- Press button 1.

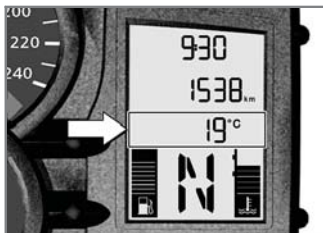

The display starts with the current value and each time the button is pressed it moves one step through the following sequence:

- Ambient temperature
- Average speed
- Average consumption
- Range

## Ambient temperature

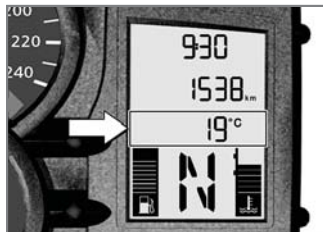

When the motorcycle is at a standstill the heat of the engine can falsify the ambient-temperature reading. If the effect of the engine's heat becomes excessive, -- temporarily appears on the display.

If ambient temperature drops below 3 °C the temperature display flashes to draw your attention to the risk of black ice forming. The display automatically switches from any other mode to the temperature reading when

the temperature drops below this threshold for the first time.

## Average speed

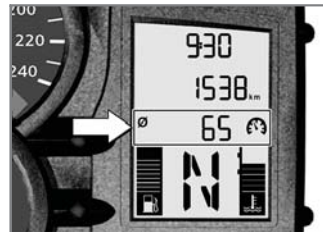

Average speed is calculated on the basis of the time elapsed since the last reset. Times during which the engine was stopped are excluded from the calculation.

## Resetting average speed

- Switch on the ignition.
- Select average speed.



- Press and hold down button **1**.  
» Average speed is reset to zero.

## Average consumption

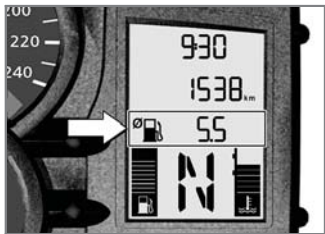

Average consumption is calculated by dividing the distance covered since the last reset by

the corresponding amount of fuel used.

## Resetting average consumption

- Switch on the ignition.
- Select average consumption.



- Press and hold down button **1**.  
» Average consumption is reset to zero.

## Range

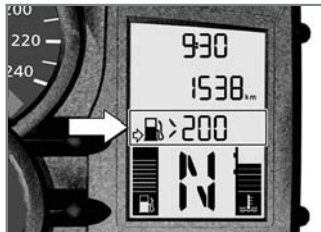

The range readout indicates how far you can ride with the fuel remaining in the tank. The figure is calculated from the level of fuel in the tank and a postulated average consumption, stored in memory, that is not always the same as the average that can be viewed on the display.

The system cannot tell exactly how much fuel is on board when the tank is completely full. Under these circumstances the display shows a minimum-range figure accompanied by a > symbol. A more accurate figure for range is

shown as soon as the fuel level can be measured exactly.

When the motorcycle is propped on its side stand the slight angle of inclination means that the sensor cannot register the fuel level correctly. This is the reason why the range is calculated only when the motorcycle is on the move.

When refuelling after running on reserve, make sure that you top up the tank to a level above reserve, as otherwise the sensor will not be able to register the new level. If the sensor cannot register the new level neither the fuel-level reading nor the range readout can be updated.

 The calculated range is only an approximate reading. Consequently, BMW Motorrad recommends that you should not try to use the full range before refuelling. ◀

## Stopwatch

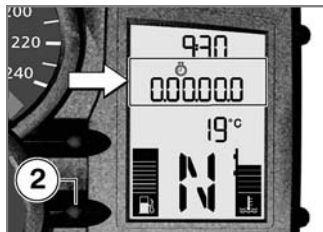

You can switch from the odometer reading to a stopwatch. The readout is in hours, minutes, seconds and tenths of a second, with dots as separators.

If you want to use the stopwatch as a lap timer, you can operate it by means of the INFO button on the handlebar fitting instead of using button **2**. If you set the controls so that the stopwatch is operated by means of the INFO button, you must use button **2** to operate the on-board computer. The stopwatch continues to time in the background if you switch

back temporarily to the odometer reading. Similarly, the stopwatch continues timing if you temporarily switch off the ignition.

## Operating stopwatch



- If necessary, use button **1** to switch from the odometer to the stopwatch.



- Press button **2** while the stopwatch is stopped.
  - » The stopwatch begins timing in tenths of a second from the time originally shown.
- Press button **2** while the stopwatch is running.
  - » The stopwatch shows the stopped time.
- Press and hold down button **2**.
  - » The stopwatch is reset and shows 0.00.00.0.

## Using stopwatch as Lap-Timer

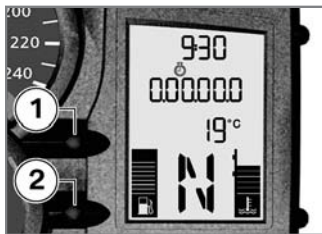

- Press button **1** and button **2** at the same time and hold them down until the reading changes.
  - » FLASH (redline warning) appears, along with ON or OFF.
- Press button **2**.
  - » LAP (Lap-Timer) appears, along with ON or OFF.
- Repeatedly press button **1** until the reading shows the mode you want.

- » ON: Stopwatch operated by means of the INFO button on the handlebar fitting.
- » OFF: Stopwatch operated by means of button **2** in the instrument cluster.
- To confirm the setting, press button **1** and button **2** at the same time and hold them down until the reading changes.
  - » The settings are accepted and the display returns to its most recent reading.
  - » The most recent setting is retained if you do not confirm the new settings.

## Redline warning



The redline warning indicates that engine revolutions have reached the rev. counter's red segment. The anti-theft alarm telltale light **1** flashes red to indicate that the engine is redlining.

The signal remains active until you shift up or reduce engine speed. You can activate or deactivate the redline warning.

## Activating redline warning

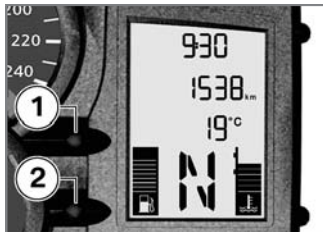

- Press button **1** and button **2** at the same time and hold them down until the reading changes.
  - » FLASH (telltale light shows) appears, along with ON or OFF.
- Repeatedly press button **1** until the reading shows the mode you want.
  - » ON: Redline warning activated.
  - » OFF: Redline warning deactivated.
- To confirm the setting, press button **1** and button **2** at

the same time and hold them down until the reading changes.

- » The settings are accepted and the display returns to its most recent reading.
- » The most recent setting is retained if you do not confirm the new settings.

## Tyre pressure monitoring RDC<sup>OE</sup>

### Selecting RDC readings

- Switch on the ignition.





- Repeatedly press button **2** until the tyre-pressure readings appear on the display.

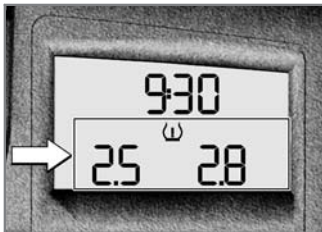

The tyre-pressure readings alternate with the odometer reading. The front tyre pressure is on the left; the reading on the

right is the rear tyre pressure. --- appears directly after the ignition is switched on, because the sensors do not transmit tyre pressures until the motorcycle accelerates to 30 km/h.



Indicates a reading for tyre pressure.

## Lights

### Side light

The side lights switch on automatically when the ignition is switched on.

▶ The side lights place a strain on the battery.

Do not switch the ignition on for longer than absolutely necessary. ◀

### Low-beam headlight

The low-beam headlight switches on automatically when you start the engine.

▶ When the engine is not running you can switch on the lights by switching on the ignition and either switching on the high-beam headlight or operating the headlight flasher. ◀

## High-beam headlight



- Press the top section of full-beam headlight switch **1**.
  - » High-beam headlight switched on.
- Move full-beam headlight switch **1** to the centre position.
  - » High-beam headlight switched off.

- Press the bottom section of full-beam headlight switch **1**.
- » The high-beam headlight is switched on until you release the button (headlight flasher).

## Switching on parking lights

- Switch off the ignition.



- Immediately after switching off the ignition, press and hold down button **1** for the left turn indicators.
- » Parking light switches on.

## Switching off parking lights

- Switch the ignition on and then off again.
- » Parking lights switched off.

## Turn indicators

### Switching on left flashing turn indicators

- Switch on the ignition.

▶ The turn indicators are cancelled automatically after you have ridden for approximately 10 seconds, or covered a distance of about 200 m.◀



- Press button **1** for the left-hand turn indicators.
- » Left-hand turn indicators switched on.
- » Telltale light for left-hand turn indicators flashes.

### Switching on right flashing turn indicators

- Switch on the ignition.

▶ The turn indicators are cancelled automatically after you have ridden for approximately 10 seconds, or covered a distance of about 200 m.◀



- Press button **2** for the right-hand turn indicators.
  - » Right-hand turn indicators switched on.
  - » Telltale light for right-hand turn indicators flashes.

## Cancelling turn indicators



- Press cancel button **3**.
  - » Flashing turn indicators switched off.
  - » Turn indicator telltale lights are off.

## Hazard warning flashers

### Switching on hazard warning flashers

- Switch on the ignition.

 The hazard warning flashers place a strain on the battery. Do not use the hazard

warning flashers for longer than absolutely necessary. ◀

 If you press a turn-indicator or button with the ignition switched on, the turn-indicator function is activated instead of the hazard warning flashers, and remains active until you release the button. The hazard warning flashers recommence flashing as soon as the button is released. ◀

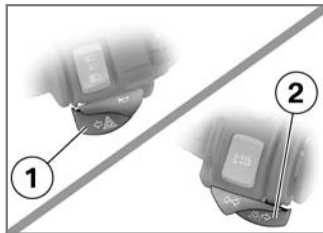

- Simultaneously press button **1** for left turn indicators and button **2** for right turn indicators.

- » The hazard warning flashers are switched on.
- » Left/right turn indicator telltale lights flash.
- Switch off the ignition.
- » The hazard warning flashers continue to operate.
- » Left and right turn indicator telltale lights are off.

### Switching off hazard warning flashers



- Press cancel button **3**.
- » Hazard warning flashers switched off.

### Emergency off switch (kill switch)



- 1** Emergency off switch (kill switch)

**!** Operating the kill switch when riding can cause the rear wheel to lock and thus cause a fall.  
Do not operate the kill switch when riding.◀

The emergency off switch is a kill switch for switching off the engine quickly and easily.

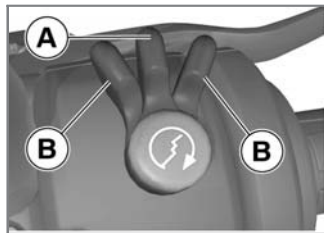

- A** Normal operating position (run)
- B** Engine switched off.

▶ You cannot start the engine unless the kill switch is in the run position.◀

## Grip heating<sup>OE</sup>



1 Grip-heating switch

The handlebar grips have two-stage heating. Grip heating can be activated only when the engine is running.

▶ The increase in power consumption caused by the grip heating can drain the battery if you are riding at low engine speeds. If the charge level is low, grip heating is switched off to ensure the battery's starting capability.◀

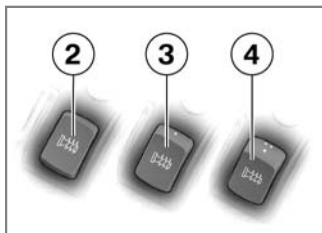

- 2 Heating off.
- 3 50 % heat output (one dot visible)
- 4 100 % heat output (three dots visible)

## Clutch

### Adjusting clutch lever

⚠ If the position of the clutch fluid reservoir is changed, air can enter the clutch system. Do not twist the handlebar fitting or the handlebars.◀

⚠ Attempting to adjust the clutch lever while riding the motorcycle can lead to accidents. Do not attempt to adjust the clutch lever unless the motorcycle is at a standstill.◀

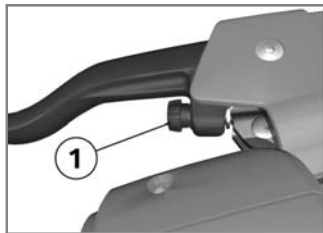

- Turn adjusting screw 1 clockwise.

▶ The adjusting screw is indexed and is easier to turn if you push the clutch lever forward.◀

» Span between handlebar grip and clutch lever increases.

- Turn adjusting screw **1** counter-clockwise.
- » Span between handlebar grip and clutch lever decreases.

## Brakes

### Adjusting handbrake lever

 Changing the position of the brake-fluid reservoir can allow air to penetrate the brake system.

Do not twist the handlebar fitting or the handlebars. ◀

 Attempting to adjust the brake lever while riding the motorcycle can lead to accidents. Do not attempt to adjust the brake lever unless the motorcycle is at a standstill. ◀

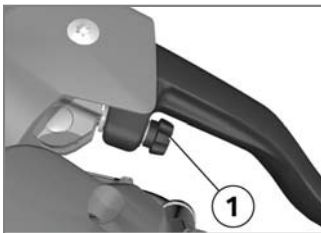

- Turn adjusting screw **1** clockwise.

 The adjusting screw is indexed and is easier to turn if you push the handbrake lever forward. ◀

- » Span between handlebar grip and handbrake lever increases.
- Turn adjusting screw **1** counter-clockwise.
- » Span between handlebar grip and handbrake lever decreases.

## Mirrors

### Adjusting mirrors

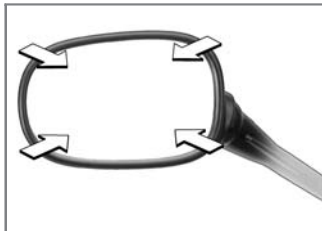

- Turn the mirror to the correct position.

## Spring preload

### Spring preload

It is essential to set spring preload of the rear suspension to suit the load carried by the motorcycle. Increase spring preload when the motorcycle is heavily loaded and reduce spring preload accordingly when the motorcycle is lightly loaded.

## Adjusting spring preload for rear wheel

- Remove the seat (➔ 56)



- Remove on-board toolkit **1**.



 Your motorcycle's handling will suffer if you do not match the spring-preload and damping-characteristic settings. Adjust the damping characteristic to suit spring preload. ◀

- If you want to increase spring preload, use the tool from the on-board toolkit to turn knob **2** clockwise.
- If you want to reduce spring preload, use the tool from the on-board toolkit to turn knob **2** counter-clockwise.



Basic setting of spring preload, rear

- Turn adjusting screw as far as it will go counter-clockwise, then back it off 12 clicks. (Full load of fuel, with rider 85 kg)

with OE Lowered suspension:

- Turn adjusting screw as far as it will go counter-clockwise, then back it off 4 clicks. (Full load of fuel, with rider 85 kg) ◁



- Stow on-board toolkit **1**.

- Install the seat (➔ 56)

## Damping

### Damping

Damping must be adapted to suit spring preload. An increase in spring preload requires firmer damping, a reduction in spring preload requires softer damping.

### Adjusting damping for rear wheel

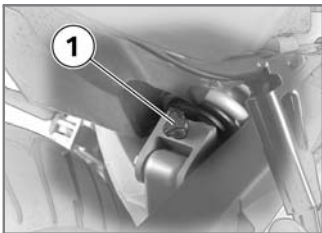

- You adjust the damping characteristic by turning adjusting screw **1**.

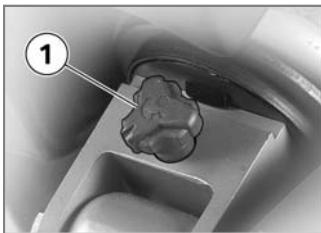

- If you want to increase damping, turn adjusting screw **1** clockwise.
- If you want to reduce damping, turn adjusting screw **1** counter-clockwise.



Basic setting of rear-suspension damping characteristic

- Turn adjusting screw as far as it will go clockwise, then back it off 1 1/2 turns. (Full load of fuel, with rider 85 kg)

## Tyres

### Checking tyre pressure

- Make sure the ground is level and firm and place the motorcycle on its stand.



Incorrect tyre pressures impair the motorcycle's handling characteristics and increase the rate of tyre wear.

Always check that the tyre pressures are correct.◀



At high road speeds, tyre valves have a tendency to open as a result of centrifugal force.

Fit metal valve caps with rubber seals and screw them on firmly to prevent sudden deflation.◀

- Check tyre pressures against the data below.



Tyre pressure, front

- 2.5 bar (one-up, tyre cold)





Tyre pressure, front

– 2.5 bar (two-up and/or with luggage, tyre cold)



Tyre pressure, rear

– 2.8 bar (one-up, tyre cold)

– 2.8 bar (two-up and/or with luggage, tyre cold)

If tyre pressure is too low:

- Correct tyre pressure.

## Headlight

### Adjusting headlight for driving on left/driving on right

If the motorcycle is ridden in a country where the opposite rule of the road applies, its asymmetric low-beam headlight will tend to dazzle oncoming traffic.

Have the headlight set accordingly by a specialist workshop, preferably an authorised BMW Motorrad dealer.



Commercially available adhesive tape will damage the plastic lens of the light.

Consult a specialist workshop, preferably an authorised BMW Motorrad dealer, in order to avoid damaging the plastic lens of the light. ◀

### Headlight beam throw and spring preload

Headlight beam throw is generally kept constant when spring preload is adjusted to suit load. Spring preload adjustment might not suffice only if the motorcycle is very heavily loaded. Under these circumstances, headlight beam throw has to be adjusted to suit the weight carried by the motorcycle.



Consult a specialist workshop, preferably an authorised BMW Motorrad dealer, if you are unsure whether the headlight basic setting is correct. ◀

### Adjusting headlight beam throw

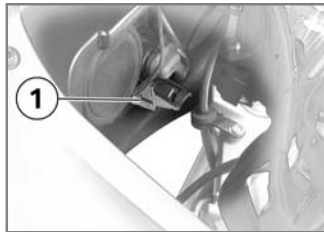

- 1 Headlight beam-throw adjustment

Spring preload adjustment might not suffice if the motorcycle is very heavily loaded. Moving the pivot lever adjusts headlight

beam throw so as not to dazzle oncoming traffic.

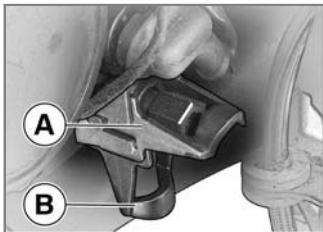

- A** Neutral position  
**B** Position for heavy load

## Seat

### Removing seat

- Make sure the ground is level and firm and place the motorcycle on its stand.

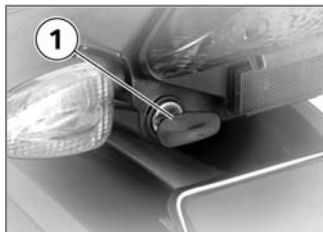

- Use the ignition key to turn seat lock **1** counter-clockwise and hold it in this position.

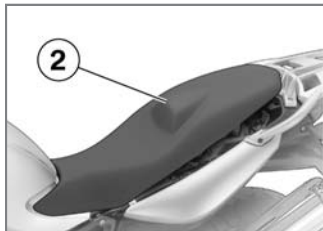

- Lift seat **2** at the rear and release the key.
- Remove the seat.

- Place the seat, upholstered side down, on a clean surface.

### Installing seat

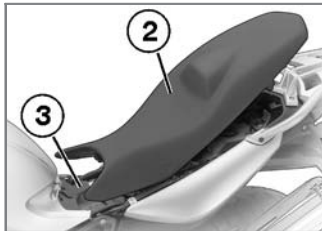

- Push seat **2** forward into holder **3**.
- Firmly press down on the seat at the rear.  
 » The seat engages with an audible click.

## Helmet holder

### Securing helmet to motorcycle

- Remove the seat (➡ 56)

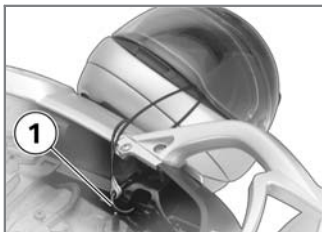

- Use the wire rope available as an optional extra to secure the helmet to helmet holder **1**.



 The helmet catch can scratch the panelling. Make sure the lock is out of the

way when you hook the helmet into position.◀

- Pass the steel cable through the helmet and hook it onto bracket **1**.
- Install the seat (➡ 56)



## **Riding**

Safety instructions .....	60
Checklist.....	62
Starting .....	62
Running in .....	64
Brakes .....	65
Parking your motorcycle .....	67
Refuelling .....	68

## Safety instructions

### Rider's equipment

Do not ride without the correct clothing. Always wear:

- Helmet
- Motorcycling jacket and trousers
- Gloves
- Boots

This applies even to short journeys, and to every season of the year. Your authorised BMW Motorrad dealer will be glad to advise you on the correct clothing for every purpose.

### Speed

If you ride at high speed, always bear in mind that various boundary conditions can adversely affect the handling of your motorcycle:

- Settings of the spring-strut and shock-absorber system
- Imbalanced load
- Loose clothing
- Insufficient tyre pressure
- Poor tyre tread
- Etc.

### Correct loading



Overloading and imbalanced loads can adversely affect the motorcycle's handling. Do not exceed the permissible gross weight and be sure to comply with the instructions on loading. ◀

### Alcohol and drugs



Even small amounts of alcohol or drugs will adversely affect your perception and your ability to assess situations and make decisions, and slow down your reflexes. Medication can exacerbate these effects.

Do not ride your motorcycle after consuming alcohol, drugs and/or medication. ◀

### Risk of poisoning

Exhaust fumes contain carbon monoxide, which is colourless and odourless but highly toxic.



Inhaling the exhaust fumes therefore represents a health hazard and can even cause loss of consciousness with fatal consequences.

Do not inhale exhaust fumes. Do not run the engine in an enclosed space. ◀

### High voltage



Touching live parts of the ignition system with the engine running can cause electric shock.

Do not touch parts of the ignition system when the engine is running. ◀

## Catalytic converter

If misfiring causes unburned fuel to enter the catalytic converter, there is a danger of overheating and damage.

For this reason, observe the following points:

- Do not run the fuel tank dry.
- Do not attempt to start or run the engine with a spark-plug cap disconnected.
- Stop the engine immediately if it misfires.
- Use only unleaded fuel.
- Comply with all specified maintenance intervals.

 Unburned fuel will destroy the catalytic converter. Note the points listed for protection of the catalytic converter.◀

## Risk of fire

Temperatures at the exhaust are high.

 Flammable materials (e.g. hay, leaves, grass, clothing and luggage, etc.) could ignite if allowed to come into contact with the hot exhaust pipe. Do not permit flammable materials to come into contact with the hot exhaust system.◀

 Cooling would be inadequate if the engine were allowed to idle for a lengthy period with the motorcycle at a standstill: overheating would result. In extreme cases, the motorcycle could catch fire. Do not allow the engine to idle unnecessarily. Ride away immediately after starting the engine.◀

## Tampering with the control unit of the electronic engine-management system

 Tampering with the engine control unit can damage the motorcycle and cause accidents. Do not tamper with the engine control unit.◀

 Tampering with the engine control unit can result in mechanical loads that the motorcycle's components are not designed to withstand. Damage caused in this way is not covered by the warranty. Do not tamper with the engine control unit.◀

## Checklist

Use the following checklist to check important functions, settings and wear limits before you ride off.

- Brakes
- Brake-fluid levels, front and rear
- Clutch
- Shock absorber setting and spring preload
- Tyre-tread depth and tyre pressures
- Cases correctly installed and luggage secured

At regular intervals:

- Engine oil level (every refuelling stop)
- Brake-pad wear (every third refuelling stop)

## Starting

### Side stand

You cannot start the motorcycle with the side stand extended and a gear engaged. The engine will switch itself off if you start it with the gearbox in neutral and then engage a gear before retracting the side stand.

### Gearbox

You can start the engine when the gearbox is in neutral or if you pull the clutch with a gear engaged. Do not pull the clutch until after you have switched on the ignition, as otherwise the engine will refuse to start. When the gearbox is in neutral, the green neutral telltale light is on and the gear indicator in the multifunction display shows N.

## Starting engine.

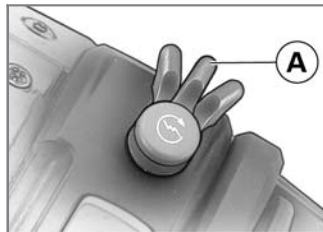

- Kill switch in run position **A**.



Gearbox lubrication is ensured only when the engine is running. Inadequate lubrication can result in damage to the gearbox.

Do not allow the motorcycle to roll for a lengthy period of time or push it a long distance with the engine switched off. ◀

- Switch on the ignition.
- » Pre-ride check is performed. (➡ 63)



with OE BMW Motorrad ABS:

- Switch on the ignition.
- » Pre-ride check is performed. (➡ 63)
- » ABS self-diagnosis is performed. (➡ 64)◀



- Press starter button **1**.

▶ If ambient temperatures are very low, you might find it necessary to open the throttle slightly when starting the engine. At ambient temperatures below 0 °C, disengage the clutch after switching on the ignition.◀

▶ The start attempt is automatically interrupted if battery voltage is too low. Recharge the battery before you start the engine, or use jump leads and a donor battery to start.◀

- » The engine starts.
- » If the engine refuses to start, consult the troubleshooting chart in the section entitled "Technical data". (➡ 122)

## Pre-ride check

The instrument cluster runs a test of the instruments and the telltale and warning lights when the ignition is switched on. This Pre-Ride-Check, as it is known, is aborted as soon you start the engine.

### Phase 1

The rev. counter and speedometer needles both swing to the limit values on their scales.

- » At the same time, the following warning lights and telltale lights are switched on in succession:
  - Telltale light for high-beam headlight and left turn indicator telltale light
  - General warning light, showing yellow, and neutral telltale light
  - Warning light for fuel down to reserve and right turn indicator telltale light
  - Warning light for oil pressure

with OE BMW Motorrad ABS:

- » ABS warning light

### Phase 2

 General warning light changes from yellow to red.

### Phase 3

The rev. counter and speedometer needles both swing back to rest. At the same time, all the warning lights and telltale lights switched on in the initial phase

are switched off in reverse sequence.

If a needle did not move or if a warning light or telltale light did not show as specified above:



Some malfunctions cannot be indicated if one of the warning lights fails to show.

Make sure that all the warning and telltale lights come on in the pre-ride check. ◀

- Have the fault rectified as quickly as possible by a specialist workshop, preferably an authorised BMW Motorrad dealer.

## ABS self-diagnosis<sup>OE</sup>

BMW Motorrad ABS performs self-diagnosis to ensure its operability. Self-diagnosis is performed automatically when you switch on the ignition. The motorcycle has to move forward a

few metres for the wheel sensors to be tested.

### Phase 1

- » Test of the diagnosis-compatible system components with the motorcycle at a standstill.



ABS warning light flashes.



Possible national variant of the ABS warning light.

### Phase 2

- » Test of the wheel sensors as the motorcycle pulls away from rest.



ABS warning light flashes.



Possible national variant of the ABS warning light.

### ABS self-diagnosis completed

- » The ABS warning light goes out.

If an indicator showing an ABS fault appears when ABS self-diagnosis completes:

- You can continue to ride. Bear in mind that the ABS function is not available.
- Have the fault rectified as quickly as possible by a specialist workshop, preferably an authorised BMW Motorrad dealer.

## Running in

### The first 1000 km

- While running in the motorcycle, vary the throttle opening and engine-speed range frequently.
- Try to do most of your riding during this initial period on twisting, fairly hilly roads, avoiding high-speed main roads and highways if possible.

 Exceeding the specified engine speeds while running in will lead to increased engine wear.

Keep to the specified engine speeds for running in. ◀

- Do not exceed the rpm limits recommended for running in.



Running-in speed

– <math><5000 \text{ min}^{-1}</math>

- No full-load acceleration.
- Avoid low engine speeds at full load.
- Do not omit the first inspection after 500 - 1200 km.

## Brake pads

New brake pads must "bed down" and therefore do not achieve their optimum friction levels during the first 500 km. You can compensate for this initial reduction in braking

efficiency by exerting greater pressure on the levers.

 New brake pads can extend stopping distance by a significant margin.

Apply the brakes in good time. ◀

## Tyres

New tyres have a smooth surface. This must be roughened by riding in a restrained manner at various heel angles until the tyres are run in. This running in procedure is essential if the tyres are to achieve maximum grip.

 Tyres do not have their full grip when new and there is a risk of accidents at extreme angles of heel.

Avoid extreme angles of heel. ◀

## Brakes

### How can stopping distance be minimised? <sup>OE</sup>

Each time the brakes are applied, a load distribution shift takes place with the load shifting forward from the rear to the front wheel. The sharper the motorcycle decelerates, the more load is shifted to the front wheel. The higher the wheel load, the more braking force can be transmitted without the wheel locking.

To optimise stopping distance, apply the front brakes rapidly and keep on increasing the force you apply to the brake lever. This makes the best possible use of the dynamic increase in load at the front wheel. Remember to pull the clutch at the same time. In the "panic braking situations" that are trained so frequently braking force is applied as rapidly as possible and with

the rider's full force applied to the brake levers; under these circumstances the dynamic shift in load distribution cannot keep pace with the increase in deceleration and the tyres cannot transmit the full braking force to the surface of the road. ABS has to intervene to keep the front wheel from locking; this increases stopping distance.

### **Descending mountain passes**

 There is a danger of the brakes fading if you use only the rear brakes when descending mountain passes. Under extreme conditions, the brakes could overheat and suffer severe damage.

Use both front and rear brakes, and make use of the engine's braking effect as well.◀

### **Wet brakes**

 After the motorcycle has been washed, ridden through water or ridden in the rain, the brake discs and pads might be wet and the brakes might not take effect immediately.

Apply the brakes in good time until the brakes have dried out.◀

### **Salt on brakes**

 The brakes may fail to take effect immediately if the motorcycle was ridden on salt-covered roads and the brakes were not applied for some time. Apply the brakes in good time until the salt layer on the brake discs and brake pads has been removed.◀

### **Oil or grease on brakes**

 Oil and grease on the brake discs and pads considerably diminish braking efficiency. Especially after repair and maintenance work, make sure that the brake discs and brake pads are free of oil and grease.◀

### **Dirt or mud on brakes**

 When riding on loose surfaces or muddy roads, the brakes may fail to take effect immediately because of dirt or moisture on the discs or brake pads.

Apply the brakes in good time until the brakes have been cleaned.◀

 The brake pads will wear more rapidly if you ride frequently on unsurfaced tracks or poor roads.

Check the thickness of the brake

pads more frequently and replace the brake pads in good time.◀

## Parking your motorcycle

### Placing motorcycle on side stand

 If the ground is soft or uneven, there is no guarantee that the motorcycle will rest firmly on the stand.

Always check that the ground under the stand is level and firm.◀

- Switch off the engine.
- Pull the handbrake lever.
- Hold the motorcycle upright and balanced.
- Use your left foot to extend the side stand fully.

 The side stand is designed to support only the weight of the motorcycle.

Do not lean or sit on the

motorcycle with the side stand extended.◀

- Slowly lean the motorcycle to the side until its weight is taken by the stand and dismount to the left.

 If the motorcycle is on the side stand, the surface of the ground will determine whether it is better to turn the handlebars to the left or right. However, the motorcycle is more stable on a level surface with the handlebars turned to the left than with the handlebars turned to the right.

On level ground, always turn the handlebars to the left to set the steering lock.◀

- Turn the handlebars to full left or right lock.
- Check that the motorcycle is standing firmly.

 On a gradient, the motorcycle should always face uphill; select 1st gear.◀

- Lock the steering lock.

### Removing motorcycle from side stand

- Unlock the steering lock.
- From the left, grip the handlebars with both hands.
- Pull the handbrake lever.
- Swing your right leg over the seat and lift the motorcycle to the upright position.
- Hold the motorcycle upright and balanced.

 An extended side stand can catch on the ground when the motorcycle is moving and lead to a fall.

Retract the side stand before moving the motorcycle.◀

- Sit on the motorcycle and use your left foot to retract the side stand.

## Placing motorcycle on centre stand<sup>OE</sup>

 If the ground is soft or uneven, there is no guarantee that the motorcycle will rest firmly on the stand. Always check that the ground under the stand is level and firm.◀

- Switch off the engine.
- Dismount and keep your left hand on the left handlebar grip.
- With your right hand, grip the rear grab handle or the rear frame.
- Place your right foot on the pin of the centre stand, and press the stand down until its curved feet touch the ground.
- Place your full body weight on the centre stand and at the same time pull the motorcycle to the rear.



Excessive movements could cause the centre stand to retract, and the motorcycle would topple in consequence.

Do not lean or sit on the motorcycle with the centre stand extended.◀

- Check that the motorcycle is standing firmly.
- Lock the steering lock.

## Removing motorcycle from centre stand<sup>OE</sup>

- Unlock the steering lock.
- Place your left hand on the left handlebar grip.
- With your right hand, grip the rear grab handle or the rear frame.
- Push the motorcycle forward off the centre stand.
- Check that the centre stand has fully retracted.

## Refuelling



Fuel is highly flammable. A naked flame close to the fuel tank can cause a fire or explosion.

Do not smoke. Never bring a naked flame near the fuel tank.◀



Fuel expands when hot. Fuel escaping from an overfilled tank could make its way onto the rear tyre. This could cause a fall.

Do not fill the tank past the bottom edge of the filler neck.◀



Fuel attacks plastics, which become dull or unsightly. Wipe off plastic parts immediately if they come into contact with fuel.◀



Fuel can attack the material of the windscreen and the side slipstream deflectors, which become dull or unsightly.

Wipe off the windscreen and slip-

stream deflectors immediately if they come into contact with fuel. ◀

 Leaded fuel will destroy the catalytic converter.



Use only unleaded fuel. ◀

- Make sure the ground is level and firm and place the motorcycle on its stand.



- Open the protective cap.
- Open the fuel tank cap with the ignition key by turning it counter-clockwise.
- Refuel with fuel of the grade stated below; do not fill the

tank past the bottom edge of the filler neck.

	Recommended fuel grade
	– 95 ROZ/RON (Super unleaded) with OE Regular unleaded (RON 91):
	– 91 ROZ/RON (Regular unleaded (fuel grade, usable with power- and consumption-related restrictions)) ◀
	Usable fuel capacity
	– 16 l
	Reserve fuel
	– $\geq 4$ l

- Press the fuel tank cap down firmly to close.

- Remove the key and close the protective cap.





## Engineering details

Brake system with BMW Motorrad ABS <sup>OE</sup> .....	72
Tyre pressure monitoring RDC <sup>OE</sup> .....	74

## Brake system with BMW Motorrad ABS<sup>OE</sup>

### How does ABS work?

The amount of braking force that can be transferred to the road depends on factors that include the coefficient of friction of the road surface. Loose stones, ice and snow or a wet road all have much lower coefficients of friction than a clean, dry asphalt surface. The lower the coefficient of friction, the longer the braking distance.

If the rider increases braking pressure to the extent that braking force exceeds the maximum transferrable limit, the wheels start to lock and the motorcycle loses its directional stability; a fall is imminent. Before this situation can occur, ABS intervenes and adapts braking pressure to the maximum transferrable braking force, so the wheels continue

to turn and directional stability is maintained irrespective of the condition of the road surface.

### What are the effects of surface irregularities?

Humps and surface irregularities can cause the wheels to lose contact temporarily with the road surface; if this happens the braking force that can be transmitted to the road can drop to zero. If the brakes are applied under these circumstances the ABS has to reduce braking force to ensure that directional stability is maintained when the wheels regain contact with the road surface. At this instant the BMW Motorrad ABS must assume an extremely low coefficient of friction, so that the wheels will continue to rotate under all imaginable circumstances, because this is the precondition for ensuring directional stability. As soon as

is registers the actual circumstances, the system reacts instantly and adjusts braking force accordingly to achieve optimum braking.

### Rear wheel lift

Even under severe braking, a high level of tyre grip can mean that the front wheel does not lock up until very late, if at all. Consequently, ABS does not intervene until very late, if at all. Under these circumstances the rear wheel can lift off the ground, and the outcome can be a high-siding situation in which the motorcycle can flip over.



Severe braking can cause the rear wheel to lift off the ground.

When you brake, bear in mind that ABS control cannot be relied on in all circumstances to prevent the rear wheel from lifting clear of the ground. ◀

## What is the design baseline for BMW Motorrad ABS?

Within the limits imposed by physics, BMW Motorrad ABS ensures directional stability on any surface. The system is not optimised for special requirements that apply under extreme competitive situations off-road or on the track.

### Special situations

The speeds of the front and rear wheels are compared as one means of detecting a wheel's incipient tendency to lock. If the system registers implausible values for a lengthy period the ABS function is deactivated for safety reasons and an ABS fault message is issued. Self-diagnosis has to complete before fault messages can be issued.

In addition to problems with the BMW Motorrad ABS, exceptional

riding conditions can lead to a fault message being issued.

### Exceptional riding conditions:

- Riding for a lengthy period with the front wheel lifted off the ground (wheelie).
- Rear wheel rotating with the motorcycle held stationary by applying the front brake (burn-out).
- Heating up with the motorcycle on the centre stand or an auxiliary stand, engine idling or with a gear engaged.
- Rear wheel locked for a lengthy period, for example while descending off-road.

If a fault message is issued on account of exceptional riding conditions as outlined above, you can reactivate the ABS function by switching the ignition off and on again.

## What significance devolves on regular maintenance?



Invariably, a technical system cannot perform beyond the abilities dictated by its level of maintenance.

In order to ensure that the BMW Motorrad ABS is always maintained in optimum condition, it is essential for you to comply strictly with the specified inspection intervals. ◀

### Reserves for safety

The potentially shorter braking distances which BMW Motorrad ABS permits must not be used as an excuse for careless riding. ABS is primarily a means of ensuring a safety margin in genuine emergencies.

Take care when cornering. When you apply the brakes on a corner, the motorcycle's weight and

momentum take over and even BMW Motorrad ABS is unable to counteract their effects.

## Tyre pressure monitoring RDC<sup>OE</sup>

### Function

A sensor integrated into each tyre measures the air temperature and the air pressure inside the tyre and transmits this information to the control unit. Each sensor has a centrifugal-force tripswitch that does not enable transmission of the measured values until the motorcycle has accelerated to about 30 km/h. The display shows -- for each tyre until the tyre-pressure signal is received for the first time. The sensors continue to transmit the measured-value signals for approximately 15 minutes after the motorcycle comes to a stop.

The control unit can administer four sensors, so two different sets of wheels with RDC sensors can be alternated on the motorcycle. An error message is issued if wheels without sensors are fitted to a motorcycle equipped with an RDC control unit.

### Temperature compensation

The tyre-pressure readings shown by the multifunction display are temperature-compensated; the reference tyre temperature for these readings is always 20 °C. The air lines available to the public in petrol stations and motorway service areas almost invariably show temperature-dependent tyre pressures, so in most instances these gauge readings will not tally with the readings shown by the multifunction display.

### Tyre-pressure ranges

The RDC control unit differentiates between three air-pressure ranges, all of which are parameterised for the motorcycle:

- Air pressure within permitted tolerance.
- Air pressure close to limit of permitted tolerance.
- Air pressure outside permitted tolerance.

## Accessories

General instructions.....	76
Power socket .....	76
Luggage .....	77
Case <sup>OA</sup> .....	78
Topcase <sup>OA</sup> .....	81

## General instructions

BMW Motorrad recommends the use of parts and accessories for your motorcycle that are approved by BMW for this purpose. Genuine BMW parts and accessories and other products which BMW has approved can be obtained from your authorised BMW Motorrad dealer, together with expert advice on their installation and use.

These parts and products have been tested by BMW for safety, function and suitability. BMW accepts product liability for them. Conversely, BMW is unable to accept any liability whatsoever for parts and accessories which it has not approved.



BMW Motorrad cannot assess each non-BMW product to determine whether it can be used on or in connection with BMW motorcycles

without constituting a safety hazard. Country-specific official authorisation does not suffice as assurance. Tests conducted by these instances cannot make provision for all operating conditions experienced by BMW motorcycles and, consequently, they are not sufficient in some circumstances.

Use only parts and accessories approved by BMW for your motorcycle. ◀

Whenever you are planning modifications, comply with all the legal requirements. Make sure that the motorcycle does not infringe national road-vehicle construction and use regulations.

## Power socket Ratings

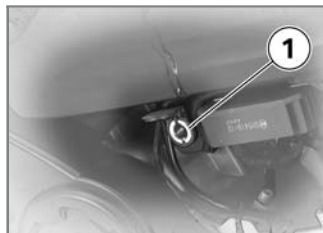

The supply to socket **1** is cut off automatically if battery voltage is low or the load exceeds the maximum rating.

## Operating electrical accessories

You can start using electrical accessories only when the ignition is switched on. The accessory remains operational if the ignition is subsequently switched off. In order to ensure that the drain on the on-board power supply sys-

tem is minimised, the supply to the power socket is cut off approximately 15 minutes after the ignition is switched off, and it is also temporarily interrupted during the start procedure.

## Cable routing

The cables from the power socket to the auxiliary device must be routed in such a way that they:

- Do not impede the rider
- Do not restrict or obstruct the steering angle and handling characteristics
- Cannot be trapped



Incorrectly routed cables can impede the rider. Route the cables as described above.◀

## Luggage

### Correct loading



Overloading and imbalanced loads can adversely affect the motorcycle's handling. Do not exceed the permissible gross weight and be sure to comply with the instructions on loading.◀

- Set spring preload, damping characteristic and tyre pressures to suit total weight.
- Ensure that the case volumes on the left and right are equal.
- Make sure that the weight is uniformly distributed between right and left.
- Pack heavy items at the bottom and toward the inboard side.
- Note the maximum permissible payload of the cases and the speed limit for riding with cases on the motorcycle.



Payload of cases

with OA Case:

–  $\leq 8 \text{ kg}$ ◀



Maximum permissible speed for riding with cases fitted to the motorcycle

with OA Case:

–  $\leq 180 \text{ km/h}$ ◀

- Note the maximum permissible payload of the topcase and the speed limit for riding with a topcase on the motorcycle.



Payload of topcase

with OA Topcase:

–  $\leq 5 \text{ kg}$ ◀

 Maximum permissible speed for riding with topcase fitted to the motorcycle

with OA Topcase:

– ≤180 km/h◁

- Note the maximum permissible payload of the tank rucksack.

 Payload of tank rucksack

with OA Tank rucksack:

– ≤5 kg◁

- Note the maximum permissible payload of the tank bag.

 Payload of tankbag

with OA Tankbag:

– ≤5 kg◁

- Note the maximum permissible payload of the luggage carrier.

 Payload of luggage carrier

– ≤10 kg

## Lashing luggage

- Remove the seat (➔ 56)

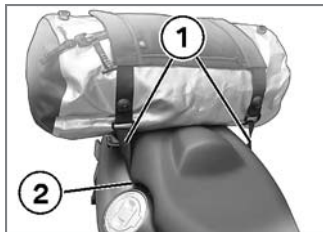

- Pull luggage strap **1** through underneath the seat in the vicinity **2** of the filler neck of the fuel tank. Make sure that the strap is in front of the ribs on the underside of the seat.
- Install the seat (➔ 56)
- Position the luggage strap appropriately to hold the item of

luggage and down to the luggage rack.

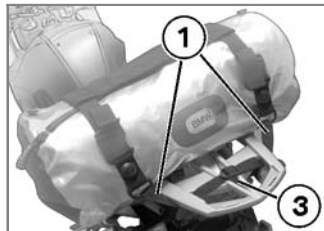

- Pass luggage strap **1** through luggage rack **3** and pull it tight.
- Check that the luggage is secure.

## Case<sup>OA</sup>

### Release levers

Each case has two levers, one on each side of the lock. The grey lever marked OPEN is for opening and closing the case.



The black lever marked RELEASE is for removing and attaching the case.

## Opening cases

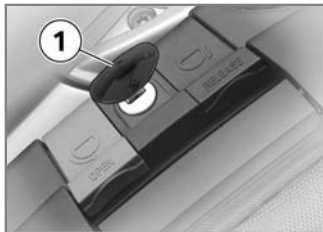

- Turn lock barrel **1** to the OPEN position.

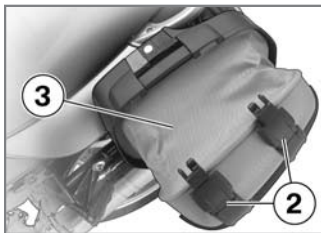

- Pull the grey release lever (OPEN) up.
  - » Lock straps **2** open.
- Pull the grey release lever (OPEN) up again.
- Pull case lid **3** out of the retainer.
  - » Case fully opened.

## Closing cases

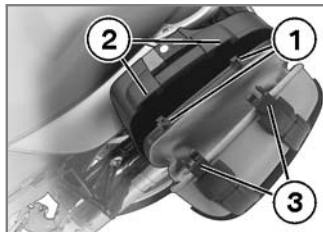

- Press catches **1** of the case lid into retainers **2**.
  - » The catches engage with an audible click.
- Press catches **3** on the lock straps into retainers **2**.
  - » The catches engage with an audible click.

## Adjusting case volume

- Close the case lid.



- Push lock straps **2** out and pull them up.
- » This expands the case to maximum volume.



- Close lock straps **2**.

- Press the case lid against the case body.
- » The case volume adapts to the contents.

### Removing cases

- Turn the lock barrel in the RELEASE direction.
- Pull the black release lever (RELEASE) up.

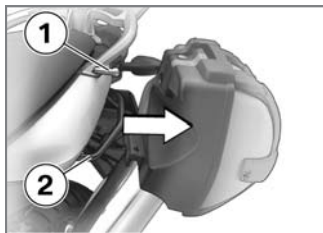

- Pull the case out of top holder **1**.
- Lift the case out of bottom holder **2**.

### Installing case

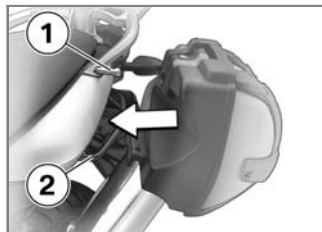

- Hook the case into bottom holder **2**.
- Pull the black release lever (RELEASE) up.
- Press the case into top holder **1**.
- Push the black release lever (RELEASE) down.
- » The case is locked into place.
- Lock the case.
- Check that the case is secure.

## Secure attachment

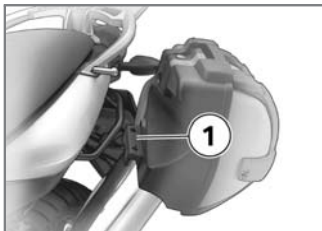

If a case wobbles or is difficult to fit, it has to be adapted to the gap between the top and bottom holders. Bottom holder **1** on the case can be moved up or down for this purpose.

## Adapting case

- Open the case.

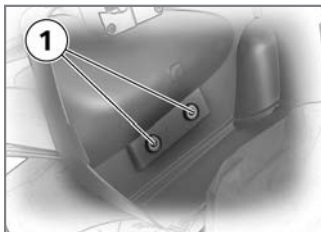

- Remove screws **1**.
- Adjust the height of the holder.
- Tighten screws **1**.

## Topcase<sup>OA</sup> Opening topcase

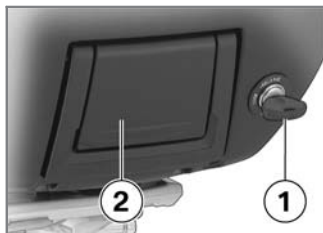

- Turn lock barrel **1** to the OPEN position.
- Press the lock barrel.  
» Locking lever **2** pops out.



- Fully open locking lever **2**.
- Open the lid.

### Closing topcase



- Fully open locking lever **2**.
- Snap the lid of the compartment closed and push it down.

Check that nothing is trapped between the lid and the case.

- Push locking lever **2** down.
- » The lever engages with an audible click.



- Turn lock barrel **1** to the LOCK position.
- » The topcase is locked.

### Removing topcase



- Turn the lock barrel in the RE-LEASE direction.
- » Handle **3** pops out.
- Pull handle **3** up as far as it will go.
- Lift the topcase at the rear and pull it off the carrier plate.

## Installing topcase

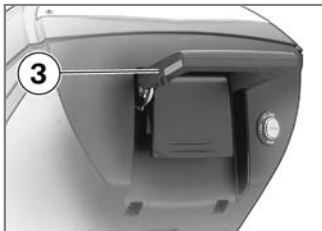

- Pull handle **3** up as far as it will go.

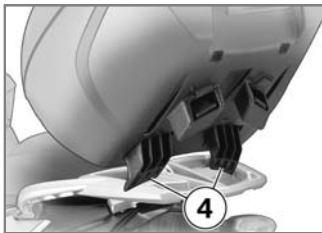

- Hook the topcase into position on the carrier. Make sure that

hooks **4** are securely seated in the corresponding keepers.



- Push handle **3** fully down.  
» The handle engages with an audible click.



## Maintenance

General instructions.....	86
On-board toolkit service kit .....	86
Engine oil .....	87
Brake system, general .....	88
Brake pads .....	89
Brake fluid .....	91
Coolant .....	93
Clutch .....	95
Tyres .....	95
Rims .....	95
Wheels .....	96
Front-wheel stand .....	102
Rear-wheel stand .....	103
Bulbs .....	104
Jump starting.....	110

Battery.....	112
--------------	-----

## General instructions

The "Maintenance" chapter describes straightforward procedures for checking and replacing certain wear parts.

Special tightening torques are listed as applicable. The tightening torques for the threaded fasteners on your motorcycle are listed in the section entitled "Technical data".

You will find information on more extensive maintenance and repair work in the Repair Manual on DVD/CD-ROM (RepROM) for your motorcycle, which is available from your authorised BMW Motorrad dealer.

Some of the work calls for special tools and a thorough knowledge of motorcycles. If you are in doubt consult a specialist workshop, preferably your authorised BMW Motorrad dealer.

## On-board toolkit service kit

Your authorised BMW Motorrad dealer can provide the on-board toolkit service kit that you will need if you are considering undertaking more extensive work. You will find information on undertaking work of this nature in the Repair Manual on the DVD/CD-ROM also obtainable from your authorised BMW Motorrad dealer.

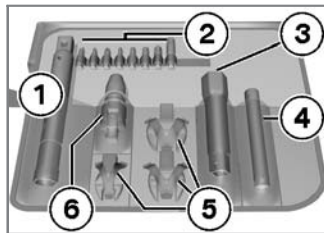

### 1 Extending tool holder

- Adapters to accommodate all tools
- Removing and installing spark plugs

### 2 1/4" bits

- 5x Torx, for example for removing and installing rear wheel
- 2x cross-head bits
- 1x plain screwdriver bit

### 3 3/8" adapter for socket-head screws, w/f 22

- Removing and installing front axle



#### 4 Electric torch

- LED bulb

#### 5 Socket

- 3x open-ended spanner, for example for connecting and disconnecting leads to battery terminals

#### 6 Adapter

- Adapter for 1/4" bits
- 9x12 mm and 3/8" swivel adapters

## Engine oil

### Checking engine oil level



The engine can seize if the oil level is low, and this can lead to accidents.

Always make sure that the oil level is correct.◀



The oil level varies with the temperature of the oil. The higher the temperature, the higher the level of oil in the sump.

Checking the oil level with the engine cold or after no more than a short ride will lead to misinterpretation; this in turn, means that the engine will be operated with the incorrect quantity of oil.

In order to ensure that the engine oil level is read correctly, check the oil level only after a lengthy trip.◀

- Wipe the area around the oil filler neck clean.
- Allow the engine to idle until the fan starts up, then allow it to idle one minute longer.
- Switch off the engine.
- Make sure the engine is at operating temperature and hold the motorcycle upright with OE Centre stand:
- Check that the engine is at operating temperature, make sure the ground is level and firm

and place the motorcycle on its centre stand.◀

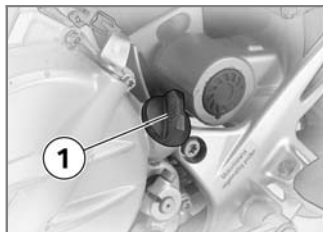

- Remove oil dipstick **1** by turning it counter-clockwise.

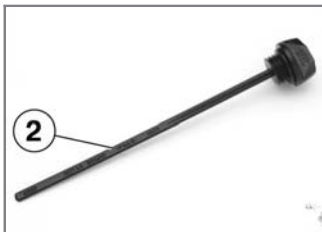

- Wipe the oil off MIN-MAX part of dipstick **2** with a clean, dry cloth.
- Seat the oil dipstick on the oil filler neck, but do not engage the threads.
- Remove the oil dipstick and check the oil level.



Engine oil level

- between MIN and MAX marks on the oil dipstick
- 0.4 l (Difference between MIN and MAX)

If the oil level is below the MIN mark:

- Top up the engine oil (➡ 88)

If the oil level is above the MAX mark:

- Have the oil level corrected by a specialist workshop, preferably an authorised BMW Motorrad dealer.

### Topping up engine oil



Damage to the engine can result if it is operated without enough oil, but the same also applies if the oil level is too high.

Always make sure that the oil level is correct.◀

- Wipe the area around the filler neck clean.
- Remove the oil dipstick.



- Pour engine oil in through filler neck **1** until it reaches the specified level.
- Check the engine oil level (➡ 87)
- Install the oil dipstick.

### Brake system, general Dependability of the brake system

A fully functional brake system is a basic requirement for the road safety of your motorcycle. Do not ride the motorcycle if you have any doubts about the dependability of the brake system.

Under these circumstances have the brake system checked by a specialist workshop, preferably an authorised BMW Motorrad dealer.

 Incorrect working practices endanger the reliability of the brakes.

Have all work on the brake system performed by a specialist workshop, preferably an authorised BMW Motorrad dealer. ◀

## Checking operation of brakes

- Pull the handbrake lever.
  - » The pressure point must be clearly perceptible.
- Press the footbrake lever.
  - » The pressure point must be clearly perceptible.

If pressure points are not clearly perceptible:

- Have the brakes checked by a specialist workshop, preferably

an authorised BMW Motorrad dealer.

## Brake pads

### Checking front brake pad thickness

 Brake pads worn past the minimum permissible brake-pad thickness can cause a reduction in braking efficiency and under certain circumstances they can cause damage to the brake system.

In order to ensure the dependability of the brake system, do not permit the brake pads to wear past the minimum permissible brake-pad thickness. ◀

- Make sure the ground is level and firm and place the motorcycle on its stand.



- Visually inspect the left and right brake pads to ascertain their thickness. Viewing direction: Between wheel and fork tube toward the brake caliper.

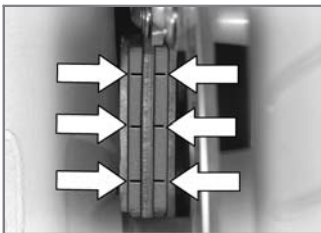

Brake-pad wear limit,  
front

– min 1 mm (Friction pad only,  
without backing plate)

– The wear indicators  
(grooves) must be clearly  
visible.

If the wear indicating marks are no longer clearly visible:

- Have the brake pads replaced by a specialist workshop, preferably an authorised BMW Motorrad dealer.

## Checking rear brake pad thickness



Brake pads worn past the minimum permissible brake-pad thickness can cause a reduction in braking efficiency and under certain circumstances they can cause damage to the brake system.

In order to ensure the dependability of the brake system, do not permit the brake pads to wear past the minimum permissible brake-pad thickness.◀

- Make sure the ground is level and firm and place the motorcycle on its stand.

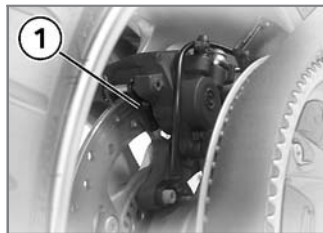

- Visually inspect brake pads **1** from the rear to ascertain their thickness.

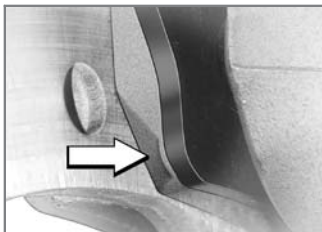

Brake-pad wear limit, rear

- min 1 mm (Friction pad only, without backing plate)
- The wear indicators must be clearly visible.

If the wear indicating mark is no longer visible:

- Have the brake pads replaced by a specialist workshop, preferably an authorised BMW Motorrad dealer.

## Brake fluid

### Checking brake-fluid level, front brakes

**!** A low fluid level in the brake reservoir can allow air to penetrate the brake system. This significantly reduces braking efficiency.

Check the brake-fluid level at regular intervals.◀

- Make sure the ground is level and firm and hold the motorcycle upright.
- with OE Centre stand:
- Make sure the ground is level and firm and place the motorcycle on its centre stand.◀
  - Move the handlebars to the straight-ahead position.



- Check the brake fluid level in front reservoir **1**.

**▷** Wear of the brake pads causes the brake fluid level in the reservoir to sink.◀



Brake fluid level, front

– DOT4 brake fluid

– Do not permit the brake fluid level to drop below the MIN mark.

If the brake fluid level drops below the permitted level:

- Have the defect rectified as quickly as possible by a specialist workshop, preferably an authorised BMW Motorrad dealer.

## Checking brake-fluid level, rear brakes



A low fluid level in the brake reservoir can allow air to penetrate the brake system. This significantly reduces braking efficiency.

Check the brake-fluid level at regular intervals.◀

- Make sure the ground is level and firm and hold the motorcycle upright.
- with OE Centre stand:
- Make sure the ground is level and firm and place the motorcycle on its centre stand.◀

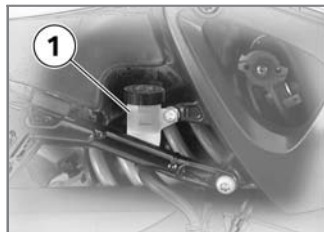

- Check the brake fluid level in rear reservoir **1**.



Wear of the brake pads causes the brake fluid level in the reservoir to sink.◀



 Brake fluid level, rear

- DOT4 brake fluid
- Do not permit the brake fluid level to drop below the MIN mark.

If the brake fluid level drops below the permitted level:

- Have the defect rectified as quickly as possible by a specialist workshop, preferably an authorised BMW Motorrad dealer.

## Coolant

### Checking coolant level

- Make sure the ground is level and firm and place the motorcycle on its stand.

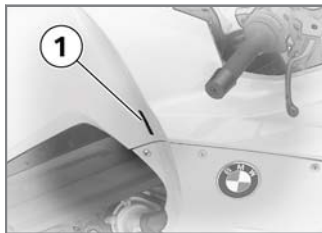

- Read off the coolant level on scale **1** on the coolant reservoir.

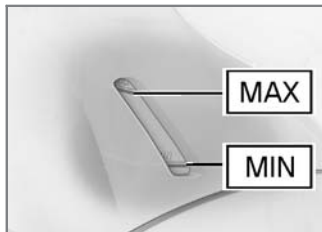

 Coolant level

- between MIN and MAX marks on the expansion tank

If the coolant level is too low:

- Top up the coolant.

### Topping up coolant

- Remove the battery-compartment cover (➔ 113)

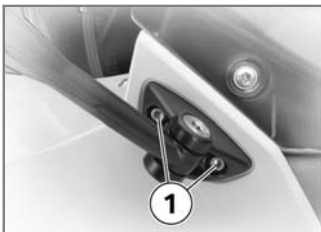

- Remove screws **1** securing the right mirror.
- Remove the mirror.

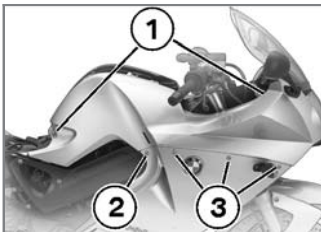

- Remove two screws **1**.
- Remove short screw **2**.
- Remove three screws **3**.

- Lift the side panel up to remove.

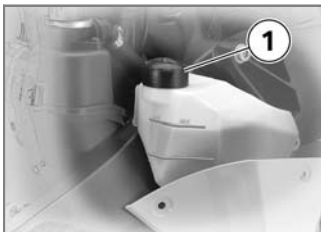

- Turn cap of the coolant filler neck **1** counter-clockwise to open.
- Top up the coolant to the specified level.
- Turn the cap of the coolant filler neck clockwise to close.

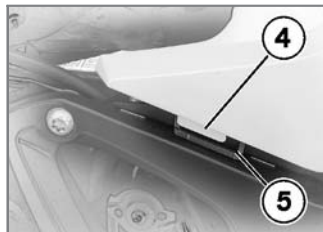

- Slip the side section behind the bottom side panel, making sure that guide **4** of the side section engages mount **5**.

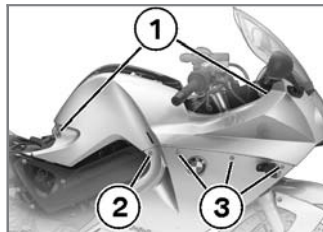

- Install three screws **3**
- Install short screw **2**.



- Install two screws **1**

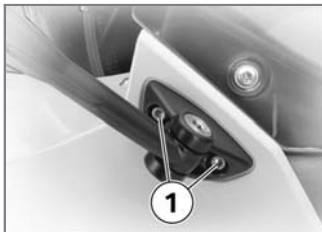

- Hold the mirror in position.
- Install screws **1**.
- Install the battery-compartment cover (➔ 114)

## Clutch

### Checking clutch operation

- Pull the clutch lever.
- » The pressure point must be clearly perceptible.

If the pressure point is not clearly perceptible:

- Have the clutch checked by a specialist workshop, preferably

an authorised BMW Motorrad dealer.

## Tyres

### Checking tyre tread depth



Your motorcycle's handling and grip can be impaired even before the tyres wear to the minimum tyre tread depth permitted by law.

Have the tyres changed in good time before they wear to the minimum permissible tread depth.◀

- Make sure the ground is level and firm and place the motorcycle on its stand.
- Measure the tyre tread depth in the main tread grooves with wear marks.



Tyres have wear indicators integrated into the main tread grooves. The tyre is worn out when the tyre tread has worn down to the level of the marks.

The locations of the marks are indicated on the edge of the tyre, e.g. by the letters TI, TWI or by an arrow.◀

If the tyre tread no longer complies with the minimum legally required tread depth:

- Replace tyre.

## Rims

### Visual inspection

- Make sure the ground is level and firm and place the motorcycle on its stand.
- Visually inspect the rims for defects.
- Have damaged rims checked and, if necessary, replaced by a specialist workshop, preferably an authorised BMW Motorrad dealer.

## Wheels

### Approved wheels and tyres

For each size of tyre BMW Motorrad tests certain makes, and approves those that it certifies as roadworthy. If BMW Motorrad has not approved the wheels and tyres, it cannot assess their suitability or provide any guarantee of road safety.

Use only wheels and tyres approved by BMW Motorrad for your type of motorcycle.

You can obtain detailed information from your authorised BMW Motorrad dealer or on the Internet at [www.bmw-motorrad.com](http://www.bmw-motorrad.com).

### RDC label<sup>OE</sup>

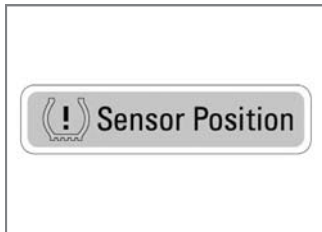

Incorrect tyre-removal procedures can result in damage to the RDC sensors. Be sure to notify the authorised BMW Motorrad dealer or specialist workshop that the wheel is fitted with an RDC sensor. ◀

If the motorcycle is equipped with RDC, each wheel rim bears an adhesive label indicating the position of the RDC sensor. When changing the tyre, take care not to damage the RDC sensor. Be sure to draw the attention of the authorised BMW

Motorrad dealer or specialist workshop to the fact that the wheel is fitted with an RDC sensor.

### Removing front wheel

- Place the motorcycle on an auxiliary stand; BMW Motorrad recommends the BMW Motorrad rear-wheel stand.
- Install the rear-wheel stand (➡ 103) with OE Centre stand:
- Place the motorcycle on its centre stand. ◀

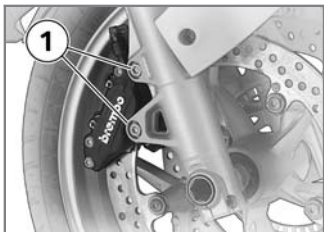

 Once the calipers have been removed, there is a risk of the brake pads being pressed together to the extent that they cannot be slipped back over the brake disc on reassembly.

Do not operate the handbrake lever when the brake calipers have been removed. ◀

- Remove securing screws **1** of the brake calipers on left and right.

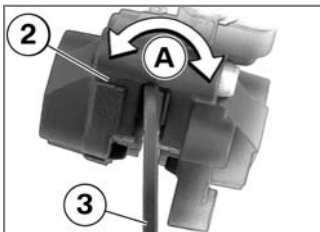

- Force the brake pads slightly apart by rocking brake calipers **2** back and forth **A** against brake discs **3**.
- Mask off the parts of the wheel rim that could be scratched in the process of removing the brake calipers.
- Carefully pull the brake calipers back and out until clear of the brake discs.

with OE BMW Motorrad ABS:

- When removing the left brake caliper, take care not to damage the ABS sensor cable. ◀

- Raise front of motorcycle until the front wheel can turn freely. BMW Motorrad recommends the BMW Motorrad front-wheel stand for lifting the motorcycle.
- Install the front wheel stand (➔ 102)

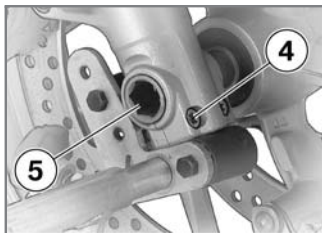

- Remove axle clamping screw **4**.
- Remove quick-release axle **5**, while supporting the wheel.
- Roll the front wheel forward to remove.

with OE BMW Motorrad ABS:

- Do not damage the ABS sensor on the left-hand side when rolling out the wheel.<

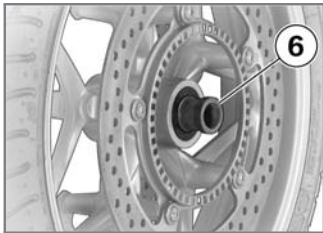

- Remove spacing bushing **6** from the left-hand side of the wheel hub.

### Installing front wheel

**!** Threaded fasteners not tightened to the specified torque can work loose or their threads can suffer damage. Always have the security of the fasteners checked by a specialist

workshop, preferably an authorised BMW Motorrad dealer.<

**!** There is a risk of damaging parts of the front brake, particularly the BMW Motorrad ABS, in the course of the procedure described below.

Take care not to damage the brake system, in particular the ABS sensor with cable and the ABS sensor ring.<

**!** The front wheel must be installed right way round to rotate in the correct direction. Note the direction-of-rotation arrows on the tyre or the wheel rim.<

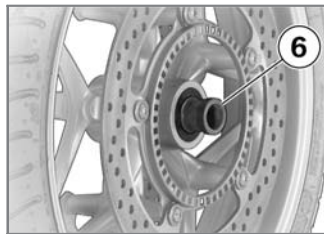

- Slip spacing bushing **6** onto the left-hand side of the wheel hub.
- Roll the front wheel into position between the front forks.

with OE BMW Motorrad ABS:

- Do not damage the ABS sensor on the left-hand side when rolling in the wheel.<

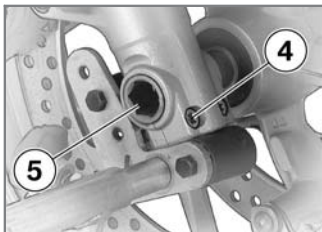

- Raise the front wheel, insert quick-release axle **5** and tighten to specified torque.



Quick-release axle in axle holder

– 50 Nm

- Tighten axle clamping screw **4** to the specified torque.





Clamp of quick-release axle

– 20 Nm

- Remove the front-wheel stand.
- Ease the brake calipers on to the brake discs.

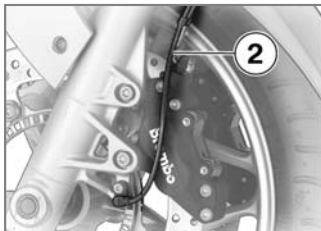
with OE BMW Motorrad ABS:



 The cable of the ABS sensor could chafe through if it comes into contact with the brake disc.

Make sure that the ABS sensor cable is routed snugly along the front suspension. ◀

- Route ABS sensor cable **2** as illustrated here. ◀

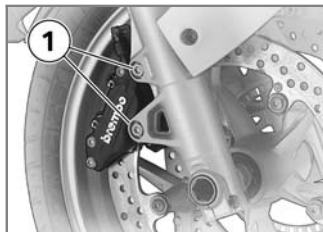

- Tighten securing screws **1** to the specified tightening torque.



Brake calipers to slider tube

– 30 Nm

- Remove the adhesive tape from the wheel rim.
- Operate the brake several times until the brake pads are bedded.

## Remove the rear wheel

- Place the motorcycle on an auxiliary stand; BMW Motorrad

recommends the BMW Motorrad rear-wheel stand.

- Install the rear-wheel stand (→ 103)

with OE Centre stand:

- Place the motorcycle on its centre stand.◀

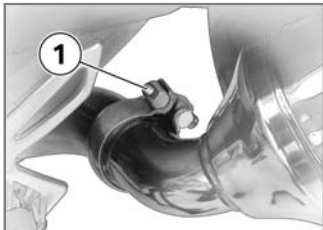

- Slacken screw **1** on the silencer.
- Do not remove the sealing grease from the clamp.
- Place a suitable support (e.g. wooden block) underneath the exhaust manifold to take its weight.



- Remove screw **2** for the bracket of the silencer from the rear footrest.



- Turn silencer **3** down and lay it down.
- Engage first gear.

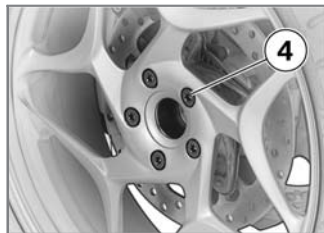

- Place a support underneath the rear wheel and remove studs **4**.
- Lower the rear wheel to the ground.
- Roll the rear wheel out toward the rear.

## Installing rear wheel

 Threaded fasteners not tightened to the specified torque can work loose or their threads can suffer damage. Always have the security of the fasteners checked by a specialist workshop, preferably an authorised BMW Motorrad dealer.◀

- Roll the rear wheel into position at the rear-wheel adapter.
- Seat the rear wheel on the rear-wheel adapter.

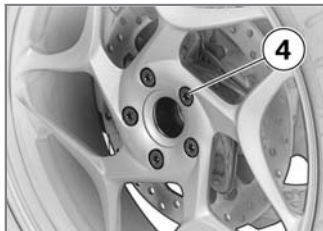

- Tighten wheel studs **4** to specified torque in diagonally opposite sequence.



Rear wheel to drive shaft

– 60 Nm

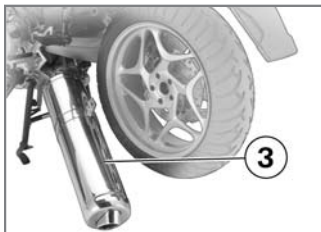

- Turn silencer **3** to its initial position.



- Install screw **2** for the bracket of the silencer in the rear footrest, but do not tighten it at this point.

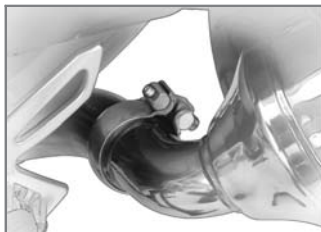

- Tighten the clamp on the silencer to the specified tightening torque.



Silencer to manifold

– 35 Nm



- Tighten screw **2** for the bracket of the silencer in the rear footrest to the specified torque.



Silencer to rear frame

– 19 Nm

- Remove the auxiliary stand, if installed beforehand.

## Front-wheel stand

### Use

A front-wheel stand for simple, safe changing of the front wheel is available from BMW Motorrad. The BMW special tool number is 36 3 970 and the front-wheel stand is available from your authorised BMW Motorrad dealer.



The BMW Motorrad front wheel stand is not designed to support motorcycles not fitted with a centre stand or without other auxiliary stands. A motorcycle resting only on the front wheel stand and the rear wheel can topple.

Place the motorcycle on its centre stand or another auxiliary stand before lifting the front wheel with the BMW Motorrad front-wheel stand.◀

## Installing front wheel stand

- Place the motorcycle on an auxiliary stand; BMW Motorrad recommends the BMW Motorrad rear-wheel stand.
- Install the rear-wheel stand (➔ 103) with OE Centre stand:
- Place the motorcycle on its centre stand.◀

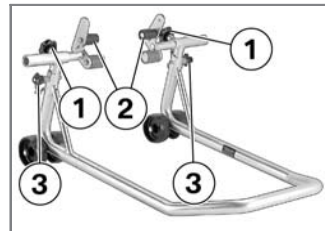

- Slacken adjusting screws **1**.
- Push the two adapters **2** apart until the front forks fit between them.



- Use locating pins **3** to set the front-wheel stand to the desired height.
- Centre the front-wheel stand relative to the front wheel and push it against the front axle.



- Apply uniform pressure to push the front-wheel stand down and raise the motorcycle.

## Rear-wheel stand

### Use

BMW Motorrad offers a rear-wheel stand for holding motorcycles (including those without centre stands) securely upright for maintenance work. The BMW special tool number is 36 3 980 and the rear-wheel stand is available from your authorised BMW Motorrad dealer.

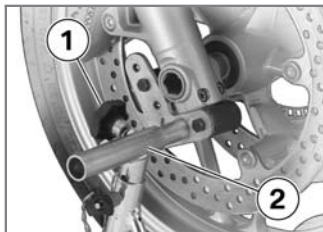

- Align the two adapters **2** so that the front forks are securely seated.
- Tighten adjusting screws **1**.

## Installing rear-wheel stand

- Make sure the ground is level and firm and place the motorcycle on its stand.

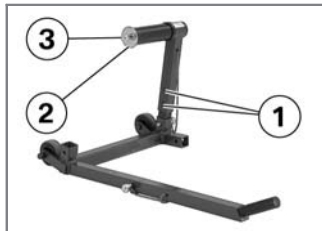

- Use screws **1** to set the rear-wheel stand to the desired height.
- Remove retaining disc **2**. To do so, press release button **3**.



- Push the rear-wheel stand from the right onto the rear axle.
- Push the retaining disc on from the left, while holding the unlock button down.
- Grip the rear grab handle of the motorcycle with your left hand and use your right to grip the lever of the rear-wheel stand 4.



- Lift the motorcycle upright, simultaneously pressing the lever down until the stand supports the motorcycle in the upright position.
- Press the lever down to the ground.

## Bulbs

### General instructions

A warning appears in the multi-function display if a bulb is defective.

 A defective bulb places your safety at risk because

it is easier for other users to oversee the motorcycle. Replace defective bulbs as soon as possible; always carry a complete set of spare bulbs if possible.◀

 The bulb is pressurised and can cause injury if damaged.

Wear protective goggles and gloves when changing bulbs.◀

 The types of bulb fitted to your motorcycle are listed in the section entitled "Technical data".◀

 Do not touch the glass of new bulbs with your fingers. Use a clean, dry cloth to hold the bulbs when handling them. Dirt deposits, in particular oil and grease, interfere with heat radiation from the bulb. This leads to overheating and shortens the bulb's operating life.◀

## Replacing high-beam/low-beam headlight bulb

 If it is not standing firmly, the motorcycle could topple in the course of the operations described below.

Always make sure that the motorcycle is stable and firmly supported. ◀

- Make sure the ground is level and firm and place the motorcycle on its stand.
- Switch off the ignition.

 Turn the handlebars to the left to facilitate access. ◀

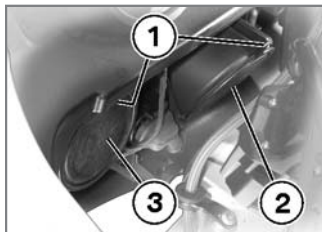

- Remove cover **2** (low-beam headlight) or cover **3** (high-beam headlight) by pulling lever **1**.

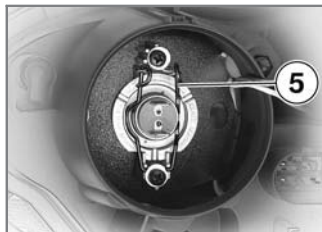

- Disengage spring clips **5** from the fastenings and swing them aside.

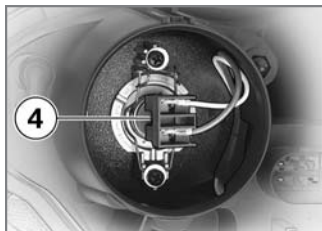

- Disconnect plug **4**.

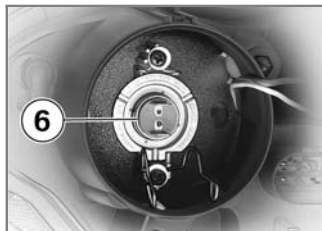

- Remove bulb **6**.
- Replace the defective bulb.



Bulb for high-beam  
headlight

– H7 / 12 V / 55 W



Bulb for low-beam head-  
light

– H7 / 12 V / 55 W



- Insert the bulb; make sure that projection **7** is correctly positioned (high-beam headlight down / low-beam headlight up) and make check that the bulb engages correctly.

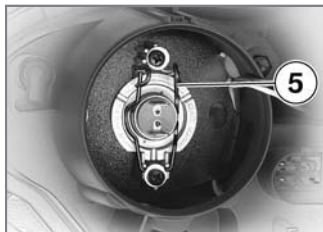

- Close and lock spring clips **5**.

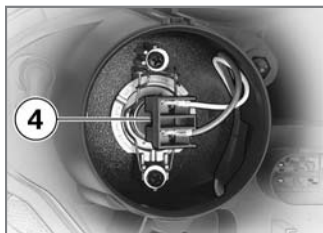

- Connect plug **4**.

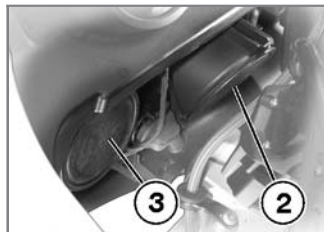

- Install cover **2** (low-beam headlight) or cover **3** (high-beam headlight).

## Replacing parking-light bulb



If it is not standing firmly, the motorcycle could topple in the course of the operations described below.

Always make sure that the motorcycle is stable and firmly supported. ◀

- Make sure the ground is level and firm and place the motorcycle on its stand.

- Switch off the ignition.

▷ Turn the handlebars to the left to facilitate access.◀

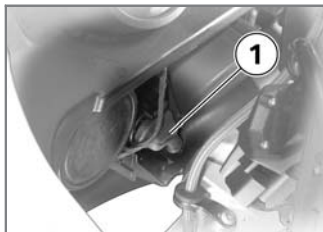

- Remove cap **1**.

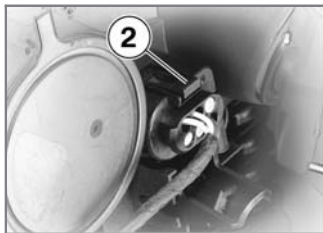

- Disconnect plug **2**.



- Turn bulb socket **3** counter-clockwise to remove.

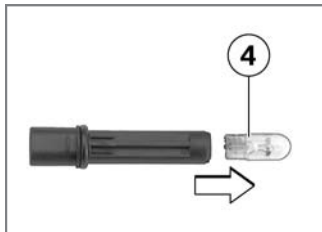

- Remove bulb **4** from the bulb holder.
- Replace the defective bulb.

 Bulb for parking light  
 – W5W / 12 V / 5 W

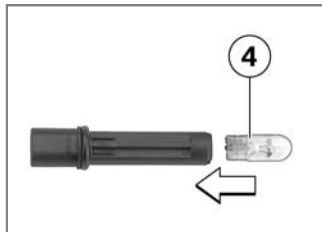

- Push bulb **4** into its socket.



- Turn bulb socket **3** clockwise to install.

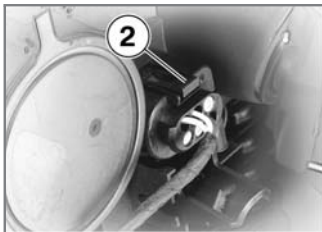

- Connect plug **2**.

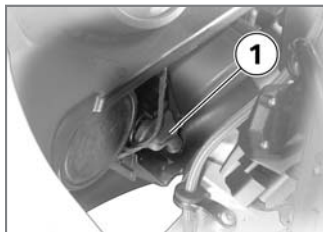

- Install cap **1**.

### Replacing the brake light and rear light bulbs

 If it is not standing firmly, the motorcycle could topple in the course of the operations described below.

Always make sure that the motorcycle is stable and firmly supported. ◀

- Make sure the ground is level and firm and place the motorcycle on its stand.
- Switch off the ignition.

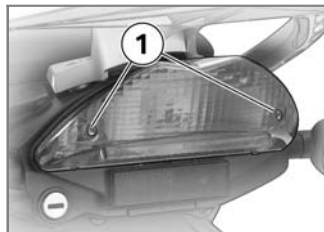

- Remove screws **1**.
- Pull the bulb housing to the rear to remove.

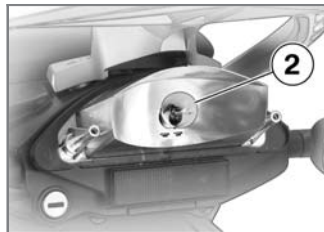

- Press bulb **2** into its socket and turn it counter-clockwise to remove.

- Replace the defective bulb.

 Bulb for tail light/brake light

– P21/5W / 12 V / 5 W / 21 W

- Use a clean, dry cloth to hold the new bulb.

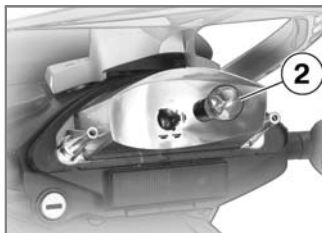

- Press bulb **2** into its socket and turn it clockwise to install.

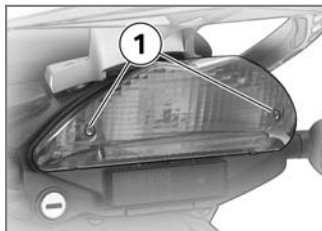

- Install the bulb housing with screws **1**.

### Replacing turn indicator bulbs, front or rear



- Remove screw **1**.

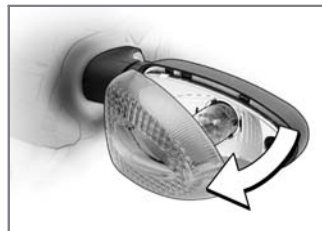

- Pull the glass out of the reflector or housing at the threaded-fastener side.

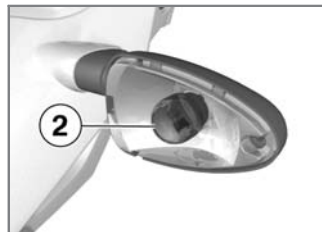

- Turn bulb **2** counter-clockwise and remove it from the bulb housing.

- Replace the defective bulb.



Bulbs for flashing turn indicators, front

– R10W / 12 V / 10 W

with OE White turn indicators:

– RY10W / 12 V / 10 W◁



Bulbs for flashing turn indicators, rear

– R10W / 12 V / 10 W

with OE White turn indicators:

– RY10W / 12 V / 10 W◁

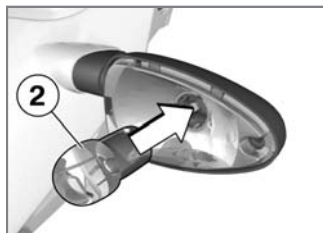

- Turn bulb **2** clockwise to install it in the bulb housing.

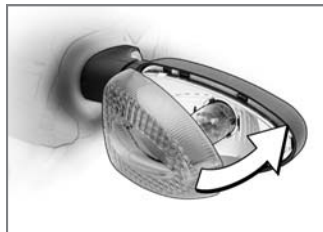

- Working from the inboard side, insert the glass into the bulb housing and close the housing.



- Install screw **1**.

## Jump starting



The wires leading to the power socket do not have a load-capacity rating adequate for jump-starting the engine. Excessively high current can lead to a cable fire or damage to the vehicle electronics.

Do not use the on-board socket to jump-start the engine of the motorcycle.◀



Touching live parts of the ignition system with the



engine running can cause electric shock.

Do not touch parts of the ignition system when the engine is running.◀



A short-circuit can result if the crocodile clips of the jump leads are accidentally brought into contact with the motorcycle.

Use only jump leads fitted with fully insulated crocodile clips at both ends.◀



Jump-starting with a donor battery voltage higher than 12 V can damage the vehicle electronics.

Make sure that the battery of the donor vehicle has a voltage rating of 12 V.◀

- Remove the battery-compartment cover (➔ 113)
- When jump-starting the engine, do not disconnect the battery

from the on-board electrical system.

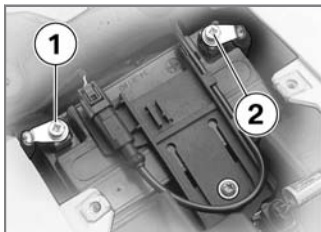

- Run the engine of the donor vehicle during jump-starting.
- Begin by connecting one end of the red jump lead to positive terminal **2** of the discharged battery and the other end to the positive terminal of the donor battery.
- Then connect one end of the black jump lead to the negative terminal of the donor battery and the other end to negative terminal **1** of the discharged battery.

- Start the engine of the vehicle with the discharged battery in the usual way; if the engine does not start, wait a few minutes before repeating the attempt in order to protect the starter motor and the donor battery.
- Allow both engines to idle for a few minutes before disconnecting the jump leads.
- Disconnect the jump lead from the negative terminals **1** first, then disconnect the second jump lead from the positive terminals **2**.

▶ Do not use proprietary start-assist sprays or other products to start the engine.◀

- Install the battery-compartment cover (➔ 114)

## Battery

### Maintenance instructions

Correct upkeep, recharging and storage will prolong the life of the battery and are essential if warranty claims are to be considered.

Compliance with the points below is important in order to maximise battery life:

- Keep the surface of the battery clean and dry
- Do not open the battery
- Do not top up with water
- Be sure to read and comply with the instructions for charging the battery on the following pages
- Do not turn the battery upside down

 If the battery is not disconnected, the on-board electronics (e.g. clock, etc.) gradually drain the battery. This can cause the battery to run flat. If this hap-

pens, warranty claims will not be accepted.

If the motorcycle is to be out of use for more than four weeks, disconnect the battery or connect a suitable trickle charger to the battery.◀

 BMW Motorrad has developed a float charger specially designed for compatibility with the electronics of your motorcycle. Using this charger, you can keep the battery charged during long periods of disuse, without having to disconnect the battery from the motorcycle's on-board systems. You can obtain additional information from your authorised BMW Motorrad dealer.◀

### Charging battery when connected

 Charging the connected battery directly at the battery terminals can damage the vehicle electronics.

Always disconnect the battery from the on-board circuits before recharging it with a charger connected directly to the battery posts.◀

 Only chargers suitable for this mode of charging can be used to recharge the battery via the on-board socket. Unsuitable chargers could cause damage to the motorcycle's on-board electrics.

Use BMW chargers with the part numbers 71 60 7 688 864 (220 V) or, as applicable, 71 60 7 688 865 (110 V). If you are in doubt, disconnect the battery from the on-board

systems and connect the charger directly to the battery.◀

**!** If you switch on the ignition and the multifunction display and telltale lights fail to light up, the battery is completely flat. Attempting to charge a completely flat battery via the on-board socket can cause damage to the motorcycle's electronics. If a battery has discharged to the extent that it is completely flat, it has to be disconnected from the on-board circuits and charged with the charger connected directly to the battery posts.◀

- Charge via the power socket, with the battery connected to the motorcycle's on-board electrical system.
- Comply with the operating instructions of the charger.

**▷** The motorcycle's on-board electronics know when the battery is fully charged. The

on-board socket is switched off when this happens.◀

## Charging battery when disconnected

- Charge the battery using a suitable charger.
- Comply with the operating instructions of the charger.
- Once the battery is fully charged, disconnect the charger's terminal clips from the battery terminals.

**▷** The battery has to be recharged at regular intervals in the course of a lengthy period of disuse. See the instructions for caring for your battery. Always fully recharge the battery before restoring it to use.◀

## Removing battery-compartment cover

- Remove the seat (➡ 56)

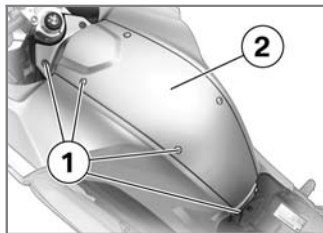

- Remove four screws **1** on left and right and remove battery-compartment cover **2**.

## Installing battery-compartment cover

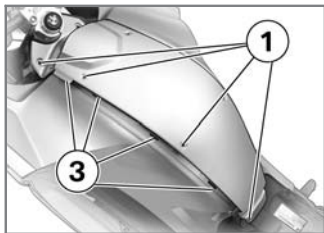

- Seat the battery-compartment cover in guides **3** on left and right.
- Install four screws **1** on left and right.
- Install the seat (⇒ 56)

## Removing battery

- Make sure the ground is level and firm and place the motorcycle on its stand.
- Switch off the ignition.

- Remove the battery-compartment cover (⇒ 113)

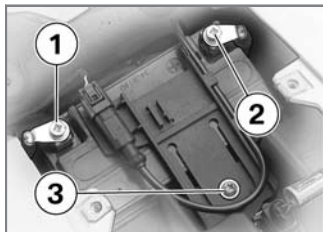

**!** Disconnection in the wrong sequence increases the risk of short-circuits. Always proceed in the correct sequence. ◀

- Disconnect negative lead **1** first.
- Then disconnect positive lead **2**.
- Remove screw **3** and remove the battery retainer.

- Lift the battery up and out; work it slightly back and forth if it is difficult to remove.

## Installing battery

- Switch off the ignition.
- Insert the battery into the battery compartment, with the positive terminal on the right in the direction of travel.

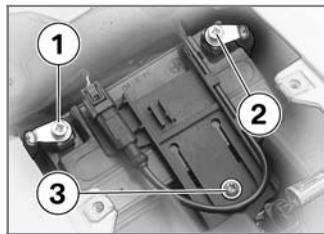

- Slip the battery retainer over the battery and install screw **3**.

**!** Connection in the wrong sequence increases the risk of short-circuits.

Always proceed in the correct sequence.◀

- Connect positive lead **2** to the battery's positive terminal.
- Connect negative lead **1** to the battery's negative terminal.

 If the battery was disconnected from the motorcycle for a prolonged period of time it will be necessary to enter the current date in the instrument cluster, in order to ensure that the service-due indicator functions correctly.

If you want to have the date set consult a specialist workshop, preferably an authorised BMW Motorrad dealer.◀

- Install the battery-compartment cover (➡ 114)
- Set the clock (➡ 40)



## Care

Care products .....	118
Washing motorcycle .....	118
Cleaning easily damaged components.....	118
Paint care .....	119
Protective wax coating .....	120
Laying up the motorcycle .....	120
Restoring motorcycle to use .....	120

## Care products

BMW Motorrad recommends that you use the cleaning and care products you can obtain from your authorised BMW Motorrad dealer. The substances in BMW Care Products have been tested in laboratories and in practice; they provide optimised care and protection for the materials used in your vehicle.

 The use of unsuitable cleaning and care products can damage vehicle components. Do not use solvents such as cellulose thinners, cold cleaners, fuel or the like, and do not use cleaning products that contain alcohol.◀

## Washing motorcycle

BMW Motorrad recommends that you use BMW insect remover to soften and wash off insects and stubborn dirt on

painted parts prior to washing the motorcycle.

To prevent stains, do not wash the motorcycle immediately after it has been exposed to strong sunlight and do not wash it in the sun.

Make sure that the motorcycle is washed frequently, especially during the winter months.

To remove road salt, clean the motorcycle with cold water immediately after every trip.

 After the motorcycle has been washed, ridden through water or ridden in the rain, the brake discs and pads might be wet and the brakes might not take effect immediately.

Apply the brakes in good time until the brakes have dried out.◀

 Warm water intensifies the effect of salt.

Use only cold water to wash off road salt.◀

 The high pressure of steam cleaners can damage seals, the hydraulic brake system, the electrical system, and the seat. Do not use a steam jet or high-pressure cleaning equipment.◀

## Cleaning easily damaged components

### Plastics

Clean plastic parts with water and BMW plastic care emulsion. This includes in particular:

- Windscreen and slipstream deflectors
- Headlight lens made of plastic
- Glass cover of the instrument cluster
- Black, unpainted parts

 If plastic parts are cleaned using unsuitable cleaning



agents, the surfaces can be damaged.

Do not use cleaning agents that contain alcohol, solvents or abrasives to clean plastic parts. Even fly-remover pads or cleaning pads with hard surfaces can produce scratches.◀

 Soften stubborn dirt and insects by covering the affected areas with a wet cloth.◀

## Windscreen

Clean off dirt and insects with a soft sponge and plenty of water.

 Fuel and chemical solvents attack the material of the windscreen; the windscreen becomes opaque or dull.

Do not use cleaning agents.◀

## Chrome

Use plenty of water and BMW shampoo to clean chrome, particularly if it has been exposed to road salt. Use chrome polish for additional treatment.

## Radiator

Clean the radiator regularly to prevent overheating of the engine due to inadequate cooling. For example, use a garden hose with low water pressure.

 Cooling fins can be bent easily.

Take care not to bend the fins when cleaning the radiator.◀

## Rubber

Treat rubber components with water or BMW rubber-care products.

 Using silicone sprays for the care of rubber seals can cause damage.

Do not use silicone sprays or other care products that contain silicon.◀

## Paint care

Washing the motorcycle regularly will help counteract the long-term effects of substances that damage the paint, especially if your motorcycle is ridden in areas with high air pollution or natural sources of dirt, for example tree resin or pollen.

Remove particularly aggressive substances immediately, however, as otherwise the paint can be affected or become discoloured. Substances of this nature include spilt fuel, oil, grease, brake fluid and bird droppings. We recommend BMW vehicle polish or BMW paint cleaner for this purpose.

Marks on the paintwork are particularly easy to see after the motorcycle has been washed.

Remove stains of this kind immediately, using cleaning-grade benzene or petroleum spirit on a clean cloth or ball of cotton wool. BMW Motorrad recommends BMW tar remover for removing specks of tar. Remember to wax the parts treated in this way.

## Protective wax coating

BMW Motorrad recommends applying only BMW car wax or products containing carnauba wax or synthetic wax.

It is time to rewax the paint-work when water "puddles" on the surface, instead of forming beads.

## Laying up the motorcycle

- Clean the motorcycle.
- Remove the battery.
- Spray the brake and clutch lever pivots, the side stand

pivots and the centre stand pivots (if the motorcycle is fitted with a centre stand) with a suitable lubricant.

- Coat bright metal and chrome-plated parts with an acid-free grease (e.g. Vaseline).
- Stand the motorcycle in a dry room in such a way that there is no load on either wheel.

 Before laying the vehicle up out of use, have the engine oil and the oil filter element changed by a specialist workshop, preferably an authorised BMW Motorrad dealer. Combine work for laying up/restoring to use with a BMW service or inspection.◀

## Restoring motorcycle to use

- Remove the protective wax coating.
- Clean the motorcycle.

- Install a charged battery.
- Before starting: work through the checklist.

## Technical data

Troubleshooting chart .....	122
Threaded fasteners .....	123
Engine .....	124
Fuel .....	125
Engine oil .....	125
Clutch .....	126
Transmission .....	126
Rear-wheel drive .....	127
Running gear .....	127
Brakes .....	128
Wheels and tyres .....	128
Electrics .....	130
Frame .....	132
Dimensions .....	132
Weights .....	133

Riding specifications .....	133
-----------------------------	-----

## Troubleshooting chart

Engine does not start at all or is difficult to start.

<b>Possible cause</b>	<b>Remedy</b>
Kill switch activated.	Kill switch in operating position (run).
Side stand extended and gear engaged.	Retract the side stand (➡ 62).
Gear engaged and clutch not disengaged.	Select neutral or pull clutch lever (➡ 62).
Clutch pulled when ignition was OFF	Switch on the ignition, then pull the clutch lever.
No fuel in tank.	Refuelling (➡ 68)
Battery not adequately charged.	Charge the battery when connected (➡ 112)

## Threaded fasteners

<b>Front wheel</b>	<b>Value</b>	<b>Valid</b>
<b>Brake calipers to slider tube</b>		
M10 x 35 - 10.9	30 Nm	
<b>Clamp of quick-release axle</b>		
M8 x 40	20 Nm	
<b>Quick-release axle in axle holder</b>		
M24 x 1.5	50 Nm	
<b>Rear wheel</b>	<b>Value</b>	<b>Valid</b>
<b>Rear wheel to drive shaft</b>		
M10 x 1.25	60 Nm	
<b>Silencer to manifold</b>		
M8 x 60 - 10.9	35 Nm	
<b>Silencer to rear frame</b>		
M8	19 Nm	

## Engine

Engine design	Two-cylinder four-stroke, DOHC with chain-and-sprocket drive, 4 valves operated by cam followers, balancing conrod, liquid-cooled cylinders and heads, integral water pump, 6-speed gearbox and dry sump lubrication
Displacement	798 cm <sup>3</sup>
Cylinder bore	82 mm
Piston stroke	75.6 mm
Compression ratio	12 : 1
Nominal output	62.5 kW, - at engine speed: 8000 min <sup>-1</sup>
with OE Regular unleaded (RON 91):	61 kW, - at engine speed: 8000 min <sup>-1</sup>
with OE Power reduction:	25 kW, - at engine speed: 7000 min <sup>-1</sup>
Torque	86 Nm, - at engine speed: 5800 min <sup>-1</sup>
with OE Regular unleaded (RON 91):	83 Nm, - at engine speed: 5800 min <sup>-1</sup>
with OE Power reduction:	55 Nm, - at engine speed: 3500 min <sup>-1</sup>
Maximum engine speed	max 9000 min <sup>-1</sup>
Idle speed	1250±50 min <sup>-1</sup>

## Fuel

Recommended fuel grade	95 ROZ/RON, Super unleaded
with OE Regular unleaded (RON 91):	91 ROZ/RON, Regular unleaded (fuel grade, usable with power- and consumption-related restrictions)
Usable fuel capacity	16 l
Reserve fuel	≥4 l

## Engine oil

Engine oil, capacity	3 l, with filter change
	0.3 l, additional, if swing-arm shaft cover is removed
Lubricant	Engine oil, 15W-40
Oil grades	Mineral oils of API classification SF through SH. BMW Motorrad recommends not using oil additives, because they can have a detrimental effect on clutch operation. Please do not hesitate to contact your authorised BMW Motorrad dealer if you have any questions relating the choice of a suitable engine oil for your motorcycle.

**Permissible viscosity classes**

SAE 10 W-40	$\geq -20$ °C, Operation at low temperatures
SAE 15 W-40	$\geq -10$ °C

**Clutch**

Clutch type	Multiplate clutch running in oil bath
-------------	---------------------------------------

**Transmission**

Gearbox type	Claw-shift 6-speed gearbox, integrated into engine block
--------------	--

**Gear ratios**

Gearbox transmission ratios	1.943 (35/68 teeth), Primary transmission ratio 1:2.462 (13/32 teeth), 1st gear 1:1.750 (16/28 teeth), 2nd gear 1:1.381 (21/29 teeth), 3rd gear 1:1.174 (23/27 teeth), 4th gear 1:1.042 (24/25 teeth), 5th gear 1:0.960 (25/24 teeth), 6th gear
-----------------------------	---



## Rear-wheel drive

Type of final drive	Belt drive with damper in special housing
Type of rear suspension	Single-arm cast light-alloy swinging arm with cam-adjustable rear wheel axle

## Running gear

Type of front suspension	Telescopic forks
Spring travel, front	140 mm, At wheel
with OE Lowered suspension:	110 mm, At wheel
Type of rear suspension	Single-arm cast light-alloy swinging arm with cam-adjustable rear wheel axle
Type of rear suspension	Direct-pivot central spring strut with steplessly adjustable rebound-stage damping
Spring travel at rear wheel	140 mm, At wheel
with OE Lowered suspension:	113 mm, At wheel

## Brakes

Type of front brake	hydraulically operated twin disc brake with 4-piston fixed calipers and floating brake discs
Brake-pad material, front	Sintered metal
Type of rear brake	Hydraulically actuated 1-piston floating caliper with fixed brake disc
Brake-pad material, rear	Sintered metal

## Wheels and tyres

Tyre combinations recommended at time of going to press (As at: 12.04.2007)	Front: Bridgestone Battlax BT 014 F Radial F, 120/70 ZR17 M/C (58W) Rear: Bridgestone Battlax BT 014R Radial F, 180/55 ZR17 M/C (73W)
	Front: Bridgestone Battlax BT 020 F UU Radial, 120/70 ZR17 M/C (58W) Rear: Bridgestone Battlax BT 020R Radial N, 180/55 ZR17 M/C (73W)
	Front: Continental Conti Sport Attack, 120/70 ZR17 M/C (58W) Rear: Continental Conti Sport Attack, 180/55 ZR17 M/C (73W)

	<p>Front: Dunlop Sportmax D 220 F ST P, 120/70 ZR17 M/C (58W)  Rear: Dunlop Sportmax D 220 ST P, 180/55 ZR17 M/C (73W)</p>
	<p>Front: Metzeler Sporttec M-1 E, 120/70 ZR17 M/C (58W)  Rear: Metzeler Sporttec M-1 B, 180/55 ZR17 M/C (73W)</p>
	<p>Front: Metzeler Roadtec Z6 Front, 120/70 ZR17 M/C (58W)  Rear: Metzeler Roadtec Z6 E, 180/55 ZR17 M/C (73W)</p>
	<p>Front: Michelin Pilot Road B, 120/70 ZR17 M/C (58W)  Rear: Michelin Pilot Road K, 180/55 ZR17 M/C (73W)</p>

### Front wheel

Front wheel, type	Cast aluminium, MT H2
Front wheel rim size	3.50" x 17"
Tyre designation, front	120/70 ZR 17

**Rear wheel**

Battery, manufacturer and designation	ETX 14 BS
Rear wheel rim size	5.5" x 17"
Tyre designation, rear	180/55 ZR 17

**Tyre pressure**

Tyre pressure, front	2.5 bar, one-up, tyre cold 2.5 bar, two-up and/or with luggage, tyre cold
Tyre pressure, rear	2.8 bar, one-up, tyre cold 2.8 bar, two-up and/or with luggage, tyre cold

**Electrics**

Electrical rating of on-board socket	5 A, One on-board socket
Fuses	Electronic fuses protect all the circuits. If an electronic fuse trips and de-energises a circuit, the circuit is active as soon as the ignition is switched on after the fault has been rectified.

**Battery**

Battery, manufacturer and designation	ETX 14 BS
Battery type	AGM (Absorptive Glass Mat) battery
Battery rated voltage	12 V
Battery rated capacity	14 Ah

**Spark plugs**

Spark plugs, manufacturer and designation	NGK DCPR 8 E
Electrode gap of spark plug	0.9 $\pm$ 0 mm, When new
	max 1.2 mm, Wear limit

**Lighting**

Bulb for high-beam headlight	H7 / 12 V / 55 W
Bulb for low-beam headlight	H7 / 12 V / 55 W
Bulb for parking light	W5W / 12 V / 5 W
Bulb for tail light/brake light	P21/5W / 12 V / 5 W / 21 W
Bulbs for flashing turn indicators, front	R10W / 12 V / 10 W
with OE White turn indicators:	RY10W / 12 V / 10 W
Bulbs for flashing turn indicators, rear	R10W / 12 V / 10 W
with OE White turn indicators:	RY10W / 12 V / 10 W

## Frame

Frame type	Aluminium deltabox frame
Type plate location	Steering head, right
VIN location	Steering head, right

## Dimensions

Length of motorcycle	2195 mm
Height of motorcycle	1225 mm, Without rider at unladen weight, to top edge of windscreen
with OE Lowered suspension:	1195 mm, Without rider at unladen weight, to top edge of windscreen
Width of motorcycle	860 mm, Across mirrors
Front-seat height	820 mm, Without rider at unladen weight
with OE Double seat, low:	790 mm, Without rider at unladen weight
with OE Lowered suspension:	790 mm, Without rider at unladen weight
with OE Lowered suspension and with OE Double seat, low:	760 mm, Without rider at unladen weight

## Weights

Unladen weight	204 kg, DIN unladen weight, ready for road, 90 % load of fuel, without optional extras
Permissible gross weight	405 kg
Maximum payload	201 kg

## Riding specifications

Top speed	>200 km/h
with OE Power reduction:	155 km/h





## Service

BMW Motorrad service .....	136
BMW Motorrad service quality .....	136
BMW Motorrad Service Card: on-the-spot breakdown assistance ....	136
BMW Motorrad service network ...	137
Maintenance work .....	137
Confirmation of maintenance work .....	138
Confirmation of service .....	143

## BMW Motorrad service

Advanced technology requires specially adapted methods of maintenance and repair.



If maintenance and repair work is performed inexpertly, it could result in consequential damage and thus constitute a safety risk.

BMW Motorrad recommends you to have all the associated work on your motorcycle carried out by a specialist workshop, preferably an authorised BMW Motorrad dealer. ◀

Your authorised BMW Motorrad dealer can provide information on BMW services and the work undertaken as part of each service. Have all maintenance and repair work carried out confirmed in the "Service" chapter in this manual. Authorised BMW Motorrad dealers are supplied with the latest technical information and have

the necessary technical know-how. BMW Motorrad recommends that you contact your authorised BMW Motorrad dealer if you have questions regarding your motorcycle.

## BMW Motorrad service quality

Along with its reputation for engineering quality and high reliability, BMW Motorrad is a byword for excellent quality of service. To ensure that your BMW is always in optimum condition, BMW Motorrad recommends that you have the maintenance work required for your motorcycle carried out regularly, preferably by your authorised BMW Motorrad dealer. For generous treatment of claims submitted after the warranty period has expired, evidence of regular maintenance is essential.

Certain signs of wear, moreover, may otherwise not be noticed until it is too late to put them right at moderate cost. Your authorised BMW Motorrad dealer's mechanics know every detail of your motorcycle and can take remedial action if necessary before minor faults develop into serious problems. By having the necessary repairs done properly and in good time, you save time and money in the long run.

## BMW Motorrad Service Card: on-the-spot breakdown assistance

In the event of a breakdown, the BMW Motorrad Service Card issued with each new BMW motorcycle enables you to access an extensive range of services such as breakdown assistance, motorcycle transportation etc. (details can differ from country to country). In the event of a break-

down, contact BMW Motorrad's Mobile Service. The specialists will provide the necessary advice and assistance.

You will find important country-specific contact addresses and the after-sales service organisation phone numbers in the "Service Kontakt / Service Contact" brochures, along with information on Mobile Service and the dealership network.

## **BMW Motorrad service network**

BMW Motorrad has an extensive after-sales service network in place to look after you and your motorcycle in more than 100 countries. In Germany alone, you have the best possible access to approximately 200 authorised BMW Motorrad dealers.

All information concerning the international dealership network can be found in the brochure

"Service Contact Europe" or "Service Contact Africa, America, Asia, Australia, Oceania".

## **Maintenance work**

### **BMW Pre-delivery Check**

Your authorised BMW motorcycle dealer conducts the BMW pre-delivery check before handing over the motorcycle to you.

### **BMW Running-in Check**

The BMW running-in check has to be performed when the motorcycle has covered between 500 km and 1,200 km

### **BMW Service**

The BMW Service is carried out once a year; the extent of servicing can vary, depending on the age of the motorcycle and the distance it has covered. Your authorised BMW Motorrad dealer confirms that the service work has been carried out and enters

the date when the next service will be due.

Riders who cover long distances in a year might have to bring in their motorcycles for service before the next scheduled date. It is to allow for these cases that a maximum odometer reading is entered as well in the confirmation of service. Servicing has to be brought forward if this odometer reading is reached before the next scheduled date for the service.

The service-due indicator in the multifunction display reminds you about one month or 1000 km in advance when the time for a service is approaching, on the basis of the programmed values.

## Confirmation of maintenance work

### BMW Pre-delivery Check

Completed

on \_\_\_\_\_

\_\_\_\_\_  
Stamp, signature

### BMW Running-in Check

Completed

on \_\_\_\_\_

Odometer reading \_\_\_\_\_

Next service  
at the latest

on \_\_\_\_\_

or, if logged beforehand,

Odometer reading \_\_\_\_\_

\_\_\_\_\_  
Stamp, signature

**BMW Service**

Completed

on \_\_\_\_\_

Odometer reading \_\_\_\_\_

Next service  
at the latest

on \_\_\_\_\_

or, if logged beforehand,

Odometer reading \_\_\_\_\_

\_\_\_\_\_  
Stamp, signature**BMW Service**

Completed

on \_\_\_\_\_

Odometer reading \_\_\_\_\_

Next service  
at the latest

on \_\_\_\_\_

or, if logged beforehand,

Odometer reading \_\_\_\_\_

\_\_\_\_\_  
Stamp, signature**BMW Service**

Completed

on \_\_\_\_\_

Odometer reading \_\_\_\_\_

Next service  
at the latest

on \_\_\_\_\_

or, if logged beforehand,

Odometer reading \_\_\_\_\_

\_\_\_\_\_  
Stamp, signature

**BMW Service**

Completed

on \_\_\_\_\_

Odometer reading \_\_\_\_\_

Next service

at the latest

on \_\_\_\_\_

or, if logged beforehand,

Odometer reading \_\_\_\_\_

\_\_\_\_\_  
Stamp, signature**BMW Service**

Completed

on \_\_\_\_\_

Odometer reading \_\_\_\_\_

Next service

at the latest

on \_\_\_\_\_

or, if logged beforehand,

Odometer reading \_\_\_\_\_

\_\_\_\_\_  
Stamp, signature**BMW Service**

Completed

on \_\_\_\_\_

Odometer reading \_\_\_\_\_

Next service

at the latest

on \_\_\_\_\_

or, if logged beforehand,

Odometer reading \_\_\_\_\_

\_\_\_\_\_  
Stamp, signature

**BMW Service**

Completed

on \_\_\_\_\_

Odometer reading \_\_\_\_\_

Next service  
at the latest

on \_\_\_\_\_

or, if logged beforehand,

Odometer reading \_\_\_\_\_

\_\_\_\_\_  
Stamp, signature**BMW Service**

Completed

on \_\_\_\_\_

Odometer reading \_\_\_\_\_

Next service  
at the latest

on \_\_\_\_\_

or, if logged beforehand,

Odometer reading \_\_\_\_\_

\_\_\_\_\_  
Stamp, signature**BMW Service**

Completed

on \_\_\_\_\_

Odometer reading \_\_\_\_\_

Next service  
at the latest

on \_\_\_\_\_

or, if logged beforehand,

Odometer reading \_\_\_\_\_

\_\_\_\_\_  
Stamp, signature

**BMW Service**

Completed

on \_\_\_\_\_

Odometer reading \_\_\_\_\_

Next service  
at the latest

on \_\_\_\_\_

or, if logged beforehand,

Odometer reading \_\_\_\_\_

\_\_\_\_\_  
Stamp, signature**BMW Service**

Completed

on \_\_\_\_\_

Odometer reading \_\_\_\_\_

Next service  
at the latest

on \_\_\_\_\_

or, if logged beforehand,

Odometer reading \_\_\_\_\_

\_\_\_\_\_  
Stamp, signature**BMW Service**

Completed

on \_\_\_\_\_

Odometer reading \_\_\_\_\_

Next service  
at the latest

on \_\_\_\_\_

or, if logged beforehand,

Odometer reading \_\_\_\_\_

\_\_\_\_\_  
Stamp, signature



## Confirmation of service

The table is intended as a record of maintenance, warranty and repair work, the installation of optional accessories and, if appropriate, special campaign (recall) work.

Item	Odometer reading	Date



## A

- Abbreviations and symbols, 6
- ABS
  - Self-diagnosis, 64
- Accessories
  - General instructions, 76
- Anti-theft alarm, 18

## B

- Battery, 15
  - Charging battery when connected, 112
  - Charging battery when disconnected, 113
  - Installation, 114
  - Installing compartment cover, 114
  - Maintenance instructions, 112
  - Removal, 114
  - Removing compartment cover, 113
  - Technical data, 130
- Brake fluid
  - Checking level, front, 91
  - Checking level, rear, 92

- Brake pads
  - Checking front, 89
  - Checking rear, 90
  - Running in, 65

## Brakes

- Adjusting handbrake lever, 52
- Checking operation, 89
- Fluid reservoir, rear, 13
- Front fluid reservoir, 13
- Safety instructions, 65
- Technical data, 128

## Bulbs

- General instructions, 104
- High-beam headlight, 19
- Low-beam headlight, 19
- Replacing front turn indicator bulb, 109
- Replacing high-beam headlight bulb, 105
- Replacing low-beam headlight bulb, 105
- Replacing rear turn indicator bulb, 109
- Replacing side-light bulb, 106

- Replacing the brake light and rear light bulbs, 108
- Side lights, 19
- Technical data, 131
- Warning for bulb failure, 28

## C

- Care, 117
- Case
  - Adapting, 81
  - Adjusting, 79
  - Closing, 79
  - Installing, 80
  - Opening, 79
  - Removing, 80
- Checklist, 62
- Cleaning, 117
- Clock, 22
  - Adjusting, 18, 40
- Clutch
  - Adjusting clutch lever, 51
  - Checking operation, 95
  - Technical data, 126
- Confirmation of maintenance work, 138

Coolant  
  Checking level, 93  
  Reading, 13  
  Temperature gauge, 22  
  Topping up, 93  
Currency, 7

**D**

Damping, 13, 54  
Dimensions  
  Technical data, 132

**E**

Electrics  
  Technical data, 130  
Emergency off switch (kill switch), 17, 50  
Engine  
  Starting, 62  
  Technical data, 124  
  Warning for engine electronics, 27  
Engine oil  
  Checking level, 87  
  Dipstick, 11  
  Filler neck, 11

  Temperature gauge, 24  
  Topping up, 88  
  Warning for engine oil pressure, 28  
Equipment, 7  
EWS, 39  
  Warning, 27

**F**

First-aid kit  
  Stowage, 14  
Frame  
  Technical data, 132  
Front-wheel stand, 102  
Fuel  
  Quantity reading, 22, 24  
  Refuelling, 68  
  Technical data, 4  
  Warning for fuel down to reserve, 27  
Fuses, 130

**G**

Gear indicator, 22, 23  
Grip heating, 17, 51

**H**

Handlebar fittings  
  General view, left side, 16  
  General view, right side, 17  
Hazard warning flashers, 16  
  Switching off, 50  
  Switching on, 49  
Headlight  
  Adjustment for driving on left/  
  driving on right, 55  
  Beam throw, 55  
Headlight flasher, 16  
Helmet holder, 14, 56  
High-beam headlight, 16, 19  
  Telltale light, 22  
Horn, 16

**I**

Idle  
  Telltale light, 22  
Ignition  
  Switching off, 38  
  Switching on, 38  
Immobiliser, 39  
  Warning, 27

Instrument cluster  
  Overview, 18  
  Sensor for instrument cluster lighting, 18

**J**  
Jump starting, 110

**K**  
Keys, 38

**L**  
Laying up, 120  
Lights  
  Adjusting headlight beam throw, 11  
  Headlight flasher, 47  
  High-beam headlight, 47  
  Low-beam headlight, 47  
  Parking light, 48  
  Side light, 47  
Low-beam headlight, 19  
Luggage  
  Correct loading, 77  
  Lashing, 78

**M**  
Maintenance  
  General instructions, 86  
Mirrors  
  Adjusting, 52  
Motorcycle  
  Care, 117  
  Cleaning, 117  
  General view, left side, 11  
  General view, right side, 13  
  Laying up, 120  
  Parking, 67  
  Restoring to use, 120  
Multifunction display, 18

**O**  
Odometer and tripmeters  
  Resetting, 41  
  Scale range, 22  
  Select readings, 40  
On-board computer, 16  
  Ambient temperature, 42  
  Average consumption, 43  
  Average speed, 42  
  Range, 43

  Reset the average consumption, 43  
  Reset the average speed, 42  
  Select readings, 41  
  Stopwatch, 44, 45

**P**  
Parking, 67  
Power socket, 13, 76  
Pre-ride check, 63  
Puncture repair kit  
  Stowage, 15

**R**  
Rear-wheel drive  
  Technical data, 127  
Rear-wheel stand, 103  
Redline warning, 46  
  Reading, 18  
Refuelling, 68  
Reserve  
  Warning, 27  
Restoring to use, 120  
Rev. counter, 18  
Rider's Manual, 14

Running gear  
  Technical data, 127  
Running in, 64

## S

Safety instructions, 60  
  Brakes, 65  
Seat, 14  
  Installation, 56  
  Removal, 56  
Seat lock, 11  
Service, 136  
  Status indicators on the  
  display, 22  
Service Card, 136  
Side light, 19  
Side stand  
  Starting the engine, 62  
Spark plugs  
  Technical data, 131  
Speedometer, 18  
Spring preload  
  Adjusting, 13, 52  
  Adjusting wrench, 14  
Starter, 17

Starting, 62  
Steering lock, 39  
Stopwatch, 18, 22, 44, 45

## T

Technical data  
  Battery, 130  
  Brakes, 128  
  Bulbs, 131  
  Clutch, 126  
  Dimensions, 132  
  Electrics, 130  
  Engine, 124  
  Frame, 132  
  Fuel, 4  
  Rear-wheel drive, 127  
  Running gear, 127  
  Spark plugs, 131  
  Standards, 7  
  Transmission, 126  
  Weights, 133  
  Wheels and tyres, 128  
Telltale lights, 18  
  Overview, 22

Toolkit, 14  
  Service kit, 86  
Topcase  
  Closing, 82  
  Installing, 83  
  Opening, 81  
  Removing, 82  
Torques, 123  
Transmission  
  Starting the engine, 62  
  Technical data, 126  
Troubleshooting chart, 122  
Turn indicators  
  Left, 16, 48  
  Right, 17, 48  
  Switching off, 17, 49  
  Telltale light, 22  
Tyre pressure monitoring RDC  
  Label on wheel rim, 96  
  Status indicators, 46  
  Warnings, 32

## Tyres

- Approved tyres, 96
- Checking inflation pressure, 54
- Checking tread depth, 95
- Running in, 65
- Technical data, 128

## **W**

Warning lights, 18

Warning symbols

- Display panels, 22

Warnings

- Mode of presentation, 24

Warnings, overview, 26, 31, 33

Weights

- Technical data, 133

Wheels

- Installing front wheel, 98
- Installing rear wheel, 100
- Remove the rear wheel, 99
- Removing front wheel, 96
- Technical data, 128

Details described or illustrated in this booklet may differ from the motorcycle's actual specification as purchased, the accessories fitted or the national-market specification. No claims will be entertained as a result of such discrepancies.

Dimensions, weights, fuel consumption and performance data are quoted to the customary tolerances.

The right to modify designs, equipment and accessories is reserved.

Errors and omissions excepted.

© 2007 BMW Motorrad

Not to be reproduced either wholly or in part without written permission from BMW Motorrad, After Sales.

Printed in Germany.



## Important data for refuelling

<b>Fuel</b>	
Recommended fuel grade	95 ROZ/RON, Super unleaded
with OE Regular unleaded (RON 91):	91 ROZ/RON, Regular unleaded (fuel grade, usable with power- and consumption-related restric- tions)
Usable fuel capacity	16 l
Reserve fuel	≥4 l
<b>Tyre pressure</b>	
Tyre pressure, front	2.5 bar, one-up, tyre cold 2.5 bar, two-up and/or with lug- gage, tyre cold
Tyre pressure, rear	2.8 bar, one-up, tyre cold 2.8 bar, two-up and/or with lug- gage, tyre cold

**BMW recommends** 

Order No. 01 41 7 709 241  
06.2007, 3rd edition



## F 800 S / F 800 ST

<b>D</b>	Korrektur zu F 800 S und F 800 ST (Seite 77 )
	Tempolimit für Fahrten mit Koffer: siehe Hinweisschild im Koffer.
<b>GB</b>	Correction for F 800 S and F 800 ST (Page 77)
	Maximum permissible speed for riding with cases: See label inside the case.
<b>F</b>	Correction concernant F 800 S et F 800 ST (Page 79)
	Limitation de vitesse pour conduites avec valises : voir plaquette d'avertissement dans la valise.
<b>E</b>	Modificación para F 800 S y F 800 ST (Página 83)
	Límite de velocidad con maleta montada: véase placa de advertencia de la maleta.
<b>I</b>	Correzione per F 800 S e F 800 ST (Pagina 77)
	Limite di velocità per la marcia con valigia: vedere la targhetta di avvertenza nella valigia.
<b>S</b>	Korrigerig för F 800 S och F 800 ST (Sidan 75)
	Hastighetsgräns för körning med toppbox: se anvisningsskylt i toppboxen.
<b>NL</b>	Correctie voor F 800 S en F 800 ST (Pagina 77)
	Snelheidslimiet voor het rijden met koffer: Zie de sticker in de koffer.

<b>USA</b>	Correction for F 800 S and F 800 ST (Page 77) Speed limit when riding with case: see label in case.
<b>P</b>	Correcção referente à F 800 S e F 800 ST (Página 78 ) Limite de velocidade para viagens com mala: consultar etiqueta de informação na mala.
<b>FIN</b>	Korjaus käsikirjoihin F 800 S ja F 800 ST (Sivu 78) Nopeusrajoitus laukut asennettuina: ks. huomautuskilpi laukussa.
<b>GR</b>	Διόρθωση για F 800 S και F 800 ST (Σελίδα 77 ) Όριο ταχύτητας για οδήγηση με βαλίτσες: βλέπε πινακίδα οδηγιών στη βαλίτσα.
<b>J</b>	改訂 : F 800 S および F 800 ST ( ページ 77 ) ケースを装着している場合の最高速度 : ケース内の注意ステッカーを参照
<b>PL</b>	Korekta do F 800 S i F 800 ST (Strona 79) Ograniczenie prędkości dla jazdy z kufrem: patrz tabliczka informacyjna w kufrze.

