

Rider's Manual (US Model)

G 650 Xmoto



BMW Motorrad



The Ultimate Riding
Machine

Motorcycle/Retailer Data

Motorcycle data

Model

Vehicle Identification Number

Color number

First registration

Registration number

Retailer Data

Contact in Service

Ms./Mr.

Phone number

Retailer's address/phone number
(company stamp)

Welcome to BMW

We congratulate you on your choice of a motorcycle from BMW and welcome you to the community of BMW riders.

Familiarize yourself with your new motorcycle so that you can ride it safely and confidently in all traffic situations. Please read this Rider's Manual carefully before starting to use your new BMW motorcycle. It contains important information on how to operate the controls and how to make the best possible use of all your BMW's technical features.

In addition, it contains information on maintenance and care to help you maintain your motorcycle's reliability and safety, as well as its value.

If you have questions concerning your motorcycle, your

authorized BMW Motorrad retailer will gladly provide advice and assistance.

We wish you many miles of safe and enjoyable riding

BMW Motorrad.

Table of Contents

You can also use the index at the end of this Rider's Manual to find a specific topic.

1 General instructions ...	5	3 Status indicators	19	Tires	39
Overview	6	Multifunction display	20	5 Riding	41
Abbreviations and symbols	6	Warning and indicator lights	20	Safety instructions	42
Equipment	7	General warning indicators	20	Checklist	44
Technical data	7	ABS warning indicators ^{OE}	23	Starting	44
Currentness of this manual	7	4 Operation	27	Running in	46
2 Overviews	9	Ignition switch and steering lock	28	Parking your motorcycle	47
General view, left side ...	11	Multifunction display	28	Refueling	48
General view, right side	13	Emergency ON/OFF switch	31	General brake system....	49
Underneath seat	14	Lights	31	Brake system with BMW Motorrad ABS ^{OE}	50
Left handlebar fitting	15	Headlight	32	6 Accessories	55
Handlebar fitting, right ...	16	Turn indicators	33	General instructions	56
Instrument cluster	17	Seat	33	Onboard socket ^{OE}	56
Headlight	18	Mirrors	34	7 Maintenance	59
		BMW Motorrad ABS ^{OE}	35	General instructions	60
		Chassis settings	36	Toolkit	60
		Spring preload	36	Engine oil	61
		Damping	37	General brake system....	63
				Brake pads	64
				Brake fluid	66
				Coolant	67

Clutch	69	9 Technical data.....	99	10 Service.....	113
Tires	69	Troubleshooting		BMW Motorrad	
Rims	70	chart.....	100	Service	114
Chain	70	Threaded fasteners	101	BMW Motorrad Service	
Wheels.....	71	Engine	103	Quality	114
Fuses	78	Riding specifications....	105	BMW Motorrad	
Lamps	80	Clutch	105	Service Card -	
Jump-starting	87	Transmission.....	105	On-the-	
Battery.....	88	Rear-wheel drive	106	spot breakdown	
License-plate carrier	92	Running gear.....	106	assistance	115
8 Care.....	95	Brakes	107	BMW Motorrad Service	
Care products	96	Wheels and tires.....	107	Network.....	115
Washing your motorcycle	96	Electrical system	109	Maintenance work	115
Cleaning sensitive motorcycle parts	97	Frame.....	110	Maintenance schedule.....	116
Paint care	97	Dimensions	111	Confirmation of maintenance work	117
Protective wax coating ...	98	Weights	111	Confirmation of service.....	122
Storing motorcycle	98			Reporting	
Returning motorcycle to use	98			Safety Defects.....	128

General instructions

Overview	6
Abbreviations and symbols	6
Equipment	7
Technical data	7
Currentness of this manual	7

Overview

Chapter 2 of this Rider's Manual will provide you with an initial overview of your motorcycle. All maintenance and repair work carried out on your motorcycle will be documented in Chapter 10. Proof of the maintenance work performed is a prerequisite for generous treatment of claims. Should you want to sell your BMW one day, please also remember to turn over the Rider's Manual to the new owner; it is an important part of your motorcycle.

Abbreviations and symbols



Indicates warnings you should always observe to ensure your own safety, the safety of others and to

protect your motorcycle from damage.



Special information on operating and inspecting your motorcycle as well as maintenance and adjustment procedures.

- ◀ Indicates the end of a note.
- Instruction to take action.
- » Results of an action.
- ➡ Reference to a page with additional information.
- ◁ Indicates the end of accessory or equipment-dependent information.



Tightening torque.



Technical data.

OE

Optional equipment
The desired BMW optional equipment is available only as a factory installed option.

OA

Optional accessories
BMW optional accessories can be purchased and installed at your authorized BMW Motorrad retailer.

ABS

Anti-Lock Brake System.

Equipment

When you ordered your BMW motorcycle, you chose various items of custom equipment. This Rider's Manual describes optional equipment (OE) offered by BMW and selected optional accessories (OA). This explains why the manual may also contain descriptions of equipment which you have not ordered. Please note, too, that your motorcycle might not be exactly as illustrated in this manual on account of country-specific differences.

If your BMW is equipped with options or accessories not described in this Rider's Manual, then this equipment is described in a separate operating manual.

Technical data

All dimensions, weights and outputs in the Rider's Manual refer to the Deutsche Institut für Normung e. V. (DIN) and comply with its tolerance regulations. Versions for individual countries may differ.

Currentness of this manual

The high safety and quality standards of BMW motorcycles are maintained by constant development work on designs, equipment and accessories. Because of this, your motorcycle may differ from the information supplied in the Rider's Manual. In addition, BMW Motorrad cannot guarantee the total absence of errors. We hope you will appreciate that no claims can be entertained on the basis of

the data, illustrations or descriptions in this manual.

Overviews

General view, left side	11
General view, right side	13
Underneath seat	14
Left handlebar fitting	15
Handlebar fitting, right	16
Instrument cluster	17
Headlight	18

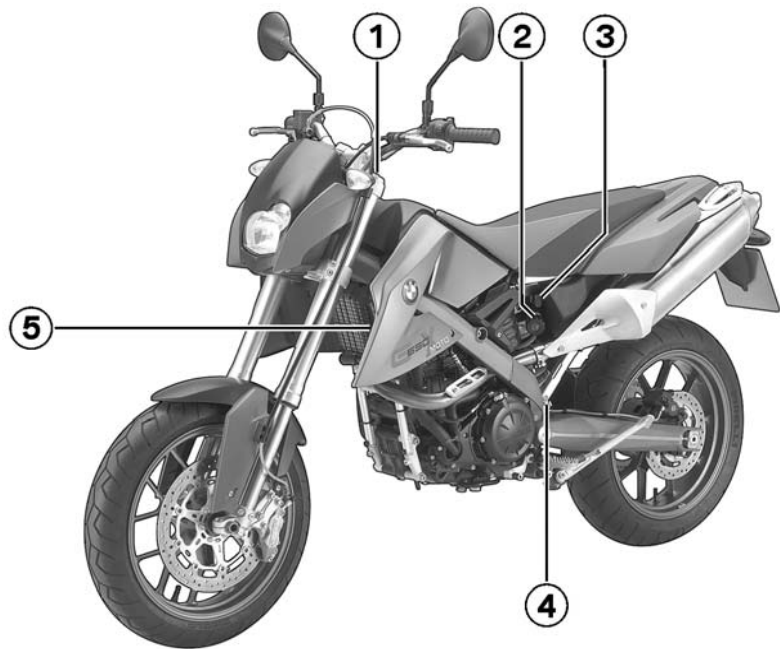

General view, left side

- 1 Adjusting front compression (➡ 37)
- 2 Adjuster, spring preload, rear (➡ 36)
- 3 Onboard socket^{OE}
(➡ 56)
- 4 Adjusting rear damping
(➡ 39)
- 5 Coolant level indicator
(➡ 67)

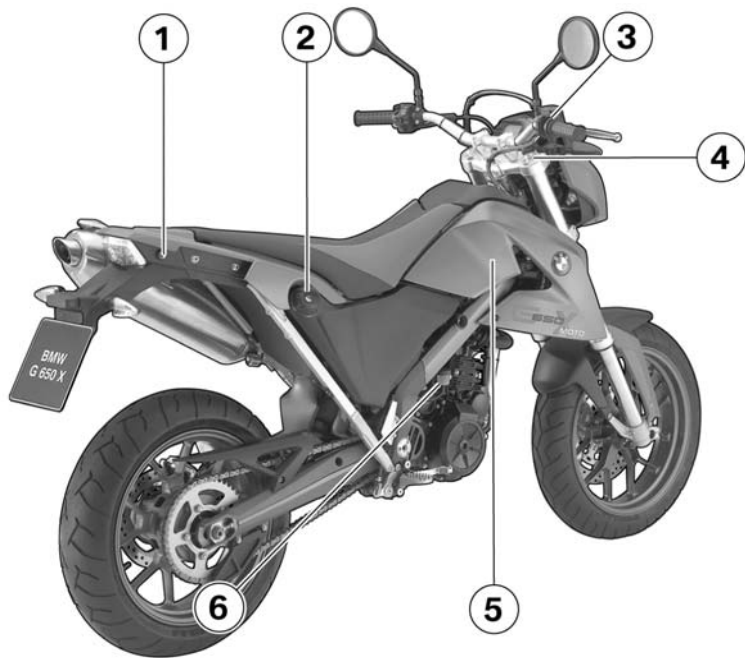

General view, right side

- 1 Seat lock (➡ 33)
- 2 Fill location for fuel (➡ 48)
- 3 Brake-fluid reservoir, front (➡ 66)
- 4 Adjustment of front rebound (➡ 38)
- 5 ABS fuses under side panel^{OE} (➡ 79)
- 6 Brake-fluid reservoir, rear (➡ 67)

Underneath seat

- 1 Toolkit (→ 60)
- 2 Rider's Manual (US Model)
- 3 Fuse box (→ 78)
- 4 Oil dipstick and engine-oil fill location (→ 61)

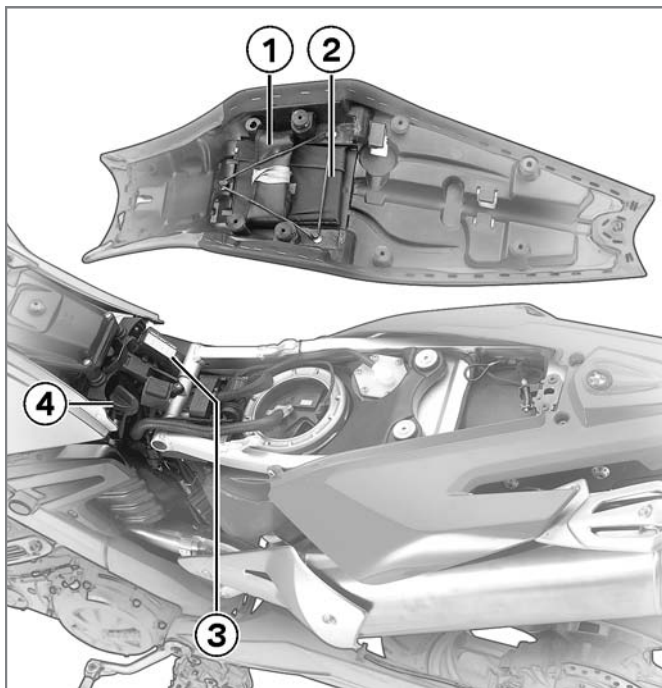

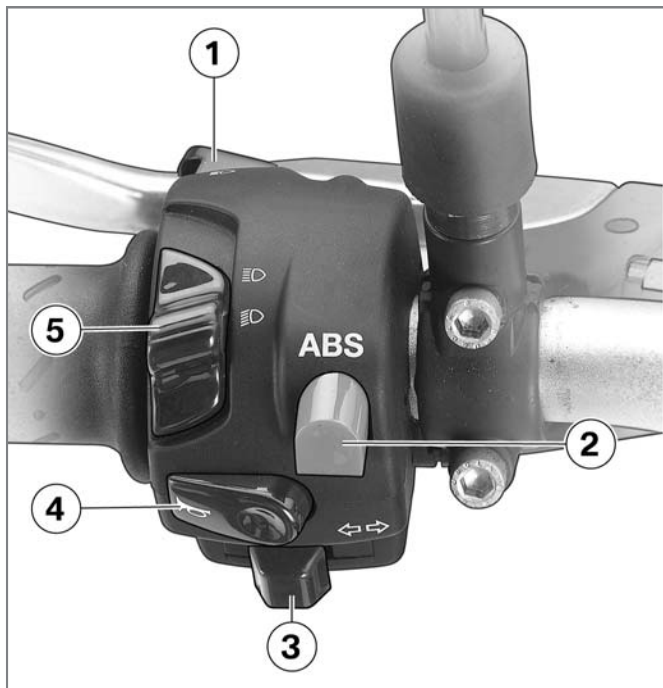

Left handlebar fitting

- 1 Headlight flasher button
- 2 ABS button^{OE} (→ 35)
- 3 Turn indicators (→ 33)
- 4 Horn button
- 5 Light switch (→ 32)

Handlebar fitting, right

- 1 Emergency ON/OFF switch (➔ 31)
- 2 Starter button (➔ 44)

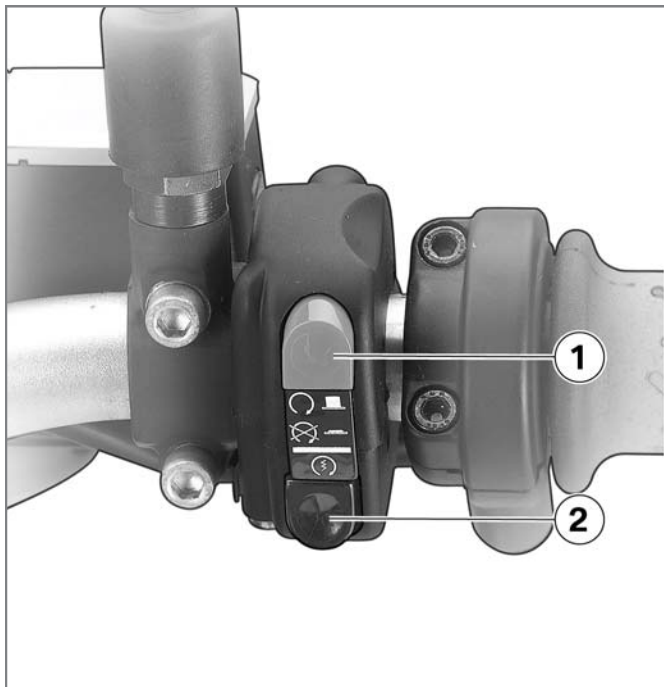

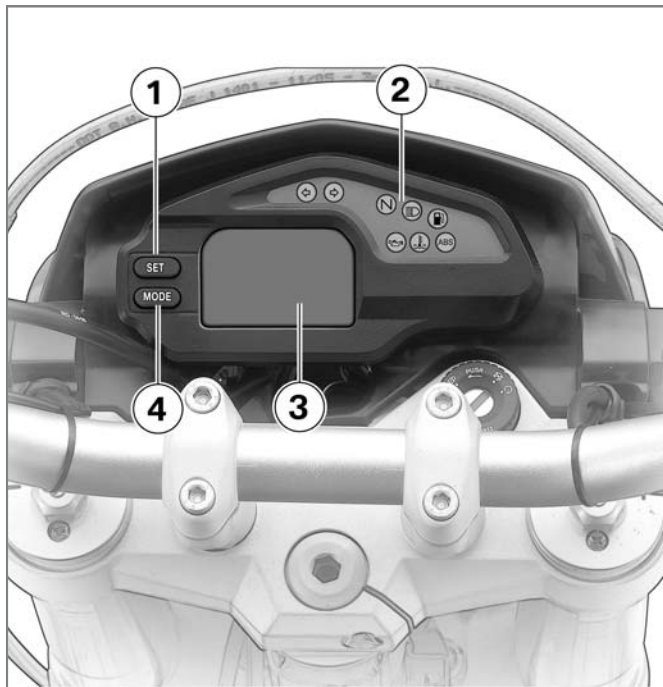

Instrument cluster

- 1 Setting clock (➡ 29)
Resetting tripmeter (➡ 29)
- 2 Warning and indicator lights (➡ 20)
- 3 Multifunction display (➡ 20)
- 4 Selecting readings (➡ 28)

Headlight

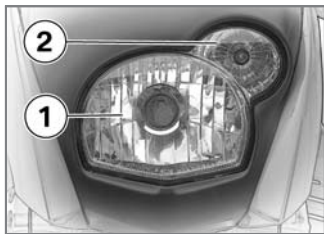

- 1 Low and high-beam
- 2 Parking lights

Status indicators

Multifunction display	20
Warning and indicator lights . . .	20
General warning indicators	20
ABS warning indicators ^{OE}	23

Multifunction display



- 1 Speedometer
- 2 Display of odometer, clock or battery voltage (⇒ 28)

Warning and indicator lights

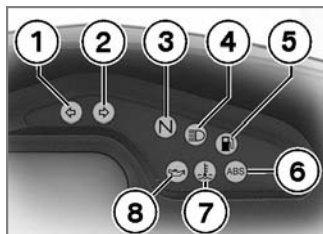

- 1 Indicator light, left turn indicator
- 2 Indicator light, right turn indicator
- 3 Indicator light, neutral
- 4 Indicator light, high-beam headlight
- 5 Fuel-reserve warning light (⇒ 22)
- 6 ABS warning light^{OE} (⇒ 23)
- 7 Coolant-temperature warning light (⇒ 23)



- 8 Engine oil-pressure warning light (⇒ 22)

General warning indicators

Display

Warnings are indicated by the corresponding warning lights.

Overview of warning indicators

		Meaning
	Lights up	Fuel down to reserve (➡ 22)
	Lights up	Engine oil pressure insufficient (➡ 22)
	Lights up	Coolant temperature too high (➡ 23)

Fuel down to reserve



Fuel-reserve warning light lights up.



A fuel shortage can lead to misfiring and to the engine dying unexpectedly. Misfiring can damage the catalytic converter, and the engine dying unexpected can lead to accidents.

Do not drive until the fuel tank is completely empty. ◀

At the most, the fuel tank still contains the reserve fuel quantity.



Reserve fuel quantity

- ≥ 2.1 quarts (≥ 2 l)

- Refueling (➡ 48)

Engine oil pressure insufficient



Engine oil-pressure warning light lights up.

The oil pressure in the lubricating oil circuit is too low. If the warning light lights up, stop immediately and switch off the engine.



The warning on insufficient engine oil pressure is no substitute for the function of an oil-level indicator. The correct engine oil level can only be checked on the oil dipstick. ◀

The cause of the warning on insufficient engine oil pressure can be an insufficient engine oil level.

- Checking engine oil level (➡ 61)

If oil level is too low:

- Topping up engine oil (➡ 63)

If the warning on insufficient engine oil pressure appears despite a correct engine oil level:



In addition to an insufficient engine oil level, other problems in the engine can lead to the warning on insufficient engine oil pressure. Continuing to ride in these cases can cause engine damage.

If this warning appears, do not continue to ride even though the engine oil level might be correct. ◀

- Do not continue driving.
- Have the malfunction corrected as soon as possible by a specialized workshop, preferably an authorized BMW Motorrad retailer.

Coolant temperature too high



Coolant-temperature warning light lights up.



Continued driving with an overheated engine can result in engine damage. Be sure to observe the measures listed below. ◀

Coolant level too low.

- Checking coolant level (➡ 67)

If coolant level is too low:

- Topping up coolant (➡ 68)

Radiator fan defective.

If the radiator fan fails to run with the coolant-temperature warning light switched on:

- Have the malfunction corrected as soon as possible by a specialized workshop, preferably an authorized BMW Motorrad retailer.

Cooling is insufficient.

- If possible, continue driving in the part-load range to cool down the engine.
- In traffic jams, switch off the engine, but keep the ignition switched on so that the radiator fan continues to operate.
- Should the coolant temperature frequently be too high, have the fault rectified as quickly as possible by a specialized workshop, preferably an authorized BMW Motorrad retailer.

ABS warning indicators^{OE}

Display



ABS warnings are indicated by the ABS warning light. The warning light can light up continuously or flash.

Overview of warning indicators

Meaning

ABS	Flashes	Self-diagnosis not completed (➡ 25)
ABS	Lights up	ABS deactivated (➡ 25)
ABS	Lights up	ABS error (➡ 25)

Self-diagnosis not completed

ABS ABS warning light flashes.

The ABS function is not available, because the self-diagnosis has not been completed. To check the wheel sensors, the motorcycle must be driven a few yards.

- Ride off slowly. It must be noted that the ABS function is not available until the self-diagnosis has been completed.

ABS deactivated

ABS ABS warning light lights up.

The ABS system has been deactivated by the driver.
with OE BMW Motorrad ABS:

- Switching on ABS function (➡ 35)

ABS error

ABS ABS warning light lights up.

The ABS control unit has detected an error. The ABS function is not available.

- Continued driving is possible. It must be noted that the ABS function is not available. Observe additional information on situations which can lead to an ABS error (➡ 52).
- Have the malfunction corrected as soon as possible by a specialized workshop, preferably an authorized BMW Motorrad retailer.

Operation

Ignition switch and steering lock	28
Multifunction display	28
Emergency ON/OFF switch	31
Lights	31
Headlight	32
Turn indicators	33
Seat	33
Mirrors	34
BMW Motorrad ABS ^{OE}	35
Chassis settings	36
Spring preload	36
Damping	37
Tires	39

Ignition switch and steering lock

Keys

You receive one master key and one spare key.

Ignition key and steering lock, seat lock and tank filler cap lock are all operated with the same key.

Switching on ignition



- Turn key to position **1**.
- » Parking lights and all function circuits switched on.
- » Engine can be started.

» Pre-ride check is performed. (➡ 45)

with OE BMW Motorrad ABS:

- Turn key to position **1**.
- » In addition to the points named above, the ABS self-diagnosis is also carried out. (➡ 46)◀

Switching off ignition

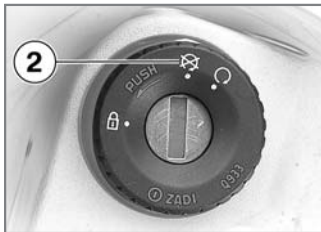

- Turn key to position **2**.
- » Light switched off.
- » Handlebars not locked.
- » Key can be removed.

Locking handlebars

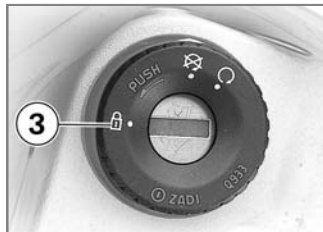

- Turn handlebars to left.
- Turn key to position **3** while moving handlebars slightly.
- » Ignition, lights and all function circuits switched off.
- » Handlebars locked.
- » Key can be removed.

Multifunction display

Selecting readings

- Switch on ignition.

▶ For longer stays in foreign countries, the display can be switched over

from miles to kilometers and vice versa. In this case, consult a specialized workshop, preferably an authorized BMW Motorrad retailer. ◀



- Press button **1**.



Each time the button is pressed, the display shows values starting with the current value in the following order:

- Total mileage (ODO)
- Tripmeter 1 (Trip I)
- Tripmeter 2 (Trip II)
- Clock
- Battery voltage

Resetting tripmeter

- Switch on ignition.
- Select desired tripmeter.

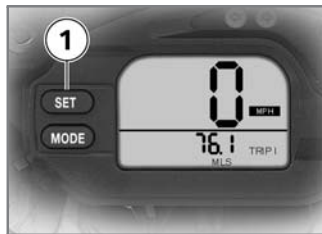

- Hold down button **1**.
» Tripmeter is reset.

Setting clock

- Switch on ignition.

 This adjustment can only be carried out with the motorcycle at a standstill. ◀

- Select clock.

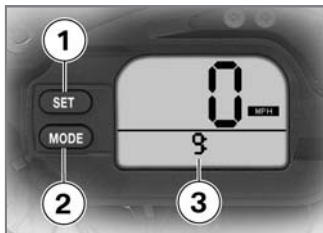

- Hold down button **1**.
- » Hours **3** are indicated.
- Press button **1**.
- » Hours increase by one each time button is pressed.
- Press button **2**.
- » Hours decrease by one each time button is pressed.

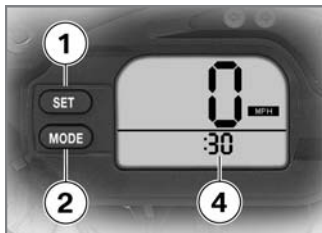

- When desired hours have been set, wait briefly.
- » Minutes **4** are indicated.
- Press button **1**.
- » Minutes increase by one each time button is pressed.
- Press button **2**.
- » Minutes decrease by one each time button is pressed.
- When desired minutes have been set, wait briefly.
- » End setting; set time is displayed.

» Setting is also ended if speed is greater than zero.

Battery voltage

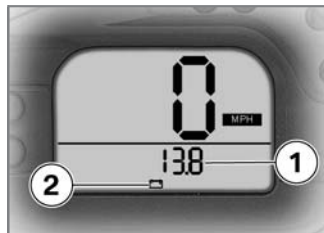

The battery voltage **1** is displayed together with the battery symbol **2**.

Emergency ON/OFF switch

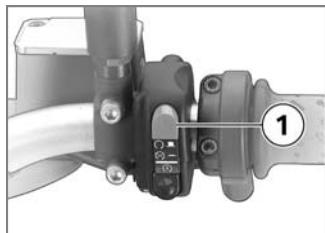

1 Emergency ON/OFF switch

 Actuating the emergency ON/OFF switch while driving can cause the rear wheel to lock up, resulting in a fall.

Do not operate the emergency ON/OFF switch while riding.◀

The engine can be switched off easily and quickly using

the emergency ON/OFF switch.

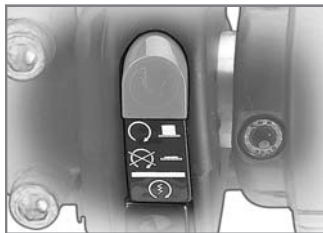

- Switch not actuated: operating position.
- Switch actuated: engine switched off.

 The engine can only be started in the operating position.◀

Lights

Parking lights

The parking lights switch on automatically when the ignition is switched on.

 The parking lights are a strain on the battery. Do not leave the ignition switched on longer than absolutely necessary.◀

Low-beam headlight

The low-beam headlights switch on automatically when the ignition is switched on.

 The low-beam headlight is a strain on the battery. Do not leave the ignition switched on longer than absolutely necessary.◀

High-beam headlight



- Push high-beam switch **1** upward.
- » High-beam headlight is switched on.
- Push high-beam switch **1** downward.
- » High-beam headlight is switched off.

Headlight flasher



- Press headlight flasher button **1**.
- » The high-beam headlight is switched on for as long as the button is pressed.

Headlight

Adjusting headlight for RHD/LHD traffic

The motorcycle is equipped with a symmetrical low-beam headlight, and can therefore also be used without modification in countries which drive on the opposite side of

the road as in the country of registration.

Headlight range and spring preload

The headlight range generally remains constant due to the adjustment of the spring preload to the loading state. Spring preload adjustment may only be insufficient when the motorcycle is very heavily loaded. In this case, the headlight range must be adjusted to the weight.

▶ If you are unsure whether the basic headlight setting is correct, consult a specialized workshop, preferably an authorized BMW Motorrad retailer.◀

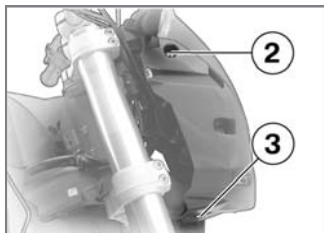

The headlight height can be adjusted with the screws **2** on the left and right below the side panels and the screw **3**. To ensure correct adjustment, it should be carried out by a specialized workshop, preferably an authorized BMW Motorrad retailer.

Turn indicators

Operating turn indicators



- Press turn indicator button **1** toward left.
 - » Left-hand turn indicator is switched on.
 - » Indicator light for left-hand turn indicator flashes.
- Press turn indicator button toward right.
 - » Right-hand turn indicator is switched on.
 - » Indicator light for right-hand turn indicator flashes.

- Press turn indicator button toward front.
 - » Turn indicator is switched off.
 - » Turn indicator lights in indicator light panel are off.

Seat

Removing seat

- Make sure ground is level and firm and park the motorcycle.

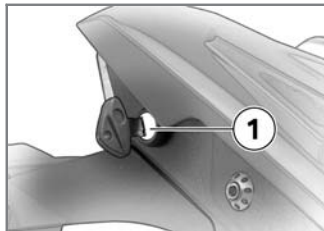

- Turn seat lock **1** counter-clockwise with ignition key and hold.

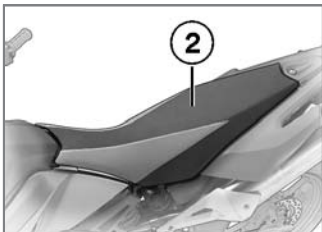

- Raise seat **2** at rear and release key.
- Remove seat.
- Place seat on a clean surface with seat surface facing downward.

Installing seat

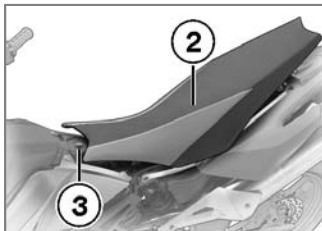

- Push seat **2** forward into mount **3**.
- Firmly press down on seat at rear.
- » The seat can be heard to lock into place.
- Check firm seating of seat.

Mirrors

Adjusting mirrors



- Move mirror into desired position by twisting.

Adjusting mirror arm

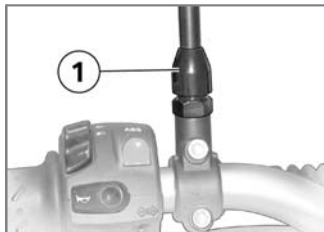

- Loosen nut **1**.

- Turn mirror arm into desired position.
- Tighten nut **1** to specified torque while holding mirror arm in place.

 Mirror union nut

– 15 lb/ft (20 Nm)

BMW Motorrad ABS^{OE}

Switchable ABS function

When driving on a loose road surface, it may be advisable to deactivate the ABS function. For this reason, the ABS function of this motorcycle can be switched off. Observe additional information on the ABS system from (➔ 50).

Switching off ABS function

- Switch on ignition or bring motorcycle to a stop.



- Hold down ABS button **1**.

ABS ABS warning light lights up; if self-diagnosis is not completed, the ABS warning light changes from flashing to being continuously lit.

- Release ABS button within five seconds after ABS warning light lights up.

 The warning indicators for ABS fault and ABS switched off are identical. ◀

» ABS function is switched off.

ABS ABS warning light continues to light up.

Switching on ABS function



- Hold down ABS button **1**.

ABS ABS warning light goes out; if self-diagnosis is not completed, the ABS warning light

changes from being continuously lit to flashing.

- Release ABS button within five seconds after ABS warning light goes out.
- » ABS warning light remains off.
- » If the ABS self-diagnosis is not completed, ABS warning light continues to flash.
- » ABS function is switched on.
- As an alternative to pressing the ABS button, the ignition can also be switched off and then on again.

▶ If the ABS light continues to light up after switching the ignition off and then on again, an ABS fault has occurred.◀

Chassis settings

Spring preload

The spring preload on the rear wheel must be adapted to the load of the motorcycle. Increase spring preload when the motorcycle is heavily loaded and reduce spring preload accordingly when the motorcycle is lightly loaded.

Damping

The damping must be adjusted to the spring preload and the road conditions. An increase in spring preload requires firmer damping, a reduction in spring preload requires softer damping.

Spring preload

Adjusting spring preload for rear wheel

 Your motorcycle's handling will suffer if you do not match the spring-preload and damping-characteristic settings.

Adjust the damping characteristic to suit the spring preload.◀

 Adjusting the spring preload while the motorcycle is being ridden can lead to accidents. Adjust the spring preload only when the motorcycle is stationary.◀

- Make sure ground is level and firm and park the motorcycle.

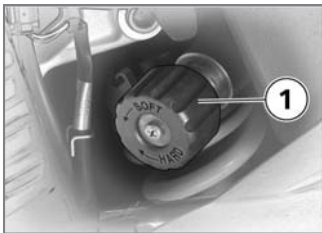

Spring-preload basic setting

- Turn adjustment wheel completely to "SOFT", then turn 10 turns toward "HARD" (Full tank of gas, with rider 187 lbs (85 kg))

Damping

Damping of telescopic forks

Both the rebound and the compression damping of the telescopic forks can be adapted to the road condition.

With the rebound, the damping during rebound is adjusted, and with compression the damping during compression. The stiffer the damping, the greater the compensating movement of the forks is damped when riding on rough

road surfaces. When soft damping is set, the forks react correspondingly faster to rough roads.

Adjusting compression on telescopic forks

- Make sure ground is level and firm and park the motorcycle.



- Adjust compression via adjusting screw **1**.

! When adjusting the handwheel, contact with the hot muffler is possible. Allow the muffler to cool down. ◀

- Adjust spring preload with handwheel **1**.
- To increase spring preload, turn handwheel in direction HARD.
- To decrease spring preload, turn handwheel in direction SOFT.



- To increase damping, turn adjusting screw in + direction with a screwdriver.
- To reduce damping, turn adjusting screw in - direction with a screwdriver.



Pressure-stage basic setting

- Turn adjusting screw as far as possible in the direction "+", then 11 clicks in the "-" direction.

Adjusting rebound on telescopic forks

- Make sure ground is level and firm and park the motorcycle.



- Adjust rebound via adjusting screw **1**.



- To increase damping, turn adjusting screw in + direction with a screwdriver.
- To reduce damping, turn adjusting screw in - direction with a screwdriver.



Rebound-stage basic setting

- Turn adjusting screw as far as possible in the direction "+", then 11 clicks in the "-" direction.

Adjusting damping on rear wheel

 The motorcycle's handling will suffer if you do not match the spring-preload and damping-characteristic settings.

Adjust the damping characteristic to suit the spring preload. ◀

- Make sure ground is level and firm and park the motorcycle.

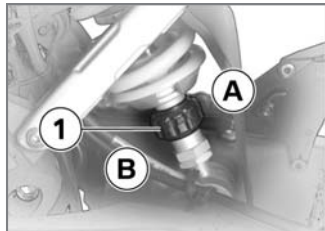

- Adjust damping with nut **1**.

- To increase damping, turn nut **1** in direction **A**.
- To decrease damping, turn nut **1** in direction **B**.

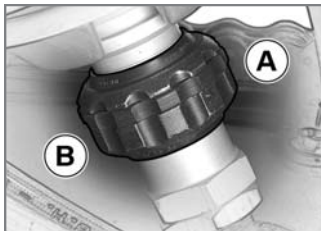

 Damping

- Turn lower adjustment wheel as far as possible in direction A, then turn 13 clicks in direction B (Full tank of gas, with rider 187 lbs (85 kg))

Tires

Checking tire pressures

 Incorrect tire pressures result in poorer handling of the motorcycle and can lead to accidents.

Ensure proper tire pressure. ◀



 At high road speeds, tire valves have a tendency to open as a result of centrifugal force.

To avoid a sudden loss of tire pressure, use a metal valve cap with a rubber sealing ring on the rear wheel and tighten it securely. ◀

 Incorrect tire pressure reduces the life of the tires.

Ensure proper tire pressure. ◀

- Check tire pressure using following data.

 Front tire pressure
– 26.1 psi (1.8 bar) (Single rider, with cold tire)
– 27.6 psi (1.9 bar) (Driver with passenger and/or load, with cold tire)
 Rear tire pressure
– 29 psi (2 bar) (Single rider, with cold tire)
– 29 psi (2 bar) (Driver with passenger and/or load, with cold tire)

In case of insufficient tire pressure:

- Correct tire pressure.

Riding

Safety instructions	42
Checklist	44
Starting	44
Running in	46
Parking your motorcycle	47
Refueling	48
General brake system	49
Brake system with BMW Motorrad ABS ^{OE}	50

Safety instructions

Rider's equipment

Do not ride without the correct clothing. Always wear:

- Helmet
- Rider's suit
- Gloves
- Boots

This applies even to short journeys, and to every season of the year. Your authorized BMW Motorrad retailer will be happy to advise you and has the correct clothing for every purpose.

Speed

If you ride at high speed, always bear in mind that various boundary conditions can adversely affect the handling of your motorcycle:

- Settings of spring–strut and shock absorber system
- Imbalanced load
- Loose clothing
- Insufficient tire pressure
- Poor tire tread
- Etc.

Correct loading



Overloading and uneven loading can diminish the riding stability of the motorcycle.

Do not exceed the gross weight limit and observe the loading information. ◀

Alcohol and drugs



Even small amounts of alcohol or drugs will adversely affect your perception and your ability to assess situations and make decisions, and slow down your reflexes.

Medication can exacerbate these effects.

Do not ride your motorcycle after consuming alcohol, drugs and/or medication. ◀

Risk of poisoning

Exhaust fumes contain carbon monoxide, which is colorless and odorless but highly toxic.



Inhaling exhaust fumes therefore represents a health hazard and can even cause loss of consciousness with fatal consequences. Do not inhale exhaust fumes. Do not run the engine in closed rooms. ◀

High voltage



Touching live parts of the ignition system with the engine running can cause electric shock.

Do not touch parts of the ignition system when the engine is running. ◀

Catalytic converter

If misfiring causes unburned fuel to enter the catalytic converter, there is a danger of overheating and damage.

For this reason, observe the following points:

- Do not run the fuel tank dry
- Do not run the engine with the spark-plug cap removed
- Stop the engine immediately if it misfires
- Use unleaded fuel only
- Comply with all specified maintenance intervals.

 Unburned fuel will destroy the catalytic converter.

Note the points listed for

protection of the catalytic converter. ◀

Risk of fire

Temperatures at the exhaust are high.

 Flammable materials (e.g. hay, leaves, grass, clothing and luggage, etc.) could ignite if allowed to come into contact with the hot exhaust pipe.

Make sure that no highly flammable materials can come in contact with the hot exhaust system. ◀

 Cooling would be inadequate if the engine were allowed to idle for a lengthy period with the motorcycle at a standstill: overheating would result. In extreme cases, the motorcycle could catch fire. Do not allow the engine to

idle unnecessarily. After starting, ride off immediately. ◀

Tampering with the control unit of the electronic engine-management system

 Modification of the engine-electronics control unit can lead to damage to the motorcycle, and therefore to accidents.

Do not modify the engine-electronics control unit. ◀

 Tampering with control unit of electronic engine-management system can result in mechanical loads that the motorcycle's components are not designed to withstand. Damage caused in this way is not covered by the warranty.

Do not modify the engine-electronics control unit. ◀

Checklist

Use the following checklist to check important functions, settings and wear limits before you ride off.

- Brakes
- Front and rear brake fluid levels
- Clutch
- Shock absorber setting and spring preload
- Tread depth and tire pressure
- Secure luggage attachment

At regular intervals:

- Engine oil level (every time you refuel)
- Brake pad wear (during every third stop for refueling)

Starting

Side stand

You cannot start the motorcycle with the side stand extended and a gear engaged. The engine will switch itself off if you start it with the transmission in neutral and then engage a gear before retracting the side stand.

Transmission

You can start the engine when the transmission is in neutral or if you pull the clutch with a gear engaged.

Starting engine

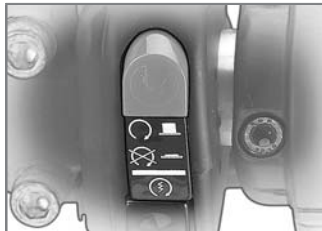

- Emergency ON/OFF switch in operating position.



Transmission lubrication is only ensured when the engine is running. Insufficient lubrication can lead to transmission damage.

Do not allow the motorcycle to roll for longer periods or push it over longer distances with the engine switched off. ◀

- Switch on ignition.
- » Pre-ride check is performed. (➡ 45)

with OE BMW Motorrad ABS:

- Switch on ignition.
 - » Pre-ride check is performed. (➡ 45)
 - » ABS self-diagnosis is performed. (➡ 46)◀
- Wait until coolant-temperature warning light no longer flashes if necessary.

▶ After the ignition is switched on, the idling positioner is positioned. If positioning takes longer than the pre-ride check, this is signaled by the coolant-temperature warning light flashing. You should wait for this procedure to be completed to avoid problems during driving.◀

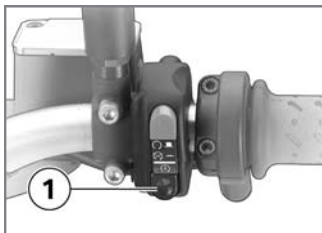

- Press starter button **1**.

▶ At extremely low temperatures it may be necessary to operate the throttle twist grip during starting. At ambient temperatures below 32 °F (0 °C), actuate the clutch after switching on the ignition.◀

▶ If the engine fails to start although the starter turns, insufficient battery voltage may be the reason. Recharge the battery before you start the engine, or use

jump leads and a donor battery to start.◀

- » Engine starts.
- » Consult the troubleshooting chart if the engine refuses to start. (➡ 100)

Pre-ride check

After the ignition is switched on, the instrument cluster conducts a test of the warning and indicator lights and the display. This is the so-called pre-ride check.

Phase 1

All warning and indicator lights and all segments of the multifunction display are switched on for a short time.

Phase 2

The tire parameters stored in the instrument cluster are displayed for a short time.

Then the instrument cluster assumes normal operation. If one of the specified warning and indicator lights was not switched on, or if not all segments of the multifunction display are switched on:



If it was not possible to switch on the warning lights, possible malfunctions cannot be indicated.

Watch all warning and indicator lights on the display. ◀

- Have the malfunction corrected as soon as possible by a specialized workshop, preferably an authorized BMW Motorrad retailer.

ABS self-diagnosis^{OE}

The readiness for operation of the BMW Motorrad ABS is checked by the self-diagnosis. Self-diagnosis is performed automatically when you switch on the ignition. To

check the wheel sensors, the motorcycle must be driven a few yards.

Phase 1

- » Checking the diagnosable system components while stopped.



ABS warning light flashes.

Phase 2

- » Checking the wheel sensors while starting off.



ABS warning light flashes.

ABS self-diagnosis completed

- » The ABS warning light goes out.

If an ABS fault is indicated after the ABS self-diagnosis is completed:

- Continued driving is possible. It must be noted

that the ABS function is not available.

- Have the malfunction corrected as soon as possible by a specialized workshop, preferably an authorized BMW Motorrad retailer.

Running in

The first 600 miles (1,000 km)

- While running in the motorcycle, vary the throttle opening and engine-speed range frequently.
- Try to do most of your riding during this initial period on twisting, fairly hilly roads, avoiding high-speed main roads and highways if possible.



Exceeding the specified engine speeds while running in will lead to increased engine wear.

Adhere to the specified engine run-in speeds. ◀

- Do not exceed gear-dependent top speeds during break-in period.

 Top speeds during break-in period
- 22 mph (35 km/h) (1st gear)
- 34 mph (55 km/h) (2nd gear)
- 47 mph (75 km/h) (3rd gear)
- 59 mph (95 km/h) (4th gear)
- 68 mph (110 km/h) (5th gear)

- Do not accelerate at full throttle.
- Avoid low engine speeds at full load.

- After 300 – 750 miles (500 – 1,200 km), have the first inspection performed.

Brake pads

New brake pads must "bed down" and therefore do not achieve their optimum friction levels during the first 300 miles (500 km). This initial reduction in braking efficiency can be compensated for by exerting greater pressure on the levers.

- ⚠ New brake pads can extend stopping distance by a significant margin. Brake early. ◀

Tires

New tires have a smooth surface. This must be roughened by riding in a restrained manner at various heel angles until the tires are run in. This running in procedure is

essential if the tires are to achieve maximum grip.

- ⚠ New tires have not achieved their full adhesion yet. There is a danger of accidents when driving at extreme angles. Avoid extreme angles. ◀

Parking your motorcycle

Placing on side stand

- ⚠ If the ground is soft or uneven, there is no guarantee that the motorcycle will rest firmly on the stand. Always check that the ground under the stand is level and firm. ◀

- Switch off the engine.
- Pull handbrake lever.
- Hold motorcycle upright and balanced.

- Use your left foot to extend side stand fully.

 The side stand is designed to support only the weight of the motorcycle. Do not lean or sit on the motorcycle with the side stand extended. ◀

- Slowly lean the motorcycle to side until its weight is taken by stand and dismount to left.

 When you prop the motorcycle on the side stand, the surface of the ground will determine whether it is better to turn the handlebars to the left or right. However, the motorcycle is more stable on a level surface with the handlebars turned to the left than with the handlebars turned to the right. On level ground, always turn

the handlebars to the left to set the steering lock. ◀

- Turn handlebars to full left or right lock position.
- Check that motorcycle is standing firmly.

 On a grade, the motorcycle should always face uphill; select 1st gear. ◀

Remove from side stand

- Unlock steering lock.
- Switch on ignition.
- From left, grip handlebars with both hands.
- Pull handbrake lever.
- Swing your right leg over the seat and lift motorcycle to upright position.
- Hold motorcycle upright and balanced.

 An extended side stand can catch on the ground when the motorcycle is moving and lead to a fall.

Retract the side stand before moving the vehicle. ◀

- Sit on motorcycle and use your left foot to retract side stand.

Refueling

 Fuel is highly flammable. Fire at the fuel tank can result in fire and explosion. Do not smoke. Never bring a naked flame near the fuel tank. ◀

 Fuel expands when exposed to heat. When the tank is overfilled, fuel can escape and get onto the rear wheel. This results in a danger of falling. Do not fill the tank past the bottom edge of the filler neck. ◀

 Fuel attacks plastic surfaces, making them cloudy or unattractive. Wipe off any fuel that gets on to plastic parts immediately. ◀

 Leaded fuel will destroy the catalytic converter. Use only unleaded fuel. ◀

- Make sure ground is level and firm and park the motorcycle.

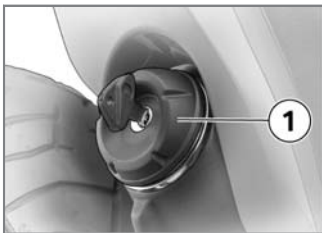

- Open fuel tank cap **1** with ignition key by turning counterclockwise.
- Remove fuel tank cap.

- Refuel with quality listed below at most until lower edge of filler neck is reached.



Recommended fuel type

– 95 ROZ/RON (Super unleaded)



Usable fuel quantity

– 2.6 gal (10 l)



Reserve fuel quantity

– ≥ 2.1 quarts (≥ 2 l)

- Mount fuel tank cap.
- Close fuel tank cap with ignition key by turning clockwise.

General brake system

Descending mountain passes

 There is a danger of the brakes fading if you use only the rear brakes when descending mountain passes. Under extreme conditions, the brakes could overheat and suffer severe damage. Use both front and rear brakes, and make use of the engine's braking effect as well. ◀

Wet brakes

 After the motorcycle has been washed, ridden through water or ridden in the rain, the brake disks and pads might be wet and the brakes might not take effect immediately. Brake early until the brakes are dry or braked until dry. ◀

Salt on brakes

 The full braking effect can be delayed if the motorcycle is ridden on salt-covered roads and the brakes are not applied for some time. Brake early until the salt layer of the brake disks and brake pads has been braked off. ◀

Oil or grease on brakes

 Oil and grease on the brake disks and pads considerably diminish braking efficiency. Especially after repair and maintenance tasks, make sure that the brake disks and brake pads are free of oil and grease. ◀

Dirt or mud on brakes

 When the motorcycle is ridden on loose surfaces or muddy roads, the brakes may fail to take effect immediately because of dirt or moisture on the disks or brake pads. Brake early until the brakes are braked clean. ◀

 Driving on unpaved or dirty roads leads to increased brake pad wear. Check the brake pad thickness more often and replace the brake pads sooner. ◀

Brake system with BMW Motorrad ABS^{OE}

How does ABS work?

The maximum braking force that can be transferred to the road surface is partially dependent on the friction coefficient of the road surface. Gravel, ice, snow and wet roads offer a considerably poorer friction coefficient than a dry, clean asphalt surface. The poorer the friction coefficient of the road surface is, the longer the braking distance will be.

If the maximum transferrable braking force is exceeded when the driver increases the brake pressure, the wheels begin to block and driving stability is lost, and a fall can result. Before this situation occurs, ABS intervenes and

adjusts the brake pressure to the maximum transferrable braking force. This enables the wheels to continue to turn and maintains driving stability regardless of the road surface condition.

What happens when rough roads are encountered?

Bumpy or rough roads can briefly lead to a loss of contact between the tires and the road surface, until the transferrable braking force is reduced to zero. If braking is carried out in this situation, ABS must reduce the brake pressure to ensure driving stability when restoring contact to the road. At this point in time, the BMW Motorrad ABS must assume extremely low friction coefficients (gravel, ice, snow)

so that the running wheels turn in every imaginable case and the driving stability is ensured. After detecting the actual conditions, the system adjusts the optimum brake pressure.

How is the shortest braking distance achieved?

The dynamic load distribution between the front and rear wheel changes during braking. The heavier you brake, the more the front wheel is loaded. The greater the wheel load, the more braking force can be transferred.

To achieve the shortest braking distance, actuate the front and rear brake. The front brake must be actuated rapidly and with increasing force to optimally utilize the dynamic load increase on

the front wheel. At the same time, the clutch should also be actuated. With the "forced braking" often practiced in which the brake pressure is generated as quickly as possible and with great force, the dynamic load distribution cannot follow the increased deceleration and the braking force cannot be completely transferred to the road surface. To prevent the front wheel from locking, the ABS system must intervene and reduce the brake pressure; the braking distance increases.

Reserves for safety

But remember: the potentially shorter braking distances which BMW Motorrad ABS permits must not be used as an excuse for careless riding. ABS is primarily a means of

ensuring a safety margin in genuine emergencies.

Take care when cornering. When you apply the brakes on a corner, the motorcycle's weight and momentum take over and even BMW Motorrad ABS is unable to counteract their effects.

Rear wheel lift

Even during severe braking, a high level of tire grip can mean that the front wheel does not lock up until very late, if at all. Consequently, ABS does not intervene until very late, if at all. Under these circumstances the rear wheel can lift off the ground, and the outcome can be a highsiding situation in which the motorcycle can flip over.



Severe braking can cause the rear wheel to lift off the ground.

When braking, bear in mind that the ABS control cannot be relied on in all circumstances to prevent the rear wheel from lifting off the ground. ◀

What are the design characteristics of the BMW Motorrad ABS?

The BMW Motorrad ABS ensures driving stability on any surface within the limits of driving physics. The system is not optimized for special requirements resulting under extreme weather conditions offroad or on the racetrack.

Special situations

To detect the tendency of the wheels to lock up, the speeds of the front and rear wheel are compared. If implausible values are detected over a longer period of time, the ABS

function is deactivated for safety reasons and an ABS fault is indicated. The condition for a fault message is the completed self-diagnosis. In addition to problems on the BMW Motorrad ABS, unusual driving conditions can also lead to a fault message.

Unusual driving conditions:

- Driving on the rear wheel (wheely) for a longer period.
- Rear wheel spinning in place with front brake pulled (burn out).
- Heating up on an auxiliary stand at idle or with gear engaged.
- Locked-up rear wheel for a longer period of time, e.g. when riding downhill offroad.

Should a fault message result due to one of the driving conditions described above, the

ABS function can be reactivated by switching the ignition off and then on again.

How important is regular maintenance?



Any technical system is always only as good as its maintenance condition.

To ensure that the BMW Motorrad ABS is in an optimally maintained condition, it is vital that the specified inspection intervals be complied with. ◀

Accessories

General instructions	56
Onboard socket ^{OE}	56

General instructions

BMW Motorrad recommends the use of parts and accessories for your motorcycle that are approved by BMW for this purpose.

Your authorized BMW Motorrad retailer is the right place to go for genuine BMW parts and accessories, other BMW –approved products, and expert advice on their installation and use.

These parts and products have been tested by BMW for safety, function and suitability. BMW accepts product liability for these products.

Conversely, BMW is unable to accept any liability whatsoever for parts and accessories which it has not approved.



BMW Motorrad cannot examine or test each product of outside origin to

ensure that it can be used on or in connection with BMW motorcycles without constituting a safety hazard. Nor is this guarantee provided when the official approval of a specific country has been granted. Tests conducted by these instances cannot make provision for all operating conditions experienced by BMW motorcycles and, consequently, they are not sufficient in some circumstances. Use only parts and accessories approved by BMW for your motorcycle. ◀

Whenever you are planning modifications, comply with all the legal requirements. The motorcycle must not infringe on national road–vehicle construction and use regulations.

Onboard socket^{OE} Ratings



The load of the onboard socket **1** may not exceed the value specified in the technical data.

Operating electrical accessories

The operation of additional devices is a strain on the battery. The starting capacity of the battery must be maintained.

Cable routing

The cables from the onboard socket to the auxiliary device must be routed in such a way that they:

- Do not impede the rider
- Do not restrict or obstruct the steering angle and handling characteristics
- Cannot be trapped



Improperly routed cables can impede the rider.

Route the cables as described above. ◀

Maintenance

General instructions	60
Toolkit	60
Engine oil	61
General brake system	63
Brake pads.....	64
Brake fluid	66
Coolant	67
Clutch	69
Tires	69
Rims	70
Chain	70
Wheels	71
Fuses	78
Lamps	80
Jump-starting	87

Battery.....	88
License-plate carrier.....	92

General instructions

The 'Maintenance' chapter describes work involving the checking and replacement of wear parts that can be performed with a minimum of effort.

If special tightening torques are to be taken into account for assembly, these are listed. An overview of all required tightening torques is contained in the chapter "Technical Data".

Information on additional maintenance and repair work is provided in the Repair Manual for your motorcycle on CD/DVD-ROM (RepROM), which you can obtain from your authorized BMW Motorrad retailer.

Toolkit

Standard onboard toolkit

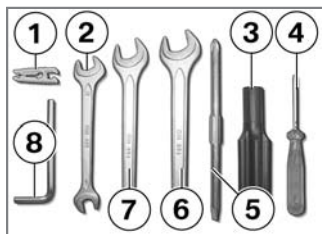

1 Fuse clip

– Replacing fuses

2 Open-ended wrench, 8/10 mm

– Adjusting chain tension

3 Screwdriver handle

– Screwdriver handle

4 Screwdriver, small

– Replacing turn indicator bulbs

5 Screwdriver blade

– Phillips and straight blade

6 Open-ended wrench, 15 mm

– Adjusting mirror arm

7 Open-ended wrench, 14 mm

– Adjusting mirror arm

8 Allen key, 4 mm

– Removing and installing body panels

Onboard-toolkit service set

Your BMW Motorrad retailer offers the onboard-toolkit service set for additional work.

Information on conducting this work is provided in the Repair Manual on DVD/CD-ROM (RepROM), which is al-

so available from your BMW Motorrad retailer.

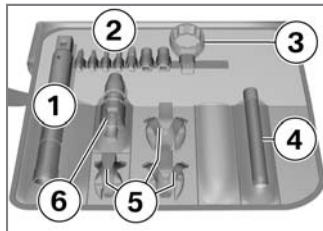

1 Pull-out tool holder

- Holding of all tools with adapter

2 Bits, 1/4"

- Phillips
- Straight blade
- Adapter 1/4" hexagon to 1/4" square
- 2x hexagon socket wrench insert, removing and installing front wheel

- Allen screw 3 mm, replacing headlight bulb
- Allen key, 4 mm, removing and installing fairings
- Allen screw 6 mm, adjusting headlight height

3 Box wrench, 27 mm

- Removing and installing wheels

4 Flashlight

- LED technology

5 3x Socket wrench

- Adjusting chain tension

6 Adapter

- Mounting for 1/4" bits
- 9x12 mm and 3/8" jointed adapter

Engine oil

Checking engine oil level

 The engine can seize if the oil level is low, and this can lead to accidents. Always make sure that the oil level is correct. ◀

 The oil level varies with the temperature of the oil. The higher the temperature, the higher the level of oil in the sump. Checking the oil level with the engine cold or after a short trip leads to misinterpretations and therefore to incorrect oil fill quantities. To ensure that the display of the engine oil level is correct, only check the oil level after a longer trip. ◀

- Make sure the ground is level and firm and hold motorcycle at operating temperature vertically.

- Allow engine to idle until fan starts up, then allow to continue running for an additional minute.
- Switch off the engine.
- Wipe area around oil fill location clean.

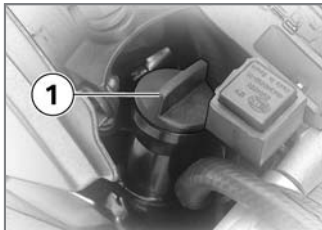

- Remove cap from oil fill location **1** by turning counter-clockwise.

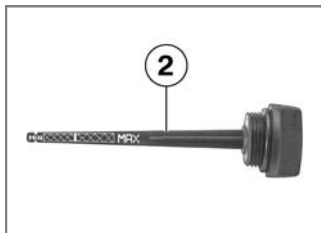

- Clean oil dipstick **2** with a dry cloth
- Install oil dipstick.
- Remove oil dipstick and read off oil level.

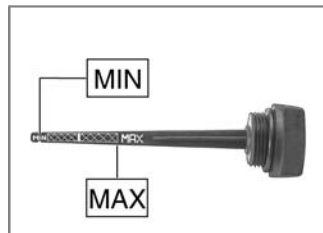

Specified level of engine oil

– between MIN and MAX marking

If oil level is below MIN mark:

- Topping up engine oil (➔ 63)

If the oil level is above the MAX mark:

- Have oil level corrected by a specialized workshop, preferably an authorized BMW Motorrad retailer.

Topping up engine oil

! Both too little and too much engine oil can lead to engine damage. Always make sure that the oil level is correct. ◀

- Wipe area around fill location clean.

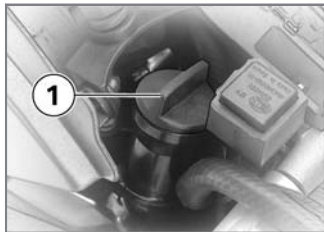

- Remove cap of oil fill location **1**.

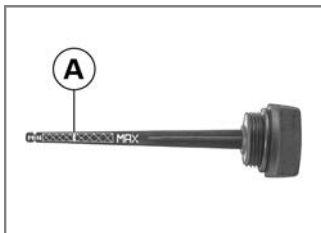

- Add engine oil up to marking **A**.
- To check the oil level, screw the oil dipstick in and then out again.
- Install cap of oil fill location.

General brake system

Brake safety

A properly functioning brake system is a basic requirement for the road safety of your motorcycle.

Do not ride the motorcycle if you have any doubts about

the dependability of the brake system.

In this case, have the brake system checked by a specialized workshop, preferably by an authorized BMW Motorrad retailer.

! Incorrect working practices endanger the reliability of the brakes. Have all work on the brake system performed by a specialized workshop, preferably by an authorized BMW Motorrad retailer. ◀

Checking brake operation

- Pull handbrake lever.
 - » Pressure point must be clearly perceptible.
- Press footbrake lever.
 - » Pressure point must be clearly perceptible.

If no clear pressure points are perceptible:

- Have the brakes checked by a certified workshop, preferably an authorized BMW Motorrad retailer.

Brake pads

Checking front brake pad thickness

 Brake pads worn past the minimum permissible thickness can impair braking efficiency and under certain circumstances they can cause damage to the brake system.

In order to ensure the operating reliability of the brake system, make sure that the brake pads are not worn beyond their minimum thickness. ◀

- Make sure ground is level and firm and park the motorcycle.



- Check the brake pad thickness with visual inspection. Direction of view: between wheel and fork tube at brake caliper.

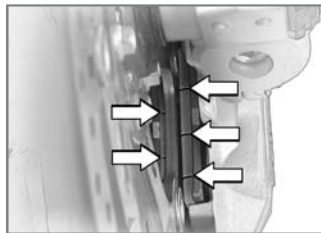

Front brake-pad wear limit

- 0.04 in (1 mm) (Only friction material without carrier plate)
- Wear markings (grooves) must be clearly visible.

If the wear indicating marks are no longer clearly visible:

- Have the brake pads replaced by a specialized workshop, preferably an authorized BMW Motorrad retailer.

Checking rear brake pad thickness

 Brake pads worn past the minimum permissible thickness can impair braking efficiency and under certain circumstances they can cause damage to the brake system.

In order to ensure the operating reliability of the brake system, make sure that the brake pads are not worn beyond their minimum thickness. ◀

- Make sure ground is level and firm and park the motorcycle.

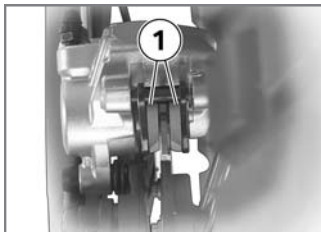

- Check thickness of rear brake pads **1** with visual inspection from behind.

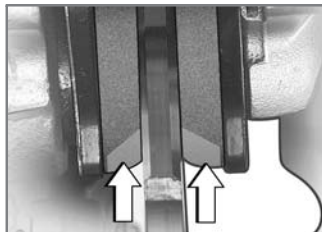

 Rear brake-pad wear limit

– 0.04 in (1 mm) (Only friction material without carrier plate)

– Wear indicators must be clearly visible.

If the wear indicating marks are no longer visible:

- Have brake pads replaced by a specialized workshop, preferably an authorized BMW Motorrad retailer.

Brake fluid

Checking front brake fluid level

 A low fluid level in the brake reservoir can allow air to penetrate the brake system. This significantly reduces braking efficiency. Check brake fluid level regularly. ◀

- Make sure the ground is level and firm and hold the motorcycle vertically.
- Move handlebars into straight-ahead position.



- Read off brake fluid level at front brake–fluid reservoir **1**.

 The brake fluid level in the brake–fluid reservoir drops due to brake pad wear. ◀

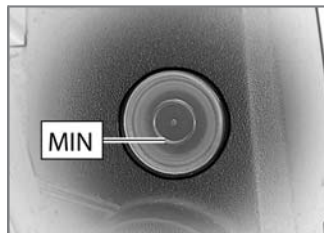

Front brake fluid level

– Brake fluid DOT4

– The brake fluid level must not fall below the MIN mark. (Brake-fluid reservoir horizontal)

If brake fluid level drops below permissible level:

- Have defect corrected as soon as possible by a specialized workshop, preferably an authorized BMW Motorrad retailer.

Checking rear brake fluid level

 A low fluid level in the brake reservoir can allow air to penetrate the brake system. This significantly reduces braking efficiency. Check brake fluid level regularly. ◀

- Make sure the ground is level and firm and hold the motorcycle vertically.

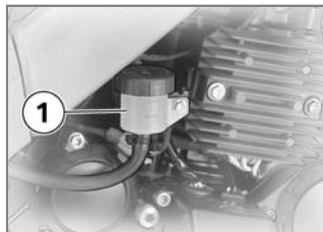

- Read off brake fluid level at rear brake–fluid reservoir **1**.

 The brake fluid level in the brake–fluid reservoir drops due to brake pad wear. ◀



Rear brake fluid level

– Brake fluid DOT4

– The brake fluid level must not fall below the MIN mark. (Brake-fluid reservoir horizontal)

If brake fluid level drops below permissible level:

- Have defect corrected as soon as possible by a specialized workshop, preferably an authorized BMW Motorrad retailer.

Coolant

Checking coolant level

- Make sure the ground is level and firm and hold the motorcycle vertically.



- Check coolant level on scale **1** of coolant expansion tank.

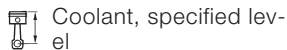
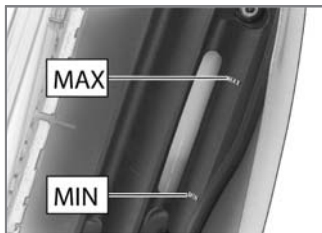

– between MIN and MAX marks on expansion tank

If coolant level is too low:

- Add coolant.

If coolant level is too high:

- Contact a specialized workshop, preferably an authorized BMW Motorrad retailer.

Topping up coolant



- Pull out radiator cap cover **1** toward front.



- Open cap of coolant expansion tank **2**.

- Pour in coolant up to specified level.
- Close cap of coolant expansion tank.

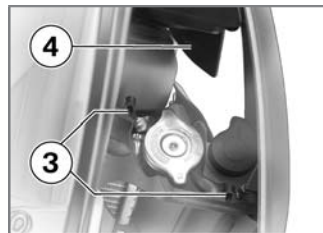

- Insert radiator cap cover in holders **3**. When doing so, guide the upper edge of the cover behind the lower edge of the center fairing panel **4**.

Clutch

Checking clutch lever play

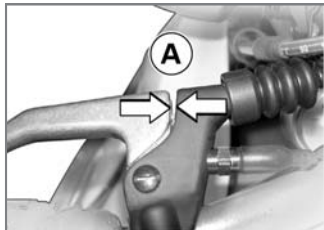

- Pull clutch lever until resistance is felt.
- Measure clutch lever play **A**.



Clutch lever play

– 0.04...0.08 in (1...2 mm)

If clutch lever play is outside tolerance:

- Adjusting clutch (➔ 69)

Adjusting clutch

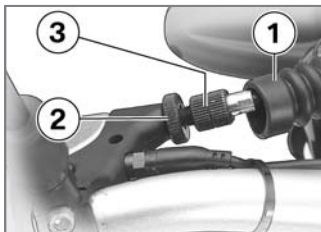

- Push back bellows **1**.
- Loosen lock nut **2**.
- Adjust clutch lever play to setpoint setting with adjusting screw **3**.
 - » Turn clockwise: clearance is increased.
 - » Turn counterclockwise: clearance is reduced.
- Checking clutch lever play (➔ 69)
- Tighten lock nut **2**.
- Pull bellows **1** over adjusting screw.

Tires

Checking tire tread depth

 The handling of your motorcycle can already change for the worse before the legally prescribed minimum tread depth is reached. Have tires replaced even before the minimum tread depth is reached. ◀

- Make sure ground is level and firm and park the motorcycle.
- Measure tire tread depth in main tread grooves with wear indicating marks.

 Tires have wear indicators integrated into the main tread grooves. If the tire tread has worn down to the level of the marks, the tire is completely worn. The locations of the marks are indi-

cated on the edge of the tire, e.g. by the letters TI, TWI or by an arrow. ◀

If the tire tread depth no longer complies with the legally required minimum tread depth:

- Replace tire.

Rims

Checking rims

- Make sure ground is level and firm and park the motorcycle.
- Visually inspect rims for defects.
- Have damaged rims checked and, if necessary, replaced by a specialized workshop, preferably an authorized BMW Motorrad retailer.

Chain

Checking chain tension

- Make sure ground is level and firm and park the motorcycle.

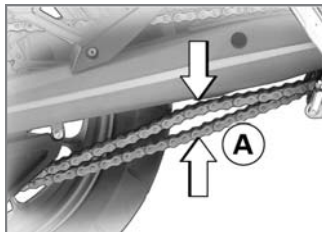

- Press chain upward and downward using a screwdriver and measure difference **A**.



Chain sag

– 1 in (25 mm) (Motorcycle unladen on auxiliary stand)

If the measured value is outside the permissible tolerance:

- Adjusting chain tension (→ 70)

Adjusting chain tension

- Make sure ground is level and firm and park the motorcycle.

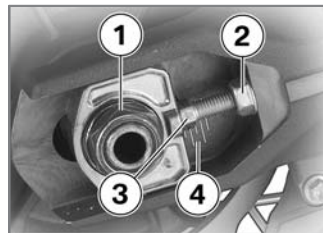

- Loosen quick-release axle nut **1**.
- Loosen lock nuts **2** on left and right by turning counterclockwise.

- Adjust chain tension with adjusting screws **3** on left and right.
 - » Turning clockwise: chain tension is reduced.
 - » Turning counterclockwise: chain tension is increased.
- Checking chain tension (→ 70)
- Make sure that the same scale value **4** is set on the left and right.
- Tighten lock nuts **2** on left and right by turning clockwise.



Locknut of drive-chain tensioning screw

– 18 lb/ft (25 Nm)

- Tighten quick-release axle nut **1** with specified torque.



Nut on rear quick-release axle

– 59 lb/ft (80 Nm)

Checking chain wear

- Make sure ground is level and firm and park the motorcycle.

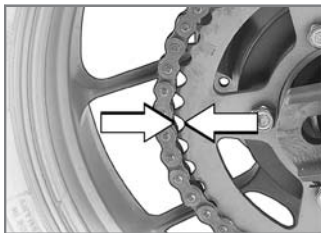

- Pull chain toward rear at rear—most point of chain sprocket.
 - » The tooth tips must still be within the chain links.

If the chain can be pulled off beyond the tooth tips:

- Please contact a specialized workshop, preferably an authorized BMW Motorrad retailer.

Wheels

Recommended tires

For every size of tire, BMW Motorrad has tested and approved certain makes as roadworthy. BMW Motorrad cannot evaluate the suitability of other tires, and can therefore take no responsibility for their driving safety.

BMW Motorrad recommends only using the tires tested and approved by BMW Motorrad. Extensive information is available at your authorized BMW Motorrad retailer or on the Internet at www.bmw-motorrad.com.

Removing front wheel

- Make sure ground is level and firm and park the motorcycle.

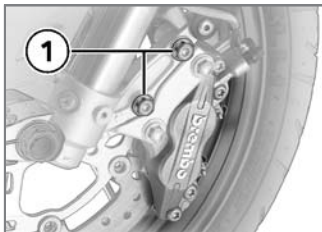

- Remove securing screws **1** of brake caliper.

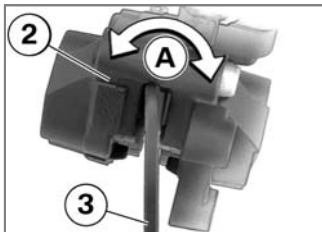

- Press brake pads in brake caliper **2** apart slightly by rocking back and forth **A** in relation to brake disks **3**.

- Mask off parts of wheel rim that could be scratched when removing brake caliper.

 Once the calipers have been removed, there is a risk of the brake pads being pressed together to the extent that they cannot be slipped back over the brake disk on reassembly. Do not operate the handbrake lever when the brake calipers have been removed.◀

- Carefully pull brake caliper back and out until clear of brake disks.

with OE BMW Motorrad ABS:

- When pulling off left brake caliper, make sure that ABS sensor cable is not damaged.◀

- Place motorcycle on suitable auxiliary stand.
- with OE BMW Motorrad ABS:

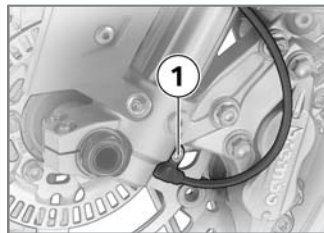

- Remove screw **1** of ABS sensor and take ABS sensor out of holder.◀

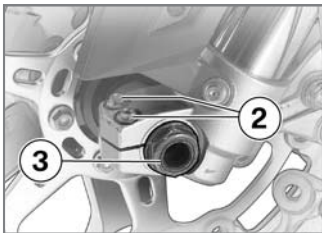

- Unscrew left-hand axle clamping screws **2**.
- Remove axle screw **3**.

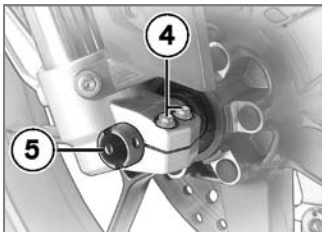

- Unscrew right-hand axle clamping screws **4**.
- Press axle **5** inward from left until it protrudes from

clamping on right-hand side.

- Pull out axle using a screwdriver.
- Do not remove grease on axle.

! Once the calipers have been removed, there is a risk of the brake pads being pressed together to the extent that they cannot be slipped back over the brake disk on reassembly. Do not operate the handbrake lever when the brake calipers have been removed. ◀

- Roll front wheel out of the forks.

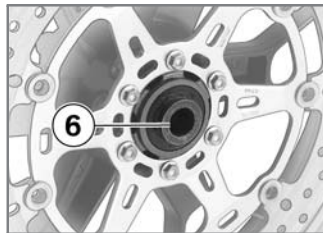

- Remove left-hand spacer sleeve **6**.

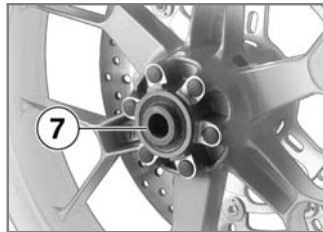

- Remove right-hand spacer sleeve **7**.

Installing front wheel

 Threaded fasteners not tightened to the specified torque can work loose or their threads can suffer damage.

Always have the tightening torques checked by a specialized workshop, preferably an authorized BMW Motorrad retailer. ◀

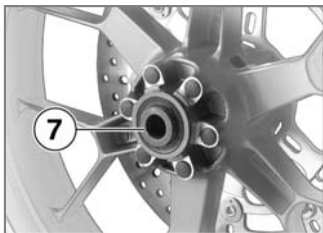

- Install right-hand spacer sleeve **7**.

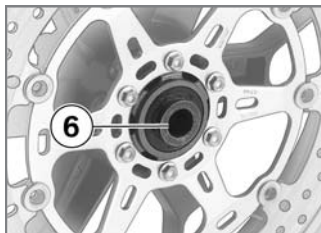

- Install left-hand spacer sleeve **6**.

 The front wheel must be installed right way round to rotate in the correct direction.

Observe the direction of rotation arrows on the tires or on the rim. ◀

- Roll front wheel into forks.

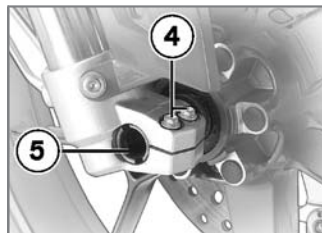

- Insert axle **5** as far as possible.
- Tighten axle clamping screw **4** with specified torque.



Front axle clamping

– 7 lb/ft (10 Nm)

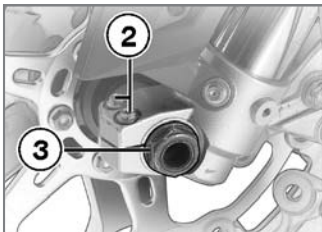

- Install the axis screw **2** with torque.

 Nut on front quick-release axle

– 59 lb/ft (80 Nm)

- Without actuating brake: firmly compress spring forks several times.
- Tighten the left-hand axle clamping screws **2** with specified torque.

 Front axle clamping

– 7 lb/ft (10 Nm)

with OE BMW Motorrad ABS:

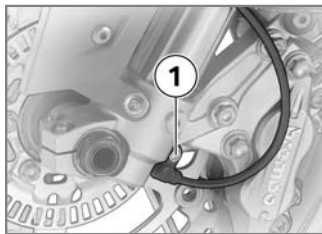

- Mount ABS sensor in holder and install screw **1** of ABS sensor.<
- Remove auxiliary stand.
- Place brake caliper on brake disk.

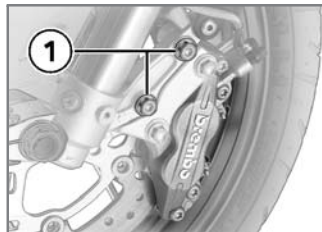

- Install mounting screws **1** with appropriate torque.

 Adapter plate on slider tube

– 37 lb/ft (50 Nm)

- Remove adhesive tape from wheel rim.
- Operate brakes several times until brake pads contact brake disk.

Removing rear wheel

- Place motorcycle on suitable auxiliary stand.

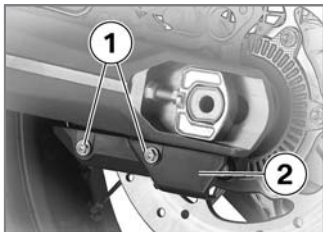

- Remove screws **1**.

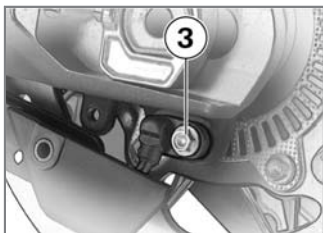

- Remove screw **3** of speed sensor and take speed sensor out of holder.

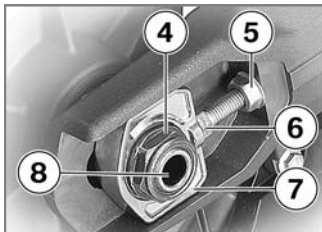

- Remove quick-release axle nut **4**.
- Loosen lock nuts **5** on left and right by turning counterclockwise.
- Loosen adjusting screws **6** on left and right by turning clockwise so that adjusting plate **7** can be removed.
- Remove quick-release axle **8**.

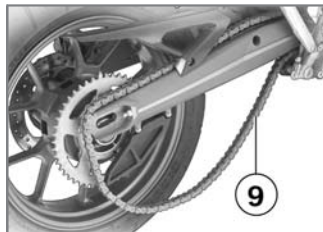

- Roll rear wheel as far forward as possible and remove chain **9** from chain sprocket.
- Roll rear wheel toward rear out of swinging arm.

▶ The chain sprocket and the spacer sleeves on the left and right are loosely inserted in the wheel. When removing, make sure that these parts are not damaged or lost. ◀

Installing rear wheel

 Threaded fasteners not tightened to the specified torque can work loose or their threads can suffer damage.

Always have the tightening torques checked by a specialized workshop, preferably an authorized BMW Motorrad retailer. ◀

- Roll rear wheel into swinging arm while guiding brake disk between brake pads.

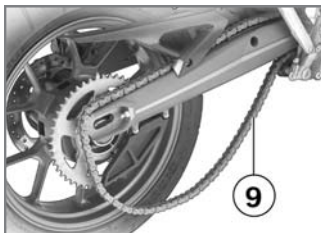

- Roll rear wheel as far forward as possible and lay chain **9** on chain sprocket.

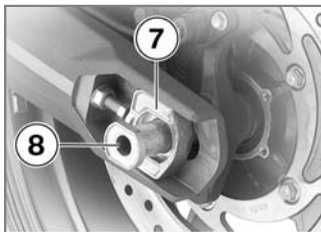

- Mount quick-release axle **8** with adjusting plate **7** in

swinging arm, brake caliper and rear wheel.

- Turn quick-release axle so that it fits into recess of adjusting plate.

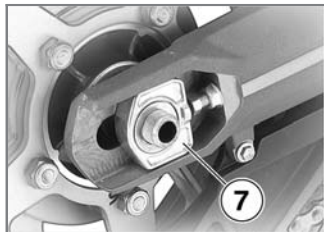

- Insert adjusting plate **7**.



- Install quick-release axle nut **4**, however do not tighten yet.

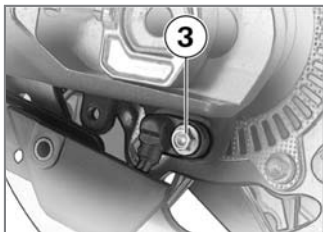

- Mount speed sensor in holder and install screw **3** of speed sensor.

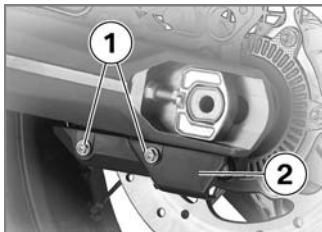

- Lay on cover **2**.
- Install 2 screws **1**.
- Adjusting chain tension (→ 70)
- Remove auxiliary stand.

Fuses

Removing fuses

 There is a danger of fire if defective fuses are bypassed.

Always replace defective fuses with new fuses. ◀

 If the fuses are frequently defective, have the electrical system checked by a specialized workshop, preferably an authorized BMW Motorrad retailer. ◀

- Removing seat (→ 33)
- Switch off ignition.

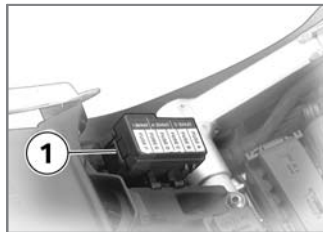

- Press locking lever **1** and fold open fuse cover.
- Pull defective fuse out of fuse box as shown in assignment diagram.

Fuse assignment

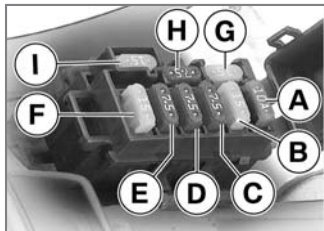

- A** ABS (OE) (10 A)
- B** Engine management system (15 A)
- C** Low-beam headlight (7.5 A)
- D** Brake light, horn, instrument cluster, diagnosis plug (7.5 A)
- E** Parking lights, license plate light, headlight flasher, high-beam headlight (7.5 A)
- F** Starter relay, turn indicators, diagnosis plug (15 A)

- G** Spare fuse (15 A or 10 A with OE)
- H** Spare fuse (7.5 A)
- I** Spare fuse (15 A)

Installing fuses

- Replace defective fuse with fuse with required amperage.
- Close fuse cover.
 - » Latch audibly engages.
- Installing seat (➡ 34)

Removing ABS fuses^{OE}

- Removing right fairing side panel (➡ 90)
- Switch off ignition.
- Pull defective fuse out of fuse box as shown in assignment diagram.

ABS fuse assignment^{OE}

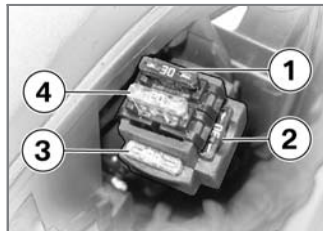

- 1** ABS (30 A)
- 2** Spare fuse (30 A)
- 3** Spare fuse (20 A)
- 4** ABS (20 A)

Installing ABS fuses^{OE}

- Replace defective fuse with fuse with required amperage.
- Installing right fairing side panel (➡ 91)

Lamps

General instructions

! A defective bulb places your safety at risk because it is easier for other users to oversee you and your motorcycle.

Replace defective bulbs as soon as possible; always carry a complete set of spare bulbs if possible.◀

! The bulb is pressurized and can cause injury if damaged.

Wear eye and hand protection when replacing bulbs.◀

▷ An overview of the bulb types installed in your motorcycle is provided in the chapter "Technical Data".◀

▷ Do not touch the glass of new bulbs with your fingers. For installation, use a clean, dry cloth. Dirt de-

posits, in particular oil and grease, interfere with heat radiation from the bulb. Overheating and therefore short service life of the bulbs are the consequence.◀

Removing headlight

! If it is not standing firmly, the motorcycle could topple in the course of the operations described below. Make sure that the motorcycle is steady on its stand.◀

- Make sure ground is level and firm and park the motorcycle.

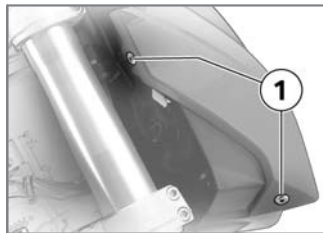

- Remove screws **1** on left and right.
- Remove left and right-hand side panel.

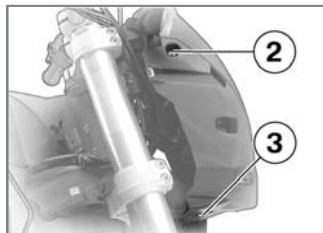

- Remove screws **2** on left and right and screw **3**.

- Take off headlight housing toward front and upward.

Installing headlight housing

- Mount headlight housing.

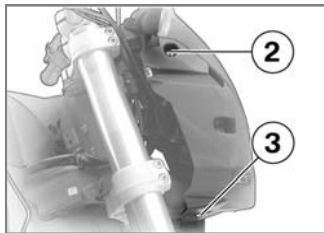

- Install screws **2** on left and right and screw **3**, however do not tighten yet.

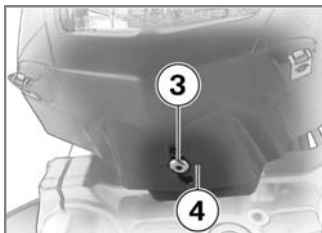

- Align headlight housing so that center of screw **3** is aligned with line **4**.
- Tighten screw **3**.

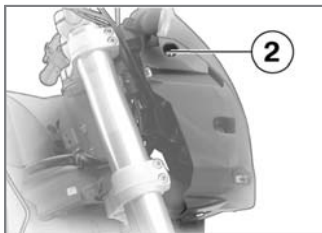

- Tighten screws **2** on left and right.

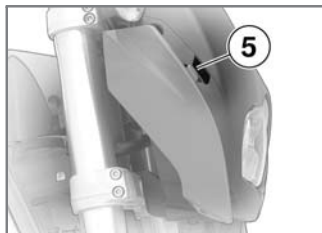

- Mount fairing on left and right, making sure that lug engages in mount **5**.

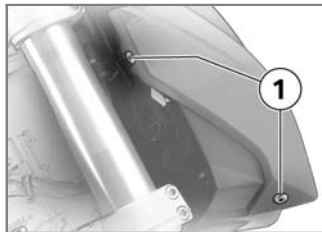

- Install screws **1** on left and right.

Replacing low-beam and high-beam bulb

- Removing headlight (→ 80)
- Switch off ignition.

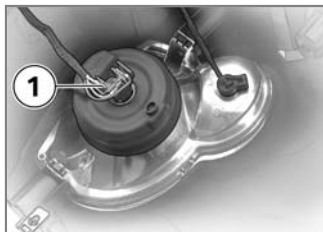

- Disconnect plug **1**.

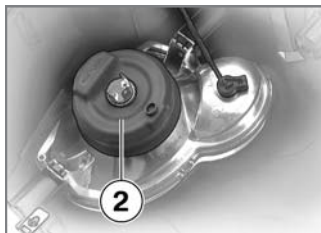

- Remove rubber cap **2**.



- Remove spring strap **3** from detents and fold up.



- Remove bulb **4**.
- Replace defective bulb.



Bulb of low-beam and high-beam headlight

– H4 / 12 V / 55...60 W



- Install bulb **4**.

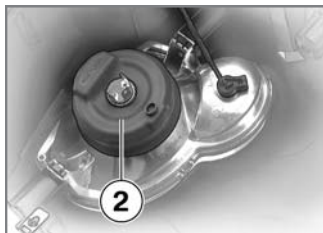

- Install rubber cap **2**.



- Fold closed spring strap **3** and insert in detents.

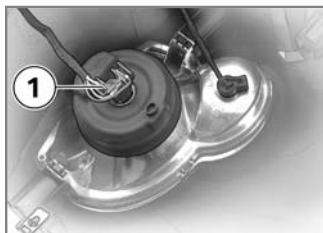

- Connect plug **1**.
- Installing headlight housing (➔ 81)

Replacing parking light bulb

! If it is not standing firmly, the motorcycle could topple in the course of the operations described below. Make sure that the motorcycle is steady on its stand. ◀

- Make sure ground is level and firm and park the motorcycle.
- Removing headlight (➔ 80)
- Switch off ignition.

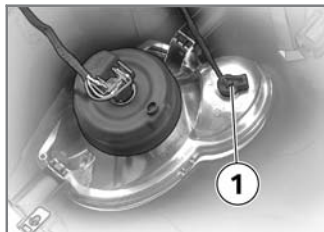

- Pull bulb socket **1** out of headlight housing.

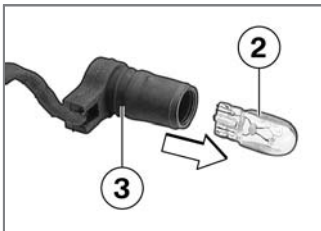

- Pull the bulb **2** out of the socket **3**.
- Replace defective bulb.



Parking-light bulb

– W5W / 12 V / 5 W

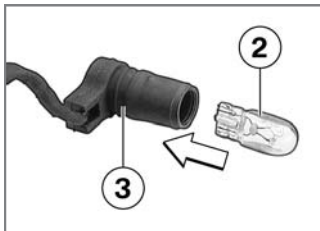

- Insert bulb **2** into socket **3**.

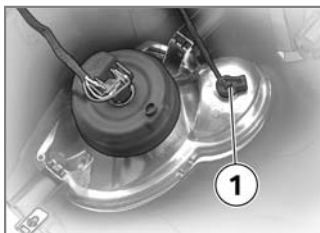

- Insert bulb socket **1** into headlight housing.
- Installing headlight housing (→ 81)

Replacing front and rear turn indicator bulbs



If it is not standing firmly, the motorcycle could topple in the course of the operations described below. Make sure that the motorcycle is steady on its stand. ◀

- Make sure ground is level and firm and park the motorcycle.

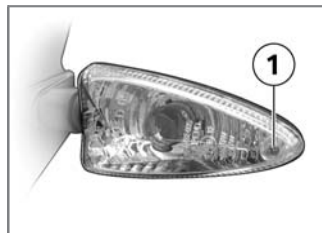

- Remove screw **1**.

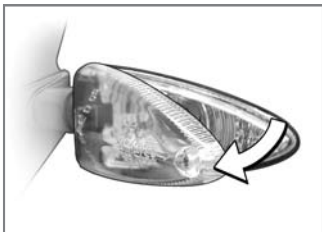

- Replace defective bulb.



Bulb of front turn indicators

– RY10W / 12 V / 10 W



Bulb of rear turn indicators

– RY10W / 12 V / 10 W

- Pull glass on screw connection side out of mirror housing.

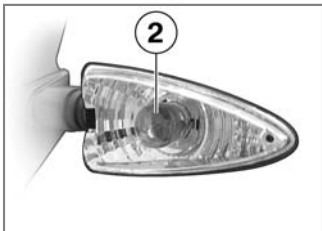

- Install bulb **2** by turning clockwise in light housing.

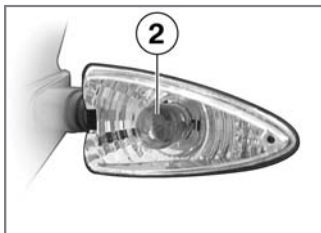

- Remove bulb **2** from light housing by turning it counterclockwise.

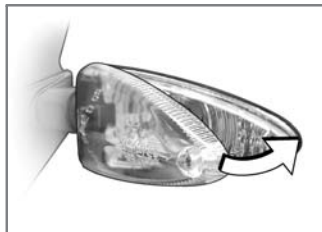

- Insert inside end of lens into light housing and close.

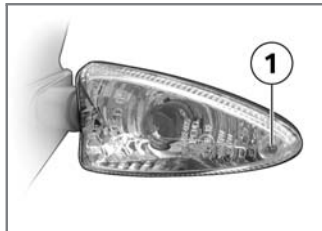

- Install screw **1**.

Replacing license plate light

! If it is not standing firmly, the motorcycle could topple in the course of the operations described below. Make sure that the motorcycle is steady on its stand. ◀

- Make sure ground is level and firm and park the motorcycle.

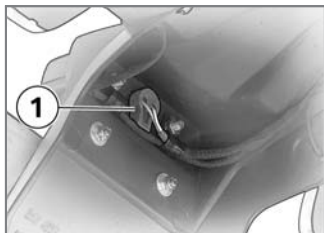

- Pull bulb socket **1** out of bulb holder.

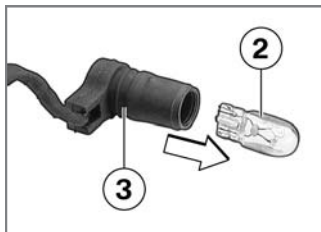

- Pull the bulb **2** out of the socket **3**.
- Replace defective bulb.

 Bulb of license plate light

– W5W / 12 V / 5 W

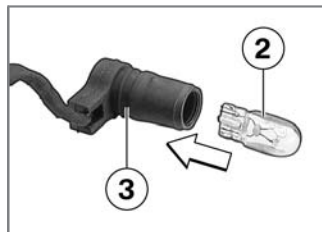

- Insert bulb **2** into socket **3**.

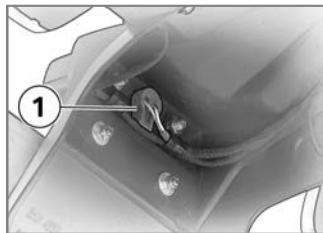

- Insert bulb socket **1** into bulb holder.

Jump-starting

! The wires leading to the onboard socket do not have a load-capacity rating adequate for jump-starting the engine. Excessively high current can lead to a cable fire or damage to the motorcycle electronics.

Do not use the onboard socket to jump-start the motorcycle.◀

! Touching live parts of the ignition system with the engine running can cause electric shock.

Do not touch parts of the ignition system when the engine is running.◀

! A short-circuit can result if the crocodile clips of the jump leads are accidentally brought into contact with the motorcycle.

Use only jump leads fitted

with fully insulated crocodile clips at both ends.◀

! Jump-starting with a donor-battery voltage higher than 12 V can damage the motorcycle electronics. The battery of the donor vehicle must have a voltage of 12 V.◀

- Removing right fairing side panel (⇒ 90)
- When jump-starting the engine, do not disconnect the battery from the onboard electrical system.

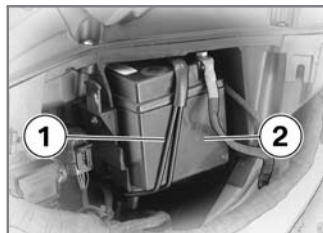

- Remove rubber tensioning strap **1** from holder at bottom and pull out battery **2** somewhat.
- Run engine of donor vehicle during jump-starting.



- Begin by connecting one end of the red jump lead to the positive terminal **3** of the discharged battery and the other end to the positive terminal of the donor battery.
- Connect the black jumper cable to the negative terminal of the supporting battery and then to a suitable grounding point of this motorcycle.
- Start engine of motorcycle with discharged battery in usual way; if engine refuses to start, wait a few minutes

before repeating attempt to protect starter and supporting battery.

- Allow both engines to idle for a few minutes before disconnecting jump leads.
- First disconnect jumper cables from negative terminal and from grounding point respectively, then from positive terminal **3**.

 To start the engine, do not use start sprays or similar items. ◀

- Installing right fairing side panel (➔ 91)

Battery

Maintenance instructions

Correct upkeep, recharging and storage will prolong the life of the battery and are essential if warranty claims are to be considered.

Compliance with the points below is important in order to maximize battery life:

- Keep the surface of the battery clean and dry
- Do not open the battery
- Do not top up with water
- Be sure to read and comply with the instructions for charging the battery on the following pages
- Do not turn the battery upside down

 If the battery is not disconnected, the onboard electronics (clock etc.) will drain the battery. This can cause the battery to run flat. If this happens, warranty claims will not be accepted.

During periods when the motorcycle is not being used, of more than four weeks, disconnect the battery from the

motorcycle or connect a trickle charger to the battery. ◀

Charging connected battery

⚠ Charging the connected battery directly at the battery terminals can damage the motorcycle electronics.

To charge the battery via the battery terminals, disconnect the battery first. ◀

⚠ If you switch on the ignition and the multifunction display and indicator lights fail to light up, the battery is completely flat. Attempting to charge a completely flat battery via the onboard socket can cause damage to the motorcycle's electronics.

Always charge a completely drained battery directly at the

terminals of the disconnected battery. ◀

- Charge connected battery via onboard socket (OE).
- Comply with operating instructions of charger.

Charging disconnected battery

- Charge battery using a suitable charger.
- Comply with operating instructions of charger.
- Once battery is fully charged, disconnect charger terminal clips from battery terminals.

▷ In the case of longer periods when the motorcycle is not being used, the battery must be recharged regularly. See the instructions for caring for your battery. Always fully recharge the

battery before returning it to use. ◀

Removing battery

- Make sure ground is level and firm and park the motorcycle.
- Removing right fairing side panel (➡ 90)

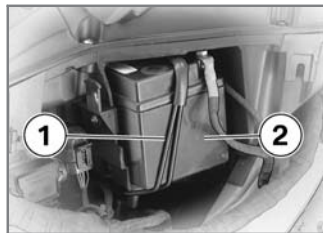

- Unhook clamping strap **1**.
- Pull out battery **2**.



! An incorrect disconnection sequence increase the risk of short-circuiting. Always observe the proper sequence. ◀

- Remove battery ground wire **4** first.
- Then remove positive battery cable **3**.

Installing battery



! An incorrect installation sequence increases the risk of short-circuiting. Always observe the proper sequence. ◀

- First install the positive battery cable **3**.
- Then install negative battery cable **4**.

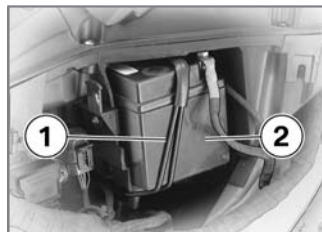

- Insert battery **2** with negative terminal first.
- Hook in clamping strap **1**.
- Installing right fairing side panel (➡ 91)
- Setting clock (➡ 29)

Removing right fairing side panel

- Make sure ground is level and firm and park the motorcycle.
- Removing seat (➡ 33)

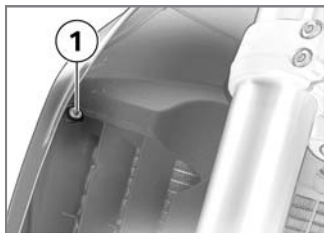

- Remove screw **1** at front right.

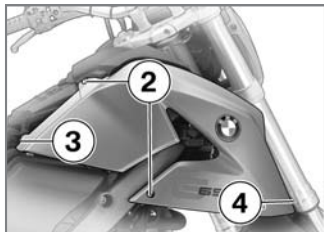

- Remove screws **2**.
- First pull fairing side panel out of holder **3**, then toward rear out of holder **4**.

- Take off fairing side panel.

Installing right fairing side panel

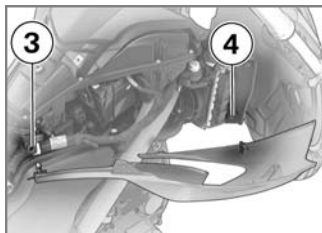

- First insert fairing side panel into holder **4**, then into holder **3**.

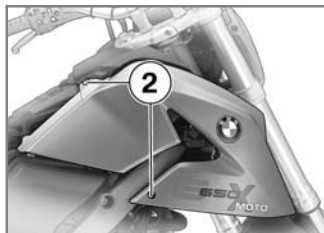

- Install screws **2**.

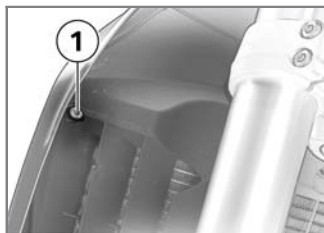

- Install screw **1** at front right.
- Installing seat (→ 34)

License-plate carrier

Removing license-plate carrier

- Make sure ground is level and firm and park the motorcycle.

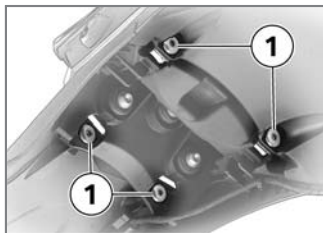

- Remove four screws **1**.

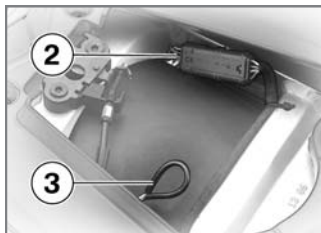

- Disconnect connector **2**.
- Unlock license-plate carrier with wire loop **3** and remove while threading out connector **2** with cable.

Installing license-plate carrier

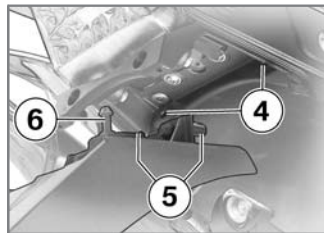

- Thread in cable, insert license-plate carrier with holders **5** in mounts **4** and press upward.
» Pin **6** audibly engages.

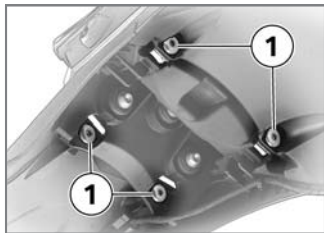

- Install four screws **1**.

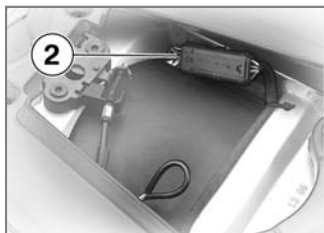

- Close connector **2**.

Care

Care products	96
Washing your motorcycle	96
Cleaning sensitive motorcycle parts	97
Paint care	97
Protective wax coating	98
Storing motorcycle	98
Returning motorcycle to use ...	98

Care products

BMW Motorrad recommends that you use cleaning and care products available at your authorized BMW Motorrad retailer. BMW Care Products have been materials tested, laboratory tested, and field tested and provide optimum care and protection for the materials used in your motorcycle.

 The use of unsuitable cleaning and care products can damage motorcycle components.

For cleaning, do not use any solvents such as nitro-thinners, cold cleaning agents, fuel or similar, and do not use cleaning agents that contain alcohol. ◀

Washing your motorcycle

BMW Motorrad recommends that you use BMW Insect Remover to soften and wash off insects and stubborn dirt from painted parts before washing the motorcycle.

To prevent stains, do not wash the motorcycle immediately after it has been exposed to bright sunlight and do not wash it in the sun. Make sure that the motorcycle is washed frequently, especially during the winter months.

To remove road salt, clean the motorcycle with cold water immediately after every trip.

 After the motorcycle has been washed, ridden through water or ridden in the rain, the brake disks and pads

might be wet and the brakes might not take effect immediately.

Brake early until the brakes are dry or braked until dry. ◀

 Warm water intensifies the effect of salt.

Only use cold water to remove road salt. ◀

 The high pressure of steam cleaners can damage seals, the hydraulic brake system, the electrical system and the seat.

Do not use a steam jet or high-pressure cleaning equipment. ◀

Cleaning sensitive motorcycle parts

Plastics

Clean plastic parts with water and BMW plastic care emulsion. This includes in particular:

- Windshields and wind deflectors
- Headlight lens made of plastic
- Covering glass of the instrument cluster
- Black, unpainted parts

 If plastic parts are cleaned using unsuitable cleaning agents, the surfaces can be damaged. Do not use cleaning agents that contain alcohol, solvents or abrasives to clean plastic parts.

'Fly sponges' or sponges with hard surfaces can also lead to scratches. ◀

 Soften stubborn dirt and dead insects by covering the affected areas with a wet cloth. ◀

Chrome

Especially in the case of road salt, carefully clean chrome parts with plenty of water and BMW auto shampoo. Use chrome polish for additional treatment.

Radiator

Clean the radiator regularly to prevent overheating of the engine due to inadequate cooling. For example, use a garden hose with low water pressure.

 Cooling fins can be bent easily.

When cleaning the radiator, ensure that the fins are not bent. ◀

Rubber

Treat rubber components with water or BMW rubber protection coating agent.

 Using silicone sprays for the care of rubber seals can cause damage.

Do not use silicon sprays or other care products that contain silicon. ◀

Paint care

Washing the motorcycle regularly will help counteract the long-term effects of substances that damage the paint, especially if your motorcycle is ridden in areas with high air pollution or

natural sources of dirt, e.g. tree resin or pollen.

However, remove particularly aggressive materials immediately; otherwise changes in the paint or discoloration can occur. These include spilled fuel, oil, grease, brake fluid as well as bird droppings. BMW Car Polish or BMW Paint Cleaner are recommended for this.

Contamination of the paint finish is particularly easy to see after the motorcycle has been washed. Remove this type of soiling with cleaning naphtha or spirit on a clean cloth or cotton ball. BMW Motorrad recommends removing tar spots with BMW Tar Remover. Then add a protective wax coating to the paint at these locations.

Protective wax coating

To preserve the finish of your motorcycle, BMW Motorrad recommends using BMW Car Wax or agents that contain carnauba or synthetic waxes. A sure sign that the paint must be protected, is the fact that water no longer pearls up on it.

Storing motorcycle

- Clean the motorcycle.
- Remove the battery.
- Spray the brake and clutch lever, the side stand pivot and, if necessary, the main stand pivot with a suitable lubricant.
- Coat bare metal and chrome-plated parts with an acid-free grease (e.g. Vaseline).

- Park the motorcycle in a dry room so that both wheels are unloaded.

 Before storing the vehicle, have the engine oil and the oil filter element changed by a specialized workshop, preferably an authorized BMW Motorrad retailer. Combine work for storing/returning to use with maintenance service or an inspection. ◀

Returning motorcycle to use

- Remove protective wax coating.
- Clean the motorcycle.
- Install a charged battery.
- Before starting: Observe checklist.

Technical data

Troubleshooting chart	100
Threaded fasteners	101
Engine	103
Riding specifications	105
Clutch	105
Transmission	105
Rear-wheel drive	106
Running gear	106
Brakes	107
Wheels and tires	107
Electrical system	109
Frame	110
Dimensions	111
Weights	111

Troubleshooting chart

Engine does not start at all or is very difficult to start

Possible cause	Remedy
Emergency ON/OFF switch activated.	Emergency ON/OFF switch in operating position.
Side stand extended and gear engaged.	Retract side stand (➡ 44).
Gear engaged and clutch not operated.	Place transmission in neutral or disengage clutch (➡ 44).
No fuel in tank.	Refueling (➡ 48)
Battery not adequately charged.	Charging connected battery (➡ 89)

Threaded fasteners

Front wheel	Value	Valid
Nut on front quick-release axle		
M20 x 1.25	59 lb/ft (80 Nm)	
Front axle clamping		
M6	7 lb/ft (10 Nm)	
Adapter plate on slider tube		
	37 lb/ft (50 Nm)	
Rear wheel	Value	Valid
Nut on rear quick-release axle		
M20 x 1.25	59 lb/ft (80 Nm)	
Locknut of drive-chain tensioning screw		
M8	18 lb/ft (25 Nm)	

Mirror arm	Value	Valid
Mirror union nut		
	15 lb/ft (20 Nm)	
Mirror clamping screw on handlebar		
	15 lb/ft (21 Nm)	

Engine

Engine design	Single-cylinder, four-stroke engine, DOHC control with bush roller-chain drive, 4 valves actuated by bucket tappets, compensating shaft, liquid cooling for cylinders and cylinder head. Integrated water pump, 5-speed transmission and dry-sump lubrication
Effective displacement	652 cc (652 cm ³)
Cylinder bore diameter	3.9 in (100 mm)
Piston stroke	3.3 in (83 mm)
Compression ratio	11.5:1
Rated output	53 hp (39 kW), - at engine speed: 7500 min ⁻¹
Maximum torque	44 lb/ft (60 Nm), - at engine speed: 5250 min ⁻¹
Maximum engine speed	7500 min ⁻¹
Idle speed	1480 min ⁻¹
Fuel	
Recommended fuel type	95 ROZ/RON, Super unleaded
Usable fuel quantity	2.6 gal (10 l)
Reserve fuel quantity	≥2.1 quarts (≥2 l)

Engine oil	
Engine oil capacity - total	2.4 quarts (2.3 l), with filter change
Engine oil top-up quantity	0.3 quarts (0.25 l), Difference between MIN and MAX
Oil grades	Mineral engine oils with the API classification SF to SH. BMW Motorrad does not recommend using oil additives, as these can worsen the operation of the clutch. BMW Motorrad recommends not using synthetic oils for the first 6,000 miles (10,000 km). Ask your BMW Motorrad retailer for engine oils suitable for your motorcycle.
Permissible viscosity classes	
SAE 10 W-40	≥ -4 °F (≥ -20 °C), Operation at low temperatures
SAE 15 W-40	≥ 14 °F (≥ -10 °C)

Riding specifications

Top speed	104 mph (167 km/h)
-----------	--------------------

Clutch

Clutch design	Multi-disk oil-bath clutch
---------------	----------------------------

Transmission

Transmission design	Claw-shifted 5-speed transmission
Transmission gear ratios	1.946 (37:72 teeth), Primary gear ratio 2.750 (12:33 teeth), 1st gear 1.750 (16:28 teeth), 2nd gear 1.313 (16:21 teeth), 3rd gear 1.045 (22:23 teeth), 4th gear 0.875 (24:21 teeth), 5th gear

Rear-wheel drive

Rear-wheel drive design	Chain drive
Rear suspension design	2-arm cast aluminum swinging arm
Secondary gear ratio	2.9 (16:47 teeth)

Running gear

Front suspension design	Upside-down telescopic forks
Front-suspension spring travel	10.6 in (270 mm), On wheel
Rear-wheel suspension design	Directly linked central spring strut with coil pressure spring and single-tube gas-filled shock absorber
Total spring travel on rear wheel	8.3 in (210 mm), On wheel

Brakes

Front-wheel brake design	Hydraulically operated single-rotor disk brake with 4-piston fixed calipers and floating brake disk
Front brake-pad material	Sintered metal
Rear-wheel brake design	Hydraulic single-rotor disk brake with 1-piston floating caliper and fixed brake disk
Rear brake lining material	Organic

Wheels and tires

Front wheel design	Cast aluminum, MT H2
Front-wheel rim size	3.50" x 17"
Front tire designation	120 / 70 - 17
Rear wheel design	Cast aluminum, MT H2
Rear-wheel rim size	4.50" x 17"
Rear tire designation	160 / 60 -17

Tire pairs approved by copy deadline	front: Pirelli Diabolo, 120/70 R 17 (58H) rear: Pirelli Diabolo, 160/60 R 17 (69H)
	You can obtain an overview of the current tire approvals from your authorized BMW motorcycle retailer or on the Internet at www.bmw-motorrad.com .
Tire pressures	
Front tire pressure	26.1 psi (1.8 bar), Single rider, with cold tire 27.6 psi (1.9 bar), Driver with passenger and/or load, with cold tire
Rear tire pressure	29 psi (2 bar), Single rider, with cold tire 29 psi (2 bar), Driver with passenger and/or load, with cold tire

Electrical system

Capacity of onboard socket	
with OE BMW Motorrad ABS:	5 A
Fuses	"Minifuse" blade-type fuses with 7.5 A and 15 A
with OE BMW Motorrad ABS:	"Minifuse" blade-type fuses with 10 A, 20 A and 30 A

Battery

Battery designation	ETZ 10 S
Battery design	AGM (Absorptive Glass Matt) battery
Battery voltage	12 V
Battery capacity	10 Ah

Spark plugs

Spark plug manufacturer and designation	NGK DR8 EB
Spark-plug electrode gap	0.02...0.03 in (0.6...0.7 mm), New 0.04 in (0.9 mm), Wear limit

Bulbs	
Bulb of low-beam and high-beam headlight	H4 / 12 V / 55...60 W
Parking-light bulb	W5W / 12 V / 5 W
Bulb of front turn indicators	RY10W / 12 V / 10 W
Bulb of rear turn indicators	RY10W / 12 V / 10 W
Bulb of license plate light	W5W / 12 V / 5 W

Frame

Frame design	Steel bridge frame, carrying drive unit and bolted-on rear frame
Location of type plate	On front frame at right
Location of vehicle identification number	On front frame at right

Dimensions

Motorcycle length	85.8 in (2180 mm)
Maximum height in normal-load position	46.6 in (1184 mm), Without mirrors 56.5 in (1435 mm), With mirrors
Motorcycle width	35.7 in (907 mm), Across mirrors
Driver's seat height	36.2 in (920 mm), Without driver at unladen weight

Weights

Unladen weight	351 lbs (159 kg), DIN unladen weight, ready for road, 90 % full tank of gas, without OE
Permissible gross weight	739 lbs (335 kg)
Maximum payload	388 lbs (176 kg)

Service

BMW Motorrad Service	114
BMW Motorrad Service Quality	114
BMW Motorrad Service Card - On-the-spot breakdown assistance	115
BMW Motorrad Service Network	115
Maintenance work	115
Maintenance schedule	116
Confirmation of maintenance work	117
Confirmation of service	122

BMW Motorrad Service

Advanced technology requires specially adapted methods of maintenance and repair.

 If this maintenance and repair work is performed inexpertly, there is a danger of damage and associated safety risks.

BMW Motorrad recommends having corresponding work on your motorcycle carried out by a specialized workshop, preferably by an authorized BMW Motorrad retailer. ◀

You can contact your authorized BMW Motorrad retailer for information on the procedures included in BMW service, inspections and the annual inspection.

Have all maintenance and repair work carried out con-

firmed in the "Service" chapter in this manual.

Your authorized BMW Motorrad retailer is supplied with all the latest technical information and therefore possesses the necessary technical know-how. BMW Motorrad recommends that you refer any questions about your motorcycle to your authorized BMW Motorrad retailer.

BMW Motorrad Service Quality

BMW Motorrad means not only quality workmanship and high reliability, but also an outstanding quality of service. To ensure that your BMW is always in optimum condition, BMW Motorrad recommends that you adhere to the regular maintenance schedule for your motorcycle, preferably having the work done by your

authorized BMW Motorrad retailer. For generous treatment of claims submitted after the warranty period has expired, evidence of regular maintenance is essential.

Certain signs of wear, moreover, may otherwise not be noticed until it is too late to correct them at moderate cost. The workshop personnel at BMW Motorrad retailers have thorough knowledge of your motorcycle and can take action before minor problems can turn into major trouble. By having the necessary repairs done properly and in good time, you save time and money in the long run.

BMW Motorrad Service Card - On-the-spot breakdown assistance

With all new BMW motorcycles, the BMW Motorrad Service Card protects you in the event of a breakdown with an extensive range of services such as breakdown assistance, motorcycle transportation etc. (differing regulations are possible in individual countries). In the case of a breakdown, contact the Mobile Service of BMW Motorrad. Here you will find our specialists ready to help with both advice and action. Important country-specific contact addresses and the relevant after-sales service organization phone numbers as well as information on Mobile Service and the re-

tail network can be found in the "Service Kontakt/Service Contact" brochures.

BMW Motorrad Service Network

With its worldwide service network, BMW Motorrad can attend to you and your motorcycle in over 100 countries around the globe. In Germany alone, there are approximately 200 authorized BMW Motorrad retailers ready to assist you.

All information on the international retail network is contained in the "Service Contact Europe" brochure and "Service Contact Africa, America, Asia, Australia and Oceania".

Maintenance work Intervals

Some maintenance tasks must be performed after a certain time, others depend on the distance covered by the motorcycle.

BMW Running-in Check

The BMW running-in check has to be performed when the motorcycle has covered between 300 miles (500 km) and 750 miles (1,200 km).

BMW Annual Inspection

Some maintenance work must be carried out at least once a year. Other tasks depend on the distance the motorcycle has covered.

BMW Service

After the first 6,000 miles (10,000 km) and every additional 12,000 miles (20,000 km) (18,000 miles, 30,000 miles, 42,000 miles etc. (30 000 km, 50 000 km, 70 000 km etc.)) if this distance is covered within a year.

BMW Inspection

After the first 12,000 mi/20,000 km and every additional 12,000 mi/20,000 km (24,000 mi/40,000 km, 36,000 mi/60,000 km, 48,000 mi/80,000 km etc.), if this distance is covered within a year.

Maintenance schedule

The maintenance schedule for your motorcycle depends on the equipment installed, and on the motorcycle's age and the distance it has covered. Your authorized BMW Motorrad retailer will be happy to supply a copy of the current maintenance schedule for your motorcycle on request.

Confirmation of maintenance work

BMW Pre-Delivery Check

Carried out properly in accordance with workshop specifications.

Date, stamp, signature

BMW Running-In Check

Carried out properly in accordance with workshop specifications.

Odometer reading _____

Brake fluid changed

Date, stamp, signature

BMW Service

- BMW Annual Inspection
- BMW Service
- BMW Inspection

Carried out properly in accordance with workshop specifications.

Odometer reading _____

- Brake fluid changed

Date, stamp, signature

BMW Service

- BMW Annual Inspection
- BMW Service
- BMW Inspection

Carried out properly in accordance with workshop specifications.

Odometer reading _____

- Brake fluid changed

Date, stamp, signature

BMW Service

- BMW Annual Inspection
- BMW Service
- BMW Inspection

Carried out properly in accordance with workshop specifications.

Odometer reading _____

- Brake fluid changed

Date, stamp, signature

BMW Service

- BMW Annual Inspection
- BMW Service
- BMW Inspection

Carried out properly in accordance with workshop specifications.

Odometer reading _____

- Brake fluid changed

Date, stamp, signature

BMW Service

- BMW Annual Inspection
- BMW Service
- BMW Inspection

Carried out properly in accordance with workshop specifications.

Odometer reading _____

- Brake fluid changed

Date, stamp, signature

BMW Service

- BMW Annual Inspection
- BMW Service
- BMW Inspection

Carried out properly in accordance with workshop specifications.

Odometer reading _____

- Brake fluid changed

Date, stamp, signature

BMW Service

- BMW Annual Inspection
- BMW Service
- BMW Inspection

Carried out properly in accordance with workshop specifications.

Odometer reading _____

- Brake fluid changed

Date, stamp, signature

BMW Service

- BMW Annual Inspection
- BMW Service
- BMW Inspection

Carried out properly in accordance with workshop specifications.

Odometer reading _____

- Brake fluid changed

Date, stamp, signature

BMW Service

- BMW Annual Inspection
- BMW Service
- BMW Inspection

Carried out properly in accordance with workshop specifications.

Odometer reading _____

- Brake fluid changed

Date, stamp, signature

BMW Service

- BMW Annual Inspection
- BMW Service
- BMW Inspection

Carried out properly in accordance with workshop specifications.

Odometer reading _____

- Brake fluid changed

Date, stamp, signature

BMW Service

- BMW Annual Inspection
- BMW Service
- BMW Inspection

Carried out properly in accordance with workshop specifications.

Odometer reading _____

- Brake fluid changed

Date, stamp, signature

BMW Service

- BMW Annual Inspection
- BMW Service
- BMW Inspection

Carried out properly in accordance with workshop specifications.

Odometer reading _____

- Brake fluid changed

Date, stamp, signature

Work carried out	Odometer reading	Date

- A**
Abbreviations and symbols, 6
ABS, 15
 Fuses, 13
Accessories
 General instructions, 56
- B**
Battery
 Charging connected
 battery, 89
 Charging disconnected
 battery, 89
 Installing, 90
 Maintenance instruc-
 tions, 88
 Removing, 89
 Technical data, 109
Brake fluid
 Checking front brake fluid
 level, 66
 Checking rear brake fluid
 level, 67
 front, 13
 rear, 13
- Brake pads
 Check front, 64
 Check rear, 65
 Running in, 47
- Brakes
 Checking operation, 63
 Safety instructions, 49
 Technical data, 107
- C**
Care, 95
Checklist, 44
Cleaning, 95
Clock
 Adjusting, 29
Clutch
 Adjusting lever play, 69
 Checking lever play, 69
 Technical data, 105
Commissioning, 98
Confirmation of maintenance
 work, 117
- Coolant, 11
 Checking level, 67
 Topping up, 68
Currentness of this manual, 7
- D**
Damping, 36
 Adjusting on rear wheel, 39
Dimensions
 Technical data, 111
- E**
Electrical system
 Technical data, 109
Emergency ON/OFF
 switch, 16, 31
Engine
 Starting, 44
 Technical data, 103
Engine oil, 14
 Checking fluid level, 61
 Engine oil-pressure warning
 indicator, 22
 Technical data, 104
 Topping up, 63
Equipment, 7

F

- Frame
 - Technical data, 110
- Front shock absorber system, 11, 37
 - Adjusting rebound, 38
- Fuel, 13
 - Refueling, 48
 - Reserve-quantity warning indicator, 22
 - Technical data, 4, 103
- Fuses, 14, 109
 - ABS, 13
 - Assignment, 79
 - Installing, 79
 - Removing, 78

H

- Handlebar fittings
 - General view, left, 15
 - General view, right, 16

H

- Headlight
 - Adjusting for RHD/LHD traffic, 32
 - Headlight range, 32
- Headlight flasher, 15
- High-beam headlight, 15, 18
- Horn, 15

I

- Ignition
 - Switching off, 28
 - Switching on, 28

J

- Jump-starting, 87

K

- Keys, 28

L

- Lamps
 - General instructions, 80
 - High-beam headlight, 18
 - Low-beam headlight, 18
 - Parking lights, 18
 - Removing headlight, 80

- Replacing front turn indicator bulb, 84
- Replacing high-beam bulb, 82
- Replacing license plate light, 86
- Replacing low-beam bulb, 82
- Replacing parking-light bulb, 83
- Replacing rear turn indicator bulb, 84
 - Technical data, 110
- Lights
 - Headlight flasher, 32
 - High-beam headlight, 32
 - Low-beam headlight, 31
 - Parking lights, 31
- Low-beam headlight, 18

M

- Maintenance
 - General instructions, 60
 - Intervals, 115

Mirrors

Adjusting, 34

Motorcycle

Care, 95

Cleaning, 95

General view of left side, 11

General view of right side, 13

Returning to use, 98

Storing, 98

Switching off, 47

Multifunction display

Selecting readings, 28

O**Odometer and tripmeters**

Resetting, 29

Onboard socket, 11, 56**Overview of warning indicators, 21, 24****P****Parking lights, 18****Pre-ride check, 45****R****Rear shock absorber system, 11****Rear suspension preload, 11****Rear-****wheel drive**

Technical data, 106

Refueling, 48**Reserve**

Warning indicator, 22

Running gear

Technical data, 106

Running in, 46**S****Safety instructions, 42**

Brakes, 49

Correct loading, 42

Seat, 14

Installing, 34

Seat lock, 13**Service, 114****Service Card, 115****Side stand**

During starting, 44

Spark plugs

Technical data, 109

Spring preload, 36

Adjusting on rear wheel, 36

Starter, 16**Starting, 44****Steering lock, 28****Storing, 98****Switching off, 47****T****Technical data**

Battery, 109

Brakes, 107

Bulbs, 110

Clutch, 105

Dimensions, 111

Electrical system, 109

Engine, 103

Engine oil, 104

Frame, 110

Fuel, 4, 103

Rear-wheel drive, 106

Running gear, 106

Spark plugs, 109

- Standards, 7
- Transmission, 105
- Weights, 111
- Wheels and tires, 107
- Tires
 - Air pressure, 4, 108
 - Checking air pressure, 39
 - Checking tread depth, 69
 - Recommended tires, 71
 - Running in, 47
 - Technical data, 107
- Toolkit, 14
 - Service set, 60
 - Standard equipment, 60
- Torques, 101
- Transmission
 - During starting, 44
 - Technical data, 105
- Troubleshooting chart, 100
- Turn indicators, 15
 - Operating, 33

W

- Warning indicators
 - Display, 20

- Weights
 - Technical data, 111
- Wheels
 - Installing front wheel, 74
 - Installing rear wheel, 77
 - Removing front wheel, 71
 - Removing rear wheel, 75
 - Technical data, 107

Reporting Safety Defects

If you believe that your vehicle has a defect which could cause a crash or could cause injury or death, you should immediately inform the National Highway Traffic Safety Administration (NHTSA) in addition to notifying BMW of North America, LLC.

If NHTSA receives similar complaints, it may open an investigation, and if it finds that a safety defect exists in a group of vehicles, it may order a recall and remedy campaign. However, NHTSA cannot become involved in individual problems between you, your dealer, or BMW of North America, LLC.

To contact NHTSA, you may call the Vehicle Safety Hotline toll-free at 1-888-327-4236 (TTY: 1-800-424-9153); go to <http://www.safercar.gov>; or write to: Administrator, NHTSA, 400 Seventh Street, SW., Washington, DC 20590. You can also obtain other information about motor vehicle safety from <http://www.safercar.gov>.

Details described or illustrated in this booklet may differ from the motorcycle's actual specification as purchased, the accessories fitted or the national-market specification. No claims will be entertained as a result of such discrepancies.

Dimensions, weights, fuel consumption and performance data are quoted to the customary tolerances. The right to modify designs, equipment and accessories is reserved.

Errors and omissions excepted.

© 2006 BMW Motorrad

Not to be reproduced either wholly or in part without written permission from BMW

Motorrad, After Sales.

Printed in Germany.

Important data for refueling

Fuel	
Recommended fuel type	95 ROZ/RON, Super unleaded
Usable fuel quantity	2.6 gal (10 l)
Reserve fuel quantity	≥2.1 quarts (≥2 l)
Tire pressures	
Front tire pressure	26.1 psi (1.8 bar), Single rider, with cold tire 27.6 psi (1.9 bar), Driver with passenger and/or load, with cold tire
Rear tire pressure	29 psi (2 bar), Single rider, with cold tire 29 psi (2 bar), Driver with passenger and/or load, with cold tire

BMW recommends 

Order No.: 01 47 7 708 197
10.2006, 1st Edition

