

2014

## Audi Sport

R8 | RS | S

Note: A word about this brochure. Audi of America, Inc., believes the specifications in this brochure to be correct at the time of printing. However, specifications, standard equipment, options, fabrics, and colors are subject to change without notice. Some equipment may be unavailable when your vehicle is built. Please ask your dealer for advice concerning current availability of standard and optional equipment, and your dealer will verify that your vehicle will include the equipment you ordered. Vehicles in this brochure are shown with optional equipment. See your dealer for complete details on the New Vehicle Limited Warranty, twelve-year limited warranty against corrosion perforation, and Audi 24/7 Roadside Assistance. (Roadside assistance coverage provided by Road America in the U.S. Certain conditions apply; see your dealer for details.) Tires supplied by various manufacturers. "Audi," all model names, "ASF," "Audi connect," "Audi ultra," "cylinder on demand," "FSI," "MMI," "pre sense," "quattro," "Sideguard," "Singleframe" and the Singleframe grille design, "Sport," "S tronic," "TFSI," "Truth in Engineering," and the four rings logo are trademarks or registered trademarks of AUDI AG. "Alcantara" is a registered trademark of Alcantara S.p.A. "Bang & Olufsen" is a registered trademark of Bang & Olufsen. "BOSE" and "AudioPilot" are registered trademarks of the BOSE Corporation. The BLUETOOTH word mark and logos are owned by the Bluetooth SIG, Inc., and use of any such marks by AUDI AG is under license. "Google" and "Google Earth" are trademarks of Google Inc. "HD Radio" and the HD Radio logo are proprietary trademarks of iBiquity Digital Corporation. "HomeLink" is a registered trademark of Johnson Controls Technology Company. "iPod" is a registered trademark of Apple Inc. "SiriusXM" and all related marks and logos are trademarks of Sirius XM Radio Inc. and its subsidiaries. "Tiptronic" is a registered trademark of Dr. Ing h.c. F. Porsche AG. "Wi-Fi" is a trademark of the Wi-Fi Alliance. All other trademarks are the property of their respective owners. Some European models shown.

Audi MMI® Navigation plus depends on signals from the worldwide Global Positioning Satellite network. The vehicle's electrical system and existing wireless and satellite technologies must be available and operating properly for the system to function. The system is designed to provide you with suggested routes in locating addresses, destinations and other points of interest. Changes in street names, construction zones, traffic flow, points of interest and other road system changes are beyond the control of Audi of America, Inc. Complete detailed mapping of lanes, roads, streets, toll roads, highways, etc., is not possible, therefore you may encounter discrepancies between the mapping and your actual location. Please rely on your individual judgment in determining whether or not to follow a suggested Audi MMI® Navigation plus route. For mapping updates please see your Audi dealer or call 1-800-FOR-AUDI for details.

SiriusXM® Satellite Radio and Traffic subscriptions sold separately or as a package after trial expires. SiriusXM® Traffic service available in select markets. Subscriptions are governed by SiriusXM® Customer Agreement (see [www.siriusxm.com](http://www.siriusxm.com)) and are continuous until you call SiriusXM® to cancel. SiriusXM® U.S. Satellite Service available only to those 18 and older in the 48 contiguous U.S.A., D.C. and Puerto Rico (with coverage limitations).

2014 | Sport

Audi of America  
 AudiUSA.com  
 Facebook.com/Audi

AoA1414241

© 2013 Audi of America, Inc. Printed in the U.S.A.



Information Provided by:  
**DEALER**  
 E-PROCESS

Audi  
 Truth in Engineering





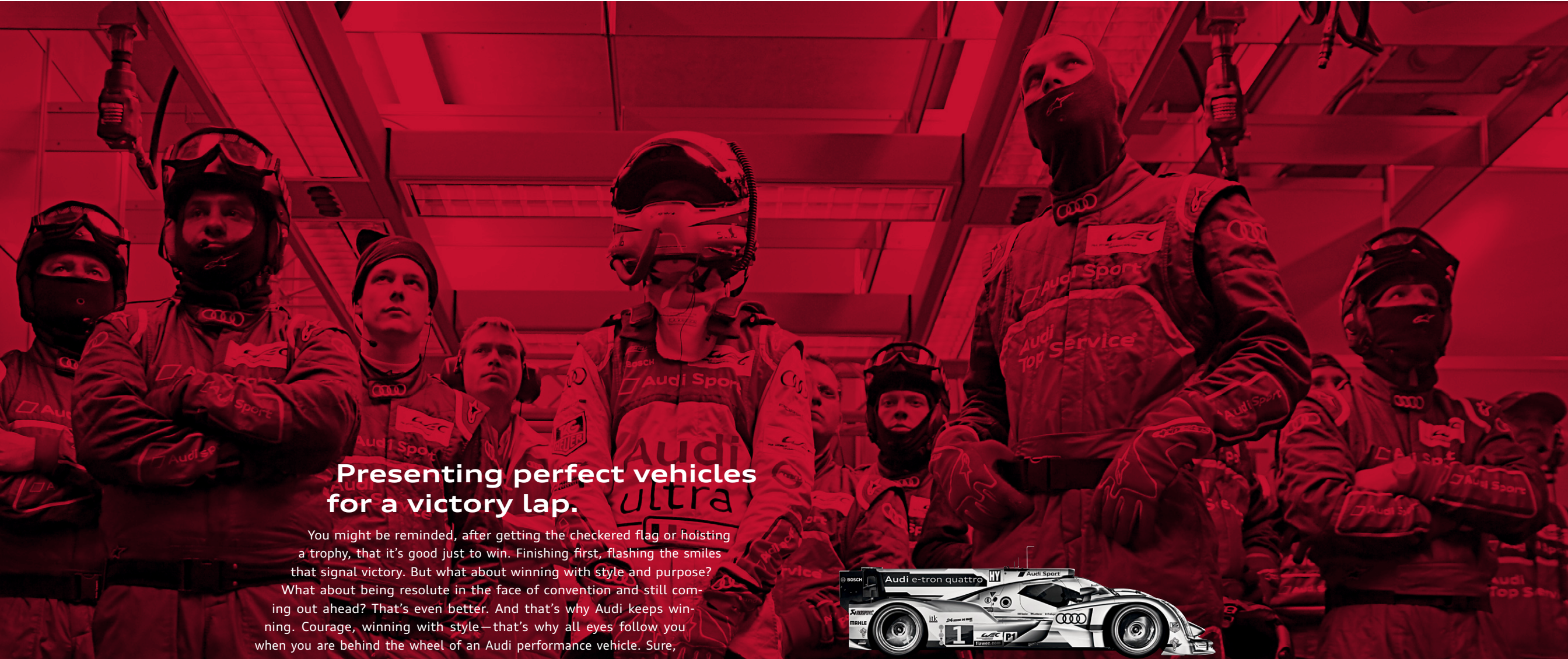

## Presenting perfect vehicles for a victory lap.

You might be reminded, after getting the checkered flag or hoisting a trophy, that it's good just to win. Finishing first, flashing the smiles that signal victory. But what about winning with style and purpose? What about being resolute in the face of convention and still coming out ahead? That's even better. And that's why Audi keeps winning. Courage, winning with style—that's why all eyes follow you when you are behind the wheel of an Audi performance vehicle. Sure,

we have a decades-long heritage of winning motorsports competitions, but it's more important to us that we also have a heritage of risk-taking that speaks to a larger victory. It's the winning that comes from learning from failure and improving our product as a result. It's the personal satisfaction you feel every time you start your Audi R8, RS or S model.

Winning with Audi is not just the time trial, or the competition—it is the rev, the craft, the kick and confidence of 200 sublimely taken turns you'll make on any given day. Whether shaving ounces off a component, revolutionizing the shape of the sheet metal or utilizing new technologies and materials to enhance the feel of performance, you win because you are experiencing an Audi expressly made to challenge convention and stand apart from the crowd. These vehicles represent a salute to you, your spirit and your endlessly winning taste in performance vehicles.



Audi Sport is distilled into its purest form with the track-born Audi R8. The uncompromising progressive supercar, the R8 stands apart. Coiled at the pinnacle of performance, the R8 is ready at a moment's notice to forcefully express the stylish craft and dynamic engineering behind Audi power.



Imagine track performance made for the road. An everyday thrill for those who own them, the Audi RS is engineered and finely tuned for exhilarating performance. It also embodies the kind of fluid, athletic form that makes the daily driver live for track day, or the road ahead.



"Drive" can have several meanings. We were driven to craft the Audi S models to blend the thrilling acceleration with the daily commute. You are driven by its eye-catching style and invigorating performance. It is driven to transport you on your daily drive—and far beyond.



The look of Audi performance. The Audi S line® option gives a sleek, performance look to select Audi models. So enjoy the double takes and motorsport stance that come with the sculpted lines and aggressively stylish interior appointments of the S line for A4, A5, TT, Q5 and Q7.



Information Provided by  
**DEALER**  
E-PROCESS



## We don't believe in recessive genes.

To those who study it, it has become more and more evident that evolution doesn't have to be slow and steady—it can happen in a single, frenzied burst of will, instantly making something stronger, more beautiful and fully adapted to even the most challenging environments. The evolutionary leaps found in the Audi performance DNA are proof. Audi doesn't build off the genetic blueprints of past racing champions so much as change what will be technologically and physically possible on the road. It's how power evolves.

**Aluminum** When the Silver Arrows were king, Auto Union, an Audi ancestor, built them. An arresting, powerful machine, they were notable for the use of aluminum in the design, their Grand Prix wins and their then-uncharted performance (a machine, charged engine design that produced up to 550 hp). Auto Union Silver Arrows and innovative applications of supercharging, ultimately, our use of ASF® aluminum construction.

**Audi quattro®** In 1977, courage held firm when Audi engineer Jörg Bensinger wondered how a high-performance vehicle would perform with all-wheel drive. Three years, Audi quattro® all-wheel drive was born, and dominated motorsports. Within grip that quattro® all-wheel drive way into all Audi models, and helped drivers gain confidence in almost any conditions.

**Audi FSI® & TFSI®** When FSI was introduced into Audi motorsports in 2001, it was a bold move. Powering the R8 Le Mans prototype. A twin-turbocharged 3.6-liter V8 with FSI direct injection maximized both power and efficiency.<sup>1</sup> Today, Audi performance cars feature it to help drivers maximize the amount of power generated when they hit the accelerator.<sup>2</sup>

**Audi S tronic®** S tronic is an automated sequential manual transmission first named "S tronic" in the 2005 Audi R10 Le Mans prototype. Originally using a single-clutch design, a second clutch was added later to design, resulting in smoother acceleration, which made for smoother acceleration models, resulting in smoother acceleration models, hundredths of a second.

**Audi ultra® lightweight technology** We introduced the Audi R18 ultra just in time for the 2011 24 Hours of Le Mans race. As the showcase vehicle for the Audi ultra lightweight technology initiative, the R18 ultra shows how smart design and the use of lightweight fiber can make all our Audi performance models more nimble, more efficient and more progressive.<sup>1</sup>





# Power can feel limitless.

Sure, Isaac Newton may have been right about a lot of things, including the physical laws of the universe, but it doesn't mean we have to like it. So while we're bound to obey the laws of motion, Audi engineers still strive mightily to push the envelope on behalf of our drivers. We know that we can't overcome these laws, but you can enjoy challenging them, it's what iconic power is all about. You can feel the results of our efforts throughout the Audi performance model lineup. Let's say that we think of our performance vehicles less as lawbreakers than as dynamic followers of Newton's Laws of Motion.

# Even if it follows the laws of motion. ▯

## Newton's 1st law

A vehicle moving in a straight line at a constant speed will keep such motion until acted on by an external force.

- Inertia
- Equilibrium
- Friction

## Newton's 2nd law

When a force is applied to a vehicle, the change in motion is proportional to the force divided by the mass of the vehicle.

- Weight/Mass
- Gravity
- Acceleration

## Newton's 3rd law

Every force on a vehicle by another object, such as the ground, is matched by an equal and opposite force on the object by the vehicle.

- Force
- Momentum
- Deceleration

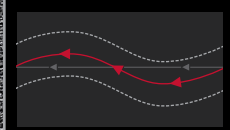

Enviably handling characteristics, achieved through Audi ultra® light-weight technology and precise balance, help our performance drivers get the most out of powering through almost any curves they want to own.<sup>1</sup>

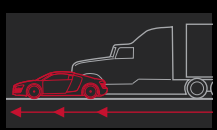

We define our performance less through numbers than through feel. There is nothing like the power distributed by an Audi performance vehicle—pure, effortless and quick. It is accelerated engineering.<sup>1</sup>

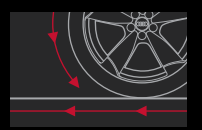

Design isn't simply for style, it's also important for Audi performance to overcome the forces of nature. Streamlined, powerful and focused is not only how we create momentum in our vehicles, it's an extension of our commitment to performance.

<sup>1</sup> Obey all speed and traffic laws.



## SCULPTING

Audi performance models make the case for functional style. Sculpted large air intakes in the front help reduce drag, while differentiated exhaust outlets in the rear lend an unmistakable look to power. We designed both to enhance response—emotional and technical.

## Style goes beyond the law.

When it comes to the “laws” of design, we chose to be more provocative than obedient. By bringing a courageous style along for the iconic ride, Audi transforms how performance moves you. For the driver, it’s about how our sleek, sculpted form engages the senses, how we invite your eye to follow us down from the Roof line into the integrated rear deck-lid spoiler, how the signature Tornado line makes you feel the movement even when in Park. One look and you’ll understand how style gives shape to the emotional core of the moment.

Aluminum-optic accents  
*+ design*



LED headlight technology  
*+ vision*

unique front fascia  
*+ confidence*

RS and S specific Audi Singleframe® grille  
*+ appeal*

seamless laser welds  
*+ finish*



LED taillight technology  
*+ awareness*

distinctive side sills  
*+ appearance*

sport suspension calibration  
*+ stance*

RS and S specific exhaust outlets  
*+ audi (Latin for listen)*





## AMAZEMENT

The shorthand for Newton's third law is: For every action, there is an equal and opposite reaction. In an automotive world that seems too ordinary, our reaction is to use materials in vehicles like our Audi R8 to challenge convention.

## How to say "craft" in a bold new language.

To help our drivers respond to the forces of the universe, we were driven to use innovative materials and technologies in a visionary way. When put to the test in our Audi performance models, they've created a new kind of grammar to articulate how power is channeled and how it performs. With words like "carbon fiber" and "aluminum" attached to body panels and chassis structures, we craft a more powerful, lighter and more precise driving experience. And we hope that others see that by crafting a bolder path now, we are set to challenge expectations down the road too.

ASF<sup>®</sup> aluminum construction<sup>1</sup>  
+ weight reduction and rigidity

four rings badge  
+ truth in engineering<sup>®</sup>

carbon fiber-reinforced  
polymer (CFRP)<sup>1</sup>  
+ Audi ultra<sup>®</sup> lightweight  
technology

dry sump lubrication<sup>1</sup>  
+ lower center of gravity

<sup>1</sup> Features and technologies listed will not be available on all models.



# AERODYNAMICS

All cars have to overcome the pressure and friction of air when in motion. By designing lines, spoilers and even the undercarriage to the optimum shape of aerodynamic efficiency, Audi helps thrust overcome resistance.

## Excessive passion. Streamlined.

Of course, sometimes we seek to define power. Other times, as when we're testing an Audi facing a wind speed of 87 mph, we look to define the drag coefficient, which might not sound as sexy, but is really a measure of just how powerful we can be. And when the test gets up to 186.4 mph, we begin to really understand how aerodynamics affects power. How we cope with drag coefficient, downforce, air management of vital systems such as engine intake and cooling, and the slipstream helps us win the most demanding race on earth: the 24 Hours of Le Mans. But that's not our only goal. It's how our passion for powerful driving dynamics gets streamlined to inspire drivers.<sup>1</sup>

fixed, integrated or adaptive rear spoilers help increase downforce<sup>2</sup>

shallow windshield rake helps avoid pressure build-up in front

Audi Singleframe® grille optimizes airflow

negative pressure

positive pressure

rear bumper and diffuser help airflow release from under the car

minimal ground clearance for lower airflow under the car, creating low pressure

front air dam optimizes airflow



1 Obey all speed and traffic laws. 2 Features and technologies listed will not be available on all models.





## GRIP

While on the road, friction is a component of the power your car can distribute. In your car's cabin, friction—also called grip—can help the driver stay better connected to the road, engineered through the design of our sport seats.

## The only way we hold you back.

When iconic design needs to take a seat, it better be an Audi sport seat, one where the driver is in total control. With a wraparound fit that helps keep you firmly in place as you hit the throttle, it's a finely tailored, hand-stitched, leather seat that's also your secure command center for performance.<sup>1</sup> Everything is within easy reach: your instruments, your shifts, your entertainment. But most of all, this is a seat that makes you one with power.<sup>2</sup>

integrated head restraints<sup>2</sup>  
+ comfort  
+ head support

diamond cross-stitch pattern<sup>2</sup>  
+ refinement in craftsmanship  
+ grip

seat bolsters  
+ lateral support  
+ comfort  
+ positioning

thigh support<sup>2</sup>  
+ comfort



Performance. Precision. Power.  
Audi Sport



## POWER

If you are thinking  $F = ma$  when you step on the accelerator, you might be overthinking how power is felt. Overcoming opposing forces produces acceleration, but engage the throttle to break through the physics lesson and emerge into the physical reality of power.

## Sharing power with those who earn it.

In the end, we believe true power is felt. So while horsepower numbers might move you, Audi performance vehicles were engineered to turn raw numbers into something comprehensible and visceral. A track-bred heritage and features like Audi ultra® lightweight technology and more efficient engine design<sup>1</sup> help transform every moment you are behind the wheel into an experience amplified by impressive torque, precise dynamics and the pure thrill of total performance.<sup>2</sup> With numbers like 8,700 rpm and 140 hp per liter, you can quicken a pulse, set a course and feel the flow of energy from your foot to your machine.<sup>3</sup>

SYMBOL OF POWER



SYMBOL OF POWER



### Power density

It's smart to embrace a little light thinking. That's why we design Audi performance engines to be lean. The result is high horsepower per liter — upwards of 130 hp per liter in the Audi S8 and 140 hp per liter in the Audi RS 7. But it's not horsepower alone that defines us, but rather the concept of power density. We engineer and manufacture proven race-bred engines that not only freely

rev as high as 8,700 rpm in the Audi R8 V10, but also remain extremely efficient through the use of innovative features like Audi FSI®, TFSI® and Audi cylinder on demand™ engine efficiency technology.<sup>1</sup> Horsepower and efficiency aside, our TFSI engines also develop broad torque curves that peak and plateau just above engine-idling speeds — this is the immense power you actually feel.<sup>3</sup>



Information Provided by:

**DEALER**  
E-PROCESS

<sup>1</sup> See [www.fueleconomy.gov](http://www.fueleconomy.gov) for EPA estimates. Your mileage will vary. <sup>2</sup> Obey all speed and traffic laws. <sup>3</sup> Specifications listed will differ from model to model. Features and technologies listed will not be available on all models.



## HANDLING

Newton tells us that when you push, something pushes back, but sometimes driving doesn't work that way. Dry or inclement weather—that's when you need Audi quattro® all-wheel drive, for the optimum grip and power when and where it is most needed.

# “Even a trained monkey can win in a quattro.”

—Walter Röhrl

Long known as the all-wheel-drive standard, Audi quattro® all-wheel drive has also helped us win races all over the world. Some people, like former Audi Sport® driver Walter Röhrl, say that it makes racing almost too easy. From the system's asymmetric torque split that delivers power when and where it's most needed—up to 85% to the rear for straightaway acceleration<sup>1</sup>—to the torque vectoring and sport differential that help make cornering more precise and handling more assured, quattro® helps optimize driving performance.<sup>2</sup> We think you'll enjoy how it helps grip the road and turns your drive into a showcase of progress.<sup>3</sup>

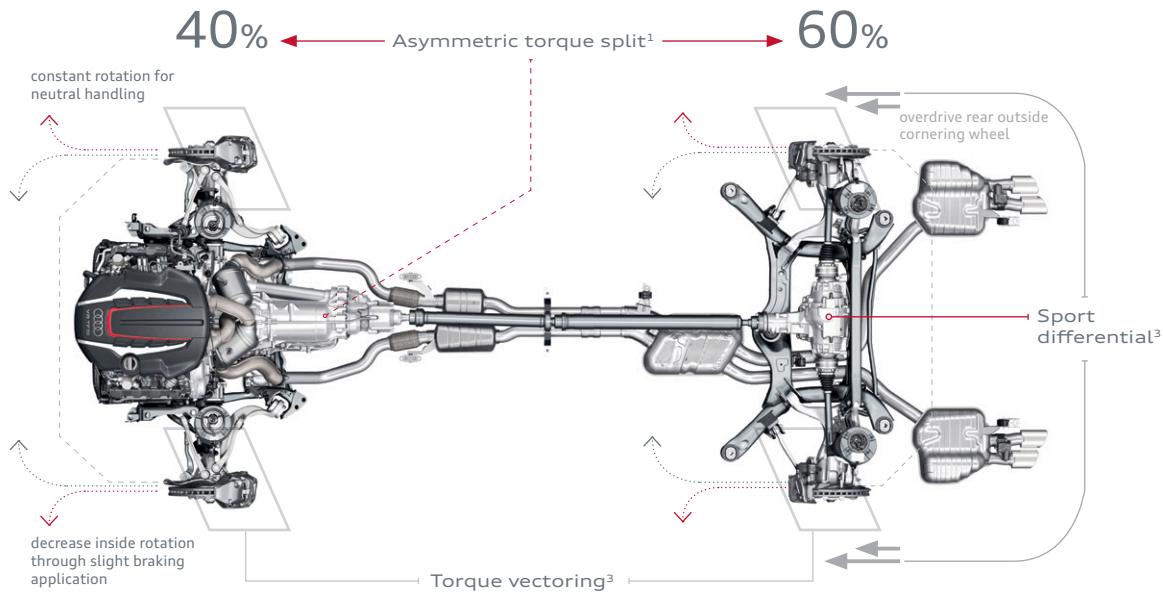

2014 Audi S8 drivetrain shown.

1 Torque split ratio will vary from model to model. 2 Obey all speed and traffic laws. 3 Features and technologies listed will not be available on all models.

### Asymmetric torque split

Under normal driving conditions the center differential splits torque at a ratio of 40:60 front to rear. As conditions change, ratio biases from 60:40 to 20:80 front to rear are achievable. If extremely low traction exists at either axle, an electronic locking feature can shift up to 100% of available torque to the wheel with the most traction.<sup>1,2</sup>

### Torque vectoring

By independently braking the inside cornering wheels, torque is then transferred to the outside cornering wheels. This intelligent application of power, known as torque vectoring, helps promote neutral handling by calculating the driver's steering input and desired level of acceleration.<sup>2,3</sup>

### Sport differential

To help ensure high cornering stability, the sport differential uses torque vectoring and then adds to that by mechanically applying additional torque to the outside rear cornering wheel. Through an electrohydraulic multiplate clutch pack and gear-set, the outside rear cornering wheel speed is increased by as much as 10%.<sup>2,3</sup>

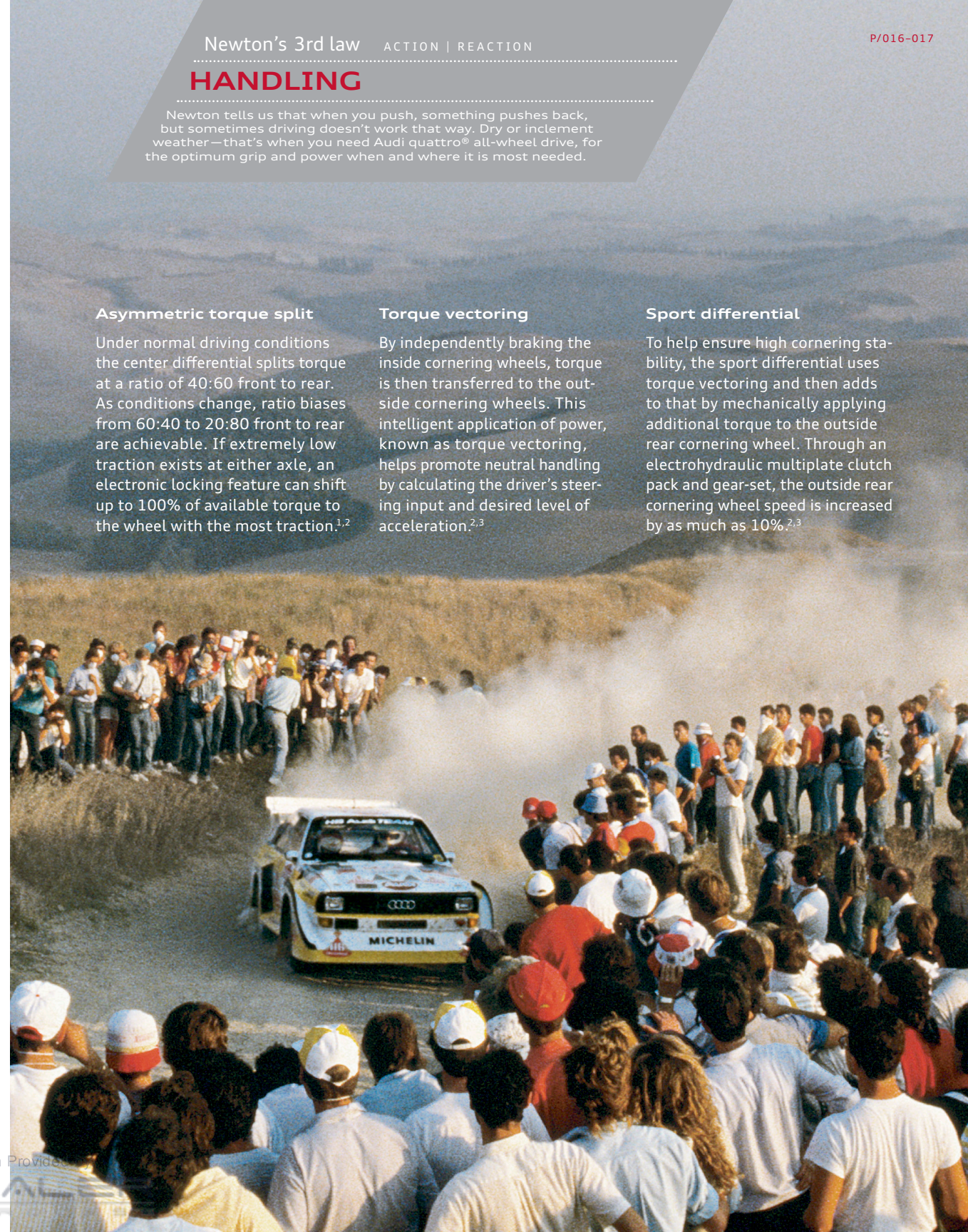



Newton's 2nd law MASS | ACCELERATION

**ACCELERATION**

Vehicles that are lightweight are the easiest to accelerate. Heavier vehicles require more energy to move and need more force in order to generate similar acceleration. The Audi performance lineup was created to make sizzling performance as powerful and efficient as possible.<sup>1</sup>

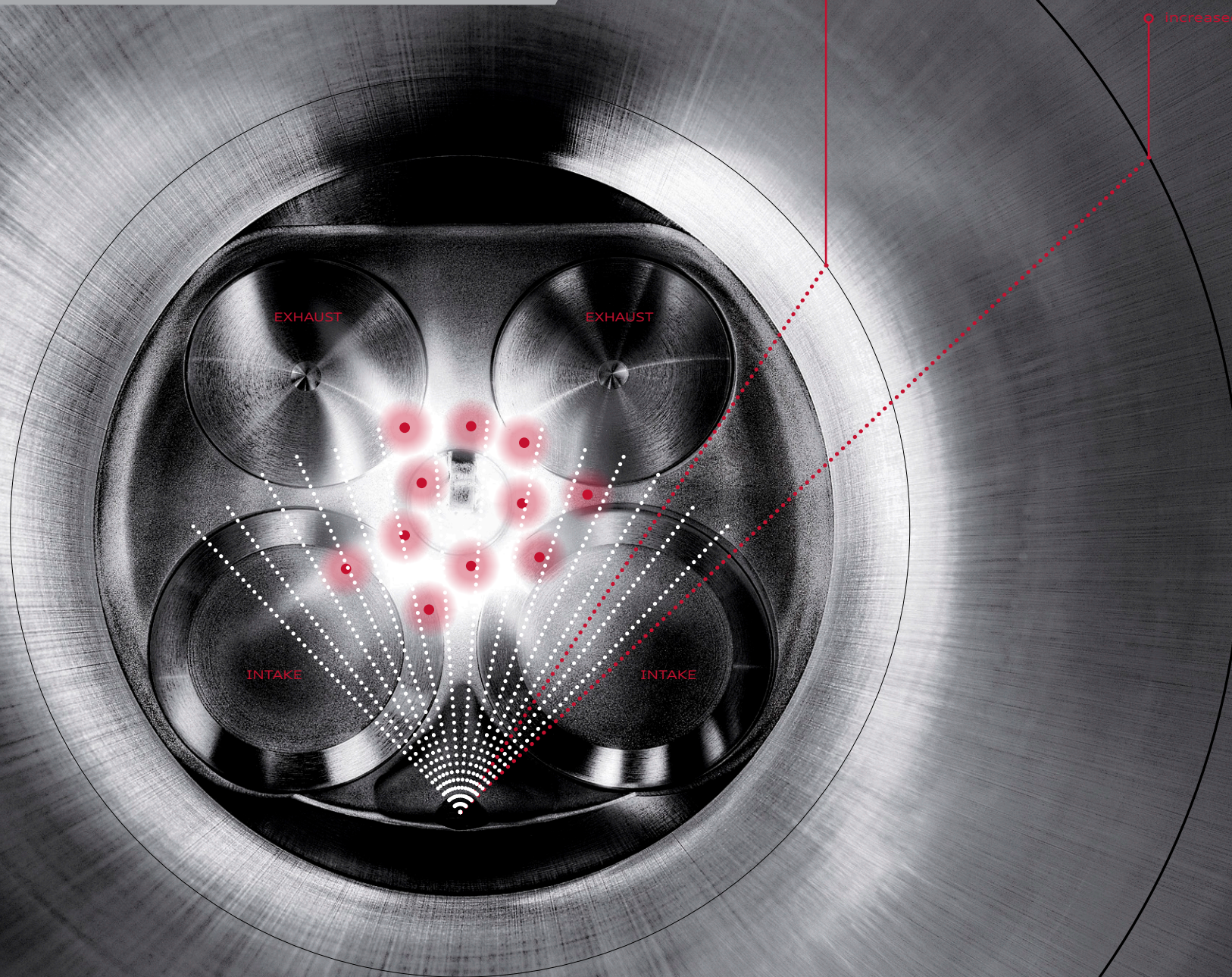

less load = shallower injection

increased load = deeper injection

**Ideas that burst through.**

The root of engineering is, of course, the engine. It's the basis of everything we do. So the engines of our Audi performance models not only deliver innovative ideas through performance engineering, but also put the driver at the center of our philosophy.

**FSI®**

The Audi FSI direct injection fuel management and delivery system directly injects fuel into the combustion chambers at precisely managed times and depths. What that means for drivers is that a fully homogenized intake charge helps increase power while also reducing fuel consumption and emissions, making efficiency more powerful.<sup>1</sup>

**TFSI®**

At Audi, TFSI represents a combination of two of the brand's core areas of expertise — direct injection and forced induction. By adding forced induction (turbocharging or supercharging) to Audi FSI direct injection, the pressurized intake charge is cooled by directly injected fuel, thus achieving efficiency and performance combined with higher compression ratios — previously only attainable by naturally aspirated engines.<sup>1,2</sup>

**Audi cylinder on demand™**

In low-load situations like highway cruising, the Audi RS 7, S8, S7 and S6 make use of Audi cylinder on demand engine efficiency technology, which shuts down cylinders for greater efficiency.<sup>1</sup> Four cylinders can be deactivated when they aren't needed. And once full power is required, all cylinders fire back to life almost imperceptibly.<sup>2</sup>

**Valve lift and variable valve timing**

It isn't easy to mix a perfect cocktail, especially when the only ingredients are air, fuel and a spark. Sliding electromagnetic sleeves on the camshafts adjust the lift, duration and timing of the intake and exhaust valves to maximize each combustion cycle. The result is increased torque and less fuel consumption.<sup>1,2</sup>



Newton's 2nd law MASS | ACCELERATION

## TRANSFER OF POWER

Newtons are a unit of measure used to determine the force required to move an object. As we transfer power by shifting up through the gears, we're moving the car's mass by means of greater acceleration. Our transmissions deliver the newtons to make this happen.

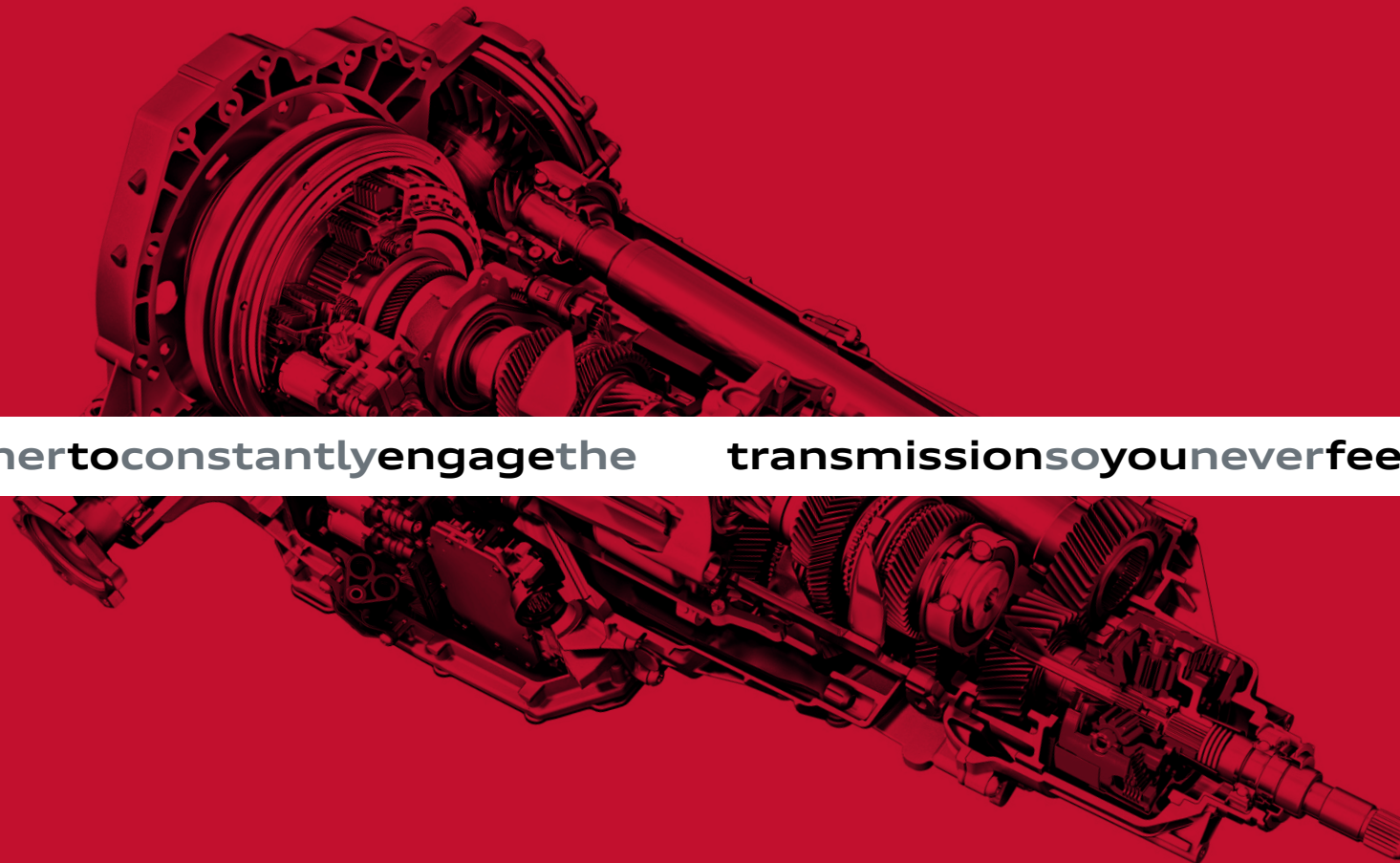

Dual clutches work together to constantly engage the transmission so you never feel a break in acceleration.

The boldest drivers always enjoy power without pause. Which is good, because that's our thinking behind the transmission offerings in Audi performance vehicles. It's why power can be intimately expressed by your hands with the use of steering wheel-mounted shift paddles or a console-mounted manual shifter. However you engage it, our transmissions are sure to deliver it, making sure power will be best felt in a virtually uninterrupted expression of progressive performance.<sup>1</sup>

### S tronic® transmission

The Audi R8, RS 5, S7, S6, S5, S4 and TTS models change gears in a few hundredths of a second with the Audi S tronic dual-clutch transmission, delivering automatic convenience with manual sportiness. While the available launch control system heightens acceleration through precisely managed engine speed and an automated clutch release.<sup>2</sup>

### Tiptronic® transmission

In the Audi RS 7, S8 and SQ5, power is transferred through an eight-speed Tiptronic® automatic transmission. With a large spread of gear ratios, this transmission helps optimize the engine speed for responsive power delivery and enhanced efficiency.<sup>3</sup> A Dynamic Shift Program (DSP) provides smooth and sporty gear changes.

### Manual transmission

Audi R8, S5 Coupe and S4 models offer a manual transmission to put the driver at center stage. Master the timing, feel and art of the perfect shift through a six-speed manual transmission with a precise, short, clearly defined shifter throw. As an added benefit, a self-adjusting clutch moderates clutch release load for consistent shifting performance.

<sup>1</sup> Features and technologies listed will not be available on all models. <sup>2</sup> Obey all speed and traffic laws. <sup>3</sup> See [www.fueleconomy.gov](http://www.fueleconomy.gov) for EPA estimates. Your mileage will vary.



Information Provided  
**DEALER**  
 BY PROCESS



## BRAKING

The law is never more evident than when inertia is interrupted—as when you brake. Stopping vehicle mass and momentum involves an enormous amount of force, and the by-product is expressed in heat. It's the heat we can handle.

## Handling the heat in the coolest way possible.

Let's just say that we can take the heat. An extraordinary amount, in fact, due to the technologies we employ throughout our Audi Sport® performance line. As the perfect counterbalance for performance driving, our cast-iron and Audi ceramic braking technologies are far from conventional.<sup>1</sup> By reducing the dynamic weight and by managing the dissipation of heat through cross-drilled perforation, wave-cut design or the use of carbon-ceramic composites, our brakes deliver increased resistance to fade, ultimately helping increase braking performance.<sup>2</sup>

Carbon fiber-reinforced ceramics can withstand temperatures up to

# 1830°F

sophisticated ventilation and perforation for optimal cooling

in contrast to cast-iron brake discs, carbon ceramic brake discs are lighter and more resistant to fading



wave-cut design for 6.61-lb weight reduction compared to traditional cast-iron brake rotors<sup>2</sup>

up to 8.82-lb weight reduction for each front brake rotor compared to traditional cast-iron brakes<sup>2</sup>



Information Provided by:  
**DEALER**  
E-PROCESS

<sup>1</sup> Obey all speed and traffic laws. <sup>2</sup> Features and technologies listed will not be available on all models.



Newton's 2nd law  $MASS | F=ma$

# LIGHTWEIGHT

A lower mass needs less force to accelerate. That also means it needs less force to stop, making braking easier. There are many benefits of lightweight design—including more precise cornering and greater engine efficiency.<sup>1</sup>

horsetail bamboo // Ackerschachtelhalm

shaft

node

shaft

node

shaft

## Efficiency is a natural selection.

As engineers, we don't add more of something when less will be more effective. For inspiration, we looked to nature, and discovered the fascinating design of bamboo. Lightweight yet strong, bamboo is a great example of natural efficiency. Taking our cues from it, our design adds strength at the conjoined areas (nodes), while the structural burdens in some aluminum extrusions (shafts) help to lower the overall weight. It allows for both rigidity and flexibility where each is most needed, and for efficiency overall.<sup>2</sup> This kind of progressive thinking seems like a natural selection to us?

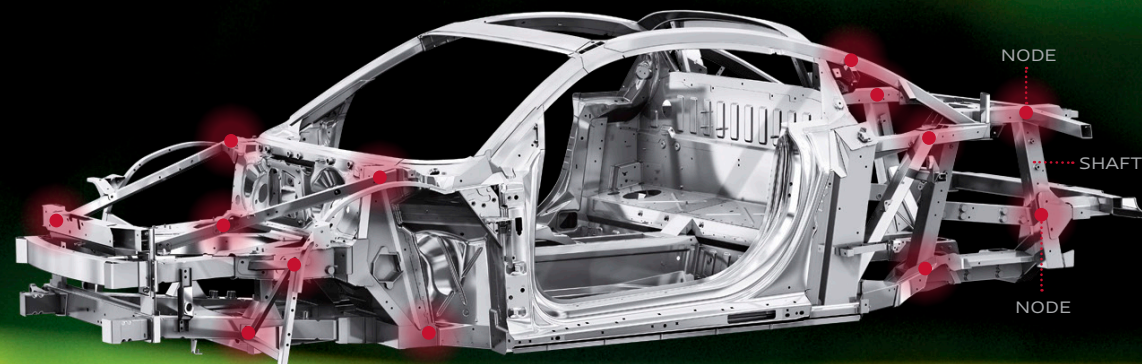

<sup>1</sup> See [www.fueleconomy.gov](http://www.fueleconomy.gov) for EPA estimates. Your mileage will vary. <sup>2</sup> Features and technologies listed will not be available on all models.



## WEIGHT BALANCE

Balance is important for control, but balance as an overall concept is just as important. Too much material increases weight, too little decreases rigidity. In the middle, in harmony, lies the truth.

## You might say that performance itself hangs in the balance.

We feel you never have to balance performance with design — rather, you need balance designed to optimize performance. Where certain features are placed, how much they weigh and how they operate in unison all help sharpen agility and turn the idea of balance into a driver's dream. In an Audi performance car where the engine is located in front, the battery is placed in the rear. Further enhancing weight distribution, most Audi performance models are equipped with brake calipers mounted inboard on the brake rotor, helping center the vehicle's mass for improved balance. With the Audi R8 Spyder, the front of the car is constructed of aluminum while the rear fenders and engine cover are partially constructed of carbon fiber-reinforced polymer (CFRP). All of this balances the vehicle's center of gravity, which in turn helps make handling more dynamic and true.<sup>2</sup>

### ASF® aluminum construction

Flexible yet unyielding, revolutionary ASF aluminum construction offers an innovative approach to weight and balance, a benefit you will notice in the Audi R8, S8 and TTS models' overall efficiency,<sup>1</sup> enhanced performance and remarkable handling. These characteristics also result in a superb and stable energy-dissipating structure in the event of a collision.

### Aluminum hybrid construction

There is a reason cream rises to the top. At Audi, we don't take weight lightly. That's because we see using less weight as a way to improve performance — to be more efficient,<sup>1</sup> to be more in control. We use aluminum along with steel in order to reduce and balance the Audi RS 7, S7 and S6 models' overall weight, which helps improve handling, keeps our core strong and enhances overall performance.



lower center of gravity = better balance



<sup>1</sup> See [www.fueleconomy.gov](http://www.fueleconomy.gov) for EPA estimates. Your mileage will vary. <sup>2</sup> Features and technologies listed will not be available on all models.



## DRIVING DYNAMICS

The third law talks about things that Audi drive select addresses with a push of a button. Through different modes of driving dynamics and performance options, Audi drive select helps you meet the equal and opposite forces of the road on your own terms.

### Pit crews at the touch of a button.

We talk a lot about power, performance, technology—the things that make Audi distinctive. Available Audi drive select adds to that by helping make your own driving experience distinctive, almost like a pit crew that is always at hand. This is customizable technology for driving that helps you control the characteristics of your drive through more finely defined precision handling, increasingly taut and precise throttle response or a more relaxed feel in the cockpit. Choose from Dynamic, Comfort, Auto or Individual modes to configure the throttle, transmission, steering and the suspension settings along with the sport differential to respond to your desires, or the conditions.<sup>1</sup> It's your choice. It helps bring out the best of your performance vehicle, of course. But it also helps bring out the best in you, without needing an entire crew to tune your driving characteristics for the road ahead.

#### Dynamic mode

More precise steering, more responsive throttle and quicker shifting focus performance while stiffer suspension gives this setting an uncompromising feel.<sup>1</sup>

#### Comfort mode

Perfect for less-than-perfect roads, this setting provides a silkier, more relaxed feel for steering, throttle, and transmission inputs while also providing a softer suspension setting to maximize a more comfortable ride.<sup>1</sup>

#### Auto mode

Auto mode helps deliver the best of both worlds by automatically adjusting to the optimal settings for a seamless combination of comfort and handling.<sup>1</sup>

#### Individual mode

Take the turn your way. Adjust the steering, throttle response and suspension to your style, and this setting will be yours whenever you choose it.<sup>1</sup>



<sup>1</sup> Features and technologies listed will not be available on all models.



Information Provided by:

DEALER  
E-PROCESS



# ROTATIONAL MOMENTUM

In the end, Newton's Laws of Motion deal with balance. Audi engineers work tirelessly to channel inertia into a fully expressed form of power and control, so the inertia exerted by rotational momentum finds the balance it needs to work properly, in context of the drive.

## Here's where performance comes full circle. ◻

This is how you feel the power that's expressed when you are in the driver's seat. Through superior handling and balance that help keep the power where it belongs, Audi suspension systems help you define performance in the boldest terms.

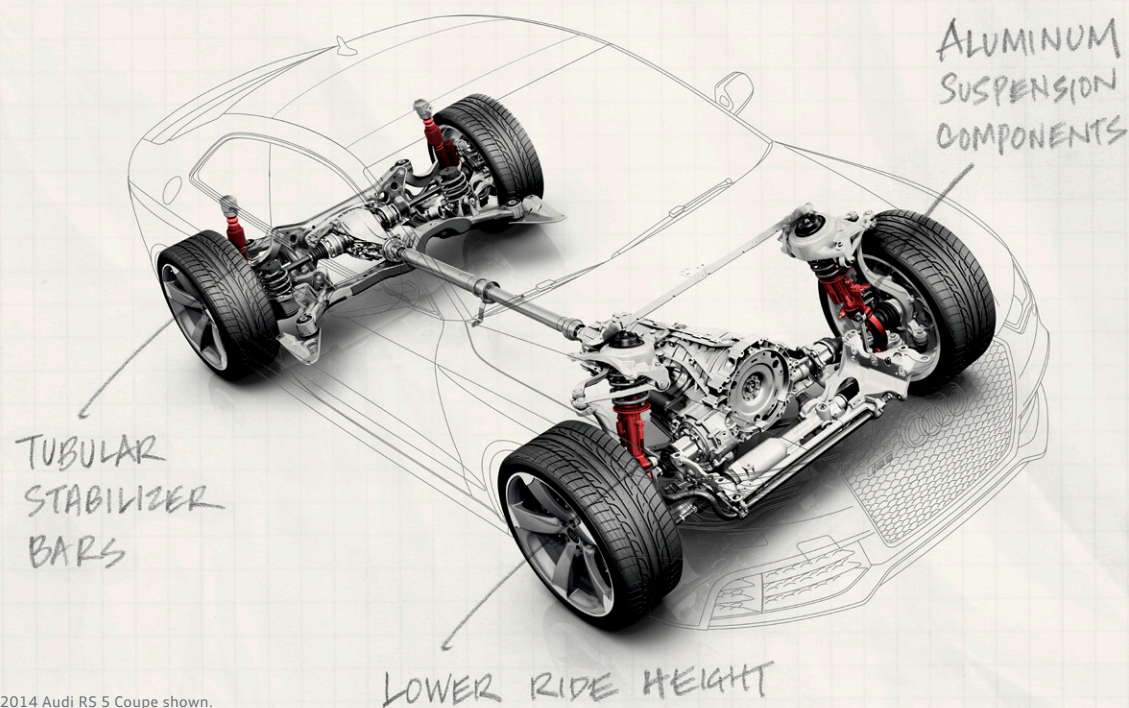

2014 Audi RS 5 Coupe shown.

### Sport suspension

By reducing the ride height, Audi sport suspension calibration helps to truly define the responsive, quick-to-the-touch handling that sets Audi performance models apart. We've designed the springs and dampers with firmer tuning to help optimize contact with the road surface, letting you put meaning to the word *agility*.

### Audi magnetic ride

Instead of conventional damper oil, the Audi R8 and TTS shocks and struts are filled with a special fluid, where viscosity can be controlled by an electromagnetic charge. Audi magnetic ride suspension helps damping forces continuously adjust to current driving conditions to provide the right amount of suspension firmness in a fraction of a second.<sup>1</sup>

### Audi adaptive air suspension

Blending dynamic handling with true comfort, Audi RS 7, S8, S7 and S6 models offer sport-tuned adaptive air suspension that allows for speed-dependent lowering of the body, resulting in a lower center of gravity, which helps significantly improve your directional stability. Speed or driver-selectable control logic adjusts the air suspension springs at all four wheels, adjusting the ride height in milliseconds.<sup>1</sup>



translatory motion

VS

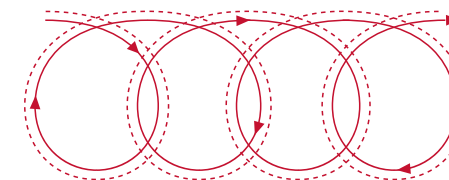

rotational momentum

Here's a case where knowing the law puts us on a more powerful path. By focusing on optimizing the rotational momentum in Audi performance models, we make more responsive and efficient vehicles?



lightweight alloy wheel // reduced wheel wall thickness for less rotational weight

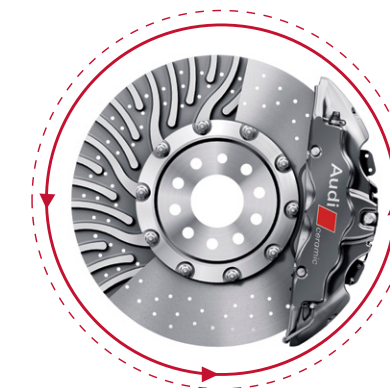

carbon ceramic rotor<sup>1</sup> // reduces rotational weight by up to 8.82 lb each

Acceleration // The more weight the component has, the more energy it takes to accelerate it (translatory motion) and overcome its inertia (rotational momentum). Deceleration // The more weight the component has, the more force it takes to overcome its inertia (rotational momentum) and decelerate its mass (translatory motion).



<sup>1</sup> Features and technologies listed will not be available on all models. <sup>2</sup> See www.fueleconomy.gov for EPA estimates. Your mileage will vary.



Intensity behind the wheel.

**RS**

**RS 7**

**RS 5**

**S8**

**S7**

**S6**

**S5**

**S4**

**TT S**

**SQ5**



Information Provided by:  
**DEALER**  
E-PROCESS



# The driver's choice. By acclamation, and exclamation.

Every inch a supercar, the refreshed Audi R8 defines the endless possibilities and incredible performance that Audi produces throughout its lineup. But more than that, the R8 stands as the dynamic, proud parent, passing on the legacy of its design, its power, its components and matchless materials throughout its Audi Sport® progeny. It may strike you like a thunderbolt when you first see it, it may seem immortal, but it is also every inch an Audi performance car. As such, it is the manifestation of desire, but also the blueprint for the dynamic models that follow. Discover these legendary performance cars and how they push the boundaries of the physical reality of Newton's Laws of Motion.

# R8

/ R8 COUPE / R8 SPYDER /



2014 Audi R8 V10 Coupe shown in Ice Silver metallic.



V8 or V10 FSI® engine  
430 to 550 horsepower  
0-60 mph in 3.3 to 4.6 seconds  
Top track speed of 186 to 198 mph<sup>1</sup>

P/034-035

R8

2014 Audi R8 V10 Spyder shown in Daytona Gray pearl.

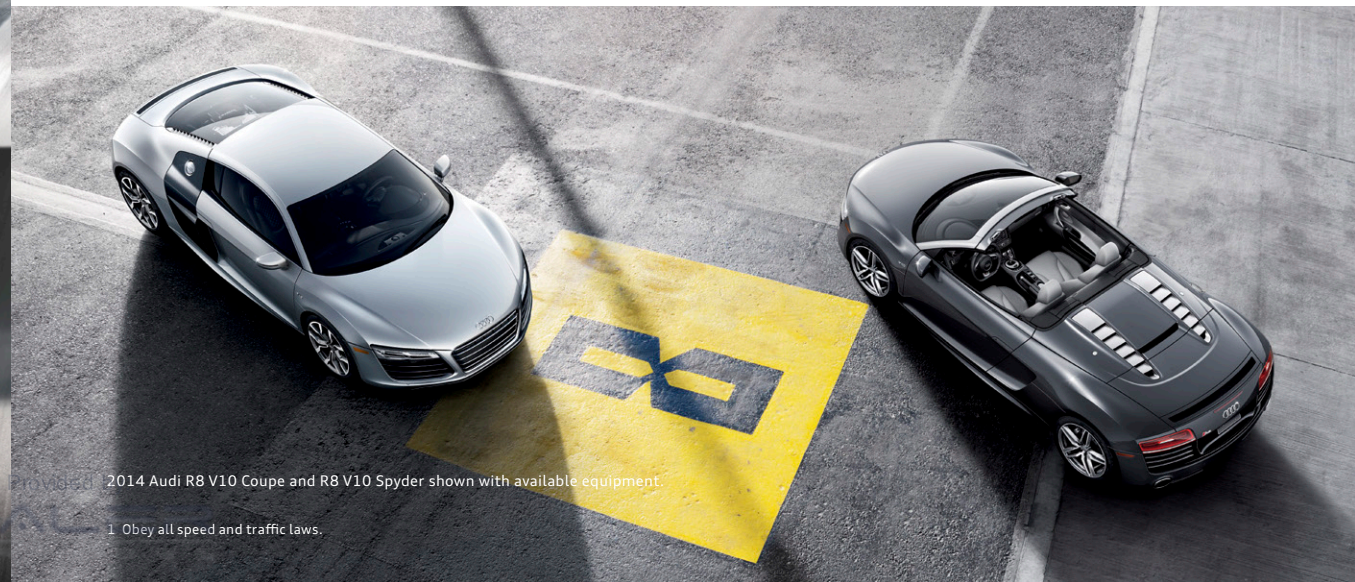

Information P/034-035 2014 Audi R8 V10 Coupe and R8 V10 Spyder shown with available equipment.

<sup>1</sup> Obey all speed and traffic laws.





2014 Audi R8 V10 Spyder shown with Titanium Gray leather and available equipment.

# R8

/ R8 COUPE / R8 SPYDER /

The redesigned 2014 Audi R8 is just as exhilarating when driven on an ordinary road as it is on an extraordinary track. It's a prime example of how our racing DNA is directly transferred to our production vehicles – from the exceptional performance of the R8 V8 with its 430 hp and 317 lb-ft of torque to the stunning R8 V10 plus, whose FSI® direct-injected DOHC V10 belts out 550 hp and 398 lb-ft of torque with a maximum engine speed of 8,700 rpm. And with each model featuring Audi ultra® lightweight technology–inspired Audi ASF® aluminum construction, legendary Audi quattro® all-wheel drive, and a six-speed manual or newly available seven-speed Audi S tronic® dual-clutch transmission, you can bet that their performance is like nothing you've experienced before.<sup>1</sup>



ENGINE // 5.2-liter FSI® V10 engine developing 550 hp and 398 lb-ft of torque  
5.2-liter FSI® V10 engine developing 525 hp and 391 lb-ft of torque  
4.2-liter FSI® V8 engine developing 430 hp and 317 lb-ft of torque

DRIVETRAIN // Audi quattro® all-wheel drive, six-speed manual transmission or an available seven-speed Audi S tronic® dual-clutch transmission

CHASSIS // R8 tuned sport suspension, Audi magnetic ride (not available on R8 V10 plus)

BRAKES // 14.4" ventilated wave design front disc brakes with R8 logo, 14.0" ventilated wave design rear disc brakes or available Audi ceramic brakes (Audi ceramic brakes are standard on R8 V10 plus)

PERFORMANCE // R8 V10 plus – Top track speed of 198/197 mph (manual/S tronic),<sup>1</sup> acceleration 0–60 mph in 3.7/3.3 seconds (manual/S tronic). R8 V10 – Top track speed 196/195 mph (Coupe, manual/S tronic) and 194/193 mph (Spyder, manual/S tronic),<sup>1</sup> acceleration 0–60 mph in 3.8/3.4 seconds (Coupe, manual/S tronic), 4.0/3.6 seconds (Spyder, manual/S tronic). R8 V8 – Top track speed of 188/186 mph (Coupe, manual/S tronic) and 186 mph (Spyder),<sup>1</sup> acceleration 0–60 mph in 4.4/4.2 seconds (Coupe, manual/S tronic) and 4.6/4.4 seconds (Spyder, manual/S tronic)<sup>1</sup>

Information Provided by:

DEALER  
E-PROCESS

<sup>1</sup> Obey all speed and traffic laws.



It is the kind of arrival that announces itself. The all-new Audi RS 7 comes into the world not so much unveiled as unleashed. A sleek, powerful presence of sophisticated design and roaring performance makes it clear that this is an unmistakable, undisguised automotive statement. At 560 hp, through a turbocharged 4.0-liter TFSI® V8 engine, it brings thundering performance, and with Audi quattro® all-wheel drive with sport differential and RS 7 tuned Audi adaptive air suspension, that power is never unrefined. We designed it to sit slightly lower to the ground, and added larger air intakes and a sportier chin spoiler to give it an even sharper sense of fluidity. Finally, RS exclusive dual oval exhausts provide the emphatic flourish of a true performer.

# RS 7



2014 Audi RS 7 shown in Daytona Gray pearl with available equipment.

4.0-liter turbocharged TFSI® V8 engine  
560 horsepower  
0-60 mph in 3.7 seconds  
Top track speed of 174 mph<sup>1</sup>

P/038-039

RS 7



2014 Audi RS 7 shown in Daytona Gray pearl with available equipment.



2014 Audi RS 7 shown in Daytona Gray pearl with available equipment.

<sup>1</sup> Top track speed is electronically limited in the U.S. Obey all speed and traffic laws.

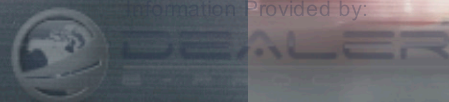





# RS 7

The potency of the all-new Audi RS 7, in style and in performance, is unmistakable, even at first glance. But that's not to say there are no surprises. With Audi cylinder on demand™ engine efficiency technology, which shuts down four cylinders when power and out-and-out performance are not required, the RS 7 has the ability to sip fuel when it's engaged.<sup>2</sup> The RS 7 is luxury performance personified, with signature Audi fit and finish throughout the interior, technology to spare and style to burn. It is desire in its most stunning form.

European model shown with available equipment.

ENGINE // 4.0-liter turbocharged TFSI® V8 engine developing 560 hp and 516 lb-ft of torque

DRIVETRAIN // Audi quattro® all-wheel drive with sport differential, eight-speed Tiptronic® automatic transmission

CHASSIS // RS 7 tuned Audi adaptive air suspension, Audi drive select and dynamic steering

BRAKES // 15.4" ventilated wave design front disc brakes with RS logo, 14.0" ventilated wave design rear disc brakes

PERFORMANCE // Top track speed of 174 mph,<sup>1</sup> acceleration 0-60 mph in 3.7 seconds

<sup>1</sup> Top track speed is electronically limited in the U.S. Obey all speed and traffic laws. <sup>2</sup> EPA estimates not available at time of printing. See [www.fueleconomy.gov](http://www.fueleconomy.gov) for updated information. Your mileage will vary.

Information Provided by:



DEALER  
BY APPOINTMENT

quattro



The Audi RS 5 doesn't come with a sign that says "For Serious Drivers Only." It doesn't have to—everyone just knows. Factory-tuned and stunningly executed, and now with an all-new Cabriolet variant, this progressive performance car showcases an aggressive front end, wide wheel arches and adaptive rear spoiler (Coupe only). But the power is what really makes this a definitive statement of Audi Sport® performance. Featuring a 4.2-liter FSI® V8 engine that produces 450 hp, along with a seven-speed Audi S tronic® dual-clutch transmission that helps funnel power to the road through nearly seamless shifts and the legendary Audi quattro® all-wheel drive. The result? An Audi RS 5 sprinting from 0 to 60 mph in 4.5–4.9 seconds with a thundering affirmation from the RS exclusive oval exhaust outlets.

4.2-liter FSI® V8 engine  
450 horsepower  
0–60 mph in 4.5 to 4.9 seconds  
Top track speed of 174 mph<sup>1</sup>

# RS 5

/ RS 5 COUPE / RS 5 CABRIOLET /



2014 Audi RS 5 Coupe shown in Ibis White with available Black Optic package.



2014 Audi RS 5 Cabriolet shown in Estoril Blue crystal with available Matte Aluminum Optic package.



2014 Audi RS 5 Coupe shown in Ibis White with available Black Optic package and optional sport exhaust system.

<sup>1</sup> Top track speed is electronically limited in the U.S. Obey all speed and traffic laws.





2014 Audi RS 5 Coupe shown with Lunar Silver leather and available equipment.



# RS 5

/ RS 5 COUPE / RS 5 CABRIOLET /

Not to be outdone by the exterior design, the Audi RS 5 interior is a statement of design infused with performance. With a driver-centric cockpit informed with touches of Fine Nappa leather on the seats and door armrests, twelve-way power front sport seats emblazoned with RS 5 contrasting embroidery, Carbon Fiber or available Aluminum Race decorative inlays, and a multifunction flat-bottom sport steering wheel with shift paddles, the RS 5 is built with a purpose. Making your purpose clear—to drive one.

ENGINE // 4.2-liter FSI® V8 engine developing 450 hp and 317 lb-ft of torque

DRIVETRAIN // Audi quattro® all-wheel drive with sport differential, seven-speed Audi S tronic® dual-clutch transmission

CHASSIS // RS 5 tuned sport suspension, Audi drive select and available dynamic steering

BRAKES // 14.4" ventilated wave design front disc brakes with RS logo, 12.8" ventilated wave design rear disc brakes or available 14.9" Audi ceramic front disc brakes

PERFORMANCE // Top track speed of 174 mph<sup>1</sup>; acceleration 0–60 mph in 4.5 seconds (Coupe) and 4.9 seconds (Cabriolet)

1. Top track speed is electronically limited in the U.S. Obey all speed and traffic laws.



Information Provided by:

DEALER  
EXPERIENCE





For those who strive for power on a grand scale, we'd like to introduce the Audi S8. From the 4.0-liter TFSI® V8 engine delivering an astonishing 520 hp and 481 lb-ft of torque to the ingenious fuel-saving Audi cylinder on demand™ engine efficiency technology, the S8 is as athletic as it is innovative.<sup>1</sup> And with dramatic driving characteristics made possible by the signature Audi ASF® aluminum construction and Audi quattro® all-wheel drive with sport differential—and stunning exterior design lines ripped from a perfectionist's drafting board—the S8 confidently delivers an ultrapowerful sports luxury experience. And more.

4.0-liter turbocharged TFSI® V8 engine  
520 horsepower  
0-60 mph in 3.9 seconds  
Top track speed of 155 mph<sup>2</sup>

# S8



2014 Audi S8 shown in Ice Silver metallic with available equipment.



Information provided by:

<sup>1</sup> EPA estimates not available at time of printing. See [www.fueleconomy.gov](http://www.fueleconomy.gov) for EPA estimates. Your mileage will vary. <sup>2</sup> Top track speed is electronically limited in the U.S. Obey all speed and traffic laws.





# S8

To truly set a new standard of luxury performance, you need luxury and performance to be equally unmistakable. So while the Audi S8 wears performance on its sleeve, it also features unsurpassed luxury at its core. Sumptuous 22-way sport comfort front seats with exclusive Valcona leather and contrast diamond stitching enthrall the driver and front passenger, while the Alcantara® headliner and Carbon Atlas decorative inlays add to its Audi Sport® character. By the time you've discovered the unparalleled convenience of Audi MMI® touch and Audi connect® with Google Earth™ with satellite imagery, you've found a sanctuary for your soul as much as a thrill for your right foot.<sup>1,2</sup>



European model shown with available equipment.

- ENGINE // 4.0-liter turbocharged TFSI® V8 engine developing 520 hp and 481 lb-ft of torque
- DRIVETRAIN // Audi quattro® all-wheel drive with sport differential, eight-speed Tiptronic® automatic transmission
- CHASSIS // S8 tuned Audi adaptive air suspension, Audi drive select and dynamic steering
- BRAKES // 15.7" ventilated front disc brakes with S8 logo, 14.0" ventilated rear disc brakes
- PERFORMANCE // Top track speed of 155 mph<sup>3</sup>; acceleration 0-60 mph in 3.9 seconds

Information Provided by:  
**DEALER**  
E-PROCESS

<sup>1</sup> Distracted driving can cause a loss of vehicle control. The features and technologies discussed above are offered for convenience, and should be used only when it is safe and appropriate. The Wi-Fi® hotspot feature is intended for passenger use only. Always pay careful attention to the road, and do not drive while distracted. See dealer for details. <sup>2</sup> Obey all speed and traffic laws. <sup>3</sup> Top track speed is electronically limited in the U.S. Obey all speed and traffic laws.



Certain drivers know that sometimes it's a good thing to blow everything out of proportion. Like design. Like performance. Like innovation. In that spirit, think of our Audi S7 as a powerful piece of performance art. It's a design and engineering statement that takes proportion and stretches it along an iconic Tornado line that, once followed from the hood, enters new territory about the time you reach the rear. Bold and sophisticated, the sloping tailgate of this performance five-door coupe becomes the signature cue for this most stylish expression of Audi performance.

# S7



2014 Audi S7 shown in Ice Silver metallic with available equipment.

4.0-liter turbocharged TFSI® V8 engine  
420 horsepower  
0-60 mph in 4.5 seconds  
Top track speed of 155 mph<sup>1</sup>

P/050-051

S7



2014 Audi S7 shown in Glacier White metallic with available equipment.



<sup>1</sup> Top track speed is electronically limited in the U.S. Obey all speed and traffic laws.



Information provided by

DEALER





# S7

Just because the Audi S7 is design-forward doesn't mean power lags behind. The 420-hp 4.0-liter TFSI® V8 takes full advantage of its aerodynamic shape to shred 0-60 mph times, while driving in full control with permanent Audi quattro® all-wheel drive.<sup>1</sup> And when you are simply cruising, the Audi cylinder on demand™ engine efficiency technology uses only the piston power that's necessary, helping make your drive more efficient.<sup>2</sup> The Audi S7 is finely designed performance that sizzles on the pavement, while the look burns even when standing still.



2014 Audi S7 shown with Black leather and available equipment.

- ENGINE // 4.0-liter turbocharged TFSI® V8 engine developing 420 hp and 406 lb-ft of torque
- DRIVETRAIN // Audi quattro® all-wheel drive with sport differential, seven-speed Audi S tronic® dual-clutch transmission
- CHASSIS // S7 tuned Audi adaptive air suspension, Audi drive select
- BRAKES // 15.7" ventilated front disc brakes with S7 logo, 14.0" ventilated rear disc brakes
- PERFORMANCE // Top track speed of 155 mph<sup>3</sup>, acceleration 0-60 mph in 4.5 seconds

Information Provided by:  
**DEALER**  
E-PROCESS

1. Obey all speed and traffic laws. 2. EPA estimates not available at time of printing. See [www.fueleconomy.gov](http://www.fueleconomy.gov) for EPA estimates. Your mileage will vary. 3. Top track speed is electronically limited in the U.S. Obey all speed and traffic laws.



The Audi S6 isn't here to play nice, no matter how composed it feels. In a lineup of progressive performance, you have to stand out in your own way. Effortlessly unleashing its 4.0-liter TFSI® V8 engine to produce an unrelenting 420 hp helps give you a seemingly endless stream of power.<sup>1</sup> But what is power without control? That's where the legendary Audi quattro® all-wheel drive with sport differential and S6 tuned Audi adaptive air suspension come into play. Never have stature, sophistication and sport felt so playfully powerful.

4.0-liter turbocharged TFSI® V8 engine  
420 horsepower  
0-60 mph in 4.5 seconds  
Top track speed of 155 mph<sup>1</sup>

# S6



2014 Audi S6 shown in Ice Silver metallic with available equipment.



<sup>1</sup> Top track speed is electronically limited in the U.S. Obey all speed and traffic laws.





# S6

The driver should sense the difference performance luxury makes immediately. Seductive yet assertive, the Audi S6 features an interior that captures the imagination through signature sport seats with integrated head restraints covered in Valcona leather and accented by available Carbon Atlas or a choice of decorative wood inlays on the dashboard, center console and door panels. The S6 also delivers available driver assistance features like a night vision assistant with pedestrian detection and Audi MMI® Navigation plus, along with the connectivity of Audi connect®<sup>2</sup>. The S6 doesn't simply deliver on luxury, it gives drivers a new perspective on the world around them.

2014 Audi S6 shown with Lunar Silver leather and available equipment.

- ENGINE // 4.0-liter turbocharged TFSI® V8 engine developing 420 hp and 406 lb-ft of torque
- DRIVETRAIN // Audi quattro® all-wheel drive with sport differential, seven-speed Audi S tronic® dual-clutch transmission
- CHASSIS // S6 tuned Audi adaptive air suspension, Audi drive select
- BRAKES // 15.7" ventilated front disc brakes with S6 logo, 14.0" ventilated rear disc brakes
- PERFORMANCE // Top track speed of 155 mph<sup>1</sup>, acceleration 0-60 mph in 4.5 seconds

<sup>1</sup> Top track speed is electronically limited in the U.S. Obey all speed and traffic laws. <sup>2</sup> Distracted driving can cause a loss of vehicle control. The features and technologies discussed above are offered for convenience, and should be used only when it is safe and appropriate. The Wi-Fi® hotspot feature is intended for passenger use only. Always pay careful attention to the road, and do not drive while distracted. See dealer for details.





Introducing the sports car's sports car. The Audi S5. The S5 brings more to the road, from its LED daytime running light technology to the Audi Singleframe® grille. Its iconic style never lets you forget the performance potential of the 3.0-liter TFSI® V6 engine that delivers a substantial 333 hp, all funneled to the road through a six-speed manual (Coupe only) or available seven-speed Audi S tronic® dual-clutch transmission and Audi quattro® all-wheel drive. With already brilliant driving dynamics and tight sport suspension calibration that puts you in total control, the S5 is ready for the most challenging drive in the world. Yours.

# S5

/ S5 COUPE / S5 CABRIOLET /



2014 Audi S5 Coupe shown in Ice Silver metallic.

3.0-liter supercharged TFSI® V6 engine  
333 horsepower  
0-60 mph in 4.9 to 5.3 seconds  
Top track speed of 155 mph<sup>1</sup>

P/058-059

S5



2014 Audi S5 Cabriolet shown in Ibis White with available equipment.



Information provided by:



<sup>1</sup> Top track speed is electronically limited in the U.S. Obey all speed and traffic laws.





# S5

/ S5 COUPE / S5 CABRIOLET /

The power and performance get the Audi S5 noticed, but the interior design generates a deep respect too. Signature sport design elements outfit the driver-centric cabin, while available Audi connect® with a Wi-Fi® hotspot for up to eight passenger devices helps you remain close even when you are far from it.<sup>1</sup> Available in Coupe or Cabriolet form, the S5 is the total package—stylish, luxurious, progressive and powerful. We like to think it's the kind of sports car that other sports cars dream of as the ideal.



- ENGINE // 3.0-liter supercharged TFST® V6 engine developing 333 hp and 325 lb-ft of torque
- DRIVETRAIN // Audi quattro® all-wheel drive, available sport differential, six-speed manual transmission (Coupe only) or an available seven-speed Audi S tronic® dual-clutch transmission
- CHASSIS // S5 tuned sport suspension, Audi drive select and available dynamic steering
- BRAKES // 13.6" ventilated front disc brakes with S5 logo, 13.0" ventilated rear disc brakes
- PERFORMANCE // Top track speed of 155 mph<sup>2</sup>; acceleration 0-60 mph in 4.9 seconds (Coupe) and 5.3 seconds (Cabriolet)

Information Provided by:

DEALER  
E-PROCESS

<sup>1</sup> Distracted driving can cause a loss of vehicle control. The features and technologies discussed above are offered for convenience, and should be used only when it is safe and appropriate. The Wi-Fi® hotspot feature is intended for passenger use only. Always pay careful attention to the road, and do not drive while distracted. See dealer for details. <sup>2</sup> Top track speed is electronically limited in the U.S. Obey all speed and traffic laws.



With classic sports sedan written all over the Audi S4, we know you'll be writing your own story together. For starters, style isn't prologue. It's intrinsic to the story. Beautifully rendered front and rear fasciae, aluminum-optic mirror housings and thundering quad exhaust outlets all add to the plot. Then performance takes the lead, thanks to the combination of a powerful engine and dynamic suspension.

# S4



2014 Audi S4 shown in Misano Red pearl.



Information Provided by:

DEALER

3.0-liter supercharged TFSI® V6 engine  
333 horsepower  
0-60 mph in 4.9 seconds  
Top track speed of 155 mph<sup>1,2</sup>

P/062-063

S4



2014 Audi S4 shown in Misano Red pearl with available equipment.



<sup>1</sup> Top track speed is electronically limited in the U.S. Obey all speed and traffic laws.  
<sup>2</sup> Top track speed is limited to 130 mph when equipped with all-season tires.





# S4

The climax of any Audi S4 story comes from the power produced by the supercharged 3.0-liter TFSI® V6 engine, which pumps out 333 hp and delivers an impressive 325 lb-ft of torque. With the option of a six-speed manual or a seven-speed Audi S tronic® dual-clutch transmission, you can serve up the performance any way you like it—and that's a line worthy of any well-told story.

2014 Audi S4 shown with Black/Magma Red leather and available equipment.

ENGINE // 3.0-liter supercharged TFSI® V6 engine developing 333 hp and 325 lb-ft of torque

DRIVETRAIN // Audi quattro® all-wheel drive, available sport differential, six-speed manual transmission or an available seven-speed Audi S tronic® dual-clutch transmission

CHASSIS // S4 tuned sport suspension, Audi drive select and available dynamic steering

BRAKES // 13.6" ventilated front disc brakes with S4 logo, 13.0" ventilated rear disc brakes

PERFORMANCE // Top track speed of 155 mph,<sup>1,2</sup> acceleration 0-60 mph in 4.9 seconds

1 Top track speed is electronically limited in the U.S. Obey all speed and traffic laws. 2 Top track speed is limited to 130 mph when equipped with all-season tires.



Information Provided by:

DEALER  
BY PROCESS





The Audi TTS stands apart. Its commitment to progressive performance is felt in every stitch and every corner—yet the TTS delivers even more. Style, for starters. The more aggressive lines of the TTS speak of power—and its brilliant design showcases the passion that its performance inspires. Meanwhile, the nimble TTS delivers dynamic driving through lightweight materials and a responsive throttle. In all, the balance, style and power make for a vehicle that stands out in a standout Audi performance lineup.

2.0-liter turbocharged TFSI® four-cylinder engine  
265 horsepower  
0-60 mph in 4.9 to 5.1 seconds  
Top track speed of 155 mph<sup>1</sup>

# TTS

/ TTS COUPE / TTS ROADSTER /



2014 Audi TTS Roadster shown in Ibis White.



2014 Audi TTS Coupe shown in Misano Red pearl.



<sup>1</sup> Top track speed is electronically limited in the U.S. Obey all speed and traffic laws.





# TTS

/ TTS COUPE / TTS ROADSTER /

The power is articulated by a 265-hp 2.0-liter TFSI® engine and transferred to the road through a rapid-shifting Audi S tronic® dual-clutch transmission, taking full advantage of the streamlined weight and shape of the TTS. And thanks to the Audi ultra® lightweight technology-inspired ASF® aluminum construction, specially tuned Audi magnetic ride suspension and Audi quattro® all-wheel drive, your TTS is ultrasensitive and nimble. Put it all together and you have a high-tech performance machine that lets you drive your TTS the way it was meant to be driven.<sup>1</sup>



2014 Audi TTS Roadster shown with Black/Magma Red leather and available equipment.



- ENGINE // 2.0-liter turbocharged TFSI® four-cylinder engine developing 265 hp and 258 lb-ft of torque
- DRIVETRAIN // Audi quattro® all-wheel drive, six-speed Audi S tronic dual-clutch transmission
- CHASSIS // TTS tuned sport suspension, Audi magnetic ride
- BRAKES // 13.4" ventilated front disc brakes with TTS logo, 12.2" ventilated rear disc brakes
- PERFORMANCE // Top track speed of 155 mph,<sup>2</sup> acceleration 0-60 mph in 4.9 seconds (Coupe) and 5.1 seconds (Roadster)

Information Provided by:  
**DEALER**  
BY PROCESS

1. Obey all speed and traffic laws. 2. Top track speed is electronically limited in the U.S. Obey all speed and traffic laws.



It's a riveting, powerfully rendered solution to a long-standing conundrum about finding the perfect SUV. It used to be, "What is it?" With the all-new Audi SQ5, now we know. It's everything. It is versatile in performance and handling, with Audi quattro® all-wheel drive making its presence felt. It is crisply stylish, an SUV smartly streamlined by signature design lines and a wide stance. But it is also sculpted muscle and luxury refinement. It has the numbers, it wears its available Fine Nappa leather well. It is an Audi SUV literally shaped and imbued with Audi power. The SQ5 is the stunning everything in elevated performance.

3.0-liter supercharged TFSI® V6 engine  
354 horsepower  
0-60 mph in 5.1 seconds  
Top track speed of 155 mph<sup>1</sup>

# SQ5



2014 Audi SQ5 shown in Ice Silver metallic with available equipment.



2014 Audi SQ5 shown in Estoril Blue crystal with available equipment.

<sup>1</sup> Top track speed is electronically limited in the U.S. Obey all speed and traffic laws.





# SQ5

Imagine an interior so exquisite that its only possible counterpart could be the bold lines and aggressive stance of the all-new Audi SQ5. An interior that never lets you forget you're driving one of the most exhilarating SUVs on the road, while doing so with a level of class that can only be described as trademark Audi. Available Fine Nappa leather graces the sport front seats, finely crafted Aluminum-layered Black Wood inlays surround you for just the right amount of flair, and voluminous cargo space, made even more capable by a 40/20/40-split rear seat, means far-flung family excursions are never out of the question.



2014 Audi SQ5 shown with Black leather and available equipment.

- ENGINE // 3.0-liter supercharged TFSI® V6 engine developing 354 hp and 346 lb-ft of torque
- DRIVETRAIN // Audi quattro® all-wheel drive, eight-speed Tiptronic® automatic transmission
- CHASSIS // SQ5 tuned sport suspension, Audi drive select and available dynamic steering
- BRAKES // 15.0" ventilated front disc brakes with S logo, 13.0" ventilated rear disc brakes
- PERFORMANCE // Top track speed of 155 mph<sup>1</sup>; acceleration 0-60 mph in 5.1 seconds

1. Top track speed is electronically limited in the U.S. Obey all speed and traffic laws.



Information Provided by:

DEALER

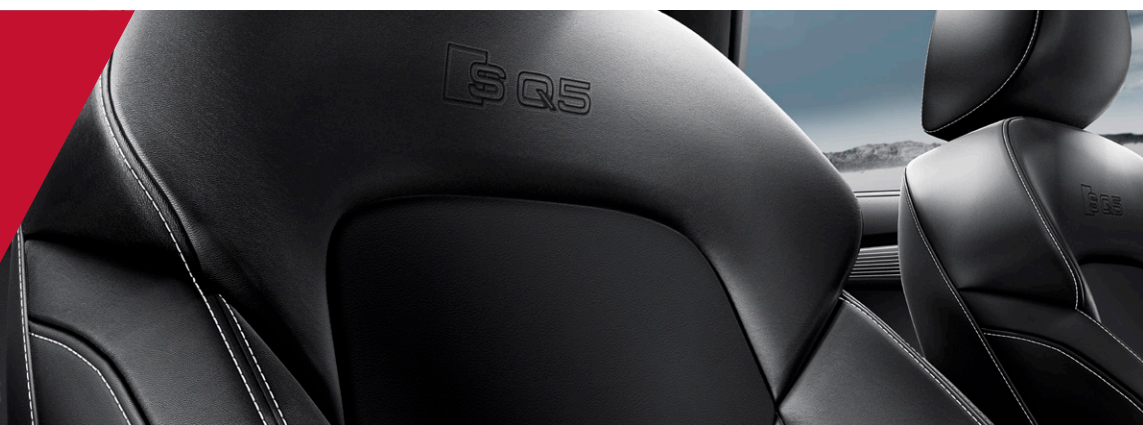



## Audi S line® packages

With available Audi S line and S line Competition packages, we give Audi Sport® style to a conventionally stunning Audi. So with an A4, A5, Q or TT model, you can get the more aggressive lines—and double takes—that come with Audi Sport design. More striking lines define the exterior, while inside we deliver high-end flourishes, like distinctive decorative inlays on the center console, doors and instrument panel—the glint of which might just match the gleam in your eye. Add to that an available flat-bottom three-spoke multifunction sport steering wheel and upgraded sport seats with Alcantara® or leather seating surfaces, and these premium features and packages become a sporty take on tradition.



▲ Audi A5 Coupe shown with Audi S line Competition package

- ▲ sport bumper
- ▲ rocker panels
- ▲ alloy wheels



▲ TT Coupe shown with Audi S line Competition package

- ▲ sport rear spoiler
- ▲ sport rear diffuser
- ▲ sport suspension

▼ Audi A5 Coupe shown with Audi S line Competition package

- ▼ sport seats
- ▼ sport steering wheel



▼ TT Coupe shown with Audi S line Competition package

- ▼ unique interior inlays





# They deliver the experience.

4.2-liter FSI® V8 | Horsepower: 450 @ 8,250 rpm | Torque: 317 @ 4,000 rpm | 0-60 mph: 4.5 sec



## R8 V10 plus Specifications and Available Featured Content

### Engineering/Performance

5.2-liter FSI® V10 engine  
 Horsepower: 550 @ 8,000 rpm/Torque: 398 @ 6,500 rpm  
 0-60 mph: 3.3-3.7 sec/Top track speed: 197-198 mph<sup>1</sup>  
 EPA mileage estimate<sup>2</sup>  
 ▶ Manual transmission: 12 city/19 highway/14 combined  
 ▶ Audi S tronic® dual-clutch transmission:  
 13 city/22 highway/16 combined  
 19.8-gallon fuel tank capacity

### Transmissions/Body/Suspension/Chassis

Six-speed manual transmission  
 Seven-speed Audi S tronic® dual-clutch transmission<sup>3</sup>  
 Audi ultra® lightweight technology—ASF® aluminum construction  
 R8 V10 plus sport suspension calibration  
 Audi quattro® all-wheel drive  
 14.9" ventilated front and 14.0" ventilated rear Audi ceramic disc brakes  
 Audi hill hold assist

### Safety

Driver and front passenger dual-stage airbags, head/thorax side airbags and knee airbags<sup>4</sup>  
 Electronic Stability Control (ESC) with traction control (ASR)  
 Anti-lock Brake System (ABS)  
 Electronic Brake-pressure Distribution (EBD) and brake assist

### Exterior

Audi Singleframe® grille  
 Full LED headlight technology  
 LED taillight technology  
 Carbon Fiber Sigma front spoiler lip  
 Carbon Fiber Sigma exterior side mirror housings  
 Carbon Fiber Sigma Audi sideblade  
 Adaptive rear spoiler  
 Carbon Fiber Sigma rear diffuser  
 R8 exclusive round exhaust outlets with Gloss Black finish  
 R8 V10 plus exterior appearance (Titanium Gray front and rear inlet grilles and flared side sills)  
 Black engine vent covers

### Interior/Seating

Automatic climate control  
 Flat-bottom three-spoke multifunction sport steering wheel (shift paddles with S tronic®)  
 Alcantara® headliner<sup>3</sup>  
 Carbon Fiber Sigma inlays  
 Leather/Alcantara® seating surfaces  
 Fine Nappa leather seats and door panel inserts<sup>3</sup>  
 Fine Nappa leather seats with contrast stitching<sup>3</sup>  
 Fine Nappa leather seats and door panel inserts with contrast diamond stitching<sup>3</sup>  
 Heated six-way manually adjustable front sport seats and four-way power lumbar adjustment  
 Twelve-way power front sport seats, including four-way power lumbar adjustment<sup>3</sup>  
 Carbon Fiber Sigma door sill inlays

### Infotainment/Technology

Audi Navigation plus  
 Driver information system with lap timer  
 Audi concert radio with seven speakers and six-disc CD changer and MP3 playback capability  
 Bang & Olufsen® Sound System with twelve speakers and 465 watts<sup>3</sup>  
 SiriusXM® Satellite Radio with 90-day trial subscription<sup>5</sup>  
 Audi music interface with iPod® integration<sup>3</sup>  
 BLUETOOTH® wireless technology preparation for mobile phone with safety belt microphones<sup>6</sup>  
 Cruise control with coast, resume and accelerate features  
 Garage door opener (HomeLink®)  
 Parking system plus (includes rear view camera and front/rear sensors)

### Available packages

#### Diamond-stitch Full Fine Nappa Leather package<sup>3</sup>

- ▶ Fine Nappa leather seats and door panel inserts with contrast diamond stitching
- ▶ Fine Nappa leather-wrapped dashboard and instrument panel cover
- ▶ Twelve-way power front sport seats, including four-way power lumbar adjustment

#### Full Fine Nappa Leather package<sup>3</sup>

- ▶ Fine Nappa leather seats and door panel inserts
- ▶ Fine Nappa leather-wrapped dashboard and instrument panel cover
- ▶ Twelve-way power front sport seats, including four-way power lumbar adjustment

#### Fine Nappa Leather package<sup>3</sup>

- ▶ Fine Nappa leather seats and door panel inserts
- ▶ Twelve-way power front sport seats, including four-way power lumbar adjustment

1 Top track speed is electronically limited in the U.S. Obey all speed and traffic laws. 2 EPA estimates. Your mileage will vary. 3 Available equipment. See dealer for details. 4 Airbags are supplemental restraints only and will not deploy under all crash circumstances. Always use safety belts and refer to your owner's manual for the proper use of the restraint systems when transporting children. 5 See back cover for important information about the Audi MMI® Navigation plus, Audi Navigation plus, and required SiriusXM® subscriptions. 6 Requires compatible phone.



Information Provided by  
**AL**  
 PROCESS



## R8 V10 Specifications and Available Featured Content

### Engineering/Performance

5.2-liter FSI® V10 engine
Horsepower: 525 @ 8,000 rpm/Torque: 391 @ 6,500 rpm
0–60 mph: 3.4–4.0 sec/Top track speed: 193–196 mph <sup>1</sup>
EPA mileage estimate <sup>2</sup>
▶ Manual transmission: 12 city/19 highway/14 combined
▶ Audi S tronic® dual-clutch transmission: 13 city/22 highway/16 combined
23.8-gallon (Coupe), 21.1-gallon (Spyder) fuel tank capacity

### Transmissions/Body/Suspension/Chassis

Six-speed manual transmission
Seven-speed Audi S tronic® dual-clutch transmission <sup>3</sup>
Audi ultra® lightweight technology—ASF® aluminum construction
Audi magnetic ride suspension with sport button program
Audi quattro® all-wheel drive
14.4" ventilated front and 14.0" ventilated rear disc brakes
Audi ceramic front and rear brakes <sup>3</sup>
Audi hill hold assist

### Safety

Driver and front passenger dual-stage airbags, head/thorax side airbags and knee airbags <sup>4</sup>
Electronic Stability Control (ESC) with traction control (ASR)
Anti-lock Brake System (ABS)
Electronic Brake-pressure Distribution (EBD) and brake assist

### Exterior

Audi Singleframe® grille
Gloss Black Audi Singleframe® grille <sup>3</sup>
Full LED headlight technology
LED taillight technology
Gloss Black front spoiler lip
Carbon Fiber Sigma Audi sideblade (Coupe) <sup>3</sup>
Adaptive rear spoiler
Gloss Black rear diffuser
R8 exclusive round exhaust outlets with chrome finish
R8 exclusive round exhaust outlets with Black finish <sup>3</sup>
R8 V10 exterior appearance (Gloss Black front and rear inlet grilles, and flared side sills)
Aluminum-optic engine vent covers

### Interior/Seating

Automatic climate control
Flat-bottom three-spoke multifunction sport steering wheel (shift paddles with S tronic®)
Alcantara® headliner (Coupe) <sup>3</sup>
Silk Matte Black decorative inlays
Piano Black decorative inlays <sup>3</sup>
Carbon Fiber Sigma decorative inlays <sup>3</sup>
Fine Nappa leather seats and door panel inserts
Fine Nappa leather with contrast stitching <sup>3</sup>
Fine Nappa leather seats and door panel inserts with contrast diamond stitching <sup>3</sup>
Heated twelve-way power front sport seats, including four-way power lumbar adjustment
Aluminum door sill inlays with illumination <sup>3</sup>

### Infotainment/Technology

Audi Navigation plus <sup>5</sup>
Driver information system with lap timer
Six-disc CD changer and MP3 playback capability
Bang & Olufsen® Sound System with twelve speakers and 465 watts
SiriusXM® Satellite Radio with 90-day trial subscription <sup>5</sup>
Audi music interface with iPod® integration <sup>3</sup>
BLUETOOTH® wireless technology preparation for mobile phone with safety belt microphones <sup>6</sup>
Cruise control with coast, resume and accelerate features
Garage door opener (HomeLink®)
Parking system plus (includes rear view camera and front/rear sensors)

### Available packages

<b>Diamond Stitch Full Fine Nappa Leather package<sup>3</sup></b>
▶ Fine Nappa leather seats and door panel inserts with contrast diamond stitching
▶ Fine Nappa leather-wrapped dashboard and instrument panel cover
<b>Full Fine Nappa Leather package<sup>3</sup></b>
▶ Fine Nappa leather-wrapped dashboard and instrument panel cover
<b>Audi exclusive Black Optic package<sup>3</sup></b>
▶ Gloss Black Audi Singleframe® grille
▶ R8 exclusive round exhaust outlets with Black finish
▶ 19" 5-double-spoke design wheels with Titanium finish
<b>Audi Ceramic Brake package<sup>3</sup></b>
▶ Audi ceramic front and rear brakes
▶ Titanium Gray brake calipers with Audi ceramic logo

## R8 V8 Specifications and Available Featured Content

### Engineering/Performance

4.2-liter FSI® V8 engine
Horsepower: 430 @ 7,900 rpm/Torque: 317 @ 4,500–6,000 rpm
0–60 mph: 4.2–4.6 sec/Top track speed: 186–188 mph <sup>1</sup>
EPA mileage estimate <sup>2</sup>
▶ Manual transmission: 11 city/20 highway/14 combined
▶ Audi S tronic® dual-clutch transmission: 14 city/23 highway/17 combined
23.8-gallon (Coupe), 21.1-gallon (Spyder) fuel tank capacity

### Transmissions/Body/Suspension/Chassis

Six-speed manual transmission
Seven-speed Audi S tronic® dual-clutch transmission <sup>3</sup>
Audi ultra® lightweight technology—ASF® aluminum construction
Audi magnetic ride suspension with sport button program
Audi quattro® all-wheel drive
14.4" ventilated front and 14.0" ventilated rear disc brakes
Audi ceramic front and rear brakes <sup>3</sup>
Audi hill hold assist

### Safety

Driver and front passenger dual-stage airbags, head/thorax side airbags and knee airbags <sup>4</sup>
Electronic Stability Control (ESC) with traction control (ASR)
Anti-lock Brake System (ABS)
Electronic Brake-pressure Distribution (EBD) and brake assist

### Exterior

Audi Singleframe® grille
Gloss Black Audi Singleframe® grille <sup>3</sup>
Full LED headlight technology
LED taillight technology
Carbon Fiber Sigma Audi sideblade (Coupe) <sup>3</sup>
Adaptive rear spoiler
R8 exclusive round exhaust outlets with chrome finish
R8 exclusive round exhaust outlets with Black finish <sup>3</sup>
R8 V8 exterior appearance
Aluminum-optic engine vent covers (Spyder)

### Interior/Seating

Automatic climate control
Flat-bottom three-spoke multifunction sport steering wheel (shift paddles with S tronic®)
Alcantara® headliner (Coupe) <sup>3</sup>
Silk Matte Black decorative inlays
Piano Black decorative inlays <sup>3</sup>

### Interior/Seating (continued)

Carbon Fiber Sigma decorative inlays <sup>3</sup>
Leather/Alcantara® seating surfaces
Fine Nappa leather seats and door panel inserts <sup>3</sup>
Fine Nappa leather with contrast stitching <sup>3</sup>
Fine Nappa leather seats and door panel inserts with contrast diamond stitching <sup>3</sup>
Heated twelve-way power front sport seats, including four-way power lumbar adjustment
Aluminum door sill inlays with illumination <sup>3</sup>

### Infotainment/Technology

Audi Navigation plus <sup>3,5</sup>
Driver information system with lap timer
Audi concert radio with seven speakers and six-disc CD changer and MP3 playback capability
Bang & Olufsen® Sound System with twelve speakers and 465 watts <sup>3</sup>
SiriusXM® Satellite Radio with 90-day trial subscription <sup>5</sup>
Audi music interface with iPod® integration <sup>3</sup>
BLUETOOTH® wireless technology preparation for mobile phone with safety belt microphones <sup>6</sup>
Cruise control with coast, resume and accelerate features
Garage door opener (HomeLink®)
Parking system plus (includes rear view camera and front/rear sensors) <sup>3</sup>

### Available packages

<b>Audi Navigation plus package<sup>3</sup></b>
▶ Audi Navigation plus <sup>5</sup>
<b>Diamond Stitch Full Fine Nappa Leather package<sup>3</sup></b>
▶ Fine Nappa leather seats and door panel inserts with contrast diamond stitching
▶ Fine Nappa leather-wrapped dashboard and instrument panel cover
<b>Full Fine Nappa Leather package<sup>3</sup></b>
▶ Fine Nappa leather seats and door panel inserts
▶ Fine Nappa leather-wrapped dashboard and instrument panel cover
<b>Fine Nappa Leather package<sup>3</sup></b>
▶ Fine Nappa leather seats and door panel inserts
<b>Audi exclusive Black Optic package<sup>3</sup></b>
▶ Gloss Black Audi Singleframe® grille
▶ R8 exclusive round exhaust outlets with Black finish
▶ 19" 5-double-spoke design wheels with Titanium finish
<b>Audi Ceramic Brake package<sup>3</sup></b>
▶ Audi ceramic front and rear brakes
▶ Titanium Gray brake calipers with Audi ceramic logo



Information Provided by:

**DEAL**  
E-PROCESS

<sup>1</sup> Top track speed is electronically limited in the U.S. Obey all speed and traffic laws. <sup>2</sup> EPA estimates. Your mileage will vary. <sup>3</sup> Available equipment. See dealer for details. <sup>4</sup> Airbags are supplemental restraints only and will not deploy under all crash circumstances. Always use safety belts and refer to your owner's manual for the proper use of restraint systems when transporting children. <sup>5</sup> See back cover for important information regarding Audi Navigation plus and required SiriusXM subscriptions. <sup>6</sup> Requires compatible phone.



## RS 7 Specifications and Available Featured Content

### Engineering/Performance

4.0-liter TFSI® V8 engine
Horsepower: 560 @ 5,700–6,600 rpm/Torque: 516 @ 1,750–5,500 rpm
0–60 mph: 3.7 sec/Top track speed: 174 mph <sup>1</sup>
Audi cylinder on demand™ engine efficiency technology <sup>2</sup>
EPA mileage estimate <sup>2</sup>
▶ Tiptronic® automatic transmission: NA

### Transmission/Body/Suspension/Chassis

Eight-speed Tiptronic® automatic transmission
Audi ultra® lightweight technology—aluminum hybrid construction
RS 7 tuned Audi adaptive air suspension
Audi quattro® all-wheel drive
Dynamic steering
Sport differential
15.4" ventilated wave design front and 14.0" ventilated wave design rear disc brakes

### Safety

Driver and front passenger dual-stage airbags, thorax side airbags, knee airbags and Sideguard® head curtain airbags <sup>3</sup>
Rear-passenger thorax side airbags <sup>3,4</sup>

### Exterior

Aluminum-matte Audi Singleframe® grille
Gloss Black Audi Singleframe® grille <sup>4</sup>
Full LED headlight technology
LED taillight technology and rear fog lights
Aluminum-matte trim around exterior side windows
Gloss Black trim around exterior side windows <sup>4</sup>
Aluminum-matte exterior side mirror housings
Power tailgate open/close
Adaptive rear spoiler
RS exclusive dual oval exhaust outlets
Sport exhaust system with Black outlets <sup>4</sup>
Audi RS exterior appearance (RS exclusive Audi Singleframe® grille, and front/rear fascia)
Carbon fiber front spoiler, lower air intakes, rear diffuser and exterior side mirror housings <sup>4</sup>
Aluminum-matte front spoiler, lower air intakes and rear diffuser <sup>4</sup>

### Interior/Seating

Four-zone automatic climate control
Three-spoke multifunction sport steering wheel with shift paddles
Alcantara® headliner <sup>4</sup>
Sunroof
Valcona leather seats with contrast honeycomb stitching
Heated twelve-way power front sport seats, including four-way power lumbar adjustment

### Interior/Seating (continued)

Heated and ventilated 22-way power front sport comfort seats, including four-way power lumbar adjustment and massage function (without contrast honeycomb stitching) <sup>4</sup>
Driver seat memory
Front passenger seat memory <sup>4</sup>

### Infotainment/Technology

Audi MMI® Navigation plus with voice control system <sup>5</sup>
Audi MMI® touch with handwriting-recognition technology
Audi connect® with six-month trial subscription <sup>6</sup>
BOSE® Surround Sound System with 14 speakers, AudioPilot® noise compensation and 630 watts
Bang and Olufsen® Advanced Sound System with 15 speakers and 1,300 watts <sup>4</sup>
SiriusXM® Satellite Radio with 90-day trial subscription <sup>5</sup>
SiriusXM® Traffic with four-year subscription <sup>5</sup>
Audi music interface with iPod® integration
BLUETOOTH® wireless technology preparation for mobile phone <sup>7</sup>
Audi advanced key—keyless start, stop and entry <sup>8</sup>
Audi adaptive cruise control with stop & go <sup>4</sup>
Audi active lane assist <sup>4</sup>
Audi pre sense® plus <sup>4</sup>
Audi side assist and pre sense® rear
Night vision assistant, pedestrian detection and head-up display <sup>4</sup>
Audi drive select
Parking system plus with rear view camera (front and rear sensors)
Corner view camera system <sup>4</sup>

### Available packages

<b>Innovation package<sup>4</sup></b>
▶ Night vision assistant with pedestrian detection and head-up display
<b>Driver Assistance package<sup>4</sup></b>
▶ Audi adaptive cruise control with stop & go
▶ Audi active lane assist
▶ Audi pre sense® plus
▶ Corner view camera system
<b>Cold Weather package<sup>4</sup></b>
▶ Heated steering wheel and heated rear seats (without steering wheel perforation, RS 7 logo and shifter)
<b>Comfort Seating package<sup>4</sup></b>
▶ Heated and ventilated 22-way power front sport comfort seats, including four-way power lumbar adjustment and massage function (without contrast honeycomb stitching)
▶ Front passenger seat memory
<b>Carbon Optic package<sup>4</sup></b>
▶ Carbon fiber front spoiler, rear diffuser and exterior side mirror housings
▶ Engine cover with carbon fiber inserts
<b>Matte Aluminum Optic package<sup>4</sup></b>
▶ Matte Aluminum front spoiler, lower air intakes and rear diffuser

## RS 5 Specifications and Available Featured Content

### Engineering/Performance

4.2-liter FSI® V8 engine
Horsepower: 450 @ 8,250 rpm/Torque: 317 @ 4,000–6,000 rpm
0–60 mph: 4.5–4.9 sec/Top track speed: 174 mph <sup>1</sup>
EPA mileage estimate <sup>2</sup>
▶ Audi S tronic® dual-clutch transmission: NA (Coupe), NA (Cabriolet)

### Transmission/Body/Suspension/Chassis

Seven-speed Audi S tronic® dual-clutch transmission
Fully galvanized steel unibody with aluminum front fenders and multistep anti-corrosion protection
RS 5 sport suspension calibration
Audi quattro® all-wheel drive
Dynamic steering <sup>4</sup>
Sport differential
14.4" ventilated wave design front and 12.8" ventilated wave design rear disc brakes
14.9" Audi ceramic front brakes <sup>4</sup>

### Safety

Driver and front passenger dual-stage airbags, thorax side airbags, knee airbags and Sideguard® head curtain airbags (Coupe) <sup>3</sup>
Driver and front passenger dual-stage airbags, knee airbags and head/thorax side airbags (Cabriolet) <sup>3</sup>

### Exterior

Audi Singleframe® grille
Gloss Black Audi Singleframe® grille <sup>4</sup>
Adaptive xenon plus headlights with LED daytime running light technology
Black trim around exterior windows (Coupe) <sup>4</sup>
Adaptive rear spoiler (Coupe)
Trunk-mounted lip spoiler (Cabriolet)
Audi RS exclusive dual oval exhaust outlets
Sport exhaust system with Black outlets <sup>4</sup>
Audi RS exterior appearance (RS exclusive Audi Singleframe® grille, front/rear fascia, wide-body design, Aluminum-optic exterior side mirror housings and body-colored door sill blades)

### Interior/Seating

Three-zone automatic climate control
Three-spoke flat-bottom multifunction sport steering wheel with shift paddles
Black cloth headliner
Panoramic tilting sunroof (Coupe)
Acoustic folding roof—folds at speeds up to 31 mph (Cabriolet)
Fine Nappa leather seats and door armrests
Leather/Alcantara® seating surfaces (Coupe) <sup>4</sup>
Heated twelve-way power front sport seats, including four-way power lumbar adjustment
Ventilated front comfort seats (Coupe) <sup>4</sup>
Ventilated comfort front seats with head-level heating system (Cabriolet) <sup>4</sup>

### Infotainment/Technology

Audi MMI® Navigation plus <sup>4,5</sup>
Audi connect® with six-month trial subscription <sup>4,6</sup>
Color driver information system
Audi concert radio with ten speakers and single CD player with MP3 playback capability
Bang & Olufsen® Sound System with 14 speakers and 505 watts (Coupe) <sup>4</sup> or 12 speakers and 505 watts (Cabriolet) <sup>4</sup>
HD Radio™ Technology <sup>4</sup>
SiriusXM® Satellite Radio with 90-day trial subscription <sup>5</sup>
SiriusXM® Traffic with four-year subscription <sup>4,5</sup>
Audi music interface with iPod® integration
BLUETOOTH® wireless technology preparation for mobile phone <sup>7</sup>
Audi advanced key—keyless start, stop and entry <sup>8</sup>
Audi adaptive cruise control <sup>4</sup>
Audi side assist <sup>4</sup>
Audi drive select
Parking system with front and rear sensors
Rear view camera <sup>4</sup>

### Available packages

<b>Technology package<sup>4</sup></b>
▶ Audi MMI® Navigation plus <sup>5</sup>
▶ Audi connect® with six-month trial subscription <sup>6</sup>
▶ Bang & Olufsen® Sound System with 14 speakers and 505 watts (Coupe) or 12 speakers and 505 watts (Cabriolet)
▶ HD Radio™ Technology
▶ Audi side assist
▶ Rear view camera
<b>Driver Assist package<sup>4</sup></b>
▶ Audi adaptive cruise control
▶ Dynamic steering
<b>Black Optic package<sup>4</sup></b>
▶ 20" 5-arm-rotor design wheels with Titanium finish
▶ Gloss Black Audi Singleframe® grille
▶ Black trim around exterior windows (Coupe)
▶ Body-colored exterior side mirror housings
<b>Comfort package<sup>4</sup></b>
▶ Perforated Milano leather seats
▶ Ventilated front comfort seats
▶ Head-level heating system (Cabriolet)

1 Top track speed is electronically limited in the U.S. Obey all speed and traffic laws. 2 EPA estimates not available at time of printing. See www.fueleconomy.gov for EPA estimates. Your mileage will vary. 3 Airbags are supplemental restraints only and will not deploy under all crash circumstances. Always use safety belts and seat children only in the rear, using restraint systems appropriate for their size and age. 4 Available equipment. See your dealer for details. 5 See back cover for important information about Audi MMI® Navigation plus, Audi Navigation plus and required SiriusXM subscriptions. 6 Distracted driving can cause a loss of vehicle control. The features and technologies discussed above are offered for convenience, and should be used only when it is safe and appropriate. The Wi-Fi® hotspot feature is intended for passenger use only. Always pay careful attention to the road, and do not drive while distracted. Features may require additional subscription plan. See dealer for details. 7 Requires compatible phone. 8 Some Audi models are equipped with a keyless ignition feature. The details as to how the system works can vary and Audi owners should consult their owner's literature or an authorized Audi dealer if they have further questions about the operation of this feature. Please note that Audi warns against leaving the vehicle unattended with the engine running, particularly in enclosed spaces.



## S8 Specifications and Available Featured Content

### Engineering/Performance

4.0-liter turbocharged TFSI® V8 engine  
 Horsepower: 520 @ 6,000 rpm/Torque: 481 @ 5,500 rpm  
 0–60 mph: 3.9 sec/Top track speed: 155 mph<sup>1</sup>  
 Audi cylinder on demand™ engine efficiency technology<sup>2</sup>  
 EPA mileage estimate<sup>2</sup>  
 ▶ Tiptronic® automatic transmission: NA

### Transmission/Body/Suspension/Chassis

Eight-speed Tiptronic® automatic transmission  
 Audi ultra® lightweight technology—ASF® aluminum construction  
 S8 tuned Audi adaptive air suspension  
 Audi quattro® all-wheel drive  
 Dynamic steering  
 Sport differential  
 15.7" ventilated front and 14.0" ventilated rear disc brakes

### Safety

Driver and front passenger dual-stage airbags, thorax side airbags, knee airbags and Sideguard® head curtain airbags<sup>3</sup>  
 Rear-passenger thorax side airbags<sup>3</sup>  
 Electronic Stability Control (ESC) with traction control (ASR)  
 Anti-lock Brake System (ABS)  
 Electronic Brake-pressure Distribution (EBD) and brake assist

### Exterior

Audi Singleframe® grille  
 Full LED headlight technology  
 High-beam assistant  
 Headlight washing system  
 LED taillight technology and rear fog lights  
 Power soft-closing doors  
 Power trunk open/close and hands-free release  
 Quad exhaust outlets  
 Audi S exterior appearance (Platinum Gray matte Audi Singleframe® grille, unique front/rear fascia and side sills, aluminum-optic front/rear blade fins and exterior side mirror housings)

### Interior/Seating

Four-zone automatic climate control  
 Three-spoke multifunction sport steering wheel with shift paddles  
 Alcantara® headliner  
 Power rear side and rear window sunshades  
 Sunroof  
 Valcona leather seats with contrast diamond stitching  
 Heated and ventilated 22-way power front sport comfort seats, including four-way power lumbar adjustment and massage function  
 Driver and front passenger seat memory

### Infotainment/Technology

Audi MMI® Navigation plus with voice control system<sup>5</sup>  
 Audi MMI® touch with handwriting-recognition technology  
 Audi connect® with six-month trial subscription<sup>6</sup>  
 Color driver information system  
 BOSE® Surround Sound System with 14 speakers, AudioPilot® noise compensation and 630 watts  
 Bang & Olufsen® Advanced Sound System with 19 speakers and 1,400 watts<sup>4</sup>  
 HD Radio™ Technology  
 SiriusXM® Satellite Radio with 90-day trial subscription<sup>5</sup>  
 SiriusXM® Traffic with four-year subscription<sup>5</sup>  
 Audi music interface with iPod® integration  
 Rear Seat Entertainment with dual 10" screens and single DVD player<sup>4</sup>  
 BLUETOOTH® wireless technology preparation for mobile phone<sup>7</sup>  
 Garage door opener (HomeLink®)  
 Audi advanced key—keyless start, stop and entry<sup>8</sup>  
 Audi adaptive cruise control with stop & go<sup>4</sup>  
 Audi lane assist<sup>4</sup>  
 Audi side assist  
 Night vision assistant with pedestrian detection<sup>4</sup>  
 Audi drive select  
 Parking system plus with rear view camera (front and rear sensors)  
 Top and corner view camera system

### Available packages

#### Driver Assistance package<sup>4</sup>

- ▶ Audi adaptive cruise control with stop & go
- ▶ Audi pre sense® plus

#### Cold Weather package<sup>4</sup>

- ▶ Heated steering wheel and heated rear seats
- ▶ Rear seat pass-through with ski bag

#### Lane Assist package<sup>4</sup>

- ▶ Four-spoke multifunction steering wheel with shift paddles (without S8 logo)
- ▶ Audi lane assist

#### Audi Design Selection package, Balao Brown<sup>4</sup>

- ▶ Balao Brown Valcona leather seats, trim and shifter
- ▶ Comfort front seats (without contrast diamond stitching)
- ▶ Balsamic Brown Natural Fine Grain Ash Wood upper inlays and Brushed Aluminum lower inlays
- ▶ Snow White Alcantara® headliner, stitching and seat piping

1 Top track speed is electronically limited in the U.S. Obey all speed and traffic laws. 2 EPA estimates not available at time of printing. See www.fueleconomy.gov for EPA estimates. Your mileage will vary. 3 Airbags are supplemental restraints only and will not deploy under all crash circumstances. Always use safety belts and seat children only in the rear, using restraint systems appropriate for their size and age. 4 Available equipment. See your dealer for details. 5 See back cover for important information about Audi MMI® Navigation plus and required SiriusXM subscriptions. 6 Distracted driving can cause a loss of vehicle control. The features and technologies discussed above are offered for convenience, and should be used only when it is safe and appropriate. The Wi-Fi® hotspot feature is intended for passenger use only. Always pay careful attention to the road, and do not drive while distracted. See dealer for details. 7 Requires compatible phone. 8 Some Audi models are equipped with a keyless ignition feature. The details as to how the system works can vary and Audi owners should consult their owner's literature or an authorized Audi dealer if they have further questions about the operation of this feature. Please note that Audi warns against leaving the vehicle unattended with the engine running, particularly in enclosed spaces.

## S7 Specifications and Available Featured Content

### Engineering/Performance

4.0-liter turbocharged TFSI® V8 engine  
 Horsepower: 420 @ 5,500–6,400 rpm/Torque: 406 @ 1,400–5,200 rpm  
 0–60 mph: 4.5 sec/Top track speed: 155 mph<sup>1</sup>  
 Audi cylinder on demand™ engine efficiency technology<sup>2</sup>  
 EPA mileage estimate<sup>2</sup>  
 ▶ Audi S tronic® dual-clutch transmission: NA

### Transmission/Body/Suspension/Chassis

Seven-speed Audi S tronic® dual-clutch transmission  
 Audi ultra® lightweight technology—aluminum hybrid construction  
 S7 tuned Audi adaptive air suspension  
 Audi quattro® all-wheel drive  
 Sport differential  
 15.7" ventilated front and 14.0" ventilated rear disc brakes

### Safety

Driver and front passenger dual-stage airbags, thorax side airbags, knee airbags and Sideguard® head curtain airbags<sup>3</sup>  
 Rear-passenger thorax side airbags<sup>3,4</sup>

### Exterior

Audi Singleframe® grille  
 Gloss Black Audi Singleframe® grille<sup>4</sup>  
 Adaptive xenon plus headlights with LED daytime running light technology  
 Full LED headlight technology<sup>4</sup>  
 LED taillight technology and rear fog lights  
 Gloss Black trim around exterior windows<sup>4</sup>  
 Power soft-closing doors<sup>4</sup>  
 Power tailgate open/close  
 Adaptive rear spoiler  
 Quad exhaust outlets  
 Audi S exterior appearance (Platinum Gray Audi Singleframe® grille, unique front/rear fascia and side sills, aluminum-optic front/rear blade fins and exterior side mirror housings)

### Interior/Seating

Four-zone automatic climate control  
 Three-spoke multifunction sport steering wheel with shift paddles  
 Alcantara® headliner<sup>4</sup>  
 Sunroof  
 Valcona leather seats with contrast diamond stitching  
 Heated twelve-way power front sport seats, including four-way power lumbar adjustment  
 Heated and ventilated 22-way power front sport comfort seats, including four-way power lumbar adjustment and massage function (without contrast diamond stitching)<sup>4</sup>  
 Driver seat memory  
 Front passenger seat memory<sup>4</sup>  
 Split folding 60/40 rear seatbacks

### Infotainment/Technology

Audi MMI® Navigation plus with voice control system<sup>5</sup>  
 Audi MMI® touch with handwriting-recognition technology  
 Audi connect® with six-month trial subscription<sup>6</sup>  
 Color driver information system  
 BOSE® Surround Sound System with 14 speakers, AudioPilot® noise compensation and 630 watts  
 Bang & Olufsen® Advanced Sound System with 15 speakers and 1,300 watts<sup>4</sup>  
 HD Radio™ Technology  
 SiriusXM® Satellite Radio with 90-day trial subscription<sup>5</sup>  
 SiriusXM® Traffic with four-year subscription<sup>5</sup>  
 Audi music interface with iPod® integration  
 BLUETOOTH® wireless technology preparation for mobile phone<sup>7</sup>  
 Audi advanced key—keyless start, stop and entry<sup>8</sup>  
 Audi adaptive cruise control with stop & go<sup>4</sup>  
 Audi active lane assist<sup>4</sup>  
 Audi pre sense® plus<sup>4</sup>  
 Audi side assist  
 Night vision assistant with pedestrian detection and head-up display<sup>4</sup>  
 Audi drive select  
 Parking system plus with rear view camera (front and rear sensors)  
 Corner view camera system<sup>4</sup>

### Available packages

#### Innovation package<sup>4</sup>

- ▶ Night vision assistant with pedestrian detection and head-up display

#### Driver Assistance package<sup>4</sup>

- ▶ Audi adaptive cruise control with stop & go
- ▶ Audi active lane assist
- ▶ Audi pre sense® plus
- ▶ Corner view camera system

#### Cold Weather package<sup>4</sup>

- ▶ Heated steering wheel and heated rear seats

#### Comfort Seating package<sup>4</sup>

- ▶ Heated and ventilated 22-way power front sport comfort seats, including four-way power lumbar adjustment and massage function (without contrast diamond stitching)
- ▶ Front passenger seat memory

#### Black Optic package<sup>4</sup>

- ▶ Gloss Black Audi Singleframe® grille
- ▶ Gloss Black trim around exterior windows
- ▶ Body-colored exterior side mirror housings
- ▶ 20" 7-twin-spoke design wheels with bicolor finish



## S6 Specifications and Available Featured Content

### Engineering/Performance

- 4.0-liter turbocharged TFSI® V8 engine
- Horsepower: 420 @ 5,500–6,400 rpm/Torque: 406 @ 1,400–5,200 rpm
- 0–60 mph: 4.5 sec/Top track speed: 155 mph<sup>1</sup>
- Audi cylinder on demand™ engine efficiency technology<sup>2</sup>
- EPA mileage estimate<sup>2</sup>
- ▶ Audi S tronic® dual-clutch transmission: NA

### Transmission/Body/Suspension/Chassis

- Seven-speed Audi S tronic® dual-clutch transmission
- Audi ultra® lightweight technology—aluminum hybrid construction
- S6 tuned Audi adaptive air suspension
- Audi quattro® all-wheel drive
- Sport differential
- 15.7" ventilated front and 14.0" ventilated rear disc brakes

### Safety

- Driver and front passenger dual-stage airbags, thorax side airbags, knee airbags and Sideguard® head curtain airbags<sup>3</sup>
- Rear-passenger thorax side airbags<sup>3,4</sup>

### Exterior

- Audi Singleframe® grille
- Gloss Black Audi Singleframe® grille<sup>4</sup>
- Adaptive xenon plus headlights with LED daytime running light technology
- Full LED headlight technology<sup>4</sup>
- LED taillight technology and rear fog lights
- Gloss Black trim around exterior windows<sup>4</sup>
- Quad exhaust outlets
- Audi S exterior appearance (Platinum Gray Audi Singleframe® grille, unique front/rear fascia and side sills, aluminum-optic front/rear blade fins, exterior side mirror housings and integrated rear spoiler)

### Interior/Seating

- Four-zone automatic climate control
- Three-spoke multifunction sport steering wheel with shift paddles
- Alcantara® headliner<sup>4</sup>
- Sunroof
- Valcona leather seats with contrast diamond stitching
- Heated twelve-way power front sport seats, including four-way power lumbar adjustment with driver seat memory
- Heated and ventilated 22-way power front sport comfort seats, including four-way power lumbar adjustment and massage function (without contrast diamond stitching)<sup>4</sup>
- Front passenger seat memory<sup>4</sup>

### Infotainment/Technology

- Audi MMI® Navigation plus with voice control system<sup>5</sup>
- Audi MMI® touch with handwriting-recognition technology
- Audi connect® with six-month trial subscription<sup>6</sup>
- Color driver information system
- BOSE® Surround Sound System with 14 speakers, AudioPilot® noise compensation and 630 watts
- Bang & Olufsen® Advanced Sound System with 15 speakers and 1,300 watts<sup>4</sup>
- HD Radio™ Technology
- SiriusXM® Satellite Radio with 90-day trial subscription<sup>5</sup>
- SiriusXM® Traffic with four-year subscription<sup>5</sup>
- Audi music interface with iPod® integration
- BLUETOOTH® wireless technology preparation for mobile phone<sup>7</sup>
- Audi advanced key—keyless start, stop and entry<sup>8</sup>
- Audi adaptive cruise control with stop & go<sup>4</sup>
- Audi active lane assist<sup>4</sup>
- Audi pre sense® plus<sup>4</sup>
- Audi side assist
- Night vision assistant with pedestrian detection and head-up display<sup>4</sup>
- Audi drive select
- Parking system plus with rear view camera (front and rear sensors)
- Top and corner view camera system<sup>4</sup>

### Available packages

- Innovation package<sup>4</sup>**
  - ▶ Night vision assistant with pedestrian detection and head-up display
- Driver Assistance package<sup>4</sup>**
  - ▶ Audi adaptive cruise control with stop & go
  - ▶ Audi active lane assist
  - ▶ Audi pre sense® plus
  - ▶ Top and corner view camera system
- Cold Weather package<sup>4</sup>**
  - ▶ Heated steering wheel and heated rear seats
- Comfort Seating package<sup>4</sup>**
  - ▶ Heated and ventilated 22-way power front sport comfort seats, including four-way power lumbar adjustment and massage function (without contrast diamond stitching)
  - ▶ Front passenger seat memory
- Black Optic package<sup>4</sup>**
  - ▶ Gloss Black Audi Singleframe® grille
  - ▶ Gloss Black trim around exterior windows
  - ▶ Body-colored exterior side mirror housings
  - ▶ 20" 5-arm-rotor design wheels with Titanium finish

## S5 Specifications and Available Featured Content

### Engineering/Performance

- 3.0-liter supercharged TFSI® V6 engine
- Horsepower: 333 @ 5,500–6,500 rpm/Torque: 325 @ 2,900–5,300 rpm
- 0–60 mph: 4.9–5.3 sec/Top track speed: 155 mph<sup>1</sup>
- EPA mileage estimate<sup>2</sup>
- ▶ Manual transmission: NA (Coupe)
- ▶ Audi S tronic® dual-clutch transmission:<sup>4</sup> NA (Coupe), NA (Cabriolet)

### Transmissions/Body/Suspension/Chassis

- Six-speed manual transmission (Coupe)
- Seven-speed Audi S tronic® dual-clutch transmission<sup>4</sup>
- Fully galvanized steel unibody with aluminum front fenders and multistep anti-corrosion protection
- S5 sport suspension calibration
- Audi quattro® all-wheel drive
- Dynamic steering and adaptive damping suspension<sup>4</sup>
- Sport differential<sup>4</sup>
- 13.6" ventilated front and 13.0" ventilated rear disc brakes

### Safety

- Driver and front passenger dual-stage airbags, thorax side airbags, knee airbags and Sideguard® head curtain airbags (Coupe)<sup>3</sup>
- Driver and front passenger dual-stage airbags, knee airbags and head/thorax side airbags (Cabriolet)<sup>3</sup>

### Exterior

- Audi Singleframe® grille
- Gloss Black Audi Singleframe® grille (Coupe)<sup>4</sup>
- Xenon plus headlights with LED daytime running light technology
- Adaptive xenon plus headlights with LED daytime running light technology<sup>4</sup>
- LED taillight technology and rear fog lights
- Gloss Black trim around exterior windows (Coupe)<sup>4</sup>
- Quad exhaust outlets
- Audi S exterior appearance (Platinum Gray Audi Singleframe® grille, Aluminum-optic front/rear blades and exterior side mirror housings, body-colored door sill blades and integrated rear spoiler)

### Interior/Seating

- Three-zone automatic climate control
- Three-spoke flat-bottom multifunction sport steering wheel (shift paddles with S tronic®)
- Black cloth headliner
- Panoramic tilting sunroof (Coupe)
- Acoustic folding roof—folds at speeds up to 31 mph (Cabriolet)
- Leather/Alcantara® seating surfaces (Coupe)
- Fine Nappa leather seats and door armrests<sup>4</sup>
- Perforated Milano leather seats<sup>4</sup>
- Heated twelve-way power front sport seats, including four-way power lumbar adjustment

### Interior/Seating (continued)

- Ventilated front comfort seats (Coupe)<sup>4</sup>
- Ventilated front comfort seats with head-level heating system (Cabriolet)<sup>4</sup>
- Driver seat memory
- Split folding 50/50 rear seatbacks (Cabriolet)
- Split folding 60/40 rear seatbacks (Coupe)

### Infotainment/Technology

- Audi MMI® Navigation plus<sup>4,5</sup>
- Audi connect® with six-month trial subscription<sup>4,6</sup>
- Color driver information system
- Audi concert radio with ten speakers and single CD player with MP3 playback capability
- Bang & Olufsen® Sound System with 14 speakers and 505 watts (Coupe)<sup>4</sup> or 12 speakers and 505 watts (Cabriolet)<sup>4</sup>
- HD Radio™ Technology<sup>4</sup>
- SiriusXM® Satellite Radio with 90-day trial subscription<sup>5</sup>
- SiriusXM® Traffic with four-year subscription<sup>4,5</sup>
- Audi music interface with iPod® integration
- BLUETOOTH® wireless technology preparation for mobile phone<sup>7</sup>
- Audi advanced key—keyless start, stop and entry<sup>8</sup>
- Audi adaptive cruise control<sup>4</sup>
- Audi side assist<sup>4</sup>
- Audi drive select
- Parking system plus with rear view camera<sup>4</sup>

### Available packages

- Audi MMI® Navigation package<sup>4</sup>**
  - ▶ Audi MMI® Navigation plus<sup>5</sup>
  - ▶ Audi connect® with six-month trial subscription<sup>6</sup>
  - ▶ HD Radio™ Technology
  - ▶ SiriusXM® Traffic with four-year subscription<sup>5</sup>
  - ▶ Parking system plus with rear view camera
- Driver Assist package<sup>4</sup>**
  - ▶ Audi adaptive cruise control
  - ▶ Dynamic steering
- Comfort package<sup>4</sup>**
  - ▶ Perforated Milano leather seats
  - ▶ Ventilated front comfort seats
  - ▶ Head-level heating system (Cabriolet)
- Black Optic package (Coupe)<sup>4</sup>**
  - ▶ Gloss Black Audi Singleframe® grille
  - ▶ Gloss Black trim around exterior windows
  - ▶ Body-colored exterior side mirror housings
  - ▶ 19" 5-arm-rotor design wheels with Titanium finish

<sup>1</sup> Top track speed is electronically limited in the U.S. Obey all speed and traffic laws. <sup>2</sup> EPA estimates not available at time of printing. See [www.fueleconomy.gov](http://www.fueleconomy.gov) for EPA estimates. Your mileage will vary. <sup>3</sup> Airbags are supplemental restraints only and will not deploy under all crash circumstances. Always use safety belts and seat children only in the rear, using restraint systems appropriate for their size and age. <sup>4</sup> Available equipment. See your dealer for details. <sup>5</sup> See back cover for important information about Audi MMI® Navigation plus and required SiriusXM subscriptions. <sup>6</sup> Distracted driving can cause a loss of vehicle control. The features and technologies discussed above are offered for convenience, and should be used only when it is safe and appropriate. The Wi-Fi® hotspot feature is intended for passenger use only. Always pay careful attention to the road, and do not drive while distracted. Features may require additional subscription plan. See dealer for details. <sup>7</sup> Requires compatible phone. <sup>8</sup> Some Audi models are equipped with a keyless ignition feature. The details as to how the system works can vary and Audi owners should consult their owner's literature or an authorized Audi dealer if they have further questions about the operation of this feature. Please note that Audi warns against leaving the vehicle unattended with the engine running, particularly in enclosed spaces.



## S4 Specifications and Available Featured Content

### Engineering/Performance

3.0-liter supercharged TFSI® V6 engine

Horsepower: 333 @ 5,500–6,500 rpm/Torque: 325 @ 2,900–5,300 rpm

0–60 mph: 4.9 sec/Top track speed: 155 mph<sup>1</sup>, or 130 mph<sup>1</sup> with all-season tires

EPA mileage estimate<sup>2</sup>

- ▶ Manual transmission: NA
- ▶ Audi S tronic® dual-clutch transmission<sup>3</sup>: NA

### Transmissions/Body/Suspension/Chassis

Six-speed manual transmission

Seven-speed Audi S tronic® dual-clutch transmission<sup>3</sup>

Fully galvanized steel unibody with aluminum hood and multistep anti-corrosion protection

S4 sport suspension calibration

Audi quattro® all-wheel drive

Dynamic steering and adaptive damping suspension<sup>3</sup>

Sport differential<sup>3</sup>

13.6" ventilated front and 13.0" ventilated rear disc brakes

### Safety

Driver and front passenger dual-stage airbags, thorax side airbags and Sideguard® head curtain airbags<sup>4</sup>

Rear-passenger thorax side airbags<sup>3,4</sup>

### Exterior

Audi Singleframe® grille

Gloss Black Audi Singleframe® grille<sup>3</sup>

Xenon plus headlights with LED daytime running light technology

Adaptive xenon plus headlights with LED daytime running light technology<sup>3</sup>

Front fog lights

LED taillight technology and rear fog lights

Gloss Black trim around exterior windows<sup>3</sup>

Quad exhaust outlets

Audi S exterior appearance (Platinum Gray Audi Singleframe® grille, Aluminum-optic front/rear blades and exterior side mirror housings, body-colored door sill blades and integrated rear spoiler)

### Interior/Seating

Three-zone automatic climate control

Three-spoke flat-bottom multifunction sport steering wheel (shift paddles with S tronic®)

Black cloth headliner

Sunroof

Leather/Alcantara® seating surfaces

Fine Nappa leather seats and door armrests<sup>3</sup>

Heated twelve-way power front sport seats, including four-way power lumbar adjustment

Driver seat memory

Split folding 60/40 rear seatbacks

### Infotainment/Technology

Audi MMI® Navigation plus with voice control system<sup>3,5</sup>

Audi connect® with six-month trial subscription<sup>3,6</sup>

Color driver information system<sup>3</sup>

Audi concert radio with ten speakers and single CD player with MP3 playback capability

Bang & Olufsen® Sound System with 14 speakers and 505 watts<sup>3</sup>

HD Radio™ Technology<sup>3</sup>

SiriusXM® Satellite Radio with 90-day trial subscription<sup>5</sup>

SiriusXM® Traffic with four-year subscription<sup>3,5</sup>

Audi music interface with iPod® integration

BLUETOOTH® wireless technology preparation for mobile phone<sup>7</sup>

Audi advanced key—keyless start, stop and entry<sup>8</sup>

Audi adaptive cruise control<sup>3</sup>

Audi side assist<sup>3</sup>

Audi drive select

Parking system plus with rear view camera<sup>3</sup>

### Available packages

#### Audi MMI® Navigation package<sup>3</sup>

- ▶ Audi MMI® Navigation plus with voice control system<sup>5</sup>
- ▶ Audi connect® with six-month trial subscription<sup>6</sup>
- ▶ Color driver information system and HD Radio™ Technology
- ▶ SiriusXM® Traffic with four-year subscription<sup>5</sup>
- ▶ Parking system plus with rear view camera

#### Driver Assist package<sup>3</sup>

- ▶ Audi adaptive cruise control
- ▶ Dynamic steering

#### Black Optic package<sup>3</sup>

- ▶ Gloss Black Audi Singleframe® grille
- ▶ Gloss Black trim around exterior windows
- ▶ Body-colored exterior side mirror housings
- ▶ 19" 5-arm-rotor design wheels with Titanium finish

<sup>1</sup> Top track speed is electronically limited in the U.S. Obey all speed and traffic laws. <sup>2</sup> EPA estimates not available at time of printing. See [www.fueleconomy.gov](http://www.fueleconomy.gov) for EPA estimates. Your mileage will vary. <sup>3</sup> Available equipment. See your dealer for details. <sup>4</sup> Airbags are supplemental restraints only and will not deploy under all crash circumstances. Always use safety belts and seat children only in the rear, using restraint systems appropriate for their size and age. <sup>5</sup> See back cover for important information about Audi MMI® Navigation plus and required SiriusXM subscriptions. <sup>6</sup> Distracted driving can cause a loss of vehicle control. The features and technologies discussed above are offered for convenience, and should be used only when it is safe and appropriate. The Wi-Fi® hotspot feature is intended for passenger use only. Always pay careful attention to the road, and do not drive while distracted. Features may require additional subscription plan. See dealer for details. <sup>7</sup> Requires compatible phone. <sup>8</sup> Some Audi models are equipped with a keyless ignition feature. The details as to how the system works can vary and Audi owners should consult their owner's literature or an authorized Audi dealer if they have further questions about the operation of this feature. Please note that Audi warns against leaving the vehicle unattended with the engine running, particularly in enclosed spaces.

## TTS Specifications and Available Featured Content

### Engineering/Performance

2.0-liter turbocharged TFSI® four-cylinder engine

Horsepower: 265 @ 6,000 rpm/Torque: 258 @ 2,500 rpm

0–60 mph: 4.9–5.1 sec/Top track speed: 155 mph<sup>1</sup>

EPA mileage estimate<sup>2</sup>

- ▶ Audi S tronic® dual-clutch transmission: NA

### Transmission/Body/Suspension/Chassis

Six-speed Audi S tronic® dual-clutch transmission

Audi ultra® lightweight technology—ASF® aluminum construction

Audi magnetic ride suspension with Sport button program

Audi quattro® all-wheel drive

13.4" ventilated front and 12.2" ventilated rear disc brakes

Audi hill hold assist

### Safety

Driver and front passenger dual-stage airbags, head/thorax side airbags and knee airbags<sup>4</sup>

Rollover protection system (Roadster only)

Electronic Stability Control (ESC) with traction control (ASR)

Anti-lock Brake System (ABS)

Electronic Brake-pressure Distribution (EBD) and brake assist

### Exterior

Audi Singleframe® grille

Gloss Black Audi Singleframe® grille<sup>3</sup>

Adaptive xenon plus headlights with LED daytime running light technology

Headlight washing system

Carbon-fiber exterior side mirror housings<sup>3</sup>

Black trim around exterior windows (Coupe)

Adaptive rear spoiler

Quad exhaust outlets

Audi S exterior appearance (Platinum Gray Audi Singleframe® grille, unique front/rear fascia, and Aluminum-optic exterior side mirror housings)

### Interior/Seating

Automatic climate control

Three-spoke flat-bottom multifunction sport steering wheel with shift paddles

Black cloth headliner

Acoustic folding roof—folds at speeds up to 31 mph (Roadster)

Power-operated wind deflector (Roadster)

Silk Nappa leather seats

Baseball-optic Fine Nappa leather seats and trim<sup>3</sup>

Audi exclusive bicolor Fine Nappa leather seats and trim<sup>3</sup>

Twelve-way power front sport seats, including four-way power lumbar adjustment

Heated front seats

### Infotainment/Technology

Audi Navigation plus<sup>3,5</sup>

Driver information system with lap timer

BOSE® sound system with twelve speakers and AudioPilot® noise compensation

Single CD player with MP3 playback capability

SiriusXM® Satellite Radio with 90-day trial subscription<sup>5</sup>

Audi music interface with iPod® integration<sup>3</sup>

BLUETOOTH® wireless technology preparation for mobile phone<sup>7</sup>

Cruise control with coast, resume and accelerate features

Garage door opener (HomeLink®)

Parking system with rear sensors<sup>3</sup>

### Available packages

#### Black Optic package<sup>3</sup>

- ▶ Gloss Black Audi Singleframe® grille
- ▶ Carbon-fiber exterior side mirror housings
- ▶ 19" 15-spoke design wheels with Titanium finish
- ▶ Phantom Black decorative inlays

#### Audi Navigation plus package

- ▶ Audi Navigation plus
- ▶ Audi music interface with iPod® integration
- ▶ Parking system with rear sensors



## SQ5 Specifications and Available Featured Content

### Engineering/Performance

- 3.0-liter supercharged TFSI® V6 engine
- Horsepower: 354 @ 6,000–6,500 rpm/Torque: 346 @ 4,000–4,500 rpm
- 0–60 mph: 5.1 sec/Top track speed: 155 mph<sup>1</sup>
- EPA mileage estimate<sup>2</sup>
- ▶ Tiptronic® automatic transmission: NA

### Transmission/Body/Suspension/Chassis

- Eight-speed Tiptronic® automatic transmission
- Fully galvanized steel unibody with aluminum hood and tailgate and multistep anti-corrosion protection
- SQ5 sport suspension calibration
- Audi quattro® all-wheel drive
- Dynamic steering<sup>3</sup>
- 15.0" ventilated front and 13.0" ventilated rear disc brakes

### Safety

- Driver and front passenger dual-stage airbags, thorax side airbags and Sideguard® head curtain airbags<sup>4</sup>
- Rear-passenger thorax side airbags<sup>3,4</sup>
- Electronic Stability Control (ESC) with traction control (ASR)
- Anti-lock Brake System (ABS)
- Electronic Brake-pressure Distribution (EBD) and brake assist

### Exterior

- Audi Singleframe® grille
- Xenon plus headlights with LED daytime running light technology
- Adaptive xenon plus headlights with LED daytime running light technology<sup>5</sup>
- Front fog lights
- LED taillight technology and rear fog lights
- Aluminum roof rails and aluminum trim around exterior windows
- Power tailgate open/close
- Quad exhaust outlets
- Audi S exterior appearance (Platinum Gray Audi Singleframe® grille and rear diffuser, Aluminum-optic exterior side mirror housings, body-colored extended side sills and integrated rear tailgate spoiler)

### Interior/Seating

- Three-zone automatic climate control
- Three-spoke flat-bottom multifunction sport steering wheel with shift paddles
- Black headliner
- Panoramic sunroof
- Leather/Alcantara® seating surfaces
- Fine Nappa leather seats and door armrests<sup>3</sup>
- Perforated Milano leather seats<sup>3</sup>
- Heated twelve-way power front sport seats, including four-way power lumbar adjustment

### Interior/Seating (continued)

- Ventilated front seats<sup>3</sup>
- Driver seat memory
- Sliding 40/20/40 split folding rear seat with adjustable recline

### Infotainment/Technology

- Audi MMI® Navigation plus with voice control system<sup>3,5</sup>
- Audi connect® with six-month trial subscription<sup>3,6</sup>
- Color driver information system<sup>3</sup>
- Audi concert radio with ten speakers and single CD player with MP3 playback capability
- Bang & Olufsen® Sound System with 14 speakers and 505 watts<sup>3</sup>
- HD Radio™ Technology<sup>3</sup>
- SiriusXM® Satellite Radio with 90-day trial subscription<sup>5</sup>
- SiriusXM® Traffic with four-year subscription<sup>3,5</sup>
- Audi music interface with iPod® integration
- BLUETOOTH® wireless technology preparation for mobile phone<sup>7</sup>
- Audi advanced key—keyless start, stop and entry<sup>8</sup>
- Audi adaptive cruise control<sup>3</sup>
- Audi side assist<sup>3</sup>
- Audi drive select
- Parking system plus with rear view camera (front and rear sensors)<sup>3</sup>

### Available packages

#### Audi MMI® Navigation package<sup>3</sup>

- ▶ Audi MMI® Navigation plus with voice control system<sup>5</sup>
- ▶ Audi connect® with six-month trial subscription<sup>6</sup>
- ▶ Color driver information system and HD Radio™ Technology
- ▶ SiriusXM® Traffic with four-year subscription<sup>5</sup>
- ▶ Parking system plus with rear view camera (front and rear sensors)

#### Driver Assist package<sup>3</sup>

- ▶ Audi adaptive cruise control
- ▶ Dynamic steering

#### Comfort package<sup>3</sup>

- ▶ Perforated Milano leather seats
- ▶ Leather instrument panel top and door armrests
- ▶ Ventilated front seats

<sup>1</sup> Top track speed is electronically limited in the U.S. Obey all speed and traffic laws. <sup>2</sup> EPA estimates not available at time of printing. See [www.fueleconomy.gov](http://www.fueleconomy.gov) for EPA estimates. Your mileage will vary. <sup>3</sup> Available equipment. See dealer for details. <sup>4</sup> Airbags are supplemental restraints only and will not deploy under all crash circumstances. Always use safety belts and refer to your owner's manual for the proper use of the restraint systems when transporting children. <sup>5</sup> See back cover for important information about the Audi MMI® Navigation plus, Audi Navigation plus, and required SiriusXM subscriptions. <sup>6</sup> Distracted driving can cause a loss of vehicle control. The features and technologies discussed above are offered for convenience, and should be used only when it is safe and appropriate. The Wi-Fi® hotspot feature is intended for passenger use only. Always pay careful attention to the road, and do not drive while distracted. Features may require additional subscription plan. See dealer for details. <sup>7</sup> Requires compatible phone. <sup>8</sup> Some Audi models are equipped with a keyless ignition feature. The details as to how the system works can vary, and Audi owners should consult their owner's literature or an authorized Audi dealer if they have further questions about the operation of this feature. Please note that Audi warns against leaving the vehicle unattended with the engine running, particularly in enclosed spaces.

# A showcase of craft.

Wheels | Interior Colors | Interior Inlays | Exterior Colors



## Wheels

### R8

19" 5-arm double-spoke design (Silver finish)



Front 235/35, rear 295/30 summer performance tires<sup>1</sup> V8

19" 5-arm double-spoke design (Titanium finish)



Front 235/35, rear 305/30 summer performance tires<sup>1</sup> V8, V10

19" 5-arm double-spoke design (Polished finish)



Front 235/35, rear 305/30 summer performance tires<sup>1</sup> V8, V10

19" 10-spoke Y design (Polished/Titanium finish)



Front 235/35, rear 295/30 summer performance tires<sup>1</sup> V10

19" 10-spoke Y design (Polished finish)



Front 235/35, rear 305/30 summer performance tires<sup>1</sup> V10

19" 5-double-spoke Y design (Titanium finish)



Front 235/35, rear 295/30 summer performance tires<sup>1</sup> V10 plus

19" 5-double-spoke Y design (Silver finish)



Front 235/35, rear 295/30 summer performance tires<sup>1</sup> V10 plus

### RS 7

20" 7-twin-spoke RS design (Silver finish)



275/35 summer performance tires<sup>1</sup>

21" 5-spoke-blade design (Titanium finish)



275/30 summer performance tires<sup>1</sup>

21" 5-spoke-blade design (Silver finish)



275/30 summer performance tires<sup>1</sup>

21" 5-spoke-blade design (Black finish)



275/30 summer performance tires<sup>1</sup>

### RS 5

19" 10-spoke RS design (Silver finish)



265/35 summer performance tires<sup>1</sup> RS5

20" 5-arm-rotor design (Silver finish)



275/30 summer performance tires<sup>1</sup> RS5

20" 5-arm-rotor design (Titanium finish)



275/30 summer performance tires<sup>1</sup> RS5

### S8

21" 5-triple-spoke design (Silver finish)



265/35 summer performance tires<sup>1</sup>

21" 5-arm-rotor design (Silver finish)



275/35 summer performance tires<sup>1</sup>

21" 5-arm-rotor design (Titanium finish)



275/35 summer performance tires<sup>1</sup>

### S6/S7

19" 5-parallel-spoke S design (Silver finish)



255/40 summer performance tires<sup>1</sup> S6, S7

20" 5-parallel-spoke star design (Silver finish)



255/35 summer performance tires<sup>1</sup> S6

20" 5-arm-rotor design (Titanium finish)



255/35 summer performance tires<sup>1</sup> S6

20" 5-parallel-spoke star design (Silver finish)



265/35 summer performance tires<sup>1</sup> S7

20" 7-twin-spoke design (Polished/Titanium finish)



265/35 summer performance tires<sup>1</sup> S7

### S4/S5

18" 5-parallel-spoke star design (Silver finish)



245/40 summer performance tires<sup>1</sup> S4

18" 5-parallel-spoke S design (Silver finish)



245/40 summer performance tires<sup>1</sup> S5

19" 5-arm-rotor design (Titanium finish)



255/35 summer performance tires<sup>1</sup> S4, S5

19" 5-segment-spoke design (Silver finish)



255/35 summer performance tires<sup>1</sup> S4, S5

### TTS

19" 5-parallel-spoke star design (Silver finish)



255/35 summer performance tires<sup>1</sup>

19" 15-spoke design (Titanium finish)



255/35 summer performance tires<sup>1</sup>

### SQ5

20" 5-parallel-spoke S design (Silver finish)



255/45 summer performance tires<sup>1</sup>

21" 5-double-spoke star design (Polished/Titanium finish)



255/40 summer performance tires<sup>1</sup>

<sup>1</sup> Tires are supplied and warranted by their manufacturer. High-performance tires are designed for optimum performance and handling in warm climates. They are not suitable for cold, snowy or icy weather conditions. If you drive under those circumstances, you should equip your vehicle with all-season or winter tires, which offer better traction under those conditions. We suggest you use the recommended winter or all-season tire specified for your car or its equivalent. These high-performance tires also have a lower aspect ratio that aids performance and handling; however, in order to avoid tire, rim or vehicle damage, it is important that the inflation pressure is regularly checked and maintained at optimum levels. Please also remember in making your selection that, while these tires deliver responsive handling, they may ride less comfortably and make more noise than other choices. Finally, these tires may wear more quickly than other choices.





## Interior Colors

### R8

Black leather/Alcantara®



Titanium Gray leather/Alcantara®

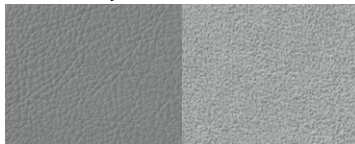

Black Fine Nappa leather

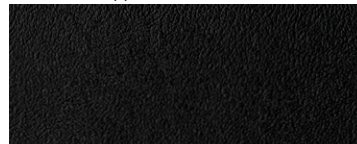

Lunar Silver Fine Nappa leather



Red Fine Nappa leather

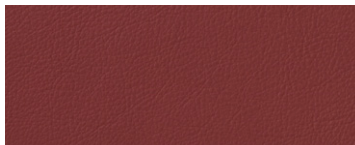

Nougat Brown Fine Nappa leather

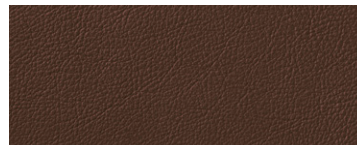

Luxor Beige Fine Nappa leather

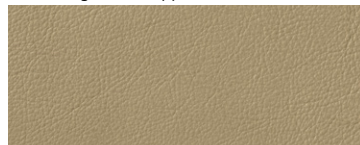

Black Fine Nappa leather with Beige contrast stitching

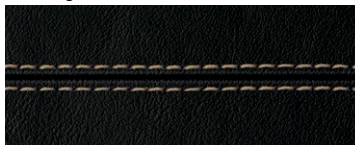

Black Fine Nappa leather with Red contrast stitching

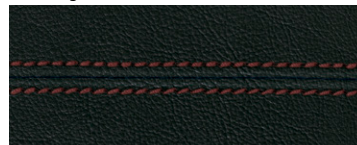

Black Fine Nappa leather with Nougat Brown contrast stitching

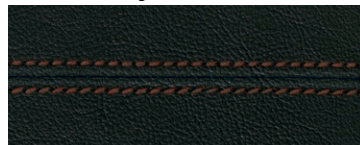

Black Fine Nappa leather with Madras Orange contrast stitching

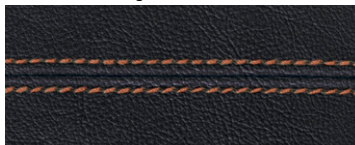

Black Fine Nappa leather with Silver contrast diamond stitching

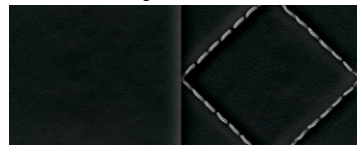

### S8

Black Perforated Valcona leather with diamond stitching

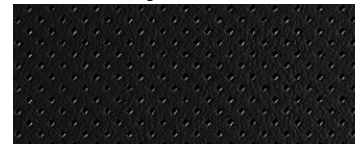

Nougat Brown Perforated Valcona leather with diamond stitching



Lunar Silver Perforated Valcona leather with Steel Gray diamond stitching and piping

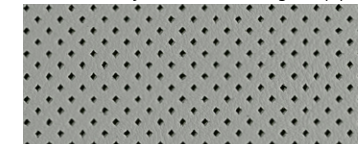

Velvet Beige Perforated Valcona leather with diamond stitching



Balao Brown Perforated Valcona leather



### S6/S7/RS 7

Black Valcona leather with Silver contrast diamond stitching (honeycomb stitching on RS 7)

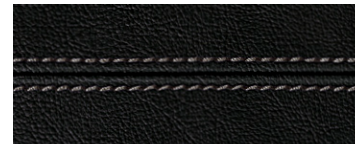

Lunar Silver Valcona leather with Steel Gray contrast diamond stitching (honeycomb stitching on RS 7)

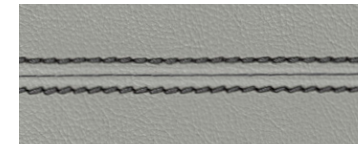

Black Perforated Valcona leather

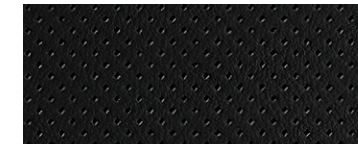



## Interior Colors (continued)

### S4/S5/RS 5

Black leather/Alcantara®

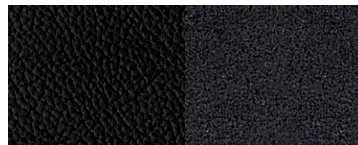

S4, S5 Coupe, RS5 Coupe

Black leather/Lunar Silver Alcantara®



S4, S5 Coupe

Black Fine Nappa leather

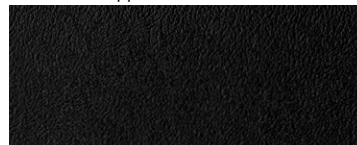

S4, S5, RS5

Black/Lunar Silver Fine Nappa leather

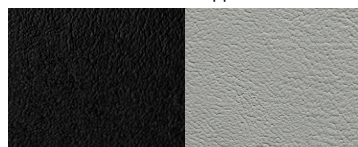

S4, S5

Black/Magma Red Fine Nappa leather



S4, S5

Black/Chestnut Brown Fine Nappa leather

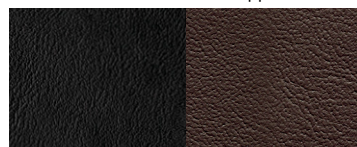

S4, S5

Black Perforated Milano leather

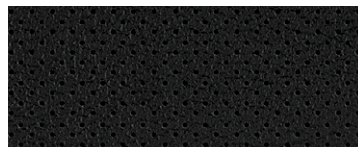

S5, RS 5

Chestnut Brown Perforated Milano leather

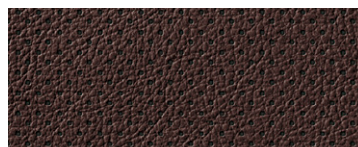

S5

Lunar Silver Fine Nappa leather



RS 5

### SQ5

Black leather/Alcantara®



Black leather/Lunar Silver Alcantara®

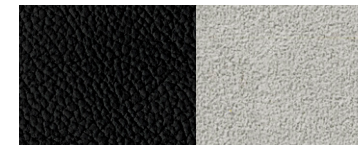

Black Fine Nappa leather

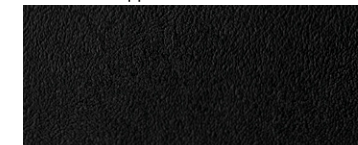

Black/Lunar Silver Fine Nappa leather

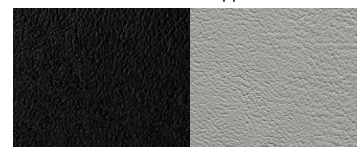

Black/Magma Red Fine Nappa leather

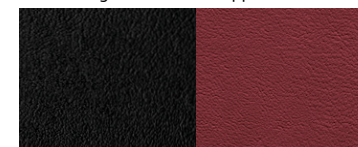

Black/Chestnut Brown Fine Nappa leather

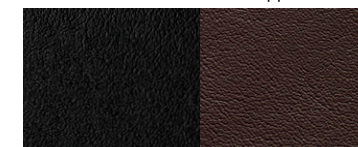

Black Perforated Milano leather



Chestnut Brown Perforated Milano leather

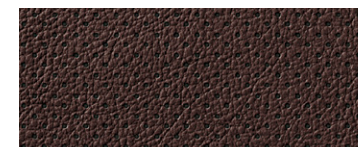

### TTS

Black Silk Nappa leather

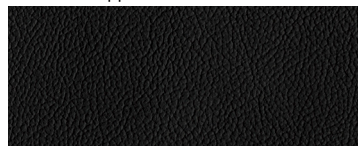

Madras Brown Baseball-optic Fine Nappa leather

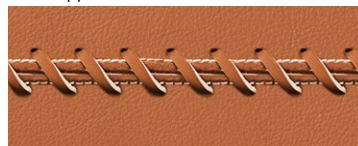

Black/Spectral Silver Silk Nappa leather

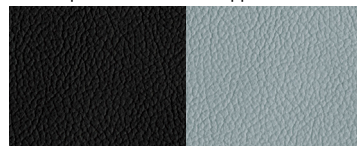

Black/Orange Silk Nappa leather

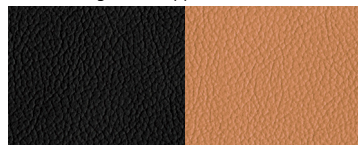

Black/Magma Red Silk Nappa leather

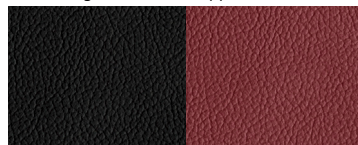

Black/Titanium Gray Fine Nappa leather

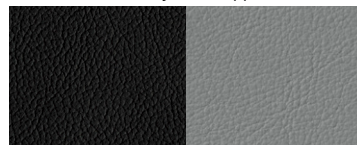

Audi exclusive

Black/Crimson Red Fine Nappa leather

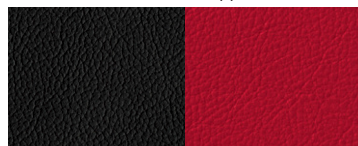

Audi exclusive





## Decorative Inlays

Brushed Aluminum<sup>1</sup>



S4, S5, S6, S7, TTS, SQ5

Carbon Atlas<sup>1</sup>



S4, S5, S6, S7, SQ5

Fine Grain Birch Wood<sup>1</sup>



S5

Layered Aluminum/Black Wood<sup>1</sup>

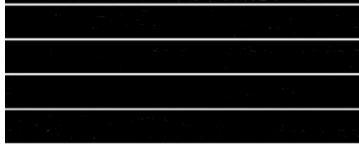

S4, S5, S6, S7, RS 7, SQ5

RS-design Carbon Fiber<sup>1</sup>

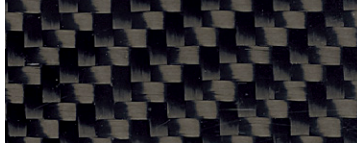

RS 5, RS 7

Aluminum Race<sup>1</sup>

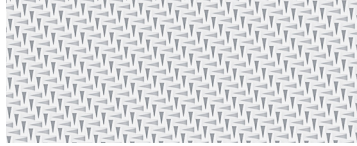

RS 5, RS 7

Fine Grain Ash Natural Brown Wood<sup>1</sup>

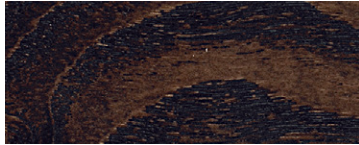

S6, S7

Brown Walnut Wood/Brushed Aluminum<sup>1</sup>

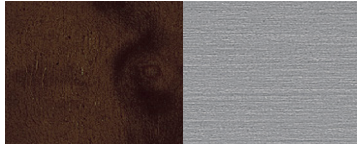

S8

Carbon Atlas/Brushed Aluminum<sup>1</sup>

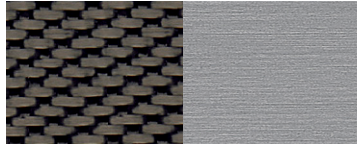

S8

Balsamic Brown Natural Fine Grain Ash Wood/Brushed Aluminum<sup>1</sup>

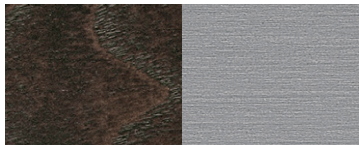

S8

Assam Gray Vavona Wood/Brushed Aluminum<sup>1</sup>

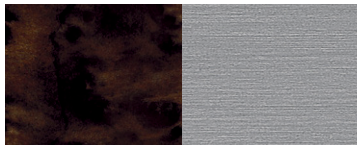

S8

Velvet Brown Fine Grain Ash Wood/Brushed Aluminum<sup>1</sup>

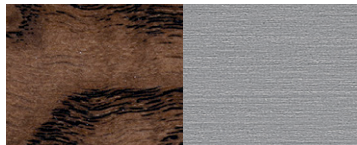

S8

Deep Black Silk matte<sup>1</sup>

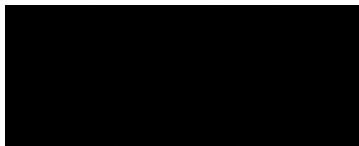

R8

Piano Black<sup>1</sup>

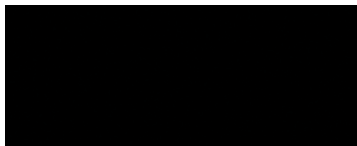

R8

Phantom Black<sup>1</sup>

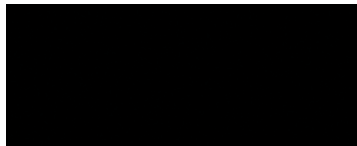

TTS

Carbon Fiber Sigma<sup>1</sup>

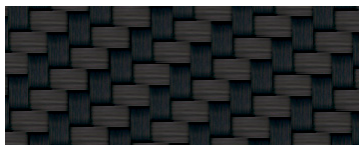

R8

# Colored in bold strokes.



<sup>1</sup> Decorative inlay options will vary based on model and interior color combination.



# Exterior Colors



Brilliant Black  
S4, S5, S6, S7, S8, TTS, SQ5

Brilliant Red  
R8

Ibis White  
S4, S5, S6, S7, S8, RS 5, RS 7, TTS, SQ5, R8

Nardo Gray  
RS 5 Cabriolet, RS 7

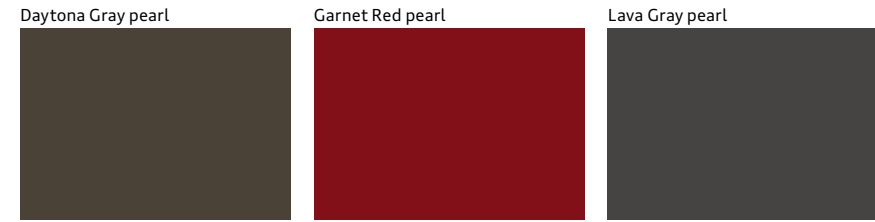

Daytona Gray pearl  
S8, RS 5, RS 7, R8

Garnet Red pearl  
S6, S7

Lava Gray pearl  
SQ5

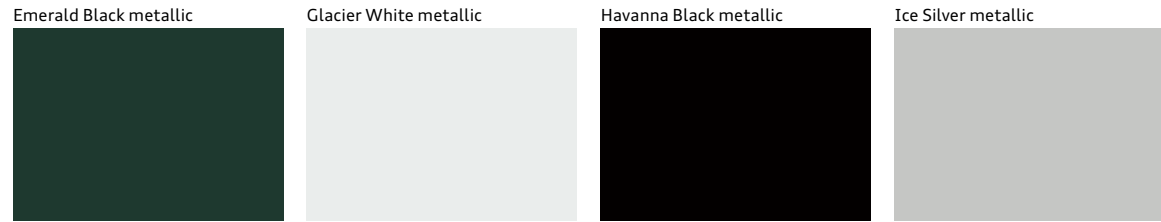

Emerald Black metallic  
S8

Glacier White metallic  
S4, S5, S6, S7, S8, TTS, SQ5

Havana Black metallic  
S6, S7, S8

Ice Silver metallic  
S4, S5, S6, S7, S8, TTS, SQ5, R8

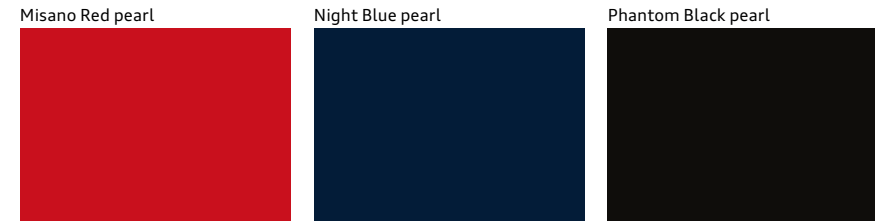

Misano Red pearl  
S4, S5, RS 5, RS 7, TTS

Night Blue pearl  
S8

Phantom Black pearl  
S4, S5, S6, S7, S8, RS 5, RS 7, TTS, R8, SQ5

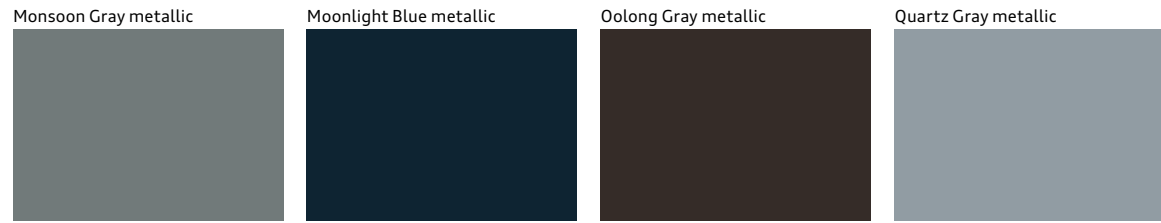

Monsoon Gray metallic  
S4, S5, SQ5

Moonlight Blue metallic  
S4, S5, S6, S7, SQ5

Oolong Gray metallic  
S6, S7, S8, TTS

Quartz Gray metallic  
S6, S7, S8



Savana Beige pearl  
S8

Sepang Blue pearl  
RS 5 Coupe, R8 V10, R8 V10 plus

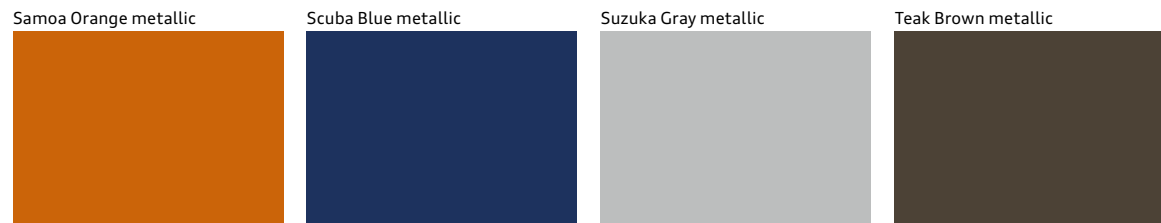

Samoa Orange metallic  
TTS, R8

Scuba Blue metallic  
TTS

Suzuka Gray metallic  
RS 5, RS 7, R8

Teak Brown metallic  
R8



Daytona Gray matte  
RS 7

Sepang Blue matte  
R8 V10 plus

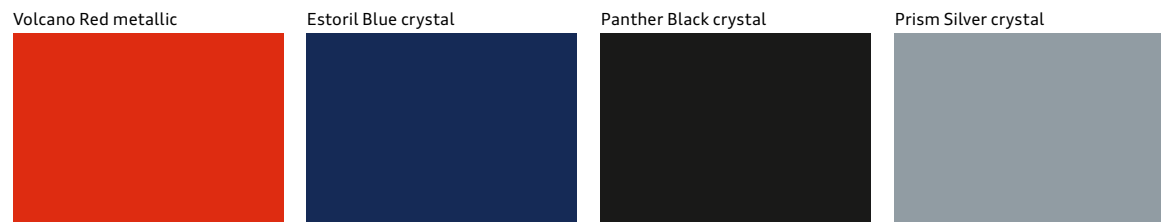

Volcano Red metallic  
S4, S5, TTS, SQ5

Estoril Blue crystal  
S4, S5, S6, S7, RS 5 Cabriolet, RS 7, R8, SQ5

Panther Black crystal  
RS 5, RS 7, TTS, R8, SQ5

Prism Silver crystal  
RS 5, RS 7



Apollo Silver metallic  
R8 Sideblade only

Saddle Brown pearl  
R8 Sideblade only

Carbon Fiber Sigma  
R8 Sideblade only