



RAM

2013 RAM 1500







**CAPABILITY. VERSATILITY. EFFICIENCY.
WELCOME TO A NEW BREED OF RAM.**

This is what others aspire to reach: technical developments that set new standards. Engineering refinements so unique, they instantly attain class-exclusive status. Exterior styling that decreases noise, vibration, and harshness (NVH) to mere whispers. And, above all in a pickup, capability and quality you can depend on, no matter how hard you push it.

PERFORMANCE THAT SETS THE STAGE. Expand your thinking — and use the word “performance” not just for speed or torque, but to define every system and technology. What you get defies the norm. Like a new available powertrain that pairs the TorqueFlite™ 8 — the world’s first 8-speed automatic transmission in a pickup — with V6 Pentastar® power and available 4x4 transfer case versatility. A new, class-exclusive^[1] * available Active-Level™ Four-Corner Air Suspension System. A flowing aerodynamic exterior with new wheel designs. Refined interior treatments with welcome new soft touches in a tough truck. New available possibilities for communications with indispensable hands-free convenience. All backed with the quality of our 5-Year/100,000-Mile Powertrain Limited Warranty^[2] — so good, it’s unsurpassed.^[1] Ram is destined for award-winning recognition from critics and public alike.

THIS IS THE NEW 2013 RAM 1500.

*Note: all disclaimers and disclosures can be found at the back of this brochure.





FUEL ECONOMY



400 mi Range

Hold > to Reset All
12567 mi

P R N D 8 8



Information Provided by
DEALER
E-PROCESS

A MODEL OF INNOVATION

**FROM COMFORT TO CAPABILITY TO FUEL EFFICIENCY,
THIS RAM IS LIGHT-YEARS IN FRONT OF THE OTHERS.**

After nearly a century of ongoing developments, the truck that has become the new 2013 Ram 1500 is all about the complete package: beyond-capable strength, uncompromising comfort, and futuristic communications. And, more important than ever, utilizing innovative engineering that delivers it all by sipping the least amount of fuel possible. For us, it means moving beyond conventional thinking and typical technologies.

HIGH FUEL EFFICIENCY: THE NEW RAM HFE MODEL. Its name says it all: for 2013, this new Ram picks up where others don't dare to go — and to be sure, it comes out in front. Irrespective of comparisons to wanna-be competitive models, the formidable new Ram 1500 HFE — the High Fuel Efficiency model — stands alone as the most fuel-efficient vehicle in its class.^[1]

THE NEW CLASS-EXCLUSIVE^[1] ACTIVE-LEVEL™ FOUR-CORNER AIR SUSPENSION SYSTEM.

This level-headed approach ensures superb off-road handling, improved aerodynamics at highway speeds, simple cargo loading, and easier in-and-out movement — in short, everything you could want in a pickup.

This all-new available system replaces the standard multilink coil spring rear suspension, now offering five distinctive ride heights (modes). Among them: authoritative Off-Road II Mode raises Ram by two inches from Normal; Off-Road I when not that much is needed; sleek Aero Mode self-adjusts for highway-efficient performance; at the low end, Entry/Exit lowers the vehicle by another two inches. The intuitive technology self-levels to keep an even profile — even under extreme payloads. Both automatically and/or manually controlled by the new button bank and key fob, it's available on all 2013 Ram 1500 Quad Cab® and Crew Cab models in 4x4 and 4x2 configurations.





3.6L
VVT

THE PENTASTAR® V6. IMPRESSIVE FROM THE GET-GO.

Consider every advantage, and you're considering seriously impressive efficiency and capability. The Pentastar application in the **NEW 2013 RAM 1500** churns out nothing less than **BEST-IN-CLASS^[1] FUEL ECONOMY^[3]**. The bigger picture is framed by **CLASS-EXCLUSIVE DISTINCTIONS AND FIRST-EVER DEVELOPMENTS**. The 2013 Ram 1500 welcomes **NEW AVAILABLE CAPABILITY WITH PURE V6 ECONOMIES**, highway cruising figures comfortably achieving the mid-20 mpg^[3] goal. Paired with the available **NEW TORQUEFLITE™ 8 ELECTRONIC 8-SPEED AUTOMATIC** — the first 8-speed transmission in a pickup, featuring a **SEGMENT-FIRST^[1] ELECTRONIC ROTARY SHIFTER** — the Pentastar V6 is all about fuel efficiency. Contributing technology encompasses the **NEW PULSE-WIDTH-MODULATED FUEL PUMP AND COOLING FAN**, which operate only at the levels required by the engine, not some predetermined rate. This improves vehicle efficiency by conserving electrical energy, and increases the fuel pump life because it isn't constantly running at full capacity. **VARIABLE VALVE TIMING (VVT)** enhances efficiency and power, with new **SOPHISTICATED THERMAL MANAGEMENT SYSTEMS** (for the Pentastar engine *and* the TorqueFlite 8) seriously separating new 2013 Ram 1500 from the rest of the pack.



ALL-NEW ROTARY SHIFTER.

SHIFTING GEARS AT THE SPEED OF INGENUITY.

Dashboard-mounted, and now with all-electronic operation to match the TorqueFlite 8 electronic interface, and replacing the previous lever shifters for at-your-fingertips ease. Transfer case operation (when equipped) is conveniently placed beneath the new Rotary Shifter; it too is fully electronic. Transmission gear changes (the up- and downshifting essential for towing and

hauling, as well as rocking in deep snow) are easier than ever. For a more refined operation, new Ram 1500 models equipped with the TorqueFlite 8 now use steering wheel-mounted buttons for manual gear range selection — offering more control when towing and hauling heavy loads.

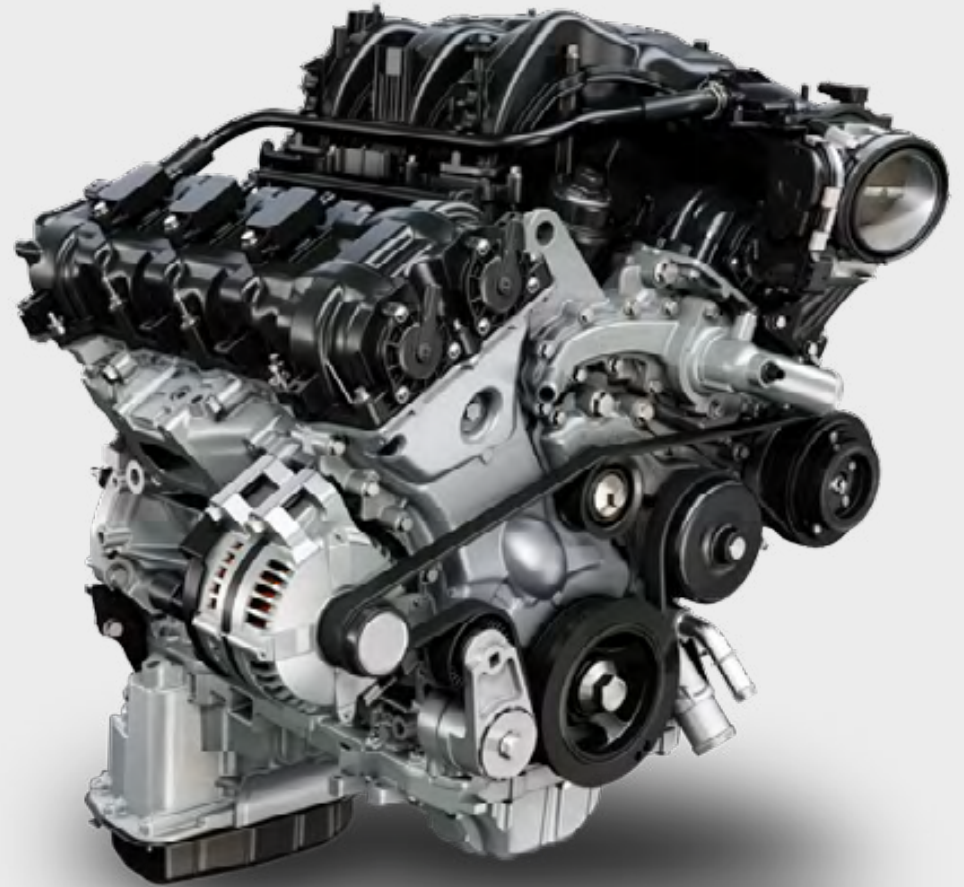

Information Provided by:



6 + 8 = 25

**ADD NEW 6-CYLINDER ECONOMY^[3] TO
ALL-NEW 8-SPEED EFFICIENCY:
THE RAM 1500 25 HWY MPG^[3] IS UNEQUALLED.^[1]**

It once was a compromise, pitting the built-in efficiencies of the 6-cylinder engine against the pickup standard: 4x4 capability. No longer. Once again, new 2013 Ram 1500 breaks the rules, achieving new benchmarks with the best V6 in our history — our award-winning Pentastar V6 power plant with 305 horsepower and 269 lb-ft of torque.

THE 3.6-LITER PENTASTAR® V6. HOW LEADERSHIP IS ATTAINED.

Obviously, the best-in-class^[1] fuel economy^[3] figures and available 4x4 capability both rank high — but the Pentastar V6 story was written with way-big-picture economies in mind. The engineering utilizes some of the most advanced automotive engine technologies available; results are exceptional, with an engineered-in focus on low cost of maintenance over the life of the power plant.

The details prove it. This award-winning engine delivers an outstanding balance of high specific output and high torque over a broad rpm band, with notable control over noise, vibration, and harshness (NVH). Assets include a “Silent Chain” timing drive — which also contributes to durability; four valves per cylinder; a dual overhead cam design; high-flow “tumble” intake ports; and an authoritative 10.2:1 compression ratio. Further assets include the new pulse-width-modulated fuel pump and cooling fan for more efficient fuel delivery and electrical load, Variable Valve Timing (VVT), and a fine, sophisticated thermal management system for optimal power, performance, and efficiency.

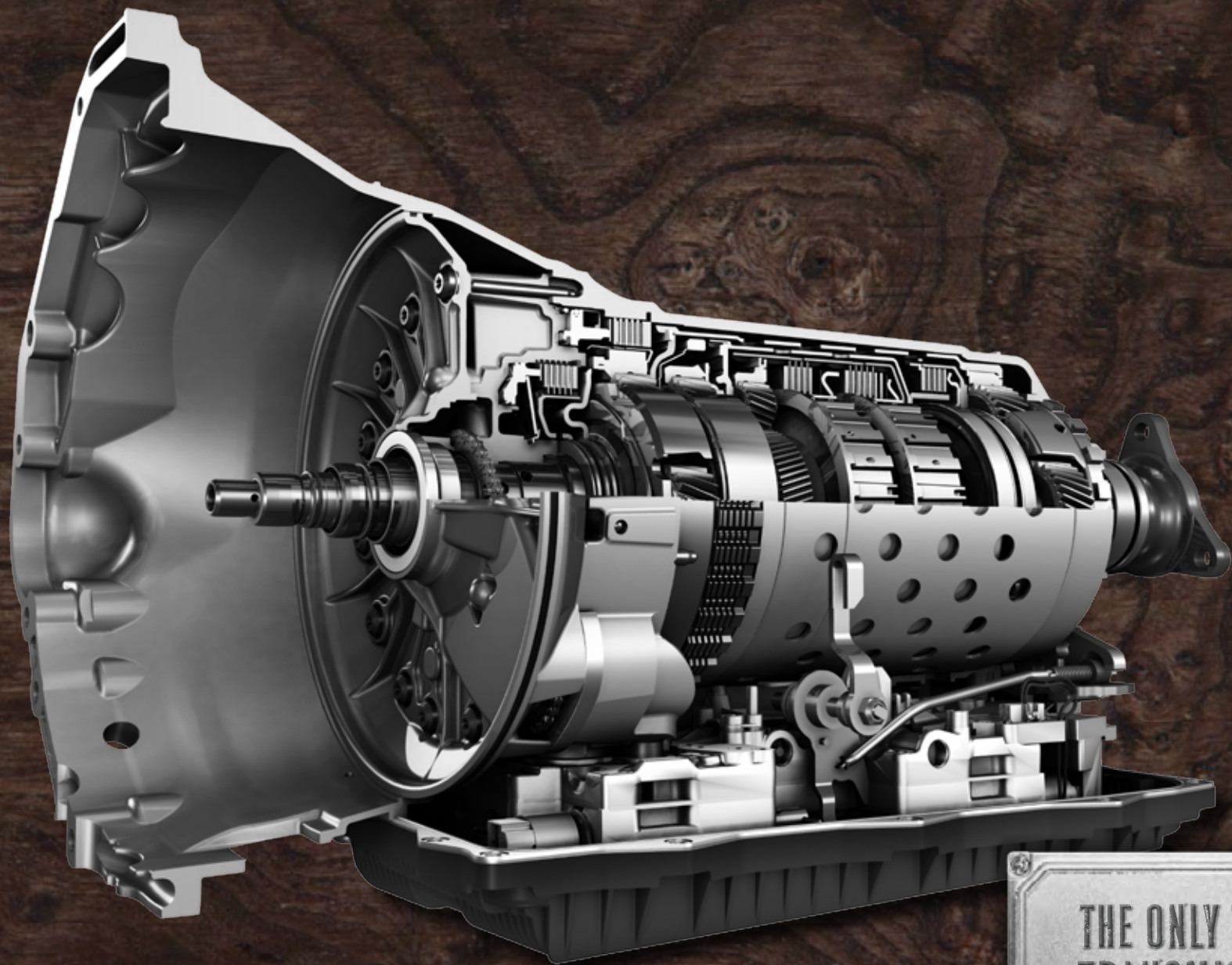

THE ONLY TRUCK
TRANSMISSION
OF ITS KIND™

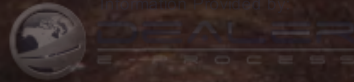



Properly secure all cargo.



THE HEMI® V8

THE AUTHORITATIVE 8-CYLINDER BOLDLY TAKES ON THE NEXT BIG CHALLENGE: EXTRAORDINARY FUEL EFFICIENCY WITH OUTSTANDING POWER; 395 HP AND 407 LB-FT OF TORQUE

The history of the hemispherical head is so exceptional in the world of transportation and engineering, it's now approaching legendary status. The bulletproof nature of this design has resulted in applications ranging from WWII aircraft to Muscle Car Era domination to the stunning and refined performance of the new 2013 Ram 1500 models.

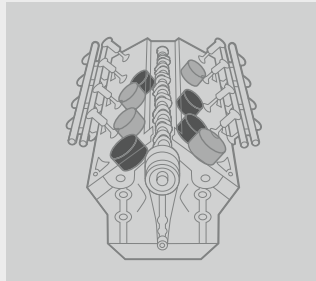

It's an 8-cylinder for the tough jobs, an efficient 4-cylinder for the cruise. Sometimes less is truly better.

LETTER-PERFECT FUEL EFFICIENCY: MDS, VVT, AND SRV.

The emphasis is performance that meets future criteria, and the HEMI V8 goes the extra mile. The Multi-Displacement System (MDS) Fuel Saver Technology seamlessly shuts off four of the eight cylinders when less power is needed, transforming the mighty V8 into a fuel-sipping 4-cylinder. Variable Valve Timing (VVT) opens and closes the valves in the most ideal manner based on engine speed and driving conditions, allowing optimal engine breathing throughout the entire rpm range and delivering valuable increased torque for towing and hauling.

Greater efficiencies of operation are also accomplished by the Short Runner Valve (SRV) Active Intake Manifold, which controls intake airflow by changing the port length based on engine rpm. The SRV contributes to both horsepower and torque improvements over similar engines lacking the technology and joins the many contributing factors which make this engine design so phenomenally successful.



CAPABILITY TO EXCEED THE NEED.

All towing figures: when properly equipped.



REGULAR CAB SHORT BOX
9,250-LB MAX TOW CAPACITY
1,620-LB PAYLOAD CAPACITY



REGULAR CAB LONG BOX
10,450-LB MAX TOW CAPACITY
1,930-LB PAYLOAD CAPACITY



QUAD CAB®
10,350-LB MAX TOW CAPACITY
1,800-LB PAYLOAD CAPACITY



CREW CAB
10,300-LB MAX TOW CAPACITY
1,750-LB PAYLOAD CAPACITY



Information Provided by
DEALER
E-PROCESS

MILES AHEAD. AND MILES PER GALLON AHEAD.

ACROSS-THE-BOARD EFFICIENCY: With the new Ram 1500 V6 models offering 25 hwy mpg,^[3] they are rapidly making the formerly unthinkable into daily routine. But these remarkable Ram 1500 models reflect how the entire Ram family is achieving exceptional fuel-efficient performance, with Ram 1500 V8-powered models offering 20 hwy mpg.^[4] And, while engine and transmission improvements are critical, equally important are the raft of improvements that

reduce aerodynamic drag into flowing, if not flawless, performance. Thousands of hours of analysis and wind tunnel testing conclusively demonstrate the ability of Ram 1500 engineers and designers to translate complex data into style, performance, and design refinements that put this pickup far ahead of the others. You'll find much more on the new Ram design at ramtrucks.com

+ REAR TONNEAU COVER (STANDARD ON HFE, AVAILABLE ON ALL OTHER RAM MODELS; LATE AVAILABILITY) FACILITATES MOVEMENT OF AIR OVER THE BODY, POSITIVELY AFFECTING AIRFLOW AND FURTHER REDUCING AERODYNAMIC DRAG — ONE MORE STEP TO ACHIEVING IMPRESSIVE FUEL EFFICIENCY.



+ WITH THE NEW RAM 1500 DESIGN PARAMETERS, WIND PASSAGE AND AIR LEAKAGE INTO THE PASSENGER COMPARTMENT — PRINCIPAL SOURCES OF NOISE — REACH NEW LOWS IN DECIBEL MEASUREMENT.

+ THE SLOPING WINDSHIELD, NEW GRILLE TREATMENTS, AND NEW FRONT END ALL CONTRIBUTE TO BEST-IN-CLASS^[1] AERODYNAMICS AND STUNNING VISUAL PRESENCE.

+ EXTERIOR MIRRORS ARE SHAPED FOR IDEAL WIND FLOW. NEW POWER FOLDING 6- x 9-INCH MIRRORS ARE AVAILABLE AS WELL AS 7- x 11-INCH TOWING MIRRORS.

+ NEW AVAILABLE CLASS-EXCLUSIVE^[1] ACTIVE GRILLE SHUTTERS INSTANTLY ADAPT TO SPEED, LOAD, AND ENGINE NEEDS, SIGNIFICANTLY REDUCING AERODYNAMIC DRAG TO HELP IMPROVE FUEL EFFICIENCY.



+ NEW AVAILABLE WHEEL-TO-WHEEL SIDE STEPS ALSO HELP IMPROVE AERODYNAMICS, HELPING TO IMPROVE FUEL EFFICIENCY. ADDITIONAL BENEFITS: EASIER ENTRY/EXIT FOR PEOPLE, AND EASIER SIDE ACCESS TO THE CARGO BED.

+ THE SEGMENT-EXCLUSIVE^[1] AVAILABLE NEW ACTIVE-LEVEL™ FOUR-CORNER AIR SUSPENSION SYSTEM OFFERS AUTOMATIC LOAD-LEVELING AND FIVE NEW MODES OF HEIGHT CONTROL — ONE SO REFINED, IT'S EARNED AN "AERO" TITLE. DETAILS ON PAGES 19-20.



+ WITH ITS BEST-IN-CLASS^[1] AERODYNAMIC EFFICIENCY, NEW RAM HFE SETS THE STANDARD. FACT: ALL RAM MODELS FEATURE A SLEEK NEW DESIGN WITH SUPERB AIRFLOW — REDUCING DRAG FOR EXCEPTIONAL INTERIOR QUIETNESS.

Information Provided by:
DEALER





RAM



**BRILLIANT NEW TOUCHES
IN DESIGN AND LIGHTING.**

Awesome illumination from new available 70-mm bi-functional halogen projector headlamps. Upgraded available Active High Beam Headlamp Control for split-second response. New available vertical fog lamps with greater surface area. On the Ram 1500 Sport, R/T, Laramie, and Laramie Longhorn models, unique new 15-element LED taillamps, and inside, new Blue Sapphire interior ambient lighting.

SIGNATURE: RAM. From the subtle Ram's Head logo in the available jeweled headlamps to the new interior lighting treatments, the new 2013 Ram 1500 is, from every perspective, easy on the eyes.



**ONLY ONE TRUCK OFFERS THIS DEGREE
OF CARGO BIN VOLUME:^[1] THE ONE WITH
THE RAMBOX® CARGO MANAGEMENT SYSTEM.**

THIS M.B.A. IN CARGO MANAGEMENT EARNS TOP HONORS. Meet the available RamBox System, offering secure capability like no other in the class.^[1] Here a bed extender/divider, bed rails, and four adjustable cleats are augmented by two illuminated, lockable, and drainable compartments — large enough for tools, bags of golf clubs, or an abundance of 12-ounce cans with ice. Available Authentic Accessories by Mopar® — like the RamBox Holster, for fishing rods and/or long guns — ramp up versatility. And the cargo bed retains full capacity, letting you haul 4- x 8-foot sheets of building material with ease. New for 2013: The RamBox System is now part of the All-Secure™ Locking System, with all locks controlled by a simple push of a key-fob button or the door lock switch.

Properly secure all cargo.





ACCOMMODATES
4-FOOT-WIDE
BUILDING
MATERIALS

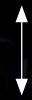

Information Provided by
DEALER

Properly secure all cargo.

GROUNDING WITH STEEL. RIDING ON AIR.

This is technology, materials engineering, innovative thinking, and good ol'-fashioned American sweat coming together for one sweet ride. The frame — created from Advanced High-Strength Steel, the same stuff used in submarine hulls — is now stronger, quieter, and lighter. Fully boxed, it adds critical crossmembers and frame sections — some rated as high as 80,000 psi.

Performance, handling, and stability show across-the-board improvements, thanks to advanced CAE (Computer-Aided Engineering) modeling techniques. But the stunning news is the all-new, available Active-Level™ Four-Corner Air Suspension System, offering unprecedented response and control for virtually any driving condition — and with a specialized Aero Mode for cruising.

RIDING ON AIR: THE NEW CLASS-EXCLUSIVE^[1] AVAILABLE ACTIVE-LEVEL FOUR-CORNER AIR SUSPENSION SYSTEM.

It's your choice: ride on the Ram 1500 standard, class-exclusive^[1] multilink coil spring rear suspension, or take a big step into the future. 2013 Ram 1500 now offers another first — the available Active-Level Four-Corner Air Suspension System with automatic load-leveling and five distinct modes, controlled by the smart new button bank.

- + **OFF-ROAD 2 MODE.** Provides best-in-class^[1] ground clearance for the path and trail, delivering the greatest angles for the approach, departure, and break-over. Difference from Normal ride height: +51mm (+2.0 in).
- + **OFF-ROAD 1 MODE.** Good balance, with an extra degree of clearance. Difference from Normal: Front, +30mm (+1.2 in), Rear, +22mm (+0.9 in).
- + **NORMAL RIDE HEIGHT.** Everyday use; designed for the most comfortable balance of ride and handling.
- + **AERO MODE.** Automatically lowers the vehicle at highway speeds to reduce aerodynamic drag and “body roll” — and thus helping to improve fuel efficiency. Difference from Normal: -27mm (-1.1 in).
- + **ENTRY/EXIT MODE.** Automatically lowers the entire vehicle for easier ingress/egress, loading/unloading, trailer hooking/unhooking. Controlled by internal button bank or with a button on the key fob. Difference from Normal: Front, -53mm (-2.1 in), Rear, -43mm (-1.7 in).

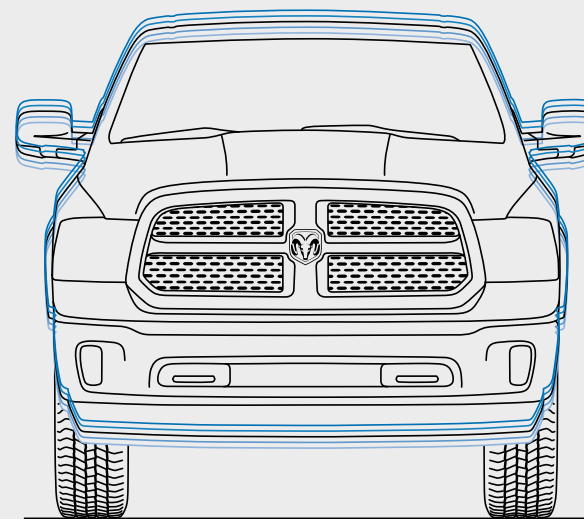

- + OFF-ROAD 2 MODE
- + OFF-ROAD 1 MODE
- + NORMAL RIDE HEIGHT
- + AERO MODE
- + ENTRY/EXIT MODE



FINGERTIP SUSPENSION CONTROL. With this new Integrated Switch Bank, operating the available new Active-Level™ Four-Corner Air Suspension System is a snap: go from any mode to another with a push of a button for ideal ride height for the terrain and conditions. The Switch Bank controls a raft of features, including the available Stop/Start system (not shown in image), Electronic Stability Control (ESC),¹⁵ Tow/Haul mode, and available features like heat and ventilation for seats, heated steering wheel — and more.



PREMIUM KEYLESS
ENTER 'N GO

+ KEY FOBs ARE NOW MORE VERSATILE THAN EVER. FUNCTIONS RANGE FROM KEYLESS (BLADELESS) CONFIGURATIONS TO MAJOR CONTROLS, INCLUDING REMOTE START, ALL-SECURE™ LOCKING SYSTEM, PANIC BUTTON, AND EVEN THE ENTRY/EXIT MODE OF THE NEW AVAILABLE ACTIVE-LEVEL FOUR-CORNER AIR SUSPENSION SYSTEM.

+ FOUR NEW ADDITIONAL CROSSMEMBERS SIGNIFICANTLY IMPROVE RIDE QUALITY AND HANDLING, WHILE HELPING TO REDUCE NOISE, VIBRATION, AND HARSHNESS (NVH).

+ NEW REDESIGNED BODY MOUNTS AT THE C-PILLARS AND THE FRONT-END MODULE ARE NOW 11 PERCENT LARGER, IMPROVING THE DAMPENING OF LATERAL SHAKE. THE UPSHOT: MORE PASSENGER COMPARTMENT COMFORT.

+ TO FURTHER REDUCE WEIGHT, NEW RAM 1500 EMPLOYS DOWN-GAUGED STEEL IN NUMEROUS PLACES WHERE HEAVY STEEL ISN'T NEEDED — AGAIN, TO HELP IMPROVE FUEL EFFICIENCY.

+ THE STRUCTURAL REAR BUMPER IS RATED FOR CLASS III TOWING, EASILY HANDLING TRAILERS UP TO 5,000 LB (WHEN PROPERLY EQUIPPED). AN EVEN TOUGHER TRAILER TOW SOLUTION RAMPS UP CAPABILITY — WITH THE AVAILABLE CLASS IV HITCH RECEIVER THAT BOLTS DIRECTLY TO THE FRAME.

+ THE FRONT BODY STRUCTURE IS CONSTRUCTED OF HYDROFORMED TUBULAR HIGH-STRENGTH STEEL, PROVIDING AN ULTRA-STIFF YET LIGHT COMPONENT. REDUCED WEIGHT FOR THE 2013 RAM 1500 FRAME HELPS CONTRIBUTE TO IMPROVED FUEL EFFICIENCY.

+ THIS LOW-TORSION FRAME FEATURES FULLY BOXED SIDE RAILS, HELPING MAINTAIN THE RAM 1500 REPUTATION FOR MINIMAL NVH.

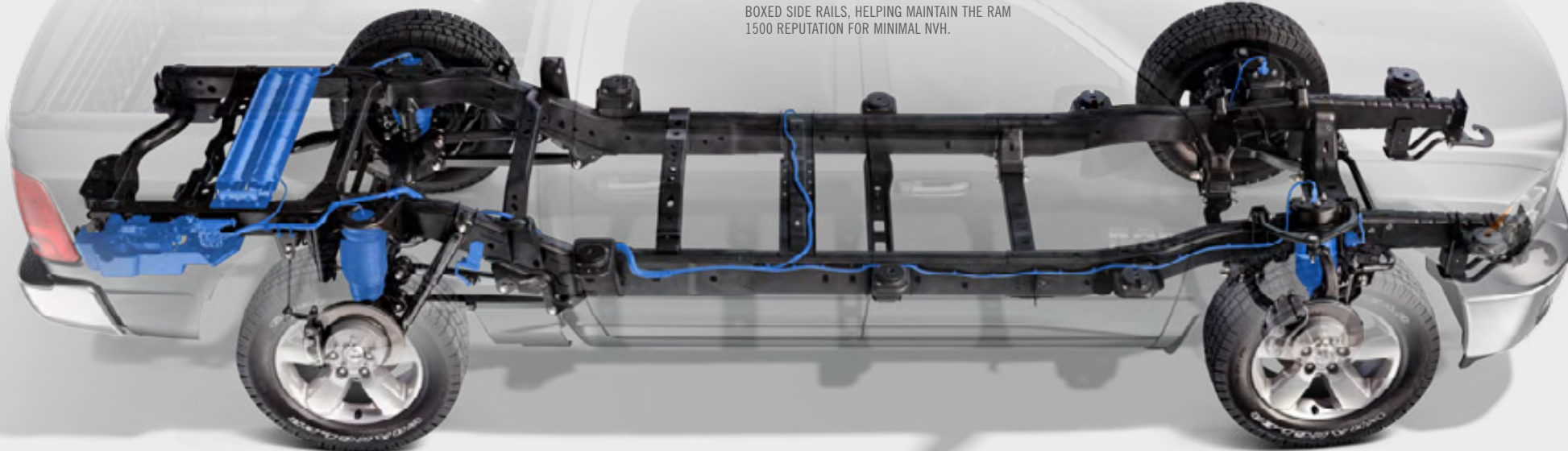

Information Provided by:





Properly secure all cargo.







LARAMIE
LONGHORN
RAM
1500

**QUIETLY ACHIEVING NEW LEVELS
OF TECHNOLOGY AND COMFORT.**

New interior treatments that distinguish themselves based on trim level. Updated colors, materials, and surfaces for the instrument panel, seats, doors, and ancillary trim. New lighting, with stunning Blue Sapphire LED ambient illumination for switches and footwells on select models. Even new air outlets that address both improved functionality and design.

THE BEAUTY IS IN THE DETAILS. The interior of the new Ram 1500 stands out in every respect where it counts the most — from the brilliant available new six-ring instrumentation and controls, to the new two-toned interiors, to the new integrated center stack configurations. Look for new, large, available full-color displays for information, navigation, radio, and vehicle functions. Reconfigured sun visors. New cup holder designs that offer greater ease of use. From the big-picture thinking that brings you new available 8.4-inch color screens to the fine hand-wrapped features and fine stitching that give Ram 1500 Laramie Longhorn such distinction, the new Ram 1500 interior leaves no detail untouched — exactly why, from the first glance, the many new soft touches and superbly comfortable ride make such a lasting impression.



Ram 1500 Laramie Longhorn seats shown in Canyon Brown with laser etching.



Ram 1500 Laramie Longhorn interior shown in Cattle Tan/Black.





Ram 1500 Crew Cab Laramie Longhorn interior shown in Cattle Tan/Black.





YOU'LL SEE THIS NEW INSTRUMENTATION IN A VERY DIFFERENT LIGHT.



A NOD TO THE PAST — AND THE TECHNOLOGY OF THE FUTURE. For the 2013 Ram 1500, each trim level now reflects a bold new look for the instrument panel and EVIC (Electronic Vehicle Information Center) display. The available six-ring cluster borrows design touches from antique watches and vintage firearms. It's pure Ram, all the way.

THE NEXT LEVEL OF EVIC. Stunning full-color graphics from the available new 7-inch Multi-View Display that uses Thin Film Transistor (TFT) display technology. Scroll-through roller-type interfaces with instant vehicle information and graphics from 34 menu options. This is technology driving to be the best.

ALL-NEW POWERNET ELECTRICAL ARCHITECTURE. It's the equivalent of a high-speed internet connection in your Ram, conveying information about virtually every facet of vehicle operation through "smart" modules located throughout the vehicle.

THE UPSHOT: KNOWLEDGE. Leave the smartphone-like intuitive technology aside for a moment. In the final analysis, you've got a wealth of information literally at your fingertips, with a steering wheel-mounted toggle switch that takes you through dozens of different pieces of information — everything from trailer towing to critical pressures and powertrain operating temperatures.

COMMUNICATIONS TECHNOLOGY DESIGNED FOR THE REAL WORLD.



STAY IN CONSTANT TOUCH. AND DO IT HANDS-FREE.

UCONNECT® 3.0. With four-line full LCD display; AM/FM with remote USB; iPod® integration. Available: SiriusXM Satellite Radio,^[6] remote CD player, steering wheel controls.

UCONNECT 5.0. With 5-inch full-color touch-screen display; AM/FM with remote USB; iPod integration; Bluetooth® connectivity for hands-free phone, streaming audio, voice commands,^[7] text message reader; rearview camera^[9] ready; SiriusXM Satellite Radio.^[6] Available: remote CD player, steering wheel controls.

SIRIUSXM PREMIER: OVER 160 CHANNELS. Enjoy every available satellite radio channel: commercial-free music, sports, news, talk, and entertainment, with premium programming bringing you Howard Stern, every NFL®, MLB®, and NHL® game, every NASCAR® race ... and more. Premier service also includes SiriusXM Latino — more than 20 channels dedicated to Spanish language programming.

UCONNECT 8.4A. With 8.4-inch full-color touch-screen display; AM/FM with remote USB/SD; iPod integration; steering wheel controls; Bluetooth connectivity for hands-free phone, streaming audio, voice commands,^[7] text message reader; also includes customer- (or dealer-) activated navigation; HVAC control integration; smartphone connectivity; available 3G WiFi hotspot;^[8] rearview camera^[9] ready; SiriusXM Satellite Radio.^[6] Available: remote CD player.

UCONNECT 8.4AN. With all features of all previous descriptions. Plus premium navigation with one-step voice destination entry, 3-D city modeling and landmarks, digital terrain modeling, 911/assist calling, and HD radio, SiriusXM Satellite Radio,^[6] SiriusXM Travel Link,^[6] and SiriusXM Traffic.^[6] Available: remote CD player.

For more information log on to driveuconnect.com



1500 TRADESMAN

THE MOST DIVERSE PORTFOLIO OF PICKUPS leads off with the one built from the ground up for the commercial market. The new Ram 1500 Tradesman is custom-designed for full-scale capability with low cost of ownership. The level of standard equipment in Ram 1500 Tradesman is substantial, and includes features not normally found on entry-priced trim levels. This is exactly the thinking that drives business. **CONFIGURATIONS: REGULAR CAB, QUAD CAB,[®] CREW CAB (4x2/4x4)**

Properly secure all cargo.





1500 EXPRESS **STANDING OUT FOR EXCEPTIONAL STYLE AND VALUE.** Built for new truck buyers who count themselves among the most cost-conscious. Ram 1500 Express doesn't disappoint, combining style, performance, capability, and value in one smart package. **CONFIGURATIONS: REGULAR CAB, QUAD CAB,[®] CREW CAB (4x2/4x4)**

1500 SLT **HERE, THE GOING GETS GOOD.** SLT models start the upscale offerings in the Ram 1500 family, with bright chrome accents, a distinguished grille treatment, and subtle, classy design touches for exterior bling and superb interior comfort. **CONFIGURATIONS: REGULAR CAB, QUAD CAB, CREW CAB (4x2/4x4)**





1500 HFE

IN EVERY WAY, A LEADER FOR OUR ECONOMY. Packed with the technology, aerodynamics, and styling cues to achieve impressive levels of fuel efficiency, the new 2013 Ram 1500 HFE model addresses fuel-economic^[3] performance like never before — and like no other. Its leadership in this area is uncontested.^[1] Compare it to any other V6- or V8-powered pickup: it is simply the most fuel-efficient offering in its class!^[1]
CONFIGURATIONS: REGULAR CAB (4x2)





1500 BIG HORN PREMIUM PERFORMANCE for guys who won't settle for less than "awesome." Ram 1500 Big Horn — branded Lone Star in Texas — offers upscale design cues like 20-inch wheels and dual exhaust, sharp interior features, impressive comfort, and exceptional capability. **CONFIGURATIONS: QUAD CAB[®], CREW CAB (4x2/4x4)**



1500 OUTDOORSMAN THIS TRUCK IS GAME FOR **EVERYTHING**. Created for the hunter, fisherman, or camper, with specialized capabilities and features for the great outdoors — including custom-designed, Outdoorsman-only Authentic Accessories by Mopar[®]. **CONFIGURATIONS: QUAD CAB, CREW CAB (4x2/4x4)**

Properly secure all cargo.





1500 SPORT AND R/T MOST LIKELY TO ACHIEVE. These two Ram 1500 models are akin to the popular kids in the class. When it comes to that unique combination of robust performance, head-turning exterior styling, and interior creature comforts, you've come to the right place. **CONFIGURATIONS: SPORT — REGULAR CAB (4x4); QUAD CAB®, CREW CAB (4x2/4x4). R/T — REGULAR CAB (4x2)**



1500 LARAMIE LIFE IS GOOD WHEN YOU'RE IN LARAMIE. Upscale in every way, with sharp two-tone exterior treatments, 20-inch chrome-clad aluminum wheels with plenty of exterior chrome to match, and an interior more typically associated with exclusive private clubs. **CONFIGURATIONS: QUAD CAB, CREW CAB (4x2/4x4)**

Properly secure all cargo.





YOU'VE PLAYED BY THE RULES. NOW YOU'RE AT THE TOP OF YOUR GAME. You need the one luxury Ram 1500 model that matches those accomplishments: Ram 1500 Laramie Longhorn. Count on two stunning soft-touch leather interiors — one of them with an exceptional laser-etched design — and distinctive treatments for the instrumentation, gauges, and steering wheel. The two-toned exterior says “opulence” to every envious sidelong glance — and you’ll get them. **CONFIGURATIONS: CREW CAB (4x2/4x4)**

Properly secure all cargo.

1500 LARAMIE LONGHORN





RAM 1500

WHEELWELL

Information Provided by

RAM



AUTHENTIC RAM ACCESSORIES



WITH YOU EVERY MILE. Mopar[®] is with you the moment you get your new keys and for every mile thereafter. Mopar helps maintain and make your ride your own with parts and accessories of every kind — all original equipment designed by the same engineers of your vehicle — specifically for your model. It's no-guesswork, get-it-right-the-first-time satisfaction with seamless fit and finishes, exact color matches, and high-quality materials that have been thoroughly tested for the long haul.

Mopar also assures you with expert technicians who know your make and model best, Vehicle Protection Plans, Express Lane Service, and with Mopar Owner Connect, a secure, “owners-only” site, accessible by registering at owners.ramtrucks.com. There you'll enjoy online access to service records, extensive vehicle information and links to where you can meet fellow Mopar enthusiasts.

See your RAM dealer for the latest accessories and parts available. Learn more about the world of Mopar and all it has to offer at mopar.com

Above: Ram 1500 Crew Cab Tradesman in Bright Silver Metallic shown with Side Window Air Deflectors, Wheel Flares, Stainless Steel Wheel-to-Wheel Tubular Side Steps, RamBox[®] Cargo Organizer, Sliding Toolbox, and RamBox Toolbags.



Heavy-Duty Commercial Toolbox



Aluminum Ladder Rack



Under-the-Rail Bedliner

SPECIFICATIONS



Information Provided by
DEALER
FINANCING

MAXIMUM LOADED TRAILER WEIGHT (LB)*																	
AUTOMATIC TRANSMISSION	Engine	Axle Ratio	GCWR	REGULAR CAB						QUAD CAB®				CREW CAB			
				SB 4x2	SB 4x4	RB 4x2	RB 4x4	LB 4x2	LB 4x4	SB 4x2	SB 4x4	RB 4x2	RB 4x4	SB 4x2	SB 4x4	RB 4x2	RB 4x4
3.6L V6	3.21	9,500	4,800	4,600	4,650	4,450	4,600	4,450	4,400	4,200	4,250	4,050	4,350	4,150	4,250	4,050	
	3.55	11,200	6,500	6,300	6,350	6,150	6,300	6,150	6,100	5,900	5,950	5,750	6,050	5,850	5,950	5,750	
4.7L V8	3.55	11,350	6,450	6,250	6,350	6,100	6,300	6,100	6,150	5,950	6,000	5,800	6,050	5,850	5,950	5,750	
	3.92	12,600	7,700	7,500	7,600	7,350	7,550	7,350	7,400	7,200	7,250	7,050	7,300	7,100	7,200	7,000	
5.7L HEMI® V8	4.10	10,050	5,050		4,900												
	3.21	12,100	7,200		7,050			7,000		6,800		6,700		6,750		6,650	
	3.55	14,150	9,250	9,050	9,100	8,900	9,050	8,850	8,850	8,650	8,750	8,500	8,800	8,600	8,700	8,450	
	3.92	14,100	9,200	9,000	9,050	8,850											
	3.92	15,650						10,450	10,350	10,350	10,150	10,250	10,000	10,300	10,100	10,200	9,950

MAXIMUM PAYLOAD CAPACITIES (LB)*																	
AUTOMATIC TRANSMISSION	Engine	GVWR	1500														
			REGULAR CAB						QUAD CAB				CREW CAB				
			SB 4x2	SB 4x4	RB 4x2	RB 4x4	LB 4x2	LB 4x4	SB 4x2	SB 4x4	RB 4x2	RB 4x4	SB 4x2	SB 4x4	RB 4x2	RB 4x4	
3.6L V6	6,010	1,430			1,290												
	6,025	1,520			1,370												
	6,300		1,580		1,430												
	6,600						1,910										
	6,700								1,800		1,660		1,750		1,630		
4.7L V8	6,800						1,930			1,680		1,540		1,650		1,530	
	6,025	1,340			1,190												
	6,350		1,440		1,290												
	6,600						1,750	1,550									
	6,700								1,690		1,540						
5.7L HEMI V8	6,800									1,570		1,420	1,690	1,490	1,570	1,370	
	6,200	1,370			1,220												
	6,350	1,620	1,420		1,470	1,280											
	6,600						1,710	1,470									
	6,700								1,610		1,470						
6,800									1,480		1,340	1,660	1,430	1,540	1,310		

*When properly equipped. SB = Short Box RB = RamBox® LB = Long Box

DIMENSIONS

REGULAR CAB SHORT BOX

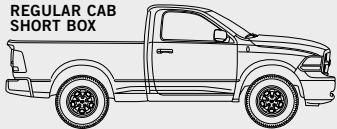

REGULAR CAB LONG BOX

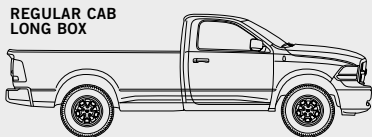

QUAD CAB

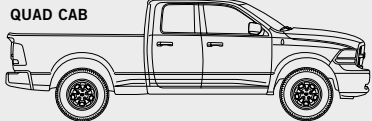

CREW CAB

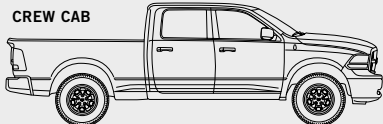

INTERIOR DIMENSIONS	REGULAR CAB	QUAD CAB	CREW CAB	
Head Room F/R	39.9	41.0/39.7	41.0/39.9	
Leg Room F/R	41.0	41.0/34.7	41.0/40.3	
Shoulder Room F/R	66.0	66.0/65.7	60.0/65.7	
Hip Room F/R	62.9	63.2/62.9	63.2/63.2	
Total Interior Volume (cu ft)	62.5	116.6	125.3	
EXTERIOR DIMENSIONS†	REGULAR CAB SHORT BOX	REGULAR CAB LONG BOX	QUAD CAB	CREW CAB
Overall Body Width	79.4	79.4	79.4	79.4
Overall Height (4x2/4x4)	74.6/75.2	74.4/75.0	75.1/75.7	75.1/75.7
Overall Length	209.0	231.0	229.0	229.0
Track – Front (4x2/4x4)	68.0/68.2	68.0/68.2	68.0/68.2	68.0/68.2
Track – Rear (4x2/4x4)	67.5/67.5	67.5/67.5	67.5/67.5	67.5/67.5
Wheelbase	120.5	140.5	140.5	140.5
Bed Height	20.1	20.2	20.1	20.0
Bed Length	76.3	98.3	76.3	67.4
Bed Width Wall	66.4	66.4	66.4	66.4
Bed Width Wheel	51.0	51.0	51.0	51.0

Note: all dimensions shown in inches unless otherwise specified. †Dimensions for base configurations.

3.6L PENTASTAR® V6

Proven strength, now improved to handle the new V6/4x4 available capability.

305 hp @ 6,400 rpm
269 lb-ft of torque @ 4,175 rpm

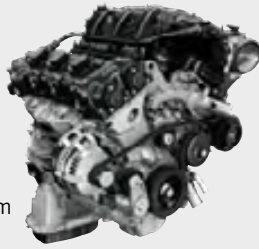

CONFIGURATION: 60-degree V6, liquid-cooled
DISPLACEMENT: 220 cu in/3604 cc
BORE/STROKE: 3.78 x 3.27 in/96.0 x 83.0 mm
BLOCK MATERIAL: Aluminum deep-skirt
CYLINDER HEAD MATERIAL: Aluminum alloy
VALVETRAIN: Chain-drive DOHC, 4 valves per cylinder (24 total), hydraulic roller rockers, variable phasing for intake and exhaust cams
FUEL DELIVERY/RECOMMENDED FUEL: Sequential multi-port injection/ unleaded regular (87 octane) (E85-compatible; non-HFE)
COMPRESSION RATIO: 10.2:1
ALTERNATOR: 220-amp HFE, 180-amp non-HFE
ADDITIONAL FEATURES: E85 Flex Fuel capable (non-HFE), VVT, exhaust manifolds integrated with cylinder heads, composite construction intake manifold and valve covers.

4.7L V8 POWER PLANT

Standard engine for Ram 1500, Flex Fuel capable with advanced engine management systems.
310 hp @ 5,650 rpm
330 lb-ft of torque @ 3,950 rpm



CONFIGURATION: 90-degree V8, liquid-cooled
DISPLACEMENT: 287 cu in/4701 cc
BORE/STROKE: 3.66 x 3.40 in/93.0 x 86.5 mm
BLOCK MATERIAL: Cast-iron
CYLINDER HEAD MATERIAL: Aluminum alloy
VALVETRAIN: Chain-drive SOHC, 16 valves, normally open check-valve lash adjusters
FUEL DELIVERY/RECOMMENDED FUEL: Sequential multi-port injection/unleaded regular (87 octane) (E85-compatible)
COMPRESSION RATIO: 9.8:1
ALTERNATOR: 160-amp
ADDITIONAL FEATURES: E85 Flex Fuel capable, dual spark plugs per cylinder, composite construction intake manifold and valve covers.

5.7L HEMI® V8

The legendary engine delivers outstanding power and impressive fuel efficiency and mileage.
395 hp @ 5,600 rpm
407 lb-ft of torque @ 3,950 rpm

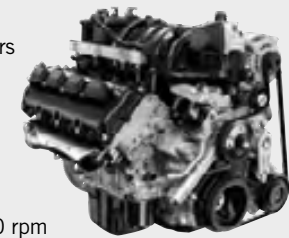

CONFIGURATION: 90-degree V8, liquid-cooled
DISPLACEMENT: 345 cu in/5654 cc
BORE/STROKE: 3.92 x 3.58 in/99.5 x 90.9 mm
BLOCK MATERIAL: Deep-skirt cast-iron, with cross-bolted main bearing caps
CYLINDER HEAD MATERIAL: Aluminum alloy with hemispherical combustion chambers
VALVETRAIN: Chain-drive cam-in-block OHV with variable valve timing, 16 valves, hydraulic lifters with roller finger followers
FUEL DELIVERY/RECOMMENDED FUEL: Sequential multi-port injection/ unleaded mid-grade recommended (89 octane)/unleaded regular acceptable (87 octane)
COMPRESSION RATIO: 10.5:1
ALTERNATOR: 180-amp
ADDITIONAL FEATURES: MDS Fuel Saver Technology, dual spark plugs per cylinder, dual stage intake with short runner valve (SRV), composite construction intake manifold and valve covers.

INTRODUCING UCONNECT® ACCESS

 New Ram 1500 brings you more Uconnect features and services than ever before. From instant Assist to obtaining information about your new Ram model, Uconnect Access does it all: radio, media, phone, vehicle information. Uconnect is so sophisticated, you can even register from your new Ram. It's all there, with the simplicity of Voice Command^[7] and fingertip control — now with brilliant displays on the new full-color EVIC screens. Notable Uconnect features include:

- 911 CALL.** Report an accident without taking your eyes off the road. Just press a button on your rearview mirror, and you're instantly connected with the right local authorities.
- ROADSIDE ASSISTANCE CALL.** If you get a flat tire, or need a tow, just press the Assist button on your rearview mirror and you're connected to help. Roadside Assistance automatically knows the vehicle you're driving and location. Additional fees may apply.
- STOLEN VEHICLE ASSISTANCE.** If your vehicle is ever stolen, Uconnect can provide your vehicle location to police to help them track it down.
- THEFT ALARM NOTIFICATION.** Choose to receive a text or eMail alert anytime your vehicle's theft alarm is activated.
- VOICE TEXTING.** Powerful, cloud-based voice recognition allows you to dictate free-form text messages, and send them from your Bluetooth® enabled phone without taking your hands off the wheel or focus from the road.

- REMOTE DOOR LOCK/UNLOCK.** Use the Uconnect Access app to lock or unlock your vehicle from virtually anywhere with your computer or smartphone.
- REMOTE VEHICLE START.** Use a computer or the Uconnect Access smartphone app to start your engine and warm up or cool down your vehicle before you get in.
- REMOTE HORN AND LIGHTS.** No matter where you are, you can sound your horn and flash your lights to locate your vehicle using the Uconnect Access smartphone app.
- WIFI^[8] HOTSPOT.** WiFi creates a mobile, on-demand hotspot in and around your vehicle, so passengers can shop, surf the web, check eMails, and stay socially connected wirelessly on their personal devices. Late availability.
- INSTANT IN-VEHICLE ASSIST.** Wondering about any Uconnect feature, app, or registration? Questions about your new Ram? Just press the Uconnect Access button, and you're immediately connected to the right source for answers.





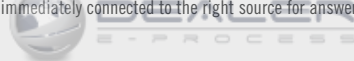
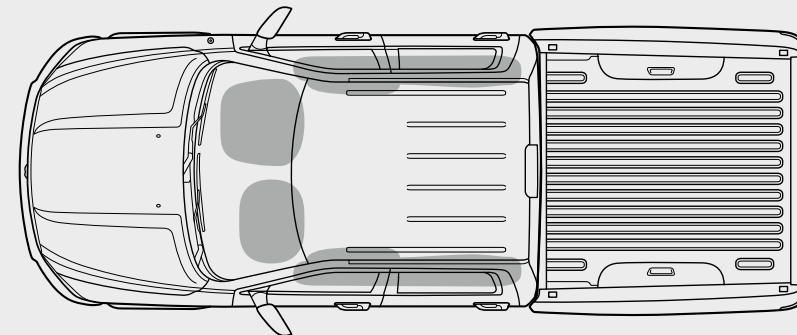

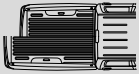

SAFETY & SECURITY

Crash avoidance is always the goal — but when life happens, the new Ram 1500 is ready for it. Count on multiple front air bags,^[10] including: advanced multistage air bags, side-curtain air bags, front seat-mounted side air bags, and knee bolsters. The Electronic Stability Control (ESC)^[5] system offers additional engineering to help protect you: this combination of multiple technologies and advanced software is all about maintaining critical control when you need it most.



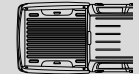

TRADESMAN

CABS	BEDS	SEATING
 Regular Cab	 6'4" Box or 8' Box	 40/20/40 Bench Seat
 Quad Cab®	 6'4" Box	 40/20/40 Bench Seat
 Crew Cab	 5'7" Box	 40/20/40 Bench Seat

MECHANICAL

4.7L Flex Fuel V8 with 6-speed automatic transmission and heavy-duty cooling system • Electronic Stability Control (ESC)^[5] system includes 4-wheel ABS, Brake Assist, Rain Brake Support, Ready Alert Braking, All-Speed Traction Control, Electronic Roll Mitigation, Hill Start Assist, and Trailer Sway Control^[5] • Multilink coil spring rear suspension • 26-gallon fuel tank (32-gallon fuel tank with 8-foot box models) • Electronic part-time transfer case on 4x4 models

INTERIOR







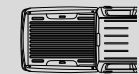

Vinyl 40/20/40 front bench seat • Vinyl folding rear bench on Quad Cab and Crew Cab models • Vinyl floor covering • Advanced multistage front air bags^[10] • Supplemental side-curtain air bags^[10] • Supplemental front-seat side-mounted air bags^[10] • Tilt steering wheel • Automatic headlamps • Air conditioning • Power windows and power door locks on Quad Cab and Crew Cab models • 3.5-inch LCD Electronic Vehicle Information Center (EVIC) located in instrument cluster • Uconnect® 3.0 AM/FM radio • MP3 auxiliary jack and 1.5-amp USB jack

EXTERIOR

Black front and rear bumpers • Black grille surround and inserts • Black front upper fascia • Quad-lens headlamps • Bed rail caps • Spray-in bedliner • Locking tailgate • 4- and 7-pin trailer wiring harness/connectors • Class IV trailer hitch receiver • 17-inch painted steel wheels with BSW tires • Black fold-in sideview mirrors

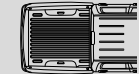

EXPRESS

CABS	BEDS	SEATING
 Regular Cab	 6'4" Box	 40/20/40 Bench Seat
 Quad Cab	 6'4" Box	 40/20/40 Bench Seat
 Crew Cab	 5'7" Box	 40/20/40 Bench Seat

MECHANICAL

5.7L HEMI® V8 with 6-speed automatic transmission and heavy-duty cooling system • Electronic Stability Control (ESC)^[5] system includes 4-wheel ABS, Brake Assist, Rain Brake Support, Ready Alert Braking, All-Speed Traction Control, Electronic Roll Mitigation, Hill Start Assist, and Trailer Sway Control^[5] • Multilink coil spring rear suspension • 26-gallon fuel tank • Electronic part-time transfer case on 4x4 models

INTERIOR









Vinyl 40/20/40 front bench seat • Vinyl folding rear bench on Quad Cab and Crew Cab models • Carpet floor covering • Advanced multistage front air bags^[10] • Supplemental side-curtain air bags^[10] • Supplemental front-seat side-mounted air bags^[10] • Tilt steering wheel • Automatic headlamps • Air conditioning • Power windows and power door locks on Quad Cab and Crew Cab models • 3.5-inch LCD EVIC located in instrument cluster • Uconnect 3.0 AM/FM radio • MP3 auxiliary jack and 1.5-amp USB jack

EXTERIOR

Body-color full front fascia and rear bumper • Fog lamps • Body-color grille surround with Black inserts • Quad-lens headlamps • Bed rail caps • Locking tailgate • 4- and 7-pin trailer wiring harness/connectors • 20-inch painted aluminum wheels with BSW tires • Black fold-in sideview mirrors • 4-inch chrome-tipped dual exhaust

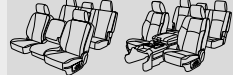

SLT

CABS	BEDS	SEATING
 Regular Cab	 6'4" Box or 8' Box	 40/20/40 Bench Seat Bucket Seats, Available
 Quad Cab	 6'4" Box	 40/20/40 Bench Seat Bucket Seats, Available
 Crew Cab	 5'7" Box	 40/20/40 Bench Seat Bucket Seats, Available

MECHANICAL

3.6L Pentastar® V6 with TorqueFlite™ 8 electronic 8-speed automatic transmission • Active Grille Shutters • Remote keyless entry • Electronic Stability Control (ESC)^[5] system includes 4-wheel ABS, Brake Assist, Rain Brake Support, Ready Alert Braking, All-Speed Traction Control, Electronic Roll Mitigation, Hill Start Assist, and Trailer Sway Control^[5] • Multilink coil spring rear suspension • 26-gallon fuel tank (32-gallon fuel tank with 8-foot-box models) • Electronic part-time transfer case on 4x4 models

INTERIOR



Cloth 40/20/40 front bench seat • Cloth folding rear bench on Quad Cab and Crew Cab models • Carpet floor covering • Advanced multistage front air bags^[10] • Supplemental side-curtain air bags^[10] • Supplemental front-seat side-mounted air bags^[10] • Tilt steering wheel • Automatic headlamps • Air conditioning • Power windows and power door locks • 3.5-inch LCD EVIC located in instrument cluster • Uconnect 3.0 AM/FM radio with SiriusXM Satellite Radio^[6] • MP3 auxiliary jack and 2.5-amp USB jack • Overhead console • Power sliding rear window on Quad Cab and Crew Cab models

EXTERIOR

Chrome front and rear bumpers • Chrome grille surround with Black inserts • Body-color front upper fascia • Quad-lens headlamps • Chrome door handles • Bed rail caps • Locking tailgate • 4- and 7-pin trailer wiring harness/connectors • 17-inch painted aluminum wheels with BSW tires • Black, power, heated, fold-in sideview mirrors

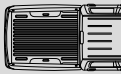

HFE

CABS	BEDS	SEATING
 Regular Cab	 6'4" Box	 40/20/40 Bench Seat

MECHANICAL

3.6L Pentastar® V6 with TorqueFlite™ 8 electronic 8-speed automatic transmission • Active Grille Shutters • Stop/Start Technology • 220-amp alternator • 800-amp battery • Remote keyless entry • Electronic Stability Control (ESC)^[5] system includes 4-wheel ABS, Brake Assist, Rain Brake Support, Ready Alert Braking, All-Speed Traction Control, Electronic Roll Mitigation, Hill Start Assist, and Trailer Sway Control^[5] • Multilink coil spring rear suspension • 26-gallon fuel tank

INTERIOR



Cloth 40/20/40 front bench seat • Carpet floor covering • Advanced multistage front air bags^[10] • Supplemental side-curtain air bags^[10] • Supplemental front-seat side-mounted air bags^[10] • Tilt steering wheel • Automatic headlamps • Air conditioning • Power windows and power door locks • 3.5-inch LCD Electronic Vehicle Information Center (EVIC) located in instrument cluster • Uconnect® 3.0 AM/FM radio with SiriusXM Satellite Radio^[6] • MP3 auxiliary jack and 2.5-amp USB jack • Overhead console

EXTERIOR

Chrome front and rear bumpers • Chrome grille surround with Black inserts • Body-color front upper fascia • Quad-lens headlamps • Chrome door handles • Bed rail caps • Locking tailgate • Tri-folding cargo bed tonneau cover • 4- and 7-pin trailer wiring harness/connectors • 17-inch painted aluminum wheels with BSW tires • Black, power, heated, fold-in sideview mirrors

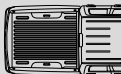
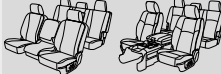

BIG HORN/LONE STAR

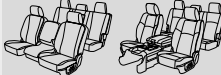
CABS	BEDS	SEATING
 Quad Cab®	 6'4" Box	 40/20/40 Bench Seat Bucket Seats, Available
 Crew Cab	 5'7" Box	 40/20/40 Bench Seat Bucket Seats, Available

MECHANICAL

5.7L HEMI® V8 with 6-speed automatic transmission and heavy-duty cooling system • Remote keyless entry • Electronic Stability Control (ESC)^[5] system includes 4-wheel ABS, Brake Assist, Rain Brake Support, Ready Alert Braking, All-Speed Traction Control, Electronic Roll Mitigation, Hill Start Assist, and Trailer Sway Control^[5] • Multilink coil spring rear suspension • 26-gallon fuel tank • Electronic on-demand transfer case on 4x4 models

INTERIOR





Premium cloth 40/20/40 front bench seat with power driver's side • Cloth 60/40 split-folding rear bench • Carpet floor covering • 115-volt power outlet • Advanced multistage front air bags^[10] • Supplemental side-curtain air bags^[10] • Supplemental front-seat side-mounted air bags^[10] • Leather-wrapped tilt steering wheel with audio controls • Automatic headlamps • Air conditioning • Power windows and power door locks • 3.5-inch LCD EVIC located in instrument cluster • Uconnect 5.0 AM/FM/BT radio with SiriusXM Satellite Radio^[6] • MP3 auxiliary jack and 2.5-amp USB jack • Overhead console • Power sliding rear window

EXTERIOR

Chrome front and rear bumpers • Fog lamps • Chrome grille surround with chrome billet inserts • Body-color front upper fascia • Quad-lens headlamps • Chrome door handles • Bed rail caps • Locking tailgate • 4- and 7-pin trailer wiring harness/connectors • Class IV trailer hitch receiver • 20-inch chrome-clad aluminum wheels with BSW tires • Black, power, heated, fold-in sideview mirrors • 4-inch chrome-tipped dual exhaust

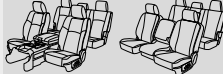

OUTDOORSMAN

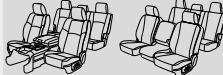
CABS	BEDS	SEATING
 Quad Cab	 6'4" Box	 Bucket Seats 40/20/40 Bench Seat, Available
 Crew Cab	 5'7" Box	 Bucket Seats 40/20/40 Bench Seat, Available

MECHANICAL

5.7L HEMI V8 with 6-speed automatic transmission and heavy-duty cooling system • Remote keyless entry • Electronic Stability Control (ESC)^[5] system includes 4-wheel ABS, Brake Assist, Rain Brake Support, Ready Alert Braking, All-Speed Traction Control, Electronic Roll Mitigation, Hill Start Assist, and Trailer Sway Control^[5] • Multilink coil spring rear suspension • 32-gallon fuel tank • Tow hooks • Limited-Slip Differential and skid plates for the transfer case and front suspension (on 4x4 models) • Remote Start and Security Group • Electronic part-time transfer case on 4x4 models

INTERIOR







Premium cloth front bucket seats • Power driver's seat • Full-floor center console with shifter • 115-volt power outlet • Cloth 60/40 split-folding rear bench • Carpet floor covering • Rubber all-weather floor mats • Luxury Group • Advanced multistage front air bags^[10] • Supplemental side-curtain air bags^[10] • Supplemental front-seat side-mounted air bags^[10] • Leather-wrapped tilt steering wheel with audio controls • Automatic headlamps • Air conditioning • Power windows and power door locks • 7-inch Thin Film Transistor (TFT) premium programmable Multi-View Display EVIC located in instrument cluster • Uconnect 8.4 AM/FM/BT/ACCESS radio with SiriusXM Satellite Radio^[6] • MP3 auxiliary jack, 2.5-amp USB jack, and SD card slot • Overhead console with Universal Garage Door Opener • Power sliding rear window

EXTERIOR

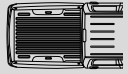
Two-tone paint with lower body, front bumper, rear bumper, and fender flares in Mineral Gray Metallic • Fog lamps • Body-color grille surround with Black inserts • Body-color front upper fascia • Quad-lens headlamps • Black door handles • Bed rail caps • Locking tailgate • 4- and 7-pin trailer wiring harness/connectors • Class IV trailer hitch receiver • 17-inch painted aluminum wheels with LT All-Terrain tires • Black, power-heated/power-folding sideview mirrors with puddle lamps and turn signal indicators

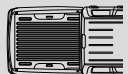

SPORT / R/T

CABS	BEDS	SEATING
 Regular Cab	 6'4" Box	 Bucket Seats
 Quad Cab [®]	 6'4" Box	 Bucket Seats
 Crew Cab	 5'7" Box	 Bucket Seats

MECHANICAL

5.7L HEMI[®] V8 with 6-speed automatic transmission and heavy-duty cooling system • 4.10 axle ratio (R/T model) • Remote keyless entry • Electronic Stability Control (ESC)^[5] system includes 4-wheel ABS, Brake Assist, Rain Brake Support, Ready Alert Braking, All-Speed Traction Control, Electronic Roll Mitigation, Hill Start Assist, and Trailer Sway Control^[5] • Multilink coil spring rear suspension • 26-gallon fuel tank • Electronic on-demand transfer case on 4x4 models

INTERIOR

Premium cloth front bucket seats • Power driver's seat • Full-floor center console with shifter • 115-volt power outlet • Cloth 60/40 split-folding rear bench on Quad Cab and Crew Cab models • Carpet floor covering • Luxury group • Advanced multistage front air bags^[10] • Supplemental side-curtain air bags^[10] • Supplemental front-seat side-mounted air bags^[10] • Leather-wrapped tilt steering wheel with audio controls • Automatic headlamps • Air conditioning • Power windows and power door locks • 7-inch Thin Film Transistor (TFT) premium programmable Multi-View Display Electronic Vehicle Information Center (EVIC) located in instrument cluster • Uconnect[®] 8.4A AM/FM/BT/ACCESS radio with SiriusXM Satellite Radio^[6] • MP3 auxiliary jack, 2.5-amp USB jack, and SD card slot • Overhead console with Universal Garage Door Opener • Power sliding rear window on Quad Cab and Crew Cab models

EXTERIOR





Monochromatic paint with body-color full front fascia and rear bumper • Fog lamps • Body-color grille surround with chrome billet inserts • Premium Sport projector headlamps with LED turn/running lights • Body-color door handles • Bed rail caps • Locking tailgate • Premium LED Sport taillamps • 4- and 7-pin trailer wiring harness/connectors • 20-inch polished face aluminum wheels with OWL tires • Body-color, power-heated/power-folding sideview mirrors with puddle lamps and turn signal indicators • 4-inch chrome-tipped dual exhaust

R/T MODEL SPECIFIC FEATURES (Regular Cab only)

• 22-inch polished forged aluminum wheels with BSW tires • Sport performance hood • Black hex grille inserts with R/T emblem

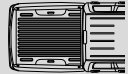

LARAMIE

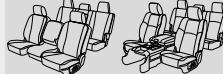
CABS	BEDS	SEATING
 Quad Cab	 6'4" Box	 40/20/40 Bench Seat Bucket Seats, Available
 Crew Cab	 5'7" Box	 40/20/40 Bench Seat Bucket Seats, Available

MECHANICAL

5.7L HEMI V8 with 6-speed automatic transmission and heavy-duty cooling system • Remote keyless entry • Security alarm system • Electronic Stability Control (ESC)^[5] system includes 4-wheel ABS, Brake Assist, Rain Brake Support, Ready Alert Braking, All-Speed Traction Control, Electronic Roll Mitigation, Hill Start Assist, and Trailer Sway Control^[5] • ParkView[®] Rear Back-Up Camera^[9] • Multilink coil spring rear suspension • 26-gallon fuel tank • Electronic on-demand transfer case on 4x4 models

INTERIOR



Leather-trimmed 40/20/40 front bench seat • Power driver's and front-passenger seats • Heated and ventilated front seats • 115-volt power outlet • Leather-trimmed 60/40 split-folding rear bench • Carpet floor covering • Advanced multistage front air bags^[10] • Supplemental side-curtain air bags^[10] • Supplemental front-seat side-mounted air bags^[10] • Heated leather-wrapped tilt steering wheel with audio controls • Automatic headlamps • Automatic Temperature Control (ATC) • Power windows and power door locks • 7-inch TFT premium programmable Multi-View Display EVIC located in instrument cluster • Uconnect 8.4A AM/FM/BT/ACCESS radio with SiriusXM Satellite Radio^[6] • MP3 auxiliary jack, 2.5-amp USB jack, and SD card slot • Premium 10-speaker Surround Sound audio system • Overhead console with Universal Garage Door Opener • Power adjustable pedals with memory • Power sliding rear window

EXTERIOR

Two-tone paint with lower body and fender flares in Bright Silver Metallic • Chrome front and rear bumpers • Fog lamps • Chrome grille surround with chrome wave perforated inserts • Premium projector headlamps with LED turn/running lights • Chrome door handles • Bed rail caps • Locking tailgate • Premium LED taillamps • 4- and 7-pin trailer wiring harness/connectors • 20-inch chrome-clad aluminum wheels with BSW tires • Chrome, power-heated/power-folding sideview mirrors with puddle lamps and turn signal indicators • 4-inch chrome-tipped dual exhaust

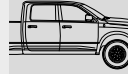
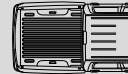

LARAMIE LONGHORN

CABS	BEDS	SEATING
 Crew Cab	 5'7" Box	 Bucket Seats

MECHANICAL

5.7L HEMI V8 with 6-speed automatic transmission and heavy-duty cooling system • Remote keyless entry • Security alarm system • Remote start • Electronic Stability Control (ESC)^[5] system includes 4-wheel ABS, Brake Assist, Rain Brake Support, Ready Alert Braking, All-Speed Traction Control, Electronic Roll Mitigation, Hill Start Assist, and Trailer Sway Control^[5] • ParkSense[®] Rear Park Assist^[9] • ParkView Rear Back-Up Camera^[9] • Multilink coil spring rear suspension • 32-gallon fuel tank • Electronic on-demand transfer case on 4x4 models

INTERIOR

Premium leather front bucket seats • Power driver's and front-passenger seats • Heated and ventilated front seats • Full-floor center console with leather cover and leather shifter • 115-volt power outlet • Premium leather heated 60/40 split-folding rear bench • Carpet floor covering • Premium floor mats with removable inserts • Advanced multistage front air bags^[10] • Supplemental side-curtain air bags^[10] • Supplemental front-seat side-mounted air bags^[10] • Heated leather-wrapped tilt steering wheel with wood accent and audio controls • Automatic headlamps • Automatic Temperature Control (ATC) • Power windows and power door locks • Ultra-premium instrument cluster with 7-inch TFT premium programmable Multi-View Display EVIC located in instrument cluster • Uconnect 8.4AN AM/FM/BT/ACCESS/NAV radio with SiriusXM Satellite Radio^[6] • MP3 auxiliary jack, 2.5-amp USB jack, and SD card slot • Premium 10-speaker Surround Sound audio system • Overhead console with Universal Garage Door Opener • Power adjustable pedals with memory • Power sliding rear window • LED additional interior lighting

EXTERIOR

Two-tone paint with lower body, fender flares, front bumper, rear bumper, and running boards in White Gold Metallic • Fog lamps • Chrome grille surround with chrome wave mesh inserts • Unique Laramie Longhorn badging • Premium projector headlamps with LED turn/running lights • Chrome door handles • Bed rail caps • Spray-in bedliner • Locking tailgate • Premium LED taillamps • 4- and 7-pin trailer wiring harness/connectors • 20-inch polished aluminum wheels with White Gold-clad inserts and BSW tires • Chrome, power-heated/power-folding sideview mirrors with puddle lamps and turn signal indicators • 4-inch chrome-tipped dual exhaust

RAM 1500 INTERIOR FABRICS



**Bristol Vinyl
Diesel Gray**
1500 Tradesman and Express

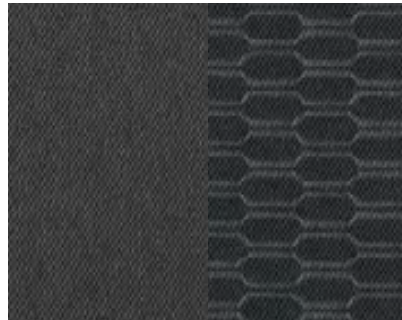

**Sedoso/Embossed Alloy II on Sedoso Cloth
Diesel Gray**
1500 Tradesman, Express, SLT, and HFE

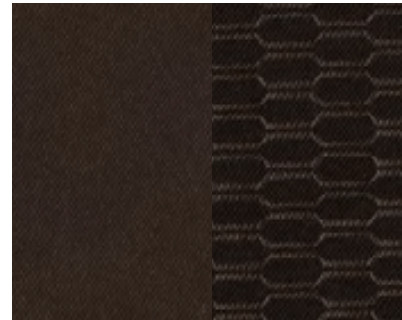

**Sedoso/Embossed Alloy II on Sedoso Cloth
Canyon Brown**
1500 SLT and HFE

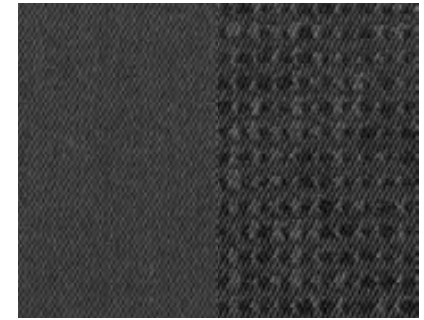

**Sedoso/Carbide Cloth
Diesel Gray**
1500 SLT, Big Horn/Lone Star, and Outdoorsman

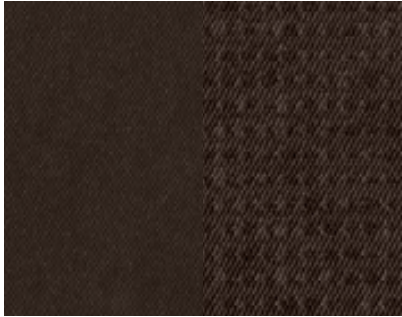

**Sedoso/Carbide Cloth
Canyon Brown**
1500 SLT, Big Horn/Lone Star, and Outdoorsman



**Bristol/Ram Sport Mesh Cloth
Black**
1500 Sport/RT



**Bristol/Bristol Axis II Perforated Leather Trim
Light Frost Beige**
1500 Laramie



**Bristol/Bristol Axis II Perforated Leather Trim
Black**
1500 Sport and Laramie

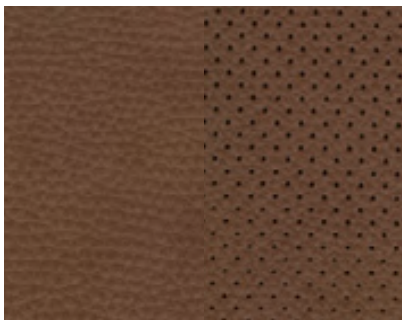

**Natura Plus without Laser Etching/
Natura Plus Axis II Perforated Leather
Cattle Tan**
1500 Laramie Longhorn

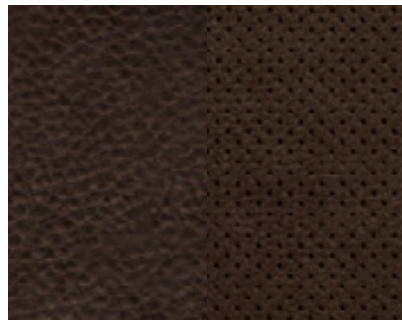

**Natura Plus without Laser Etching/
Natura Plus Axis II Perforated Leather
Canyon Brown**
1500 Laramie Longhorn



**Natura Plus with Laser Etching/
Natura Plus Axis II Perforated Leather
Canyon Brown**
1500 Laramie Longhorn



Information Provided by
DEALOG
E-PROCESS

RAM 1500 WHEELS

New exterior, new interior, new technology — all matched by a stunning selection of new wheels for new 2013 Ram 1500 models. Notable here are wheels that contribute to performance and help with fuel efficiency: the 17x7-inch lightweight steel wheel weighs 4.5 lb less than its predecessor, further reducing vehicle weight by 18 lb. The new 20-inch tire by Goodyear® assists with fuel efficiency with its low-resistance engineering. For more on Ram wheels, visit us anytime at ramtrucks.com



22-inch Polished Forged Aluminum Wheel
Standard on Regular Cab R/T (WPZ)



20-inch Aluminum Wheel with Polished Face and Silver-clad Inserts
Available on Laramie Longhorn with Monotone Paint (WRJ)



20-inch Aluminum Multi-insert Wheel with Polished Face and White Gold-clad Inserts
Standard on Two-Tone Laramie Longhorn (WRH)



20-inch Chrome-clad Aluminum Wheel
Standard on Laramie (WRG)



20-inch Polished Aluminum with Painted Pockets Wheel
Standard on Sport (WRF)



20-inch Chrome-clad Aluminum Wheel
Standard on Big Horn/Lone Star (WRK)



20-inch Chrome-clad Aluminum Wheel
Available on Express (WP2)



20-inch Painted Aluminum Wheel
Standard on Express • Available on Outdoorsman (WRE)



17-inch Chrome-clad Aluminum Wheel
Available on Big Horn/Lone Star and Laramie (WFJ)



Information Provided by:
17-inch Painted Aluminum Wheel
Standard on SLT, Outdoorsman, and HFE • Available on Tradesman (WFE)



17-inch Argent Steel Wheel
Standard on Tradesman (WFP)

RAM 1500 EXTERIOR COLORS



BLACK



BLACK GOLD PEARL



BRIGHT SILVER METALLIC



BRIGHT WHITE



COPPERHEAD PEARL



DEEP CHERRY RED CRYSTAL PEARL



FLAME RED



MAXIMUM STEEL METALLIC



MINERAL GRAY METALLIC



PRAIRIE PEARL



TRUE BLUE PEARL



WESTERN BROWN PEARL



Information Provided by:

DEALER
E-PROCESS

TRUE BLUE PEARL

2013 RAM 1500 BUYER'S GUIDE

	TRADESMAN REG/QUAD/CREW	EXPRESS REG/QUAD/CREW	SLT REG/QUAD/CREW	HFE REGULAR CAB	BIG HORN QUAD/CREW	OUTDOORSMAN QUAD/CREW	SPORT REG/QUAD/CREW	LARAMIE QUAD/CREW	LARAMIE LONGHORN CREW CAB
CPOS PACKAGE	B	C	G	P	Z/Y	T	L	H	K
POWERTRAIN/ENGINE/TRANSMISSION									
3.6L PENTASTAR® FLEX FUEL 24V VVT V6 (ERB) 8-SPEED AUTOMATIC 8HP45 (DFG)	22B		22G	22P					
4.7L FLEX FUEL V8 (EVE) 6-SPEED AUTOMATIC (DG1)	23B								
5.7L HEMI® V8 WITH VVT AND FUEL SAVER TECHNOLOGY (EZH) 6-SPEED AUTOMATIC (DG1)	25B	25C	25G		25 Z/Y	25T	25L	25H	25K
MECHANICAL FEATURES									
ACTIVE GRILLE SHUTTERS — (included with 8-speed automatic transmission)			P	•	P	P	P	P	P
ALTERNATOR — 160-amp	•								
— 180-amp (included with 3.6L V6 and 5.7L V8)	P	•	•		•	•	•	•	•
— 220-amp				•					
AXLE — 3.21 ratio (included with 3.6L V6)	P	0	•	•	•	0 (4x2)	0 (4x2)	0 (4x2)	
— 3.55 ratio	•	•	0		0	0	•	•	•
— 3.92 ratio (included with Outdoorsman 4x4)	0	0	0		0	0/P	0	0	0
— 4.10 ratio (included with Regular Cab R/T 4x2 with 6-speed auto)							P		
— Antispin rear differential (included with Outdoorsman 4x4 and 4.10 axle ratio; optional with 3.21, 3.55, or 3.92 axle ratio)	0	0	0	0	0	0/P	0/P	0	0
BATTERY — 730-amp	•	•	•		•	•	•	•	•
— 800-amp (with Stop/Start only)				•					
ENGINE BLOCK HEATER	0	0	0	0	0	0	0	0	0
ENGINE COOLING — Heavy-duty (included with 4.7L/ 5.7L V8 engines)	•	•	P		•	•	•	•	•
FUEL TANK — 26-gallon (not available with 8' box)	•	•	•	•	•	•	•	•	•
— 32-gallon (included with 8'-box model, not available on Regular Cab short-box models; optional on 6'4"- and 5'7"-box models)	0/P	0	0/P		0	0	0	0	•
SHOCK ABSORBERS — Front, heavy-duty	•	•	•	•	•	•	•	•	•
— Rear, heavy-duty	•	•	•	•	•	•	•	•	•
— Rear, extra heavy-duty (included with Outdoorsman 4x4 only)						P			
STEERING — Electronic rack and pinion	•	•	•	•	•	•	•	•	•
STOP/START SYSTEM — (HFE models only)				•					
STABILIZER BAR — Front	•	•	•	•	•	•	•	•	•
— Rear (included with 3.6L V6 on Regular Cab ST 4x2 6'4" box (included with Regular Cab R/T 4x2 6'4" box; included with 20-inch wheels on Regular Cab SLT 4x2 8' box; not available on Regular Cab ST, SLT, and HFE 4x2 models unless noted otherwise)	•	•	•/P		•	•	•/P	•	•
SUSPENSION — Front, upper and lower A-arms, coil springs, twin-tube shocks	•	•	•	•	•	•	•	•	•
— Rear, 5-Link, coil springs, twin-tube shocks	•	•	•	•	•	•	•	•	•
— Active-Level™ Four-Corner Air Suspension System (Quad Cab® and Crew Cab only)	0	0	0		0	0	0	0	0
TRAILER HITCH — Class IV hitch receiver	•	0	0	0	•	•	0	0	0
TRANSFER CASE — Electronic part-time (4x4 models only)	•	•	•			•			
— Electronic on-demand (4x4 models only; requires 5.7L HEMI V8)					P		•	•	•
WINCH — Tire carrier	•	•	•	•	•	•	•	•	•

• = Standard 0 = Optional P = Part of Package
NOTE: Some features and/or applications may be late availability.

	TRADESMAN REG/QUAD/CREW	EXPRESS REG/QUAD/CREW	SLT REG/QUAD/CREW	HFE REGULAR CAB	BIG HORN QUAD/CREW	OUTDOORSMAN QUAD/CREW	SPORT REG/QUAD/CREW	LARAMIE QUAD/CREW	LARAMIE LONGHORN CREW CAB
CPOS PACKAGE	B	C	G	P	Z/Y	T	L	H	K
EXTERIOR FEATURES									
AIR DAM — Flexible 0-mm (Outdoorsman only)						•			
— Flexible 18-mm (included with Active-Level Four-Corner Air Suspension System; not available on Outdoorsman)	P	P	P		P		P	P	P
— Flexible 38-mm (not available with Active-Level Four-Corner Air Suspension System; not available on Outdoorsman)	•	•	•	•	•		•	•	•
BED CHROME TUBULAR RAILS — For 5'7" and 6'4" bed sides (not available with RamBox® System or Mossy Oak® Package)	0	0	0	0	0	0	0	0	0
BEDLINER — Spray-in	•	0	0	0	0	0	0	0	•
BODYSIDE MOLDINGS — Chrome (included with monotone paint)	0		0	0	0	P		P	
BODY MODEL — Regular Cab 6'4" box	0	0	0	•			0		
— Regular Cab 8' box	0		0						
— Quad Cab 6'4" box	0	0	0		0	0	0	0	
— Crew Cab 5'7" box	0	0	0		0	0	0	0	0
DOOR HANDLES — Black	•	•				•			
— Body-color							•		
— Chrome with body-color bezel			•	•	•			•	•
EXHAUST — Single rear	•		•	•		•			
— Dual rear		•			•			•	•
— Dual rear aggressive sound								•	
FOG LAMPS — (optional on Tradesman with Exterior Appearance Group)	0	•	0	0	•	•	•	•	•
GRILLE — Black surround, Black hex-link	•								
— Chrome surround, Black hex-link (included with Exterior Appearance Group)	P		•	•					
— Body-color surround, Black hex-link (included with R/T models)		•				•	P		
— Body-color surround, chrome billet-perf								•	
— Chrome surround, chrome billet-perf					•				
— Chrome surround, chrome wave-perf								•	
— Chrome surround, chrome wave-mesh									•
HEADLAMPS — Automatic	•	•	•	•	•	•	•	•	•
— Quad-lens halogen	•	•	•	•	•	•			
— Premium bi-function halogen projector with LED turn/running lights								•	•
— Auto High Beam Headlamp Control (included in Convenience Group)							P	P	P
MIRRORS, EXTERIOR — Manual, Black, Regular Cab only 6 x 9-inch	•	•							
— Power, heated, folding, Black 6 x 9-inch (included with Power and Remote Entry Group on Regular Cab Tradesman models)	P/•	P/•	•	•	•				
— Folding trailer tow, manual, Black 7 x 11-inch	0	0							
— Power, heated, auto-dimming, power-folding, Black 6 x 9-inch; includes exterior courtesy lamps and supplemental turn signal (included with Luxury Group)			P		P	•			
— Power, heated, power-folding, auto-dimming, body-color 6 x 9-inch; includes exterior courtesy lamps and supplemental turn signal								•	
— Power trailer tow, manual folding, Black 7 x 11-inch; includes exterior courtesy lamps and supplemental turn signal	0	0	0	0	0	0	0	0	0



	TRADESMAN REG/QUAD/CREW	EXPRESS REG/QUAD/CREW	S/LT REG/QUAD/CREW	HFE REGULAR CAB	BIG HORN QUAD/CREW	OUTDOORSMAN QUAD/CREW	SPORT REG/QUAD/CREW	LARAMIE QUAD/CREW	LARAMIE LONGHORN CREW CAB
CPOS PACKAGE	B	C	G	P	Z/Y	T	L	H	K
EXTERIOR FEATURES (continued)									
— Power multifunction, heated, auto-dimming, power-folding, chrome 6 x 9-inch; includes position memory, exterior courtesy lamps, and supplemental turn signal								•	•
— Power trailer tow multifunction, heated, auto-dimming, manual folding, chrome 7 x 11-inch; includes position memory, exterior courtesy lamps, and supplemental turn signal								0	0
RUNNING BOARDS — Accent color									•
SKID PLATE — Front suspension, 4x4 only (included with Protection Group)	P		P		P	•		P	P
— Transfer case, 4x4 only (included in Protection Group)	P		P		P	•		P	P
STORAGE — RamBox® Cargo Management System: includes pickup box with integrated bins which are weatherproof, lockable, and drainable. Also includes rails with four adjustable cleats and a dual-purpose bed divider/bed extender (5'7"- and 6'4"-box models only; not available with 8' box)	0	0	0	0	0	0	0	0	0
TAILLAMPS — Incandescent	•	•	•	•	•	•			
— Sport (LED turn/stop/running lights)							•		
— Premium (LED turn/stop/running lights)								•	•
TIRES — P265/70R17 BSW All-Season	•		•	•					
— P265/70R17 OWL All-Season (included with 17-inch aluminum wheel)			0		P			P	
— LT265/70R17E OWL on-/off-road	0		0		•				
— P275/60R20 BSW All-Season (included with 20- x 8-inch aluminum wheels)		•	P		•			•	•
— P275/60R20 OWL All-Season (included with 20-inch chrome-clad wheel)		P			0	0	•	0	0
— P285/45R22 BSW All-Season (Regular Cab R/T 4x2 model only)							•		
— Spare, full-size	•	•	•	•	•	•	•	•	•
TONNEAU COVER — Soft, tri-fold (available with or without RamBox System)	0	0	0	•	0	0	0	0	0
TOW HOOKS — Included with Protection Group	P		P	0	P	•		0/P	•
WHEELS — Steel spare	•	•	•	•	•	•	•	•	•
— 17- x 7-inch styled steel, painted Argent	•								
— 17- x 7-inch painted cast aluminum (included with Exterior Appearance Group)	P		•	•		•			
— 17- x 7-inch chrome-clad aluminum			0		0			0	
— 20- x 8-inch painted aluminum		•				0			
— 20- x 8-inch chrome-clad aluminum (included with Big Horn/Lone Star Equipment Group)			P		•				
— 20- x 9-inch chrome-clad aluminum		0							
— 20- x 9-inch aluminum, polished face, painted pockets							•		
— 20- x 9-inch chrome-clad aluminum								•	
— 20- x 9-inch aluminum, multi-insert, polished, with White Clad accents									•
— 20- x 9-inch aluminum, multi-insert, polished with Silver-clad accents (included with monotone paint)									P
— 22- x 9-inch forged aluminum polished (Regular Cab R/T 4x2 model only)									

• = Standard 0 = Optional P = Part of Package
NOTE: Some features and/or applications may be late availability.



	TRADESMAN REG/QUAD/CREW	EXPRESS REG/QUAD/CREW	S/LT REG/QUAD/CREW	HFE REGULAR CAB	BIG HORN QUAD/CREW	OUTDOORSMAN QUAD/CREW	SPORT REG/QUAD/CREW	LARAMIE QUAD/CREW	LARAMIE LONGHORN CREW CAB
CPOS PACKAGE	B	C	G	P	Z/Y	T	L	H	K
INTERIOR FEATURES									
AIR CONDITIONING									
— Dual-Zone Temperature Control (included with Sport Premium Group)									P
CLUSTER — Instrument, with 3.5" display screen for Electronic Vehicle Information Center (EVIC)	•	•	•	•	•				
— Premium instrument, with 7-inch Thin Film Transistor (TFT) programmable Multi-View display screen for EVIC (included with Luxury Group)			P		P	•	•	•	
— Ultra premium instrument, with 7-inch TFT programmable Multi-View display screen for EVIC (Laramie Longhorn only)									•
CONSOLE — Full-size floor console (included with front bucket seats)			P		P	•	•	P	
— Premium full-size floor with leather-wrapped accents									•
— Overhead (included with Uconnect® 5.0 radio)	P	P	•	•	•				
— Overhead, with Universal Garage Door Opener (included with Luxury Group)			P		P	•	•	•	•
FLOOR MATS — Front and rear, rubber (Quad Cab® and Crew Cab)	0	0	0		0	•	0	0	
— Front, rubber (Regular Cab)	0	0	0	0			0		
— Front and rear, carpeted (Quad Cab and Crew Cab; included with ST Popular Equipment Group)	P	•	•		•			•	•
— Front, carpeted (Regular Cab; included with ST Popular Equipment Group)	P	•	•	•				•	
— Front and rear luxury									•
LOAD FLOOR — Rear fold-flat (Quad Cab and Crew Cab only; included with *M9, *MJ, and *DJ seats) (Late availability on Crew Cab)			P		•	•	•	•	P
MEMORY SYSTEM — Seats, mirrors, pedals, radio presets									•
PEDALS — Non-adjustable	•	•	•	•	•	•	•	•	
— Power adjustable									0
— Power adjustable with memory									•
SEATS — Manual adjusting driver and front passenger seats	•	•	•	•					
— Power 10-way driver (included with *M9 and *MJ seats)			P		•	•	•		
— Power 10-way driver and power 6-way passenger (included with *CJ seats)								P	
— Power 10-way driver with memory and power 6-way passenger									•
— Power 2-way lumbar adjuster (driver's seat only)			0		•	•	•	•	•
— Belt, front, shoulder, height-adjustable	•	•	•	•	•	•	•	•	•
— Heated, driver and front-passenger, includes heated steering wheel (included with Comfort Group and *CJ seats)					P	P	P	•	•
— Ventilated front							0	•	•
— Heated, second row, Crew Cab only (included with *GJ bucket seats)								P	•
— Vinyl 40/20/40 split-bench front seat with folding front armrest/cup holder, floor-mounted storage tray on Crew Cab (Quad Cab® and Crew Cab models include folding rear bench seat trimmed in vinyl)	•	•							
— Cloth 40/20/40 split-bench front seat, front armrest with cup holder (Quad Cab and Crew Cab models include cloth folding rear bench seat; included with Popular Equipment Group)	P	P	•	•					

	TRADES MAN REG/QUAD/CREW	EXPRESS REG/QUAD/CREW	ST REG/QUAD/CREW	HE REGULAR CAB	BIG HORN QUAD/CREW	OUTDOORS MAN QUAD/CREW	SPORT REG/QUAD/CREW	LARAMIE QUAD/CREW	LARAMIE LONGHORN CREW CAB
CPOS PACKAGE	B	C	G	P	Z/Y	T	L	H	K
INTERIOR FEATURES (continued)									
— Premium cloth-trimmed 40/20/40 split-bench front seat, front armrest with cup holder, power 10-way driver's seat, power lumbar adjuster, center seat cushion storage, 115-volt auxiliary power outlet, Quad Cab® and Crew Cab models include 60/40 split-folding rear bench seat with underseat storage and fold-flat load floor storage			0		•	0			
— Premium cloth-trimmed low-back bucket seats, power 10-way driver's seat, power lumbar adjuster, full-length floor console, 115-volt auxiliary power outlet (Quad Cab and Crew Cab models include 60/40 split-folding rear bench seat trimmed in cloth with underseat storage and fold-flat load floor storage)			0		0	•			
— Cloth/vinyl-trimmed high-back bucket seats, power 10-way driver's seat, power lumbar adjuster, full-length floor console, 115-volt auxiliary power outlet (Quad Cab and Crew Cab models include 60/40 split-folding rear bench seat trimmed in cloth/vinyl with underseat storage and fold-flat load floor storage)							•		
— Leather-trimmed high-back, ventilated and heated bucket seats, includes power 10-way driver and power 6-way passenger, power lumbar adjuster, full-length floor console, 115-volt auxiliary power outlet (Quad Cab and Crew Cab models include 60/40 split-folding rear bench seat trimmed in vinyl with underseat storage and fold-flat load floor storage)							0		
— Leather-trimmed 40/20/40 split-bench heated and ventilated front with power 10-way/memory for driver and power 6-way passenger, power lumbar adjuster, front center-seat cushion storage and folding center armrest with cup holder, 115-volt auxiliary power outlet (Quad Cab and Crew Cab models include 60/40 split-folding rear bench seat trimmed in vinyl with underseat storage and fold-flat load floor storage)								•	
— Leather-trimmed high-back, ventilated and heated bucket seats, includes power 10-way driver and power 6-way passenger, power lumbar adjuster, full-length floor console, 115-volt auxiliary power outlet and heated 2nd-row on Crew Cab models (Quad Cab and Crew Cab models include 60/40 split-folding rear bench seat trimmed in vinyl with underseat storage and fold-flat load floor storage)								0	
— Premium leather with laser-etched design, high-back ventilated and heated bucket seats, includes power 10-way driver and power 6-way passenger, power lumbar adjuster, premium full-length floor console, 115-volt auxiliary power outlet, heated 2nd-row seats. Includes 60/40 split-folding premium leather with laser-etched design rear bench seat with underseat storage (available only with Canyon Brown color)									•
— Premium leather high-back, ventilated, and heated bucket seats, includes power 10-way driver and power 6-way passenger, power lumbar adjuster, premium full-length floor console, 115-volt auxiliary power outlet, heated 2nd-row seats. Includes 60/40 split-folding premium leather rear bench seat with underseat storage and fold-flat load floor storage (available in Canyon Brown or Cattle Tan color)									0
STEERING WHEEL — Urethane	•	•	•	•					
— Leather-wrapped with audio control buttons (included with Luxury Group)			P		•	•	•	•	
— Leather-wrapped with genuine wood, heated, audio control buttons									•
— Heated (included with Comfort Group)					P	P	P	•	•

	TRADES MAN REG/QUAD/CREW	EXPRESS REG/QUAD/CREW	ST REG/QUAD/CREW	HE REGULAR CAB	BIG HORN QUAD/CREW	OUTDOORS MAN QUAD/CREW	SPORT REG/QUAD/CREW	LARAMIE QUAD/CREW	LARAMIE LONGHORN CREW CAB
CPOS PACKAGE	B	C	G	P	Z/Y	T	L	H	K
STORAGE — Front-seat center cushion (included with *M9 and *VL seats)			P	P	•	0		•	
— Front, behind seat (Regular Cab only)	•	•	•	•		•	•		
— Rear, in-floor bins, two with removable liners (Crew Cab only)	•	•	•		•	•	•	•	•
— Rear, underseat compartment (Quad Cab and Crew Cab models only)	•	•	•		•	•	•	•	•
— Dual glove boxes with closing doors			•	•	•	•	•	•	•
SUNROOF — Power (Quad Cab and Crew Cab models only)			0		0	0	0	0	0
WINDOWS — Manual (Regular Cab only)	•	•							
— Power, front with driver's one-touch down (Regular Cab only; included with Power Remote Entry Group)	P	P	•	•		•	•		
— Power, front and rear with driver's one-touch down and up (Quad Cab and Crew Cab models only)	•	•	•		•	•	•	•	•
— Rear backlight, fixed (standard on Regular Cab and ST models)	•	•	•	•			•		
— Rear backlight, sliding (Regular Cab only)	0	0	0				0		
— Rear backlight, power sliding (Quad Cab and Crew Cab models only)			•		•	•	•	•	•
— Rear defroster (with fixed glass or power sliding rear backlight only)			0		0	0	0	0	0
UCONNECT® MULTIMEDIA									
CONNECTIVITY — Auxiliary input jack for mobile devices	•	•	•	•	•	•	•	•	•
— USB 1.5-amp fully functioning port	•	•	•	•	•	•	•	•	•
— USB 2.5-amp charging-only port (included with *V9, *M9, *MJ seats and Uconnect 5.0 radio)	P	P	P	P	P	P	•	•	•
— SD card (included with Uconnect 8.4A and 8.4AN radios)			P	P	P	•	•	•	•
RADIO — Uconnect 3.0 AM/FM	•	•	•	•					
— Uconnect 5.0 AM/FM/ Bluetooth®	0	0	0	0	•				
— Uconnect 8.4A AM/FM/BT/ACCESS			0	0	0	•	•	•	
— Uconnect 8.4AN AM/FM/BT/ACCESS/NAV					0	0	0	0	•
RADIO CONTROLS — Steering wheel-mounted audio controls (included with leather-wrapped steering wheel)			P		•	•	•	•	•
SINGLE-DISC CD PLAYER	0	0	0	0	0	0	0	0	0
SIRIUSXM SATELLITE RADIO ⁽⁶⁾ — Included with Popular Equipment Group	P	P	•	•	•	•	•	•	•
SIRIUSXM TRAFFIC ⁽⁶⁾ — Included with Uconnect 8.4AN radio					P	P	P	P	•
SIRIUSXM TRAVEL LINK ⁽⁶⁾ — Included with Uconnect 8.4AN radio					P	P	P	P	•
SPEAKER SYSTEM — Six, standard	•	•	•	•	•	•	•	•	•
— Premium I; seven speakers and eight-channel amplifier (Regular Cab only)			0				•		
— Premium II; 10 speakers including a subwoofer and 12-channel amplifier (included with Sport Premium Group; Quad Cab and Crew Cab models only)			0		0	0	P	•	•
UCONNECT ACCESS — Requires Uconnect 8.4A or 8.4AN radios			0	0	0	0	0	0	0
UCONNECT ACCESS VIA MOBILE SMARTPHONE — Requires Uconnect 8.4A or 8.4AN radios			0	0	0	0	0	0	0
UCONNECT BLUETOOTH CONNECTIVITY — Includes hands-free phone, streaming audio, Voice Command ⁽⁷⁾ and text message reader (requires Uconnect 5.0, 8.4A, or 8.4AN radios)	P	P	P	P	•	•	•	•	•

• = Standard 0 = Optional P = Part of Package

NOTE: Some features and/or applications may be late availability.

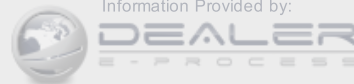

	TRADESMAN REG/QUAD/CREW	EXPRESS REG/QUAD/CREW	S/T REG/QUAD/CREW	HFE REGULAR CAB	BIG HORN QUAD/CREW	OUTDOORSMAN QUAD/CREW	SPORT REG/QUAD/CREW	LARAMIE QUAD/CREW	LARAMIE LONGHORN CREW CAB
CPOS PACKAGE	B	C	G	P	Z/Y	T	L	H	K
SAFETY AND SECURITY									
AIR BAGS ¹⁰⁾ — Advanced multistage front	•	•	•	•	•	•	•	•	•
— Supplemental side-curtain	•	•	•	•	•	•	•	•	•
— Supplemental front-seat side-mounted	•	•	•	•	•	•	•	•	•
BRAKES — Power-assisted 4-wheel antilock disc	•	•	•	•	•	•	•	•	•
ELECTRONIC STABILITY CONTROL (ESC) ⁵⁾ — Includes 4-wheel ABS, Brake Assist, All-Speed Traction Control, Rainy Day Braking, Ready Alert Braking, Electronic Roll Mitigation, Hill Start Assist, and Trailer Sway Control ⁵⁾	•	•	•	•	•	•	•	•	•
PARKSENSE [®] REAR PARK ASSIST ¹⁹⁾ — Not available on Regular Cab			0		0	0	0	0	•
PARKVIEW [®] REAR BACK-UP CAMERA ¹⁹⁾ — With dynamic grid lines (grid lines not available with Uconnect [®] 3.0 Radio)	0	0	0	0	0	0	0	•	•
REMOTE KEYLESS ENTRY — Controls for power door locks, tailgate, and RamBox [®] System (when equipped), illuminated entry system, panic alarm, includes two transmitters (included with ST Popular Equipment Group, Power and Remote Entry Group)	P	P	•	•	•	•	•	•	•
REMOTE START SYSTEM — Included with Remote Start and Security Group			P		P	•	P	0	•
SECURITY ALARM — Included with Remote Start and Security Group			P		P	•	P	•	•
TRAILER BRAKE CONTROL — Fully integrated electronic (included with Trailer Brake Control Group)	P	P	0	0	0	0	0	0	0
PACKAGE GROUPS									
EXTERIOR APPEARANCE GROUP — Includes chrome front and rear bumpers, chrome grille surround, fog lamps, and 17-inch painted aluminum wheels	0								
BIG HORN EQUIPMENT GROUP — Includes 3.6L V6 engine on Regular/Quad/Crew Cabs and 5.7L HEMI [®] V8 engine on Regular Cab only; equipment same as 2TZ CPOS			0						
COMFORT GROUP — Includes heated cloth seats and heated steering wheel					0	0	0		
CONVENIENCE GROUP — Includes Passive Entry/Keyless Enter 'n Go, Rain-Sensitive Wipers, SmartBeam [™] Headlamps							0	0	0
LONE STAR EQUIPMENT GROUP — Includes 3.6L V6 engine on Regular/Quad/Crew Cabs and 5.7L HEMI V8 engine on Regular Cab only; equipment same as 2TY CPOS			0						
LUXURY GROUP — Includes switchable dome lamp, ashtray lamp, glove box lamp, underhood lamp, illuminated vanity mirror, auto day/night mirror, exterior mirrors with signal and puddle lamps, overhead console with Universal Garage Door Opener, leather-wrapped steering wheel, new larger 7-inch Thin Film Transistor (TFT) programmable Electronic Vehicle Information Center (EVIC) screen.			0		0	•	•		
MOSSY OAK [®] PACKAGE — Crew Cab 4x4 only — includes decal on rear box side; camouflage pattern on exterior bed rail caps, tailgate caps, interior I/P center stack and door panel inserts; embroidered logo on four primary headrests						0			

	TRADESMAN REG/QUAD/CREW	EXPRESS REG/QUAD/CREW	S/T REG/QUAD/CREW	HFE REGULAR CAB	BIG HORN QUAD/CREW	OUTDOORSMAN QUAD/CREW	SPORT REG/QUAD/CREW	LARAMIE QUAD/CREW	LARAMIE LONGHORN CREW CAB
CPOS PACKAGE	B	C	G	P	Z/Y	T	L	H	K
POPULAR EQUIPMENT GROUP — Includes cloth 40/20/40 bench seat, carpeted flooring, remote keyless entry, floor mats, and SiriusXM Satellite Radio ⁶⁾									
POWER AND REMOTE ENTRY GROUP — Includes remote keyless entry, foldaway, Black, power heated mirrors, power windows with front one-touch down, and power locks (Regular Cab only)	0	0							
PROTECTION GROUP — 4x4 models only — includes tow hooks, front suspension, and transfer case skid plates	0		0		0	•		0	0
REMOTE START AND SECURITY GROUP — Includes security alarm and remote start system			0		0	•	0		
R/T PACKAGE — Includes unique torque converter with 4.10 axle ratio and antispin differential, P285/45R22 BSW All-Season tires, 22- x 9-inch forged aluminum polished wheels, and Sport performance hood (Regular Cab 6'4" box 4x2 models only)							•		
SMOKER'S GROUP — Includes ashtray and cigar lighter	0	0	0	0	0	0	0	0	0
SPORT PREMIUM GROUP — Includes Dual-Zone Automatic Temperature Control, Surround Sound speaker system (Quad Cab [®] and Crew Cab only)							0		
TRAILER BRAKE CONTROL GROUP — Includes trailer brake control	0	0							

• = Standard 0 = Optional P = Part of Package
NOTE: Some features and/or applications may be late availability.





^[1]Based on the latest available competitive information and *Automotive News* classification. Excludes hybrid pickups. ^[2]Transferable. See dealer for complete details and a copy of the 5-Year/100,000-Mile Powertrain Limited Warranty. ^[3]Fuel economy based on EPA estimated 18 city/25 highway mpg for Ram 1500 HFE V6 4x2 or EPA estimated 17 city/25 highway mpg for Ram 1500 V6 4x2. ^[4]Fuel economy based on EPA estimated 14 city/20 highway mpg for Ram 1500 V8 4x2. ^[5]No system, no matter how sophisticated, can repeal the laws of physics or overcome careless driving actions. Performance is limited by available traction, which snow, ice, and other conditions can affect. When the ESC warning lamp in the speedometer flashes, the driver needs to use less throttle and adapt speed and driving behavior to prevailing road conditions. Always drive carefully, consistent with conditions. Always wear your seat belt. ^[6]Sirius services require subscriptions, sold separately after the 12-month trial included with new vehicle purchase. **If you decide to continue your Sirius services at the end of your trial subscription, the plan you choose will automatically renew and bill at then-current rates until you call SiriusXM at 1-866-635-2349 to cancel. See our Customer Service Agreement for complete terms at siriusxm.com.** All fees and programming subject to change. Sirius satellite service is available only to those at least 18 and older in the 48 contiguous U.S., D.C., and P.R. (with coverage limitations). Our Internet radio service is available throughout our satellite service area and in AK and HI. Traffic information not available in all markets. See siriusxm.com/traffic for details. © 2012 Sirius XM Radio Inc. Sirius, XM and all related marks and logos are trademarks of SiriusXM Radio Inc. ^[7]Requires Uconnect Phone. ^[8]Sold separately. Subscription required. Uconnect WiFi feature is not intended for use by the driver while the vehicle is in motion. Always drive carefully. ^[9]Always check entire surroundings before backing up. ^[10]The Advanced Front Air Bags in this vehicle are certified to the new U.S. federal regulations for advanced air bags. Children 12 years old and younger should always ride buckled up in a rear seat. Infants in rear-facing child restraints should never ride in the front seat of a vehicle with a passenger front air bag. All occupants should always wear their lap and shoulder belts properly.

About this catalog: Since the time of printing, some of the information you'll find in this catalog may have been updated. Ask your dealer for details. Some of the equipment shown or described throughout this catalog may be available at extra cost. Specifications, descriptions, illustrative materials, and all competitive comparisons contained herein are as accurate as known at the time this catalog was approved for publication. Chrysler Group LLC reserves the right to discontinue models at any time or change specifications without notice or without incurring obligation. All options are required in combination with other options. For the price of the model with the equipment you desire, or verification of specifications contained here, see your Ram dealer. iPod is a registered trademark of Apple Inc. Bluetooth is a registered trademark of Bluetooth SIG, Inc. Sirius, XM and all related marks and logos are trademarks of SiriusXM Radio Inc. Goodyear is a registered trademark of The Goodyear Tire & Rubber Company. All rights reserved. Facebook and logo are trademarks of Facebook, Inc. The Twitter logo is a service mark of Twitter, Inc. The YouTube logo is a trademark of Google Inc. Mossy Oak is a registered trademark of Haas Outdoors, Inc. NFL is a registered trademark of the National Football League. NHL is a registered trademark of the National Hockey League. MLB is a registered trademark of Major League Baseball. NASCAR is a registered trademark of the National Association for Stock Car Auto Racing, Inc. The FOX HEAD LOGO and Shift logo are trademarks of FOX HEAD, INC. Dunlop is a registered trademark of Dunlop Tires. Loctite is a registered trademark of Henkel Loctite Corporation. U.S.A. D.I.D. is a U.S.A. registered trademark of D.I.D.; Daido Kogyo Co. Ltd. Towmaster is a registered trademark of Towmaster, Inc. SmartBeam is a trademark of Gentex Corporation. Chrysler, Dodge, Ram, the Ram's Head logo, Big Horn, HEMI, Laramie, Laramie Longhorn, Mopar, Outdoorsman, ParkSense, ParkView, Pentastar, Quad Cab, R/T, RamBox, Ram 1500 Express, Tradesman, and Uconnect are registered trademarks and Active-Level, All-Secure, HFE High Fuel Efficiency & Design, and TorqueFlite are trademarks of Chrysler Group LLC. © 2012 Chrysler Group LLC. All rights reserved.



Join fellow RAM enthusiasts and tell your story by posting comments, participating in discussions, and sharing your photos and videos. Join our community on Facebook, follow us on Twitter, and check us out on YouTube.

74-383-2314_9/12_Litho in U.S.A.

THE RAM OUTFITTER

Owning a new 2013 Ram 1500 opens up a world of new apparel, tools, and a variety of equipment for work and play. The one place to find it all is the Ram Outfitter site.

This is the online shopping center for gear and gifts for the Ram enthusiast. With the Ram identity prominently featured, you can choose from authentic wear, sports equipment, electronics, and attire. Log on. It's all at ramtrucks.com/outfitter

