

YOUR 306 AT A GLANCE

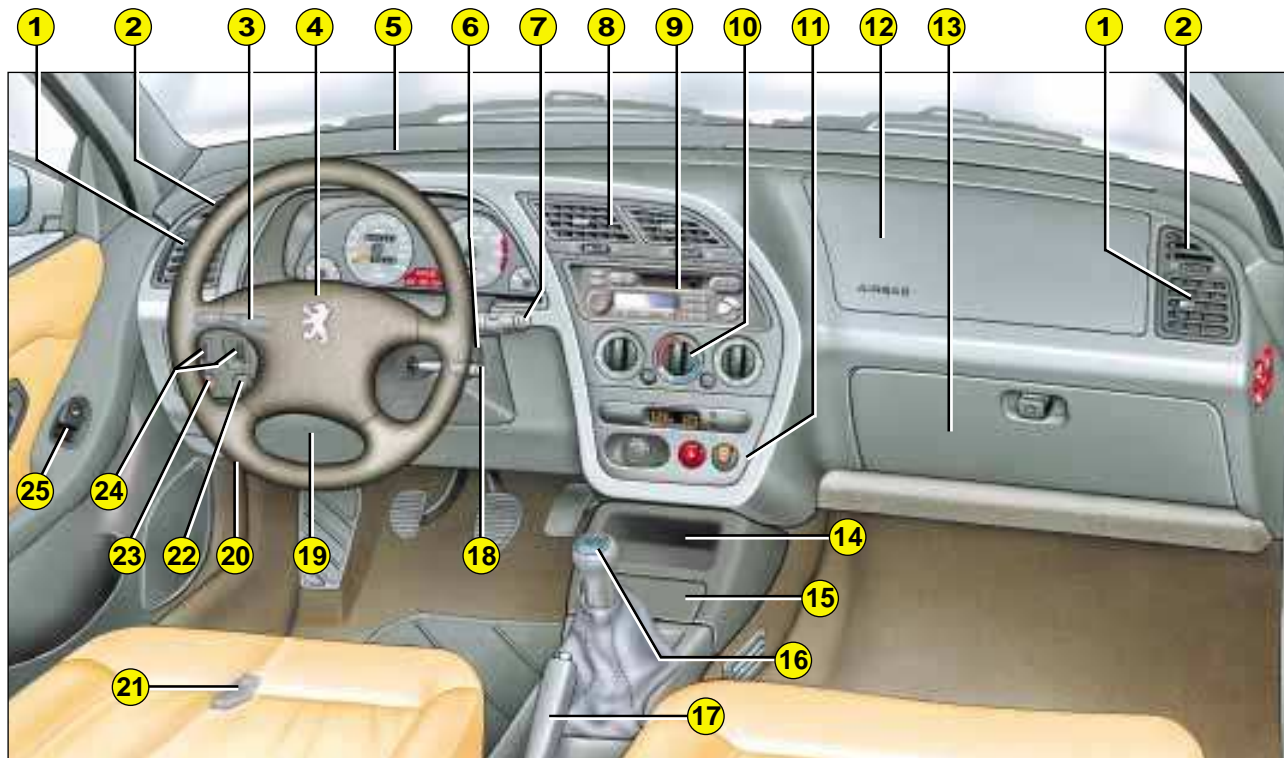

YOUR 306 AT A GLANCE

- | | | |
|---|---|---|
| 1 - Adjustable side vent. | 10 - Heating/Ventilation,
Air conditioning controls*. | 18 - Audio remote control*. |
| 2 - Side window demisting vents. | 11 - Controls:
Lighter
Hazard warning lights
Rear screen and mirrors
demisting. | 19 - Fuse box. |
| 3 - Lighting control, fog lamps*
and horn. | 12 - Passenger airbag*. | 20 - Bonnet opening control. |
| 4 - Steering wheel with airbag*. | 13 - Glove box | 21 - Fuel filler flap control*. |
| 5 - Windscreen demisting vents. | 14 - Storage compartment. | 22 - Passenger airbag
disarming switch*. |
| 6 - Steering lock and ignition. | 15 - Ashtray. | 23 - Control for locking the rear
windows. |
| 7 - Windscreen wash-wipe
control. | 16 - Gear lever. | 24 - Headlamp height adjust-
ment
- Instrument dials lighting
rheostat |
| 8 - Adjustable central vents. | 17 - Handbrake. | 25 - Controls for:
Electric mirrors*
Electric windows* |
| 9 - Audio equipment*. | | |

* According to specification.

YOUR 306 AT A GLANCE

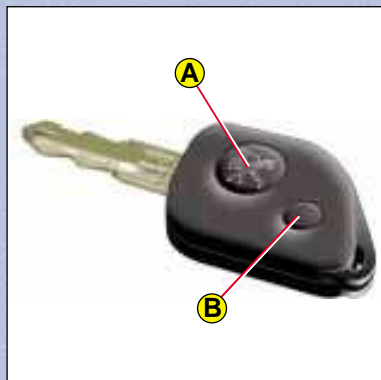

KEYS

Using the key in the driver's door lock will lock or unlock the doors and boot or tailgate.

THE REMOTE CONTROL

A single press on button **A** locks the doors and boot or tailgate.

A single press on button **B** unlocks the vehicle.



FRONT AIRBAGS

Disarming the passenger airbag
Insert the ignition key in switch 1 and turn it:

- to the “**ON**” position, the passenger airbag is armed
- to the “**OFF**” position, the passenger airbag is not armed.



Operational Check

This is by means of the warning light on the instrument panel.

If the passenger airbag is armed or if your vehicle is not fitted with a passenger airbag, the warning light comes on for 6 seconds when the ignition is switched on.

If the passenger airbag is not armed, one of the warning lights remains on.

Always contact your PEUGEOT dealer if the warning light flashes.

Passenger airbag precautions

For a vehicle fitted with a disarming switch:



- disarm the airbag if you install a rear-wards-facing child seat.
- arm the airbag when an adult is in the seat.

For a vehicle not fitted with a disarming switch:

- do not install rear-wards-facing child seats on the front passenger seat.



Never place your feet or any object on the fascia.

** According to model.

YOUR 306 AT A GLANCE

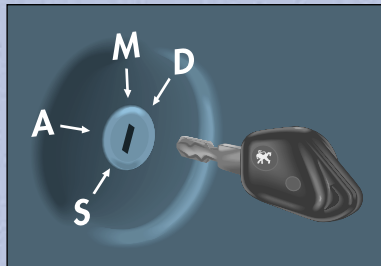

STARTING

The 4 positions of the key in the ignition:

“S” for STOP The ignition is off.

“A” for Accessories The ignition is off but the accessories can be used.

“M” for Running The ignition is on.

“D” for Starting Operates the starter.

Steering lock

Before starting, unlock the steering if necessary, by gently turning the steering wheel at the same time as you turn the key.

It is advisable to press the clutch pedal while operating the starter to make starting easier.

Starting a petrol engine

Do not press the accelerator.

Operate the starter, without releasing the key, until the engine turns.

Starting a diesel engine



Do not press the accelerator.

Turn the key to position **“M”**.

If the engine is warm enough, the pre-heat light does not come on and you can start immediately.

If the pre-heat light comes on, wait for it to go out before operating the starter.

HDI engine special feature

If the engine stalls, it is necessary to return the key to position **“S”** before restarting.



Never race a cold engine.

Never run the engine in a confined space.

Do not make any modifications to the steering lock.

YOUR 306 AT A GLANCE



ELECTRONIC ENGINE IMMOBILISER

This locks the engine control system a few moments after the ignition has been switched off and therefore prevents starting of the vehicle by anyone who has not got the key.

Operation

Each key has an electronic chip which has a special code.

When the ignition is switched on the key code is recognised and starting is possible.

If the key does not have a code or has a different code from that stored in the system memory, the vehicle will not start.

Additional key

You can store up to 5 keys in the memory.

If you require an additional key or wish to change a faulty key, you must visit a PEUGEOT dealer with the confidential card and all the keys in your possession.



Confidential card

This contains the identification combination which is required if any work is carried out on the system by a PEUGEOT dealer. This combination is concealed by a strip which must not be removed unless required.

Keep your card in a safe place, never in your vehicle.



When buying a second hand car:

Ensure that you are given the confidential card.

It is advisable to have the key codes memorised by a PEUGEOT dealer to ensure that the keys in your possession are the only ones which can start the vehicle.

Do not make any modifications to the PEUGEOT electronic engine immobiliser system.

YOUR 306 AT A GLANCE

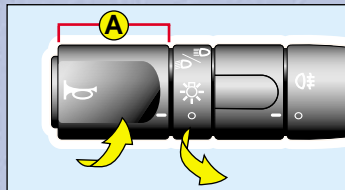

STEERING WHEEL STALKS LIGHTING

Front lights (ring A)



Lights off.



Side lights on.



Dipped/main beam head-lamps on.

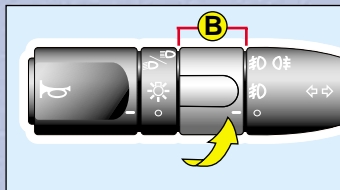
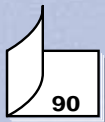

Front/rear fog lamps (ring B)



Fog lamp off.



Front fog lamps on.

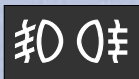

Front and rear fog lamps on.

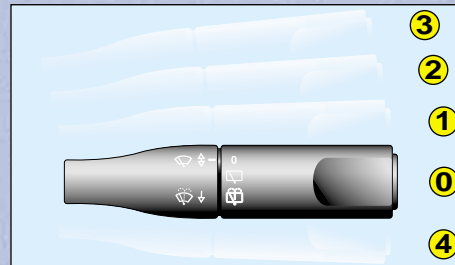

Front windshield wipers

- 3 Rapid wipe
 - 2 Normal wipe
 - 1 Intermittent or automatic wipe
 - 0 Stop
 - 4 Single wipe
- Wash-wipe: pull the stalk towards you.

Rear



Stop



Intermittent wipe



Wash-wipe

Automatic wipe

The system automatically adjusts the wiper timing to the intensity of the rainfall. After switching off the ignition or starting in position 1, it is necessary to re-set this function. This is possible in two ways:

- change from 1 to 0 then return to 1 (displayed by one wipe),
- change from 1 to 2 then return to 1 (displayed by two wipes).

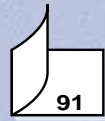

YOUR 306 AT A GLANCE



ADJUSTING THE FRONT SEATS (3-door)

- 1 Forwards-backwards adjustment.
- 2 Seat back angle adjustment.
- 3 Drivers seat height adjustment: pull the telescopic handle and pivot it.
- 4 Lumbar adjustment.
- 5 Access to rear seats.

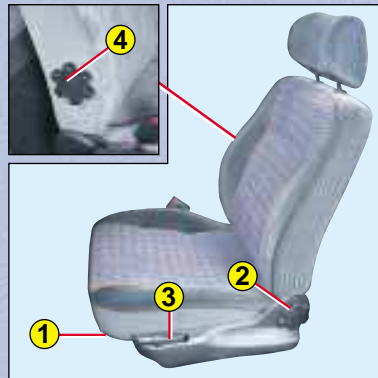
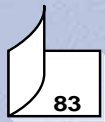

ADJUSTING THE FRONT SEATS (4/5-door and estate)

- 1 Forwards-backwards adjustment.
- 2 Seat back angle adjustment.
- 3 Drivers seat height adjustment: pull the telescopic handle and pivot it.
- 4 Lumbar adjustment.

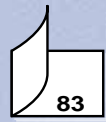

HEAD RESTRAINTS

- Height adjustment: slide them.
- Adjusting the angle: tilt them.

To remove the head restraint, position it at maximum height and press the tab.

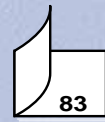

YOUR 306 AT A GLANCE



FOLDING REAR SEAT BACK

To fold the seat back:

- from inside the boot, release control **1**
- position the seat belt under the strap guide **B**
- unlock the seat back by pressing button **A**
- tilt the seat back
- tilt the backrest.

When repositioning the seat back, ensure that the seat belts are positioned correctly and the seat back is secured correctly

86

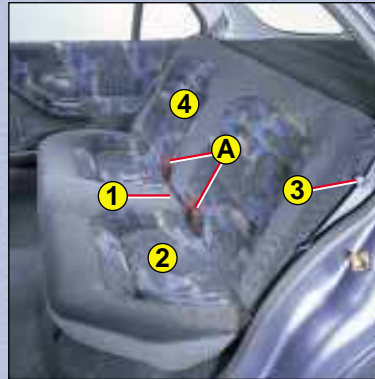

FOLDING REAR SEATS (all models)

To fold the rear seats:

- insert the seat belt stalks in the hooks **A**.
- pull the strap **1**.
- tilt the seat cushion **2** against the front seats.
- position the seat belt under the lever **3** (5-door and estate) or on the top of the seat back (3-door).
- unlock the seat back using the controls on the side **3** (5-door and estate) or on the seat back **4** (3-door).
- tilt the seat back **4**.

To tilt the rear seats, always start with the seat cushion, never with the backrest (risk of damage).

When repositioning, take care to avoid trapping the seat belts under the seat cushion or behind the seat back.

85



YOUR 306 AT A GLANCE



ELECTRIC WINDOWS

1. Driver's electric window

Manual mode: press or pull the switch lightly. The window stops as soon as the switch is released.

Automatic mode: press or pull the switch firmly. One touch completely opens or closes the window.

Automatic opening and closing only work when the engine is running.

2. Passenger's electric window.

3. Left rear electric window

4. Right rear electric window.



ADJUSTING THE HEIGHT OF THE STEERING WHEEL

Push the handle to unlock the steering wheel.

Adjust the steering wheel to the desired height and pull the handle to lock it into position.

ELECTRIC MIRRORS

Turn the knob **A** to the right or to the left to select the corresponding mirror.

Move the knob in all four directions to adjust the mirror.

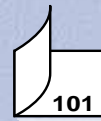

YOUR 306 AT A GLANCE



OPENING THE BONNET

Inside the vehicle: Pull the handle.



FUEL FILLER FLAP

To open*: firmly pull the handle on the floor to the outside of the drivers seat.

To close: from outside, push the flap back and check that it is secured correctly.

The fuel filler cap is opened and closed with the ignition key independently of opening the doors (during model year).

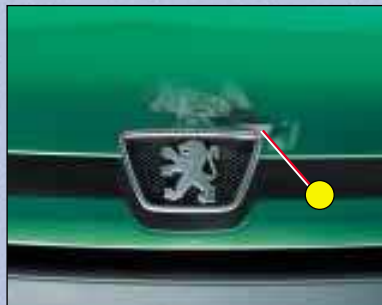

Outside the vehicle

Raise the catch 1 and support the bonnet as it rises.

81



Fuel low warning light

The fuel low warning light indicates that the quantity of fuel remaining in the tank is approximately 1.3 gallons (6 litres).

Filling with fuel

Switch off the engine.

There is a holder for the fuel filler cap.

A label on the inside of the flap shows which fuels are permitted and which are not allowed.

The capacity of the tank is approximately 13 gallons (60 litres).

* According to specification.

82

YOUR 306 AT A GLANCE

THE AUTOMATIC AUTOADAPTIVE GEARBOX

Starting

To start the engine, place the selector lever in position **N** or **P**. Press the brake pedal when starting the engine or when selecting a forwards or reverse gear.



Position of selector lever

This is shown by an indicator on the instrument panel.

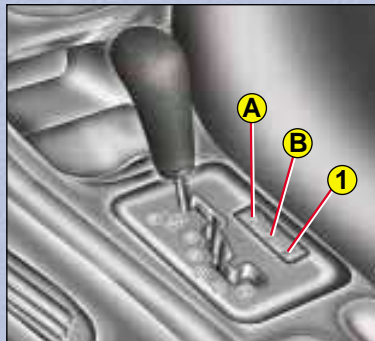

- P.** Park.
- R.** Reverse.
- N.** Neutral.
- D.** Drive: in this position, all four gears change automatically.
- 3.** Automatic changing of the first three gears only.
- 2.** Automatic changing of the first two gears only.
- 1.** Selection of first gear only.
Selection of first gear is from position **2** by pressing switch **1**.
- A.** Sport programme.
- B.** Snow programme.

YOUR 306 AT A GLANCE

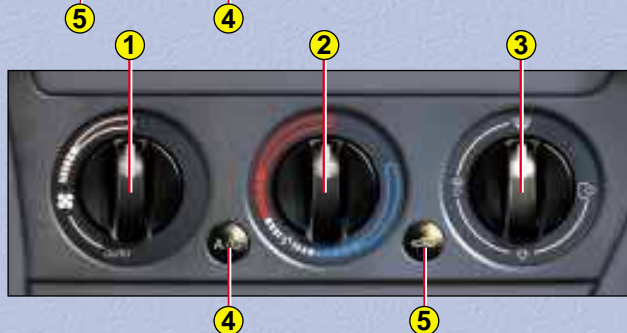

VENTILATION/HEATING/AIR CONDITIONING

1 - Air flow adjustment.

2 - Temperature adjustment.

3 - Air distribution.



Windscreen and side windows.



Windscreen, side windows and footwells.



Footwells.



Central and side vents.

4 - Air conditioning on/off.

5 - Recirculation of interior air.

MAINTENANCE OF YOUR 306

PEUGEOT SERVICING

Your vehicle benefits from extended service intervals.

- For petrol engines: every 20,000 miles (30,000 km) or every two years
- For direct injection diesel engines: every 12,000 miles (20,000 km) or every two years.
- For indirect injection diesel engines: every 10,000 miles (15,000 km) or every two years.

The extension of the service intervals means that the engine oil level must be checked regularly: topping up of the oil between oil changes is normal.

That is why the PEUGEOT network is offering you an intermediate visit between each regular service.

The date of this visit is not shown by the service indicator. It is to be carried out at least every 10 000 Miles (15 000km) for petrol and twin-fuel engines; every 6 000 miles (10 000 km) for direct injection diesel engines and every 5 000 miles (7 500 km) for indirect injection diesel engines.

A Peugeot dealer will carry out a rapid check and top up fluids as necessary (oil, coolant, windscreen wash fluid to the 2 litre limit).

If the oil level is too low there is a risk of serious damage to the engine : check the engine oil level at least every 2,000 to 3,000 miles (3,000 to 5,000 km), depending on the conditions of use.

This extended servicing has been made possible by modifications to our vehicles and to the lubricants:

THUS IT IS ESSENTIAL TO ONLY USE ENGINE LUBRICANTS WHICH ARE APPROVED AND RECOMMENDED BY THE MANUFACTURER.

MAINTENANCE OF YOUR 306

SPECIAL FEATURES

Some of your vehicle's vital components have specific servicing schedules.

The airbags and the pretensioning seat belts must be replaced every 10 years.

The brake fluid must be replaced every 36/40,000 miles (60,000 km) or every 2 years.

The pollen filter must be checked at each visit to the PEUGEOT dealer (intermediate visits and regular services).

NB: the coolant does not need to be renewed.

Arduous conditions of use

If the vehicle is used under certain particularly arduous conditions:

- **Continuous door-to-door use.**
- **Town use (e.g. taxi).**
- **Repeated short journeys, with the engine cold in low temperatures,**

Or in long stays under the following conditions:

- Hot countries with temperatures often above 30 °C.
- Cold countries with temperatures often below minus 15 °C.
- Countries with a dusty atmosphere.
- Countries whose lubricants or fuels do not conform to our recommendations.

It is necessary to follow an "Arduous conditions" service schedule which includes special operations and shorter service intervals:

- Every 12,000 miles (20 000 km) or every year for petrol vehicles.
- Every 9,000 miles (15 000 km) or every year for Direct Injection Diesel engine vehicles.
- Every 6,000 miles (10 000 km) or every year for Indirect Injection Diesel engine vehicles.

YOUR 306 IN DETAIL

SERVICE INDICATOR

This is a reminder of when the next service is due in accordance with the manufacturer's maintenance schedule.

Operation

The spanner symbolising the service operations comes on for five seconds when the ignition is switched on. The total distance recorder displays the distance remaining (in round figures) before the next service.

Example: 4800 km remain before the next service is due. For five seconds after the ignition is switched on, the display shows:



5 seconds after switching on the ignition the display resumes normal operation and shows the total and trip distances.



When the distance remaining before the next service is less than 1000 km.

Example: 900 km remain before the next service is due.

For five seconds after the ignition is switched on, the display shows:



5 seconds after switching on the ignition, the display resumes normal operation and the symbol remains lit.

This indicates that a service should be carried out shortly. The display shows the total and trip distances.



When a service is overdue.

For five seconds after the ignition is switched on, the service symbol and the excess distance flash.

Example: the service is overdue by 300 km. The vehicle should be serviced very soon.

For five seconds after the ignition is switched on, the display shows:



5 seconds after switching on the ignition, the display resumes normal operation and the service symbol remains lit. The display shows the total and trip distances.

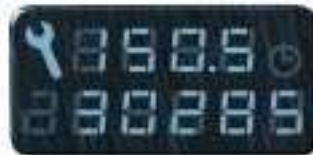

YOUR 306 IN DETAIL

Service intervals

If your vehicle is used in certain particularly difficult conditions it is necessary to follow the "Arduous conditions" servicing schedule, which involves shorter intervals between services (see your Warranty and Maintenance Record booklet).

Comment: If the time limit between two services is reached before the relevant mileage limit, the service spanner symbol will light up and the display will show 0.

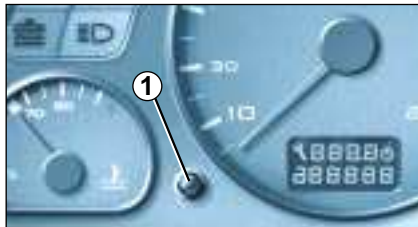

To change the service interval

- Switch off the ignition.
- Press and hold button 1.

- Switch on the ignition.
- The display begins a 10 second countdown.
- Release the button before the countdown finishes.
- The service interval is displayed.
- Each brief press of button 1 alternates the service intervals.

Example:



- When the chosen service interval is displayed, press button 1 for 10 seconds (countdown) to confirm.

Reset

Your PEUGEOT dealer carries out this operation after each service. However, if you service the vehicle yourself, reset as follows:

- Switch off the ignition.
- Press and hold button 1.
- Switch on the ignition.
- The display begins a 10 second countdown.
- Keep button 1 pressed for 10 seconds.
- The display shows [= 0] and the service symbol disappears.

YOUR 306 IN DETAIL

Service intervals

If your vehicle is used in certain particularly difficult conditions it is necessary to follow the "Arduous conditions" servicing schedule, which involves shorter intervals between services (see your Warranty and Maintenance Record booklet).

Comment: If the time limit between two services is reached before the relevant mileage limit, the service spanner symbol will light up and the display will show 0.



To change the service interval

- Switch off the ignition.
- Press and hold button 1.

- Switch on the ignition.
- The display begins a 10 second countdown.
- Release the button before the countdown finishes.
- The service interval is displayed.
- Each brief press of button 1 alternates the service intervals.

Example:



- When the chosen service interval is displayed, press button 1 for 10 seconds (countdown) to confirm.

Reset

Your PEUGEOT dealer carries out this operation after each service. However, if you service the vehicle yourself, reset as follows:

- Switch off the ignition.
- Press and hold button 1.
- Switch on the ignition.
- The display begins a 10 second countdown.
- Keep button 1 pressed for 10 seconds.
- The display shows [= 0] and the service symbol disappears.

MAINTENANCE OF YOUR 306

SPECIAL FEATURES

Some of your vehicle's vital components have specific servicing schedules.

The airbags and the pretensioning seat belts must be replaced every 10 years.

The brake fluid must be replaced every 36/40,000 miles (60,000 km) or every 2 years.

The pollen filter must be checked at each visit to the PEUGEOT dealer (intermediate visits and regular services).

NB: the coolant does not need to be renewed.

Arduous conditions of use

If the vehicle is used under certain particularly arduous conditions:

- **Continuous door-to-door use.**
- **Town use (e.g. taxi).**
- **Repeated short journeys, with the engine cold in low temperatures,**

Or in long stays under the following conditions:

- Hot countries with temperatures often above 30 °C.
- Cold countries with temperatures often below minus 15 °C.
- Countries with a dusty atmosphere.
- Countries whose lubricants or fuels do not conform to our recommendations.

It is necessary to follow an "Arduous conditions" service schedule which includes special operations and shorter service intervals:

- Every 12,000 miles (20 000 km) or every year for petrol vehicles.
- Every 9,000 miles (15 000 km) or every year for Direct Injection Diesel engine vehicles.
- Every 6,000 miles (10 000 km) or every year for Indirect Injection Diesel engine vehicles.

MAINTENANCE OF YOUR 306

TYPES OF SERVICE

Each vehicle has its own servicing cycle, defined by the manufacturer in accordance with each vehicle's specific technical features.















This cycle consists of alternating 2 types of service A and C, intermediate visits, and a few additional operations depending on your vehicle ; these correspond to key stages in the life of your 306.

Services of type B are designed for less recent vehicles.

Your dealer will indicate the type and content of the next service when the first service is carried out, and at each subsequent service.

THE MAINTENANCE CYCLE FOR YOUR PETROL 306

Service every 20,000 miles (30 000 km) or 2 years

MILES (KM)	20,000 (30 000)	40,000 (60 000)	60,000 (90 000)	80,000 (120 000)
1st service at 6,000 miles (10 000 km)* or 6 months* The validity of the Warranty depends on this service.				
				
				
				+ timing belt replacement
100,000 (150 000)	120,000 (180 000)	140,000 (210 000)	160,000 (240 000)	180,000 (270 000)
				
				
				
				+ timing belt replacement

* Whichever comes first

Automatic gearbox oil level every 40,000 miles (60,000km)

Brake fluid replacement every 2 years or every 40,000 miles (60,000km)

These operations are carried out with **synthetic based oil**; Fuel Economy oil or synthetic oil can also be used.





















Intermediate visit

MAINTENANCE OF YOUR 306

THE MAINTENANCE CYCLE FOR YOUR 306 DIESEL TURBO HDI

Service every 12,000 miles (20 000 km) or 2 years

MILES (KM)	12,000 (20 000)	24,000 (40 000)	36,000 (60 000)	48,000 (80 000)					
1st Service at 6,000 miles (10 000 km)* or 6 months* The validity of the Warranty depends on this service.									
60,000 (100 000)	72,000 (120 000)	84,000 (140 000)	96,000 (160 000)	108,000 (180 000)					
									
			+ timing belt replacement						

* Whichever comes first

Brake fluid replacement every 2 years or every 36,000 (60 000km).
These operations are carried out with **synthetic based oil**; Fuel Economy oil or synthetic oil can also be used.

























Intermediate visit

MAINTENANCE OF YOUR 306

THE MAINTENANCE CYCLE FOR YOUR 306 DIESEL (INDIRECT INJECTION NON-TURBO)

Service every 10,000 miles (15 000 km) or every 2 years

MILES (KM)	10,000 (15 000)	20,000 (30 000)	30,000 (45 000)	40,000 (60 000)	50,000 (75 000)						
1st Service at 6,000 miles (10 000 km)* or 6 months* The validity of the Warranty depends on this service.											
60,000 (90 000)	70,000 (105 000)	80,000 (120 000)	90,000 (135 000)	100,000 (150 000)	110,000 (165 000)						
											
		+ timing belt replacement									

* Whichever comes first

Brake fluid replacement every 2 years or every 40,000 (60 000km).
 These operations are carried out with **synthetic based oil**; Fuel Economy oil or synthetic oil can also be used.



Intermediate visit

MAINTENANCE OF YOUR 306

PEUGEOT SERVICING LEVELS A AND C

Operations	Description of operations for 1st service	First service	Level		
			A	C	Intermediate visit
DRAIN AND REFILL	- Engine oil	●	●	●	
	- Bleed fuel filter (diesel)		●	●	
REPLACEMENT	- Oil filter.		●	●	
	- Fuel filter (Petrol).			●	
	- Fuel filter element (Diesel).			●	
	- Air filter element.			●	
	- Spark plugs (Petrol).			●	
LEVEL	- Engine oil (check + top up).	●		●	●
	- Manual gearbox oil (check + top up).	●		●	
	- Battery (check + top up) if cap is removable		●	●	
	- Front/rear windscreen wash (check + top up).	●	●	●	●
	- Coolant (check + top up).	●	●	●	●
	- Brake fluid (check + top up).	●	●	●	
	- Power steering fluid (check + top up according to specification).	●	●	●	
CHECK	- Operation of lights and indicators.	●	●	●	
	- Condition of glass, headlamp and light lenses and mirrors.		●	●	
	- Horn.		●	●	
	- Windscreen washer jets.		●	●	
	- Condition of wiper blades.		●	●	
	- Condition and tension of ancillary drive belts.		●	●	
	- Handbrake.		●	●	
	- Condition of hydraulic circuits (hoses and covers), check for leaks.		●	●	
	- Condition of rubber boots and gaiters.	●	●	●	
	- Brake pad wear.		●	●	○
	- Play in hubs, rods, ball joints, flexible mountings		●	●	
	- Shock absorbers for leaks		●	●	
	- Rear drum brake lining wear		●	●	
	- Condition and pressure of tyres (including spare wheel).	●	●	●	
	- Emission control check according to current legislation (Petrol).	●	●	●	
	- Smoke opacity (Diesel).	●	●	●	
	- Pollen filter check (according to specification).		●	●	○
- Visual check of the whole vehicle by a PEUGEOT dealer.	●			●	
SERVICE	- Courtesy vehicle			●	
ROAD TEST			●	●	

● : All driving conditions

○ : Arduous conditions

MAINTENANCE OF YOUR 306

Recommendations for approved lubricants

The oils which appear in the table opposite are suitable for most purposes.

The diagram opposite states the optimum range of viscosity depending on the temperatures at which the oils are to be used.



It is also possible to use synthetic oils of 'superior quality'.

In the absence of semi-synthetic or synthetic oils, oils of API SH/SJ quality (for petrol engines), or CD/CF quality (for diesel engines) may be used by following the 'Arduous Conditions' maintenance schedule which specifies shorter intervals.

Do not hesitate to ask for advice from a PEUGEOT dealer to maintain driving pleasure and to minimise the maintenance cost of your vehicle.

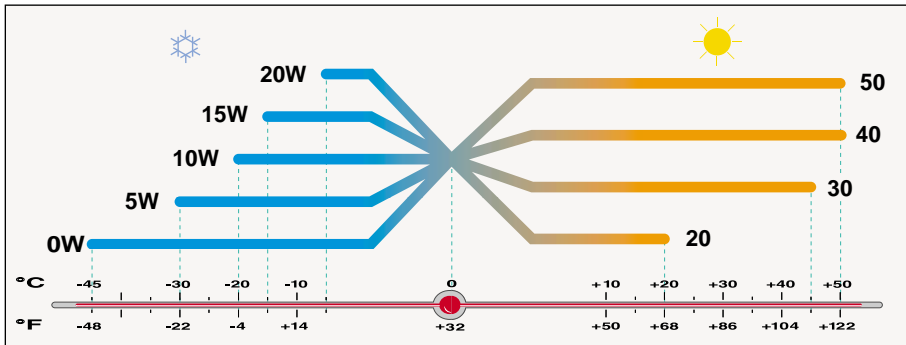
For countries outside Europe, please contact a local PEUGEOT dealer.



		
Manual gearbox	ESSENTIAL ESSO GEAR OIL BV 75W 80 PR 9736.41	ESSENTIAL TOTAL TRANSMISSION BV 75W 80
Automatic gearbox AL4	ESSENTIAL ATF 4HP20-AL4 PR 9736.22	
Automatic gearbox 4 HP-14	ESSO ATF D PR 9730.94	TOTAL FLUIDE AT42
Power steering	ESSO ATF D PR 9730.94	TOTAL FLUIDE AT42

Other approved products

Brake fluid	PEUGEOT DOT4
Coolant	PROCOR TM108 / GLYSANTIN G33 or REVKOGEL 2000 ESSENTIAL Protection to minus 35 °C

YOUR 306 IN DETAIL

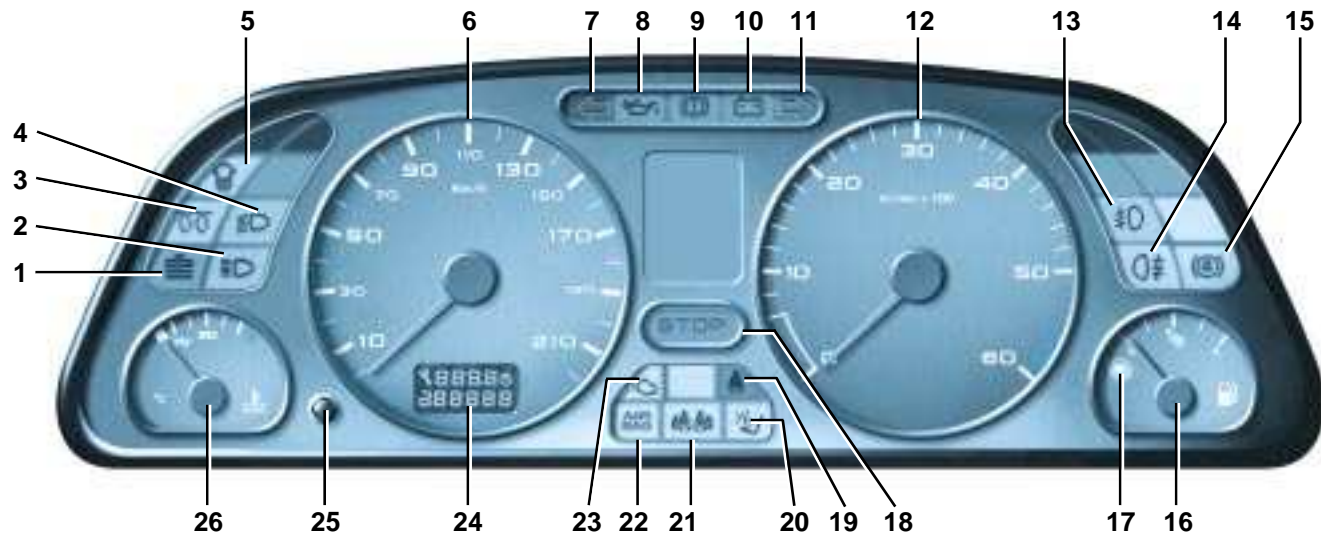

INSTRUMENT PANEL

- 1 Low coolant level*.
- 2 headlamp main beam.
- 3 Pre-heat (Diesel).
- 4 headlamp dipped beam.
- 5 Water in fuel filter warning light* (Diesel).
- 6 Speedometer.
- 7 Left indicator.
- 8 Low oil pressure warning light.
- 9 Handbrake low brake fluid level and electronic brake force distribution.
- 10 Battery charge.

- 11 Right indicator.
- 12 Rev counter.
- 13 Front fog lamps*.
- 14 Rear fog lamp.
- 15 ABS: anti-lock braking system*.
- 16 Fuel gauge.
- 17 Low fuel level.
- 18 STOP warning.
- 19 Seat belt not fastened warning light*.
- 20 Disarming of passenger airbag**.

- 21 Side airbags warning light*.
- 22 Front* and side** airbag warning light and disarming passenger airbag*.
- 23 Autodiagnosics*.
- 24 Trip recorder and service indicator
- 25 Trip recorder zero reset and clock setting.
- 26 Coolant temperature gauge.

* According to specification or country.

** According to model.

YOUR 306 IN DETAIL

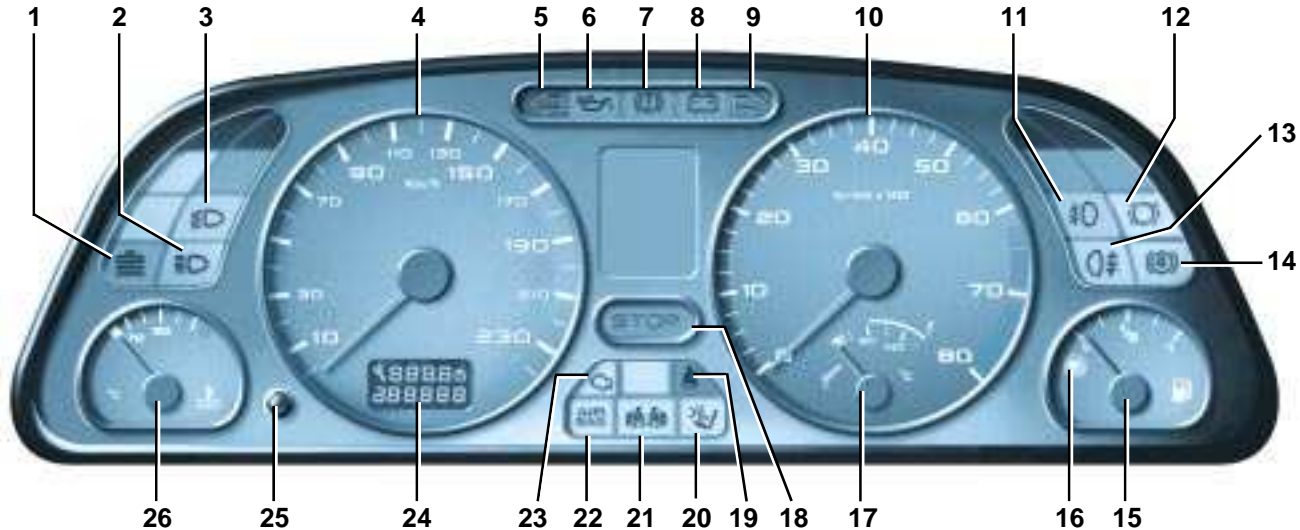

INSTRUMENT PANEL

- | | | |
|--|---|--|
| <p>1 Low coolant level.
 2 headlamp main beam.
 3 headlamp dipped beam.
 4 Speedometer.
 5 Left indicator.
 6 Low oil pressure warning light.
 7 Handbrake low brake fluid level and electronic brake force distribution.
 8 Battery charge.
 9 Right indicator.
 10 Rev counter.
 11 Front fog lamps.</p> | <p>12 Brake pad wear warning light*.
 13 Rear fog lamp.
 14 ABS: anti-lock braking system*.
 15 Fuel gauge.
 16 Low fuel level.
 17 Oil level and temperature gauge.
 18 STOP warning.
 19 Seat belt not fastened warning light*.
 20 Disarming of passenger airbag**.
 21 Side airbags warning light*.</p> | <p>22 Front* and side** airbag warning light and disarming passenger airbag*.
 23 Autodiagnosics*.
 24 Trip recorder and service indicator.
 25 Trip recorder zero reset and clock setting.
 26 Coolant temperature gauge.</p> |
|--|---|--|

* According to specification or country.

** According to model.

YOUR 306 IN DETAIL

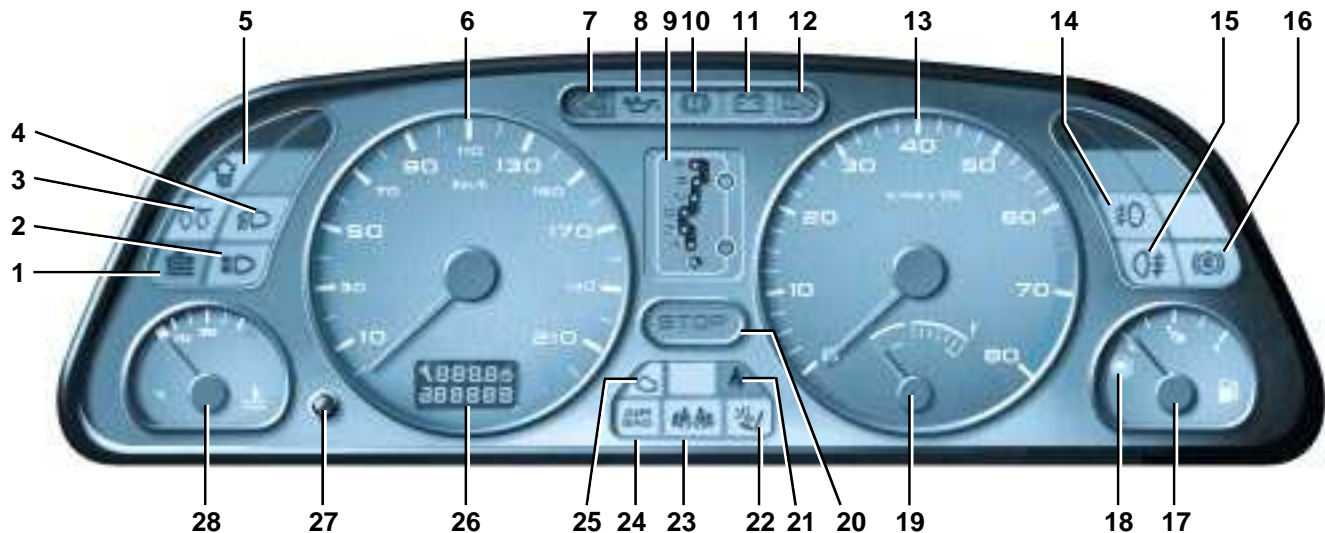

INSTRUMENT PANEL

- 1 Low coolant level*.
- 2 headlamp main beam.
- 3 Pre-heat (Diesel)*.
- 4 headlamp dipped beam.
- 5 Water in fuel filter warning light* (Diesel).
- 6 Speedometer.
- 7 Left indicator.
- 8 Low oil pressure warning light.
- 9 Gear indicator (automatic gearbox).
- 10 Handbrake low brake fluid level and electronic brake force distribution.

- 11 Battery charge.
- 12 Right indicator.
- 13 Rev counter.
- 14 Front fog lamps*.
- 15 Rear fog lamp.
- 16 ABS: anti-lock braking system*.
- 17 Fuel gauge.
- 18 Low fuel level.
- 19 Oil level.
- 20 STOP warning.
- 21 Seat belt not fastened warning light*.

- 22 Disarming of passenger airbag**.
- 23 Side airbags warning light**.
- 24 Front* and side** airbag warning light and disarming passenger airbag*.
- 25 Autodiagnosics*.
- 26 Trip recorder and service indicator.
- 27 Trip recorder zero reset and clock setting.
- 28 Coolant temperature gauge.

* According to specification or country.

** According to model.

YOUR 306 IN DETAIL

INSTRUMENTS AND CONTROLS

A warning light which remains permanently lit indicates that the unit concerned is not operating correctly. Do not ignore this warning: contact a PEUGEOT dealer as soon as possible.



Handbrake, low brake fluid level and electronic brake force distribution warning light

Indicates either:

- that the handbrake is on or has not been released correctly,
- an excessive drop in the brake fluid level (if the light remains lit even with the handbrake released),
- a malfunction of the braking system, if lit at the same time as the ABS warning light.

Stop immediately.

Contact a PEUGEOT dealer.



STOP warning light

(Together with the oil pressure warning light)

You must stop.

Contact a PEUGEOT dealer.



Battery charge warning light

Indicates either:

- faulty operation of the battery charging circuit
- loose battery or starter terminals
- a broken or loose alternator drive belt
- an alternator fault

Contact a PEUGEOT dealer.



Low coolant level warning light*

You must stop.

Wait until the engine cools before topping up.

The cooling circuit is pressurised.

When opening to top up, turn the cap to the first notch to let the pressure drop.

Contact a PEUGEOT dealer.

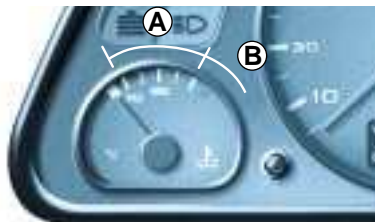

Coolant temperature gauge

- needle in zone **A**, the temperature is correct.

- needle in zone **B**, the temperature is too high.

The STOP warning light comes on.

You must stop.

Contact a PEUGEOT dealer.



Oil pressure warning light

Together with the STOP warning light.

You must stop.

Indicates either:

- oil pressure is too low
 - a lack of oil in the lubricating circuit
- Top up the oil level if necessary.

Contact a PEUGEOT dealer.



Engine autodiagnostic warning light*

This comes on each time the ignition is switched on. If it comes on when driving, this

indicates faulty operation of the injection, ignition or emission control system.

There is a risk of damage to the catalytic converter if your vehicle is fitted with one.

Contact a PEUGEOT dealer.



Low fuel warning light

Indicates that there are approximately 1.3 gallons (6 litres) of fuel remaining in the fuel tank.

(The capacity of the tank is approximately 60 litres).

YOUR 306 IN DETAIL

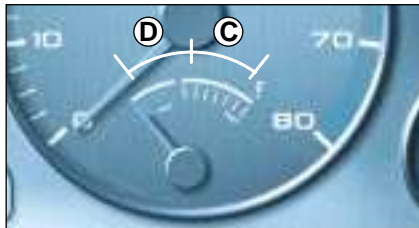

Oil gauge*

When the ignition is switched on, this indicates the oil level:

The reading is only valid if the vehicle is on level ground and the engine has been switched off for 10 minutes.

- needle in zone **C**, the oil level is correct
- needle in zone **D**, check the oil level using the dipstick and top up if necessary.

Never exceed the maximum level on the dipstick.

The oil level indicator switches off approximately 15 seconds after starting the engine.



Water in diesel filter warning light (according to country)

Risk of damage to the injection pump.

Contact a PEUGEOT dealer as soon as possible.



Oil level and temperature gauge*

When the ignition is switched on, this indicates the oil level (see Oil Gauge section).

After approximately 15 seconds, the graduated section and the oil level symbol go out. The oil temperature is then shown.

- needle in zone **E**, the temperature is correct.
- needle in zone **F**, the temperature is too high. To lower the oil temperature, reduce your speed.



Diesel pre-heat light

If the light comes on, wait until it goes out before trying the starter.

If the engine is warm enough, the light will not come on, and you can start the engine without waiting.

Front air bags*, side air bags** and disarming the passenger air bag*

For operation, see section on AIR BAGS.



Side air bags**

For operation, see section on AIR BAGS.



Front brake pad wear warning light*

For your safety, change the brake pads when the warning light comes on.

Contact a PEUGEOT dealer.



Anti-lock braking system (ABS) warning light*

It comes on for 3 seconds each time the ignition is switched on. If it comes on at over 8 m.p.h. (12 km/h.) it indicates a malfunction of the ABS.

However, the vehicle retains conventional servo-assisted braking.

Contact a PEUGEOT dealer.

* According to specification.

** According to model.

YOUR 306 IN DETAIL

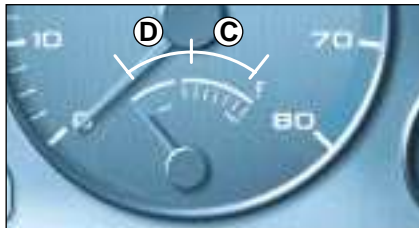

Oil gauge*

When the ignition is switched on, this indicates the oil level:

The reading is only valid if the vehicle is on level ground and the engine has been switched off for 10 minutes.

- needle in zone **C**, the oil level is correct
- needle in zone **D**, check the oil level using the dipstick and top up if necessary.

Never exceed the maximum level on the dipstick.

The oil level indicator switches off approximately 15 seconds after starting the engine.



Water in diesel filter warning light (according to country)

Risk of damage to the injection pump.

Contact a PEUGEOT dealer as soon as possible.



Oil level and temperature gauge*

When the ignition is switched on, this indicates the oil level (see Oil Gauge section).

After approximately 15 seconds, the graduated section and the oil level symbol go out. The oil temperature is then shown.

- needle in zone **E**, the temperature is correct.
- needle in zone **F**, the temperature is too high. To lower the oil temperature, reduce your speed.



Diesel pre-heat light

If the light comes on, wait until it goes out before trying the starter.

If the engine is warm enough, the light will not come on, and you can start the engine without waiting.

Front air bags*, side air bags** and disarming the passenger air bag*

For operation, see section on AIR BAGS.



Side air bags**

For operation, see section on AIR BAGS.



Front brake pad wear warning light*

For your safety, change the brake pads when the warning light comes on.

Contact a PEUGEOT dealer.



Anti-lock braking system (ABS) warning light*

It comes on for 3 seconds each time the ignition is switched on. If it comes on at over 8 m.p.h. (12 km/h.) it indicates a malfunction of the ABS.

However, the vehicle retains conventional servo-assisted braking.

Contact a PEUGEOT dealer.

* According to specification.

** According to model.

YOUR 306 IN DETAIL



Adjusting the height of the steering wheel

Push the handle to unlock the steering wheel.

Adjust the steering wheel to the desired height and pull the handle to lock it into position.

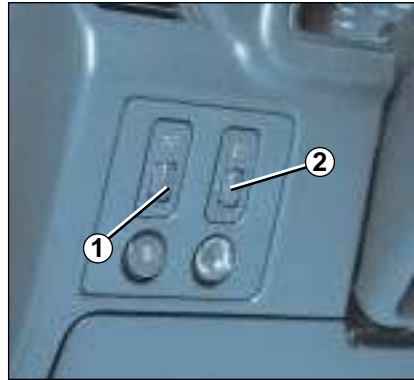

1 - Lighting rheostat*

Dim or brighten the instrument panel lighting by turning the knob. This only operates when the exterior lights are on.



2 - Headlamp height adjustment*

Depending on the vehicle's load, it is advisable to adjust the headlamp beam.

- 0** - 1 or 2 people in the front seats.
- 3 people.
- 1** - 5 people.
- 2** - 5 people + maximum authorised load.
- 3** - Driver + maximum authorised load.

This adjustment can only be carried out with the lighting stalk in the dipped/main beam headlamps position.

Initial setting: **0**.

* According to specification.

YOUR 306 IN DETAIL

AUDIO RB1

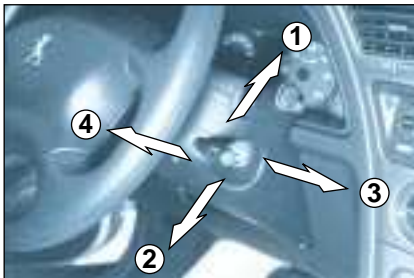
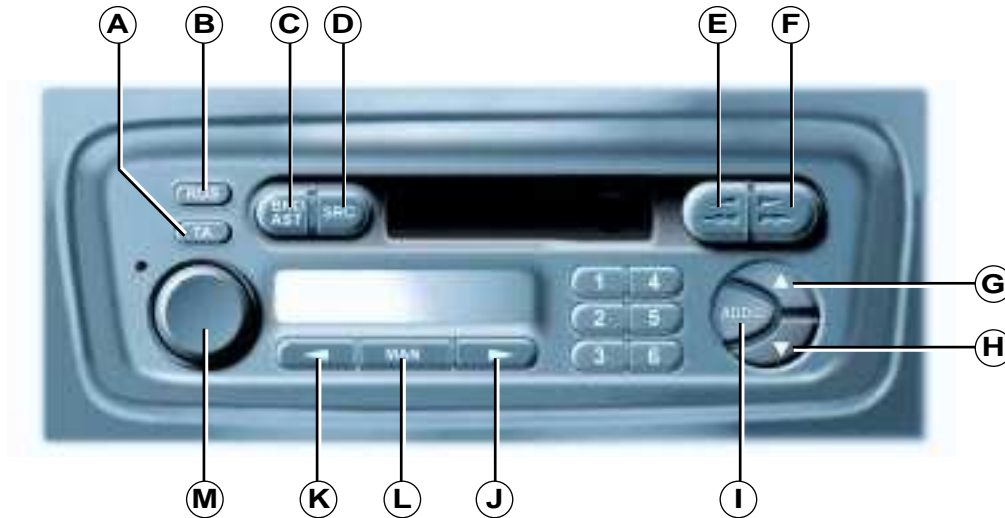







- 1 - Upwards
- 2 - Downwards
- 3 - Forwards
- 4 - Backwards

- I : Raise volume
- F : Lower volume
- D : Automatic search of lower frequencies (radio). Selection of previous track (CD)*
- C : Automatic search of higher frequencies (radio). Selection of next track (CD)*

* Available as an accessory

YOUR 306 IN DETAIL

Button		Function
A	TA	Traffic information priority on/off.
B	RDS	RDS on/off. Pressed for over 2 seconds: regional following mode on/off.
C	BND/AST	Waveband selection FMI, FMII, FMIII, AM. Pressed for over 2 seconds: autostore, automatic storing of stations.
D	SRC	Source selection; radio, cassette or CD*. Pressed for over 2 seconds: CD* shuffle.
E		Pressed fully: cassette fast rewind.
F		Pressed fully: cassette fast forwards.
E + F		Pressed half-way: reverses the direction of play of the cassette. Pressed fully: ejects the cassette.
G		Increase the audio setting
H		Decrease the audio setting
I	AUDIO	Selects bass, treble, loudness, balance and fader.
J		Higher frequency automatic search. Selection of next CD* track.
K		Lower frequency automatic search. Selection of previous CD* track.
L	MAN	Manual/automatic operation of button J and K .
M		Audio system on/off. Volume adjustment.
1 to 6		Selects a stored station. Pressed for over 2 seconds: stores a station. Selects a CD* disk.

* Available as an accessory.

YOUR 306 IN DETAIL

GENERAL FUNCTIONS



On / off

With the ignition key in the ACCESSORIES or IGNITION position, press the "**ON/VOL**" button to switch the set on or off.

ANTI-THEFT SYSTEM

The first time you use the set following disconnection of the set or the battery, you must enter the confidential code which was given to you on handover of your vehicle.

Entering the code

Switch the set on.

The display shows "**CODE**" then the set changes over to code request mode and "- - -" is displayed.

Enter your **four-digit** code number using buttons "**1**" to "**6**".

For example: if your code is 5345 press buttons "**5**", "**3**", "**4**" and "**5**" in turn.

When the fourth number has been entered correctly, the radio starts automatically.

Error in entering the code

If an error is made when entering one of the first three digits, do not continue the operation and switch off the radio to prevent blocking it.

Each incorrect code entry will result in the set being blocked for a period of from 5 seconds to 30 minutes, after the 7th incorrect entry.

To unblock the set, leave it switched on during the waiting period. When "- - -" is displayed, you can enter the code again.

If the set is switched off during the waiting period, this waiting period will restart when the set is switched on again.

After 14 incorrectly input codes, the radio will be permanently locked and the display will read "**END**".

ADJUSTING THE SOUND

Adjusting the volume

Turn the "**M**" button to increase or decrease the volume of the set.

In the event of the radio overheating, the volume reduces. If an attempt is made to increase the volume the message "**TOO HOT**" appears on the display.

Note

*If you have a telephone fitted with a "**mute**" signal output connected to the set, the set will automatically change to "**mute**" when the telephone is used.*

YOUR 306 IN DETAIL



AUDIO SETTINGS

Press the “**AUDIO**” button several times to select bass (**BASS**), treble (**TREB**), loudness (**LOUD**), fader (**FAD**) and balance (**BAL**).

Exit from audio mode is automatic after a few seconds, without pressing any button or by pressing the “**AUDIO**” button after adjusting the balance.

Note : bass and treble settings are specific to each source. It is possible to set them differently for radio, cassette and CD.

Bass setting

When “**BASS**” is displayed, press the “**G**” or “**H**” buttons to vary the setting.

- “**BASS -9**” for a minimum bass setting,
- “**BASS 0**” for a normal position,
- “**BASS +9**” for a maximum bass setting.

Treble setting

When “**TREB**” is displayed, press the “**G**” or “**H**” buttons to vary the setting.

- “**TREB -9**” for a minimum treble setting,
- “**TREB 0**” for a normal position,
- “**TREB +9**” for a maximum treble setting.

Adjusting the loudness

This function automatically emphasises bass and treble tones when the volume is low.

Press the “**G**” or “**H**” buttons to switch this function on or off.

Setting the front/rear sound distribution (Fader)

When “**FAD**” is displayed, press the “**G**” or “**H**” buttons to vary the setting.

The “**G**” button increases the volume at the front.

The “**H**” button increases the volume at the rear.

Note : For vehicles fitted with speakers at the front only, it is possible to cancel or add this function. This operation is carried out as follows:

- ignition key in Accessories position,
- with the radio switched off,
- simultaneously pressing buttons “**I**” and “**M**”.

YOUR 306 IN DETAIL

Setting the right/left sound distribution (Balance)

When "BAL" is displayed, press the "G" or "H" buttons to vary the setting.

The "G" button increases the volume on the right-hand side.

The "H" button increases the volume on the left-hand side.

RADIO

Notes on radio reception

Your car radio receiver is subject to phenomena which do not affect domestic sets. Both MW/LW and FM reception are subject to various forms of interference which are not a reflection on the quality of your set, but are due to the nature of the signals and the way in which they are transmitted.

On MW/LW, interference may be noticed when passing underneath high voltage power lines or bridges or in tunnels.

On FM, interference may be the result of distance from the transmitter, reflection of the signal by obstacles (mountains, hills, buildings etc), or of being in an area which is not covered by a transmitter.



Selecting the radio

Press the "SRC" button, until the radio is selected.



Selecting a waveband

By short presses on the "BND/AST" button, you can select the FMI, FMII, FMIII, and AM wavebands.



Automatic station search

Briefly press button "J" or "K" to search for the next station up or down the waveband. By continuing to press the button in the direction selected, you will obtain continuous scrolling of the frequency.

The scrolling stops at the first station found as soon as you release the button.

If the TA traffic programme is selected, only stations broadcasting this type of programme are selected.

Searching for a station occurs first in "LO" sensitivity (selection of the most powerful transmitters, while scanning the waveband), then in "DX" sensitivity (selection of the most powerful transmitters).



YOUR 306 IN DETAIL

Setting the right/left sound distribution (Balance)

When "BAL" is displayed, press the "G" or "H" buttons to vary the setting.

The "G" button increases the volume on the right-hand side.

The "H" button increases the volume on the left-hand side.

RADIO

Notes on radio reception

Your car radio receiver is subject to phenomena which do not affect domestic sets. Both MW/LW and FM reception are subject to various forms of interference which are not a reflection on the quality of your set, but are due to the nature of the signals and the way in which they are transmitted.

On MW/LW, interference may be noticed when passing underneath high voltage power lines or bridges or in tunnels.

On FM, interference may be the result of distance from the transmitter, reflection of the signal by obstacles (mountains, hills, buildings etc), or of being in an area which is not covered by a transmitter.



Selecting the radio

Press the "SRC" button, until the radio is selected.



Selecting a waveband

By short presses on the "BND/AST" button, you can select the FMI, FMII, FMIII, and AM wavebands.



Automatic station search

Briefly press button "J" or "K" to search for the next station up or down the waveband. By continuing to press the button in the direction selected, you will obtain continuous scrolling of the frequency.

The scrolling stops at the first station found as soon as you release the button.

If the TA traffic programme is selected, only stations broadcasting this type of programme are selected.

Searching for a station occurs first in "LO" sensitivity (selection of the most powerful transmitters, while scanning the waveband, then in "DX" sensitivity (selection of the most powerful transmitters).



YOUR 306 IN DETAIL



Manual station search

Press the “**MAN**” button.

Briefly press button “**J**” or “**K**” respectively to increase or reduce the frequency displayed.

By continuing to press the button in the direction selected, you will obtain continuous scrolling of the frequency.

Scrolling stops as soon as you release the button.

Pressing the “**MAN**” button again returns you to automatic station search.

Manual storing of stations in the memory

Select the station required.

Press for more than two seconds one of the buttons “**1**” to “**6**”.

The sound stops then becomes audible again, confirming that the station has been stored in memory.



Automatic storing of FM stations in the memory (autostore)

Press the “**BND/AST**” button for more than two seconds, to automatically store the 6 stations with the strongest signal in FM. These stations are stored in the FMIII waveband.

- If it is not possible to find 6 stations, the remaining memories are empty.

Recalling stations stored in the memory

For each waveband, briefly pressing the buttons “**1**” to “**6**” recalls the corresponding stored station.

RDS FUNCTION

Using the RDS (Radio Data System) function on FM

RDS allows you to continue to listen to the same station, whatever frequency it is using for the region you are going through.

Switch the function on or off by briefly pressing the “**RDS**” button.



RDS station following

The display indicates the name of the station selected. The radio is continually searching for the station which has the best reception and which is transmitting the same programme.

YOUR 306 IN DETAIL

Traffic information programmes

Press the "TA" button to switch the function on or off.

Any traffic information flash will be given priority, whatever source you are listening to (radio, cassette or CD).

If you wish to interrupt a message, press the "TA" button; this switches off the function.

Note : the volume of the traffic information announcements is independent of the volume of normal radio listening. You can adjust it using the volume button. The setting will be stored and will be used when the next messages are broadcast.

While traffic information is being broadcast, the display will alternately show "TRAFFIC" and the name of the station.

When the station selected cannot broadcast traffic information, the display shows "NO TA".



Regional following mode (REG)

When they are part of a network, certain stations broadcast regional programmes in the various areas they serve.

With regional following mode you can keep listening to the same programme.

To do this press the "RDS" button for more than two seconds to switch this function on or off.



YOUR 306 IN DETAIL

CASSETTE

Selecting cassette mode



When a cassette is inserted, the cassette player will start automatically. If a cassette is already inserted, press the "SRC" button until the cassette is selected.

Ejecting the cassette



Fully press both buttons "E" and "F" to eject the cassette from the player.

Direction of play

The player will play sides 1 and 2 of the cassette alternately, by automatically reversing the direction of play at the end of a side.

To manually reverse the direction of play, press both buttons "E" and "F" part way.

Fast forward/rewind



Fully press one of the buttons "E" or "F" to fast forward or fast rewind the cassette. At the end of the fast forward/rewind, the set plays the current side.

Note:

- **During fast forwards or rewind of a cassette, the audio system will automatically play the last radio station.**
- **Never insert a damaged cassette.**

YOUR 306 IN DETAIL

CDMULTI-CHANGER (Available as an accessory)

Selecting the CD changer

Press the "**SRC**" button until the CD player is selected.



Selecting a disc

Press a button from "**1**" to "**6**" to select the corresponding disc.

Selecting a track

Press button "**J**" to select the next track.

Press button "**K**" to return to the start of the current track or to select the previous track.



Accelerated play

Press the "**MAN**" button.

Keep button "**J**" or "**K**" pressed for forwards or backwards accelerated play.

Accelerated play stops as soon as you release the button.

Buttons "**J**" and "**K**" resume the "track selection" function when the "**MAN**" button is pressed again.



Shuffle (RAND)

When the CD multi-changer is selected, keep the "**SRC**" button pressed for two seconds. The tracks will be played in random sequence. Pressing the "**SRC**" button again for two seconds returns you to normal play.



YOUR 306 IN DETAIL

CD CHANGER (Available as an accessory)

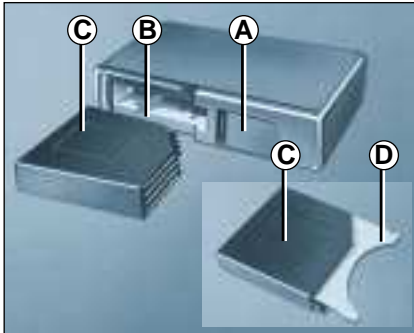

To insert a disc into the changer:

- open sliding panel **A**,
- press button **B** to eject the cartridge **C**,
- open one of the six compartments of the cartridge by pulling tab **D**,
- **insert the disc with the printed face upwards and close the compartment,**
- insert the cartridge into the changer,
- close the sliding panel **A**.

YOUR 306 IN DETAIL



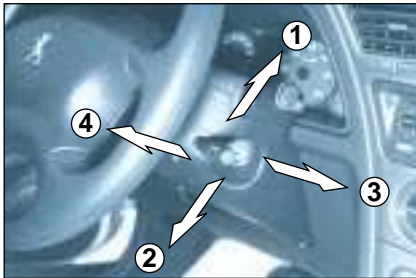
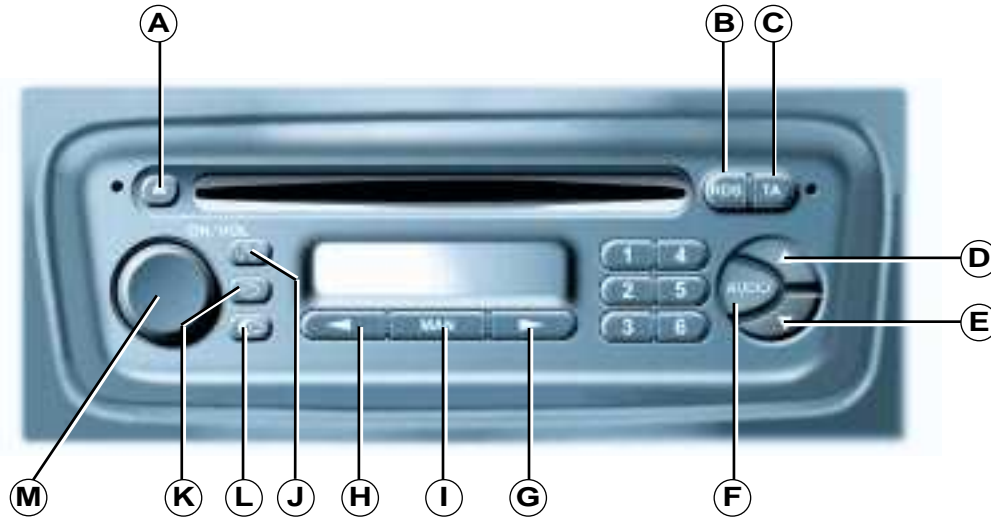





AUDIO RD1



- 1 - Upwards
- 2 - Downwards
- 3 - Forwards
- 4 - Backwards

- F : Raise volume
- G : Lower volume
- H : Automatic search of lower frequencies (radio).
Selection of previous track (CD)
- I : Automatic search of higher frequencies (radio).
Selection of next track (CD)

YOUR 306 IN DETAIL

Button		Function
A		Ejection of the CD.
B	RDS	RDS function on/off. Press for more than 2 seconds: regional station following on/off.
C	TA	Traffic information priority on/off. Press for more than 2 seconds: PTY function on/off.
D		Increase the audio setting.
E		Decrease the audio setting.
F	AUDIO	Selects bass, treble, loudness, balance and fader.
G		Automatic search of higher frequency. Selection of next CD track.
H		Automatic search of lower frequency. Selection of previous CD track.
I	MAN	Manual/automatic operation of buttons G and H .
J		Source selection, radio. Selection of wavebands FM1, FM2, FM3, AM. Press for more than 2 seconds: automatic storing of stations (autostore).
K		Source selection, CD. Press for more than 2 seconds: shuffle.
L		Source selection: CD changer
M	ON/VOL	Radio on/off. Volume adjustment.
1 to 6		Selection of the stored station. Press for more than 2 seconds: storing a station. Selection of a CD disc.

YOUR 306 IN DETAIL

GENERAL FUNCTIONS



On / off

With the ignition key in the ACCESSORIES or IGNITION position, press the "ON/VOL" button to switch the set on or off.

The set can operate for 30 minutes without switching the ignition on.

ANTI-THEFT SYSTEM

The first time you use the set following disconnection of the set or the battery, you must enter the confidential code which was given to you on handover of your vehicle.

Entering the code

Switch the set on.

The display shows "CODE IN" then the set changes over to code request mode and "- - - -" is displayed.

Enter your **four-digit** code number using buttons "1" to "6".

For example: if your code is 5345 press buttons "5", "3", "4" and "5" in turn.

When the fourth number has been entered correctly, the radio starts automatically.

Error in entering the code

If an error is made when entering one of the first three digits, do not continue the operation and switch off the radio to prevent blocking it.

Each incorrect code entry will result in the set being blocked for a period of from 5 seconds to 30 minutes, after the 7th incorrect entry.

To unblock the set, leave it switched on during the waiting period. When "- - - -" is displayed, you can enter the code again.

If the set is switched off during the waiting period, this waiting period will restart when the set is switched on again.

After 14 incorrectly input codes, the radio will be permanently locked and will display "END".

ADJUSTING THE SOUND

Adjusting the volume

Turn the "ON/VOL" button **M** to increase or decrease the volume of the set.

In the event of the radio overheating, the volume level decreases.

Note

If you have a telephone fitted with a "mute" signal output connected to the set, the set will automatically change to "mute" when the telephone is used.

YOUR 306 IN DETAIL



AUDIO SETTINGS

Press the “**AUDIO**” button several times to select bass (**BASS**), treble (**TREB**), loudness (**LOUD**), fader (**FAD**) and balance (**BAL**).

Exit from audio mode is automatic after a few seconds, without pressing any button or by pressing the “**AUDIO**” button after adjusting the balance.

Note: the bass and treble settings are specific to each source. It is possible to set the radio, CD, or CD multi-changer differently.

Bass setting

When “**BASS**” is displayed, press the “**D**” or “**E**” buttons to vary the setting.

- “**BASS -9**” for a minimum bass setting,
- “**BASS 0**” for a normal position,
- “**BASS +9**” for a maximum bass setting.

Treble setting

When “**TREB**” is displayed, press the “**D**” or “**E**” buttons to vary the setting.

- “**TREB -9**” for a minimum treble setting,
- “**TREB 0**” for a normal position,
- “**TREB +9**” for a maximum treble setting.

Adjusting the loudness

This function automatically emphasises bass and treble tones when the volume is low.

Press the “**D**” or “**E**” buttons to switch this function on or off.

Setting the front/rear sound distribution (Fader)

When “**FAD**” is displayed, press the “**D**” or “**E**” buttons to vary the setting.

The “**D**” button increases the volume at the front.

The “**E**” button increases the volume at the rear.

This function may be switched off by simultaneously pressing buttons “**M**” and “**F**”.

Setting the right/left sound distribution (Balance)

When “**BAL**” is displayed, press the “**D**” or “**E**” buttons to vary the setting.

The “**D**” button increases the volume on the right-hand side.

The “**E**” button increases the volume on the left-hand side.

YOUR 306 IN DETAIL

RADIO

Notes on radio reception

Your car radio receiver is subject to phenomena which do not affect domestic sets. Both MW/LW and FM reception are subject to various forms of interference which are not a reflection on the quality of your set, but are due to the nature of the signals and the way in which they are transmitted.

On MW/LW, interference may be noticed when passing underneath high voltage power lines or bridges or in tunnels.

On FM, interference may be the result of distance from the transmitter, reflection of the signal by obstacles (mountains, hills, buildings etc), or of being in an area which is not covered by a transmitter.



Selecting the radio

Press the "J" button.

Selecting a waveband

By short presses on the "J" button, you can select the FM1, FM2, FM3 and AM wavebands.



Automatic station search

Briefly press button "G" or "H" to search for the station immediately above or below. By continuing to press the button in the direction selected, you will obtain continuous scrolling of the frequency.

The scrolling stops on the first station found immediately after you release the button.

If TA, traffic information programme, is selected, only stations broadcasting this type of programme are selected.

Searching for a station occurs first in "LO" sensitivity (selection of the most powerful transmitters) during scanning of the waveband, then in "DX" sensitivity (selection of the weakest and most distant transmitters).

To scan the waveband in "DX" sensitivity, press twice on button "G" or "H".



Manual station search

Press the "MAN" button.

Briefly press button "G" or "H" respectively to increase or reduce the frequency displayed.

By continuing to press the button in the direction selected, you will obtain continuous scrolling of the frequency.

Scrolling stops as soon as you release the button.

Pressing the "MAN" button again returns you to automatic station search.



YOUR 306 IN DETAIL

Manual storing of stations in the memory

Select the station required.

Press for more than two seconds one of the buttons “1” to “6”.

The sound stops then becomes audible again, confirming that the station has been stored in memory.

Automatic storing of FM stations in the memory (autostore)

Press the “J” button for more than two seconds, to automatically store the 6 stations with the strongest signal in FM. These stations are stored in the FM3 waveband.

- If it is not possible to find 6 stations, the remaining memories are empty.

Recalling stations stored in the memory

For each waveband, briefly pressing the buttons “1” to “6” recalls the corresponding stored station.



RDS FUNCTION

Using the RDS (Radio Data System) function on FM

RDS allows you to continue to listen to the same station, whatever frequency it is using for the region you are going through.

Switch the function on or off by briefly pressing the “RDS” button.

RDS station following

The display indicates the name of the station selected. The radio is continually searching for the station which has the best reception and which is transmitting the same programme.



YOUR 306 IN DETAIL



Traffic information programme

Press the "TA" button to switch the function on or off.

Any traffic information flash will be broadcast as a priority, whether you are using the radio, CD, CD multi-changer.

If you wish to interrupt a message, press the "TA" button; this switches off the function.

Note : the volume of the traffic information announcements is independent of the volume of normal radio listening. You can adjust it using the volume button. The setting will be stored and will be used when the next messages are broadcast.

While traffic information is being broadcast, the display will alternately show "TRAFFIC" and the name of the station.

When the station selected cannot broadcast traffic information, the display shows "NO TA".



Regional following mode (REG)

When they are part of a network, certain stations broadcast regional programmes in the various areas they serve.

With regional following mode you can keep listening to the same programme.

To do this press the "RDS" button for more than two seconds to switch this function on or off.



PTY function

This allows you to listen to stations broadcasting a specific type of programme (news, culture, sport, rock etc.).

With FM selected, press the "TA" button for two seconds to switch this function on or off.

To find a PTY programme:

- switch on the **PTY** function,
- briefly press button "G" or "H" to scroll down the list of the various types of programmes offered,
- when the programme of your choice is displayed, keep button "G" or "H" pressed for more than two seconds to carry out an automatic search (after an automatic search the PTY function is switched off).

In **PTY** mode the different types of programmes can be stored in memory. To do this, press down the preselection buttons "1" to "6" for more than two seconds. Recalling the type of programme stored in the memory is by a brief press on the corresponding button.



YOUR 306 IN DETAIL

EON system

This connects stations which are part of the same network. It enables broadcasting of traffic information or a PTY programme from a station which is part of the same network as the station to which you are listening. This service is available when you have selected the TA traffic information programme or the PTY function.

COMPACT DISC

Selecting the CD as source

After inserting a disc, with the printed surface upwards, the player starts automatically. If a disc is already inserted, press the "K" button.



Ejecting a disc

Press button "A" to eject the disc from the player.



Selecting a track

Press button "G" to select the next track.

Press button "H" to return to the start of the current track or to select the previous track.



Accelerated play

Press the "MAN" button.

Keep button "G" or "H" pressed for forwards or backwards accelerated play.

Accelerated play stops as soon as you release the button.

Buttons "G" and "H" resume the "track selection" function when the "MAN" button is pressed again.



Shuffle (RDM)

When the CD is selected, keep the "K" button pressed for two seconds. The tracks will be played in random sequence. Pressing the "K" button again for two seconds returns you to normal play.



YOUR 306 IN DETAIL

EON system

This connects stations which are part of the same network. It enables broadcasting of traffic information or a PTY programme from a station which is part of the same network as the station to which you are listening. This service is available when you have selected the TA traffic information programme or the PTY function.

COMPACT DISC

Selecting the CD as source

After inserting a disc, with the printed surface upwards, the player starts automatically. If a disc is already inserted, press the "K" button.



Ejecting a disc

Press button "A" to eject the disc from the player.



Selecting a track

Press button "G" to select the next track.

Press button "H" to return to the start of the current track or to select the previous track.



Accelerated play

Press the "MAN" button.

Keep button "G" or "H" pressed for forwards or backwards accelerated play.

Accelerated play stops as soon as you release the button.

Buttons "G" and "H" resume the "track selection" function when the "MAN" button is pressed again.

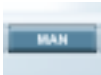

Shuffle (RDM)

When the CD is selected, keep the "K" button pressed for two seconds. The tracks will be played in random sequence. Pressing the "K" button again for two seconds returns you to normal play.



YOUR 306 IN DETAIL

CD MULTI-CHANGER

Selecting the CD multi-changer

Press the “L” button.



Selecting a disc

Press a button from “1” to “6” to select the corresponding disc.

Selecting a track

Press button “G” to select the next track.

Press button “H” to return to the start of the current track or to select the previous track.



Accelerated play

Press the “MAN” button.

Keep button “G” or “H” pressed for forwards or backwards accelerated play.

Accelerated play stops as soon as you release the button.

Buttons “G” and “H” resume the “track selection” function when the “MAN” button is pressed again.



Shuffle (RDM)

When the CD multi-changer is selected, keep the “L” button pressed for two seconds. The tracks will be played in random sequence. Pressing the “L” button again for two seconds returns you to normal play.



YOUR 306 IN DETAIL

CD CHANGER (Available as an accessory)

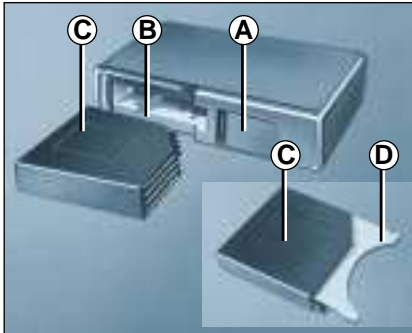

To insert a disc into the changer:

- open sliding panel **A**,
- press button **B** to eject the cartridge **C**,
- open one of the six compartments of the cartridge by pulling tab **D**,
- **insert the disc with the printed face upwards and close the compartment,**
- insert the cartridge into the changer,
- close the sliding panel **A**.

YOUR 306 IN DETAIL

RADIO/NAVIGATION "Travel Pilot"

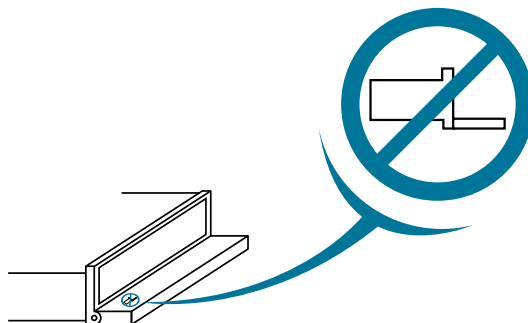

Note : Do not drive with the front panel flap open.

*According to specification

The instructions for using the Radio/Navigation «Travel Pilot» are attached to the CD, on delivery of the vehicle.

The travel pilot can control the BLAUPUNKT CDC A08 CD changer

YOUR 306 IN DETAIL

CD CHANGER (Available as an accessory)

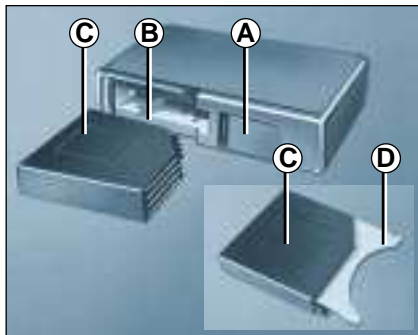

To insert a disc into the changer:

- open sliding panel **A**,
- press button **B** to eject the cartridge **C**,
- open one of the six compartments of the cartridge by pulling tab **D**,
- **insert the disc with the printed face upwards and close the compartment,**
- insert the cartridge into the changer,
- close the sliding panel **A**.

YOUR 306 IN DETAIL

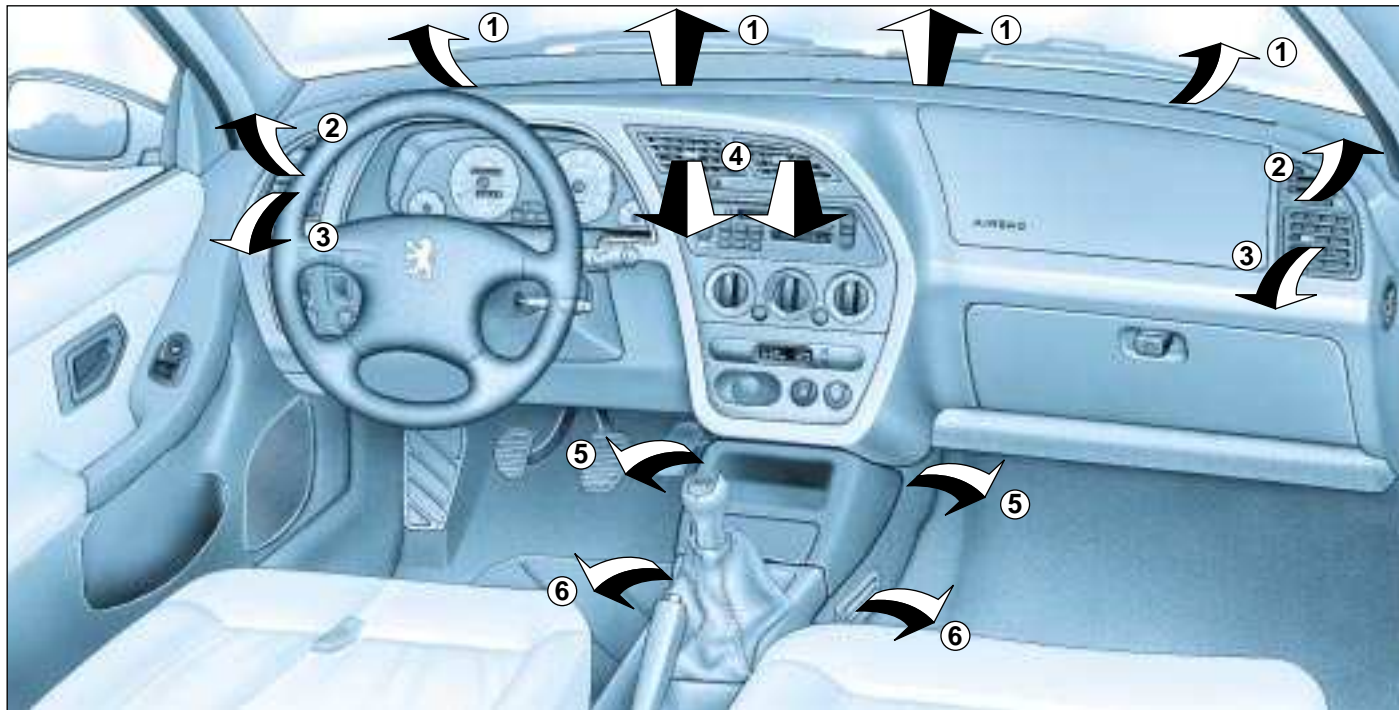

YOUR 306 IN DETAIL

Ventilation

- 1 - Windscreen demisting or de-icing vents.
- 2 - Front windows demisting or de-icing vents.
- 3 - Side vents.
- 4 - Central vents.
- 5 - Air outlet to front footwells.
- 6 - Air outlet to rear footwells.

Advice on use

- Position the air flow control at a sufficient level to ensure correct renewal of air inside the vehicle.
- Select the most suitable air distribution for your requirements and the climatic conditions.
- Select a suitable temperature setting and only modify it gradually for your comfort.

YOUR 306 IN DETAIL

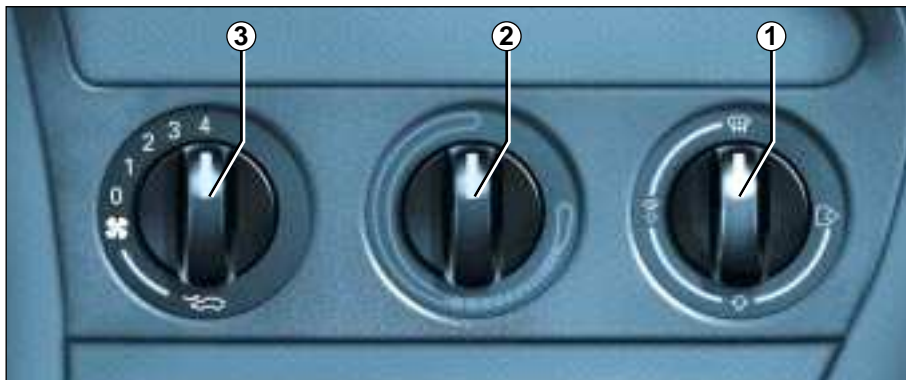

HEATING

1 - Adjusting the air distribution

To direct hot or cold air, turn knob **1** to the desired position.



Windscreen and side windows.



Footwells only.



Windscreen, side windows and footwells.



Side and central vents.

To quickly de-ice or demist the windscreen and the side windows, set the heating and air flow controls to maximum.

To obtain even air distribution, ensure that the external air intake vent and the ventilation vents are not blocked and that the air can move freely under the front seats.

2 - Adjusting the temperature

Turn the knob **2** to the blue zone (outside temperature) or to the red zone (hot).

3 - Adjusting the air flow

Turn the knob **3** to the required flow position.



This position prevents the entry of outside air. It must only be used for a short time to prevent the entry of unpleasant odours or dust.

YOUR 306 IN DETAIL

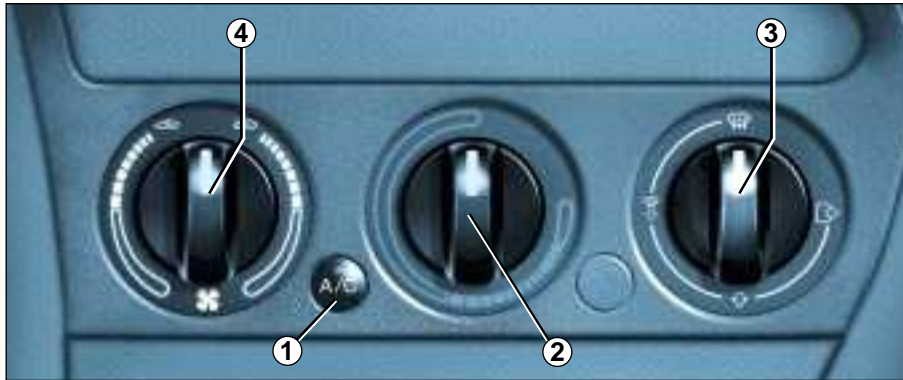

AIR CONDITIONING

1 - Switching on

Press the switch 1, the operating light will come on.

2 - Adjusting the temperature

Turn the knob 2 to the blue zone (cold) or to the red zone (hot).

3 - Adjusting the air distribution

To direct the hot or cold air, turn the knob 3 to the desired position.



Windscreen and side windows.



Footwells only.



Windscreen, side windows and footwells.



Side and central vents.

4 - Adjusting the air flow

Turn the knob 4 to obtain the desired flow.



Entry of outside air

This is the normal operating position.



Recirculation of interior air

This position prevents the entry of outside air.

Used at the same time as the air conditioning, this will improve air conditioning performance.

Used on its own, it prevents the entry of outside air (dust, unpleasant odours) but there is a risk of misting of the windows.

Avoid continuous operation in interior air recirculation mode.

Important precautions:

Operate the air conditioning system for 5 to 10 minutes once or twice a month to keep it in good working order.

It is advisable to change the air conditioning system fluid every two years.

If the system is not producing cold air, stop using it and contact a PEUGEOT dealer.

YOUR 306 IN DETAIL

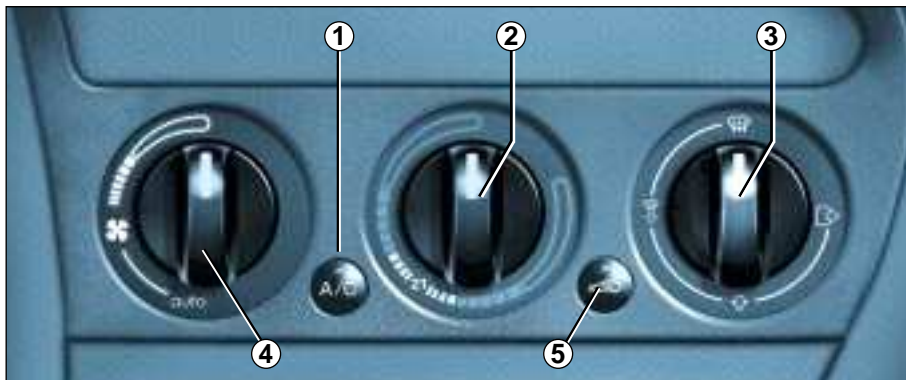

AUTOMATIC AIR CONDITIONING

This provides optimum comfort as well as dehumidifying the air inside the vehicle. In particular, it allows the temperature to be lowered in summer and the effectiveness of the demisting to be increased in winter.

1 - Switching on

Press the switch 1, the operating light will come on.

2 - Adjusting the temperature:

Turn the knob 2 to the blue zone (cold) or to the red zone (hot).

On positioning the knob in the white zone the system automatically controls the operation of the air conditioning. This ensures a comfortable temperature whatever the climatic conditions may be.

Temperature selection in auto mode requires 12 to 15 seconds before the required temperature is reached.

3 - Adjusting the air distribution

To direct the hot or cold air, turn the knob 3 to the desired position.



Windscreen and side windows.



Windscreen, side windows and footwells.



Footwells only.



Side and central vents.

YOUR 306 IN DETAIL

4 - Adjusting the air flow

In the AUTO position the flow is controlled automatically in accordance with the temperature selected.

You can, however, adjust the flow manually by turning the knob **4** according to the desired flow.

In AUTO mode, this automatically adjusts the temperature inside the vehicle according to your wishes (pre-set temperature). To do this, the electronic control unit adjusts the temperature and the flow of air at the vents and operates the air conditioning system if necessary.

5 - Recirculation of interior air

Press the switch **5**, the indicator light comes on.

The air conditioning comes into operation automatically.

This position must only be used in exceptional circumstances to:

- improve the performance of the air conditioning,
- prevent the entry of external air (dust, unpleasant odours),
- speed up heating inside the vehicle with a risk of misting of the windows.

Special features

If the air distribution control is in the windscreen de-icing position, the air conditioning system will start operating automatically when the engine is switched on.

If the air flow control is in the AUTO position, and air recirculation is selected, air conditioning will start automatically in order to prevent condensation on the windows.

When you switch on the ignition, the air conditioning will automatically return to the operating mode it was in when it was last used. If the inside temperature is greatly different from the required temperature displayed and the outside temperature is above 5 °C the air conditioning will switch on automatically regardless of the position of the air flow control.

When the ignition is switched on, if the system had been in air recirculation mode, the system will automatically allow entry of outside air unless the temperature inside the vehicle is over 30 °C.

Important precautions

Operate the air conditioning system for 5 to 10 minutes once or twice a month to keep it in good working order.

It is advisable to change the air conditioning system fluid every 2 years.

If the system is not producing cold air, stop using it and contact a PEUGEOT dealer.

YOUR 306 IN DETAIL

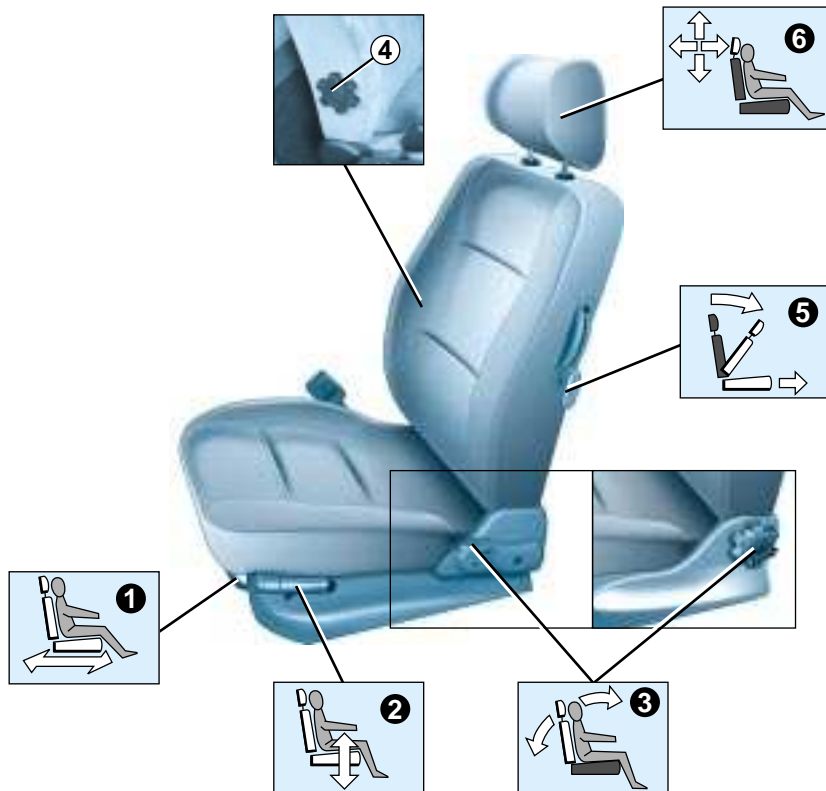

SEATS

1 - Forward-backwards adjustment

Lift the lever and slide the seat forwards or backwards.

2 - Adjusting the driver's seat height

Pull the telescopic handle forwards and pivot it up or down.

3 - Adjusting the seat back angle

Turn the knob to obtain the best angle (4/5-door and estate).

Lift the handle to obtain the best angle (3-door).

4 - Lumbar adjustment*

Turn the knob.

5 - Access to the rear seats (3-door)

Lift the handle, tilt the seat-back and slide the seat forwards. When it slides back, the seat will return to its original position.

6 - Head restraint

Height adjustment: slide the head restraint.

Adjustment is correct when the top of the head restraint is level with the top of the head.

The angle of the head restraint can also be adjusted.

To remove the head restraint, press the tab and pull the head restraint upwards.

* According to specification.

YOUR 306 IN DETAIL

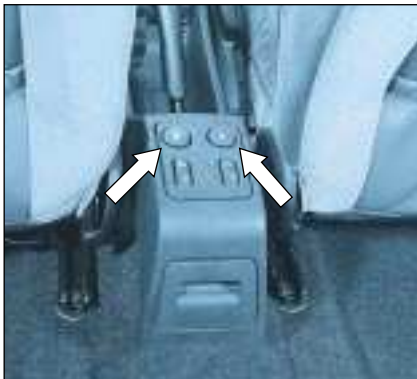

Heated seat controls*

Press the switch.

The temperature is controlled automatically.

Pressing a second time stops operation.



Isofix mounting**

The Isofix mountings available on the two rear seats allow for the installation of **special child seats****, approved by UTAC for Peugeot vehicles and marketed within the network. The fixings are available as an accessory and must be fitted by an approved PEUGEOT dealer.

The locks incorporated in the child seat fit onto the mounting and ensure quick, reliable and safe installation of the seats. The combined use of the seat belt is **compulsory** for a forward-facing child seat.

In the front, it is **compulsory** to fit the child seat in the rear-facing position*** (in this instance it is imperative to disarm the passenger airbag if your vehicle is fitted with one). The forward-facing position is permitted in the rear.

For maximum safety, it is **essential** to adjust the corresponding front seat to the intermediate longitudinal position, seat back upright,

Follow the instructions for fitting the child seat in the leaflet provided when the child seat is purchased.

* According to specification.

** During the model year.

*** According to current legislation.

YOUR 306 IN DETAIL

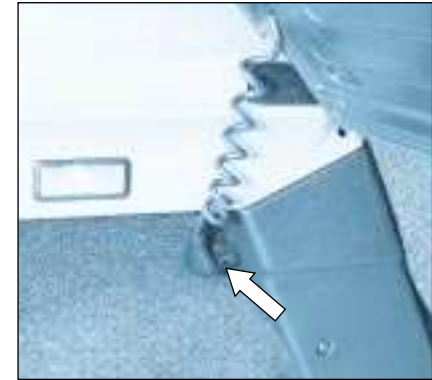
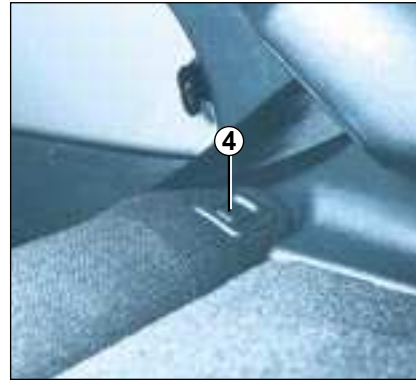
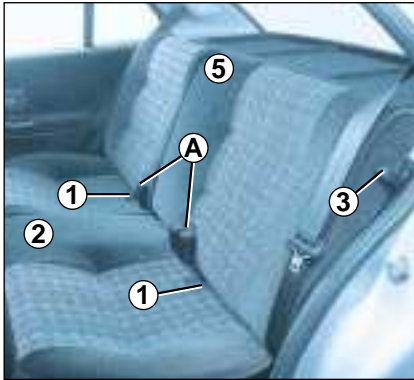

REAR SEATS (3 and 5 doors)

To fold the rear seats:

- insert the seat belt stalks in the hooks **A**.
- pull the strap **1**.
- tilt the seat cushion **2** against the front seats.
- position the seat belt under the lever **3** (5-door) or under the strap guide (3-door).
- unlock the seat back using the controls on the side **3** (5-door) or on the seat back **4** (3-door).
- tilt the seat back **5**.

To tilt the rear seats, always start with the seat cushion, never with the seat back (risk of damage).

When repositioning, take care to avoid trapping the seat belts under the seat cushion or behind the seat back.

To remove the rear seat cushion, tilt the seat cushion through 90° and remove it.

To replace the seat cushion: position it on the front securing plates and lower it into its normal position.

Rear parcel shelf with integral speakers

To remove:

- Turn the speaker connector to the left then disconnect it.
- Unhook the two cords.
- Raise the shelf.
- Remove the shelf.

Storage: turn the shelf over and lay it flat in the boot.

Rear parcel shelf without integral speakers

To remove:

- Unhook the two cords.
- Raise the shelf.
- Remove the shelf.

YOUR 306 IN DETAIL



REAR SEATS (4 door)

To fold the seat back

Insert the seat belt stalks in the hooks. The seat back can be folded in one or two parts*.

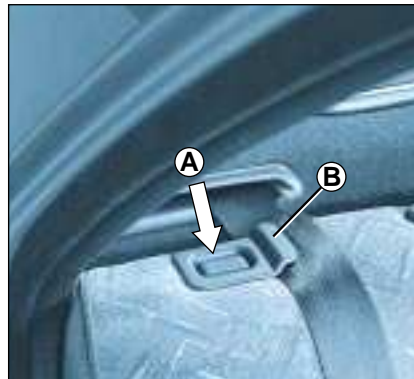

From inside the boot, unlock the control 1.

Position the seat belt under the strap guide **B**.

Unlock the seat back by pressing the button **A**.

Tilt the seat back.

When repositioning, ensure that the seat belts are positioned correctly and that the seat back is secured correctly.

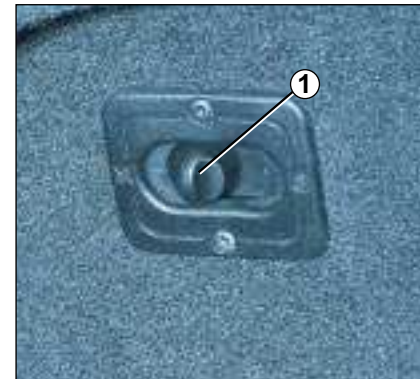

The additional locking control 1 locks the seat back. Access is from inside the boot:

0 : Locking

X : Unlocking

It is essential to lock the seat back to prevent access to the boot from inside the vehicle.

* According to specification.

YOUR 306 IN DETAIL

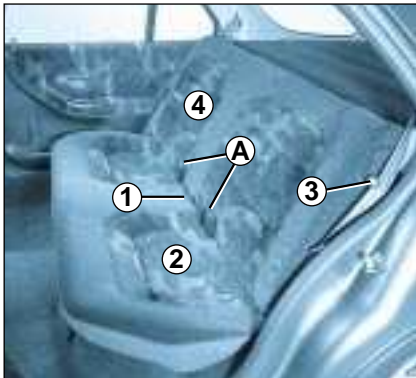

REAR SEATS (estate)

To fold the rear seats:

- Insert the seat belt stalks in the hooks A.
- Pull the strap 1.
- Tilt the seat cushion 2 against the front seats.
- Position the seat belt under the lever 3.
- Unlock the seat back using the controls on the side 3.
- Tilt the seat back 4.

To tilt the rear seats, always start with the seat cushion, never with the seat back (risk of damage).

When repositioning, take care to avoid trapping the seat belts under the seat cushion or behind the seat back.

To remove the rear seat cushion, tilt the seat cushion through 90 degrees and remove it.

To replace the seat cushion: position it on the front securing plates and lower it into its normal position.

Luggage cover

Access to the boot:

- **from the rear:** fold the components like an accordion.
- **from the front (from the rear seats):** raise the part behind the seat back.

Retaining nets*

The lashing points permit the use of a luggage retaining net. A full height load net is also available as an accessory.

* According to specification.

YOUR 306 IN DETAIL

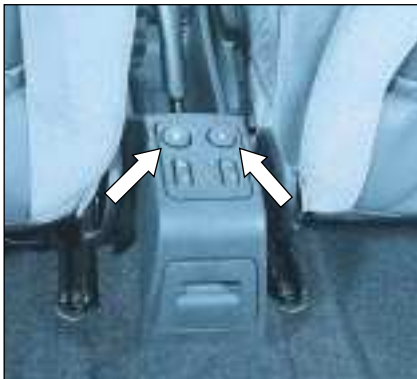

Heated seat controls*

Press the switch.

The temperature is controlled automatically.

Pressing a second time stops operation.



Isofix mounting**

The Isofix mountings available on the two rear seats allow for the installation of **special child seats****, approved by UTAC for Peugeot vehicles and marketed within the network. The fixings are available as an accessory and must be fitted by an approved PEUGEOT dealer.

The locks incorporated in the child seat fit onto the mounting and ensure quick, reliable and safe installation of the seats. The combined use of the seat belt is **compulsory** for a forward-facing child seat.

In the front, it is **compulsory** to fit the child seat in the rear-facing position*** (in this instance it is imperative to disarm the passenger airbag if your vehicle is fitted with one). The forward-facing position is permitted in the rear.

For maximum safety, it is **essential** to adjust the corresponding front seat to the intermediate longitudinal position, seat back upright,

Follow the instructions for fitting the child seat in the leaflet provided when the child seat is purchased.

* According to specification.

** During the model year.

*** According to current legislation.

YOUR 306 IN DETAIL

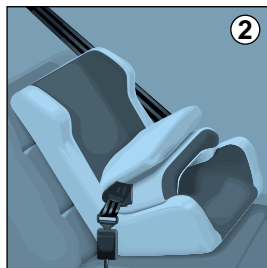

CHILD SEATS

This was one of PEUGEOT's main criteria when designing your vehicle, however the safety of your children also depends on you. For maximum peace of mind, please follow these simple precautions:

All children under the age of 10 are required to travel in approved child safety seats*, fitted with seat belts.

After carrying out numerous tests, PEUGEOT recommend the following systems :

Up to 9 months (up to 22 lbs. or 10 kg)

① «Baby Safe», a seat secured with its back to the engine and secured with a three-point seat belt, on either the front or rear seat.

From 9 months to 3 or 4 years (20 to 40 lbs. or 9 to 18 kg)

② «Römer Peggy» is fitted to the rear seat with a two-point (lap-belt) or three-point belt.

From 3 to 10 years of age (33 to 80 lbs or 15 to 36 kg)

③ «Klippan Optima» : is fitted in the rear with a three point belt (removable seatback).

from 33 to 55 lbs. [15 to 25 kg] : booster + seatback.

from 55 to 80 lbs. [25 to 36 kg] : use the booster on its own.

For maximum safety, fasten the three-point seat belts or the child seat straps keeping the slack in relation to the child's body to a minimum, even for short journeys.

To prevent the doors from opening accidentally: use the child-proof lock.

Also, do not open the rear windows more than a third.



Never leave a child in a vehicle which is exposed to the sun and has the windows closed.

To protect young children from the sun, fit sunblinds to the rear windows.

Never leave the keys in the reach of children inside the car.

Strap children into their child seats even on short journeys.



Observe the precautions concerning the passenger airbag.

YOUR 306 IN DETAIL



SAFETY: SEAT BELTS

To adjust the height of the front seat belts

Pull the knob 1 and slide it.

To lock the seat belts

Pull the strap, then insert the end into the buckle.

Pre-tensioning and force-limiting front seat belts*

Safety in the event of a frontal impact has been improved by the introduction of pre-tensioning and force-limiting front seat belts. Depending on the seriousness of the impact, the pre-tensioning system instantly tightens the seat belts firmly against the body of the occupant.

The pre-tensioning seat belts are armed when the ignition is on.

The force-limiting device reduces the pressure of the seat belt against the occupant's body in the event of an accident.

Rear seat belts

4-door: the rear seats are fitted with 3 three-point inertia reel seat belts.

3/5-door, estate: The rear seats are fitted with 2 three-point inertia reel seat belts and one lap belt.

Use the buckle retaining hooks when the rear seats are not occupied.



To be effective, a seat belt must be tensioned as close to the body as possible.

Depending on the nature and seriousness of the impact the pre-tensioning system may be triggered before and independently of the airbags.

In all cases, the airbag warning light comes on.

Following an impact, have the system checked by a PEUGEOT dealer.

The system has been designed to be fully operational for ten years.

Have it replaced at the end of this period.

* According to specification.

YOUR 306 IN DETAIL



KEYS

Without central locking

The key individually locks and unlocks the doors and boot or tailgate.

With central locking

Turning the key in the driver's door lock will lock or unlock the doors and boot or tailgate. If either of the front doors is not closed, the central locking will not work.

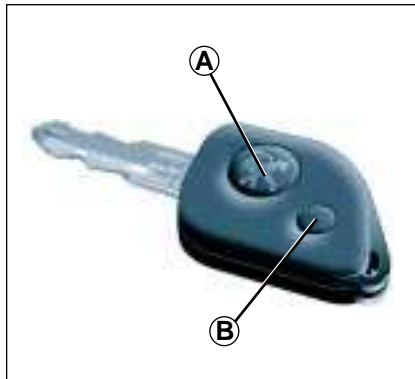

THE REMOTE CONTROL

A single press on button **A** locks the doors and boot or tailgate, this is displayed by the direction indicators staying on for about 2 seconds.

A single press on button **B** unlocks the vehicle, this is displayed by the direction indicators flashing rapidly.

Note: do not repeatedly press the button of your remote control out of range of your vehicle. You risk causing it not to work and the remote control would have to be reprogrammed.

CHANGING THE REMOTE CONTROL BATTERIES

To gain access to the battery, unclip the key casing with a coin where you can see the ring (CR1620/3 volt battery).

If the remote control does not work after the battery has been changed, re-programme the remote control.

PROGRAMMING THE REMOTE CONTROL

Manual synchronisation

- Switch off the ignition,
- Switch on the ignition,
- Immediately after switching on the ignition press button **A**.

The remote control is now working again.

Automatic synchronisation

- Switch on the ignition (position **M**),
- Switch off the ignition and, during the next four minutes, lock the vehicle using the remote control (button **A**).

The remote control is now working again.

YOUR 306 IN DETAIL

DOORS

Opening the doors from outside



Opening the doors from inside

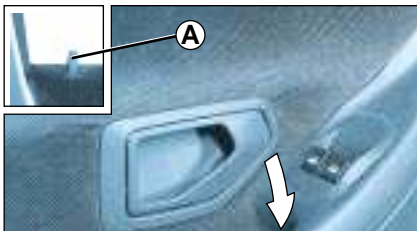

LOCKING FROM INSIDE THE VEHICLE

Without central locking

To lock, press button **A**. The button locks that door.

With central locking

To lock, press button **A**.

Locking the driver's door locks the front and rear doors and the tailgate.

On the other doors the button only locks that door.



Take careful note of the numbers on the keys.

The key number is coded on the label attached to the key. If the key is lost your PEUGEOT dealer can rapidly supply you with new keys or a remote control.

As a safety precaution (with children on board) remove the ignition key when you leave the vehicle, even for a short time.

The high frequency remote control is a high-performance system which has a powerful beam. Therefore do not operate it while it is in your pocket as there is a possibility that it may unlock your vehicle.



Locking or unlocking the boot or tailgate

3 or 5 door without central locking

Turn the key in the tailgate lock.

4 door or estate

Using the key: turn the key in the boot or tailgate lock.

Using the remote control*: the boot or tailgate locks and unlocks at the same time as the doors.

Locking the boot only (4 door)

Turn the key to the right in the boot lock.

The boot will be locked whatever the action of the remote control or the driver's door lock.

To open, turn the key to the left in the boot lock. The boot will then be locked at the same time as the central locking of the doors.

The seat back locking control enables you to prevent unauthorised entry to the boot, even if the doors are open.



Locking or unlocking the boot or tailgate

3 or 5 door with central locking

The tailgate locks and unlocks at the same time as the doors.

Tailgate release

In the event of a central locking operating fault, this enables the tailgate to be unlocked:

- fold the rear seats to gain access to the control from inside the vehicle.
- Insert the ignition key in the opening and slide it to unlock the tailgate.



Child lock

This prevents opening of the rear doors from inside the vehicle.

Turn control **1** a quarter turn using the ignition key.

It is still possible to open the doors from outside the vehicle.

* According to specification.

YOUR 306 IN DETAIL



Tilt and slide electric sun roof*

Open the cover.

To open

Press the rear part of the switch 1.

To close

Press the front part of the switch 1.

To tilt

Press the front part of the switch 1.

To close, press the rear part of the switch 1.

Tilting manual sun roof

Tilt the handle.



Bonnet

Inside the vehicle: Pull the handle.



Outside the vehicle

Raise the catch 1 and support the bonnet as it rises.

* According to specification.

YOUR 306 IN DETAIL



Fuel filler flap

To open*: firmly pull the handle on the floor to the outside of the driver's seat.

To close: from outside, push the flap back and check that it is secured correctly.



Filling with fuel

Switch off the engine.

There is a holder for the fuel filler cap.

A label on the inside of the flap shows which fuels are permitted and which are not allowed.

The capacity of the tank is approximately 13 gallons (60 litres).

Use the ignition key to open and close the fuel filler cap independently of opening the doors.

* According to specification.

YOUR 306 IN DETAIL

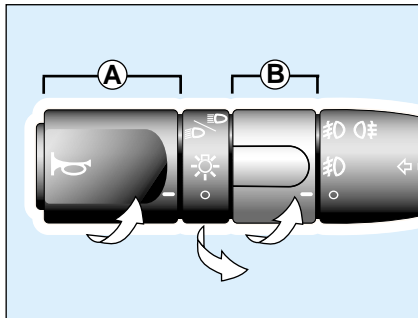

LIGHTING CONTROL

Front lights

Selection is by turning ring A.



Lights off.



Side lights on.



Dipped beam/main beam.

Dipped beam/main beam change

Pull the stalk fully towards you.

Note: when the ignition is switched off, if the driver's door or front passenger door* is left open, a buzzer sounds if you forget that you have left your lights on.

Front and rear fog lights

To switch on, turn the ring. The position is confirmed by the light on the instrument panel.

Front and rear (ring B)



Lights off.



Front fog lamps on.

These operate with the side lights and the dipped/main beam headlamps.



Front and rear fog lamps on.

These operate with the side lights and the dipped/main beam headlamps. When the side lights are switched off, there is a return to the front fog lamps only position.



Direction indicators (flashers)

Left : downwards.

Right : upwards.



Horn

Press the end of the lighting stalk.

* According to specification.

YOUR 306 IN DETAIL

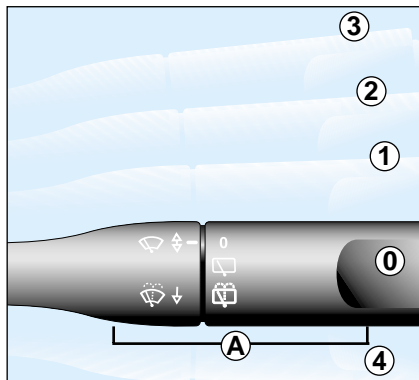

WINDSCREEN WIPERS

Front windscreen wipers

- 3 Fast wipe.
- 2 Normal wipe.
- 1 Intermittent or automatic wipe.
- 0 Park.
- 4 Single wipe.

Windscreen and headlight wash*

Pull the wipers stalk towards you.
The headlamp wash works if the dipped or main beam headlamps are on.

Automatic windscreen wiper*

In position 1, the wipers operate automatically and adjust their speed to the rainfall.

After switching off the ignition or after starting, this function must be re-set, so the sensor can detect the condition of the windscreen.

To do this, change the stalk position :

- from 1 to 0 then back to 1 (confirmed by a single wipe),
- change from 1 to 2, then back to 1 (confirmed by two wipes).



Rear screen wiper (estate)

Turn ring A to the first notch, for intermittent wiping.



Rear screen wash (estate)

Turn ring A beyond the first notch.



In good weather or in rain, both day and night, if the rear fog lamp is lit it causes glare and is prohibited.

Do not forget to switch it off as soon as it is no longer needed.

Do not cover the rain detector located on the windscreen behind the interior mirror.

When using an automatic car wash, switch off the ignition or check that the wiper control is not in the automatic position.

In winter it is advisable to wait for the windscreen to completely clear of ice before operating the automatic wipe.

* According to specification.

YOUR 306 IN DETAIL

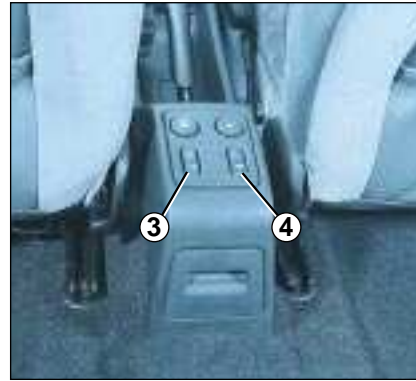
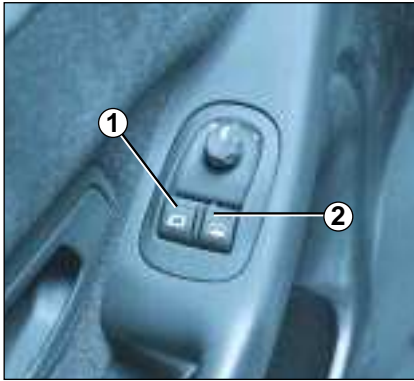

Electric windows*

1. Driver's electric window control

You have two options*:

Manual operation: Push or pull switch **1**, lightly. The window stops when the switch is released.

Automatic operation: Push or pull switch **1** firmly. Pressing once opens or closes the window completely. Automatic opening and closing operate only when the engine is switched on.

2. Passenger electric window control.

Push or pull switch **2**. The window stops when the switch is released.

3. Left rear electric window control.

4. Right rear electric window control.

Temporary locking of the rear windows (child safety) control

This allows the rear windows to be locked in any position.

NOTE: as a safety measure (children on board), remove the ignition key when leaving the vehicle even for a short time.

* According to specification.

YOUR 306 IN DETAIL

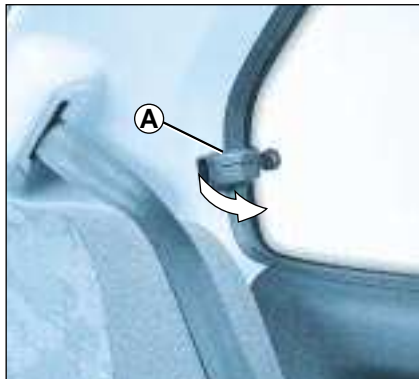

Tilting windows (3-door)

To open the rear side windows, tilt the lever **A** and push the window outwards.

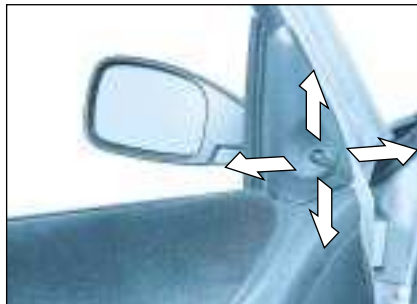

Manual mirrors

Operate the adjusting lever in all four directions to adjust.

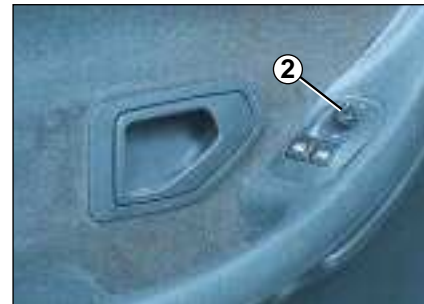

Electric mirrors

Turn the control **2** to the right or to the left to select the corresponding mirror. Move the control **2** in all four directions to adjust.

When parked, the mirrors can be folded back manually.



The driver's mirror is "non-spherical" in order to reduce the "blind spot". As a result, objects observed in the mirror are closer than they appear. This must be taken into account to correctly judge the distance of vehicles approaching from the rear.*

** According to country.*

YOUR 306 IN DETAIL

Athermic windscreen*

The windscreen has two non-reflective zones located either side of the base of the interior rear-view mirror. These are for affixing toll cards or parking passes.

Note : the athermic glass reduces the effect of the sun's rays, by limiting the heating of the passenger compartment, but its reflective coating blocks radio signals.

**Rear screen blind (4 door)***

Pull the blind by the central tab then position the hooks in the locations. Support it as it returns.

**Storage compartments (estate)**

There are two storage compartments, fitted with elastic retaining straps, behind the boot side trims.

To gain access to a storage compartment, pull the handle towards you.

* According to specification.

YOUR 306 IN DETAIL

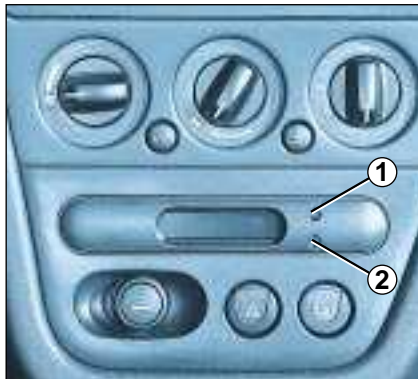

Digital clock*

Setting:

- 1 - Adjusting of hours.
- 2 - Adjusting of minutes.

Outside temperature display*

This indicates the outside temperature. When the temperature is between minus 3 °C and + 5 °C, the °C symbol flashes indicating a risk of ice.



Hazard warning lights

The switch and the direction indicators flash.

This controls the indicator lights simultaneously and continuously.

Only use in case of danger, in an emergency stop or for driving in unusual conditions.

They can operate with the ignition off.



Rear screen demisting

Rear screen (and mirrors)* electric demisting control.

Goes out automatically after approximately 12 minutes to avoid excessive power consumption.

Pressing the button again will operate the demisting for another 12 minutes.

* According to specification.

YOUR 306 IN DETAIL



Lighter

Press and wait a few moments until it pops out automatically.



Front ashtray

To empty:

- open and pull the unit.

To replace:

- push in fully.

Rear ashtray

To empty, open and pull towards you.

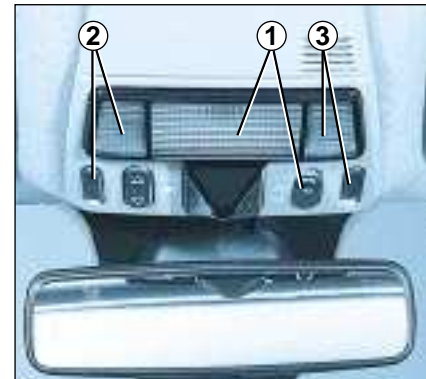

Front and rear courtesy lights



Off.



Gradual illumination on opening or closing a door.



Lights permanently on with the key in the accessories position or with the ignition on.

1 - Front courtesy light.

2 - Left map-reading light.

3 - Right map-reading light.

With the key in the accessories or ignition on position, press the corresponding switch.

DRIVING YOUR 306

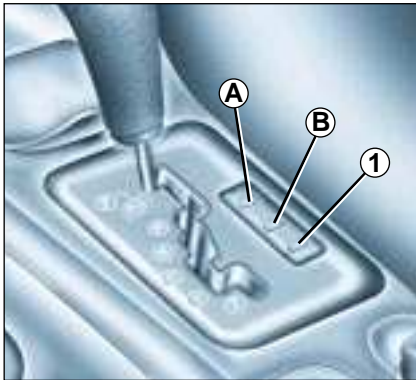

AUTOMATIC AUTOADAPTIVE GEARBOX

Starting

To start the engine, put the selector lever in **N** or **P**.

Press the brake pedal when starting the engine and to exit position P.

Positions of the selector lever

These positions are displayed on the instrument panel.

- P.** Park: use with the handbrake when parked.
- R.** Reverse: this must only be engaged when the vehicle is stationary and the engine idling.
- N.** Neutral: if **N** is engaged by mistake while the car is moving, allow the engine to return to idling speed before engaging a new forward gear.
- D.** Drive: in this position, the four gear ratios change automatically. The gear change points vary depending on the programme selected.
- 3.** Automatic changes of the first three gears only.

Select this position when you notice frequent changes between third and fourth gear (town driving or on winding roads).

- 2.** Automatic changes of the first two gears only.

This position is particularly suitable for mountain roads, when going uphill (to make the best use of the engine's power) and downhill (engine braking).

- 1.** Selection of first gear only.

For use on steep gradients, especially when towing a trailer.

Selection of first gear is by pressing switch **1** with the lever in position **2**.

To exit position **1**, press switch **1** again or move the selector lever.

Operating programmes

You have a choice of three operating programmes:

- Auto-adaptive (normal).
- Sport.
- Snow.

One press on button **A** or **B** will select Sport or Snow respectively. The selection is displayed on the instrument panel. Pressing the button a second time will return to the auto-adaptive (normal) programme.

Auto-adaptive programme (normal)

Gear changes are carried out on the basis of various parameters, such as:

- driving style,
- road characteristics,
- the vehicle's load.

The gearbox continuously scans the different programmes in the memory and selects the one most suitable for the driving conditions at any given moment.

Sport programme

The Sport programme favours performance for sporty driving and more dynamic acceleration.

Snow Programme

In position **D** the Snow programme provides smooth driving suited to slippery roads in order to improve traction and stability. Starting is in 2nd gear and changing down is at low engine speeds.

Special operating features

- During prolonged braking, the gearbox changes down automatically, so as to provide efficient engine braking.
- If you take your foot off the accelerator suddenly (when you are taken by surprise, for example), the gearbox will not change up, so as to improve safety.
- When the engine is cold, the gearbox automatically selects a special programme which enables the engine to reach its ideal temperature more quickly to decrease pollution.

Kickdown

For immediate maximum acceleration without touching the gear lever, press the accelerator pedal down as far as it will go. The gearbox will change down automatically or stay in the gear selected, up to maximum engine speed.



Any disruption of the system is signalled by the simultaneous flashing of the Sport and Snow lights on the instrument panel. In

*such a case, the gearbox will operate in downgraded mode. You may feel a substantial knock when reverse is selected from **P** or **N** (without any risk of damage to the gearbox).*

Do not exceed 60 m.p.h. (100km/h).

Contact a PEUGEOT dealer without delay.

When the engine is idling with the car in gear, the car will move even without you accelerating.

Do not accelerate while a gear is being selected, when the vehicle is stationary.

When stationary, have your foot on the brake pedal when selecting a gear.

Do not accelerate in gear with the brakes on.

*If work needs to be done with the engine running, apply the hand-brake and select position **P**.*

Do not change down to brake on slippery roads.

*Never select position **N** when the vehicle is moving.*

*Never engage **P** or **R** if the vehicle is not stationary.*

Do not allow children inside the vehicle unsupervised when the engine is running.

DRIVING YOUR 306

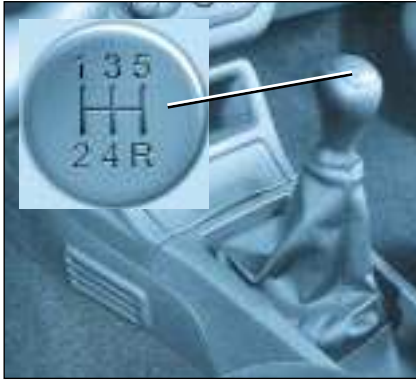

Manual gearbox

The positions are indicated on the gear lever knob.

Reverse gear can only be engaged from neutral when the vehicle is stationary, with the engine idling.

Special features of the six speed gearbox*

Raise the lock ring under the knob before engaging reverse.



Handbrake

Application

When you have parked the vehicle, pull up the handbrake to apply it.

To ease application and release of the handbrake, press the brake pedal and pull up the handbrake with the engine running.

Release

Press the button before releasing the handbrake.

THE ABS ANTI-LOCK BRAKING SYSTEM*

In conjunction with tyres of an approved make and in good condition, the ABS system with electronic brake force distribution improves the stability and handling of your vehicle, particularly on an uneven or slippery surface.

The anti-lock braking system comes into operation automatically when there is a risk of wheel lock.

In the event of emergency braking, press very firmly without reducing the pressure. In some conditions the normal operation of the ABS may be felt as vibrations of the brake pedal.

Power steering

This is a comfort device which offers the best compromise for parking, and for driving at high speeds.

* According to specification.

AIRBAGS

The airbag system has been designed to maximise the safety of the occupants in the event of serious collisions. It works in conjunction with the seat belts.

The electronic detectors register and analyse any abrupt deceleration of the vehicle; if the triggering threshold is reached the airbags inflate instantly and come between the occupants and the vehicle.

Immediately after the impact, the airbags deflate rapidly, so that they do not hinder the visibility of the occupants and their exit if necessary from the vehicle.

The airbags are not deployed in the case of collisions which are not serious, for which the seat belt is sufficient to ensure maximum protection. The seriousness of a collision depends on the nature of the obstacle and the speed of the vehicle at the moment of the collision.

Airbags only operate when the ignition is switched on.

Note: the gas escaping from the airbags can be a minor irritant.

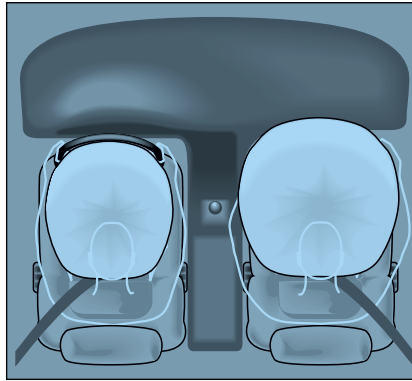

FRONT AIRBAGS*

These are folded in the centre of the steering wheel for the driver and in the fascia for the front passenger. They are deployed simultaneously (except in cases where the airbag is disarmed), for frontal impacts where there is a risk of injury to the head or chest.



DISARMING THE PASSENGER AIRBAG*

To ensure the safety of your child, it is essential to disarm the passenger airbag when you install a rearwards-facing child seat on the front passenger seat.

Remove the ignition key, insert it into the passenger airbag switch 1 and turn it to the "OFF" position.

**AIR
BAG**



One of these two warning lights* on the instrument panel is lit throughout the disarming procedure.

* According to specification.

DRIVING YOUR 306

In the “OFF” position, the passenger airbag will not be triggered in the event of an impact.

As soon as you remove the rearwards-facing child seat from the front passenger seat, turn the airbag switch to the “ON” position, to arm the airbag and thus ensure the safety of your passenger in an impact.

Passenger airbag precautions

Vehicle fitted with a passenger airbag disarming switch:



- disarm the airbag if you install a rearwards-facing child seat on the front passenger seat,
- arm the airbag when you transport an adult on the front passenger seat.

Vehicle not fitted with a passenger airbag disarming switch:



- do not install a rearwards-facing child seat on the front passenger seat.

Never place your feet or any object on the fascia.

Operating check

It is indicated by one of the lights on instrument panel.

If the passenger airbag is armed (passenger airbag switch in the “ON” position), the light will come on for 6 seconds when the ignition is switched on.

If the passenger airbag is disarmed (passenger airbag switch in the “OFF” position), the light will stay on.



Only the airbag warning light remains on,

or,



the airbag warning light comes on for six seconds after the ignition is switched on and the airbag disarming light remains on permanently.



In any case, if the light flashes, contact a PEUGEOT dealer.

* According to specification.

SIDE AIRBAGS*

These are incorporated into the front seat back frame on the door side.

They are deployed independently of each other depending on which side the collision occurs, in collisions which could cause injury to the chest, the abdomen or the head.

**Operating check**

This is indicated by one of the lights on the instrument panel.

It comes on for 6 seconds, each time the ignition is switched on.

If one of the switches:

- does not light up when the ignition is switched on, or,
 - does not go out after 6 seconds or,
 - flashes for 5 minutes then stays on,
- contact a PEUGEOT dealer.

* According to specification.

** During model year and depending on model.

DRIVING YOUR 306



WARNING

For the front and side airbags to be fully effective, observe the following safety rules:

- *Wear a correctly adjusted seat belt.*
 - *Sit in a normal upright position.*
 - *Do not leave an accessory, or any other object between the occupants of the front seats and the airbags. It could hamper the operation of the airbags or injure the occupants.*
 - *All work on the airbag system is strictly forbidden unless it is carried out by qualified personnel of the PEUGEOT network.*
 - *After an accident or if the vehicle has been stolen or broken into, have the airbag systems checked.*
 - *The airbag systems have been designed to be fully operational for 10 years after the vehicle has been registered. Have them checked by a PEUGEOT dealer at this time.*
- **Front air bags***
- *Do not drive holding the steering wheel by its spokes or resting your hands on the centre part of the wheel.*
 - *Smoke as little as possible; deployment of the airbags can cause burns or the risk of injury from a cigarette or pipe.*
 - *Never remove or pierce the steering wheel or hit it violently.*
- **Side air bags***
- *Fit only approved covers to the front seats.*
 - *Do not fix or glue anything to the front seat backs. This could cause injury to the chest or arms when the side airbag inflates.*
 - *Do not sit with the upper part of the body any nearer to the door than necessary.*

** According to specification.*

SIDE AIRBAGS*

These are incorporated into the front seat back frame on the door side.

They are deployed independently of each other depending on which side the collision occurs, in collisions which could cause injury to the chest, the abdomen or the head.

**Operating check**

This is indicated by one of the lights on the instrument panel.

It comes on for 6 seconds, each time the ignition is switched on.

If one of the switches:

- does not light up when the ignition is switched on, or,
 - does not go out after 6 seconds or,
 - flashes for 5 minutes then stays on,
- contact a PEUGEOT dealer.

* According to specification.

** During model year and depending on model.

DRIVING YOUR 306



WARNING

For the front and side airbags to be fully effective, observe the following safety rules:

- *Wear a correctly adjusted seat belt.*
 - *Sit in a normal upright position.*
 - *Do not leave an accessory, or any other object between the occupants of the front seats and the airbags. It could hamper the operation of the airbags or injure the occupants.*
 - *All work on the airbag system is strictly forbidden unless it is carried out by qualified personnel of the PEUGEOT network.*
 - *After an accident or if the vehicle has been stolen or broken into, have the airbag systems checked.*
 - *The airbag systems have been designed to be fully operational for 10 years after the vehicle has been registered. Have them checked by a PEUGEOT dealer at this time.*
- **Front air bags***
- *Do not drive holding the steering wheel by its spokes or resting your hands on the centre part of the wheel.*
 - *Smoke as little as possible; deployment of the airbags can cause burns or the risk of injury from a cigarette or pipe.*
 - *Never remove or pierce the steering wheel or hit it violently.*
- **Side air bags***
- *Fit only approved covers to the front seats.*
 - *Do not fix or glue anything to the front seat backs. This could cause injury to the chest or arms when the side airbag inflates.*
 - *Do not sit with the upper part of the body any nearer to the door than necessary.*

** According to specification.*

MAINTENANCE OF YOUR 306

1.4 litre and 1.6 litre petrol engine

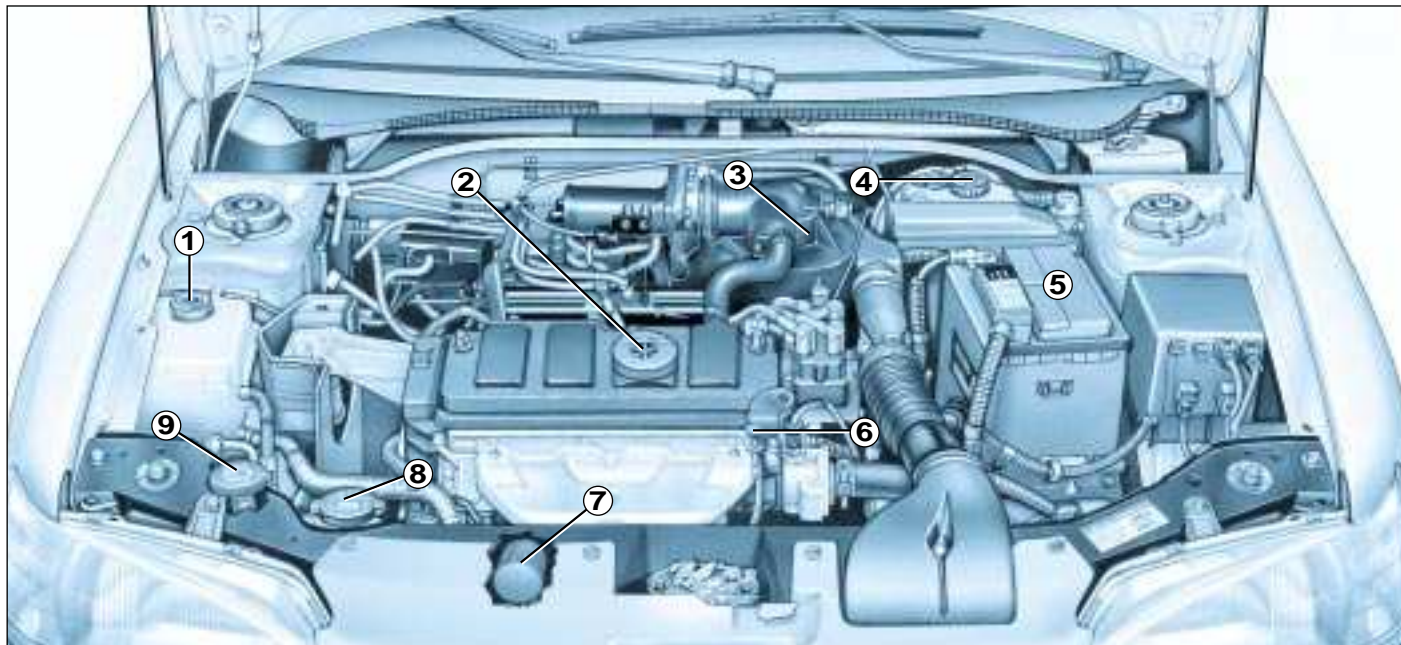

1 Power steering fluid reservoir*.

2 Engine oil filler cap.

3 Air filter.

4 Brake fluid reservoir.

5 Battery.

6 Engine oil dipstick.

7 Oil filter.

8 Coolant reservoir.

9 Screenwash reservoir.

* According to specification.

MAINTENANCE OF YOUR 306

1.8 litre and 2 litre 16V petrol engine

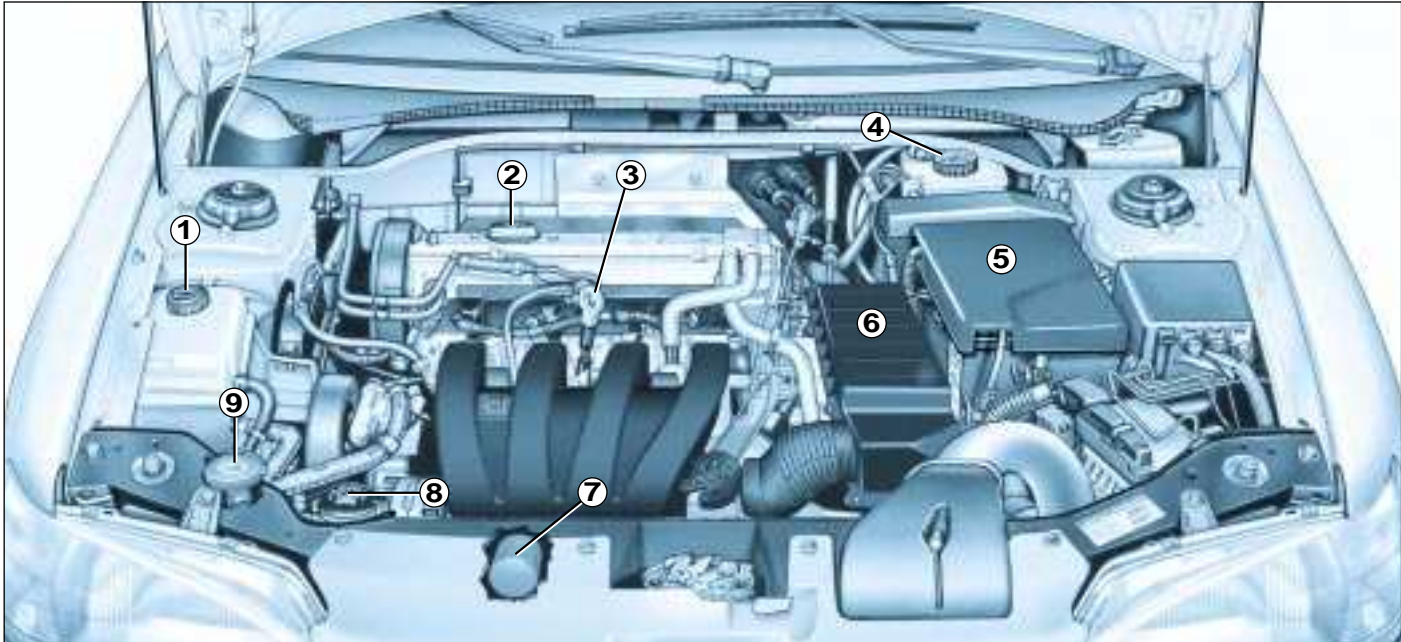

- 1 Power steering fluid reservoir*.
- 2 Engine oil filler cap.
- 3 Engine oil dipstick.

- 4 Brake fluid reservoir.
- 5 Battery.
- 6 Air filter.

- 7 Oil filter.
- 8 Coolant reservoir.
- 9 Screenwash reservoir.

* According to specification.

MAINTENANCE OF YOUR 306

1.9 litre diesel engine

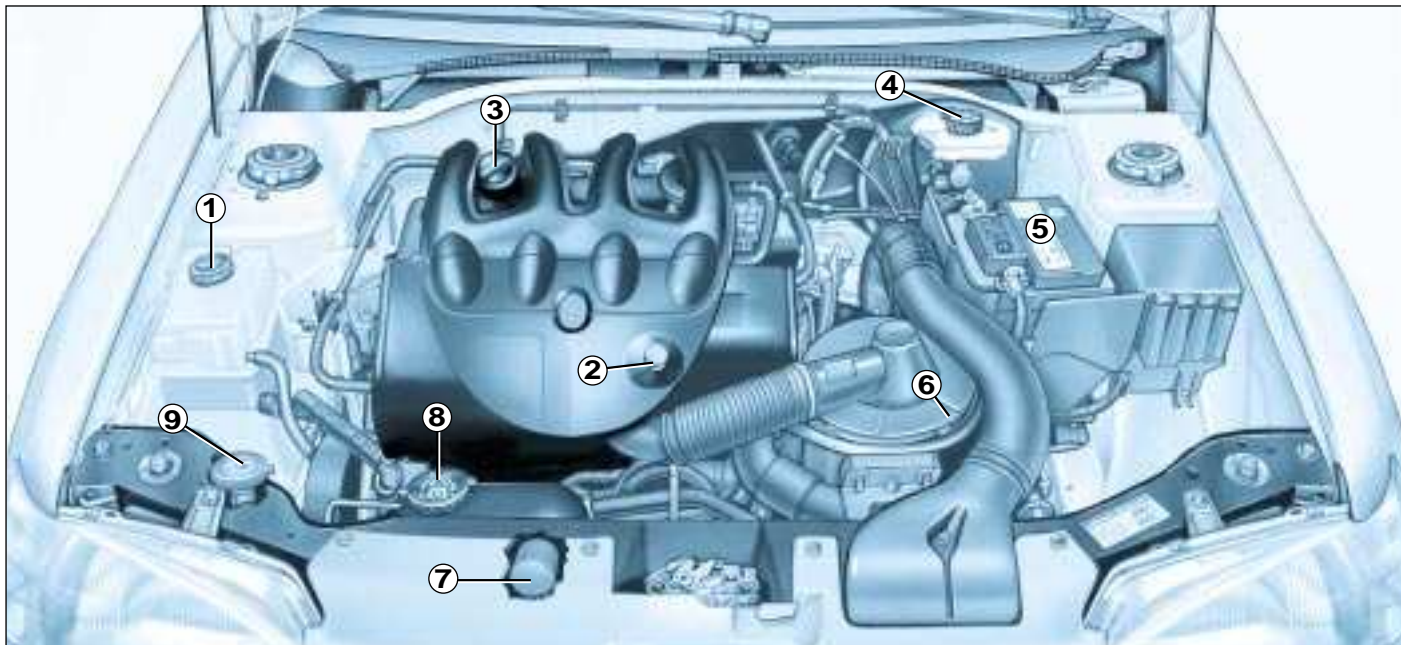

- 1 Power steering fluid reservoir*.
- 2 Engine oil dipstick.
- 3 Engine oil filler cap.

- 4 Brake fluid reservoir.
- 5 Battery.
- 6 Air filter.

- 7 Oil filter.
- 8 Coolant reservoir.
- 9 Screenwash reservoir.

* According to specification.

MAINTENANCE OF YOUR 306

2 litre HDI turbo diesel engine

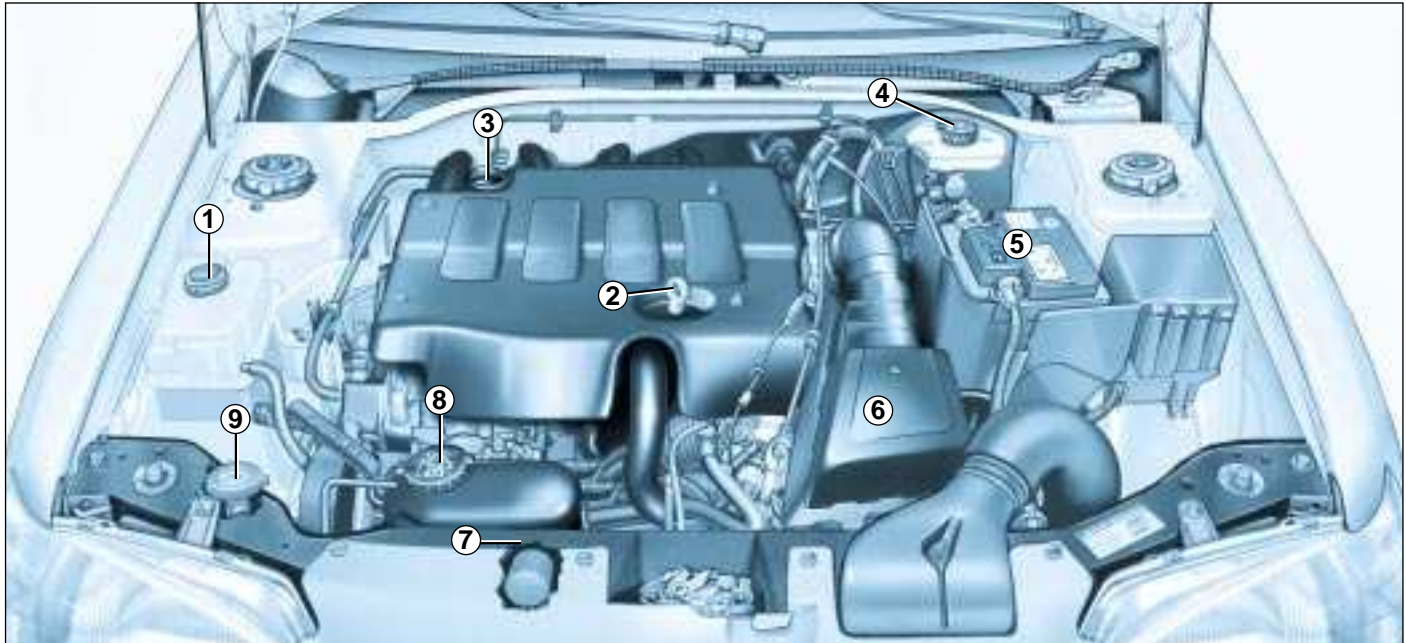

- 1 Power steering fluid reservoir*.
- 2 Engine oil dipstick.
- 3 Engine oil filler cap.

- 4 Brake fluid reservoir.
- 5 Battery.
- 6 Air filter.

- 7 Oil filter.
- 8 Coolant reservoir.
- 9 Screenwash reservoir.

* According to specification.

MAINTENANCE OF YOUR 306

CHECKING THE LEVELS

Engine

Checking the oil level

Check the level regularly and top up between changes (maximum consumption is 0.5 litres per 600 miles (1,000 km)).

The oil level should be checked with the vehicle level, engine cold.

There are two marks on the dipstick:

A = maximum.

B = minimum.

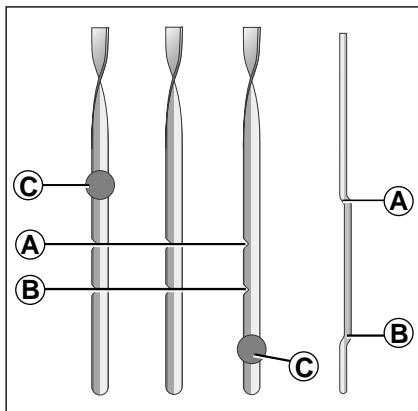

Item C : Dipstick guide.

Oil change: according to the manufacturer's servicing schedule.

- Dipstick. Never fill past the maximum mark **A**.
- Oil level gauge on the instrument panel.

Viscosity selection

In all cases, the oil selected must meet the manufacturer's requirements.

Oil filter

Change the filter regularly in accordance with the maintenance schedule.

Used oil

Prevent used oil from coming into prolonged contact with the skin.

Do not dispose of used oil into drains or into the ground.

To maintain the reliability of engines and emission control systems, the use of additives in the engine oil is prohibited.

Brake fluid reservoir

Checking the brake and clutch fluid level :

- The level should always be above the DANGER mark on the reservoir.
- If the level drops substantially, contact a PEUGEOT dealer immediately.

Fluid change

- must be carried out according to the manufacturer's schedule.
- use fluids approved by the manufacturer, which fulfil DOT4 standards.

Coolant reservoir

Use the fluid approved by the manufacturer.

When the engine is warm, the temperature of the coolant is controlled by the engine fan: because this fan can operate with the ignition key removed, and because the cooling system is pressurised, wait for at least one hour after the engine has stopped before carrying out any work.

If necessary, in a breakdown, slacken the cap to the first notch to release the pressure to prevent any risk of scalding. When the pressure has dropped remove the cap and top up the level.

MAINTENANCE OF YOUR 306

Power steering reservoir

Open the reservoir, with the engine cold, at outside temperature, the level should always be above the MINI mark, close to the MAXI mark.

Windscreen and headlamp wash reservoir*

For best quality cleaning and for your safety, we recommend that you use products approved by PEUGEOT (capacity 4,4 litres or 6 litres with headlight wash).

Battery

At the start of winter, have your battery checked by a PEUGEOT dealer.

Air filter

Regular replacement of the filter element is essential. If you drive in very dusty conditions, change it twice as often.

Brake pads

Brake pad wear depends on the style of driving, in particular for vehicles which are used in town or for short journeys or which are driven in a sporty manner, it may be necessary to check the thickness of the pads even between services.

Manual gearbox

This does not need an oil change. Check the level according to the manufacturer's service schedule.

Autoadaptive automatic gearbox

This does not need an oil change: have the level checked by a PEUGEOT dealer according to the manufacturer's service schedule.



Only use products approved by Automobiles PEUGEOT.

To ensure best performance from components as important as the power steering and the braking system, PEUGEOT selects and offers quite specific products.



Fuel supply cut-off*

In a serious collision, a system prevents fuel from reaching the engine.

To re-establish the fuel supply, press the switch on the angle of the front left-hand suspension assembly, under the bonnet.

* According to specification.

MAINTENANCE OF YOUR 306

Power steering reservoir

Open the reservoir, with the engine cold, at outside temperature, the level should always be above the MINI mark, close to the MAXI mark.

Windscreen and headlamp wash reservoir*

For best quality cleaning and for your safety, we recommend that you use products approved by PEUGEOT (capacity 4,4 litres or 6 litres with headlight wash).

Battery

At the start of winter, have your battery checked by a PEUGEOT dealer.

Air filter

Regular replacement of the filter element is essential. If you drive in very dusty conditions, change it twice as often.

Brake pads

Brake pad wear depends on the style of driving, in particular for vehicles which are used in town or for short journeys or which are driven in a sporty manner, it may be necessary to check the thickness of the pads even between services.

Manual gearbox

This does not need an oil change. Check the level according to the manufacturer's service schedule.

Autoadaptive automatic gearbox

This does not need an oil change: have the level checked by a PEUGEOT dealer according to the manufacturer's service schedule.



Only use products approved by Automobiles PEUGEOT.

To ensure best performance from components as important as the power steering and the braking system, PEUGEOT selects and offers quite specific products.



Fuel supply cut-off*

In a serious collision, a system prevents fuel from reaching the engine.

To re-establish the fuel supply, press the switch on the angle of the front left-hand suspension assembly, under the bonnet.

* According to specification.

MAINTENANCE OF YOUR 306

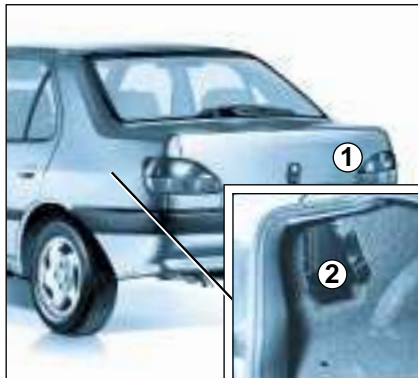

CHANGING A WHEEL

Jack location

Petrol and Diesel

3 or 5 door: the jack is in the boot **2**. Rear crossbar (right side). Press the tab and open the storage box to remove it.

4 door: the jack is in the left-hand side of the boot.

Estate: the jack is in the right-hand storage compartment of the boot.

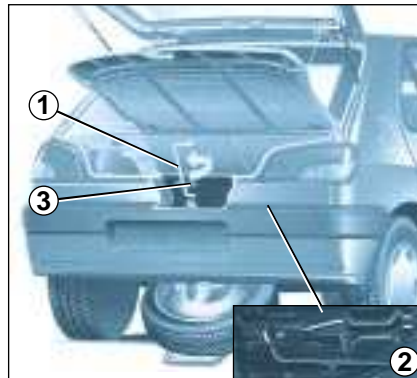

Access to the spare wheel

The wheel is on the outside of the vehicle, under the boot, supported by a metal carrier.

Take out the wheelbrace **1**.

Using the wheelbrace **1**, unscrew the spare wheel carrier securing bolt located under the carpet in the boot.

Raise the carrier to release the hook rearwards, then lower the carrier.

Release the spare wheel.

MAINTENANCE OF YOUR 306

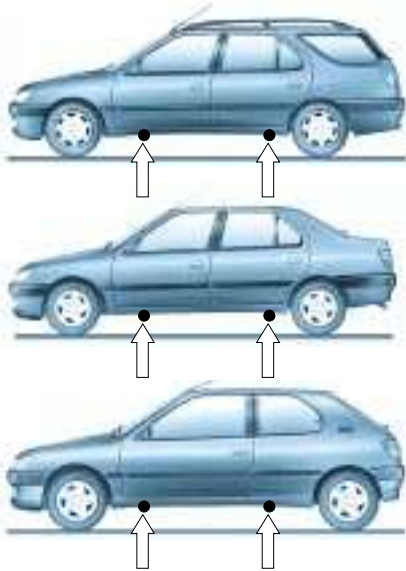

Removing the wheel

Park the vehicle on level, stable and non-slippery ground.

Apply the handbrake, engage first gear or reverse (position **P** for the automatic gearbox).

Remove the wheel trim by using the wheelbrace and pulling next to the valve.

Warning: your wheel trims are fitted with dummy nuts. Do not use them to remove your wheel trims.

4-door: Use the jack storage box to chock the wheel diagonally opposite the wheel to be changed.

Loosen the wheel bolts.

Place the jack in the location designed for it, as close as possible to the wheel to be changed.

Ensure that the whole of the base of the jack is in contact with the ground.

Extend the jack, fully loosen the wheel bolts and remove the wheel.

To fit the wheel

After positioning the wheel, pre-tighten the bolts using the wheelbrace.

Lower the jack and remove it.

Fully tighten the wheel bolts using the wheelbrace.

Fit the wheel trim starting with the section by the valve and press into place using the palm of the hand.

Refitting the wheel in the carrier

Raise the wheel, then the carrier, and resecure it on the hook.

Do not forget to fully tighten the spare wheel carrier securing bolt.



For your safety, always change the wheel:

- on level, stable and non-slippery ground,
- with the handbrake applied,
- with first gear or reverse engaged (position **P** for the automatic gearbox).

Never go underneath a vehicle which is supported only by a jack. (Use a ramp).

After changing the wheel:

- have the tightening of the bolts and the tyre pressure checked by a PEUGEOT dealer as soon as possible,
- have the punctured wheel repaired and refit it to the vehicle as soon as possible.

MAINTENANCE OF YOUR 306

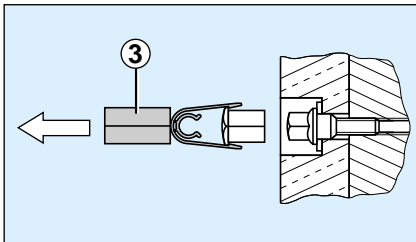

Special features of the alloy wheels*

Bolt covers

Alloy wheel bolts are covered by chrome trims.

Use tool 3 to remove the trims before slackening the bolts.

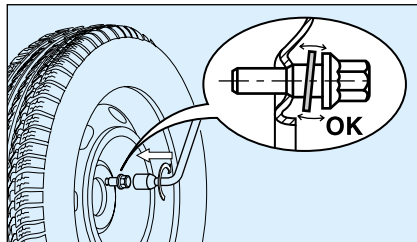

Fitting the spare wheel

If your vehicle is fitted with a steel spare wheel, it is **normal** to notice that the bolt washers do not come into contact with the rim. The spare wheel is secured by the cone shape of each bolt. Tighten the bolts fully.

Fitting snow tyres

If you fit snow tyres mounted on steel wheels, it is **essential** to use special bolts available from your PEUGEOT dealer.

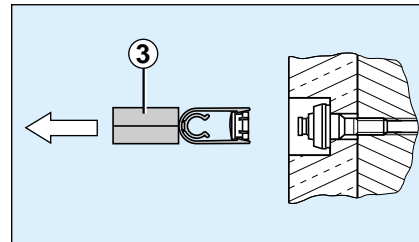

Anti-theft bolts**

If your wheels are fitted with an anti-theft bolt (one per wheel), the chrome trim and then the plastic cover must be removed using tool 3, before unscrewing the bolt using one of the two anti-theft sockets (which were given to you on delivery of your vehicle with the duplicate keys and the confidential card) and the wheel brace 1.

Comment: make a careful note of the code number engraved on the head of the anti-theft socket. This will enable you to obtain a duplicate of the anti-theft sockets from a Peugeot dealer.

* According to specification.

** According to model and destination.

MAINTENANCE OF YOUR 306

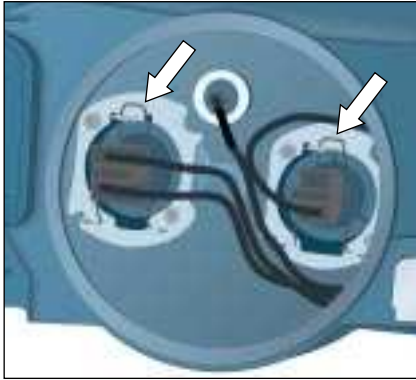

CHANGING A BULB

Dipped/main beam headlamps

Double Headlamps: two H7 55W bulbs.

Changing the bulbs

Turn the plastic protector and remove it.

Disconnect the connectors.

Press the spring to unclip the bulb and then change it.

When fitting, ensure that the direction notches are positioned correctly and that the plastic protector is secured correctly.

Only handle the bulb using a dry cloth.

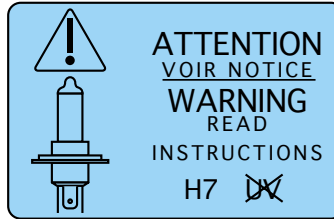

Warning

There is a risk of damage to the dipped/main beam Headlamps.

Only use bulbs supplied by the following manufacturers:

- GE/TUNGSRAM
- PHILIPS
- OSRAM

These bulbs meet the UV-free specifications necessary for the correct operation and reliability of the Headlamps.

The Headlamps are fitted with polycarbon glass with a protective coating. We strongly advise against cleaning them using a dry or abrasive cloth or using products which contain detergents or solvents.

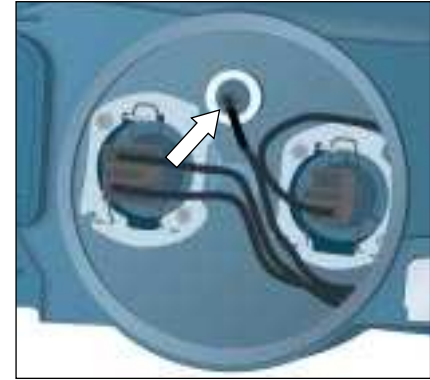

Side lights W5W

Turn the plastic protector and remove it.

Turn the pin a quarter turn and remove it.

Change the bulb.

MAINTENANCE OF YOUR 306
.....**Amber direction indicator lights
PY21W**

Pull out the connector. Turn the holder a quarter of a turn.

Replace the light.

**Amber side repeater lights W5W**

Pull the rear part of the transparent cover and release the assembly.

Support the connector and turn the transparent cover a quarter turn.

Change the bulb.

**Number plate lights W5W**

Remove the translucent plastic protectors.

MAINTENANCE OF YOUR 306
.....**Amber direction indicator lights
PY21W**

Pull out the connector. Turn the holder a quarter of a turn.

Replace the light.

**Amber side repeater lights W5W**

Pull the rear part of the transparent cover and release the assembly.

Support the connector and turn the transparent cover a quarter turn.

Change the bulb.

**Number plate lights W5W**

Remove the translucent plastic protectors.

MAINTENANCE OF YOUR 306

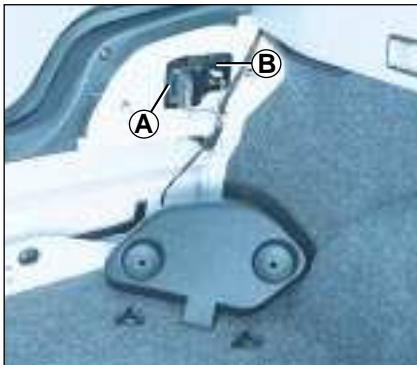

REAR LIGHTS 3, 4 AND 5 DOOR

- Unscrew the two wing nuts inside the boot.
- Remove the plastic cover.
- Disconnect the connector **A** by pressing the metal bar.
- Disconnect the connector **B** by releasing the tab.
- Release the light unit.
- Pinch the tabs and remove the bulb holder **C**.
- Change the faulty bulb.

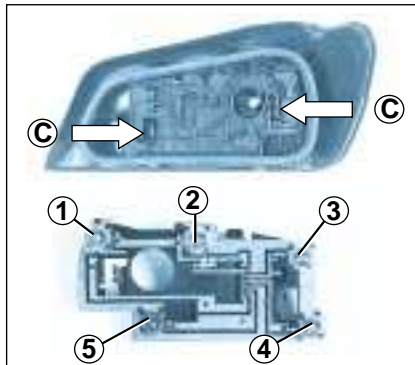

REAR LIGHTS 3 AND 5 DOOR

- 1 Brake lights/side lights P21/5W.
- 2 Side lights P21/5W.
- 3 Rear fog lamp P21W.
- 4 Reversing lights P21W.
- 5 Amber direction indicator lights PY21W.

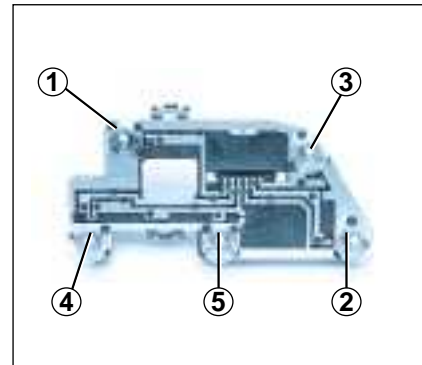

REAR LIGHTS 4 DOOR

- 1 Amber direction indicator lights PY21W.
- 2 Rear fog lamp P21W.
- 3 Reversing lights P21W.
- 4 Brake lights/side lights P21/5W.
- 5 Side lights P21/5W.



When refitting, ensure that the seal is clean, in order to prevent water entry.

MAINTENANCE OF YOUR 306



REAR LIGHTS (ESTATE)

- Open the storage compartment inside the boot.
- Open the access flap.
- Unscrew the wing bolt on the inside.
- Unscrew the second wing bolt outside the vehicle.

Use the wheelbrace to make it easier to unscrew the bolts. **Warning:** never use it for refitting.

- Release the light unit.
- Disconnect the connector by pressing the metal bar.
- Pinch the tabs and remove the bulb holder.
- Change the faulty bulb.

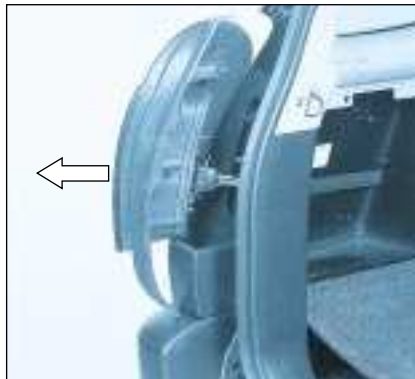

- 1 Amber direction indicator lights PY21W.**
- 2 Reversing lights P21W.**
- 3 Brake lights/side lights P21/5W.**

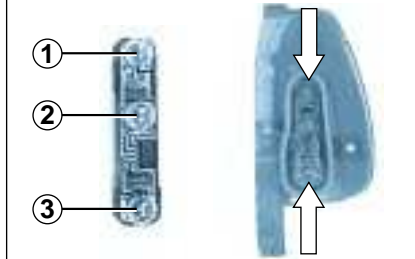

Fog lamp P21W

This is located in the bumper.

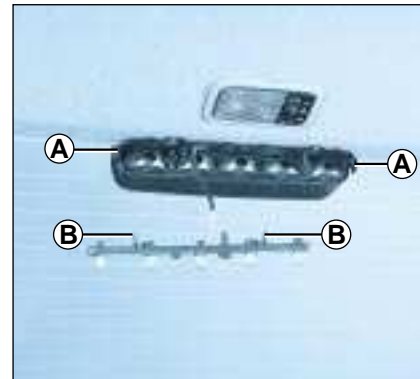

Additional brake light 5 bulbs W5W

Remove the plastic protector by pressing the notches **A**.

Squeeze the tabs **B** to release the lamp holder.

Change the faulty bulb.



The bulbs must be replaced by bulbs of identical specification and colour.

MAINTENANCE OF YOUR 306



CHANGING A FUSE

The fuse boxes are located under the fascia and in the engine compartment.

Fascia fuse box

Unscrew the catch a quarter turn using a coin then remove the cover to gain access to the fuses.

Removing and changing a fuse

Before changing a fuse you must find out the cause of the fault and have it put right. The fuse numbers are indicated on the fuse box. Use the special pliers **A** attached to the box.

Always change a faulty fuse for one of the same rating.

CORRECT

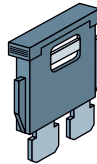

INCORRECT

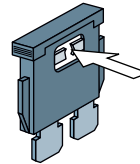

PLIERS A

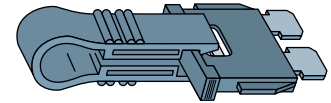

MAINTENANCE OF YOUR 306



ENGINE COMPARTMENT FUSES*

To access the fuse box in the engine compartment (beside the battery), unclip the cover.

Carefully close the cover when you have finished.

Fuse No.	Rating*	Functions*
1**	40A	Anti-theft supply
2**	60A	Supply to Locks - lighting switch – air conditioning blower unit – front fog relay – diagnostic connector
3**	60A	ABS ECU supply
4**	60A	+ positive fuse box supply

* According to specification.



The electrical system of your vehicle is designed to operate with standard or optional equipment.

Before installing other electrical equipment or accessories on your vehicle, contact a PEUGEOT dealer.

Some electrical accessories or the way in which they are fitted can have damaging effects on the operation of your vehicle; the electronic control circuits, the audio circuit and the battery charging circuit.

PEUGEOT will not accept responsibility for the cost incurred in repairing your vehicle or for rectifying the malfunctions resulting from the installation of accessories not supplied and not recommended by PEUGEOT and not installed in accordance with its instructions, in particular where the equipment in question consumes more than 10 milliamperes.

*** The maxi-fuses provide additional protection for the electrical systems. All work must be carried out by a PEUGEOT dealer.*

MAINTENANCE OF YOUR 306

Fuse No.	Rating*	Functions*
29	10A	Left-hand dipped beam
30	10A	Right-hand dipped beam
31	10A	Left-hand main beam
32	10A	Right-hand main beam
33	15A	Diesel control unit
34	10A	Oxygen sensor
35	15A	Petrol pump
36	20A	Headlamp wash timer
37	40A	Cooling fan unit
38	-	Not used
39	40A	Fan unit spare fuse
40	40A	Fan unit

* According to specification.

MAINTENANCE OF YOUR 306



CHANGING A FUSE

The fuse boxes are located under the fascia and in the engine compartment.

Fascia fuse box

Unscrew the catch a quarter turn using a coin then remove the cover to gain access to the fuses.

Removing and changing a fuse

Before changing a fuse you must find out the cause of the fault and have it put right. The fuse numbers are indicated on the fuse box. Use the special pliers **A** attached to the box.

Always change a faulty fuse for one of the same rating.

CORRECT

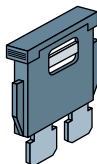

INCORRECT

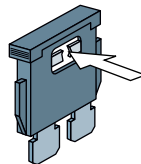

PLIERS A

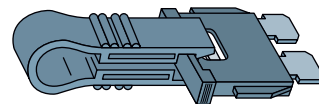

MAINTENANCE OF YOUR 306

FASCIA FUSE BOX

28-fuse box

Fuse No.	Rating*	Functions*
1	—	Not used
2	7.5A	Automatic gearbox or excess speed buzzer control unit
3	5A	ABS control unit
4	5A	Instrument panel – Passenger compartment protection unit – Coolant temperature unit – Automatic gearbox lever lighting – Automatic gearbox relay – Passenger airbag disarming switch
5	25A	Reversing lights switch – Automatic gearbox relay – Stop lights switch – Daylight running lights relay – Fan assembly relay – Pressostat control – Compressor relay
6	5A	Instrument panel - Passenger compartment protection unit – Alarm warning light – Clock – Boot light – Radio aerial
7	30A	Rear screen and mirrors demisting
8	20A	Passenger compartment protection unit – Radio
9	20A	Injection control unit – Fan assembly relay – Coolant temperature unit
10	20A	Hazard warning lights – Front and rear courtesy lights
11	10A	Instrument panel lighting – Side lights buzzer - Clock – Lighting rheostat – Side lights
12	10A	Rear fog lamp
13	—	Not used
14	30A	Rear screen and heated seats relay

* According to specification.

MAINTENANCE OF YOUR 306

Fuse No.	Rating*	Functions*
15	20A	Towing attachment
16	30A	Front window and sun roof relay
17	20A	Horn control
18	10A	Front fog lamps
19	10A	Right rear light
20	30A	Ventilation - Heating and air conditioning
21	10A	Left rear light – Number plate lighting – Front side lights
22	10A	Ventilation relay – Rear screen and mirrors demisting control
23	20A	Lighter
24	—	Not used
25	10A	Radio
26	30A	Front window wiper and windscreen wash pump - Front windscreen wiper motor – Window wiper or rain sensor relay timer
27	15A	Storage compartment lighting – Direction indicators – Electric mirrors control - Map reading lights – Courtesy mirror – Rain sensor – Passenger compartment temperature sensor
28	15A	Clock – Outside temperature – Window and heated seats relay – Rear screen wiper – Sun roof

* According to specification.

MAINTENANCE OF YOUR 306

BATTERY

To charge the battery using a battery charger:

- Disconnect the battery, starting with the negative (-) terminal.
- Follow the instructions for use given by the battery charger manufacturer.
- Reconnect starting with the positive (+) terminal.
- Check that the terminals and connectors are clean. If they are covered with sulphate deposits (white or greenish deposit), disconnect them and clean them.

To start the vehicle and charge the battery from another battery:

- Ensure that the connections are good:
- Connect the red cable to the positive (+) terminals of the two batteries.
- Connect one end of the green or black cable to the negative (-) terminal of the slave battery.
- Connect the other end of the green or black cable to an earth point on the broken down vehicle as far as possible from the battery.

Operate the starter, let the engine run.

Wait for the engine to return to idle, and disconnect the cables.



- *Never disconnect a terminal when the engine is running.*
- *Never charge a battery without first disconnecting the terminals.*
- *After every disconnection of the battery, switch on the ignition and wait 10 seconds before starting. If slight difficulties are experienced after this, please contact a PEUGEOT dealer.*

It is advisable to disconnect the battery if the vehicle is not to be used for a period of more than one month.

MAINTENANCE OF YOUR 306

FITTING AUDIO EQUIPMENT

Your vehicle is factory-fitted with certain audio equipment:

- Roof aerial.
- Aerial coaxial cable.
- Basic interference suppression.
- Supply to front speakers.
- Supply to rear speakers*.
- Two 8-way connectors.

FITTING SPEAKERS

165 mm diameter speakers can be fitted in the front doors and on the rear parcel shelf.

Contact your PEUGEOT dealer.

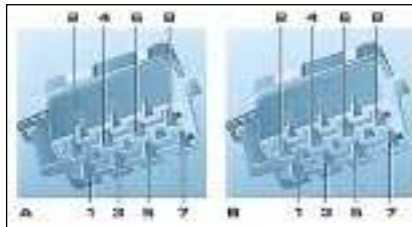

Wiring positions and functions

Connector A

A1 : Telephone mute connection.

A2 : –

A3 : –

A4 : (+ve) Accessories.

A5 : –

A6 : (+ve) Sidelights.

A7 : (+ve) Permanent.

A8 : Earth.

Connector B

B1 : (+) Right rear loud-speaker.

B2 : (–) Right rear loud-speaker.

B3 : (+) Right front loud-speaker.

B4 : (–) Right front loud-speaker.

B5 : (+) Left front loud-speaker.

B6 : (–) Left front loud-speaker.

B7 : (+) Left rear loud-speaker.

B8 : (–) Left rear loud-speaker.

* According to specification.

MAINTENANCE OF YOUR 306



TOWING

Without lifting (four wheels on the ground)

You must always use a towbar.

From the front or the rear

Attach the towbar to the towing eye.

By lifting (two wheels only on the ground)

It is preferable to lift the vehicle by the wheels.

Never use the radiator crossmember.

Special features of the automatic gearbox

When towing with four wheels on the ground, the following rules must be obeyed:

- lever in position **N**,
- tow the vehicle at less than 30 m.p.h. (50 km/h) over a maximum distance of 30 miles (50 km),
- do not add oil to the gearbox.

MAINTENANCE OF YOUR 306

TOWING A TRAILER, CARAVAN, BOAT ETC.

Only use original PEUGEOT towbars which have been tested and approved from the design stage of your vehicle.

The towbar must be fitted by a PEUGEOT dealer.

Your vehicle is mainly designed for transporting people and luggage but it may also be used to tow a trailer.

Driving with a trailer subjects the towing vehicle to more significant forces and requires particular attention on the part of the driver.

Air density decreases with altitude, thus also reducing engine performance. Above 1000 metres, reduce the maximum towing load by 10 % and so on for each additional 1000 metres.

Driving advice

Distribution of loads: distribute the load in the trailer so that the heaviest loads are as close as possible to the axle and the nose weight is close to the maximum authorised without, however, exceeding it.

Cooling: towing a trailer on a slope increases the coolant temperature. As the fan is electrically controlled, its cooling capacity is not dependent on the engine speed.

On the contrary, use a high gear to lower the engine speed, and reduce your speed.

The maximum towing load on a long slope depends on the gradient and the outside temperature.

In all cases, pay attention to the coolant temperature.

If the warning light comes on, stop the vehicle and switch off the engine as soon as possible.

For use in arduous conditions (towed load at the limit of the Permissible Gross Train Weight, in Summer on a long hill) **certain engines (1.9 l Diesel) must be equipped** with a more resistant cooling system.

Consult a PEUGEOT dealer who, depending on your vehicle and what it is used for, will be able to advise you about suitable equipment.

Pay attention to the coolant temperature at all times.

If the alarm warning light comes on, stop the vehicle and switch off the engine as soon as possible.

Tyres: check the tyre pressures of the towing vehicle and the trailer, observing the recommended pressures.

Brakes: towing increases the braking distance. Drive at a moderate speed, change down early, brake gradually and avoid jerky braking.

Lighting: adjust your headlamps so as not to dazzle other road users. Check the electrical signalling on the trailer.

Side wind: sensitivity to side wind is increased. Drive smoothly and at a moderate speed.

MAINTENANCE OF YOUR 306

BODYWORK MAINTENANCE

To preserve the paintwork and the plastic trim on your vehicle, we recommend that you wash them regularly,

- by hand, there are no specific precautions to take;
- however repeated use of poorly maintained automatic car-washes can lead to the appearance of micro-scopical scratches which give the paintwork a matt appearance (especially visible on dark colours);
- using a high pressure washer, always following the recommendations on the equipment (pressure and spraying distance).

If there are areas of damage on the vehicle (painted bumpers, or headlamps), it is not recommended to direct the high pressure jet onto them: wash the areas of damage by hand.

Also avoid the entry of water into the locks.

Waxing: the regular use of wax added to the washing water or applied separately is strongly recommended, it protects the upper coats of paintwork against external attack.

For all questions relating to the maintenance of your vehicle, contact an approved dealer who can advise you on quality products selected by our departments.



-Clean off, as soon as possible, bird droppings, resinous deposits, tar stains and grease marks ; (as these all contain substances which can cause serious damage to the paintwork).

- *Brake briefly several times to expel any dampness from the brake pads, when you are setting off after washing your vehicle.*
- *Do not use a dry or abrasive cloth, or detergent or solvent products to clean the double lens, complex surface headlamps as they are fitted with polycarbonate glass covered in a protective finish.*
- *Do not use petrol, oil or cloth stain removers to clean the bodywork and plastic parts of your vehicle.*
- *To prevent the development of bodywork corrosion as a result of accidental damage (stone chips, scratches etc.) have them repaired swiftly.*

PARTS AND ACCESSORIES

For your PEUGEOT, use only accessories and original parts approved by the manufacturer.

These accessories and parts are all suitable for your PEUGEOT, after being tested and approved for reliability and safety.

A wide choice of original accessories, approved by PEUGEOT, is available through the network.

They all carry the PEUGEOT guarantee.

Safety:	Anti-theft alarm, engraving of windows, wheel anti-theft devices, first aid kit...
Comfort:	Telephone console, armrests, seat covers compatible with side airbags, mats, boot tray, sunroof, luggage net, door deflectors, storage under rear parcel shelf...
Communication:	Audio equipment, telephone, CB, speakers, CD changer, audio accessories, navigation...
Personalisation:	Spoiler, alloy wheels, wheel trims, long range lights, fog lamps, sports exhaust, mud flaps,...
Leisure:	Towbar, roof bars, roof box,...
Children:	Booster seats and child seats, side blinds and rear blind...
Maintenance products:	Windscreen wiper fluid, internal and external cleaning and maintenance products...

TECHNICAL DATA

PETROL ENGINES

MODELS: Model codes	7CKFW 7AKFW 7SKFW 7BKFW 7EKFW	7CNFT 7ANFT 7BNFT 7ENFT		7CL6A 7AL6A 7BL6A 7EL6A	7CLFY 7ALFY 7BLFY 7ELFY
ENGINES	1.4 litre	1.6 litre		1.8 litre	1.8 litre 16V
Capacity (cm ³)	1360	1587		1761	1761
Bore x stroke	75 x 77	78,5 x 82		83 x 81,4	83 x 81,4
Number of valves	8	8		8	16
Max. power:					
EU standard (KW)	55	72,6		70	81
at engine speed (r.p.m)	5500	5750		6000	5500
Max. torque:					
EU standard (Nm) at r.p.m	120 at 3400	137,8 at 3250		142 at 3000	155 at 4250
Fuel	Unleaded	Unleaded		Leaded allowed	Unleaded
Catalytic converter	yes	yes		no	yes
GEARBOX	Manual (5-speed)	Manual (5-speed)	Automatic (4-speed)	Manual (5-speed)	Manual (5-speed)
CAPACITIES (in litres)					
Engines (with filter replacement)	3,2	3,2	3,2	4,25(1) - 4,75(2)	4,25(1) - 4,75(2)
Gearbox - Final drive	2	2,4	-	2	2

(1) With air conditioning.

(2) Without air conditioning.

TECHNICAL DATA

PETROL AND DIESEL ENGINES

MODELS: Model codes	7ALFYE 7ALFYT 7BLFYE 7BLFYT 7ELFYE 7ELFYT	7CRFV 7ARFV 7BRFV 7ERFV		7CWJY 7AWJY 7SWJY 7BWJY 7EWJY 7TWJY	7CRHY 7ARHY 7BRHY 7ERHY
ENGINES	1,8 litre 16V	2 litres 16 V		Diesel 1,9 litre	DieselTurbo 2 litres HDI
Capacity (cm ³)	1761	1998		1868	1997
Bore x stroke	83 x 81,4	86 x 86		82,2 x 88	85 x 88
Number of valves	16	16		8	8
Max. power:					
EU standard (KW)	81	97,4		51	66
at engine speed (r.p.m)	5500	5500		4600	4000
Max. torque:					
EU standard (Nm) at r.p.m	155 at 4250	180 at 4200		125 at 2500	205 at 1900
Fuel	Unleaded	Unleaded		Diesel	Diesel
Catalytic converter	oui	oui			
GEARBOX	Manual (5-speed)	Manual (5-speed)	Automatic (4-speed)	Manual (5-speed)	Manual (5-speed)
CAPACITIES (in litres)					
Engines (with filter replacement)	4,25(1)	4,25(1)	4,25(1)	4,5(1)	4,25
	4,75(2)	4,75(2)	4,75(2)	4,75(2)	
Gearbox - Final drive	2	2	-	1,9	1,9

(1) With air conditioning. (2) Without air conditioning.

TECHNICAL DATA

PETROL AND DIESEL ENGINES

MODELS: Model codes	7ALFYE 7ALFYT 7BLFYE 7BLFYT 7ELFYE 7ELFYT	7CRFV 7ARFV 7BRFV 7ERFV		7CWJY 7AWJY 7SWJY 7BWJY 7EWJY 7TWJY	7CRHY 7ARHY 7BRHY 7ERHY
ENGINES	1,8 litre 16V	2 litres 16 V		Diesel 1,9 litre	DieselTurbo 2 litres HDI
Capacity (cm ³)	1761	1998		1868	1997
Bore x stroke	83 x 81,4	86 x 86		82,2 x 88	85 x 88
Number of valves	16	16		8	8
Max. power:					
EU standard (KW)	81	97,4		51	66
at engine speed (r.p.m)	5500	5500		4600	4000
Max. torque:					
EU standard (Nm) at r.p.m	155 at 4250	180 at 4200		125 at 2500	205 at 1900
Fuel	Unleaded	Unleaded		Diesel	Diesel
Catalytic converter	oui	oui			
GEARBOX	Manual (5-speed)	Manual (5-speed)	Automatic (4-speed)	Manual (5-speed)	Manual (5-speed)
CAPACITIES (in litres)					
Engines (with filter replacement)	4,25(1)	4,25(1)	4,25(1)	4,5(1)	4,25
	4,75(2)	4,75(2)	4,75(2)	4,75(2)	
Gearbox - Final drive	2	2	-	1,9	1,9

(1) With air conditioning. (2) Without air conditioning.

TECHNICAL DATA

PETROL ENGINE FUEL CONSUMPTION

Consumption			In accordance with directive 93/116 (litres/100km)			
Engines	Gearbox	Model codes	Urban driving	Inter-urban driving	Mixed driving	Emission of CO ₂ by mass
1,4 litre	Manual	7CKFW 7AKFW 7SKFW 7BKFW 7EKFW	8,6	5,5	6,6	156 g/km
1,6 litre	Manual	7CNFT 7ANFT 7BNFT 7ENFT	9,1	5,6	6,9	165 g/km
1,6 litre	Automatic	7CNFT 7ANFT 7BNFT 7ENFT	11	5,9	7,8	185 g/km
1,8 litre 16 V	Manual	7CLFYT 7ALFYT 7BLFYT	11,6	6,1	8,1	193 g/km
		7ELFYT	11,7	6,2	8,2	196 g/km
		7CLFYE 7ALFYE 7BLFYE	12	6,3	8,3	198 g/km
		7ELFYE	12,1	6,4	8,4	198 g/km
2 litres 16 V	Manual	7CRFV 7ARFV 7BRFV 7ERFV	12,8	7,0	9,1	219 g/km
2 litres 16 V	Automatic	7CRFVW 7ARFVW 7BRFVW 7ERFVW	13,7	6,5	9,2	221 g/km

TECHNICAL DATA

CONSUMPTION FOR DIESEL

Consumption			According to directive 93/116 (litres/100 km)			
Engine	Gearbox	Model codes	Urban roads	Inter-urban roads	Mixed roads	Emission of CO ₂ by mass
Diesel 1,9 litre	Manual	7CWJY 7AWJY 7BWJY 7EWJY 7SWJY 7TWJY	8,3	5	6,3	166 g/km
Diesel turbo 2 litres HDI	Manual	7CRHY 7ARHY 7BRHY 7ERHY	7	4,4	5,3	143 g/km

The fuel consumption values given are correct at the time of going to press.

TECHNICAL DATA

TOWING WEIGHTS AND LOADS (IN KG)

3 DOOR

Engines	1.4 litre	1.6 litre	1.6 litre	1.8 litre	2 16 V	2 16 V	1.9 D	2 HDI			
Gearbox	Manual	Manual	Auto.	Manual	Manual	Auto.	Manual	Manual			
Model codes : 7C...	KFW	NFT	NFT	LFY/L6A	RFV	RFV	WJY	RHY			
• Kerb weight	1 013	1 071	1 108	1 096	1 160	1 208	1 100	1 142			
• Gross vehicle weight (GVW)	1 460	1 535	1 550	1 560	1 625	1 650	1 530	1 585			
• Gross Train weight (GTW)*	2 360	2 435	2 450	2 560	2 625	2 650	2 480	2 585			
• Unbraked trailer	540	570	575	580	610	630	570	600			
• Braked trailer (within GTW)	1 200	1 200	1 200	1 200	1 200	1 200	1 200	1 200			

5 DOOR

Engines	1.4 litre	1.6 litre	1.6 litre	1.8 litre	1.8 16 V	2 16 V	2 16 V	1.9 D	2 HDI		
Gearbox	Manual	Manual	Auto.	Manual	Manual	Manual	Auto.	Manual	Manual		
Model codes : 7A...	KFW	NFT	NFT	LFY/L6A	FYE/FYT	RFV	RFV	WJY	RHY		
• Kerb weight	1 043	1 106	1 125	1 116	1 116	1 194	1 242	1 118	1 213		
• Gross vehicle weight (GVW)	1 480	1 580	1 600	1 600	1 670	1 640	1 650	1 580	1 630		
• Gross Train weight (GTW)*	2 380	2 480	2 500	2 600	2 670	2 640	2 650	2 530	2 630		
• Unbraked trailer	550	580	585	590	625	620	640	580	610		
• Braked trailer (within GTW)	1 200	1 200	1 200	1 200	1 200	1 200	1 200	1 200	1 200		

3 DOOR VAN 7S...

5 DOOR VAN 7T...

Engines	1.4 litre	1.9 D			1.8 16 V	1.9 D				
Gearbox	Manual	Manual			Manual	Manual				
Model codes : 7S... / 7T...	KFW	WJY			FYE/FYT	WJZ				
• Kerb weight	1 013	1 100			1 096	1 118				
• Gross vehicle weight (GVW)	1 460	1 530			1 670	1 580				
• Gross Train weight (GTW)*	2 360	2 480			2 670	2 530				
• Unbraked trailer	—	—			—	—				
• Braked trailer (within GTW)	1 200	1 200			1 200	1 200				

* The speed of a towing vehicle is limited to 60 mph (100 Km/h).

TECHNICAL DATA

TOWING WEIGHTS AND LOADS (IN KG)

4 DOOR

Engines	1.4 litre	1.6 litre	1.6 litre	1.8 litre	1.8 I 16 V	2 I 16 V	2 I 16 V	1.9 I D	2 I HDI		
Gearbox	Manual	Manual	Auto.	Manual	Manual	Manual	Auto.	Manual	Manual		
Model codes : 7B...	KFW	NFT	NFT	LFY/L6A	FYE/FYT	RFV	RFV	WJY	RHY		
• Kerb weight	1 042	1 117	1 180	1 162	1 162	1 198	1 225	1 227	1 225		
• Gross vehicle weight (GVW)	1 515	1 575	1 610	1 615	1 695	1 635	1 660	1 590	1 635		
• Gross Train weight (GTW)*	2 415	2 475	2 510	2 615	2 695	2 635	2 660	2 540	2 635		
• Unbraked trailer	555	585	605	600	640	630	650	590	620		
• Braked trailer (within GTW)	1 200	1 200	1 200	1 200	1 200	1 200	1 200	1 200	1 200		

ESTATE

Engines	1.4 litre	1.6 litre	1.6 litre	1.8 litre	1.8 I 16 V	2 I 16 V	2 I 16 V	1.9 I D	2 I HDI		
Gearbox	Manual	Manual	Auto.	Manual	Manual	Manual	Auto.	Manual	Manual		
Model codes : 7B...	KFW	NFT	NFT	LFY/L6A	FYE/FYT	RFV	RFV	WJY	RHY		
• Kerb weight	1 088	1 150	1 165	1 185	1 185	1 195	1 225	1 172	1 260		
• Gross vehicle weight (GVW)	1 550	1 605	1 635	1 645	1 725	1 665	1 675	1 625	1 655		
• Gross Train weight (GTW)*	2 450	2 505	2 535	2 645	2 725	2 665	2 675	2 575	2 655		
• Unbraked trailer	570	590	620	630	675	640	650	600	635		
• Braked trailer (within GTW)	1 000	1 000	1 000	1 000	1 000	1 000	1 000	1 000	1 000		

* The speed of a towing vehicle is limited to 60 mph (100 Km/h).

TECHNICAL DATA

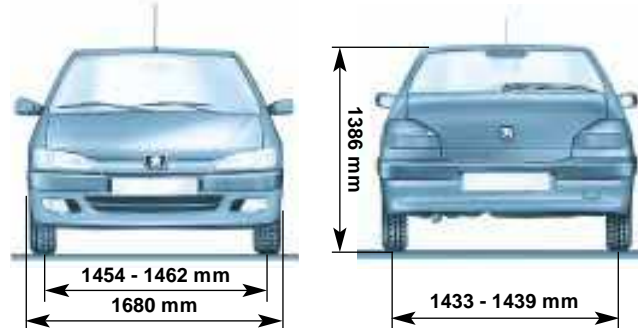
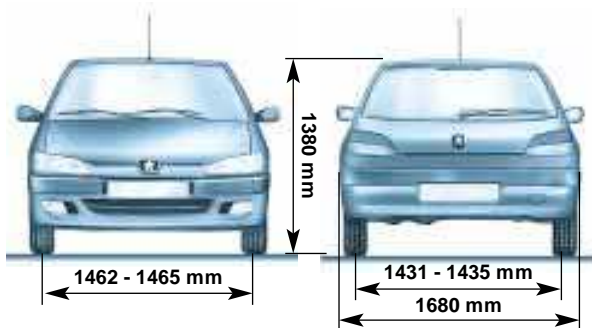
Dimensions 3 or 5 door**Dimensions 4 door**

TECHNICAL DATA

Dimensions estate

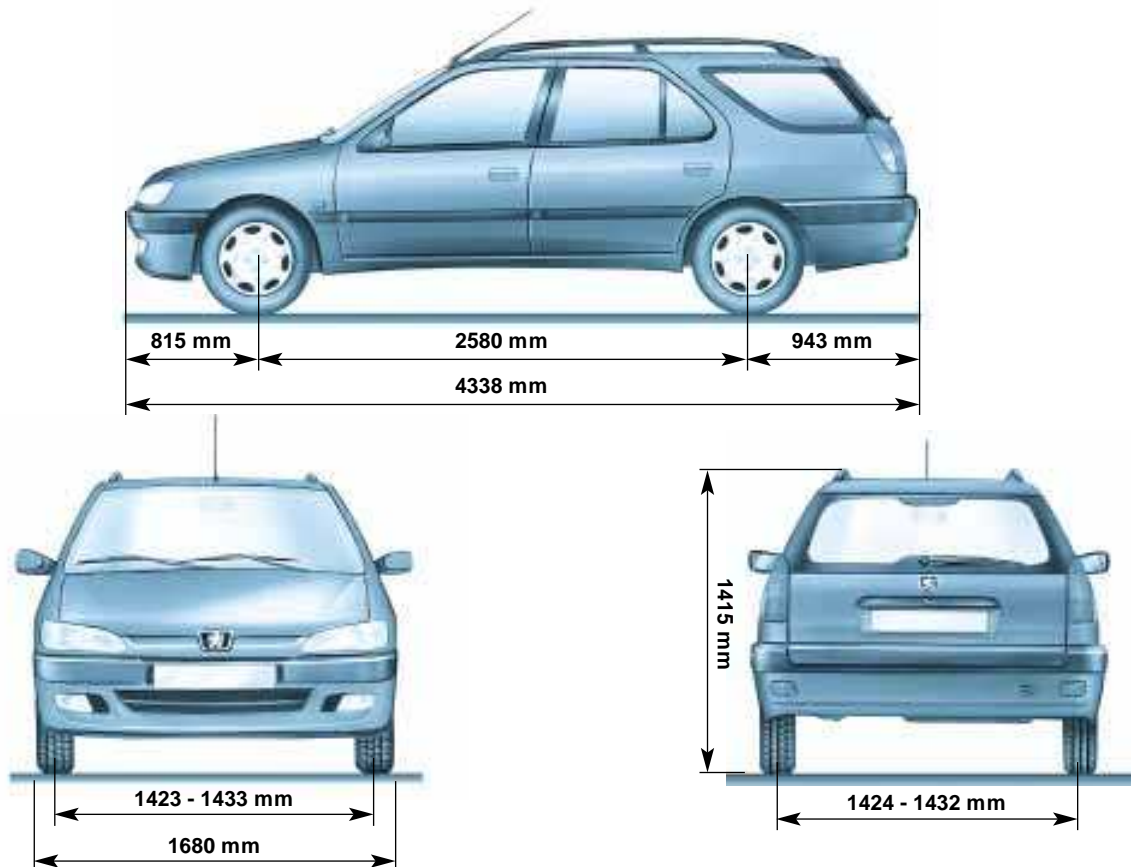

TECHNICAL DATA

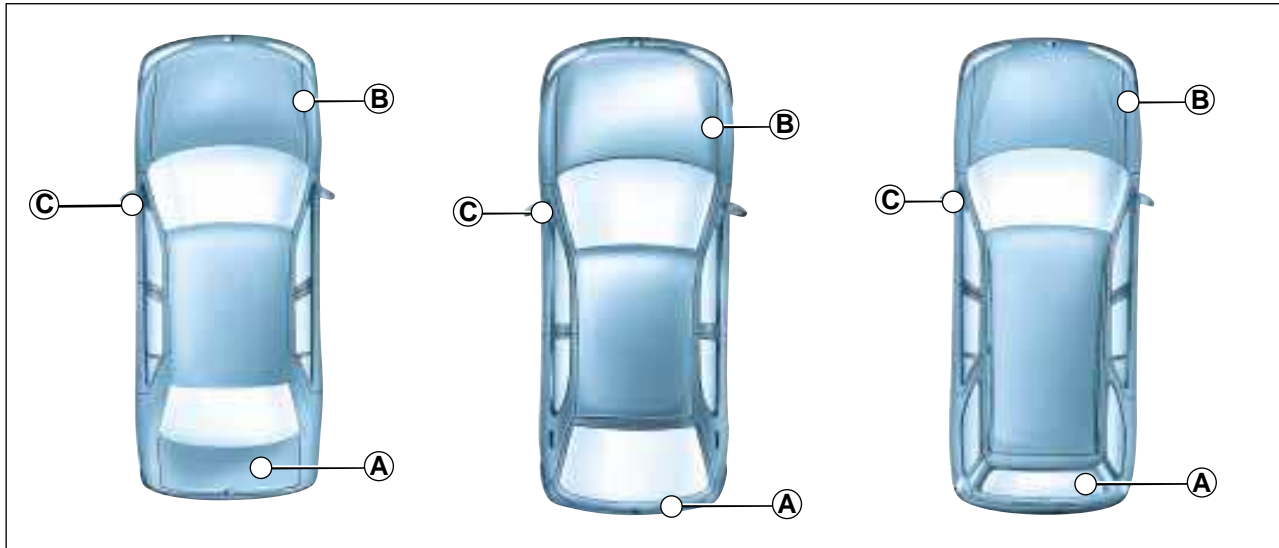
**IDENTIFYING FEATURES OF YOUR 306**

A. Manufacturer's plate.

B. Model serial number.

C. Tyre pressures and paint colour code.

The label **C** affixed to the centre pillar of the driver's side door indicates:

- the wheel and tyre sizes,
- the brands of tyres approved by the manufacturer,
- inflation pressures (**the inflation pressure check must be carried out cold, at least once a month**).
- the paint colour code.