

L200 - ENGLISH - OKTE14E2

L200 - ENGLISH - OKTE14E2

L200

OWNER'S MANUAL



Foreword

E09200104597

Thank you for selecting a MITSUBISHI L200 as your new vehicle. This owner's manual will add to your understanding and full enjoyment of the many fine features of this vehicle. It contains information prepared to acquaint you with the proper way to operate and maintain your vehicle for the utmost in driving pleasure.

MITSUBISHI MOTORS Europe B.V. reserves the right to make changes in design and specifications and/or to make additions to or improvements in this product without obligation to install them on products previously manufactured.

It is an absolute requirement for the driver to strictly observe all laws and regulations concerning vehicles.

This owner's manual has been written in compliance with such laws and regulations, but some of the contents may become contradictory with later amendment of the laws and regulations.

Please leave this owner's manual in this vehicle at time of resale. The next owner will appreciate having access to the information contained in this owner's manual.

Repairs to your vehicle:
Vehicles in the warranty period:
All warranty repairs must be carried out by a MITSUBISHI MOTORS Authorized Service Point.

Vehicles outside the warranty period:
Where the vehicle is repaired is at the discretion of the owner.

Throughout this owner's manual the words **WARNING** and **CAUTION** appear.

These serve as reminders to be especially careful. Failure to follow instructions could result in personal injury or damage to your vehicle.

WARNING

indicates a strong possibility of severe personal injury or death if instructions are not followed.

CAUTION

means hazards or unsafe practices that could cause minor personal injury or damage to your vehicle.

You will see another important symbol:

NOTE: gives helpful information.

***:** indicates optional equipment.

It may differ according to the sales classification; refer to the sales catalogue.

Abbreviations used in this owner's manual:

LHD: Left-Hand Drive

RHD: Right-Hand Drive

M/T: Manual Transmission

A/T: Automatic Transmission

The symbol used on the vehicles:



: See owner's manual

Information for station service

E09300102174

Fuel	Fuel tank capacity	75 litres
	Fuel requirements	Cetane number (EN590) 51 or higher Refer to the "General information" section for the fuel selection.
Engine oil		Refer to the "Maintenance" section for the selection of engine oil.
Tyre inflation pressure		Refer to the "Maintenance" section for the tyre inflation pressure.

Table of contents

<i>Overview</i>	
<i>General information</i>	
<i>Locking and unlocking</i>	1
<i>Seat and seat belts</i>	2
<i>Instruments and controls</i>	3
<i>Starting and driving</i>	4
<i>For pleasant driving</i>	5
<i>For emergencies</i>	6
<i>Vehicle care</i>	7
<i>Maintenance</i>	8
<i>Specifications</i>	9

Instruments and Controls (Driver's area)

E00100106630

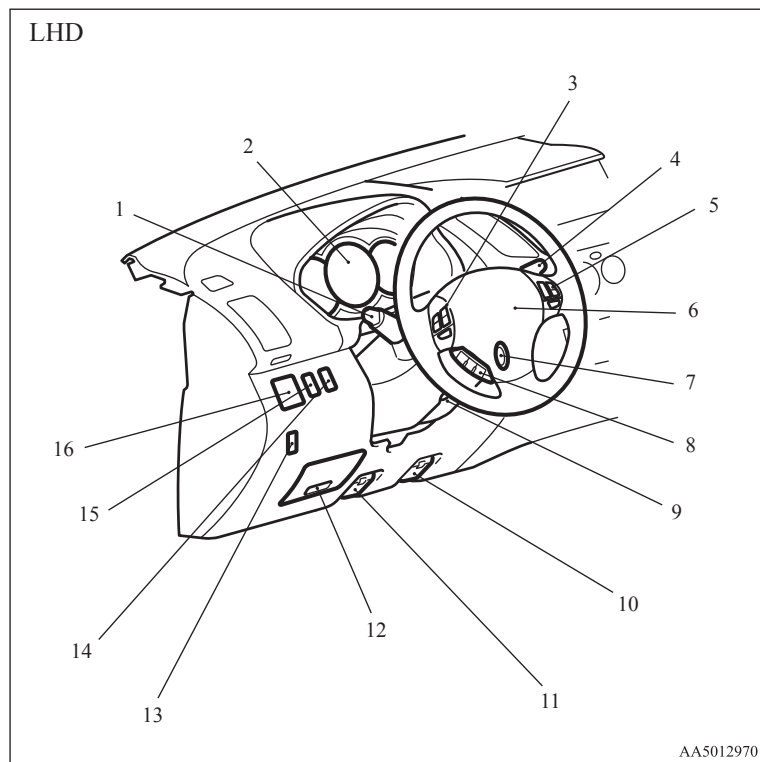

1. Combination headlamps and dipper switch p. 3-30
Turn-signals lever p. 3-33
Front fog lamp switch* p. 3-34
Rear fog lamp switch* p. 3-35
Headlamp washer switch* p. 3-39
2. Instruments p. 3-02
3. Audio remote control switches* p. 5-41
4. Wiper and washer switch p. 3-36
5. Cruise control switches* p. 4-45
6. Supplemental restraint system (SRS) - airbag (for driver's seat)* p. 2-26
Horn switch p. 3-40
7. Ignition switch p. 4-10
8. Hands-free & voice recognition switches* p. 5-52
9. Steering wheel height adjustment p. 4-08
10. Fuel tank filler door release lever* p. 02
11. Bonnet release lever p. 8-03
12. Fuses p. 8-20
13. Active stability control (ASC) OFF switch Type 2* p. 4-43
14. Headlamp levelling switch* p. 3-32
15. Active stability control (ASC) OFF switch Type 1* p. 4-43
Rear differential lock switch* p. 4-30
16. Electric remote-controlled outside rear-view mirror switch* p. 4-09

RHD

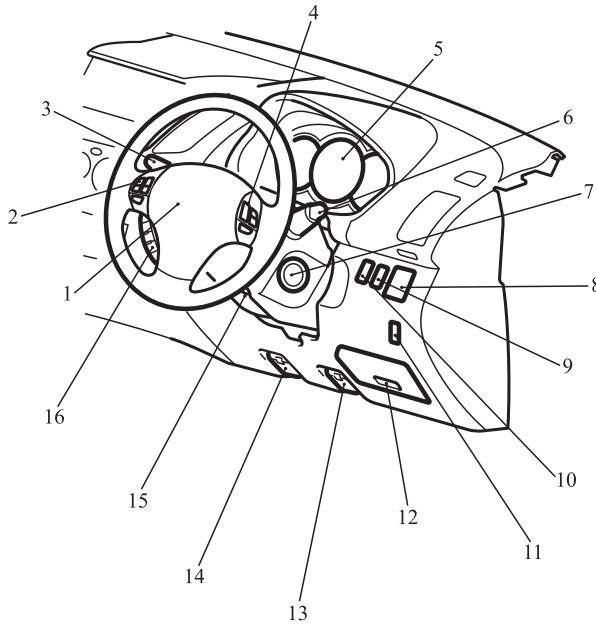

AA5012723

1. Supplemental restraint system (SRS) - airbag (for driver's seat)* p. 2-26
Horn switch p. 3-40
2. Audio remote control switches* p. 5-41
3. Combination headlamps and dipper switch p. 3-30
Turn-signals lever p. 3-33
Front fog lamp switch* p. 3-34
Rear fog lamp switch p. 3-35
Headlamp washer switch* p. 3-39
4. Cruise control switches* p. 4-45
5. Instruments p. 3-02
6. Wiper and washer switch p. 3-36
7. Ignition switch p. 4-10
8. Electric remote-controlled outside rear-view mirror switch* p. 4-09
9. Active stability control (ASC) OFF switch Type 1* p. 4-43
Rear differential lock switch* p. 4-30
10. Headlamp levelling switch* p. 3-32
11. Active stability control (ASC) OFF switch Type 2* p. 4-43
12. Fuses p. 8-20
13. Bonnet release lever p. 8-03
14. Fuel tank filler door release lever* p. 02
15. Steering wheel height adjustment p. 4-08
16. Hands-free & voice recognition switches* p. 5-52

Instruments and Controls (Single cab)

E00100106148

LHD

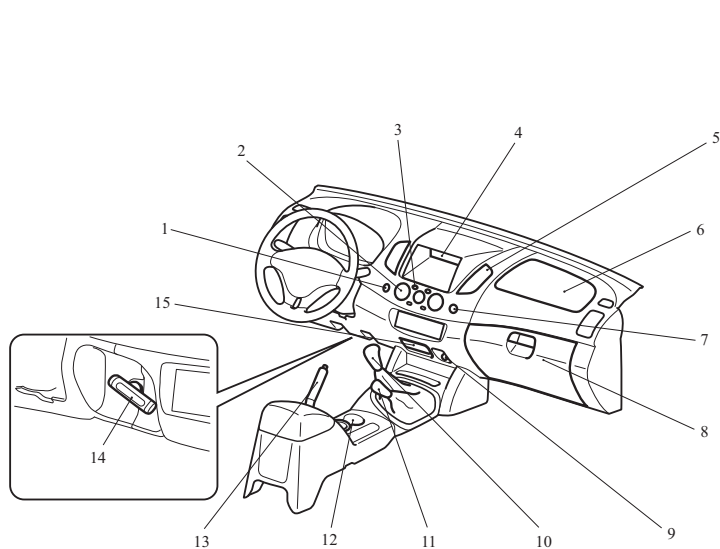

AA5004258

1. Hazard warning flasher switch p. 3-34
2. Heater/Manual air conditioning* p. 5-03
3. Rear window demister switch p. 3-39
4. Utility box p. 5-78
5. Ventilators p. 5-02
6. Supplemental restraint system (SRS) - airbag (for front passenger's seat)* p. 2-26
7. Front passenger's airbag OFF indication lamp* p. 2-30
8. Glove box p. 5-77
9. Cigarette lighter p. 5-72
10. Gearshift lever p. 4-14
11. Transfer shift lever (4WD only) p. 4-22
12. Cup holder* p. 5-79
13. Parking brake lever Type 1* p. 4-06
14. Parking brake lever Type 2* p. 4-06
15. Ashtray p. 5-71

RHD

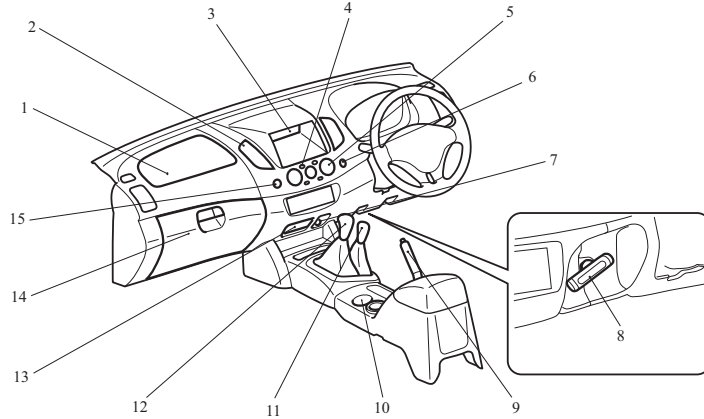

AA5004186

1. Supplemental restraint system (SRS) - airbag (for front passenger's seat) p. 2-26
2. Ventilators p. 5-02
3. Utility box p. 5-78
4. Rear window demister switch p. 3-39
5. Heater/Manual air conditioning* p. 5-03
6. Hazard warning flasher switch p. 3-34
7. Cigarette lighter p. 5-72
8. Parking brake lever Type 2* p. 4-06
9. Parking brake lever Type 1* p. 4-06
10. Cup holder* p. 5-79
11. Transfer shift lever (4WD only) p. 4-22
12. Gearshift lever p. 4-14
13. Ashtray p. 5-71
14. Glove box p. 5-77
15. Front passenger's airbag ON-OFF switch p. 2-29
- Front passenger's airbag OFF indication lamp p. 2-30

Instruments and Controls (Club, Double cab)

E00100106643

LHD

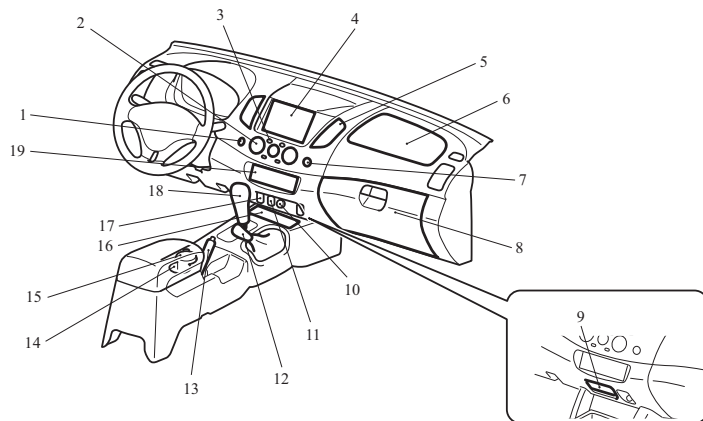

AA5010455

1. Hazard warning flasher switch p. 3-34
2. Heater/Manual air conditioning* p. 5-03
Automatic air conditioning* p. 5-08
3. Rear window demister switch (vehicle with heater/manual air conditioning) p. 3-39
4. Utility box* p. 5-78
Centre information display* p. 3-10
MITSUBISHI Multi-Communication System*
Refer to the separate "MITSUBISHI Multi-Communication System owner's manual"
5. Ventilators p. 5-02
6. Supplemental restraint system (SRS) - airbag (for front passenger's seat)* p. 2-26
7. Front passenger's airbag OFF indication lamp* p. 2-30
8. Glove box p. 5-77
Front passenger's airbag ON-OFF switch* p. 2-29
USB input terminal* p. 5-68
9. Ashtray (fixed position)* p. 5-71
10. Cigarette lighter p. 5-72
11. Rear retractable power window switch* p. 1-08
12. Transfer shift lever (4WD only) p. 4-22, 4-26
13. Parking brake lever p. 4-06
14. Cup holder p. 5-79
15. Ashtray (moveable)* p. 5-71
16. Front console box* p. 5-77
17. Heated seat switch* p. 2-06
18. Gearshift lever* p. 4-14
Selector lever* p. 4-17
19. Audio* p. 5-13

RHD

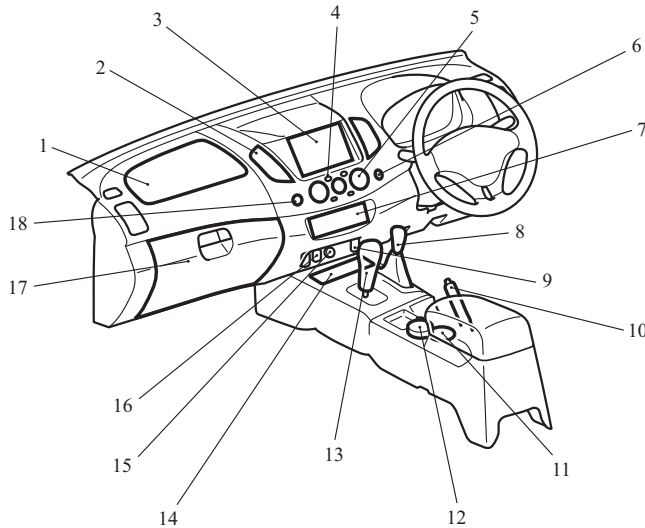

AA5010468

1. Supplemental restraint system (SRS) - airbag (for front passenger's seat)* p. 2-26
2. Ventilators p. 5-02
3. Utility box* p. 5-78
Centre information display* p. 3-10
MITSUBISHI Multi-Communication System*
Refer to the separate "MITSUBISHI Multi-Communication System owner's manual"
4. Rear window demister switch (vehicle with heater/manual air conditioning) p. 3-39
5. Heater/Manual air conditioning* p. 5-03
Automatic air conditioning* p. 5-08
6. Hazard warning flasher switch p. 3-34
7. Audio* p. 5-13
8. Transfer shift lever (4WD only) p. 4-22, 4-26
9. Heated seat switch* p. 2-06
10. Parking brake lever p. 4-06
11. Cup holder p. 5-79
12. Ashtray (moveable)* p. 5-71
13. Gearshift lever* p. 4-14
Selector lever* p. 4-17
14. Front console box* p. 5-77
15. Cigarette lighter p. 5-72
16. Rear retractable power window switch* p. 1-08
17. Glove box p. 5-77
Front passenger's airbag ON-OFF switch* p. 2-29
USB input terminal* p. 5-68
18. Front passenger's airbag OFF indication lamp* p. 2-30

Interior (Single cab)

E00100204842

LHD

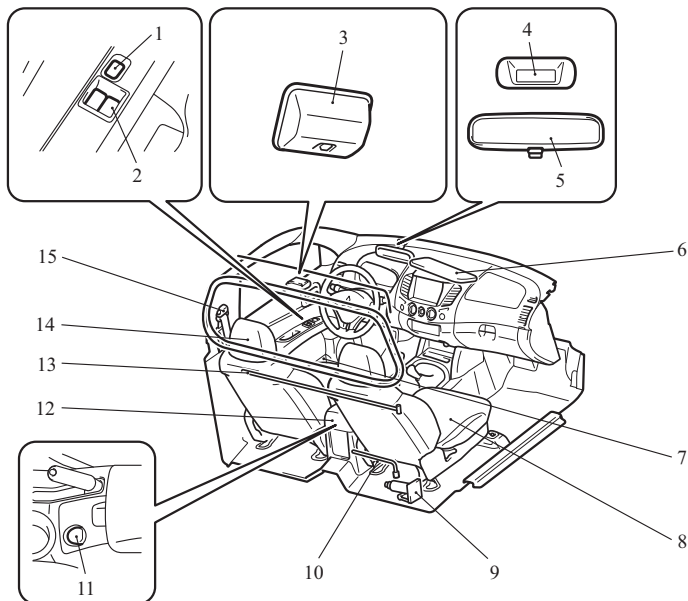

AA5010471

1. Lock switch* p. 1-09
2. Electric window control switch* p. 1-08
3. Room lamp p. 5-74, 8-24, 8-32
4. Digital clock p. 5-74
5. Inside rear-view mirror p. 4-08
6. Sun visors p. 5-70
7. Bottle holder p. 5-80
8. Front seats p. 2-03
9. Jack p. 6-07
10. Tools*¹ p. 6-07
11. Accessory socket* p. 5-73
12. Floor console box* p. 5-77
13. Jack handle p. 6-07
14. Head restraints p. 2-08
15. Seat belts p. 2-09

NOTE: *¹- Tools differ according to the vehicle model.

RHD

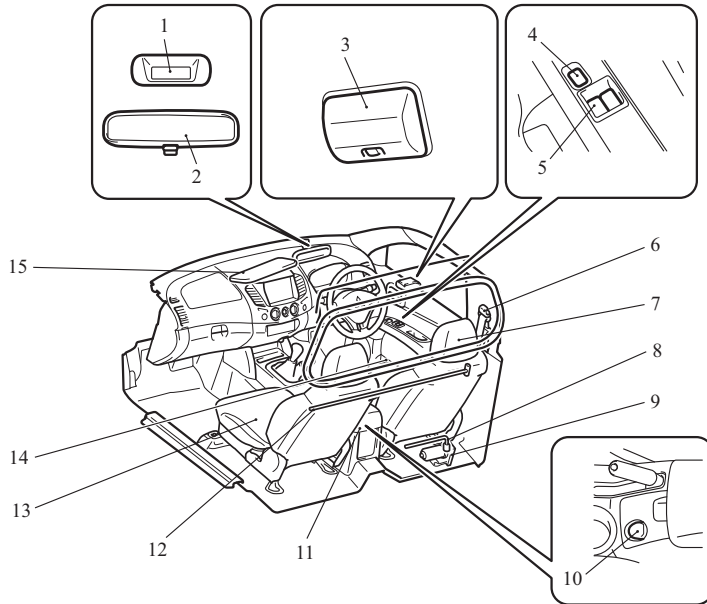

1. Digital clock p. 5-74
2. Inside rear-view mirror p. 4-08
3. Room lamp p. 5-74, 8-24, 8-32
4. Lock switch* p. 1-09
5. Electric window control switch* p. 1-08
6. Seat belts p. 2-09
7. Head restraints p. 2-08
8. Tools*1 p. 6-07
9. Jack p. 6-07
10. Accessory socket* p. 5-73
11. Floor console box* p. 5-77
12. Jack handle p. 6-07
13. Front seats p. 2-03
14. Bottle holder p. 5-80
15. Sun visors p. 5-70

NOTE:*1- Tools differ according to the vehicle model.

AA5010484

Interior (Club cab)

E00100204682

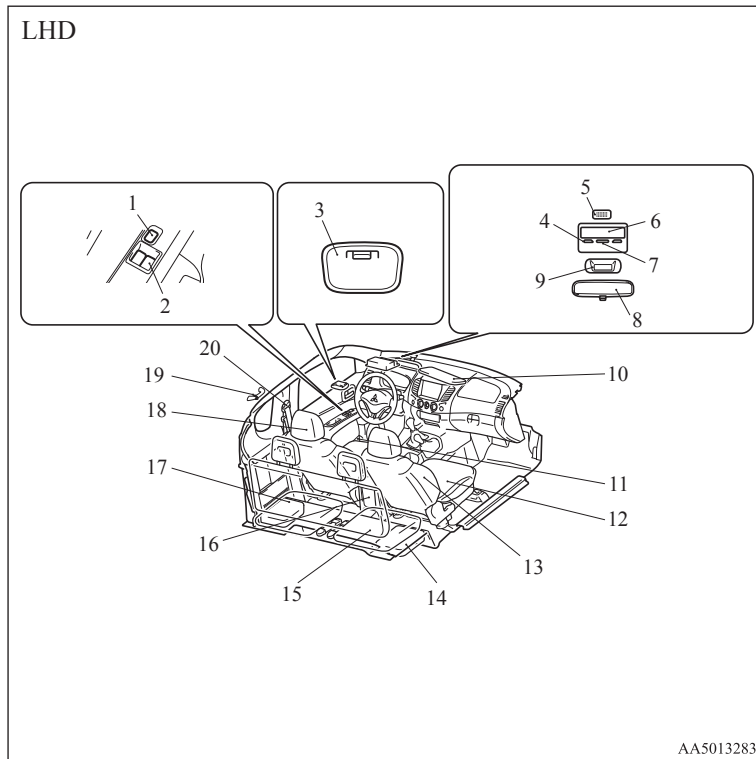

1. Lock switch* p. 1-09
2. Electric window control switch* p. 1-08
3. Room lamp (rear) p. 5-74, 8-24, 8-32
4. Personal lamps* p. 5-75, 8-24, 8-32
5. Microphone (for Hands-free & voice recognition)* p. 5-53
6. Sunglasses holder* p. 5-78
7. Room lamp (front)* p. 5-74, 8-24, 8-32
8. Inside rear-view mirror p. 4-08
9. Digital clock* p. 5-74
10. Sun visors p. 5-70
 - Card holder p. 5-70
 - Vanity mirror p. 5-71
11. Bottle holder p. 5-80
12. Front seats p. 2-03
13. Supplemental restraint system (SRS) - side airbag (for front seat)* p. 2-34
14. Secret box p. 5-78
15. Rear seat* p. 2-07
16. Floor console box p. 5-77
 - Accessory socket p. 5-73
 - Auxiliary Audio connector (RCA)* p. 5-40
17. Jack p. 6-07
 - Jack handle p. 6-07
 - Tools p. 6-07
18. Head restraints p. 2-08
19. Coat hook* p. 5-81
20. Seat belts p. 2-09
 - Adjustable seat belt anchor p. 2-11

RHD

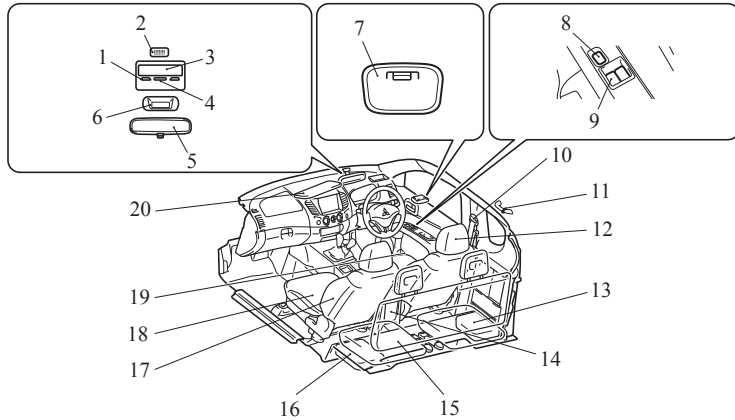

AA5013296

1. Personal lamps* p. 5-75, 8-24, 8-32
2. Microphone (for Hands-free & voice recognition)* p. 5-53
3. Sunglasses holder* p. 5-78
4. Room lamp (front)* p. 5-74, 8-24, 8-32
5. Inside rear-view mirror p. 4-08
6. Digital clock* p. 5-74
7. Room lamp (rear) p. 5-74, 8-24, 8-32
8. Lock switch* p. 1-09
9. Electric window control switch* p. 1-08
10. Seat belts p. 2-09
 - Adjustable seat belt anchor p. 2-11
11. Coat hook* p. 5-81
12. Head restraints p. 2-08
13. Secret box p. 5-78
14. Floor console box p. 5-77
 - Accessory socket p. 5-73
 - Auxiliary Audio connector (RCA)* p. 5-40
15. Rear seat* p. 2-07
16. Jack p. 6-07
 - Jack handle p. 6-07
 - Tools p. 6-07
17. Supplemental restraint system (SRS) - side airbag (for front seat)* p. 2-34
18. Front seats p. 2-03
19. Bottle holder p. 5-80
20. Sun visors p. 5-70
 - Card holder p. 5-70
 - Vanity mirror p. 5-71

Interior - front area (Double cab)

E00100204695

LHD

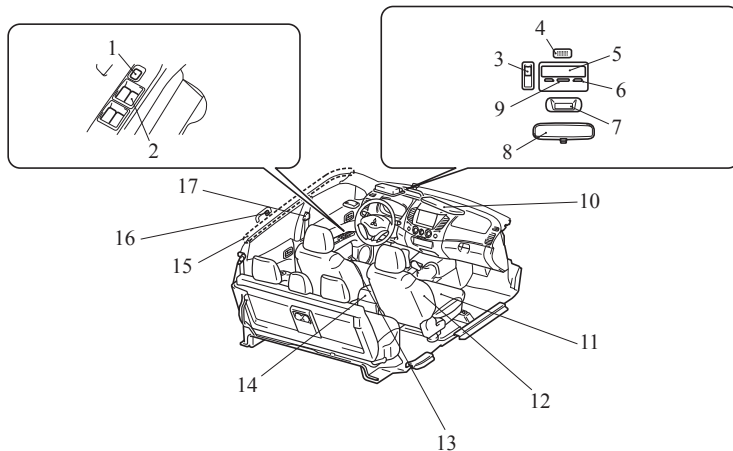

AA5013300

1. Lock switch* p. 1-09
2. Electric window control switch* p. 1-08
3. Sunroof switch* p. 1-13
4. Microphone (for Hands-free & voice recognition)* p. 5-53
5. Sunglasses holder p. 5-78
6. Personal lamps p. 5-75, 8-24, 8-32
7. Digital clock* p. 5-74
8. Inside rear-view mirror p. 4-08
9. Room lamp (front) p. 5-74, 8-24, 8-32
10. Sun visors p. 5-70
 - Card holder p. 5-70
 - Vanity mirror p. 5-71
11. Front seats p. 2-03
12. Supplemental restraint system (SRS) - side airbag (for front seat)* p. 2-34
13. Bottle holder p. 5-80
14. Floor console box p. 5-77
 - Accessory socket* p. 5-73
 - Auxiliary Audio connector (RCA)* p. 5-40
15. Supplemental restraint system (SRS) - curtain airbag* p. 2-34
16. Coat hook* p. 5-81
17. Seat belts p. 2-09
 - Adjustable seat belt anchor (front seats) p. 2-11

RHD

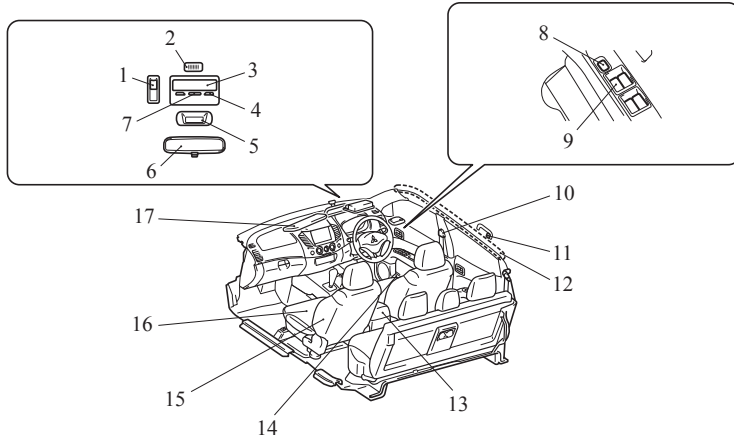

AA5013313

1. Sunroof switch* p. 1-13
2. Microphone (for Hands-free & voice recognition)* p. 5-53
3. Sunglasses holder p. 5-78
4. Personal lamps p. 5-75, 8-24, 8-32
5. Digital clock* p. 5-74
6. Inside rear-view mirror p. 4-08
7. Room lamp (front) p. 5-74, 8-24, 8-32
8. Lock switch* p. 1-09
9. Electric window control switch* p. 1-08
10. Seat belts p. 2-09
- Adjustable seat belt anchor (front seats) p. 2-11
11. Coat hook* p. 5-81
12. Supplemental restraint system (SRS) - curtain airbag* p. 2-34
13. Floor console box p. 5-77
- Accessory socket* p. 5-73
- Auxiliary Audio connector (RCA)* p. 5-40
14. Bottle holder p. 5-80
15. Supplemental restraint system (SRS) - side airbag (for front seat)* p. 2-34
16. Front seats p. 2-03
17. Sun visors p. 5-70
- Card holder p. 5-70
- Vanity mirror p. 5-71

Interior - rear area (Double cab)

E00100201144

LHD

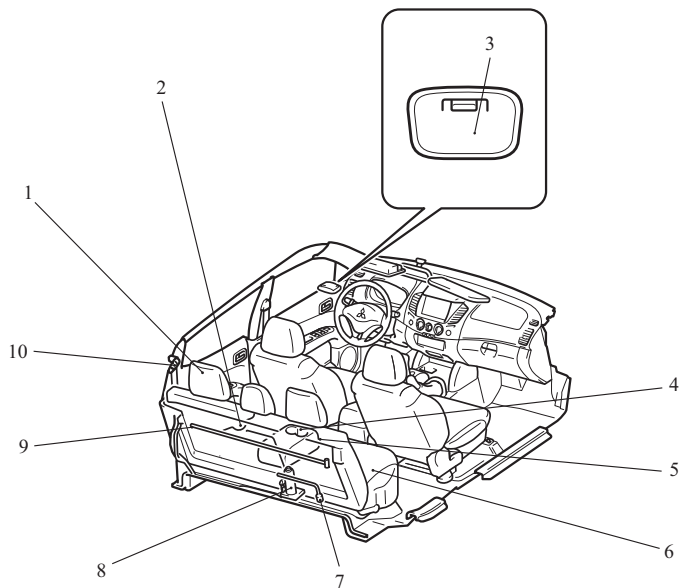

AA5004290

1. Head restraints p. 2-08
2. Bottle holder p. 5-80
3. Room lamp (rear)* p. 5-74, 8-24, 8-32
4. Cup holder p. 5-79
5. Armrest (for rear seat) p. 2-07
6. Rear seats p. 2-07
7. Tools*¹ p. 6-07
8. Jack p. 6-07
9. Jack handle*¹ p. 6-07
10. Seat belts (for rear seats) p. 2-09

NOTE:*¹- Tools differ according to the vehicle model.

RHD

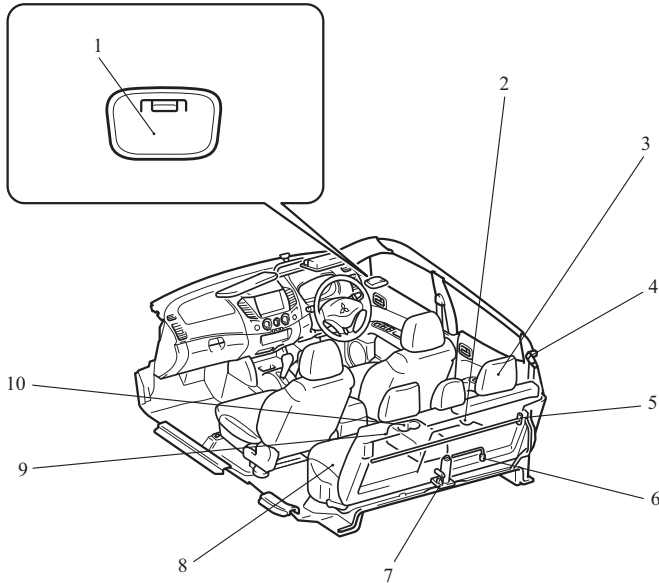

AA5004232

1. Room lamp (rear)* p. 5-74, 8-24, 8-32
2. Bottle holder p. 5-80
3. Head restraints p. 2-08
4. Seat belts (for rear seats) p. 2-09
5. Jack handle*1 p. 6-07
6. Tools*1 p. 6-07
7. Jack p. 6-07
8. Rear seats p. 2-07
9. Armrest (for rear seat) p. 2-07
10. Cup holder p. 5-79

NOTE:*1- Tools differ according to the vehicle model.

Exterior - front (Single cab)

E00100503952

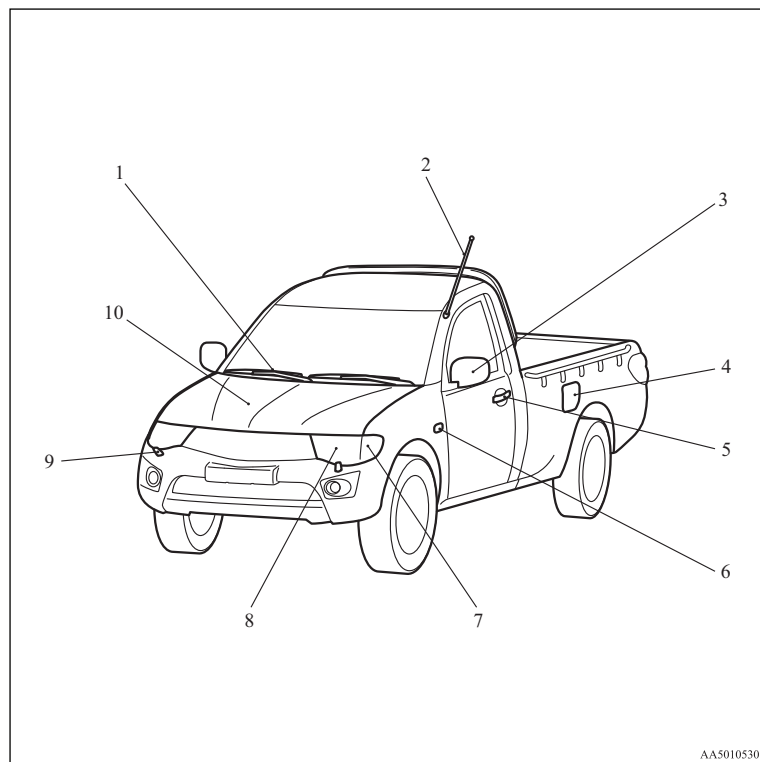

1. Wiper and washers p. 3-36
2. Antenna p. 5-51
3. Outside rear-view mirrors p. 4-09
4. Fuel tank filler door p. 02
5. Locking and unlocking p. 1-02
6. Side turn-signal lamps p. 3-33, 8-24, 8-28
7. Front turn-signal lamps p. 3-33, 8-24, 8-27
8. Headlamps p. 3-30, 8-24, 3-31
Position lamps p. 3-30, 8-24, 8-27
9. Headlamp washers* p. 3-39
10. Engine compartment p. 9-21
Bonnet p. 8-03

AA5010530

Exterior - rear (Single cab)

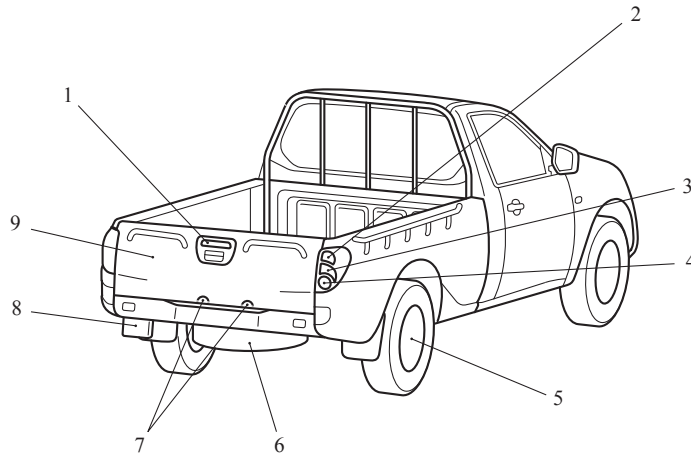

AA5008940

1. High-mounted stop lamp p. 8-24, 8-31
2. Rear turn-signal lamps p. 3-33, 8-24, 8-30
3. Stop and tail lamps p. 3-30, 8-24, 8-30
4. Reversing lamps p. 8-24, 8-30
5. Tyre inflation pressures p. 8-12
 - Changing tyres p. 6-17
 - Tyre rotation p. 8-13
 - Tyre chains p. 8-14
6. Spare wheel p. 6-16
7. Licence plate lamps p. 3-30, 8-24, 8-31
8. Rear fog lamp (Driver's side only) p. 3-35, 8-24, 8-29
9. Rear gate p. 1-11

Exterior - front (Club cab)

E00100505448

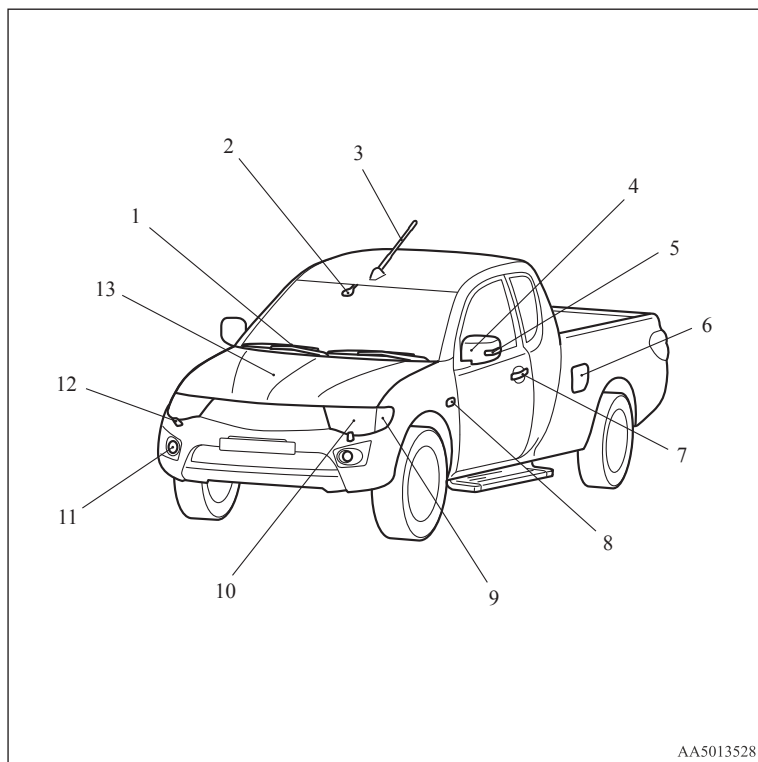

- 1. Wiper and washers p. 3-36
- 2. Rain sensor* p. 3-36
- 3. Antenna p. 5-51
- 4. Outside rear-view mirrors p. 4-09
- 5. Side turn-signal lamps* p. 3-33, 8-24, 8-28
- 6. Fuel tank filler door p. 02
- 7. Locking and unlocking p. 1-02
Keyless entry system* p. 1-04
- 8. Side turn-signal lamps* p. 3-33, 8-24, 8-28
- 9. Front turn-signal lamps p. 3-33, 8-24, 8-27
- 10. Headlamps p. 3-30, 8-24, 3-31
Position lamps p. 3-30, 8-24, 8-27
- 11. Front fog lamps* p. 3-34, 8-24, 8-28
- 12. Headlamp washers* p. 3-39
- 13. Bonnet p. 8-03
Engine compartment p. 9-21

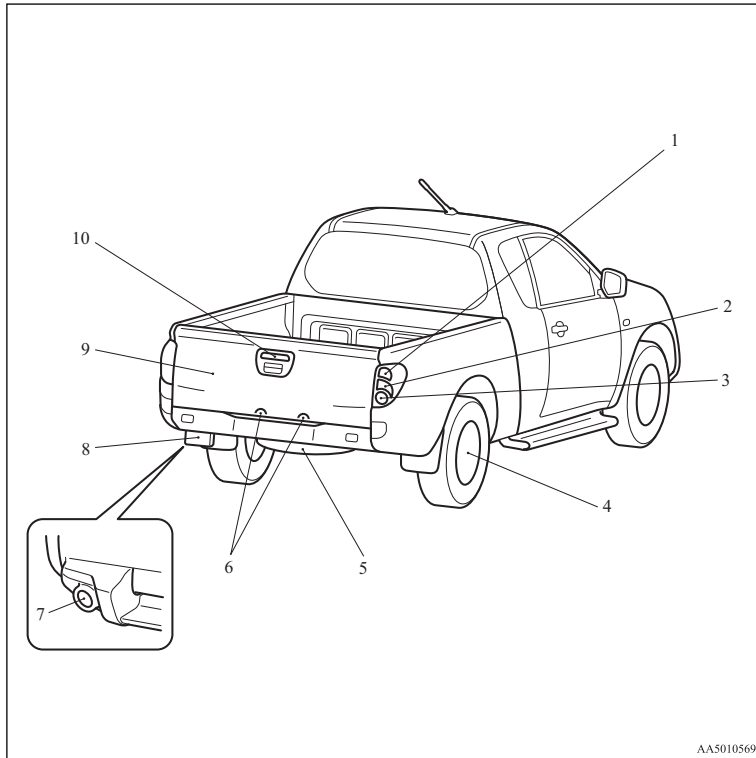
Exterior - rear (Club cab)

AA5010569

1. Rear turn-signal lamps p. 3-33, 8-24, 8-30
2. Stop and tail lamps p. 3-30, 8-24, 8-30
3. Reversing lamps p. 8-24, 8-30
4. Tyre inflation pressures p. 8-12
Changing tyres p. 6-17
Tyre rotation p. 8-13
Tyre chains p. 8-14
5. Spare wheel p. 6-16
6. Licence plate lamps Type 1 p. 3-30, 8-24, 8-31
7. Rear fog lamp (Driver's side only) Type 2* p. 3-35, 8-24, 8-29
8. Rear fog lamp (Driver's side only) Type 1* p. 3-35, 8-24, 8-29
9. Rear gate p. 1-11
10. High-mounted stop lamp p. 8-24, 8-31

Exterior - front (Double cab)

E00100505451

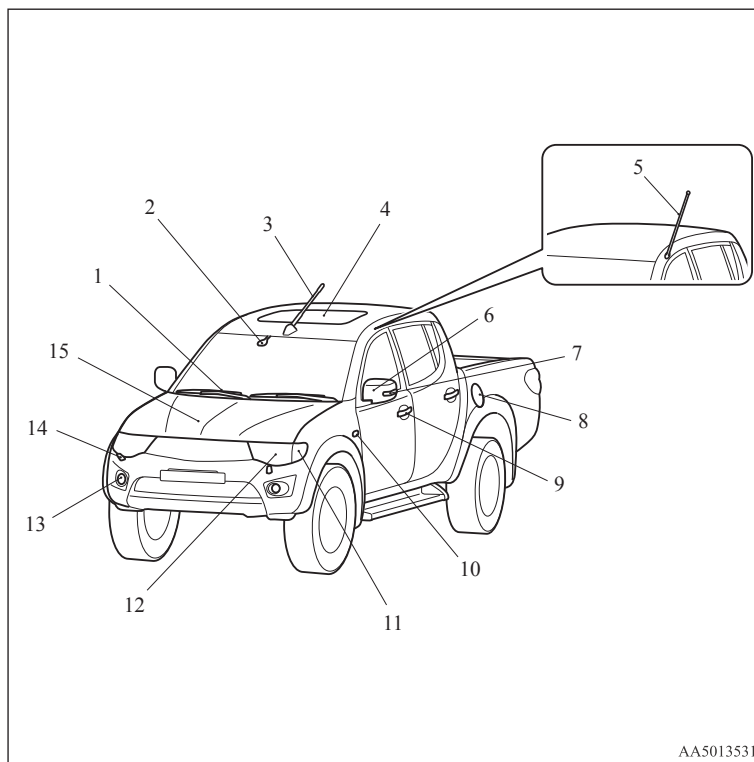

1. Wiper and washers p. 3-36
2. Rain sensor* p. 3-36
3. Antenna* p. 5-51
4. Sunroof* p. 1-13
5. Antenna* p. 5-51
6. Outside rear-view mirrors p. 4-09
7. Side turn-signal lamps* p. 3-33, 8-24, 8-28
8. Fuel tank filler door p. 02
9. Locking and unlocking p. 1-02
Keyless entry system* p. 1-04
10. Side turn-signal lamps* p. 3-33, 8-24, 8-28
11. Front turn-signal lamps p. 3-33, 8-24, 8-27
12. Headlamps p. 3-30, 8-24, 3-31
Position lamps p. 3-30, 8-24, 8-27
13. Front fog lamps* p. 3-34, 8-24, 8-28
14. Headlamp washers* p. 3-39
15. Bonnet p. 8-03
Engine compartment p. 9-21

AA5013531

Exterior - rear (Double cab)

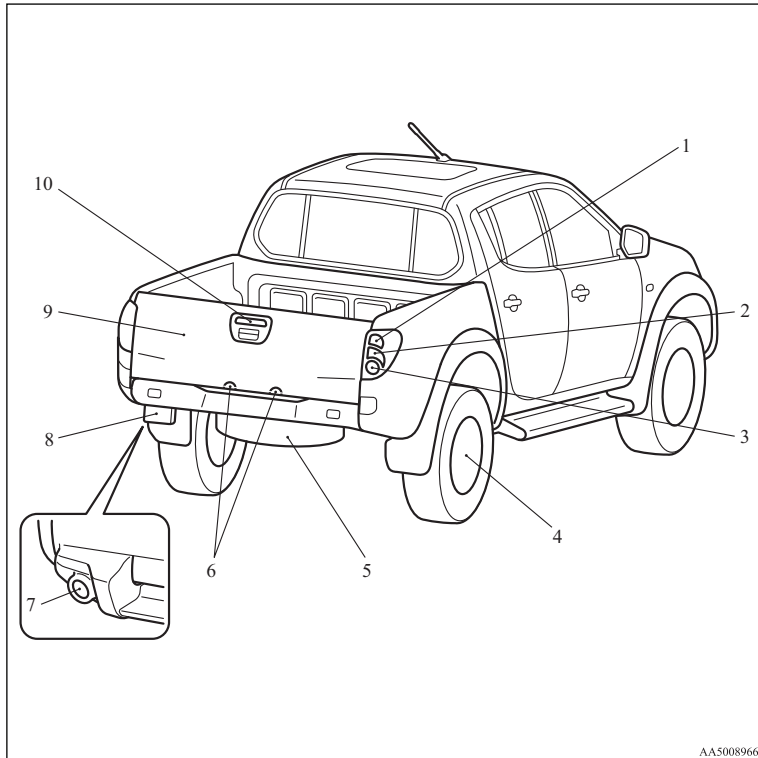

AA5008966

1. Rear turn-signal lamps p. 3-33, 8-24, 8-30
2. Stop and tail lamps p. 3-30, 8-24, 8-30
3. Reversing lamps p. 8-24, 8-30
4. Tyre inflation pressures p. 8-12
Changing tyres p. 6-17
Tyre rotation p. 8-13
Tyre chains p. 8-14
5. Spare wheel p. 6-16
6. Licence plate lamps Type 1 p. 3-30, 8-24, 8-31
7. Rear fog lamp (Driver's side only) Type 2* p. 3-35, 8-24, 8-29
8. Rear fog lamp (Driver's side only) Type 1* p. 3-35, 8-24, 8-29
9. Rear gate p. 1-11
10. High-mounted stop lamp p. 8-24, 8-31

A series of 15 horizontal dashed lines spanning the width of the page, providing a template for handwriting practice.

General information

Fuel selection.....	02
Filling the fuel tank.....	02
Installation of accessories.....	04
Modification/alterations to the electrical or fuel systems.....	04
Genuine parts.....	05
Used engine oils safety instructions and disposal information.....	05
Disposal information for used batteries.....	05

General information

Fuel selection

E00200102907

Recommended fuel	Cetane number (EN590) 51 or higher
------------------	---------------------------------------

CAUTION

- **Your vehicle is designed to use only diesel fuel that meets the EN590 standard. Use of any other type of diesel fuel would adversely affect the engine's performance and durability.**

NOTE

- Due to the separation of paraffin, the fluidity of the fuel decreases considerably as the temperature falls.
Because of this fact there are two kinds of fuel: "summer" and "winter".
This must be considered in winter use.
Select either of the two kinds of fuel in accordance with ambient temperature.
Above -5 °C: "Summer" diesel
Below -5 °C: "Winter" diesel
When travelling abroad, find out in advance about the fuels served in local service stations.

- Poor-quality diesel fuel can cause deposits to form in the injector, resulting in black smoke and rough idling.

If these problems occur, you are advised to add a cleaning additive to the diesel fuel when you refuel the vehicle.

The additive will break up and remove the deposits, thereby returning the engine to a normal condition.

Be sure to use a MITSUBISHI MOTORS GENUINE DIESEL FUEL SYSTEM CLEANER. Using an unsuitable additive could make the engine malfunction. For details, please contact a MITSUBISHI MOTORS Authorized Service Point.

Filling the fuel tank

E00200202025

WARNING

- When handling fuel, comply with the safety regulations displayed by garages and filling stations.
- Before removing the fuel cap, be sure to get rid of your body's static electricity by touching a metal part of the car or the fuel pump. Any static electricity on your body could create a spark that ignites fuel vapour.
- Perform the whole refueling process (opening the fuel tank filler door, removing the fuel cap, etc.) by yourself. Do not let any other person come near the fuel tank filler. If you allowed a person to help you and that person was carrying static electricity, fuel vapour could be ignited.
- Do not move away from the fuel tank filler until refueling is finished. If you moved away and did something else (for example, cleaning your windscreen) part-way through the refueling process, you could pick up a fresh charge of static electricity.
- If the tank cap must be replaced, use only a MITSUBISHI MOTORS original part.

Fuel tank capacity

75 litres

Refueling

1. Before filling with fuel, stop the engine.

- The fuel tank filler is located on the rear left side of your vehicle.

Type 1

Open the fuel tank filler door with the release lever located below the instrument panel.

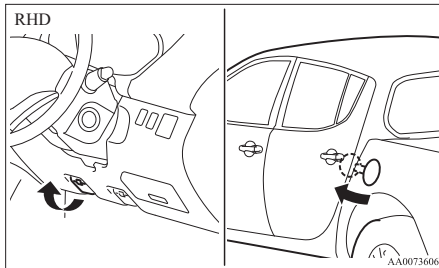
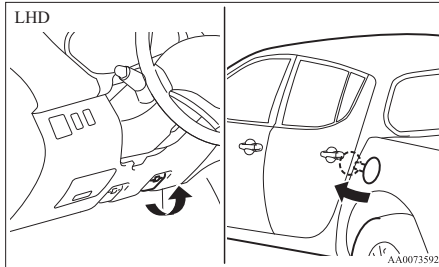

- Open the fuel tank filler tube by slowly turning the cap anticlockwise.

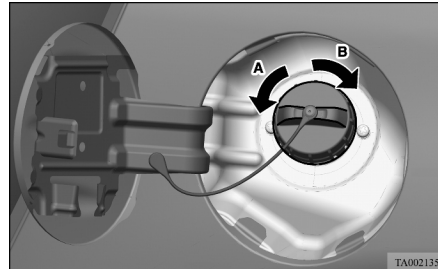

- A- Remove
- B- Close

Type 2

Slide the cover (1). Insert the key in the cap (2) and unlock it. Turn the cap and remove it.

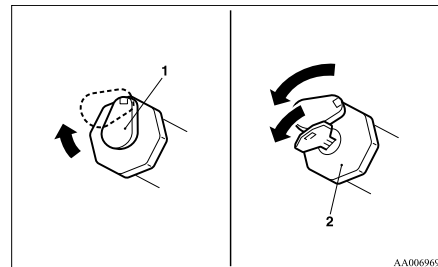

CAUTION

- Since the fuel system may be under pressure, remove the fuel tank filler tube cap slowly. This relieves any pressure or vacuum that might have built up in the fuel tank. If you hear a hissing sound, wait until it stops before removing the cap. Otherwise, fuel may spray out, injuring you or others.

- Insert the gun in the tank port as far as it goes. Do not tilt the gun.
- When the gun stops automatically, do not fill with fuel any more.
- To close, turn the fuel tank filler tube cap slowly clockwise until you hear clicking sounds, then gently push the fuel tank filler door closed.

General information

Installation of accessories

E00200300875

We recommend you to consult your MITSUBISHI MOTORS Authorized Service Point.

- The installation of accessories, optional parts, should only be carried out within the limits prescribed by law in your country, and in accordance with the guidelines fitting instructions and warnings contained within the documents accompanying the parts or accessories.
- Improper installation of electrical components may cause an electrical fire if incorrectly fitted. Please refer to the Modification/alteration to the electrical or fuel systems section within this owner's manual.
- Using a cellular phone or radio set inside the vehicle without an external antenna may cause electrical system interference, which could lead to unsafe vehicle operation.
- Tyres and wheels which do not meet specifications must not be used.
Refer to the "Specifications" section for information regarding wheel and tyre sizes.
- When fitting accessories, ensure that maximum gross vehicle weight and maximum axle weight are not exceeded.

Important points!

Due to large number of accessory and replacement parts of different manufactures available in the market, it is not possible, not only for MITSUBISHI MOTORS, but also for a MITSUBISHI MOTORS Authorized Service Point, to check whether the attachment or installation of such parts affects the overall safety of your MITSUBISHI-vehicle.

Even when such parts are officially authorized, for example by a "general operators permit" (an appraisal for the part) or through the execution of the part in an officially approved manner of construction, or when a single operation permit following the attachment or installation of such parts, it cannot be deduced from that alone, that the driving safety of your vehicle has not been affected.

Consider also that there basically exists no liability on the part of the appraiser or the official. Only in the case of parts (MITSUBISHI MOTORS original replacement or exchange parts as well as MITSUBISHI MOTORS genuine accessories) that are recommended and released by a MITSUBISHI MOTORS Authorized Service Point and that are attached or installed by a MITSUBISHI MOTORS Authorized Service Point can you assume, that optimal safety has been provided. The same also pertains to modifications of MITSUBISHI vehicle with respect to the production specifications. For your own safety, in such cases, you should only undertake modifications according to the recommendations of a MITSUBISHI MOTORS Authorized Service Point.

Modification/alterations to the electrical or fuel systems

E00200400238

MITSUBISHI MOTORS CORPORATION has always manufactured safe, high quality vehicles. In order to maintain this safety and quality, it is important that any accessory that is to be fitted, or any modifications carried out which involve the electrical or fuel systems, should be carried out in accordance with MITSUBISHI guidelines.

CAUTION

- **If the wiring interferes with any part of the vehicle bodywork or improper installation methods are used, i.e. protective fuses not installed, etc.), electronic devices may be adversely affected, possibly resulting in an electrical fire or other failures that may cause an accident.**

Genuine parts

E00200500545

MITSUBISHI MOTORS has gone to great lengths to bring you a superbly crafted automobile offering the highest quality and dependability.

Use MITSUBISHI MOTORS Genuine Parts, designed and manufactured to maintain your MITSUBISHI MOTORS automobile at top performance. MITSUBISHI MOTORS Genuine Parts are identified by this mark and are available at all MITSUBISHI MOTORS Authorized Service Points.

**MITSUBISHI MOTORS
GENUINE PARTS**

Used engine oils safety instructions and disposal information

E00200600025

WARNING

- Prolonged and repeated contact may cause serious skin disorders, including dermatitis and cancer.
- Avoid contact with the skin as far as possible and wash thoroughly after any contact.
- Keep used engine oils out of reach of children.

Protect the environment

It is illegal to pollute drains, water courses and soil. Use authorized waste collection facilities, including civic amenity sites and garages providing facilities for disposal of used oil and used oil filters. If in doubt, contact your local authority for advice on disposal.

Disposal information for used batteries

E00201300029



Your vehicle contains batteries and/or accumulators. Do not mix with general household waste.

For proper treatment, recovery and recycling of used batteries, please take them to applicable collection points, in accordance with your national legislation and the Directives 2006/66/EC. By disposing of these batteries correctly, you will help to save valuable resources and prevent any potential negative effects on human health and the environment which could otherwise arise from inappropriate waste handling.

A series of 15 horizontal dashed lines spanning the width of the page, intended for writing or drawing.

Locking and unlocking

Keys.....	1-02
Electronic immobilizer (Anti-theft starting system).....	1-03
Keyless entry system*.....	1-04
Doors.....	1-06
Central door locks*.....	1-07
“Child-protection” rear doors (Double cab).....	1-08
Manual window control*.....	1-08
Electric window control*.....	1-08
Quarter window (Club cab).....	1-12
Rear gate.....	1-13
Sunroof*.....	1-13

Locking and unlocking

Keys

E00300101608

Two keys are provided. The key fits all locks. Keep one in a safe place as a spare key.

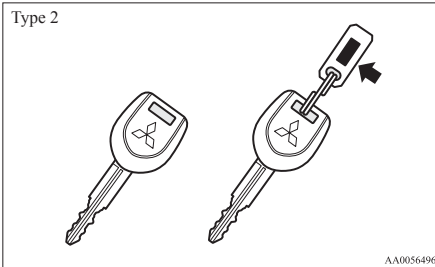
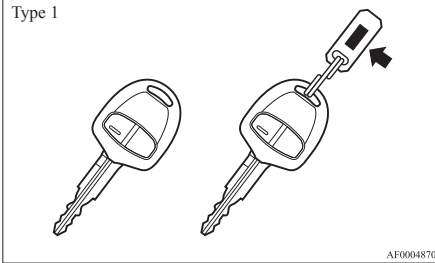

⚠ WARNING

- When taking a key on flights, do not press any switches on the key while on the plane. If a switch is pressed on the plane, the key emits electromagnetic waves, which could adversely affect the plane's flight operation. When carrying a key in a bag, be careful that no switches on the key can be easily pressed by mistake.

NOTE

- The key number is stamped on the tag as indicated in the illustration. Make a record of the key number and store the key and key number tag in separate places, so that you can order a key in the event the original keys are lost.
- The key is a precision electronic device with a built-in signal transmitter. Please observe the following in order to prevent a malfunction.
 - Do not leave in a place that is exposed to direct sunlight, for example on the dashboard.
 - Do not disassemble or modify.
 - Do not excessively bend the key or subject it to strong impacts.
 - Do not expose to water.
 - Keep away from magnetic key holders.
 - Keep away from audio systems, personal computers, TVs, and other equipment that generates a magnetic field.
 - Do not clean with ultrasonic cleaners or similar equipment.

- Do not leave the key where it may be exposed to high temperature or high humidity.
- The engine is designed so that it will not start if the ID code registered in the immobilizer computer and the key's ID code do not match. Refer to the "Electronic immobilizer" section for details and key usage.

Electronic immobilizer (Anti-theft starting system)

E00300200921

The electronic immobilizer is designed to significantly reduce the possibility of vehicle theft. The purpose of the system is to immobilize the vehicle if an invalid start is attempted. A valid start attempt can only be achieved (subject to certain conditions) using a keyless operation system “registered” to the immobilizer system.

NOTE

- In the following cases, the vehicle may not be able to receive the registered ID code from the key. This means the engine will not start even when the registered key is turned to the “START” position.
 - When the key contacts a key ring or other metallic or magnetic object (Type A)
 - When the key grip contacts metal of another key (Type B)
 - When the key contacts or is close to other immobilizing keys (including keys of other vehicles) (Type C)

In cases like these, remove the object or additional key from the vehicle key and turn the key back to the “ACC” or “LOCK” position. Then try again to start the engine.

If the engine does not start, we recommend you to contact your MITSUBISHI MOTORS Authorized Service Point.

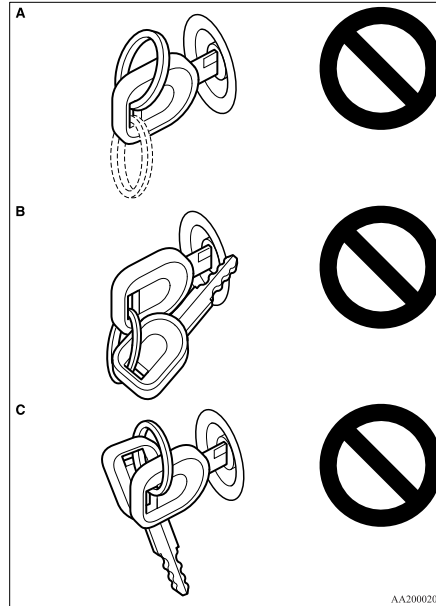

- Two keys are provided. If you lose one of them, order a replacement as soon as possible. To obtain a key, take your vehicle and all remaining keys to a MITSUBISHI MOTORS Authorized Service Point. If you need an extra spare key, take your vehicle and all the keys to a MITSUBISHI MOTORS Authorized Service Point. All the keys have to be re-registered in the immobilizer computer unit. The immobilizer allows up to 8 different ID codes to be registered; you can register a maximum of 8 keys for use.

⚠ CAUTION

- **Don't make any alterations or additions to the immobilizer system; alterations or additions could cause failure of the immobilizer.**

Locking and unlocking

Keyless entry system*

E00300301860

Press the remote control switch, and all doors will be locked or unlocked as desired.

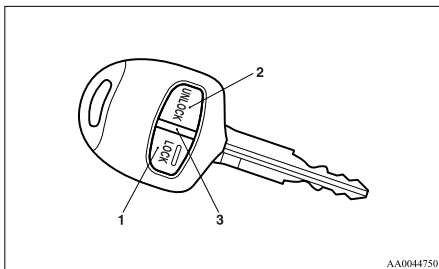

- 1- LOCK switch
- 2- UNLOCK switch
- 3- Indication lamp

To lock

Press the LOCK switch (1), and all doors will be locked. When they are locked with the room lamp at the [•] position, the room lamp and the turn-signal lamps blink once.

To unlock

Press the UNLOCK switch (2), and all doors will be unlocked. When unlocked with the room lamp at the [•] position, the room lamp will be turned on for approximately 15 seconds and the turn-signal lamps will blink twice.

NOTE

- The indication lamp (3) comes on each time a switch is pressed.

- If the UNLOCK switch (2) is pressed and any of the doors is not opened within approximately 30 seconds, relocking will automatically occur.
- It is possible to modify functions as follows: For further information, please contact your MITSUBISHI MOTORS Authorized Service Point.
 - The time from pressing the UNLOCK switch (2) to the moment of automatic locking can be changed.
 - The confirmation function (flashing of the turn-signal lamps) can be set to operate only when the doors are locked or only when the doors are unlocked.
 - The confirmation function (this indicates locking or unlocking of the doors with the blink of the turn-signal lamps) can be deactivated.
 - The number of times the turn-signal lamps are flashed by the confirmation function can be changed.
- The keyless entry system does not operate in the following conditions:
 - The key is left in the key cylinder.
 - The door is open.
- The remote control switch will operate within approximately 4 m from the vehicle. However, the operating range of the remote control switch may change if the vehicle is located near a power station, or radio/TV broadcasting station.
- If either of the following problems occurs, the battery may be exhausted.
 - The remote control switch is operated at the correct distance from the vehicle, but the doors are not locked/unlocked in response.

- The indication lamp (3) is dim or does not come on.

For further information, please contact your MITSUBISHI MOTORS Authorized Service Point.

If you replace the battery yourself, refer to "Procedure for replacing the remote control switch battery" on page 1-04.

- If your remote control switch is lost or damaged, please contact your MITSUBISHI MOTORS Authorized Service Point for a replacement remote control switch.
- If you wish to add a remote control switch, we recommend you to contact a MITSUBISHI MOTORS Authorized Service Point.

A maximum of 4 remote control switches are available for your vehicle.

Procedure for replacing the remote control switch battery

E00309500190

1. Before replacing the battery, remove static electricity from your body by touching.

2. Remove the screw (A) from the remote control switch.

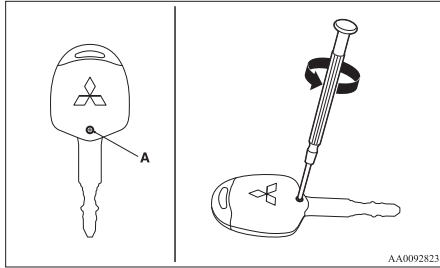

3. With the MITSUBISHI mark facing you, insert the cloth-covered tip of a straight blade (or minus) screwdriver into the notch in the remote control switch case and use it to open the case.

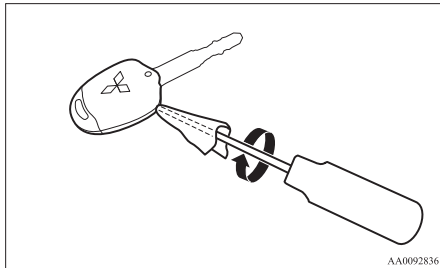

NOTE

- Be sure to perform the procedure with the MITSUBISHI mark facing you. If the MITSUBISHI mark is not facing you when you open the remote control switch case, the switches may come out.

4. Remove the remote control transmitter from the remote control switch case. Then, open the remote control transmitter using the method described in step 3.

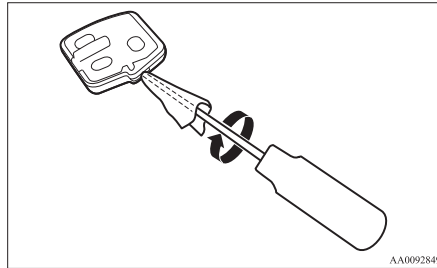

5. Remove the old battery.

6. Install a new battery with the + side (B) down.

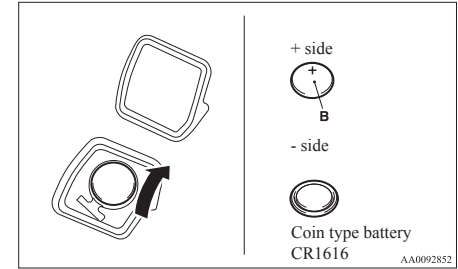

7. Close the remote control transmitter firmly.
8. Place the remote control transmitter in the remote control switch case, then securely close the remote control switch case.
9. Attach the screw (A) removed in step 2.
10. Check the keyless entry system to see that it works.

NOTE

- You may purchase a replacement battery at an electric appliance store.
- A MITSUBISHI MOTORS Authorized Service Point can replace the battery for you if you prefer.

⚠ CAUTION

- When the remote control switch case is opened, be careful to keep water, dust, etc. out. Also, do not touch the internal components.

Doors

E00300401584

CAUTION

- Make sure the doors are closed: driving with doors not completely closed is dangerous.
- Never leave children in the vehicle unattended.
- Be careful not to lock the doors while the key is inside the vehicle.

1

NOTE

- To prevent the key from being locked inside the vehicle, neither the lock knob on the driver's door nor the key can be used to lock the driver's door when it is open.

To lock or unlock with the key

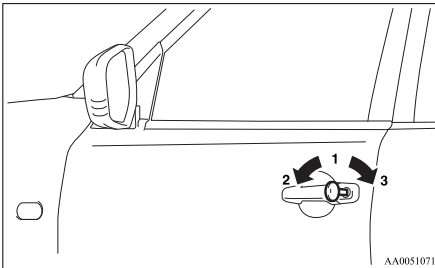

- 1- Insert or remove the key
- 2- Lock
- 3- Unlock

To lock or unlock from inside the vehicle

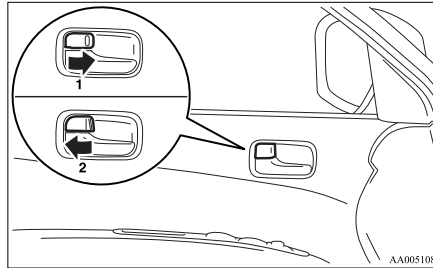

- 1- Lock
- 2- Unlock

Pull the inside door handle towards you to open the door.

NOTE

- The driver's door can be opened without using the lock knob by pulling on the inside door handle.
If your vehicle is equipped with the central door lock system, all other doors are unlocked at the same time.

To lock without using the key

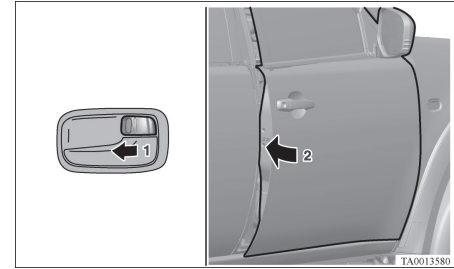

Set the inside lock knob (1) to the locked position, and close the door (2).

NOTE

- The driver's door cannot be locked using the inside lock knob while the driver's door is opened.

Central door locks*

E00300801504

NOTE

- Each of the doors can be locked or unlocked independently by using the inside lock knob.
- Repeated continuous operation between lock and unlock could activate the central door locking systems built-in protection circuit and prevent the system from operating. If this occurs, wait about 1 minute before operating the inside lock knob or the key.

All of the doors can be locked and unlocked as described hereafter.

Driver's door with key

Turn the key in the driver's door towards the front of the vehicle to lock the doors and towards the rear of the vehicle to unlock the doors.

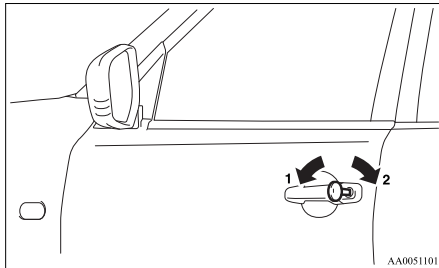

- 1- Lock
2- Unlock

Driver's door with inside lock knob

Set the inside lock knob on the driver's door towards the front of the vehicle to lock the doors. Set it towards the rear of the vehicle to unlock the doors.

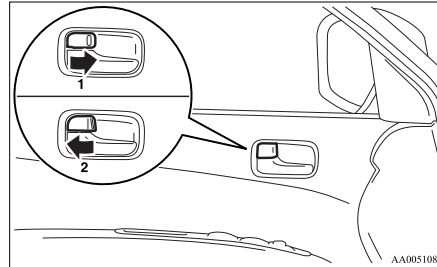

- 1- Lock
2- Unlock

Unlocking doors using selector lever (vehicle with keyless entry system)

It is possible to unlock all of the doors using the selector lever by placing in the "P" position while the ignition switch is in the "ON" position.

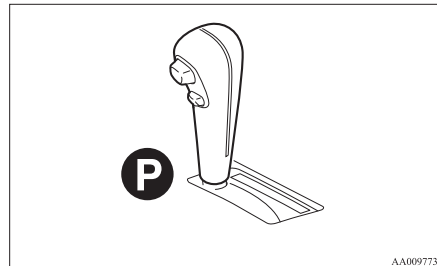

NOTE

- The vehicle is shipped from the factory with a setting established such that the doors are not unlocked when the selector lever is placed in the in the "P" position with the ignition switch in the "ON" position. If you wish to change the setting such that the doors are unlocked, contact your MITSUBISHI MOTORS Authorized Service Point.

Locking and unlocking

“Child-protection” rear doors (Double cab)

E00300900742

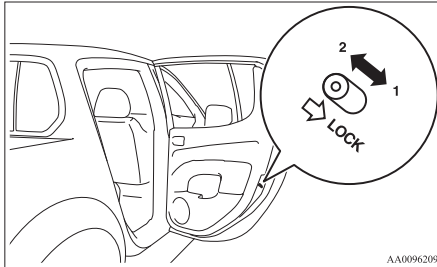

- 1- Lock
2- Unlock

Child protection helps prevent doors from being opened accidentally, especially when small children are in the rear seat.

A lever is provided on each rear door.

If the lever is set to the locked position, the rear door cannot be opened using the inside handle.

To open the rear door while the child protection is in use, pull the outside door handle.

If the lever is set to the “Unlock” position, the child protection mechanism does not function.

CAUTION

- When driving with a child in the rear seat, please use the child protection to prevent accidental door opening which may cause an accident.

Manual window control*

E00302100067

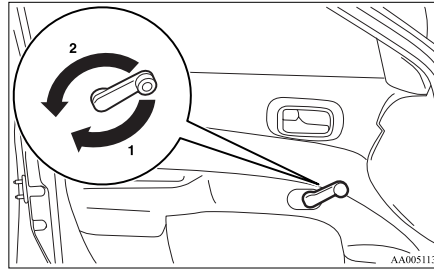

- 1- To open
2- To close

Electric window control*

E00302200127

The electric windows can only be operated with the ignition switch in the “ON” position.

WARNING

- Before operating the electric window control, make sure that nothing can get trapped (head, hand, finger, etc.).
- Never leave the vehicle without removing the key.
- Never leave a child (or other person who might not be capable of safe operation of the electric window control) in the vehicle alone.
- The child may tamper with the switch at the risk of its hands or head being trapped in the window.

Electric window control switch

E00302301431

Each window opens or closes while the corresponding switch is operated.

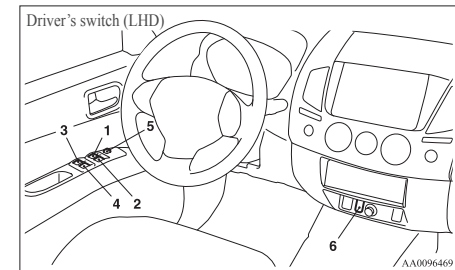

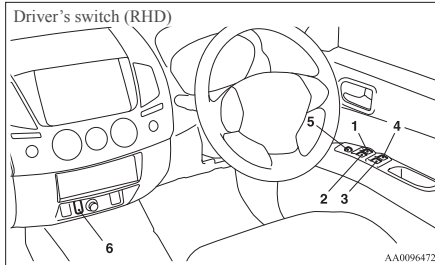

- 1- Driver's door window
- 2- Front passenger's door window
- 3- Rear left door window (Double cab)
- 4- Rear right door window (Double cab)
- 5- Lock switch
- 6- Rear retractable power window (Double cab)*

The switches can be used to operate all door windows. A window can be opened or closed by operating the corresponding switch. Press the switch down to open the window, and pull up the switch to close it.

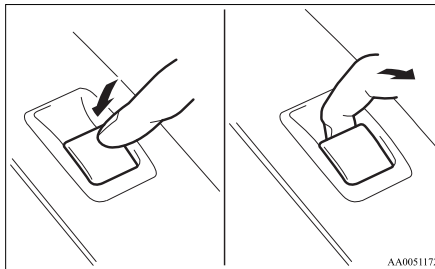

If the switch is fully pressed down/pulled up, the door window automatically opens/closes completely. If you want to stop the window movement, operate the switch lightly in the reverse direction.

NOTE

- Repeated operation with the engine stopped will run down the battery. Operate the window switches only while the engine is running.
- The rear door windows only open halfway.

Rear retractable power window switch (Double cab)*

The rear retractable power window switch can be used to operate the rear retractable power window. The rear retractable power window stops in three positions: the fully closed position, a ventilation position, and the fully open position.



- 1- Close
- 2- Open

NOTE

- It is not possible to stop the rear retractable power window in any position other than the fully closed position, ventilation position, and fully open position. If the rear retractable power window is opened while the rear window demister is operating, the rear window demister automatically stops. When the rear retractable power window is subsequently fully closed, the behaviour of the rear window demister depends upon the elapsed time of the rear window demister's timer. (The timer runs for about 20 minutes in total.)
 - If the rear window demister's timer is running, the rear window demister restarts for the remaining time.
 - If the rear window demister's timer has finished, the rear window demister does not operate. If you wish to activate the rear window demister, press the rear window demister switch again.

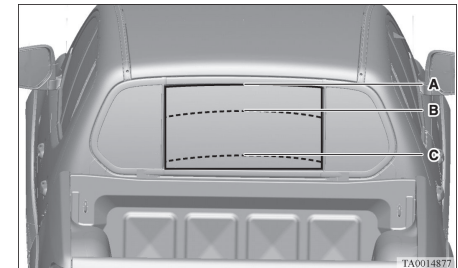

Locking and unlocking

A- Fully closed position

In this position, the rear retractable power window is fully closed.

To place the rear retractable power window in the fully closed position, firmly press the rear retractable power window switch (1).

B- Ventilation position

In this position, the rear retractable power window is slightly open.

To place the rear retractable power window in the ventilation position, lightly press the rear retractable power window switch (1) or (2).

⚠ WARNING

- In each of the following circumstances, the operating direction of the rear retractable power window switch and the operating direction of the rear retractable power window do not match each other. Exercise caution to avoid the risk of accidentally trapping a hand or your head when operating the rear retractable power window.
 - Even if the rear retractable power window switch (1) is lightly pressed while the rear retractable power window is moving from the fully closed position towards the ventilation position, the rear retractable power window does not return to the fully closed position.

⚠ WARNING

- Even if the rear retractable power window switch (2) is lightly pressed while the rear retractable power window is moving from the fully open position towards the ventilation position, the rear retractable power window does not return to the fully open position.

C- Fully open position

In this position, the rear retractable power window is fully open.

To place the rear retractable power window in the fully open position, firmly press the rear retractable power window switch (2).

⚠ WARNING

- If the rear retractable power window switch (1) is lightly pressed while the rear retractable power window is moving from the fully closed position towards the fully open position, the rear retractable power window will come up to the ventilation position. To avoid the risk of accidentally trapping a hand or your head, do not operate the switch while the rear retractable power window is moving.

NOTE

- The rear retractable power window only opens halfway.

Lock switch

E00303100396

When this switch is operated, the passenger's switches and the rear retractable power window switch cannot be used to open or close the windows. To unlock, press it once again.

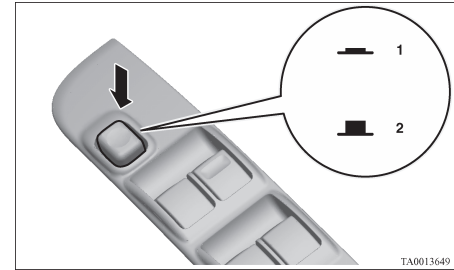

- 1- Lock
2- Unlock

NOTE

- The driver's switch can open or close any door windows.

⚠ WARNING

- A child may tamper with the switch at the risk of its hands or head being trapped in the window. When driving with a child in the vehicle, please press the window lock switch to disable the passenger's switches and rear retractable power window switch.

Timer function

E00302400709

Door's window

The door windows can be opened or closed for 30 seconds after the ignition switch is turned from the "ON" position to the "ACC" or "LOCK" position. If the driver's door is opened during this period, the door window can be opened or closed for another 30 seconds.

However, once the driver's door is closed, the windows cannot be operated.

Rear retractable power window

The rear retractable power window can be opened or closed for 30 seconds after the ignition switch is turned from the "ON" position to the "ACC" or "LOCK" position.

If the driver's door is opened during this period, the rear retractable power window can be opened or closed for another 30 seconds.

However, once the driver's door is closed, the rear retractable power window cannot be operated.

Safety mechanism

E00302500537

Door's window

If a hand or head is trapped in the closing power window, it will lower automatically.

Nonetheless, make sure that nobody puts their head or hand out of the power window when closing a power window.

The lowered window will become operational after a few seconds.

WARNING

- If the safety mechanism is activated three or more times successively, the safety mechanism will be temporarily cancelled. If a hand or head got trapped, a serious injury could result.

CAUTION

- The safety mechanism is cancelled just before the power window is fully closed. This allows the power window to close completely. Therefore be especially careful that no fingers are trapped in the power window.

NOTE

- The safety mechanism can be activated if the driving conditions or other circumstances cause the power window to be subjected to a physical shock similar to that caused by a trapped hand or head.
- If the safety mechanism is activated three or more times in a row, the safety mechanism will be cancelled and the power window will not close correctly.

In such a case, the following procedure should be implemented to rectify this situation. Repeatedly raise the appropriate power window switch until that power window has been fully closed. Following this, release the switch, raise the switch once again and hold it in this condition for at least one second, then release it. You should now be able to operate the power window in the normal fashion.

Rear retractable power window

If a hand or head is trapped in the closing rear retractable power window, it will lower automatically. Nonetheless, make sure that nobody puts their head or hand out of the rear retractable power window when closing a rear retractable power window.

The lowered window will become operational after a few seconds.

WARNING

- If the safety mechanism is activated three or more times successively, the safety mechanism will be temporarily cancelled. If a hand or head got trapped, a serious injury could result.

CAUTION

- The safety mechanism is cancelled just before the rear retractable power window is fully closed. This allows the rear retractable power window to close completely. Therefore be especially careful that no fingers are trapped in the rear retractable power window.

NOTE

- The safety mechanism can be activated if the driving conditions or other circumstances cause the rear retractable power window to be subjected to a physical shock similar to that caused by a trapped hand or head.

Locking and unlocking

- If the safety mechanism is activated three or more times in a row, the safety mechanism will be cancelled and the rear retractable power window will not close correctly.

In such a case, the following procedure should be implemented to rectify this situation. Repeatedly press the rear retractable power window switch (1) until that rear retractable power window has been fully closed. Following this, release the switch, press the switch once again and hold it in this condition for at least 1 second, then release it. You should now be able to operate the rear retractable power window in the normal fashion.

1

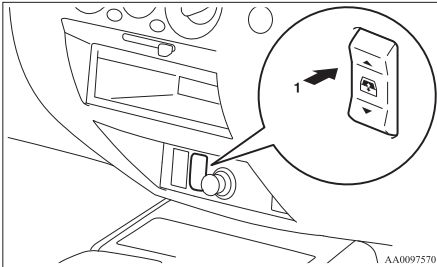

Quarter window (Club cab)

E00302600088

To open

1. Pull the lever towards you.

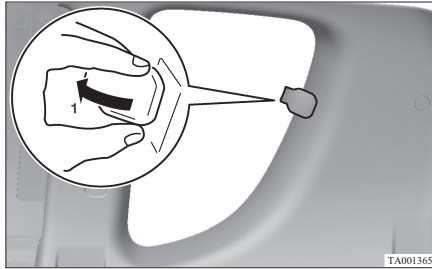

2. Push the lever towards the outside of the vehicle.
3. Push the lever towards the rear of the vehicle to secure it in place.

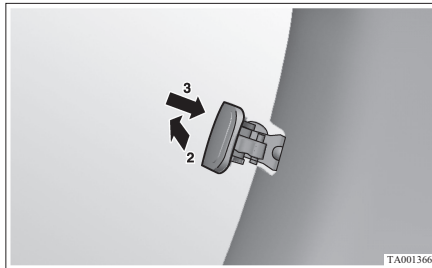

To close

Pull the lever, returning it to its original position and securing it in place.

Rear gate

E00303000050

To open

Lift up the handle and lower the rear gate.

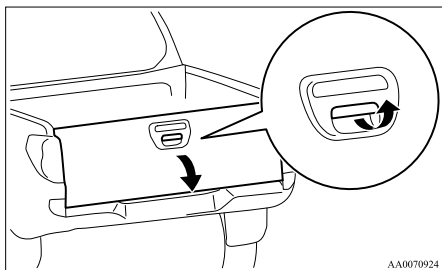

To close

Raise the rear gate and close with enough force to latch the assembly securely into position.

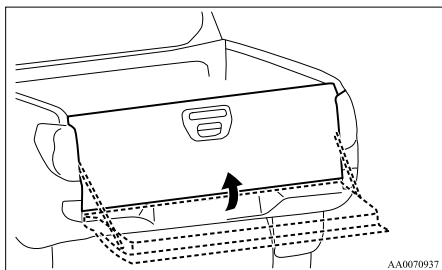

CAUTION

- Do not stand behind the exhaust pipe when loading and unloading luggage. Heat from the exhaust could lead to burns.
- Pay attention not to catch your fingers in the rear gate.
- Do not weight the rear gate.
- Before driving, make sure that the rear gate is securely closed. If the rear gate opens while driving the vehicle, objects stored in the cargo area could fall out onto the road.

Locking and unlocking

Sunroof*

E00302700887

The sunroof can only be operated with the ignition switch in the “ON” position.

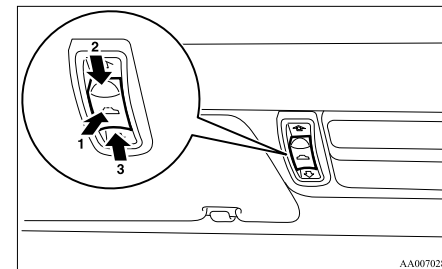

To open

The sunroof automatically opens if the switch (3) is pressed.

To stop the moving sunroof, press the switch (1) or (2).

NOTE

- The sunroof automatically stops just before reaching the fully open position. Press the switch again to fully open it.

To close

The sunroof closes while the switch (2) is pressed.

To tilt up

When the switch (1) is pressed, the rear edge of sunroof rises for ventilation.

To tilt down

The sunroof tilt down while the switch (2) is pressed.

Locking and unlocking

Safety mechanism

E0030380029

If a hand or head is trapped in the closing sunroof, it will reopen automatically. Nonetheless, make sure that nobody puts their head or hand out of the sunroof when opening or closing. The opened sunroof will become operational after a few seconds.

If the safety mechanism is activated 5 or more times consecutively or the switch (1) is kept pressed for 10 seconds or longer with the sunroof stationary in the fully tilted up position, normal closing of the sunroof will be aborted. In such an event, you should take the following steps:

1. Press the switch (1) repeatedly until the sunroof has been fully tilt up.
2. Once the fully tilt up position has been reached, press again and hold the switch (1) for at least 3 seconds.
3. After pressing the switch (3) to perform full opening, press the switch (2) to fully close the sunroof.

NOTE

- The safety mechanism can be activated if the driving conditions or other circumstances cause the sunroof to be subjected to a physical shock similar to that caused by a trapped hand or head.
- Avoid stopping the sunroof before it reaches the opening or closing end during operations. If this should accidentally happen, repeat the process from step 1.



CAUTION

- **The safety mechanism is cancelled just before the sunroof is fully closed. This allows the sunroof to close completely. Therefore be especially careful that no fingers are trapped in the sunroof.**

4. Following this action, it should be possible to operate the sunroof in the normal manner.

Sunshade

E0030790044

Slide the sunshade manually to open and close it.

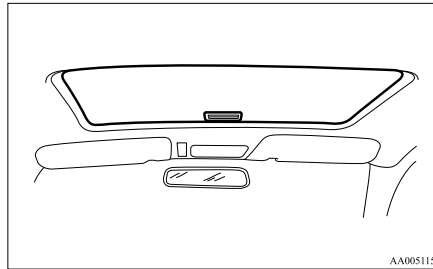

CAUTION

- **Be careful that hands are not trapped when closing the sunshade.**

NOTE

- The sunshade will operate together with the sunroof when the sunroof is opened.

- Be sure to tilt down the sunroof before closing the sunshade.
- The sunshade cannot be closed with the sunroof opened. Do not attempt to close the sunshade when the sunroof is opened.



WARNING

- **Do not put head, hands or anything else out of the sunroof opening while driving the vehicle.**
- **Never leave a child (or other person who might not be capable of safe operation of the sunroof switch) in the vehicle alone.**
- **Before operating the sunroof, make sure that nothing is capable of being trapped (head, hand, finger, etc.).**

NOTE

- The sunroof stops just before reaching the fully open position. If the vehicle is driven with the sunroof in this position, wind throb is lower than with the sunroof fully open.
- When leaving the vehicle unattended, make sure you close the sunroof and remove the ignition key.
- Do not try to operate the sunroof if it is frozen closed (after snow fall or during extreme cold).
- Do not sit or place heavy luggage on the sunroof or roof opening edge.
- Release the switch as soon as the sunroof reaches the fully open or fully closed position.

- If the sunroof does not operate when the sunroof switch is operated, release the switch and check whether something is trapped by the sunroof. If nothing is trapped, we recommend you to have the sunroof checked.
- Depending on the model of ski carriers or roof carriers, the sunroof may make contact with the carrier when the sunroof is tilted up. Be careful when tilting up the sunroof if such a ski carrier or a roof carrier is installed.
- Be sure to close the sunroof completely when washing the vehicle or when leaving the vehicle.
- Be careful, not to put any wax on the weatherstrip (black rubber) around the sunroof opening. If stained with wax, the weatherstrip cannot maintain a weatherproof seal with the sunroof.
- After washing the vehicle or after it has rained, wipe off any water that is on the sunroof before operating it.
- Operating the sunroof repeatedly with the engine stationary will run down the battery. Operate the sunroof while the engine is running.

A series of 15 horizontal dashed lines spanning the width of the page, providing a template for handwriting practice.

Seat and seat belts

Seat.....	2-02
Seat adjustment.....	2-03
Front seat.....	2-03
Rear seat*.....	2-07
Head restraints.....	2-08
Seat belts.....	2-09
Pregnant women restraint.....	2-12
Seat belt pretensioner system and force limiter system*.....	2-12
Child restraint.....	2-13
Seat belt inspection.....	2-26
Supplemental restraint system (SRS) - airbag*.....	2-26

Seat

E00400102042

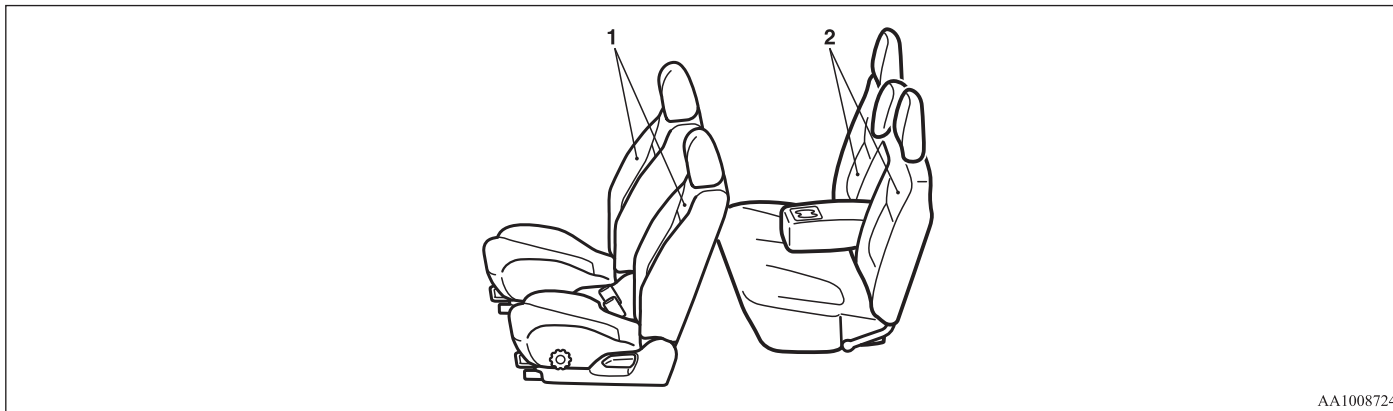

AA1008724

1-Front seat

- To adjust forward or backward → p. 2-03
- To recline the seatback → p. 2-04
- To adjust the seat height (Driver's seat)* → p. 2-05
- To get in and out of the cargo space (Club cab, passenger's seat) → p. 2-06
- Folding the seatback forward (Single cab, passenger's seat)* → p. 2-06
- Heated seats* → p. 2-06

2-Rear seat*

- Folding the seatback forward (Double cab) → p. 2-07
- Folding up the seat cushion (Club cab)* → p. 2-07
- Armrest (Double cab) → p. 2-07

Seat adjustment

E00400300200

Adjust the driver's seat so that you are comfortable and that you can reach the pedals, steering wheel, switches etc. while retaining a clear field of vision.

⚠ WARNING

- Do not attempt to adjust the seat while driving. This can cause loss of vehicle control and result in an accident. After adjustments are made, ensure the seating is locked in position by attempting to move the seat forward and rearward without using the adjusting mechanism.
- It is extremely dangerous to ride in the cargo area (inside or outside) of a vehicle. Also, the cargo area and rear seats should never be used as a play area by children. In a collision, people or children riding unrestrained in these areas are more likely to be seriously injured or killed. Do not allow people or children to ride in any area of your vehicle that is not equipped with seats and seat belts, and make sure that everyone travelling in your vehicle is in a seat and wearing a seat belt, or in the case of a child is strapped in a child restraint.

⚠ WARNING

- To minimize the risk of personal injury in the event of a collision or sudden braking, the seatbacks should always be in the almost upright position while the vehicle is in motion. The protection provided by the seat belts may be reduced significantly when the seatback is reclined. There is greater risk that the passenger will slide under the seat belt, resulting in serious injury, when the seatback is reclined.

⚠ CAUTION

- Make sure the seat is adjusted by an adult or with adult supervision for correct and safe operation.
- Do not place a cushion or the like between your back and the seatback while driving. The effectiveness of the head restraints will be reduced in the event of an accident.
- When sliding the seats, be careful not to catch your hand or foot.
- When sliding or reclining the seat rearward, pay careful attention to the rear seat passengers. (Double cab and Club cab)

Front seat

E0400400012

To adjust forward or backward

E00400500824

Manual type

Pull the seat adjusting lever and adjust the seat forward or backward to the desired position. After adjustment, release the adjusting lever to lock the seat in position.

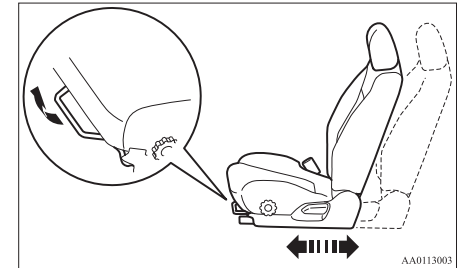

⚠ WARNING

- To ensure the seat is locked securely, try to move the seat forward or backward without using the adjusting lever.

Seat and seat belts

Power type

Adjust the seat by operating the switch as indicated by the arrows.

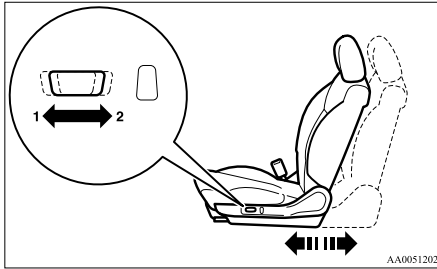

- 1- Adjustment forward
- 2- Adjustment backward

NOTE

- To prevent the battery from running down, operate the power type seat with the engine running.

To recline the seatback

E00400601037

Manual type

In order to recline the seatback, lean forward slightly, pull the seatback lock lever up, and then lean backward to the desired position and release the lever. The seatback will lock in that position.

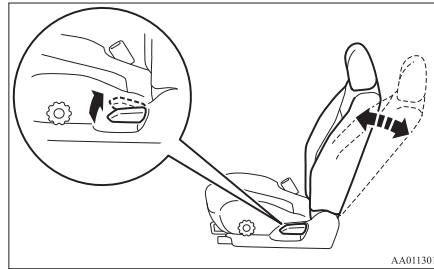

Power type

Adjust the seatback angle by operating the switch as indicated by the arrows.

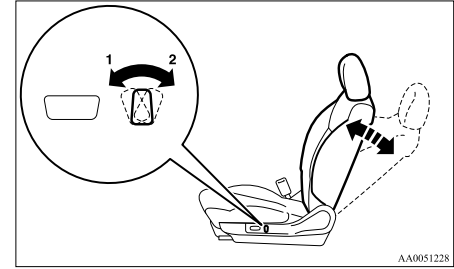

- 1- To move to forward direction
- 2- To recline rearward

NOTE

- To prevent the battery from running down, operate the power type seat with the engine running.

⚠ CAUTION

- The reclining mechanism of the seatback is spring loaded, causing it to return to the vertical position when the lock lever is operated. When operating the lever, sit close to the seatback or hold it with your hand to control its return motion.

To adjust the seat height (Driver's seat)*

E00400701113

Manual type

Dial type

To adjust the seat cushion height, turn the dial as shown in the illustration.

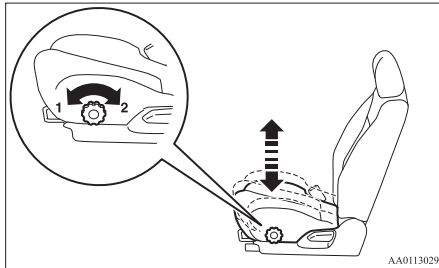

- 1- To move the seat cushion up
- 2- To move the seat cushion down

Lever type

Adjust the seat height by repeatedly operating the lever.

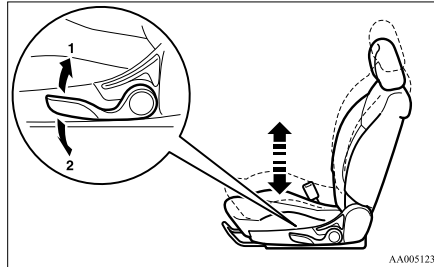

- 1- Raise
- 2- Lower

Power type

To adjust the seat height, operate the switch as indicated by arrows.

NOTE

- To prevent the battery from running down, operate the power type seat with the engine running.

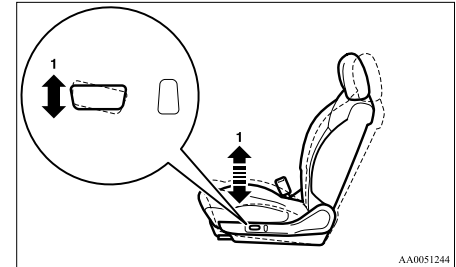

- 1- To move the front of the seat up and down

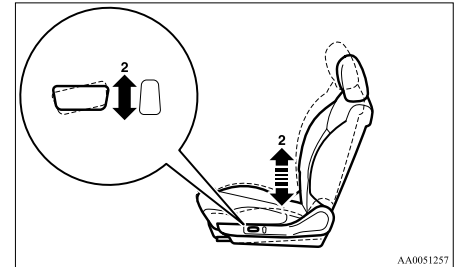

- 2- To move the rear of the seat up and down

Seat and seat belts

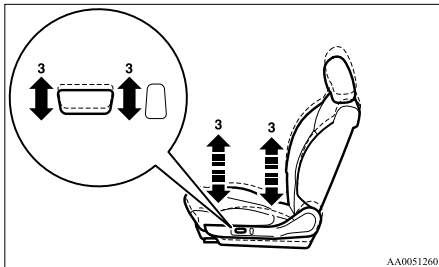

3- To move the whole seat up and down

AA0051260

To get in and out of the cargo space (Club cab, passenger's seat)

E00411000021

The lever can be used to make getting in and out easier.

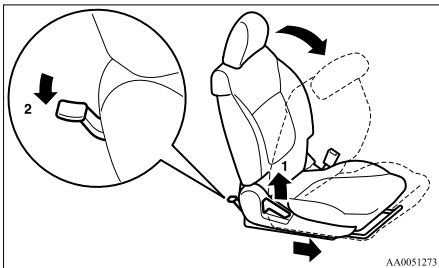

1- To get in or out
2- To get out

AA0051273

When the lever or pedal is used, the seatback will tilt forward and at the same time the entire seat will move forward. To return the seat, slide the entire seat rearward and then raise the seatback rearward to lock the seat in position.

⚠ WARNING

- Do not drive the vehicle with the seatback folded forward. The seat is not retained position if it is not kept in an upright position, so serious injuries could be suffered in the event of hard braking or a collision.

⚠ CAUTION

- The reclining mechanism of the seatback is spring loaded, causing it to return to the vertical position when the lock lever is operated. When using the lever, sit close to the seatback or hold it with your hand.
- Use a foot to operate the pedal (2).

Folding the seatback forward (Single cab, passenger's seat)*

E00410400031

To access the onboard tool kit, fold forward the seatback of the passenger's seat. Refer to "Tools, jack and jack handle" on page 6-07.

Pull the band and fold the seatback forward.

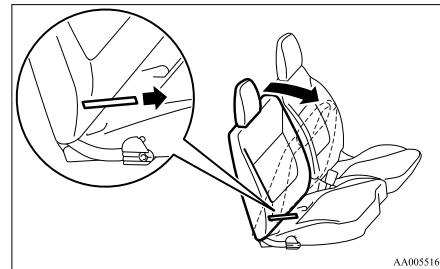

AA0055167

Heated seats*

E00401100784

The heated seats can be operated with the ignition switch in the "ON" position.

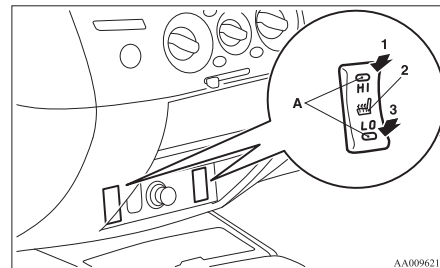

AA0096212

- 1 (HI)- Heater high (for quick heating).
- 2- Heater off.
- 3 (LO)- Heater low (to keep the seat warm).

The indication lamp (A) will illuminate while the heater is on.

CAUTION

- Switch off seat heaters when not in use.
- Operate in the high position for quick heating. Once the seat is warm, set the heater to low to keep it warm. Slight variations in seat temperature may be felt while using the heated seats. This is caused by the operation of the heater's internal thermostat and does not indicate a malfunction.
- If the following types of persons use the heated seats, they might become too hot or receive minor burns (red skin, heat blisters, etc.):
 - Children, elderly or ill people
 - People with sensitive skin
 - Excessively tired people
 - People under the influence of alcohol or sleep inducing medication (cold medicine, etc.)
- Do not place heavy objects on the seat or stick pins, needles, or other pointed objects into it.
- Do not use a blanket, cushion, or other material with high heat insulation properties on the seat while using the heater; this might cause the heater element to overheat
- When cleaning the seat, do not use benzene, kerosene, petrol, alcohol, or other organic solvents; these might damage the surface of the seat and also the heater element.
- If water or any other liquid is spilled on the seat, allow it to dry thoroughly before attempting to use the heater.
- Turn the heater off immediately if it appears to be malfunctioning during use.

Rear seat*

E00401300148

When a person is sitting in the middle seating position of the rear seat, adjust the head restraint to height at which it lock in position. Refer to "Head restraints" on page 2-08.

Folding the seatback forward (Double cab)

E00401600242

Pull up the band on the top of the seatback and fold it forward.

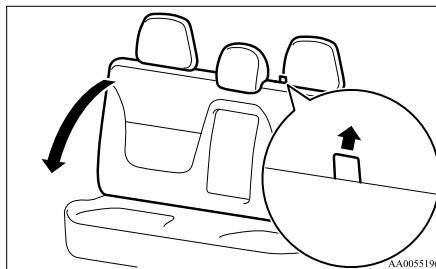

Confirm that the seatback locks securely when it is returned.

Folding up the seat cushion (Club cab)*

E00411300024

The right and left seat cushions can be folded up separately. To fold the seat cushions up, raise the seat cushions.

Securely retain the seat cushion by hooking the retaining band (A) onto the head restraint (B) of the rear seat.

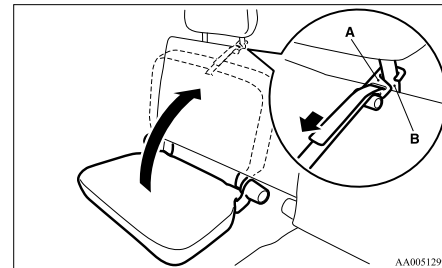

Armrest (Double cab)

E00401700605

To use the armrest, fold it down. To return to the original position, push it backward (into the seatback) until it is level with the seat.

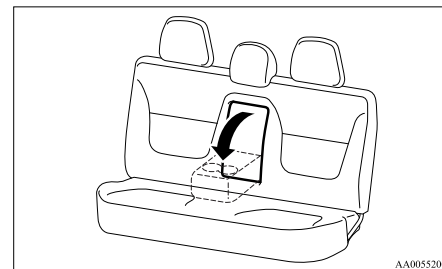

Seat and seat belts

NOTE

- Do not stand or sit on the armrest. It could break.
- The top surface of the armrest contains a cup holder for rear seat occupants. Refer to “Cup holder” on page 5-79.

Head restraints

E00403300995

⚠ WARNING

- **Driving without the head restraints in place can cause you and your passengers serious injury or death in an accident. To reduce the risk of injury in an accident, always make sure the head restraints are installed and properly positioned when the seat is occupied.**
- **Never place a cushion or similar device on the seatback. This can adversely affect head restraint performance by increasing the distance between your head and the restraint.**

To adjust height

Adjust the head restraint height so that the centre of the restraint is as close as possible to eye level to reduce the chances of injury in the event of collision. Any person too tall for the restraint to reach their seated eye level, should adjust the restraint as high as possible.

To raise the head restraint, move it upward. To lower the restraint, move it downward while pushing the height adjusting knob (A) in the direction of the arrow. After adjustment, push the head restraint downward and make sure that it is locked.

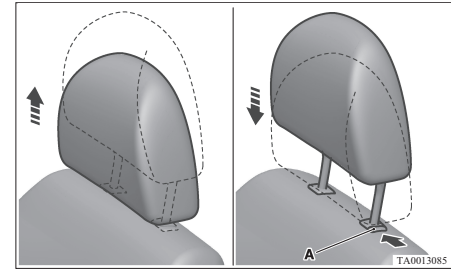

To remove

Lift the head restraint with the height adjusting knob (A) pushed in.

Seat belts

E00404800825

To protect you and your passengers in the event of an accident, it is most important that the seat belts are worn correctly while driving.

A seat belt for a front seat equipped with an airbag has a pretensioner system. These belts are used the same way as a conventional seat belt.

Refer to “Seat belt pretensioner system and force limiter system” on page 2-12 .

To install

Confirm that the head restraint is facing the correct direction, and then insert it into the seatback while pressing the height adjusting knob (A) in the direction indicated by the arrow.

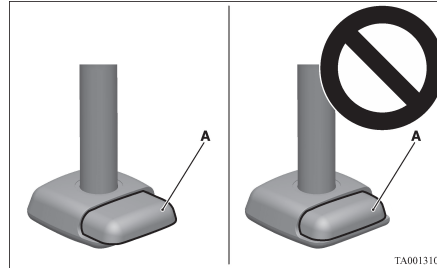
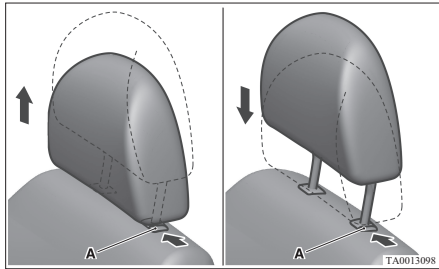

TA0013102

CAUTION

- Confirm that the height adjusting knob (A) is correctly adjusted as shown in the illustration, and also lift the head restraints to ensure that they do not come out of the seatback.

CAUTION

- If your vehicle is equipped with the rear seat head restraint, the head restraints for the front and rear seats differ in size. When installing head restraints, make sure the front and rear head restraints are fitted in their respective seats.

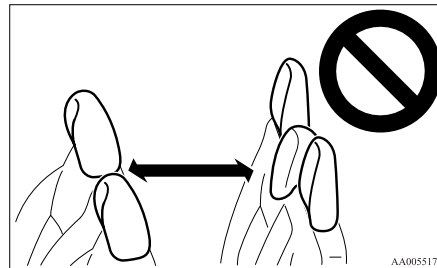

AA0055170

WARNING

- Always place the shoulder belt over your shoulder and across your chest. Never put it behind you or under your arm.
- One seat belt should be used by only one person. Doing otherwise can be dangerous.
- The seat belt will provide its wearer with maximum protection if the recliner seatback is placed in fully upright position. When the seatback is reclined, there is greater risk that the passenger will slide under the belt, especially in a forward impact accident, and may be injured by the belt or by striking the instrument panel or seatbacks.
- Seat belts should always be worn by every adult who drives or rides in this vehicle, and by all children who are tall enough to wear seat belts properly.
- Remove any twists when using the belt.

⚠ WARNING

- No modifications or additions should be made by the user which will either prevent the seat belt adjusting devices from operating to remove slack, or prevent the seat belt assembly from being adjusted to remove slack.
- To reduce risk of serious or fatal injury in an accident, including the deploying driver's airbag, adjust the driver's seat as far back as possible while maintaining a position that still allows good visibility and good control of the steering wheel, the brake and accelerator, and vehicle controls.
- Never hold a child in your arms or on your lap when riding in this vehicle, even if you are wearing your seat belt. To do so risks severe or fatal injury to the child in a collision or sudden stop.
- Always adjust the seat belt to a snug fit.



3-point type seat belt (with emergency locking mechanism)

E00404901126

This type of belt requires no length adjustment. Once worn, the belt adjusts itself to the movement of the wearer, but in the event of a sudden or strong shock, the belt automatically locks to hold the wearer's body.

NOTE

- You can check if the belt locks by pulling it forward quickly.

To fasten

1. Pull the seat belt out slowly while holding the latch plate.

NOTE

- When the seat belts cannot be pulled out in a locked condition, pull the belts once forcefully and then return them. After that, pull the belts out slowly once again.

2. Insert the latch plate into the buckle until a "click" is heard.

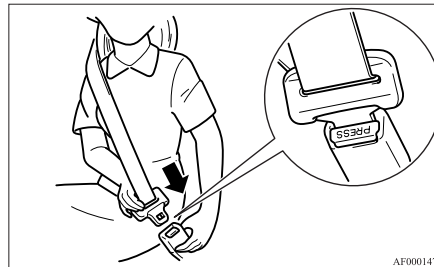

⚠ WARNING

- Never wear the lap portion of the belt across your abdomen. During accidents it can press sharply against the abdomen and increase the risk of injury.
- The seat belts must not be twisted when worn.

3. Pull the belt slightly to adjust slackness as desired.

To unfasten

Hold the latch plate and push the button on the buckle.

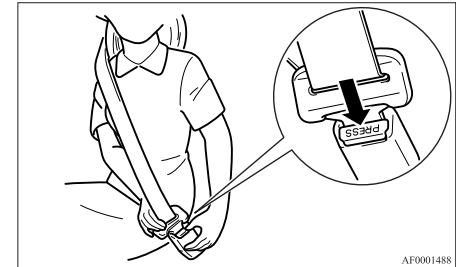

NOTE

- As the belt retracts automatically, keep holding the latch plate while retracting so that the belt stows slowly. Failure to do this could damage the vehicle.

Seat belt reminder/warning lamp

E00409800790

A tone and warning lamp are used to remind the driver and front passenger to fasten the seat belt.

NOTE

- For the front passenger seat, the warning function works only while a person is sitting on the seat.

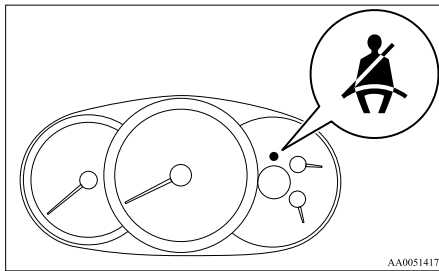

AA0051417

When the ignition key is turned to the “ON” position, the warning lamp will come on and a tone will sound for about 6 seconds. If the front seat belt remains unfastened approximately 1 minute later, the warning lamp will flash and the tone sound intermittently (each 12 times) when the vehicle is driven. If the passenger subsequently unfastens the seat belt while driving, the warning lamp and tone will issue further warnings. And if the seat belt remains unfastened, the warning lamp and tone will issue further warnings each time the vehicle starts moving from a stop. When the seat belt is fastened, the warnings will stop.

⚠ WARNING

- In order to reduce the risk of serious or fatal injury in an accident, always wear your own seat belt. Do not allow anyone to ride in your vehicle unless he or she is also seated and wearing a seat belt. Children should additionally be restrained in a secure child restraint system.

NOTE

- When luggage is placed on the front passenger seat, a sensor in the seat cushion may, depending on the weight and position of the luggage, cause the warning tone to sound and the warning lamp to come on (Double cab).

Adjustable seat belt anchor (front seats)*

E00405000299

The seat belt anchor height can be adjusted. Move the seat belt anchor down with the lock knob (A) depressed. To move the anchor up, slide it without depressing the lock knob (A).

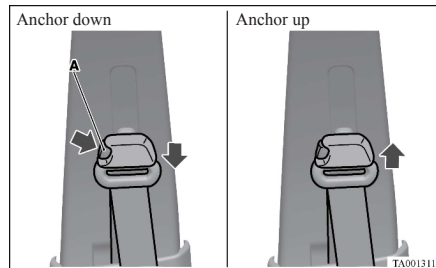

⚠ WARNING

- When adjusting the seat belt anchor, set it at a position that is sufficiently high so that the belt will make full contact with your shoulder but will not touch your neck.

Lap belts*

E00405100128

The lap belts should be adjusted by holding the belt and latch plate at right angles to each other, and then pulling the belt as shown in the illustration to a snug fit around the occupant.

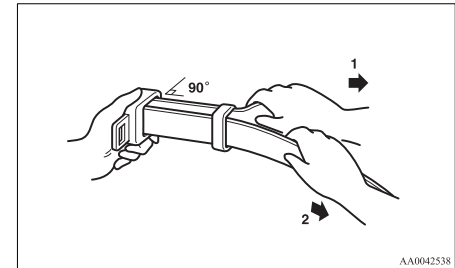

AA0042538

- 1- Tighten
- 2- Loosen

While holding the latch plate, insert the latch plate into the buckle until a “click” is heard.

Pregnant women restraint

E00405600064

⚠ WARNING

- Seat belts work for everyone, including pregnant women. Pregnant women should use the available seat belts. This will reduce the likelihood of injury to both the woman and the unborn child. The lap belt should be worn across the thighs and as snug against the hips as possible, but not across the waist. Consult your doctor if you have any additional questions or concerns.

Seat belt pretensioner system and force limiter system*

E00405700283

The driver's and front passenger's seat equipped with an airbag has a pretensioner seat belt.

Pretensioner system

E00405801089

The pretensioner system will retract their respective seat belts instantaneously, thus maximizing the seat belt's effectiveness, if there is a frontal impact severe enough to injure the driver and/or front passenger and the ignition switch is in the "ON" or "START" position.

The seat belt pretensioner includes the following components:

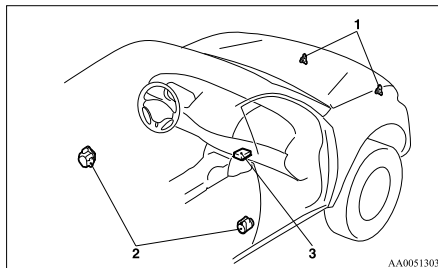

- 1- Front impact sensors
- 2- Seat belt pretensioners
- 3- Airbag control unit

⚠ WARNING

- To obtain the best results from your pretensioner seat belt, make sure you have adjusted your seat correctly and wear your seat belt properly.

⚠ CAUTION

- Installation of audio equipment or repairs in the vicinity of the pretensioner seat belts or floor console must be performed in line with MITSUBISHI MOTORS guidelines. It is important to do so because the work could affect the pretensioner systems.
- If you need to scrap the vehicle, please consult a MITSUBISHI MOTORS Authorized Service Point. It is important to do so because unexpected activation of the pretensioner seat belts could cause injuries.

NOTE

- The pretensioner seat belts will be activated if the vehicle suffers a severe frontal impact, even if the seat belts are not worn.
- The pretensioner seat belts are designed to work only once. After the pretensioner seat belts have been activated, we recommend you have them replaced by a MITSUBISHI MOTORS Authorized Service Point.

SRS warning lamp

E00405900126

This warning lamp is shared by the SRS airbags and the pretensioner seat belts.

Refer to “SRS warning lamp” on page 2-37.

Force limiter system

E00406000078

In the event of a collision, each force limiter system will effectively absorb the load applied to the seat belt so as to minimize the impact to the passenger.

Child restraint

E00406401297

When transporting children in your vehicle, some type of child restraint system should always be used according to the size of the child. This is required by law in most countries.

The regulations concerning driving with children in the front seat may differ from country to country. You are advised to comply with the relevant regulations.

⚠ WARNING

- When possible, put children in the rear seat. Accident statistics indicate that children of all sizes and ages are safer when properly restrained in the rear seat rather than in the front seat. (Double cab and Club cab)
- Holding a child in your arms is no substitute for a restraint system. Failure to use a proper restraint system can result in severe or fatal injury to the child.
- Each child restraint device or fixing is to be used only by one child.
- When attaching a child restraint to the rear seat, place the front seatbacks in the upright position. Otherwise, the child could be seriously injured in the event of hard braking or a collision. (Double cab and Club cab)

Caution for installing the child restraint on vehicles with a front passenger airbag

E00406500565

The label shown here is attached on vehicles with a front passenger airbag.

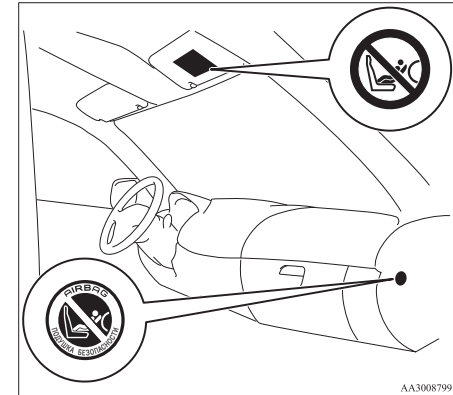

⚠ WARNING

- **Extreme Hazard!**
Do not use a rearward facing child restraint on a seat protected by an airbag in front of it!
- A REARWARD FACING CHILD RESTRAINT must NOT be used in the front passenger seat if the front passenger’s airbag has not been deactivated. The force of an inflating airbag could kill or cause serious injuries to the child.

Seat and seat belts



NOTE

- If you have a rearward facing child restraint system that cannot be fitted to any seat other than the front passenger seat, be sure to turn OFF the front passenger's airbag ON-OFF switch before using it. (Refer to "To turn an airbag off" on page 2-29.)

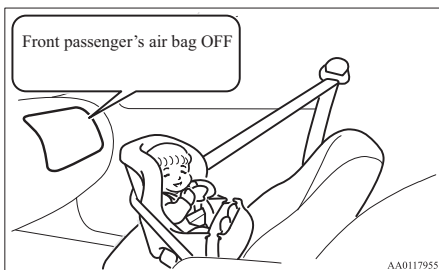

⚠ WARNING

- **A FORWARD FACING CHILD RESTRAINT should not be used in the front passenger seat whenever possible; if used in the front passenger seat, adjust the seat to the most rearward position.**



Infants and small children

E00406600768

When transporting infants and small children in your vehicle, follow the instruction given below.

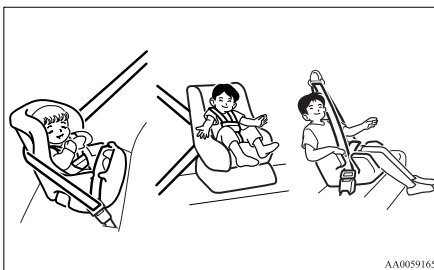

Instruction:

- For small infants, an infant carrier should be used. For small children whose height when seated allows the shoulder belt to lie in contact with the face or the throat, a child seat should be used.
- The child restraint system should be appropriate for the child's weight and height and properly fit in the vehicle.
- Before purchasing a child restraint system, try installing it in the seat to make sure there is a good fit. Because of the location of the seat belt buckles and the shape of the seat cushion, it may be difficult to securely install some manufacturer's child restraint systems. If the child restraint system can be pulled forward or to either side easily on the seat cushion after the seat belt has been tightened, choose another manufacturer's child restraint system.

⚠ WARNING

- **When installing a child restraint system, refer to the instructions provided by the manufacturer of the restraint system. Failure to do so can result in severe or fatal injury to the child.**
- **After installation, push and pull the child restraint system back and forth, and side to side, to see that it is properly secured. If the child restraint system is not installed securely, it may cause injury to the child or other occupants in the case of accident or sudden stops.**

⚠ WARNING

- When the child restraint system is not in use, keep your child restraint system secured with the seat belt or remove it from the vehicle in order to prevent it from being thrown around inside the vehicle during an accident.

⚠ WARNING

- Children who are not buckled up can strike other people in the vehicle in an accident.
- A child should never be left unattended in your vehicle. When you leave the vehicle, take the child with you.

NOTE

- Depending on the seating position in the vehicle and the child restraint system that you have, the child restraint can be attached using one of the following two locations:
 - To the lower anchorage in the rear seat ONLY if the child restraint has ISOFIX mountings (Double cab, See page 2-24).
 - To the seat belt (See page 2-25).

Older children

E00406700235

Children who have outgrown the child restraint system should be seated in the rear seat and wear combination lap shoulder belt.

The lap portion of the belt should be snug and positioned low on the abdomen so that it is below the top of the hip-bone. Otherwise, the belt could intrude into the child's abdomen during an accident and cause injury.

⚠ WARNING

- Children who are not buckled up can be thrown out of the vehicle in an accident.

Suitability for various ISOFIX positions

E00411400692

Mass group	Size class	Fixture	Vehicle ISOFIX positions
			Rear Outboard (Double cab)
Carycot	F	ISO/L1	X
	G	ISO/L2	X
0 - Up to 10 kg	E	ISO/R1	X
0+ - Up to 13 kg	E	ISO/R1	IL* ¹
	D	ISO/R2	X
	C	ISO/R3	X
I -9 to 18 kg	D	ISO/R2	X
	C	ISO/R3	X
	B	ISO/F2	IUF
	B1	ISO/F2X	IUF, IL* ²
	A	ISO/F3	IUF
II -15 to 25 kg			X
III -22 to 36 kg			X

 **CAUTION**

- When installing a child restraint system, remove the head restraint from the seat.

Key of letters to be inserted in the table above:

- IUF- Suitable for ISOFIX forward child restraints systems of universal category approved for use in the mass group.
- IL- Suitable for particular ISOFIX child restraint systems given in the following list (MITSUBISHI MOTORS GENUINE parts).
- X- ISOFIX position not suitable for ISOFIX child restraint systems in this mass group and/or this size class.

IL (Genuine part information)

	Genuine part No.	ECE No.
*1	MZ314393 (Child restraint system), MZ314394 (ISOFIX base)	E1-04301146
*2	MZ313045	E1-04301133

NOTE

- MITSUBISHI MOTORS Europe B.V. reserves the right to changes without any prior announcement.
For further information, please contact a MITSUBISHI MOTORS Authorized Service Point.

Suitability for various seating positions

Single cab (Separate seat)

Mass group		Seating position	
		Front passenger	
		Activated airbag	Deactivated airbag [#]
0	- Up to 10 kg	X	X
0+	- Up to 13 kg	X	L* ¹
I	-9 to 18 kg	X	L* ² , L* ³
II	-15 to 25 kg	X	L* ⁴
III	-22 to 36 kg	X	L* ⁴

[#]: With front passenger's airbag deactivated by means of front passenger's airbag ON-OFF switch.

CAUTION

- When installing a child restraint system, remove the head restraint from the seat.

Key of letters to be inserted in the table above:

- L- Suitable for particular child restraints in the following list (MITSUBISHI MOTORS GENUINE parts).
- X- Seat position not suitable for children in this mass group.

L (Genuine part information)

	Genuine parts No.	ECE No.
*1	MZ314393	E1-04301146
*2	MZ313045	E1-04301133
*3	MZ314451	E1-04301203
*4	MZ314250	E1-04301169

NOTE

- There is no applicable MITSUBISHI MOTORS GENUINE Parts to the Mass Group “0-Up to 10 kg”.

MITSUBISHI MOTORS Europe B.V. reserves the right to changes without any prior announcement.
For further information, please contact a MITSUBISHI MOTORS Authorized Service Point.

Single cab (Bench seat)

Mass group	Seating position		
	Front passenger		Front centre
	Activated airbag	Deactivated airbag [#]	
0 - Up to 10 kg	X	X	X
0+ - Up to 13 kg	X	L*1	X
I -9 to 18 kg	X	L*2, L*3	X
II -15 to 25 kg	X	L*4	X
III -22 to 36 kg	X	L*4	X

[#]: With front passenger's airbag deactivated by means of front passenger's airbag ON-OFF switch.

 **CAUTION**

- When installing a child restraint system, remove the head restraint from the seat.

Key of letters to be inserted in the table above:

- L- Suitable for particular child restraints in the following list (MITSUBISHI MOTORS GENUINE parts).
- X- Seat position not suitable for children in this mass group.

L (Genuine part information)

	Genuine parts No.	ECE No.
*1	MZ314393	E1-04301146

Seat and seat belts

	Genuine parts No.	ECE No.
*2	MZ313045	E1-04301133
*3	MZ314451	E1-04301203
*4	MZ314250	E1-04301169

NOTE

- There is no applicable MITSUBISHI MOTORS GENUINE Parts to the Mass Group “0-Up to 10 kg”.

MITSUBISHI MOTORS Europe B.V. reserves the right to changes without any prior announcement.
For further information, please contact a MITSUBISHI MOTORS Authorized Service Point.

Club cab

Mass group	Seating position		
	Front passenger		Rear outboard
	Activated airbag	Deactivated airbag [#]	
0 - Up to 10 kg	X	X	X
0+ - Up to 13 kg	X	L*1	L*1
I -9 to 18 kg	X	L*2, L*3	L*2, L*3
II -15 to 25 kg	X	L*4	X
III -22 to 36 kg	X	L*4	X

[#]: With front passenger’s airbag deactivated by means of front passenger’s airbag ON-OFF switch.

CAUTION

- When installing a child restraint system, remove the head restraint from the seat if the head restraint is adjustable.

Key of letters to be inserted in the table above:

- L- Suitable for particular child restraints in the following list (MITSUBISHI MOTORS GENUINE parts).
- X- Seat position not suitable for children in this mass group.

L (Genuine part information)

	Genuine parts No.	ECE No.
*1	MZ314393	E1-04301146
*2	MZ313045	E1-04301133
*3	MZ314451	E1-04301203
*4	MZ314250	E1-04301169

NOTE

- There is no applicable MITSUBISHI MOTORS GENUINE Parts to the Mass Group “0-Up to 10 kg”.

MITSUBISHI MOTORS Europe B.V. reserves the right to changes without any prior announcement.
For further information, please contact a MITSUBISHI MOTORS Authorized Service Point.

Double cab

Mass group	Seating position			
	Front passenger		Rear outboard	Rear centre
	Activated airbag	Deactivated airbag [#]		
0 - Up to 10 kg	X	X	U	X
0+ - Up to 13 kg	X	L*1	U, L*1	X
I -9 to 18 kg	X	L*2, L*3	U, L*2, L*3	L*2
II -15 to 25 kg	X	L*4	U, L*4	L*4
III -22 to 36 kg	X	L*4	U, L*4	L*4

[#]: With front passenger's airbag deactivated by means of front passenger's airbag ON-OFF switch.

⚠ CAUTION

- When installing a child restraint system, remove the head restraint from the seat.

Key of letters to be inserted in the table above:

- U- Suitable for “universal” category restraints approved for use in this mass group.
- L- Suitable for particular child restraints in the following list (MITSUBISHI MOTORS GENUINE parts).
- X- Seat position not suitable for children in this mass group.

2

L (Genuine part information)

	Genuine parts No.	ECE No.
*1	MZ314393	E1-04301146
*2	MZ313045	E1-04301133
*3	MZ314451	E1-04301203
*4	MZ314250	E1-04301169

NOTE

- There is no applicable MITSUBISHI MOTORS GENUINE Parts to the Mass Group “0-Up to 10 kg”.

MITSUBISHI MOTORS Europe B.V. reserves the right to changes without any prior announcement.
For further information, please contact a MITSUBISHI MOTORS Authorized Service Point.

Child restraint anchorage points (Double cab)*

E00406900354

Anchorage locations

There are 2 child restraint anchorage points on the floor, located behind the rear seat. These are for securing a child restraint system tether strap to each of the 2 rear seating positions in your vehicle.

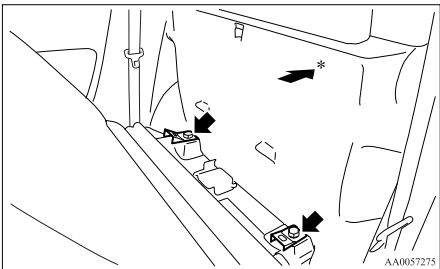

*: Rear of the vehicle

CAUTION
● The anchorages are only applicable for child restraints fitted in the rear seat.

Tether anchorage strap installation

WARNING

● Child restraint anchorages are designed to withstand only those loads imposed by correctly fitted child restraints. Under no circumstances are they to be used for adult seat belts, harnesses, or for attaching other items or equipment to the vehicle.

1. Remove the head restraint from the location in which you wish to install a child restraint.
2. Drop the child restraint's tether strap (A) down the back of the rear seatback.

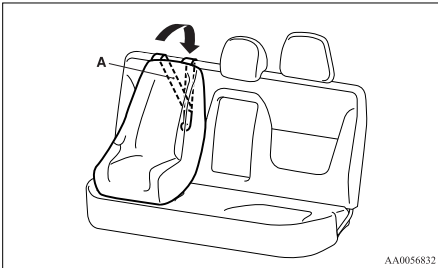

3. Tip the armrest forward. Open the fastener (B) that is located in the space where the armrest was stowed.

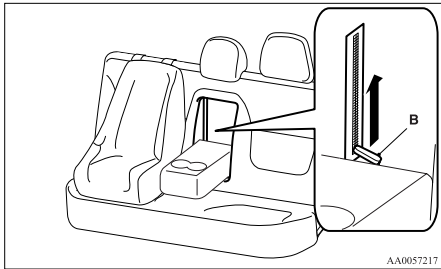

2

4. Put your hand in the opening of the fastener, attach the tether strap's hook (C) to the tether anchorage (D), and securely tighten the tether strap.

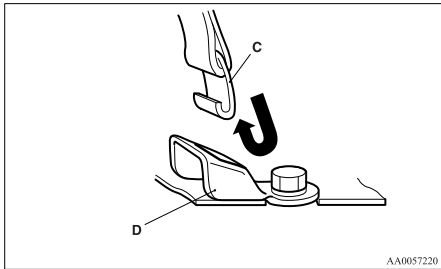

Seat and seat belts

Installing a child restraint system to the lower anchorage (ISOFIX child restraint mountings)*

E00408900114

Your vehicle's second seat is fitted with lower anchorages for attaching a child restraint system with ISOFIX mountings.

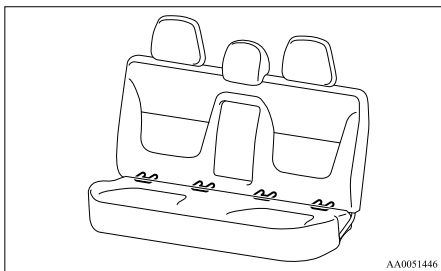

It is not necessary to retain the child restraint system using the vehicle's seat belts.

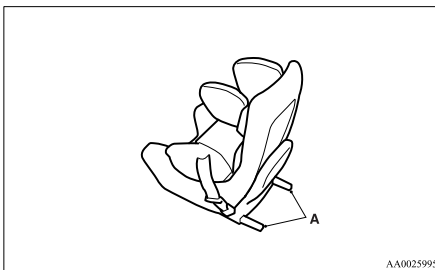

A- Child restraint system connectors

To install

⚠ WARNING

- If there is any foreign material in or around the connectors, remove it before installing the child restraint system. Also, make sure the seat belt is away from, not looped through or otherwise interfering with, the child restraint system. If foreign matter is not removed and/or the seat belt interferes with the child restraint system, the child restraint system will not be secured properly and could move forward in the event of sudden braking or a collision, seriously injuring the child and possibly other vehicle occupants.
- When the vehicle is moving do not adjust the seat where the child restraint system is installed.

1. Remove the head restraint from the location in which you wish to install a child restraint. Refer to "Head restraints" on page 2-08.
2. Push the child restraint system's connectors into the lower anchorages (A) in accordance with the instructions provided by the child restraint system's manufacturer.

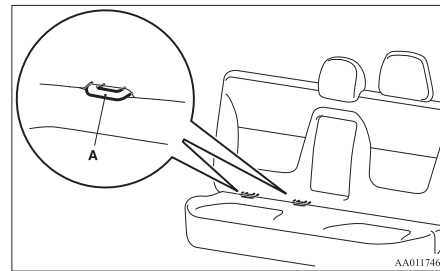

If your child restraint system requires the use of a tether strap, fasten the tether strap in accordance with steps 3 through 5. If a tether strap is unnecessary, perform the step 6.

Child restraint system with ISOFIX mountings

E00409000574

The child restraint system is designed only for seats that incorporate lower anchorages. Retain the child restraint system using the lower anchorages.

- Drop the child restraint's tether strap (B) down the back of the rear seatback.

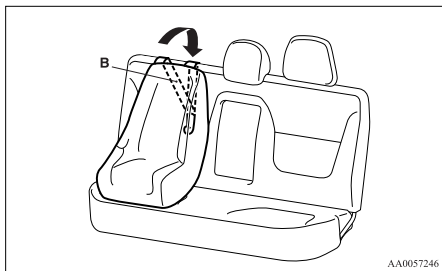

- Tip the armrest forward. Open the fastener (C) that is located in the space where the armrest was stowed.

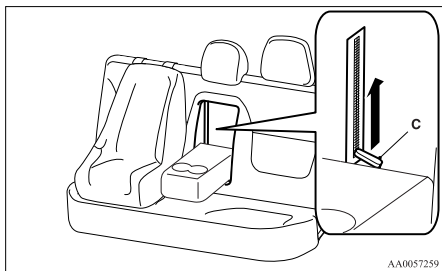

- Put your hand in the opening of the fastener, attach the tether strap's hook (D) to the tether anchorage (E), and securely tighten the tether strap.

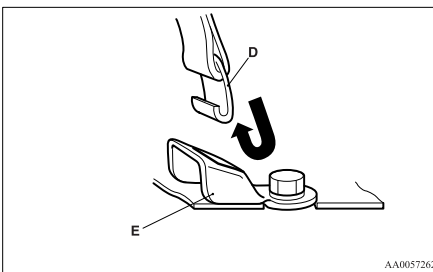

- Push and pull the child restraint system in all directions to be sure it is firmly secured.

To remove

Remove the child restraint in accordance with the instructions provided by the child restraint system's manufacturer.

Installing a child restraint system to a 3-point type seat belt (with emergency locking mechanism)

E00408700822

Installation:

- Put a child restraint system on the seat in which you wish to install it.
If the head restraint is adjustable, remove the head restraint from the seat.
Refer to "Head restraints" on page 2-08

- Fasten the seat belt to secure the child restraint system.

Make sure you hear a "click" when you insert the latch plate in the buckle.

- Remove all slack by using the locking clip.
- Push and pull the child restraint in all directions to be sure it is secure.

⚠ WARNING

- For some types of child restraint, the locking clip (A) should be used to help avoid personal injury during a collision or sudden manoeuvre.

It must be fitted and used in accordance with the child restraint manufacturer's instructions.

The locking clip must be removed when the child restraint is removed.

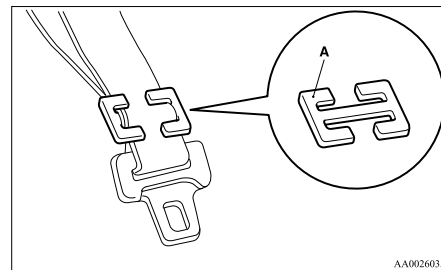

Seat belt inspection

E00406300475

- Check the belts for cuts, worn or frayed webbing and for cracked or deformed metallic parts. Replace the belt assembly if defective.
- A dirty belt should be cleaned with neutral detergent in warm water. After rinsing in water, let it dry in the shade. Do not attempt to bleach or re-dye the belts because this affects their characteristics.

2

WARNING

- We recommend you have all seat belt assemblies including retractors and attaching hardware inspected after any collision. We recommend that seat belt assemblies in use during a collision be replaced unless the collision was minor and the belts show no damage and continue to operate properly.
- Do not attempt to repair or replace any part of the seat belt assemblies; we recommend you to have this work done by a MITSUBISHI MOTORS Authorized Service Point. Incorrect repair or replacement could reduce the effectiveness of the belts and could result in serious injury in the event of a collision.
- Once the pretensioner has activated, it cannot be re-used. It must be replaced together with the retractor.

Supplemental restraint system (SRS) - airbag*

E00407202273

The information written in this Supplemental Restraint System (SRS) section contains important points concerning the driver, front passenger, side and curtain airbags.

The SRS driver and front passenger airbags are designed to supplement the primary protection of the driver and front passenger side seat belt systems by providing those occupants with protection against head and chest injuries in certain moderate-to-severe frontal collisions.

The SRS side airbag is designed to supplement the properly worn seat belts and provide the driver and front passenger with protection against chest injury in certain moderate-to-severe side impact collisions.

The SRS curtain airbags are designed to supplement the properly worn seat belts and provide the driver and passengers with protection against head injuries in certain moderate-to-severe side impact collisions.

The SRS is NOT a substitute for the seat belts; for maximum protection in all types of crashes and accidents, seat belts should ALWAYS be worn by everyone who drives or rides in this vehicle.

WARNING

- IT IS VERY IMPORTANT TO ALWAYS PROPERLY WEAR YOUR SEAT BELT, EVEN WITH AN AIRBAG:

WARNING

- Seat belts help keep the driver and passengers properly positioned, which reduces injury risk in all collisions, and reduces the risk of serious or fatal injuries when the airbags inflate. During sudden braking just before a collision, an unrestrained or improperly restrained driver or passengers can move forward into direct contact with or within close proximity to the airbag which may then deploy during the collision. The initial stage of airbag inflation is the most forceful which could cause serious or fatal injuries if the occupant contacts it at this stage.
- Seat belts reduce the risk of injury in roll-overs, rear impact collisions, and in lower-speed frontal collisions, because driver's and passenger's airbags are not designed to inflate in those situations.
- Seat belts reduce the risk of being thrown from your vehicle in a collision or roll-over.
- IT IS VERY IMPORTANT TO BE PROPERLY SEATED. A driver or front passenger too close to the steering wheel or instrument panel during airbag deployment can be killed or seriously injured. Airbags inflate very fast, and with great force. If the driver and front passenger are not properly seated and restrained, the air-

⚠ WARNING

bags may not protect you properly, and could cause serious or fatal injuries when it inflates.

- Before driving, adjust the driver's seat as far back as possible while still maintaining complete control of the vehicle.
- Before driving, adjust the front passenger seat as far back as possible.
- Make sure all vehicle occupants are always properly restrained using the available seat belts.
- With seat belts properly fastened, the driver and passengers should sit well back and upright without leaning against the window or door.
- Do not sit on the edge of the seat, or lean head or chest close to the steering wheel or instrument panel.
- Do not put feet or legs on or against the instrument panel.

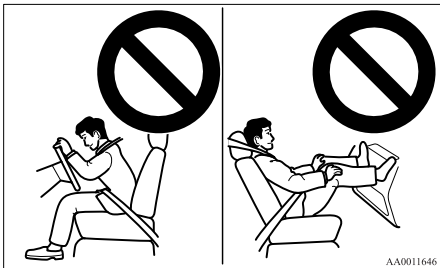

⚠ WARNING

- Infants and small children should never be unrestrained, stand up against the instrument panel or be held in your arms or on your lap. They could be seriously injured or killed in a collision, including when the airbag inflates. They should be properly seated in an appropriate child restraint system. See the "Child restraint" section of this owner's manual.

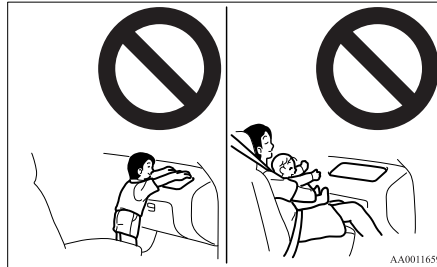

⚠ WARNING

- A REARWARD FACING CHILD RESTRAINT must NOT be used in the front passenger seat if the front passenger's airbag has not been deactivated. The force of an inflating airbag could kill or cause serious injuries to the child.



NOTE

- If you have a rearward facing child restraint system that cannot be fitted to any seat other than the front passenger seat, be sure to turn OFF the front passenger's airbag ON-OFF switch before using it. (Refer to "To turn an airbag off" on page 2-29.)



⚠ WARNING

- A FORWARD FACING CHILD RESTRAINT should not be used in the front passenger seat whenever possible; if used in the front passenger seat, adjust the seat to the most rearward position. Failure to do so could kill or cause serious injuries to the child.

2



⚠ WARNING

- Older children should be seated, properly wearing the seat belt, with an appropriate booster seat if needed.

Caution for installing the child restraint on vehicles with a front passenger airbag

E00408800588

The label shown here is attached on vehicles with a front passenger airbag.

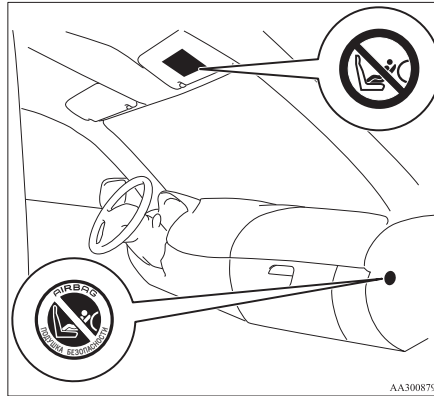

⚠ WARNING

- **Extreme Hazard!**
Do not use a rearward facing child restraint on a seat protected by an airbag in front of it!

How the Supplemental Restraint System works

E00407301352

The SRS includes the following components:

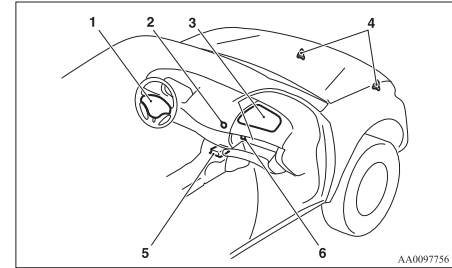

- 1- Airbag module (Driver)
- 2- Front passenger's airbag OFF indication lamp
- 3- Airbag module (Passenger)
- 4- Front impact sensors
- 5- Airbag control unit
- 6- Front passenger's airbag ON-OFF switch

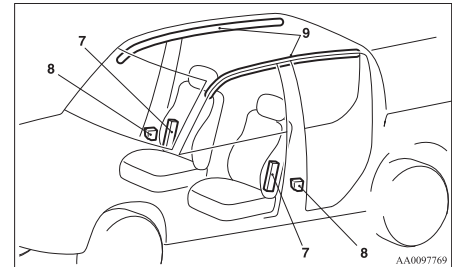

- 7- Side airbag modules
- 8- Side impact sensors
- 9- Curtain airbag modules

The airbags will operate only when the ignition switch is in the “ON” or “START” position.

When the airbag control unit detect an impact of sufficient frontal or side force, it sends an ignition signal to the airbag modules to ignite materials in the inflator and generate gas and inflate the airbags.

The airbags deployment produces a sudden, loud noise, and releases some smoke and powder, but these conditions are not injurious, and do not indicate a fire in the vehicle. People with respiratory problems may feel some temporary irritation from chemicals used to produce the deployment; open the windows after airbag deployment, if safe to do so.

The airbags deflate very rapidly after deployment, so there is little danger of obscured vision.

The time required from the sensors detecting an impact to deflation of the airbags after deployment is shorter than a blink of an eye.

CAUTION

- Airbags inflate at an extremely rapid speed. In certain situations, contact with inflating airbags can result in abrasions, light cuts, bruises, and the like.

Front passenger’s airbag ON-OFF switch

E00410100331

The front passenger’s airbag ON-OFF switch can be used to disable the front passenger’s airbag. If you have a rearward facing child restraint system that cannot be fitted to any seat other than the front passenger seat, be sure to turn OFF the front passenger’s airbag ON-OFF switch before using it. (Refer to “To turn an airbag off” on page 2-29.)

The front passenger’s airbag ON-OFF switch is located in the glove box.

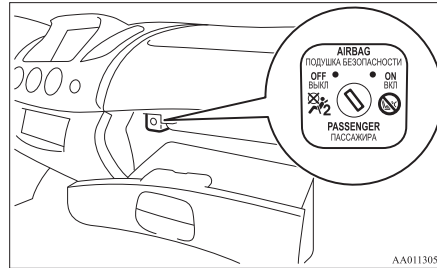

WARNING

- To reduce risk of serious or fatal injury:
 - Always remove the key from the ignition switch before operating a front passenger’s airbag ON-OFF switch. Failure to do so could adversely affect the airbag performance.
 - Wait at least 60 seconds to operate the front passenger’s airbag ON-OFF switch after turning the ignition switch from “ON” position to “LOCK” position.
- The SRS airbag system is designed to retain enough voltage to deploy the airbag.

WARNING

- Always remove the key from the front passenger’s airbag ON-OFF switch after operating that switch. Failure to do so could lead to improper position of the front passenger’s airbag ON-OFF switch.

To turn an airbag off

E00410600440

To turn an airbag off, follow these steps:

1. Insert the key into the key opening of the appropriate front passenger’s airbag ON-OFF switch, and turn that airbag ON-OFF switch to the “OFF” position.
2. Remove the key from the key opening of the front passenger’s airbag ON-OFF switch.
3. Insert the key into the ignition switch, and turn the ignition to the “ON” position.

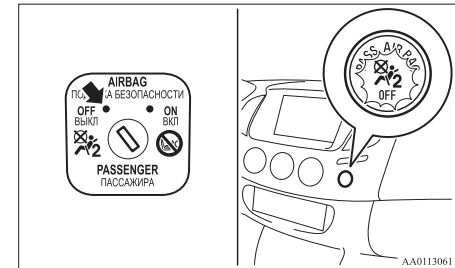

The front passenger’s airbag OFF indication lamp will stay on to show that the front passenger’s airbag is not operational. (“Front passenger’s airbag OFF indication lamp” on page 2-30)

Seat and seat belts

That airbag will remain OFF, and will NOT deploy, until it is turned ON again.

⚠ WARNING

- To reduce risk of serious or fatal injury:
 - If the indication lamp does not come on when the front passenger's airbag ON-OFF switch is turned OFF, do not fit a rearward facing child restraint system to the front passenger seat.
 - Do not turn OFF the front passenger's airbag ON-OFF switch except when a rearward facing child restraint system is fitted to the front passenger seat.

To turn an airbag on

E00410700135

To turn an airbag on, follow these steps:

1. Insert the key into the key opening of the appropriate front passenger's airbag ON-OFF switch, and turn that airbag ON-OFF switch to "ON" position.
2. Remove the key from the key opening of that front passenger's airbag ON-OFF switch.

3. Insert the key into the ignition switch, and turn the ignition to the "ON" position.

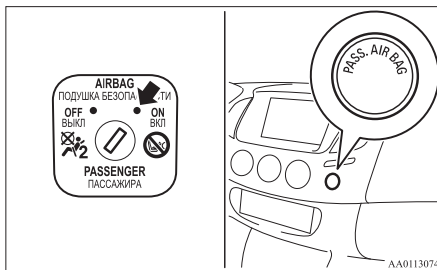

The front passenger's airbag OFF indication lamp goes off to show that the front passenger's airbag is operational.

That airbag will remain ON, and will be ready to deploy, until it is again turned OFF.

⚠ WARNING

- To reduce risk of serious or fatal injury:
 - Turn ON the front passenger's airbag ON-OFF switch immediately after removing a rearward facing child restraint system from the front passenger seat.
 - If the indication lamp remains on when the front passenger's airbag ON-OFF switch is turned ON, do not allow anyone to sit on the front passenger seat.

Front passenger's airbag OFF indication lamp

E00410200257

The front passenger's airbag OFF indication lamp is located in the instrument panel.

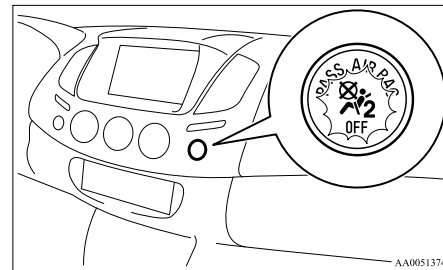

When the front passenger's airbag ON-OFF switch is turned OFF, the indication lamp will stay on to show that the front passenger's airbag is not operational.

When the front passenger's airbag ON-OFF switch is turned ON, the indication lamp goes off to show that the front passenger's airbag is operational.

⚠ WARNING

- If the indication lamp behaves in any of the following ways, there may be a fault in the airbag system.
Have the vehicle inspected at a MITSUBISHI MOTORS Authorized Service Point as soon as possible.

⚠ WARNING

- The indication lamp does not come on when the front passenger's airbag ON-OFF switch is turned OFF.
- The indication lamp stays on when the front passenger's airbag ON-OFF switch is turned ON.

⚠ WARNING

- Do not fit any accessory that makes the indication lamp impossible to see, and do not cover the indication lamp with a sticker. You would not be able to verify the status of the passenger airbag system.

Driver's and passenger's front airbag system

E00407400330

The driver's airbag is located under the padded cover in the middle of the steering wheel. The front passenger's airbag is contained in the instrument panel above the glove box.

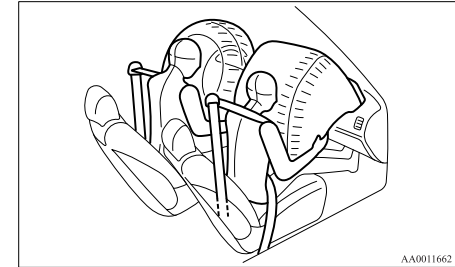

2

Deployment of front airbags

The front airbags ARE DESIGNED TO DEPLOY when...

Head-on collision with a solid wall at speed of approximately 25 km/h (16 mph) or higher

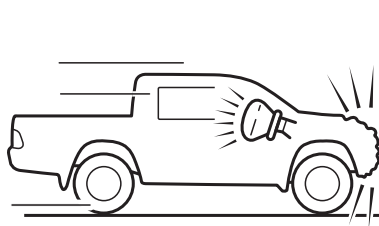

Moderate to severe frontal impact within the shaded area between the arrows

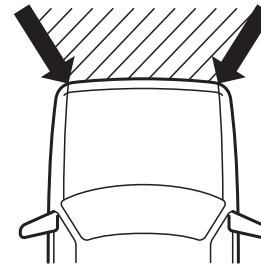

E00407501354

AA1002966

Seat and seat belts

The front airbags are designed to deploy when the vehicle suffers a moderate to severe frontal impact. A typical condition is shown in the illustration.

The front airbags will deploy if the severity of impact is above the designed threshold level, comparable to an approximately 25 km/h (16 mph) collision when impacting straight into a solid wall that does not move or deform. If the severity of the impact is below the above threshold level, the front airbags may not deploy. However, this threshold speed will be considerably higher if the vehicle strikes an object that absorbs the impact by either deforming or moving (for example, another stationary vehicle, pole or a guard rail).

Because frontal collisions can easily move you out of position, it is important to always properly wear your seat belts. Your seat belts will help keep you in a safe distance from the steering wheel and instrument panel during the initial stages of airbag deployment. The initial stage of airbag inflation is the most forceful, and can possibly cause serious or fatal injuries. Moreover, the seat belts in your vehicle are your primary means of protection in a collision. The SRS airbags are designed to provide additional protection. Therefore, for your safety and the safety of all occupants, be sure to always properly wear your seat belts.

The front airbags MAY NOT DEPLOY when...

With certain types of frontal collisions, the vehicle's body structure is designed to absorb the shock to help protect the occupants from harm. (The vehicle body's front area may deform significantly as it absorbs the impact.) Under such circumstances, the front airbags may not deploy irrespective of the deformation and damage to the vehicle body. Examples of some typical conditions are shown in the illustration.

Examples of some typical conditions are shown in the illustration.

Because the front airbags do not protect the occupant in all types of frontal collisions, be sure to always properly wear your seat belts.

Collision with a utility pole, tree or other narrow objects

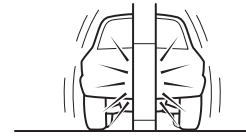

Vehicle slides under the rear body of a truck

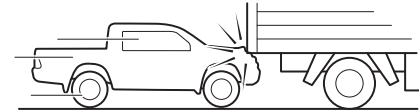

Oblique frontal impacts

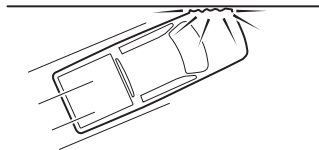

AA2001070

The front airbags ARE NOT DESIGNED TO DEPLOY when...

The front airbags are not designed to deploy in conditions where they cannot typically provide protection to the occupant. Such conditions are shown in the illustration.

Because the front airbags do not protect the occupant in all types of collisions, be sure to always properly wear your seat belts.

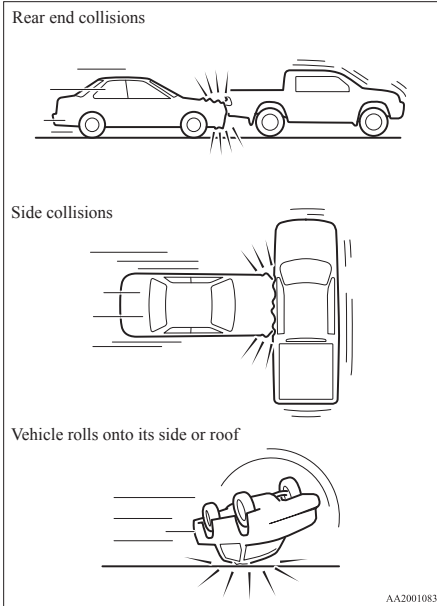

The front airbags *MAY DEPLOY* when...
 The front airbags may deploy if the bottom of the vehicle suffers a moderate-to-severe impact (undercarriage damage).
 Examples of some typical conditions are shown in the illustration.

Because the front airbags may deploy in certain types of unexpected impacts as shown in the illustration that can easily move you out of position, it is important to always properly wear your seat belts. Your seat belts will help keep you a safe distance from the steering wheel and instrument panel during the initial stages of airbag deployment. The initial stage of airbag inflation is the most forceful and can possibly cause serious or fatal injuries if you contact it at this stage.

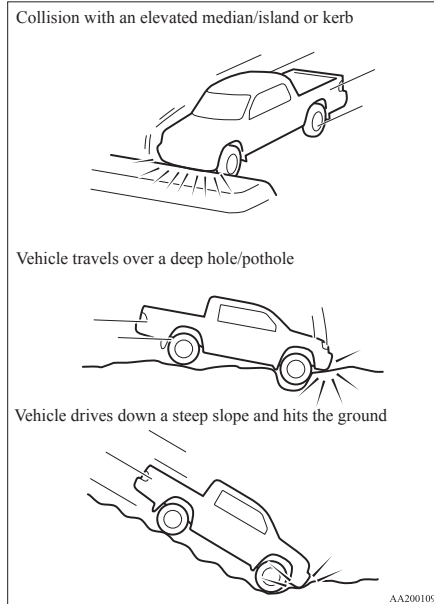

⚠ WARNING

- Do not attach anything to the steering wheel's padded cover, such as trim material, badges, etc. It might strike and injure an occupant if the airbag inflates.
- Do not set anything on, or attach anything to, the instrument panel above the glove box. It might strike and injure an occupant if the airbag inflates.

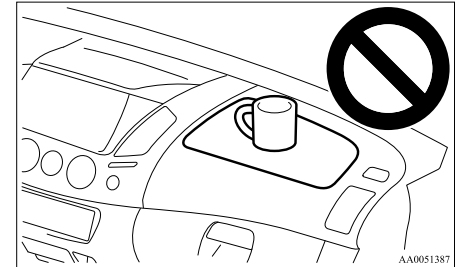

⚠ WARNING

- Do not attach accessories to, or put them in front of, the windshield. These objects could restrict the airbag inflation, or strike and injure an occupant if the airbags inflate.
- Do not put packages, pets or other objects between the airbags and the driver or front passenger. It could affect airbag performance, or could cause injury when the airbag inflates.

⚠ WARNING

- Right after the airbag inflation, several airbag system components will be hot. Do not touch them; you could be burned.
- The airbag system is designed to work only once. Once the airbags have deployed, they will not work again. They must promptly be replaced, and we recommend you to have the entire airbag system inspected by a MITSUBISHI MOTORS Authorized Service Point.

2

Side airbag system

E00407600563

The side airbags (A) are contained in the driver and front passenger seatbacks.

The side airbag is designed to inflate only on the side of the vehicle that is impacted, even with no passenger in the front seat.

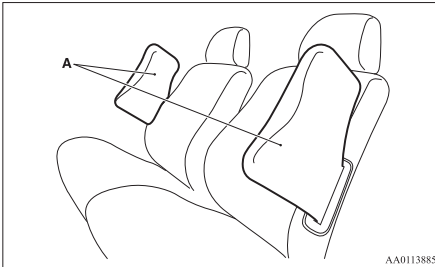

AA0113885

The label shown here is attached to the seatbacks with a side airbag.



AA0113087

Curtain airbag system

E00409100474

The curtain airbags are contained in the front pillars and roof side rail. The curtain airbag is designed to inflate only on the side of the vehicle that is impacted, even with no passenger in the front seat or rear seat.

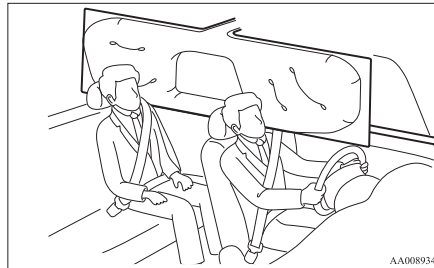

AA0089340

Deployment of side airbags and curtain airbags

E00407701011

The side airbags and curtain airbags ARE DESIGNED TO DEPLOY when...

The side airbags and curtain airbags are designed to deploy when the vehicle suffers a moderate-to-severe side impact to the middle of the passenger compartment.

The typical condition is shown in the illustration.

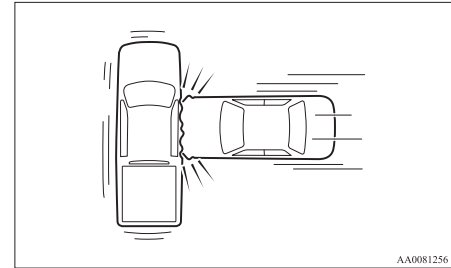

AA0081256

The seat belts in your vehicle are your primary means of protection in a collision. The SRS side airbags and curtain airbags are designed to provide additional protection. Therefore, for your safety and the safety of all occupants, be sure to always properly wear your seat belts.

The side airbags and curtain airbags *MAY NOT* DEPLOY when...

With certain types of side collisions, the vehicle's body structure is designed to absorb the shock to help protect the occupants from harm. (The vehicle body's side area may deform significantly as it absorbs the impact.) Under such circumstances, the side airbags and curtain airbags may not deploy irrespective of the deformation and damage to the vehicle body.

Examples of some typical conditions are shown in the illustration.

Because the side airbags and curtain airbags do not protect the occupant in all types of side collisions, be sure to always properly wear your seat belts.

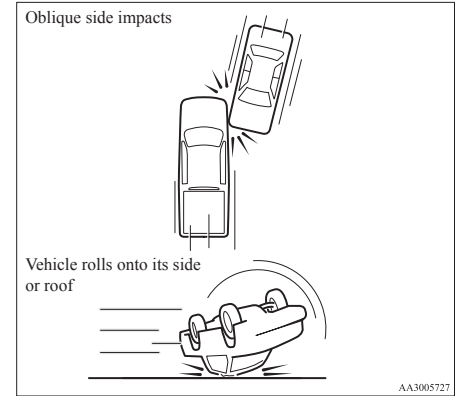
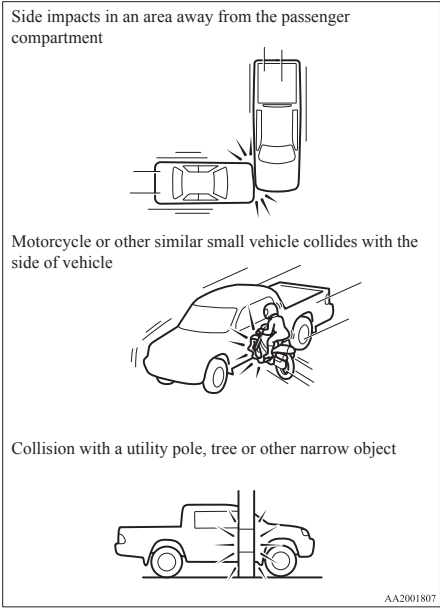

Seat and seat belts

The side airbags and curtain airbags ARE NOT DESIGNED TO DEPLOY when...

The side airbags and curtain airbags are not designed to deploy in conditions where they cannot usually provide protection to the occupant. Typical conditions are shown in the illustration.

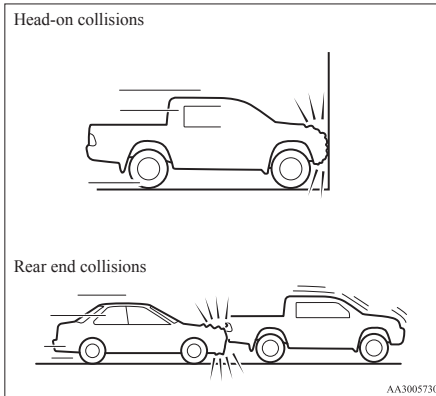

Because the side airbags and curtain airbags do not protect the occupant in all types of collisions, be sure to always properly wear your seat belts.

⚠ WARNING

- The side airbags and curtain airbags are designed to supplement the driver and passenger seat belts in certain side impacts. Seat belts should always be worn properly, and the driver and passenger should sit well back and upright without leaning against the window or door.

⚠ WARNING

- The side airbags and curtain airbags inflate with great force. The driver and front passenger should not put their arms out the window, and should not lean against the door, in order to reduce the risk of serious or possible fatal injury from the deploying side airbag and curtain airbag.



⚠ WARNING

- Do not allow a child to kneel on the passenger seat facing the passenger's side door, since the side airbags and curtain airbags inflate with great force. Otherwise, the child may be killed or seriously injured.



⚠ WARNING

- Do not allow any rear seat occupant to hold onto the seatback of either front seat, in order to reduce risk of injury from the deploying side airbag. Special care should be taken with children.
- Do not place any objects near or in front of the seatback of either front seat. They could interfere with proper side airbag inflation, and also could cause injury if thrown free by side airbag deployment.
- Do not place stickers, labels or additional trim on the seatback of either front seat. They could interfere with proper side airbag inflation.
- Do not install seat covers on seats with side airbags. Do not re-cover seats that have side airbags. This could interfere with proper side airbag inflation.

⚠ WARNING

- Do not attach a microphone (A) or any other device or object around the part where the curtain airbags (B) activate such as on the windscreen, side door glass, front and rear pillars and roof side or assist grips. When the curtain airbags inflate, the microphone or other device or object will be hurled with great force or the curtain airbags may not activate correctly, resulting in death or serious injury.

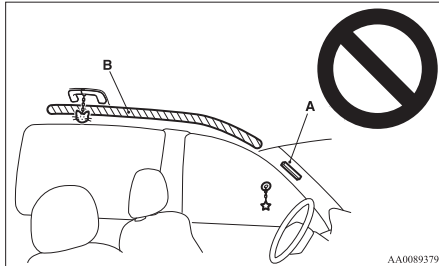
**⚠ WARNING**

- Do not put a hanger or any heavy or pointed object on the coat hook. If the curtain airbag was activated, any such item could be propelled away with great force and could prevent the curtain airbag from inflating correctly. Hang clothes directly on the coat hook (without using a hanger). Make sure there are no heavy or sharp objects in the pockets of clothes that you hang on the coat hook.
- Do not allow a child to lean against or close to the front door even if the child is seated in a child restraint system. The child's head should also not be leaned against or be close to the area of the seat where the side airbag and curtain airbag are located. It is dangerous if the side airbag and curtain airbag inflate. Failure to follow all of these instructions could lead to serious or fatal injury to the child.
- We recommend work around and on the side airbags and curtain airbags system to be done by MITSUBISHI MOTORS Authorized Service Point. Improper work could result in inadvertent deployment of a side airbags and curtain airbags, or could render a side airbags and curtain airbags inoperative; either situation could result in serious injury.

SRS warning lamp

E00407801201

There is a Supplemental Restraint System ("SRS") warning lamp on the instrument panel. The system checks itself and the lamp tells you if there is a problem. When the ignition switch is turned to the "ON" or "START" position, the warning lamp should illuminate for several seconds and then should go out. This means the system is ready. If an SRS airbag or pretensioner seat belt is not operating properly, the warning lamp comes on and stays on.

The SRS warning lamp is shared by the SRS airbag and the seat belt pretensioner system.

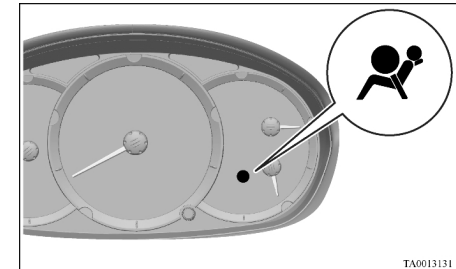
**⚠ WARNING**

- If any of the following conditions occur, the SRS and/or seat belt pretensioners are not working properly, and we recommend you to have it inspected by a MITSUBISHI MOTORS Authorized Service Point immediately.

⚠ WARNING

- The SRS warning lamp does not illuminate when you start the vehicle.
- The SRS warning lamp does not go out after several seconds.
- The SRS warning lamp illuminates while driving.

SRS servicing

E00407901244

⚠ WARNING

- We recommend any maintenance performed on or near the components of the SRS to be performed by a MITSUBISHI MOTORS Authorized Service Point. Improper work on the SRS components or wiring could result in inadvertent deployment of the airbags, or could render the SRS inoperative; either situation could result in serious injury.
- Do not modify your steering wheel, seat belt retractor or any other SRS components. For example, replacement of the steering wheel, or modifications to the front bumper or body structure can adversely affect SRS performance and lead to possible injury.
- If your vehicle has sustained any damage, we recommend you to have the SRS inspected to ensure it is in proper working order.

⚠ WARNING

- On vehicles equipped with side airbags, do not modify your front seats, centre pillar and centre console. It can adversely affect SRS performance and lead to possible injury. Also, if you have found any tear or open seam in the seat fabric at the portion near the side airbag, we recommend you to have the seat inspected.
- On vehicles with the curtain airbags, if you have found any scratch, crack or damage to the portion of the front and rear pillars and roof side rail, we recommend you to have the SRS inspected by a MITSUBISHI MOTORS Authorized Service Point.

NOTE

- When you transfer ownership of the vehicle to some other person, we urge you to alert the new owner that it is equipped with the SRS and refer the new owner to the applicable section in this owner's manual.
- If you junk or scrap the vehicle, we urge you to first take the vehicle to a MITSUBISHI MOTORS Authorized Service Point so that the SRS can be rendered safe.

Instruments and controls

Instruments.....	3-02
Indication and warning lamps.....	3-06
Indication lamps.....	3-07
Warning lamps.....	3-08
Centre information display*.....	3-10
Combination headlamps and dipper switch.....	3-30
Headlamp levelling switch*.....	3-32
Turn-signals lever.....	3-33
Hazard warning flasher switch.....	3-34
Front fog lamp switch*.....	3-34
Rear fog lamp switch.....	3-35
Wiper and washer switch.....	3-36
Rear window demister switch.....	3-39
Horn switch.....	3-40

Instruments

E00500100876

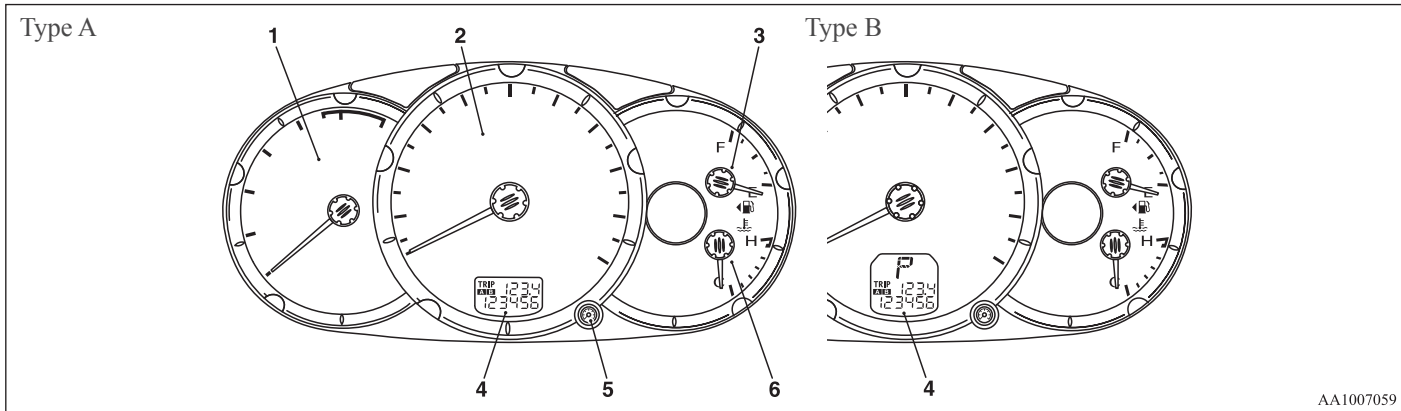

AA1007059

- 1- Tachometer
- 2- Speedometer
- 3- Fuel gauge
- 4- Odometer/Tripmeter
- 5- Tripmeter reset button/Daytime dipper button*
- 6- Water temperature gauge

Speedometer

E00500200880

Indication for km/h

The speedometer indicates the vehicle's speed in kilometers per hour (km/h).

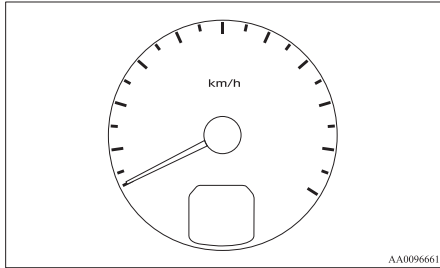

Indication for km/h and mph

The speedometer indicates the vehicle's speed in miles per hour (mph) and kilometers per hour (km/h).

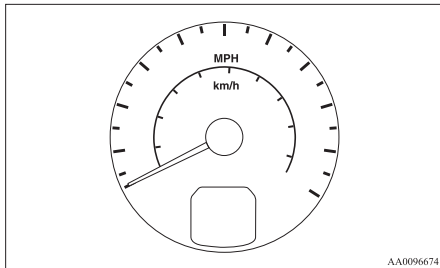

Tachometer

E00500300780

The tachometer indicates the engine speed (r/min). The tachometer can help you obtain more economical driving and also warns you of excessive engine speeds.

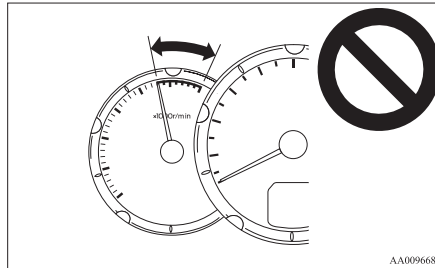

CAUTION

- When driving, watch the tachometer to make sure that the engine speed indication does not rise into the red zone (excessive engine rpm).

Odometer/Tripmeter

E00500601113

When the ignition switch is in the "ON" position, odometer and tripmeter indications are given.

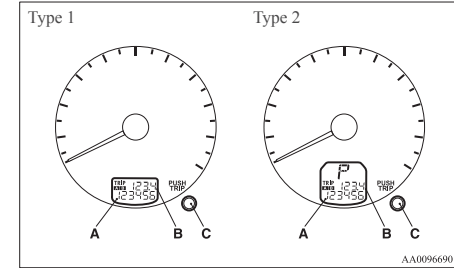

- A- Odometer
- B- Tripmeter
- C- Reset button

Odometer

The odometer indicates the total distance the vehicle has travelled.

Tripmeter

The tripmeter indicates the distance travelled during a particular trip or period.

There are two tripmeter displays: TRIP **A** and **B**.

TRIP **A** can be used to measure the distance travelled since the current trip began. At the same time, TRIP **B** can be used to measure the distance from an intermediate location.

Instruments and controls

Every time the reset button (C) is pressed lightly (less than 1 second), the tripmeter display changes (between TRIP **A** and **B**).

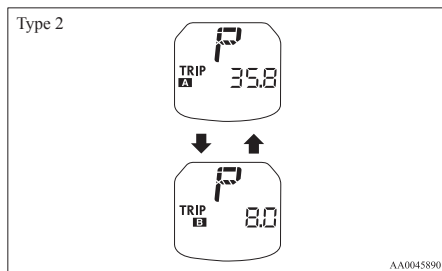
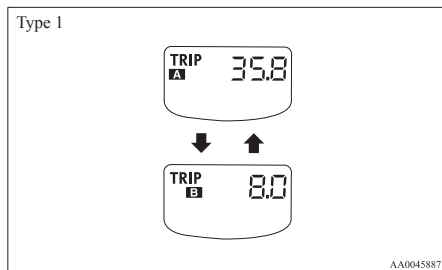

To reset the tripmeter

To return the display to “0”, press the reset button (C) for more than 1 second. Only the currently displayed value will be reset. If TRIP **A** is displayed, for example, only TRIP **A** will be reset.

NOTE

- Display TRIP **A** and **B** each have a maximum distance of 999.9 km (999.9 miles).
- When disconnecting the battery terminal for a long time, the memory of tripmeter display TRIP **A** and **B** are cleared, and the display returns to “0”.

Fuel gauge

E00500700902

The fuel gauge indicates the fuel level in the fuel tank when the ignition switch is in the “ON” position.

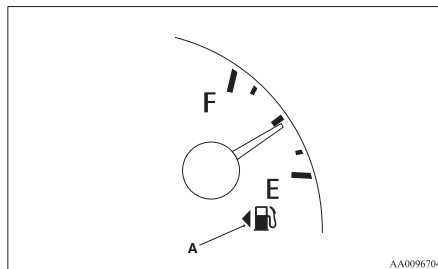

F- Full
E- Empty

NOTE

- When the engine on diesel-powered vehicles fails to operate due to running out of fuel, it may sometimes be difficult to start after refueling. This is due to air entering the fuel system. Therefore, air must be bled from the system. (Refer to “Bleeding the fuel system” on page 6-05.)

Fuel lid mark

The fuel lid mark (A) indicates that the fuel tank filler door is located on the left side of the vehicle (Refer to “Filling the fuel tank” on page 02).

Low fuel warning lamp

E00508100739

The warning lamp (A) comes on when the fuel level is getting low (approx. 11 litres) with the ignition switch in the “ON” position. Refuel as soon as possible.

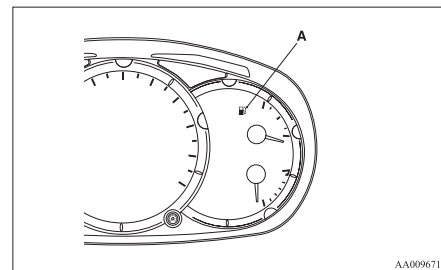

NOTE

- On inclines or curves, due to the movement of fuel in the tank, the low fuel warning lamp may indicate incorrectly.

Water temperature gauge

E00500800479

The water temperature gauge indicates the engine coolant temperature when the ignition switch is in the “ON” position.

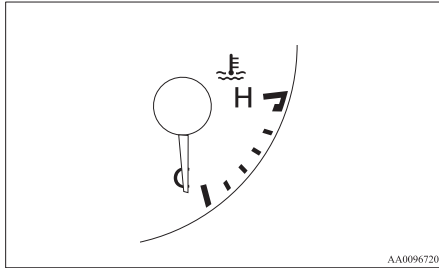

AA0096720

Turn the dial to adjust the illumination (meter, multi centre display, audio system’s control panel, heater control panel, etc.) to the desired brightness.

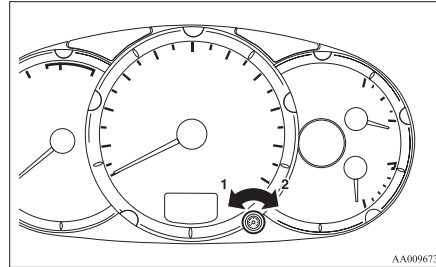

AA0096733

- 1- To reduce brightness
- 2- To increase brightness

⚠ CAUTION

- If the indication needle enters the H zone while the engine is running, it indicates that the engine is possibly overheating. Immediately park your vehicle in a safe place and make the necessary corrections. (Refer to “Engine overheating” on page 6-04.) While driving, care should always be taken to maintain the normal operating temperature.

Daytime dipper button (meter illumination control)*

E00500800273

The rheostat can be adjusted while the headlamps or tail lamps turn on.

Indication and warning lamps

E00501502305

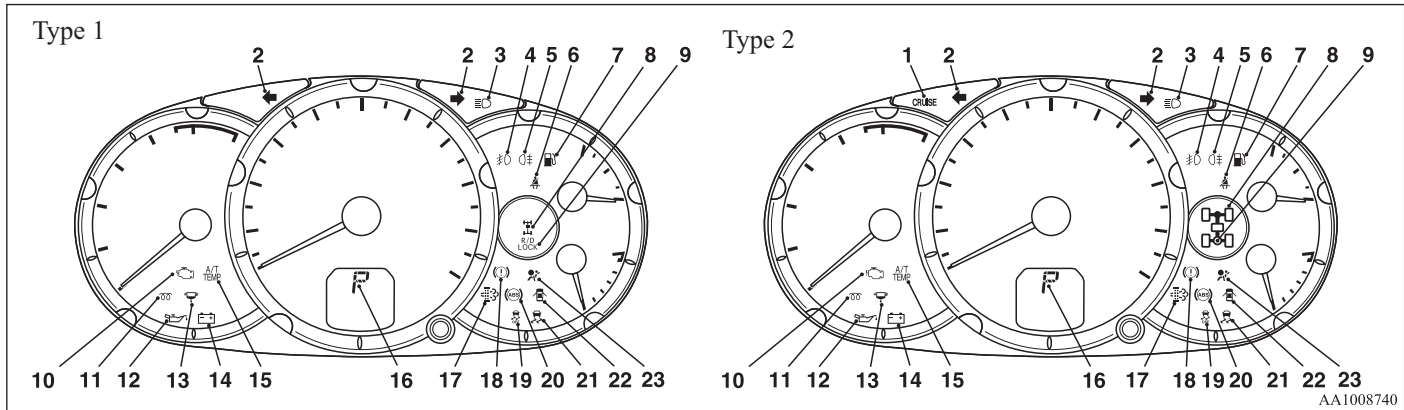

1. CRUISE indication lamp* → p. 4-45
2. Turn-signal indication lamps/Hazard warning indication lamps → p. 3-07
3. High-beam indication lamp → p. 3-07
4. Front fog lamp indication lamp* → p. 3-07
5. Rear fog lamp indication lamp → p. 3-07
6. Seat belt reminder/warning lamp → p. 2-11
7. Low fuel warning lamp → p. 3-04
8. 2WD/4WD operation indication lamp* → p. 4-24, 4-28
9. Rear differential lock indication lamp* → p. 4-31
10. Check engine warning lamp → p. 3-08
11. Diesel preheat indication lamp → p. 3-07
12. Oil pressure warning lamp → p. 3-09
13. Fuel filter indication lamp → p. 3-07

14. Charge warning lamp → p. 3-09
15. A/T (automatic transmission) fluid temperature warning lamp (vehicles with A/T) → p. 4-20
16. Selector lever position indicator (vehicles with A/T) → p. 4-18
17. Diesel particulate filter (DPF) warning lamp* → p. 4-13
18. Brake warning lamp → p. 3-08
19. Active Stability & Traction Control (ASTC) OFF indication lamp* → p. 4-43
20. Anti-lock brake system (ABS) warning lamp* → p. 4-40
21. Active Stability & Traction Control (ASTC) indication lamp* → p. 4-43
22. Door ajar warning lamp → p. 3-10
23. Supplement Restraint System (SRS) warning lamp* → p. 2-37

Indication lamps

E00501600012



Turn-signal indication lamps/ Hazard warning indication lamps

E00501700185

These indication lamps blink on and off when a turn-signal lamp is operating.

NOTE

- If the blinking is too fast, the cause may be a blown lamp bulb or a faulty turn-signal connection.

When the hazard warning lamp switch is pressed, all turn-signal lamps will flash on and off continuously.



High-beam indication lamp

E00501800115

This indication lamp illuminates when the high-beam is used.



Front fog lamp indication lamp*

E00501900347

This indication lamp illuminates while the front fog lamps are on.



Rear fog lamp indication lamp

E00502000114

This indication lamp illuminates while the rear fog lamp is on.



Diesel preheat indication lamp

E00502300250

This indication lamp illuminates when the ignition switch is placed in the “ON” position. As the glow plug becomes hot, the lamp goes out and the engine can be started.



CAUTION

- If the diesel preheat indication lamp comes on after the engine is started, the engine speed may not rise above the idling speed because of fuel freezing. In this case, keep the engine idling for about ten minutes, then turn off the ignition switch and immediately turn it on again to confirm that the diesel preheat indication lamp is off.

NOTE

- If the engine is cold, the diesel preheat indication lamp is on for a longer time.
- When the engine has not been started within about 5 seconds after the diesel preheat indication lamp went out, return the ignition switch to the “LOCK” position. Then, turn the switch to the “ON” position to preheat the engine again.



Fuel filter indication lamp

E00509900170

This indication lamp illuminates when the ignition switch is turned to the “ON” position and goes off after the engine has started. If it lights up while the engine is running, it indicates that water has accumulated inside the fuel filter; if this happens, remove the water from the fuel filter.

Refer to “Removal of water from the fuel filter” on page 6-06.

When the lamp goes out, you can resume driving. If it either does not go out or comes on from time to time, we recommend you to have the vehicle inspected.

Warning lamps

E00502400017



Brake warning lamp

E00502501637

This lamp illuminates when the ignition switch is turned to the “ON” position, and goes off after a few seconds.

Always make sure that the lamp goes off before driving.

With the ignition switch in the “ON” position, the brake warning lamp illuminates under the following conditions:

- When the parking brake lever has been engaged.
- When the brake fluid level in the reservoir falls to a low level.
- When the brake force distribution function is not operating correctly. (vehicles with anti-lock brake system)

CAUTION

- In the situations listed below, brake performance may be compromised or the vehicle may become unstable if brakes are applied suddenly; consequently, avoid driving at high speeds or applying the brakes suddenly. Furthermore, immediately the vehicle should be brought to a stop in a safe location and to have it checked.

CAUTION

- The brake warning lamp does not illuminate when the parking brake is applied or does not turn off when the parking brake is released.
- The ABS warning lamp and brake warning lamp illuminate at the same time. For details, refer to “ABS warning lamp” on page 4-40. (vehicles with anti-lock brake system)
- The brake warning lamp remains illuminated during driving.
- The vehicle should be brought to a halt in the following manner when brake performance has deteriorated.
 - Depress the brake pedal harder than usual. Even if the brake pedal moves down to the very end of its possible stroke, keep it pressed down hard.
 - Should the brakes fail, use engine braking to reduce your speed and carefully pull the parking brake lever to park your vehicle. Depress the brake pedal to operate the stop lamp to alert the vehicles behind you.



Check engine warning lamp

E00502601944

This lamp is a part of an onboard diagnostic system which monitors the emissions, engine and automatic transmission control systems.

If a problem is detected in one of these systems, this lamp illuminates.

Although your vehicle will usually be drivable and not need towing, we recommend you to have the system checked as soon as possible.

[Vehicles to comply with the Euro 3 and Euro 4 regulation]

This lamp will also illuminate for a few seconds when the ignition switch is turned to the “ON” position. If it does not go off after a few seconds, we recommend you to have the vehicle checked.

[Vehicles to comply with the Euro 5+]

This lamp will also illuminate when the ignition switch is turned to the “ON” position, and goes off after the engine has started. If it does not go off after the engine has started, we recommend you to have the system checked.

CAUTION

- Prolonged driving with this lamp on may cause further damage to the emission control system. It could also affect fuel economy and drivability.

CAUTION

- If the lamp does not illuminate when the ignition switch is turned to the “ON” position, we recommend you to have the system checked.
- If the lamp illuminates while the engine is running, avoid driving at high speeds and we recommend you to have the system checked.

During vehicle operation with the lamp illuminated, the vehicle may not accelerate when you depress the accelerator pedal.

When the vehicle is stationary with the lamp illuminated, you must depress the brake pedal more firmly than usual since the engine idling speed is higher than usual and the vehicle with an A/T has a stronger tendency to creep forward.

NOTE

- The engine electronic control module accommodating the onboard diagnostic system has various fault data (especially about the exhaust emission) stored.

This data will be erased if a battery cable is disconnected which will make a rapid diagnosis difficult. Do not disconnect a battery cable when the check engine warning lamp is ON.



Charge warning lamp

E00502700821

This lamp illuminates when the ignition switch is turned to the “ON” position, and goes off after the engine has started.

CAUTION

- If the lamp comes on while the engine is running, the probable cause is as shown below. Park the vehicle immediately at a safe place and we recommend you to have it checked.
 - Broken drive belt or abnormality in the charging system. A broken drive belt causes poor braking efficiency. Depress the brake pedal harder than usual to park the vehicle in a safe place.



Oil pressure warning lamp

E00502800620

This lamp illuminates when the ignition switch is turned to the “ON” position, and goes off after the engine has started. If it illuminates while the engine is running, the oil pressure is too low. If the warning lamp illuminates while the engine is running, turn the engine off and have it inspected.

CAUTION

- If this lamp illuminates when the engine oil level is not low, have it inspected.
- This warning lamp does not indicate the amount of oil in the crankcase. This must be determined by checking the oil level on the dipstick, while the engine is switched off.
- If you continue driving with low engine oil level or with this warning lamp illuminated, engine seizure may occur.

NOTE

- The oil pressure warning lamp should not be treated as an indication of the engine’s oil level. The oil level must be checked using the dipstick.



Door ajar warning lamp

E00503300475

This lamp illuminates when a door is either open or not completely closed. If the vehicle speed reaches approximately 8 km/h (5 mph) with a door open or incompletely closed, the warning lamp flashes 16 times and a buzzer simultaneously sounds 16 times as a warning.

CAUTION

- Before moving your vehicle, check that the warning lamp is OFF.

NOTE

- It is possible to change the buzzer setting for either of the following types of operation. For further information, we recommend you to consult a MITSUBISHI MOTORS Authorized Service Point.
 - No buzzer operation (buzzer disabled)
 - Continuous buzzer operation

Centre information display*

E00517800279

WARNING

- When operating the system for a prolonged period, make sure the vehicle is parked in a well-ventilated area to avoid the accumulation of toxic fumes inside and outside of the passenger compartment.

CAUTION

- The driver should not operate the display while the vehicle is in motion.
- When operating the system, stop the vehicle in a safe area.

When the ignition switch is turned to the “ACC” position, the screen switches on automatically.

NOTE

- Placing a cellular phone in the monitor’s small storage compartment may weaken the phone’s reception. This does not indicate a fault with the system.
- Use of wireless devices such as transceivers or a cellular phone near the monitor may make the following condition on the display. This does not indicate a fault with the system.
 - The screen goes dark temporarily.
 - The compass may not show the correct direction.
- Depending on the angle of view, you may see reddish horizontal lines on the monitor. The lines are a characteristic of the vacuum fluorescent display (VFD) used in the monitor. They do not indicate a fault.

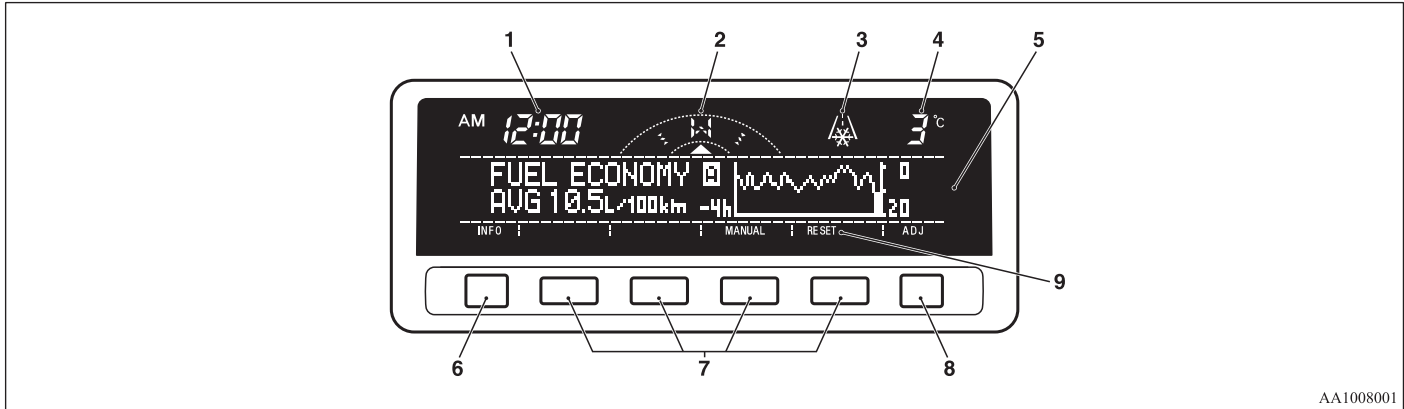

AA1008001

3

- 1- Clock → p. 3-19
Indicates the time.
- 2- Electronic compass
This display shows the direction of the vehicle.
- 3- Frozen road warning → p. 3-16
Gives an indication when the outside temperature is 3 °C or lower.
- 4- Outside temperature → p. 3-16
- 5- Centre information display indications
Indicates details of each display.
- 6- “INFO” button
Used to select various kinds of information for display.
- 7- Function buttons
Press this button to select options shown in the display.
- 8- “ADJ” button
Used for adjusting the clock and for selecting settings displays.
- 9- Display for function buttons
This display shows the options available for each function button.

Adjusting the time

E0051800063

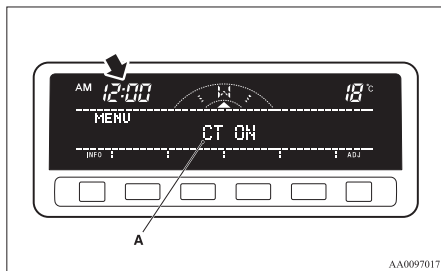

3

Following modes are available for clock adjustment:

- For vehicles with MITSUBISHI genuine audio:
 - “Automatic mode” and “Manual mode”
- Except for vehicles with MITSUBISHI genuine audio:
 - “Manual mode” only

Automatic mode (MITSUBISHI genuine audio)

The automatic adjustment mode can set the local time automatically by using the signal from the local RDS stations. In this mode, “CT” (A) (Clock Time; sent with the RDS signal) is shown in the audio display.

NOTE

- Automatic clock adjustment does not take place while a settings display is shown.

Manual mode

The manual mode is also available in case the automatic mode shows the incorrect time when the adjacent local RDS stations are located in a different time zone. Refer to “Radio data system (RDS)” on page 5-18.

It is possible to manually adjust the time. Refer to “Changing the clock settings” on page 3-19.

Changing the information display

E00517900270

Every time the “INFO” button is pressed lightly, the display can be changed to the following:

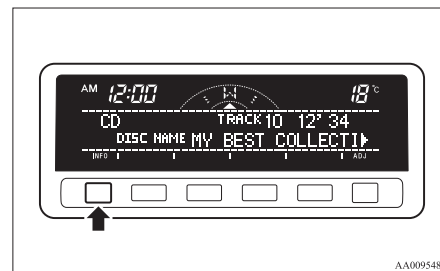

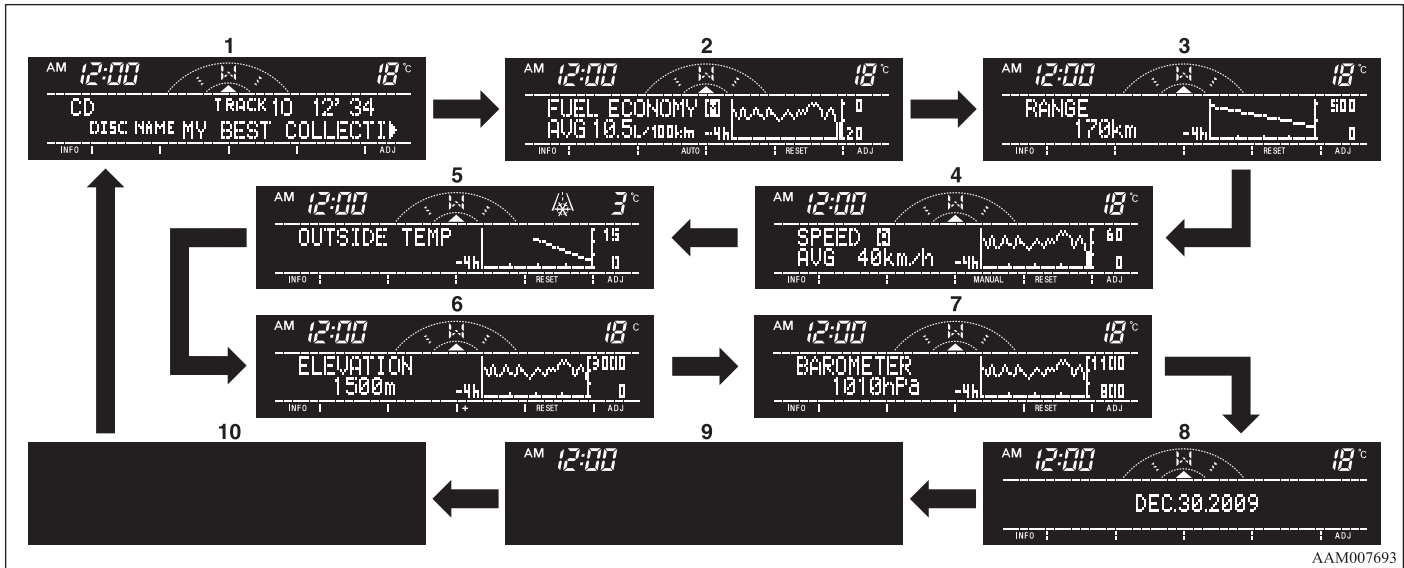

- 1- Audio information → p. 5-13
- 2- Average fuel consumption → p. 3-14
- 3- Driving range → p. 3-14
- 4- Average speed → p. 3-15
- 5- Outside temperature → p. 3-16
- 6- Altimeter → p. 3-16
- 7- Barometer → p. 3-17
- 8- Calendar → p. 3-18
- 9- Clock-only → p. 3-18
- 10- Blank → p. 3-18

Instruments and controls

Average fuel consumption

E00518200267

The average fuel consumption during the period since the last reset is shown in (A) and the momentary fuel consumption in (C). The average value of the fuel consumption is graphed every 5 minutes and the data for up to 4 hours are shown in (B). When you press the “MANUAL” function button in the auto reset mode, the mode will be changed to the manual reset mode. When you press the “AUTO” function button in the manual reset mode, the mode will be changed to the auto reset mode.

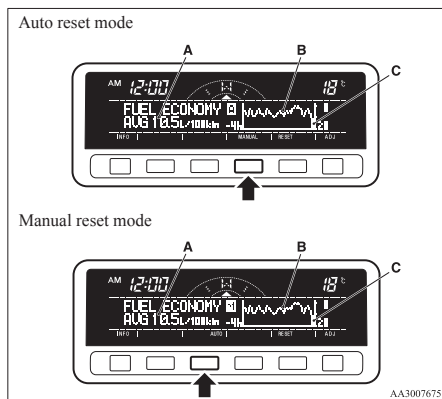

NOTE

- When you turn the ignition switch to the “ON” position after turning it from the “ON” position to the “ACC” or “LOCK” position in the manual reset mode, the auto reset mode will automatically be selected.

- When the average fuel consumption cannot be calculated, “-.-” will be shown.
- The average and momentary fuel consumption change depending on the driving condition (road condition, driving behavior, etc.). The indications may differ from the actual fuel consumption. Therefore, it is recommended to use the indications as reference.
- The unit indication can be changed to your desired setting {km/L, L/100 km, mpg (UK GALLON), or mpg (US GALLON)}. Refer to “User customization” on page 3-24.

Resetting the average fuel consumption

Press the “RESET” function button to reset the average fuel consumption indication.

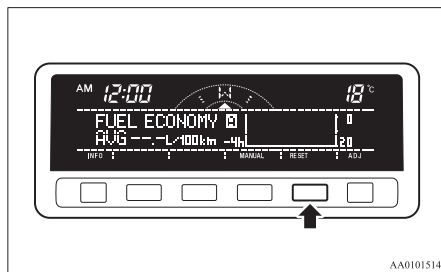

NOTE

- The average fuel consumption can be reset separately for the auto reset mode and for the manual reset mode.

- When you turn the ignition switch to the “ON” position about 4 hours (or more) after turning it from the “ON” position to the “ACC” or “LOCK” position in the auto reset mode, the average fuel consumption indication will automatically be reset.

Driving range

E00518300095

This value (A) shows the distance (in km or miles) that can be driven on the fuel remaining in the fuel tank. The driving range is graphed every 5 minutes and the data for up to 4 hours are shown in (B).

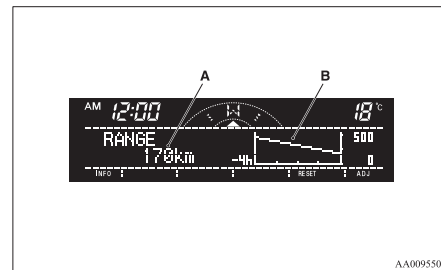

NOTE

- When the driving range is 50 km (30 miles) or less, the display shows “----”.
- When it is 3,000 km (2,000 miles) or more, “3,000 km” or “2,000 miles” will be shown.
- When the driving range cannot be measured, the display shows “----”.

- The driving range is shown based on the accumulated fuel consumption data, however, may be changed depending on the driving condition (road condition, driving behavior, etc.). If the battery terminals are disconnected, the accumulated fuel consumption data will be erased. It is recommended to use the indication as reference.
- When the vehicle is fueled, the driving range will be updated. However, if the amount of fueling is small, the indication may not be correct. Therefore, fill up the tank as much as possible in case of fueling.
- When the vehicle is stopped on a steep slope, the value of the driving range may increase. This is caused by the fuel movement inside the tank on the slope and is not deemed as a failure.

Resetting the driving range

Press the “RESET” function button to reset the driving range plotted in graph.

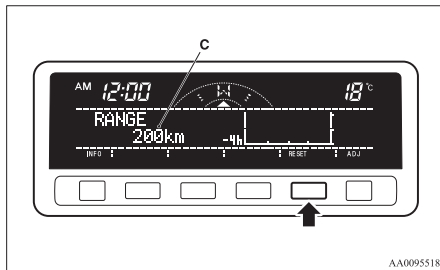

NOTE

- Pressing the “RESET” function button will not reset the indication (C).
- It is possible to set the display unit to km or miles. Refer to “User customization” on page 3-24.

Average speed

E00518400126

The average speed during the period since the last reset is shown in (A) and the momentary speed in (C). The average value of the vehicle speed is graphed every 5 minutes and the data for up to 4 hours are shown in (B).

When you press the “MANUAL” function button in the auto reset mode, the mode will be changed to the manual reset mode. When you press the “AUTO” function button in the manual reset mode, the mode will be changed to the auto reset mode.

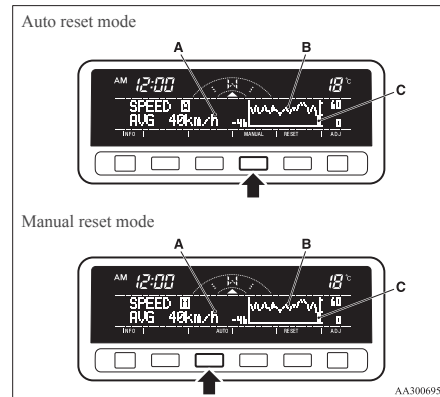

NOTE

- When you turn the ignition switch to the “ON” position after turning it from the “ON” position to the “ACC” or “LOCK” position in the manual reset mode, the auto reset mode will automatically be selected.
- When the average speed cannot be calculated, “--” will be shown.
- The average and momentary speed change depending on the driving condition (road condition, driving behavior, etc.). The indications may differ from the actual speed. Therefore, it is recommended to use the indications as reference.
- The unit indication can be changed to your desired setting (km/h or mph). Refer to “User customization” on page 3-24.

Resetting the average speed

Press the “RESET” function button to reset the average vehicle speed.

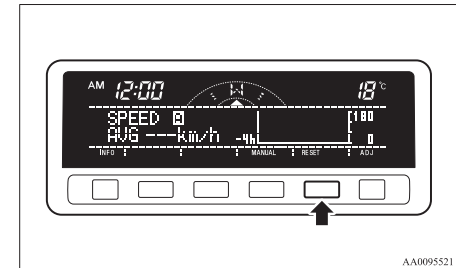

Instruments and controls

NOTE

- The average speed can be reset separately for the auto reset mode and for the manual reset mode.
- When you turn the ignition switch to the “ON” position about 4 hours (or more) after turning it from the “ON” position to the “ACC” or “LOCK” position in the auto reset mode, the average speed indication will automatically be reset.

Outside temperature

E0051850097

The outside temperature is graphed every 5 minutes and the data for up to 4 hours are shown in (A). The current outside temperature is shown in (B).

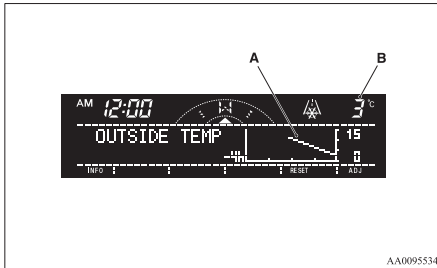

Resetting the outside temperature

Press the “RESET” function button to reset the graph of the outside temperature.

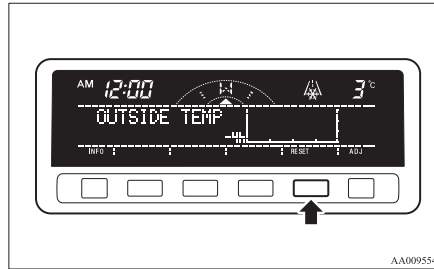

NOTE

- Depending on factors such as the driving conditions, the displayed temperature may vary from the actual outside temperature.
- It is possible to set the display unit to °C or °F. Refer to “User customization” on page 3-24.

Frozen road warning

This shows the temperature outside the vehicle.

When the outside air temperature drops below about 3 °C (37 °F), the alarm sounds and the outside air temperature warning symbol (A) flashes for about 10 seconds.

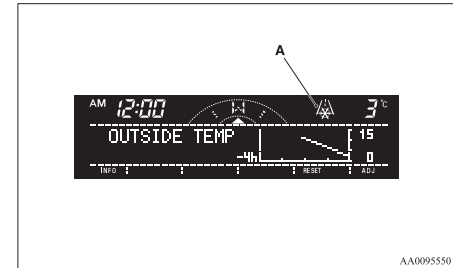

CAUTION

- There is a danger the road might be icy, even when this symbol is not flashing, so please take care when driving.

Altimeter

E0051860069

The current elevation in units of 100 m (400 ft) is shown in (A). The elevation is graphed every 5 minutes and the data for up to 4 hours are shown in (B).

To adjust the elevation

It is possible to adjust the currently indicated elevation using the following function buttons:

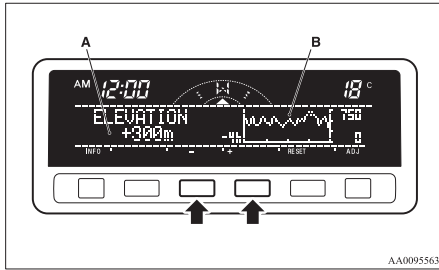

AA0095563

“+”-

Adjustment of elevation
The elevation increases by 100 m (400 ft) every time you lightly push the “+” button.
If you continue pressing the button for about 2 seconds or more, the elevation indication is fast-forwarded. Then the setting is changed to the elevation selected.

“-”-

Adjustment of elevation
The elevation decreases by 100 m (400 ft) every time you lightly push the “-” button.
If you continue pressing the button for about 2 seconds or more, the elevation indication is fast-forwarded. Then the setting is changed to the elevation selected.

NOTE

- The elevation is determined from changes in atmospheric pressure. Depending on weather conditions, the indicated elevation may differ from the actual elevation. Variations in atmospheric pressure can cause different elevations to be shown even in the same location. This behavior does not indicate a fault. Use the indication as a guide only.

Resetting the elevation

Press the “RESET” function button to reset the elevation plotted in graph.

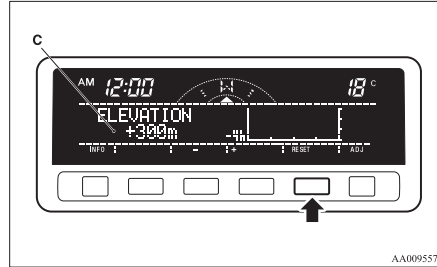

AA0095576

NOTE

- Pressing the “RESET” function button will not reset the indication (C).
- It is possible to set the display unit to m or ft. Refer to “User customization” on page 3-24.

Barometer

E0051870044

This display shows the atmospheric pressure at the present location in (A). The atmospheric pressure values are graphed every 5 minutes and the data for up to 4 hours are shown in (B).

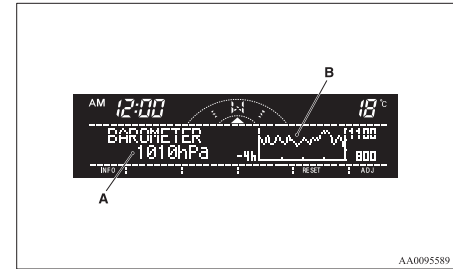

AA0095589

Resetting the atmospheric pressure

Press the “RESET” function button to reset the atmospheric pressure plotted in graph.

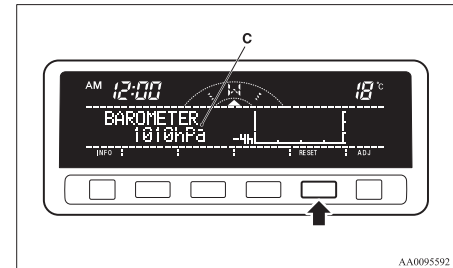

AA0095592

Instruments and controls

NOTE

- Pressing the “RESET” function button will not reset the indication (C).
- It is possible to set the display unit to hPa, mb, kPa, or inHg.
Refer to “User customization” on page 3-24.

Calendar

E00518800032

The date is shown. The calendar pattern can be changed to your desired setting.
Refer to “Changing the calendar setting” on page 3-23.

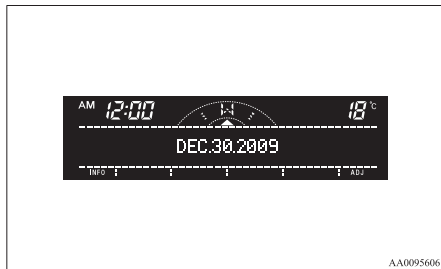

Clock-only

E00518900033

Only the clock is shown. The time notation can be changed to your desired setting. (12 hour/24 hour)

Refer to “User customization” on page 3-24.

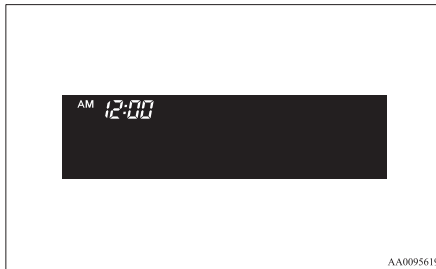

Blank

E00519000015

The whole display can be turned into blank. In this case, buttons remain illuminated.



NOTE

- If you operate the audio system, the audio display pops up.

Selecting settings displays

E00519100090

Every time the “ADJ” button is pressed lightly, the display can be changed to the following:

CAUTION

- The driver should not operate the display while the vehicle is in motion.
- When operating the system, stop the vehicle in a safe area.

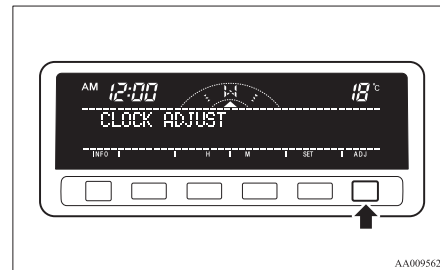

- 1- Changing the clock settings → p. 3-19
- 2- Adjusting the display brightness → p. 3-20
- 3- Correcting the compass → p. 3-21
- 4- Changing the calendar setting → p. 3-23
- 5- User customization → p. 3-24
- 6- Adjusting the barometer → p. 3-28

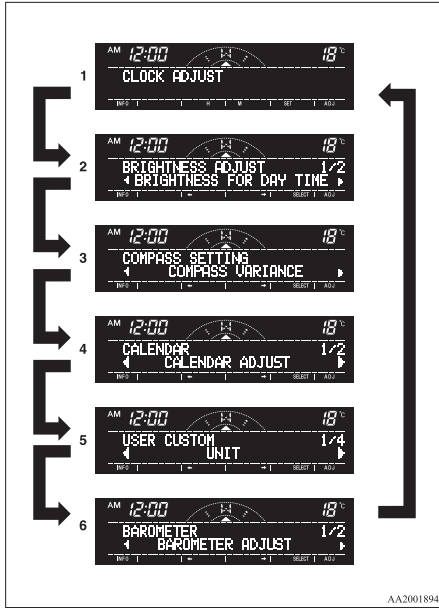

Changing the clock settings

E00519200121

1. Press the “ADJ” button to select the clock setting display.

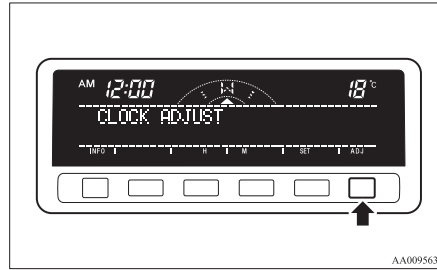

2. It is possible to adjust the clock using the function buttons.

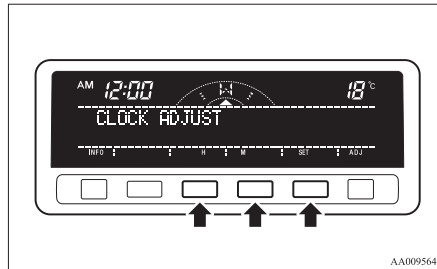

“H”- Adjust “hour”.
The indication increases by one hour, every time you lightly press the “H” function button. If you continue pressing the button for about 2 seconds or more, the indication is fast-forwarded, and then the setting is changed to the hour selected.

“M”- Adjust “minute”.
The indication increases by one minute, every time you lightly press the “M” function button. If you continue pressing the button for about 2 seconds or more, the indication is fast-forwarded, and then the setting is changed to the minute selected.

“SET”- To reset the minutes to zero.
The time is adjusted as described below by pressing the function button “SET”.

- 10:30-11:29 change to 11:00
- 11:30-12:29 change to 12:00

In this occasion, the display flashes twice and then the setting is changed.

3. After making the adjustment, press the “INFO” button to select the information display.

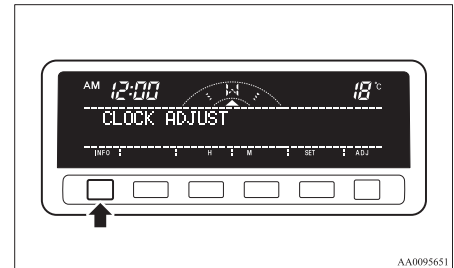

Instruments and controls

Adjusting the display brightness

E00519300034

The display brightness can be adjusted at 13 levels for both daytime and nighttime.

- **BRIGHTNESS FOR DAY TIME**

The display brightness is adjusted when the light switch is in the “OFF” position.

- **BRIGHTNESS FOR NIGHT TIME**

The display brightness is adjusted when the light switch is in the “☰” or “☷” position.

1. Press the “ADJ” button to show the brightness adjusting display.

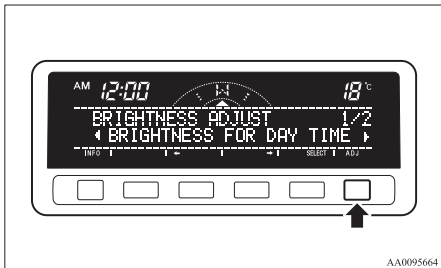

2. Press the “←” or “→” function button to select the setting you wish to adjust (daytime or nighttime). Then press the “SELECT” function button.

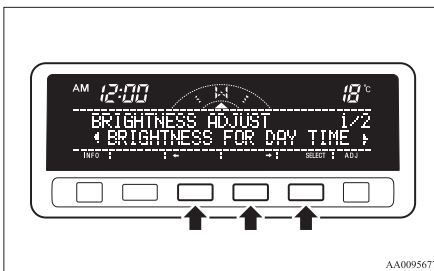

3. Use the function buttons to adjust the brightness.

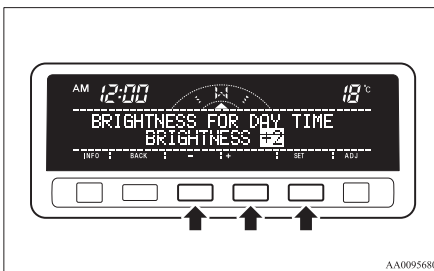

“+”- To make the display brighter

The display becomes brighter by one step, every time you lightly press the “+” function button. If you continue pressing the button for about 2 seconds or more, the indication is fast-forwarded.

“-”- To make the display darker

The display becomes darker by one step, every time you lightly press the “-” function button. If you continue pressing the button for about 2 seconds or more, the indication is fast-forwarded.

“SET”- To set the brightness

Press function button “SET” to set the new brightness. The display will flash twice.

NOTE

- If you next wish to adjust the other adjustment setting (daytime or nighttime), press the “ADJ” button or “BACK” function button.

4. After adjustment, press the “INFO” button to select the information display.

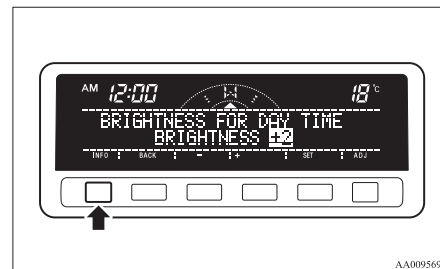

NOTE

- As the display brightness can be adjusted in the center information display only, the brightness inside the meter cannot be changed.

Correcting the compass

E00519400178

This compass shows the direction of the vehicle by the 8 azimuth system.

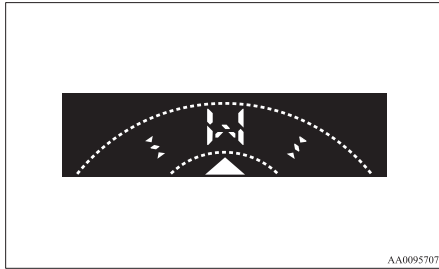

NOTE

- This system uses the earth's magnetic field, and so may not show the correct direction depending on the traffic condition or in the following places where the earth's magnetic field is disrupted.
 - Car parks located in buildings and tunnels
 - Expressways and underground cables
 - Area over the subway
 - Transforming station
 - Areas along the railroad

In these cases, the correct direction will be displayed once the vehicle returns to a place where the earth's magnetic field is stable.

- Do not install ski racks, antennas, etc. which are attached to the vehicle by means of a magnet. They affect the operation of the compass.

Setting the declination

The declination is the difference between true north (the direction of the geographic north pole) and where a compass needle points to. Since the declination varies from place to place, it needs to be set for each region. Otherwise the compass will not show the correct direction.

Set the declination by the following steps:

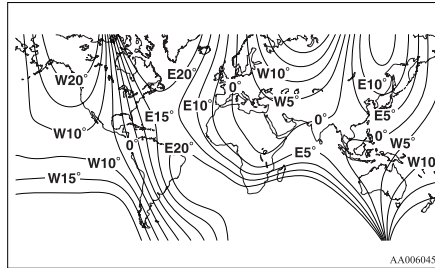

NOTE

- The default declination setting is 0 degrees. In accordance with the illustration, set the declination setting to the declination contour nearest to a region where you drive the vehicle.
- The declination can be set at intervals of 1 degree, from 28 degrees west (W28) to 28 degrees east (E28).

With a settings display showing, press the "ADJ" button and select "COMPASS VARIANCE".

1. Press the function button for "SELECT".

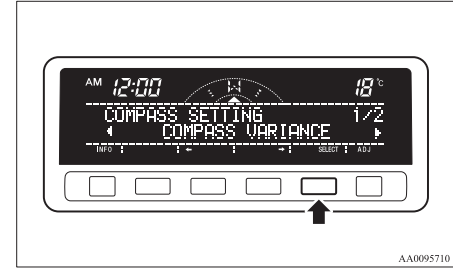

2. Press the function button for "←" or "→" to set the desired declination.

Pressing "←" or "→" for more than 1 second makes the value change rapidly.

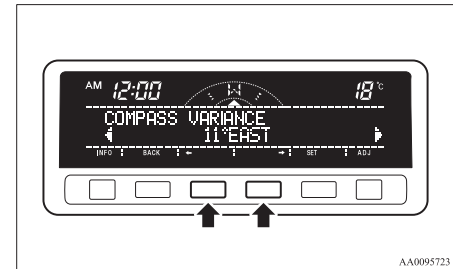

Instruments and controls

- When the declination adjustment has been completed, press the “SET” function button.

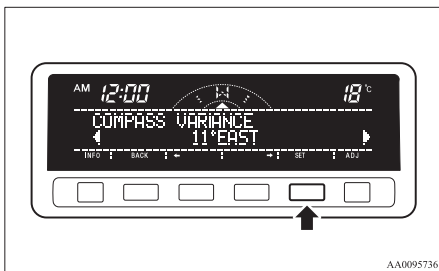

3

Setting the compass

The compass is usually calibrated automatically when the vehicle is moving. At times when complete calibration is not possible, no compass indications are given. Manually set the compass using the following procedure.

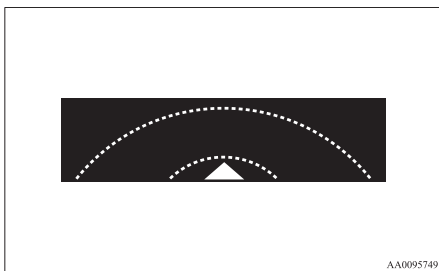

NOTE

- If your vehicle has a sunroof, keep the sunroof closed when calibrating the compass. Having the sunroof open when calibrating the compass could render the compass unable to correctly show directions.

With a settings display showing, press the “ADJ” button and select “COMPASS CALIBRATION”.

- Press the function button for “SELECT”.

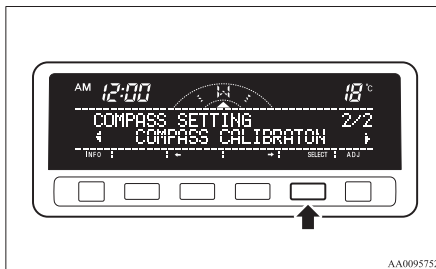

- Press the function button for “SELECT”.

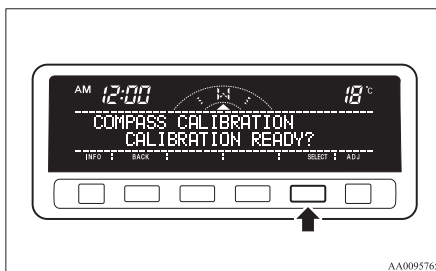

- Turn the vehicle slowly through 360 degrees in a safe, open area with no buildings and other vehicles.



NOTE

- If you wish to stop calibrating the compass part-way through the procedure, press the “INFO” button or “ADJ” button.

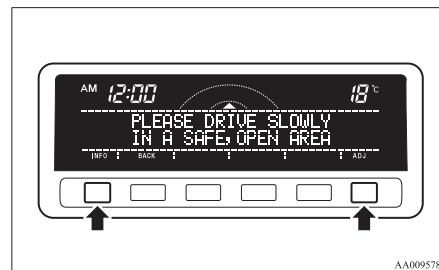

NOTE

- The “Completed the calibration”. message may be displayed even if you terminate the turn before it is complete and return to the vehicle’s original direction. The compass may not be properly calibrated in this case, so you must turn the vehicle through at least 360 degrees.

4. The compass setting will finish automatically and the words “COMPASS CALIBRATION COMPLETE” will appear on the screen.

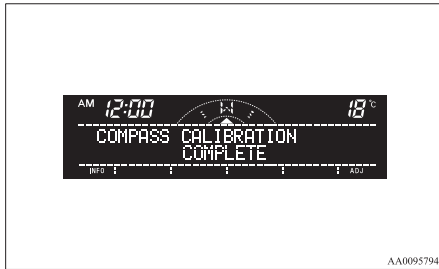

AA0095794

Changing the calendar setting

E0051950065

The date and the calendar indication patterns can be changed.

Date setting

1. Press the “ADJ” button to select the calendar setting display.

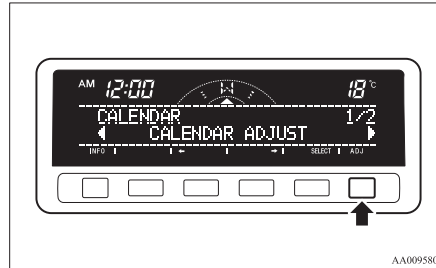

AA0095808

2. Press the “←” or “→” function button to select “CALENDAR ADJUST”. Then press the “SELECT” function button.

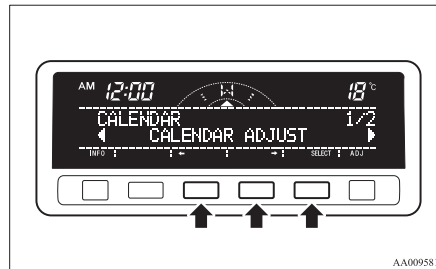

AA0095811

3. Use the function buttons to set the calendar.

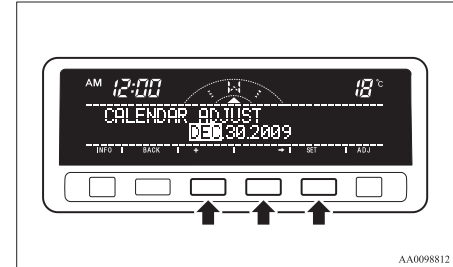

AA0098812

“→”- Select “YEAR”, “MONTH”, “DAY” you wish to change. “YEAR”, “MONTH”, and “DAY” are changed over by turns every time you lightly press the “→” function button.

“+”- Change “YEAR”, “MONTH”, “DAY” you have selected. The indication is changed to your desired date every time you lightly press the “+” function button.

If you continue pressing the button for about 2 seconds or more, the indication is forwarded.

“SET”- Determine the date. Press the “SET” function button. Then the display flashes twice and the setting is changed.

NOTE

- The year changes in the following sequence: 2012 → 2013 → ... 2099 → 2012.
- You can return to the previous display by pressing the “BACK” function button.

Instruments and controls

- After setting the date, press the “INFO” button to return to the information display.

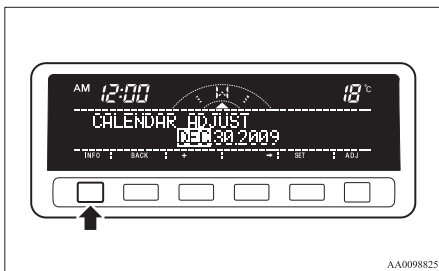

Changing the calendar pattern

- Press the “ADJ” button to select the calendar setting display. Press the “←” or “→” function button to select “CALENDAR PATTERN SELECT”. Then press the “SELECT” function button.

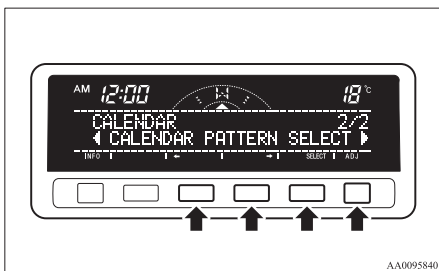

- Press function button “←” or “→” to select your desired indication pattern.

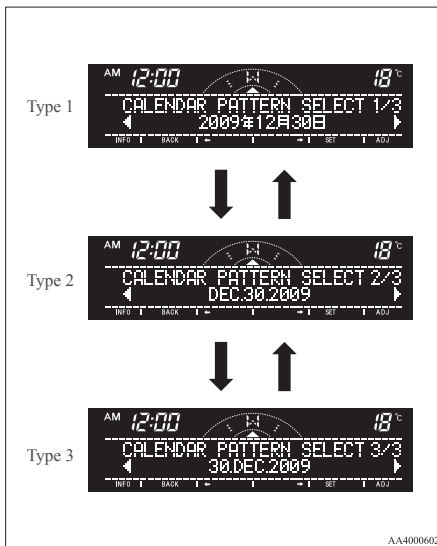

- Press the function button “SET”. The display will flash twice, and the indication pattern will be updated.

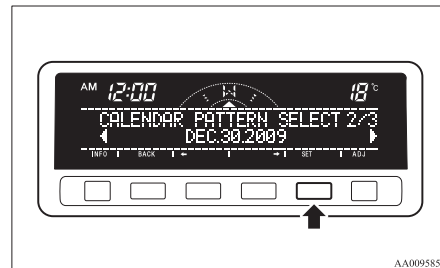

NOTE

- You can return to the previous display by pressing the “BACK” function button.

- After setting the calendar pattern, press the “INFO” button to return to the information display.

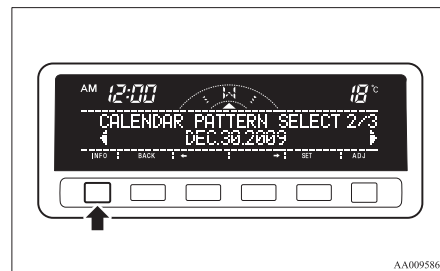

User customization

E00519600183

You can set the indication of unit, language, and the time notation.

In addition, you can return these settings to the factory default settings.

Selecting the item to set

1. Press the “ADJ” button to select the user customization display.

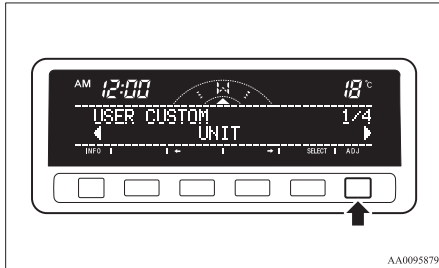

2. Press the function button “←” or “→” to select the item you wish to set.
 - “UNIT”: Changing the unit
 - “LANGUAGE”: Changing the language
 - “12h ↔ 24h”: Changing the time format
 - “DEFAULT”: Resetting to factory settings
 Push the function button “SELECT”. The setting display for your selected item will appear.

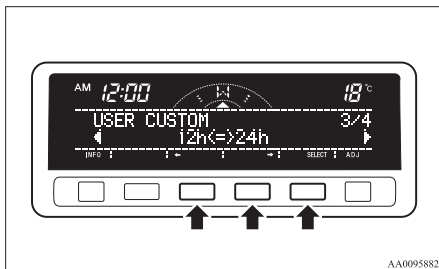

Changing display units

It is possible to change the display units for the fuel consumption, driving range, average speed, outside temperature, elevation, and atmospheric pressure as shown below.

FUEL ECONOMY	km/L → L/100 km → mpg (UK GALLON) → mpg (US GALLON)
RANGE	km → miles
SPEED	km/h → mph
OUTSIDE TEMPERATURE	°C → °F
ELEVATION	m → ft
BAROMETER	hPa → mb → kPa → inHg

- Changing the display unit for fuel consumption

1. Press the “←” or “→” function button to select “FUEL ECONOMY”. Then press the “SELECT” function button.

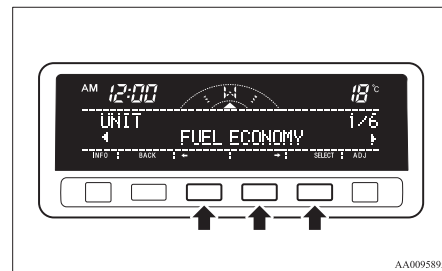

2. Press the “←” or “→” function button to select “km/L”. Then press the “SET” function button. The display will flash twice, and the display unit will be updated to the selected one.

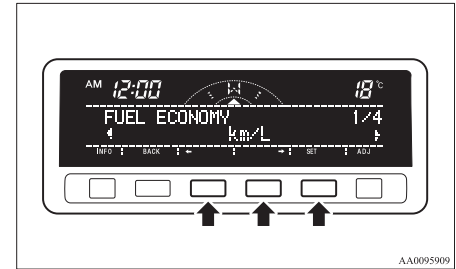

NOTE

- You can return to the previous display by pressing the “BACK” function button.
3. After setting, press the “INFO” button to return to the information display.

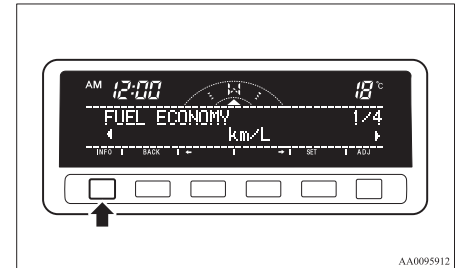

Instruments and controls

Changing the language

It is possible to set the display language of the centre information display.

- To change the display language to English

1. Press the “←” or “→” function button to select “ENGLISH”. Then press the “SET” function button. The display will flash twice, and then the setting is completed to the language selected.

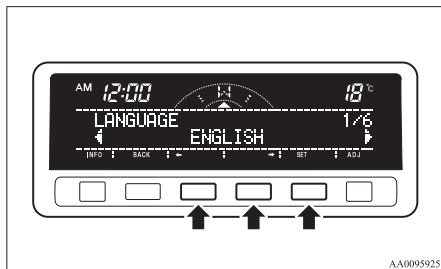

NOTE

- You can return to the previous display by pressing the “BACK” function button.

2. After setting the language, press the “INFO” button to return to the information display.

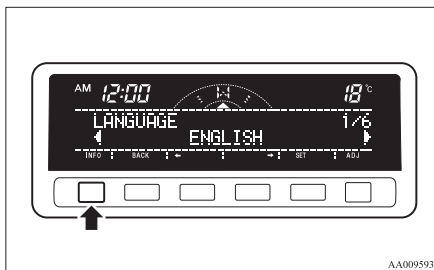

Changing the time notation

It is possible to set the time notation to 12-hour or 24-hour.

1. Press the “←” or “→” function button to select “12h TIME NOTATION” or “24h TIME NOTATION”. Then press the “SET” function button. The display will flash twice, and the display time notation will be updated to the selected one.

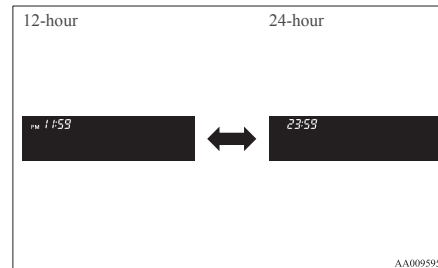
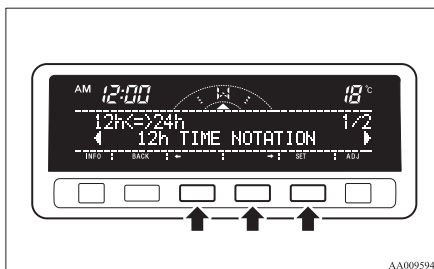

NOTE

- You can return to the previous display by pressing the “BACK” function button.
2. After setting the time notation, press the “INFO” button to return to the information display.

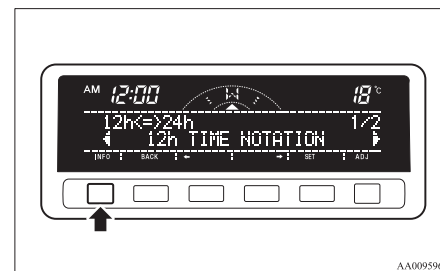

Returning display items to their factory settings

You can return to the setting of each item to the factory default settings.

NOTE

- The factory settings are as follows:
 - Fuel consumption: L/100 km (62 mph)
 - Driving range: km
 - Average speed: km/h
 - Outside temperature: °C
 - Elevation: m
 - Atmospheric pressure: hPa
 - Display language: English
 - Time notation: 12-hour

1. Push the “SELECT” function button.

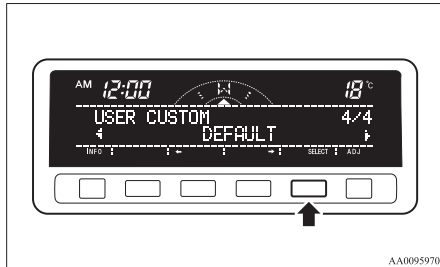

2. Press the “←” function button to select “YES”.

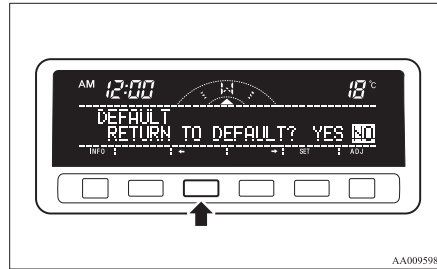

3. Press the “SELECT” function button.

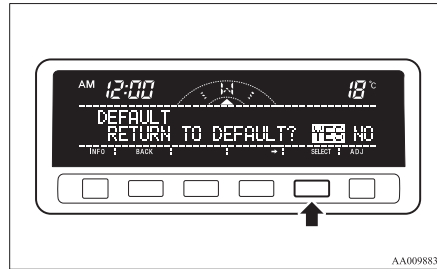

4. Once more press the “←” function button to select “YES”.

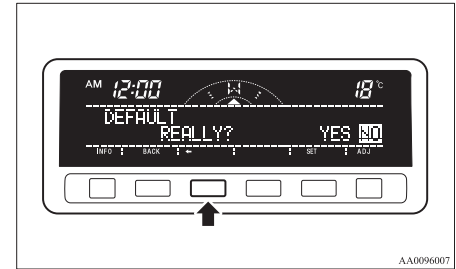

5. Press the “SET” function button.

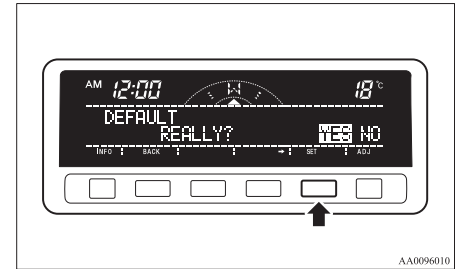

6. The display shown below will appear, and the display items will return to their factory settings.

Instruments and controls

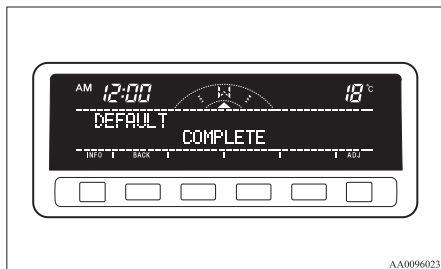

AA0096023

NOTE

- If the battery terminals are disconnected, the settings for the date and time may be erased. If this happens, please set the date and time again.

Adjusting the barometer

E00524400033

It is possible to adjust the barometer indication and return it to the factory setting.

NOTE

- It is not necessary to adjust the barometer because it has been adjusted at the factory. However, if you wish, adjust it using an accurate barometer.

To adjust the barometer

1. Press the “ADJ” button to select the barometer adjustment display.

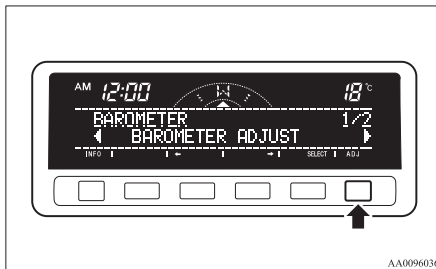

AA0096036

2. Press the “←” or “→” function button to select the “BAROMETER ADJUST” display. Then press the “SELECT” function button.

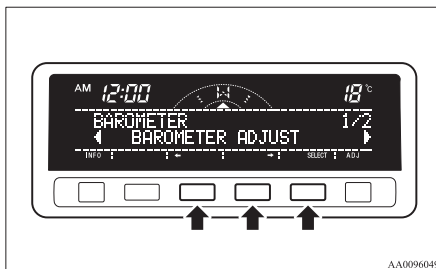

AA0096049

3. Adjust the barometer by pressing the function buttons.

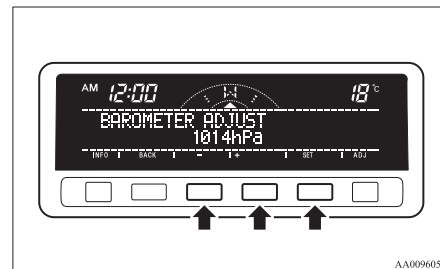

AA0096052

“+”-

To adjust the barometer
Each gentle press of the “+” function button will increase the indicated barometer by 2 hPa. If you continue pressing the button for about 2 seconds or longer, the indication is fast-forwarded.

“-”-

To adjust the barometer
Each gentle press of the “-” function button will decrease the indicated barometer by 2 hPa. If you continue pressing the button for about 2 seconds or longer, the indication is fast-forwarded.

“SET”-

To set the barometer
Press the “SET” function button. The display will flash twice, and the new setting will be established.

NOTE

- You can return to the previous display by pressing the “BACK” function button.

- After setting the barometer adjust, press the “INFO” button to return to the information display.

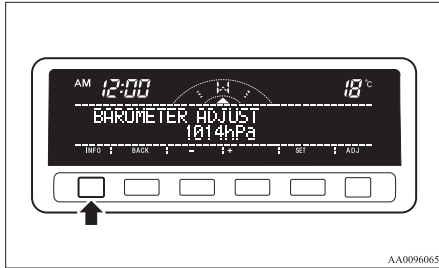

- Press the “SET” function button. The display will flash twice and the barometer indication will return to the factory settings.

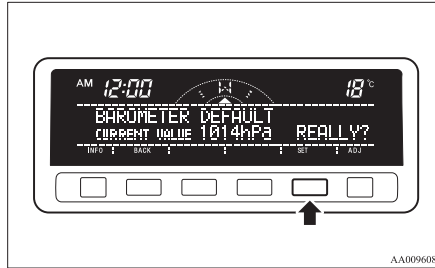

- After setting the barometer default, press the “INFO” button to return to the information display.

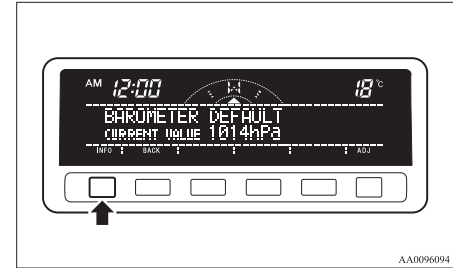

Resetting to the factory setting

- Press the “ADJ” button to select the barometer adjustment display. Press the “←” or “→” function button to select the “BAROMETER DEFAULT” display. Then press the “SELECT” function button.

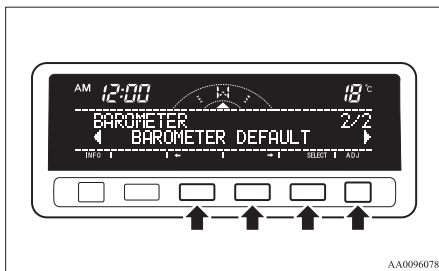

NOTE

- Although the barometer value is changed to the factory setting, a barometer unit you have selected is unchanged.
- You can return to the previous display by pressing the “BACK” function button.

Care of the monitor

E00519700012

If the monitor becomes covered in fingerprints or otherwise dirty, clean it with a soft and dry cloth.

NOTE

- Don't use a wet cloth or abrasive cleaner as this may cause damage.

Combination headlamps and dipper switch

E00506001728

Headlamps

NOTE

- Do not leave the headlamps and other lamps on for a long time while the engine is stationary (not running). A run-down battery could result.
- When it rains or when the vehicle has been washed, the inside of the lens sometimes becomes foggy. This is the same phenomenon as when window glass mists up on a humid day, and does not indicate a functional problem. When the lamp is switched on, the heat will remove the fog. However, if water gathers inside the lamp, we recommend you to have it checked.

Type 1

Rotate the switch to turn on the lamps.

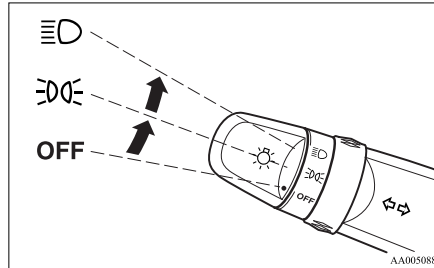

OFF	All lamps off
AUTO	Position, tail, licence plate and instrument panel lamps on
ON	Headlamps and other lamps go on

Type 2

Rotate the switch to turn on the lamps.

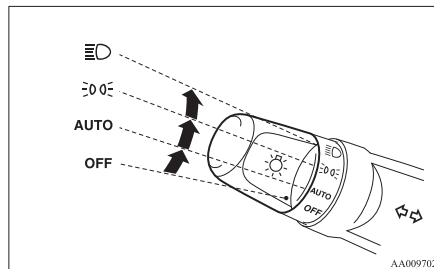

OFF	All lamps off
AUTO	With the ignition switch in the "ON" position, headlamps, position, tail, licence plate, and instrument panel lamps turn on and off automatically in accordance with outside light level. All lamps turn off automatically when the ignition switch is turned to the "OFF" position.
AUTO	Position, tail, licence plate and instrument panel lamps on
ON	Headlamps and other lamps go on

NOTE

- The sensitivity of the automatic on/off control can be adjusted. For further information, we recommend you to consult a MITSUBISHI MOTORS Authorized Service Point.
- When the headlamps are turned off by the automatic on/off control with the ignition switch in the "ON" position, the front fog lamps (if so equipped) and rear fog lamp also go off. When the headlamps are subsequently turned back on by the automatic on/off control, the front fog lamps also come on but the rear fog lamp stays off. If you wish to turn the rear fog lamp back on, operate the switch again.
- Do not cover the sensor (A) for the automatic on/off control by affixing a sticker or label to the windscreen.

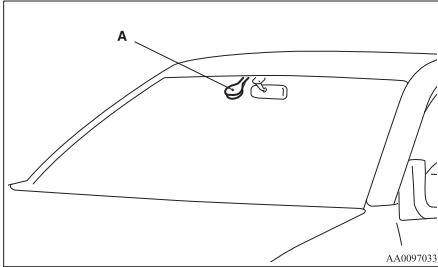



- If the lamps do not turn on or off with the switch in the “AUTO” position, manually operate the switch and we recommend you to have your vehicle checked.

[Vehicles with Daytime Running Lamp]



When the ignition switch is in the “ON” position and the lamp switch is set to the “OFF” position, the low beam of the headlamps, tail lamps, etc., will illuminate.

Lamps (headlamps, fog lamp, etc.) auto-cut-out function



- If the ignition key is turned to “LOCK” or “ACC” position or removed from the ignition switch and the lamps will stay on for about 3 minutes without opening the driver’s door while the lamp switch in the “” position, the lamps automatically turn off.

- If the ignition key is turned to “LOCK” or “ACC” position or removed from the ignition switch and the driver’s door is opened within 3 minutes while the lamp switch in the “” position, a buzzer will sound to warn the driver that the lamps have not been turned off, and these lamps will automatically turn off.

NOTE

- The lamp auto-cutout will not function when the lamp switch is in the “” position.
- When the ignition key has been turned either to the “LOCK” or “ACC” position or removed from the ignition switch with the lamp switch in the “” position, and the lamp switch is returned to the “OFF” position within approximately 3 minutes, the auto-cutout function will not be activated.

When you want to keep the lamps on

- Turn the lamp switch in the “OFF” position to switch off all lamps while the ignition key is in the “LOCK” or “ACC” position or remove it from the ignition switch.
- Turn on the lamps with the switch in the “” or “” position again, then the lamps will remain on.

NOTE

- It is possible to alter the auto-cutout function such that:
 - Auto-cutout function is never activated.
 For details, we recommend you to consult a MITSUBISHI MOTORS Authorized Service Point.

Lamp monitor buzzer

E00506100184

If the driver’s door is opened when the ignition key is in the “LOCK” or “ACC” position or removed from the ignition switch while the lamps are on, a buzzer will sound to remind the driver to turn off the lamps. When the lamp auto-cutout function acts, the buzzer will stop automatically. When this function does not act, turn off the lamp switch to stop the buzzer.

Dipper (High/Low beam change)

E00506200286

When the lamp switch is in the “” position, the beam changes from high to low (or low to high) each time the lever is pulled to (1). While the high-beam is on, the high-beam indication lamp in the instrument cluster will also illuminate.

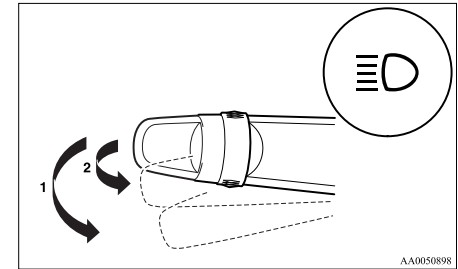

Headlamp flasher

E00506300157

The high-beams flash when the lever is pulled slightly (2), and will go off when it is released. When the high-beam is on, the high-beam indication lamp in the instrument cluster will also illuminate.

Instruments and controls

NOTE

- The high-beams can also flash when the lamp switch is in the “OFF” position.
- If you turn the lamps off with the headlamps set to high-beam illumination, the headlamps are automatically returned to their low-beam setting when the lamp switch is next turned to the “D” position.

Headlamp levelling switch*

E00506400826

The angle of the headlamp beam varies depending on the load carried by the vehicle. The headlamp levelling switch can be used to adjust the headlamp illumination distance (when the lower beam is illuminated) so that the headlamps’ glare does not distract other drivers. Set the switch (referring to the following table) to the appropriate position according to the number of people and the load in the vehicle.

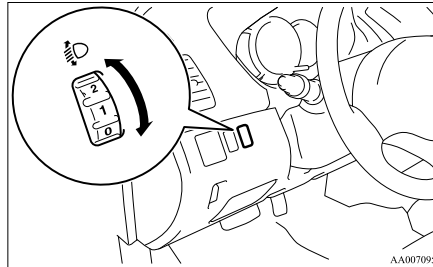

AA0070953



CAUTION

- Always perform adjustments before driving. Do not attempt to adjust while driving, as it could cause an accident.

NOTE

- When adjusting the beam position, first put the dial in the “0” position (the highest beam position).

Single cab

Vehicle condition		
Switch position	“0”	“2”



●: 1 person

: Full luggage loading

Switch position 0- Driver only

Switch position 2- Driver + Full luggage loading

Club cab

Vehicle condition		
Switch position	“0”	“3” or “4”

●: 1 person

: Full luggage loading

Switch position 0- Driver only

Switch position 3- Driver + Full luggage loading
{Vehicles with heavy duty suspension}

Switch position 4- Driver + Full luggage loading
 {Vehicles without heavy duty suspension}



Switch position 4- Driver + Full luggage loading
 {Vehicles with headlamp - type 1* and without heavy duty suspension}

Turn-signals lever

E00506501273

The turn-signal lamps flash when the lever is operated (with the ignition switch in the “ON” position). At the same time, the turn-signal indication lamps flash.

Double cab

Vehicle condition		
Switch position	“0”	“2” or “3” or “4”

●: 1 person

▨: Full luggage loading

Switch position 0- Driver only

Switch position 2- Driver + Full luggage loading
 {Vehicles with heavy duty suspension for Russia, Kazakhstan and Ukraine}

Switch position 3- Driver + Full luggage loading
 {Vehicles with heavy duty suspension except for Russia, Kazakhstan and Ukraine}
 {Vehicles with headlamp - type 2* and without heavy duty suspension}

*: Refer to “Outside” on page 8-24

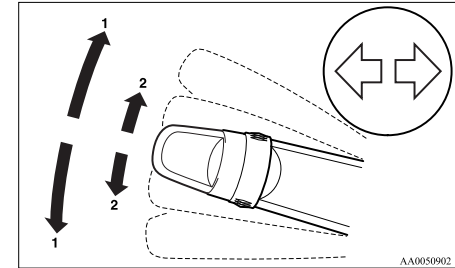

1- Turn-signals

When making a normal turn, use position (1). The lever will return automatically when cornering is completed.

There are times when the lever will not return after cornering. This occurs when the steering wheel is turned only slightly.

In such cases, return the lever by hand.

2- Lane-change signals

When changing lanes, use position (2). It will return to the neutral position when released.

NOTE

● If the lamp flashes unusually quickly, the bulb in a turn-signal lamp may have burned out. We recommend you to have the vehicle inspected.

Instruments and controls

- It is possible to activate the following functions. For further information, we recommend you to consult a MITSUBISHI MOTORS Authorized Service Point.

- Flashing of the turn-signal lamps and the indication lamp in the instrument cluster when the lever is operated with the ignition switch in the “ACC” position
- Flashing of the turn-signal lamps and the indication lamp in the instrument cluster three times when you move the lever to (2) slightly then release it
- The time required to operate the lever for the 3-flash function can be adjusted.

Hazard warning flasher switch

E00506600903

Use the hazard warning flasher switch when the vehicle has to be parked on the road for any emergency. The hazard warning flashers can always be operated, regardless of the position of the ignition key.

Push the switch to turn on the hazard warning flashers; push the switch again to turn them off.

When this switch is operated, all turn-signal lamps flash continuously, as do the turn-signal indication lamps in the instrument cluster.

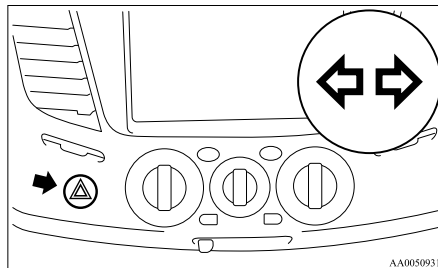

NOTE

- If the lamps are kept flashing for a long time, the battery will be discharged, resulting in hard engine starting or no start condition.
 - If the lamp flashes unusually quickly, the bulb in a turn-signal lamp may have burned out.
- We recommend you to have the vehicle inspected.

Front fog lamp switch*

E00506800934

The front fog lamps can be used only when the headlamps or tail lamps are on. Turn the knob once in the “ON” direction to turn on the front fog lamps. The indication lamp in the instrument cluster will also come on. To turn the front fog lamps off, turn the knob once in the “OFF” direction. While the rear fog lamp is on, turn the knob twice in the “OFF” direction to turn the front fog lamps off. The knob will automatically return to its original position when you release it.

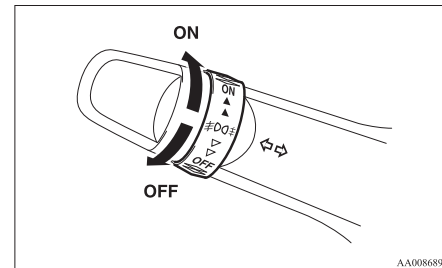

NOTE

- The front fog lamps are automatically turned off when the headlamps or tail lamps are turned off. To turn the front fog lamps on again, turn the knob in the “ON” direction after turning on the headlamps or tail lamps.
- Do not use fog lamps except in conditions of fog, otherwise excessive lamp glare may temporarily blind oncoming vehicle drivers.

- In case of vehicles with Daytime Running Lamp, the front fog lamp can be operated even if the lamp switch is set to the “OFF” position, because the low beam of the headlamps, tail lamps, etc. illuminate when the ignition key is at the “ON” position.

Rear fog lamp switch

E00506900313

The rear fog lamp illuminates only when the headlamps or front fog lamps (if so equipped) are on. An indication lamp in the instrument cluster comes on when the rear fog lamp is turned on.

[Vehicles without front fog lamps]

Turn the knob once in the “ON” direction to turn on the rear fog lamp. To turn the rear fog lamp off, turn the knob once in the “OFF” direction. The knob will automatically return to its original position when you release it.

[Vehicles with front fog lamps]

Turn the knob once in the “ON” direction to turn on the front fog lamps. Turn the knob once more in the “ON” direction to turn on the rear fog lamp. To turn the rear fog lamp off, turn the knob once in the “OFF” direction. Turn the knob once more in the “OFF” direction to turn off the front fog lamps. The knob will automatically return to its original position when you release it.

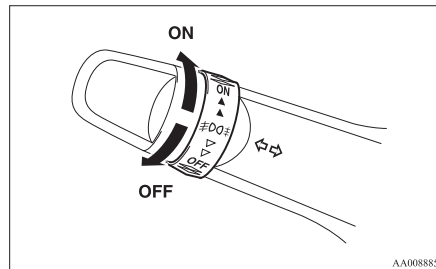

NOTE

- The rear fog lamp is automatically turned off when the headlamps and front fog lamps (if so equipped) turned off.
- To turn the rear fog lamp on again, turn the knob once in the “ON” direction after turning on the headlamps. (Vehicles without front fog lamps)
- To turn the rear fog lamp on again, turn the knob twice in the “ON” direction after turning on the headlamps. (Vehicles with front fog lamps)
- In case of vehicles with Daytime Running Lamp, the rear fog lamp can be operated even if the lamp switch is set to the “OFF” position, because the low beam of the headlamps, tail lamps, etc. illuminate when the ignition key is at the “ON” position.

Wiper and washer switch

E00507101191

CAUTION

- If the washer is used in cold weather, the washer fluid sprayed against the glass may freeze, which may hinder visibility. Warm the glass with the defroster or rear window demister before using the washer.

Windscreen wipers

E00516900303

Except for vehicles equipped with rain sensor

The windscreen wipers can be operated with the ignition switch in the “ON” or “ACC” position. If the blades are frozen to the windscreen, do not operate the wipers until the ice has melted and the blades are freed, otherwise the wiper motor may be damaged.

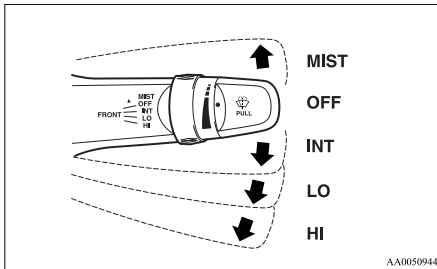

AA0050944

MIST- Misting function
The wipers will operate once.

- OFF- Off
- INT- Speed sensitive intermittent operation
Interval between wipers varies in accordance with vehicle speed.
- LO- Slow
- HI- Fast

To adjust intermittent intervals

With the lever in the “INT” (speed-sensitive) position, the intermittent intervals can be adjusted by turning the knob (A).

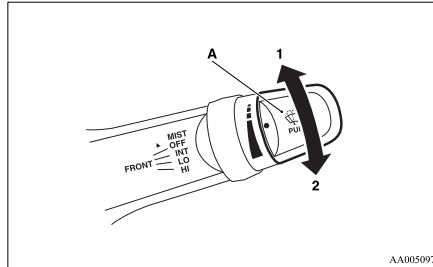

AA0050973

- 1- Fast
- 2- Slow

NOTE

- The speed-sensitive-operation function of the windscreen wipers can be deactivated. For further information, we recommend you to consult a MITSUBISHI MOTORS Authorized Service Point.

Misting function

Move the lever in the direction of the arrow and release, to operate the wipers once.

Use this function when you are driving in mist or drizzle. If the lever is held in the upward position (MIST), the wipers continue operating until the lever is released.

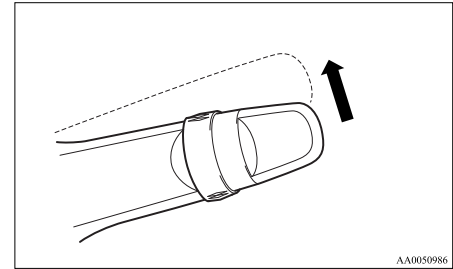

AA0050986

Vehicles with rain sensor

E00526400369

The windscreen wipers can be operated with the ignition switch in the “ON” or “ACC” position. If the blades are frozen to the windscreen, do not operate the wipers until the ice has melted and the blades are freed, otherwise the wiper motor may be damaged.

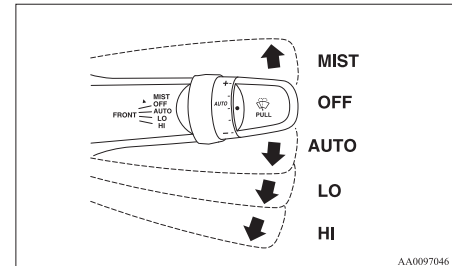

AA0097046

- MIST- Misting function
The wipers will operate once.
- OFF- Off
- AUTO- Auto-wiper control
Rain sensor
The wipers will automatically operate depending on the degree of wetness on the windscreen.
- LO- Slow
- HI- Fast

Rain sensor

Can only be used when the ignition switch is in the “ON” position.

If the lever is put in the “AUTO” position, the rain sensor (A) will detect the extent of rain (or snow, other moisture, dust, etc.) and the wipers will operate automatically.

Keep the lever in the “OFF” position if the windscreen is dirty and the weather is dry.

Wiper operation under these conditions can scratch the windscreen and damage the wipers.

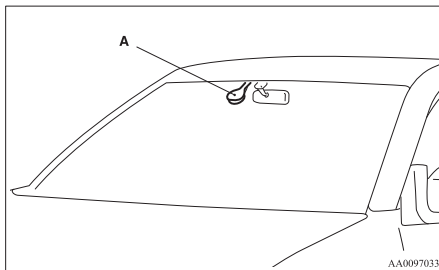

CAUTION

- With the ignition switch in the “ON” position and the lever in the “AUTO” position, the wipers may automatically operate in the situations described below. If your hands get trapped, you could suffer injuries or the wipers could malfunction. Be sure to turn the ignition switch to the “OFF” position or move the lever to the “OFF” position to deactivate the rain sensor.
 - When cleaning the outside surface of the windscreen, if you touch the rain sensor.
 - When cleaning the outside surface of the windscreen, if you wipe with a cloth the rain sensor.
 - When using an automatic car wash.
 - A physical shock is applied to the windscreen.
 - A physical shock is applied to the rain sensor.

NOTE

- To protect the rubber parts of the wipers, this operation of the wipers does not take place when the vehicle is stationary and the ambient temperature is about 0 °C or lower.
- Do not cover the sensor by affixing a sticker or label to the windscreen. Also, do not put any water-repellent coating on the windscreen. The rain sensor would not be able to detect the extent of rain, and the wipers might stop working normally.
- In the following cases, the rain sensor may be malfunctioning.

Have the vehicle inspected at a MITSUBISHI MOTORS Authorized Service Point.

- When the wipers operate at a constant interval despite changes in the extent of rain.
- When the wipers do not operate even though it is raining.
- The wipers may automatically operate when things such as insects or foreign objects are affixed to the windscreen on top of the rain sensor or when the windscreen is frozen. Objects affixed to the windscreen will stop the wipers when the wipers cannot remove them. To make the wipers operate again, place the lever in the “LO” or “HI” position. Also, the wipers may operate automatically due to strong direct sunlight or electromagnetic wave. To stop the wipers, place the lever in the “OFF” position.
- Contact a MITSUBISHI MOTORS Authorized Service Point when replacing the windscreen or reinforcing the glass around the sensor.

Instruments and controls

To adjust the sensitivity of the rain sensor

With the lever in the “AUTO” (rain sensor) position, it is possible to adjust the sensitivity of the rain sensor by turning the knob (A).

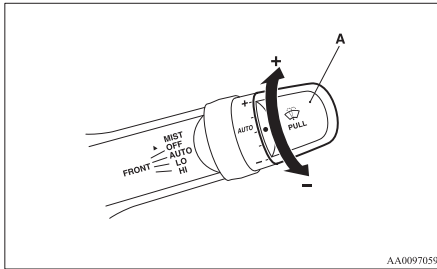

"+"- Higher sensitivity to rain

"-"- Lower sensitivity to rain

NOTE

- It is possible to activate the following functions. For further information, we recommend you to consult a MITSUBISHI MOTORS Authorized Service Point.
 - Automatic operation (rain droplet sensitive) can be changed to intermittent operation (vehicle-speed sensitive).
 - Automatic operation (rain droplet sensitive) can be changed to intermittent operation (except vehicle-speed sensitive).

Misting function

Move the lever in the direction of the arrow and release, to operate the wipers once.

Use this function when you are driving in mist or drizzle.

If the lever is held in the upward position (MIST), the wipers continue operating until the lever is released.

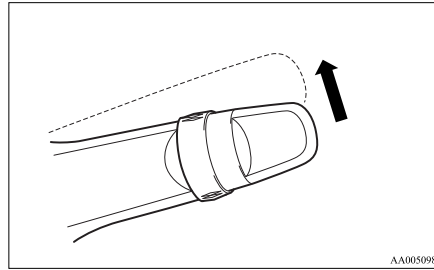

The wipers will operate once if the lever is moved to the “AUTO” position and the knob (A) is turned in the “+” direction when the ignition switch is “ON” position.

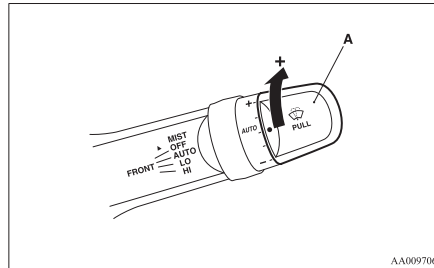

Windscreen washer

E00507200805

The windscreen washer can be operated with the ignition switch in the “ON” or “ACC” position.

The washer fluid will be sprayed onto the windscreen by pulling the lever towards you. The wipers operate automatically several times while the washer fluid is being sprayed.

On a vehicle equipped with a headlamp washer, the headlamp washer operates together with the windscreen washer the first time the windscreen washer is used if the headlamps are on.

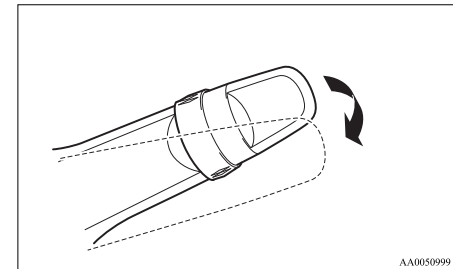

⚠ CAUTION

- If the washer is used in cold weather, the washer fluid sprayed against the glass may freeze resulting in poor visibility. Heat the glass with the defroster or demister before using the washer.

NOTE

- It is possible to spray washer fluid without activating the wipers. To do so, hold the lever in the pulled position and turn the ignition switch to the “ON” or “ACC” position.

- It is possible to cause the wipers never to operate when washer fluid is sprayed. For further information, we recommend you to consult a MITSUBISHI MOTORS Authorized Service Point.

Headlamp washer switch*

E00510100273

The headlamp washer can be operated when the ignition switch is in the “ON” or “ACC” position and the headlamps are on.

Push the button once and the washer fluid will be sprayed on to the headlamps.

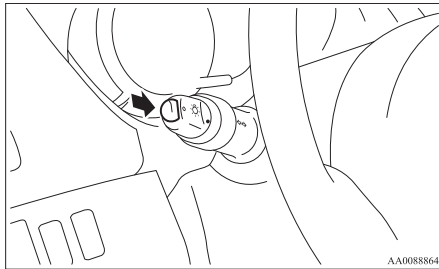

NOTE

- If the ignition switch is in the “ON” or “ACC” position and the headlamps are on, the headlamp washer operates together with the windscreen washer the first time the windscreen washer lever is pulled.

Precautions to observe when using wipers and washers

E00507600014

- If the moving wipers become blocked by ice or other deposits on the glass, the motor may burn out even if the wiper switch is turned to OFF. If obstruction occurs, park your vehicle in a safe place, turn off the ignition, and clean the deposits from the glass so that the wipers operate smoothly.
- Do not use the wipers when the glass is dry. They may scratch the glass surface and the blades wear out prematurely.
- Before using the wipers in cold weather, check that the wiper blades are not frozen onto the glass. The motor may burn out if the wipers are used with the blades frozen onto the glass.
- Avoid using the washer continuously for more than 20 seconds. Do not operate the washer when the fluid reservoir is empty. Otherwise, the motor may burn out.
- Periodically check the level of washer fluid in the reservoir and refill if required. During cold weather, add a recommended washer solution that will not freeze in the washer reservoir. Failure to do so could result in loss of washer function and frost damage to the system components.

Rear window demister switch

E00507900961

The rear window demister switch can be operated with the ignition switch in the “ON” position.

Push the switch to turn on the rear window demister. It will be turned off automatically in about 20 minutes. To turn off the demister within about 20 minutes, push the switch again.

The indication lamp (A) will illuminate while the demister is on.

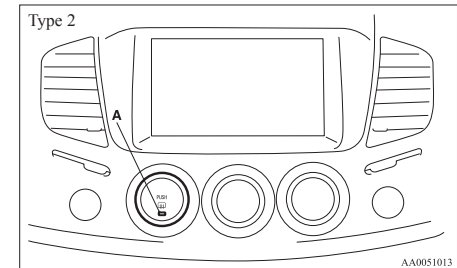
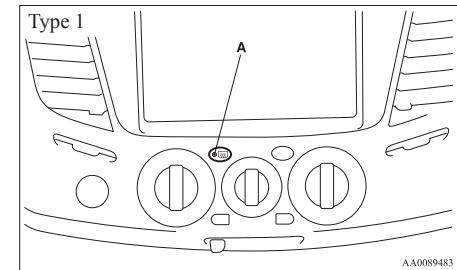

Instruments and controls

NOTE

- If your vehicle is equipped with heated mirrors, these operate in conjunction with the demister. Refer to “Heated mirror” on page 4-10.
- The demister switch is not to melt snow but to clear mist. Remove snow before use of the demister switch.
- To avoid unnecessary discharge of the battery, do not use the rear window demister during starting of the engine or when the engine is not running. Turn the demister off immediately after the window is clear.
- When cleaning the inside of the rear window, use a soft cloth and wipe gently along the heater wires, being careful not to damage the wires.
- Do not allow objects to touch the inside of the rear window glass, or damaged or broken wires may result.

Horn switch

E0050800608

Press the steering wheel on or around the “” mark.

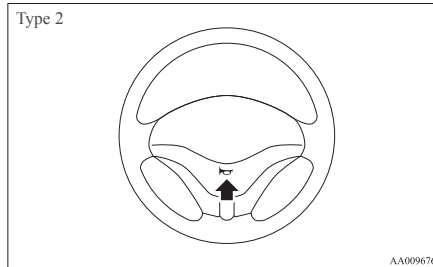
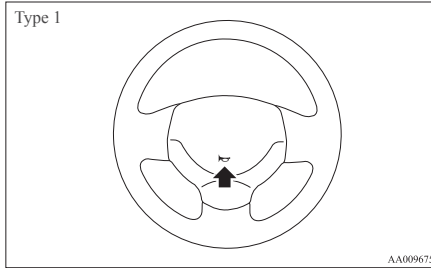

Starting and driving

Economical driving.....	4-02
Driving, alcohol and drugs.....	4-02
Safe driving techniques.....	4-03
Running-in recommendations.....	4-04
Parking brake.....	4-06
Parking.....	4-07
Steering wheel height adjustment.....	4-08
Inside rear-view mirror.....	4-08
Outside rear-view mirrors.....	4-09
Ignition switch.....	4-10
Steering wheel lock.....	4-12
Starting.....	4-12
Diesel particulate filter (DPF)*.....	4-13
Manual transmission.....	4-14
Automatic transmission Sports Mode 4A/T, 5A/T.....	4-17
Easy select 4WD*.....	4-22
Super select 4WD*.....	4-26
Rear differential lock*.....	4-30
4-wheel drive operation.....	4-34
Inspection and maintenance following rough road operation.....	4-36
Cautions on handling of 4-wheel drive vehicles.....	4-36
Limited-slip differential*.....	4-38
Braking.....	4-38
Brake assist system*.....	4-39
Anti-lock brake system (ABS)*.....	4-39
Power steering system.....	4-42
Active Stability & Traction Control (ASTC)*.....	4-42
Cruise control*.....	4-45
Cargo loads.....	4-49

Trailer towing.....	4-49
---------------------	------

Starting and driving

Economical driving

E00600100620

For economical driving, there are some technical requirements that have to be met. The prerequisite for low fuel consumption is a properly adjusted engine. In order to achieve longer life of the vehicle and the most economical operation, we recommend you to have the vehicle checked at regular intervals in accordance with the service standards.

Fuel economy and generation of exhaust gas and noise are highly influenced by personal driving habits as well as the particular operating conditions. The following points should be observed in order to minimize wear of brakes, tyres and engine as well as to reduce environmental pollution.

Starting

Avoid rapid acceleration and sudden starts; such operation will result in higher fuel consumption.

Shifting

Shift only at an appropriate speed and engine speed. Always use the highest gear possible. The transfer shift lever should be set to "2H" when driving 4WD vehicles on normal roads and express ways to obtain best possible fuel economy.

City traffic

Frequent starting and stopping increases the average fuel consumption. Use roads with smooth traffic flow whenever possible. When driving on congested roads, avoid use of a low gear at high engine speeds.

Idling

The vehicle consumes fuel even during idling. Avoid extended idling whenever possible.

Speed

The higher the vehicle speed, the more fuel consumed. Avoid driving at full speed. Even a slight release of the accelerator pedal will save a significant amount of fuel.

Tyre inflation pressure

Check the tyre inflation pressures at regular intervals. Low tyre inflation pressure increases road resistance and fuel consumption. In addition, low tyre pressures adversely affect tyre wear and driving stability.

Load

Do not drive with unnecessary articles in the cargo area. Especially during city driving where frequent starting and stopping is necessary, the increased weight of the vehicle will greatly affect fuel consumption.

Cold engine starting

Starting of a cold engine consumes more fuel. Unnecessary fuel consumption is also caused by keeping a hot engine running. After the engine is started, commence driving as soon as possible.

Air conditioning*

The use of the air conditioning will increase the fuel consumption.

Driving, alcohol and drugs

E00600200012

Driving after drinking alcohol is one of the most frequent causes of accidents.

Your driving ability can be seriously impaired even with blood alcohol levels far below the legal minimum. If you have been drinking, don't drive. Ride with a designated non-drinking driver, call a cab or a friend, or use public transportation.

Drinking coffee or taking a cold shower will not make you sober.

Similarly, prescription and nonprescription drugs affect your alertness, perception and reaction time. Consult with your doctor or pharmacist before driving while under the influence of any of these medications.

WARNING

● **NEVER DRINK AND DRIVE.**

Your perceptions are less accurate, your reflexes are slower and your judgment is impaired.

Safe driving techniques

E00600300491

Driving safety and protection against injury cannot be fully ensured. However, we recommend that you pay extra attention to the following:

Seat belts

Before starting the vehicle, make sure that you and your passengers have fastened your seat belts.

Floor mats

⚠ WARNING

- Keep floor mats clear of the pedals by correctly laying floor mats that are suitable for the vehicle.

To prevent the floor mats from slipping out position, securely retain them using the hooks etc.

Note that laying a floor mat over a pedal or laying one floor mat on top of another can obstruct pedal operation and lead to a serious accident.

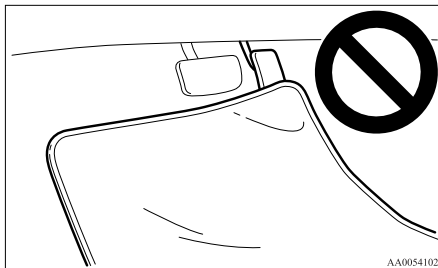

AA0054102

Carrying children in the vehicle

- Never leave your vehicle unattended with the key in the ignition and children inside the vehicle. Children may play with the driving controls and this could lead to an accident.
- Make sure that infants and small children are properly restrained in accordance with the laws and regulations, and for maximum protection in case of an accident.
- Prevent children from playing in the cargo area. It is quite dangerous to allow them to play there while the vehicle is moving.

Running-in recommendations

E00600402500

During the running-in period for the first 1,000 km (620 miles), it is advisable to drive your new vehicle using the following precautions as a guideline to aid long life as well as future economy and performance.

- Do not race the engine at high speeds.
- Avoid rapid starting, accelerating, braking and prolonged high-speed running.
- Keep to the running-in speed limit shown below.
Please note that the legal speed limits displayed must be adhered to.
- Do not exceed loading limits.
- Refrain from towing a trailer.

Vehicles with manual transmission

Shift point	Speed limit				
	2WD	Vehicles with easy select 4WD		Vehicles with super select 4WD	
		2H, 4H	4L	2H, 4H, 4HLc	4LLc
1 st gear	20 km/h (12 mph)	20 km/h (12 mph)	10 km/h (6 mph)	20 km/h (12 mph)	10 km/h (6 mph)
2 nd gear	40 km/h (25 mph)	40 km/h (25 mph)	20 km/h (12 mph)	40 km/h (25 mph)	20 km/h (12 mph)
3 rd gear	65 km/h (40 mph)	70 km/h (43 mph)	35 km/h (22 mph)	70 km/h (43 mph)	35 km/h (22 mph)
4 th gear	95 km/h (59 mph)	100 km/h (62 mph)	55 km/h (34 mph)	100 km/h (62 mph)	50 km/h (30 mph)
5 th gear	120 km/h (74 mph)	130 km/h (81 mph)	65 km/h (40 mph)	130 km/h (81 mph)	65 km/h (40 mph)

Vehicles with automatic transmission

Vehicles with 4A/T

Shift point	Speed limit				
	2WD	Vehicles with easy select 4WD		Vehicles with super select 4WD	
		2H, 4H	4L	2H, 4H, 4HLc	4LLc
1 st gear	25 km/h (16 mph)	25 km/h (16 mph)	15 km/h (9 mph)	25 km/h (16 mph)	15 km/h (9 mph)
2 nd gear	65 km/h (40 mph)	65 km/h (40 mph)	35 km/h (22 mph)	65 km/h (40 mph)	35 km/h (22 mph)
3 rd gear	100 km/h (62 mph)	100 km/h (62 mph)	50 km/h (30 mph)	100 km/h (62 mph)	50 km/h (30 mph)

Shift point	Speed limit				
	2WD	Vehicles with easy select 4WD		Vehicles with super select 4WD	
		2H, 4H	4L	2H, 4H, 4HLc	4LLc
4 th gear	140 km/h (87 mph)	140 km/h (87 mph)	—	135 km/h (84 mph)	—

Vehicles with 5A/T

Shift point	Speed limit	
	2H, 4H, 4HLc	4LLc
1 st gear	25 km/h (16 mph)	10 km/h (6 mph)
2 nd gear	45 km/h (28 mph)	25 km/h (16 mph)
3 rd gear	70 km/h (43 mph)	35 km/h (22 mph)
4 th gear	100 km/h (62 mph)	50 km/h (30 mph)
5 th gear	135 km/h (84 mph)	—

NOTE

- On 4WD vehicles with automatic transmission, when the transfer shift lever is in “4LLc”, the transmission will not shift into the overdrive gear.

 **CAUTION**

- On 4WD vehicles, the “4LLc” range gives maximum torque for low-speed driving on steep slopes, as well as sandy, muddy, and other difficult surfaces. On vehicles with A/T, do not exceed speeds of approximately 70 km/h (43 mph) in “4LLc” range.

Parking brake

E00600501562

To park the vehicle, first bring it to a complete stop, fully engage the parking brake, and then move the gearshift lever to 1st (on an uphill) or Reverse (on a downhill) position for vehicles with manual transmission or set the selector lever to “P” (PARK) position on automatic transmission vehicles.

CAUTION

- Before driving, be sure that the parking brake is fully released and brake warning lamp is off.
If a vehicle is driven without releasing the parking brake, the brake will be overheated, resulting in ineffective braking and possible brake failure.
- When you intend to apply the parking brake, firmly press the brake pedal to bring the vehicle to a complete stop before pulling the parking brake lever. Pulling the parking brake lever with the vehicle moving could make the rear wheels lock up, thereby making the vehicle unstable. It could also make the parking brake malfunction.
- If the brake warning lamp does not extinguish when the parking brake is fully released, the brake system may be abnormal. Have your vehicle checked immediately. For details, refer to “Brake warning lamp” on page 3-08.

Type 1

To apply

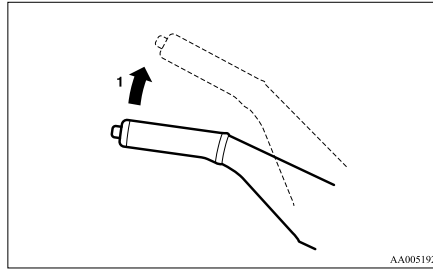

- 1- Firmly depress and hold the brake pedal, then pull the lever up without pushing the button at the end of hand grip.

To release

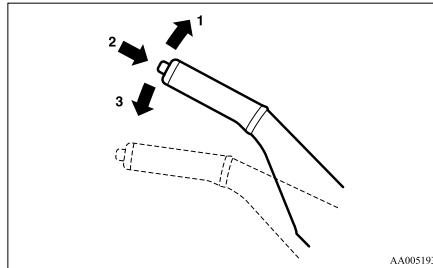

- 1- Firmly depress and hold the brake pedal, then pull the lever up slightly.
- 2- Push the button at the end of hand grip.
- 3- Lower the lever fully.

Type 2

To apply

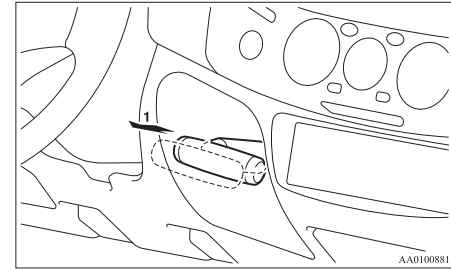

- 1- Firmly depress and hold the brake pedal, then pull the lever out.

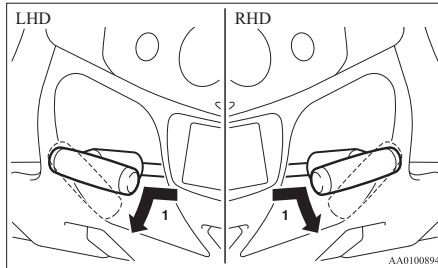
To release

1- Firmly depress and hold the brake pedal, then pull the lever out slightly and turn it clockwise (LHD) or anticlockwise (RHD).

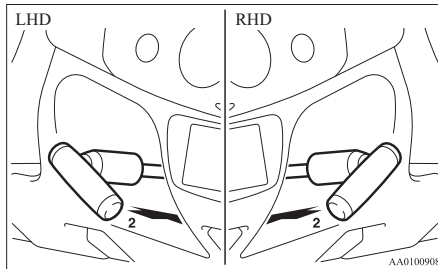

2- Push in the lever completely.

Parking

E00600601202

Parking on a hill

To prevent the vehicle from rolling, follow these procedures:

Parking on a downhill slope

Turn the front wheels towards the kerb and move the vehicle forward until the kerb side wheel gently touches the kerb.

Set the parking brake and place the gearshift lever into the “R” (Reverse) position (with M/T) or the selector lever into the “P” (PARK) position (with A/T).

If necessary, apply chocks to wheels.

Parking on an uphill slope

Turn the front wheels away from the kerb and move the vehicle back until the kerb side wheel gently touches the kerb.

Set the parking brake and place the gearshift lever into the 1st position (with M/T) or the selector lever into the “P” (PARK) position (with A/T).

If necessary, apply chocks to wheels.

NOTE

- If your vehicle is equipped with A/T, be sure to apply the parking brake before moving the selector lever to the “P” (PARK) position. If you move the selector lever to the “P” (PARK) position before applying the parking brake, it may be difficult to disengage the selector lever from the “P” (PARK) position when next you drive the vehicle, requiring application of a strong force to the selector lever to move from the “P” (PARK) position.

Parking with the engine running

Never leave the engine running while you take a short sleep/rest. Also, never leave the engine running in a closed or poorly ventilated place.

⚠ WARNING

- Leaving the engine running risks injury or death from accidentally moving the gearshift lever (on M/T vehicles) or the selector lever (on A/T vehicles) or the accumulation of toxic exhaust fumes in the passenger compartment.

Where you park

Your front bumper can be damaged if you scrape it over kerbs or parking stop blocks. Be careful when travelling up or down steep slopes where your bumper can scrape the road.

⚠ WARNING

- Do not park your vehicle in areas where combustible materials such as dry grass or leaves can come in contact with a hot exhaust, since a fire could occur.

When leaving the vehicle

Always remove the key from the ignition switch and lock all doors when leaving the vehicle unattended.

Always try to park your vehicle in a well lit area.

Starting and driving

Steering wheel height adjustment

E00600700219

To adjust the steering wheel height, release the tilt lock lever while holding the steering wheel by hand, and raise or lower the steering wheel to the desired height.

After adjustment, securely lock the lever by pulling it upward.

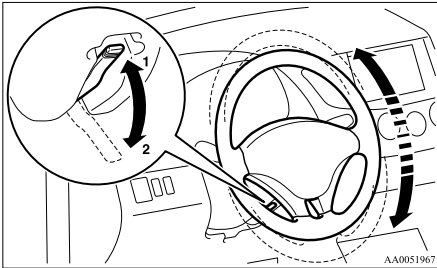

- 1- Locked
2- Release

⚠ WARNING

- After adjusting to the desired height, check to be sure that the lever is locked.
- Do not attempt to adjust the steering wheel while you are driving the vehicle.
- When releasing the tilt lock lever, move it to the release position (2) and hold the steering wheel by hand to prevent it falling to the lowest position.

Inside rear-view mirror

E00600800106

Adjust the rear-view mirror only after making any seat adjustments so you have a clear view to the rear of the vehicle.

⚠ WARNING

- Do not attempt to adjust the rear-view mirror while driving. This can be dangerous. Always adjust the mirror before driving.

Adjust the rear-view mirror to maximize the view through the rear window.

To adjust the vertical mirror position

It is possible to move the mirror up and down to adjust its position.

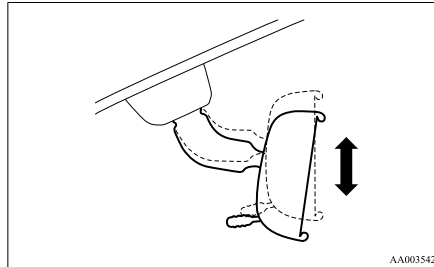

AA0035422

To reduce the glare

The lever (A) at the bottom of the mirror can be used to adjust the mirror to reduce the glare from the headlamps of vehicles behind you during night driving.

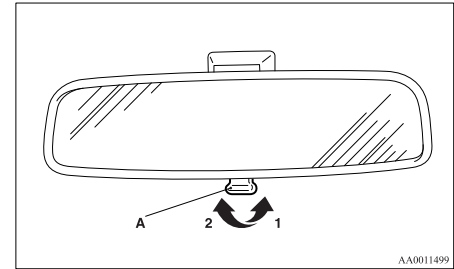

AA0011499

- 1- Normal
2- Anti-glare

Outside rear-view mirrors

E00600900149

To adjust the mirror position

E00601000482

⚠ WARNING

- Do not attempt to adjust the rear-view mirrors while driving. This can be dangerous. Always adjust the mirrors before driving.
- Your vehicle is equipped with convex type mirrors. Please take into consideration, that objects you see in the mirror will look smaller and farther away compared to a normal flat mirror. Do not use this mirror to estimate distance of following vehicles when changing lanes.

Manual outside rear-view mirrors*

Adjust the mirror surface by hands as indicated by the arrows.

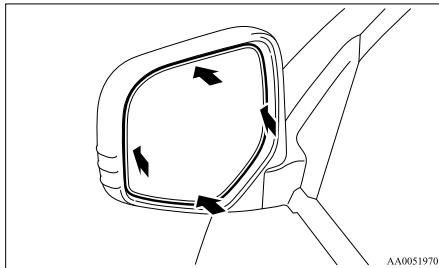

Electric remote-controlled outside rear-view mirrors*

The electric remote-controlled outside rear-view mirrors can be operated when the ignition switch is in the "ON" or "ACC" position.

Push the switch (A) on the same side as the mirror whose adjustment is desired.

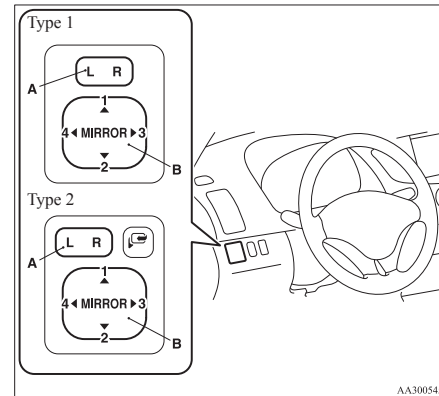

- L- Left outside mirror adjustment
- R- Right outside mirror adjustment

NOTE

- After adjustment, lightly push the switch on the opposite side to return it to the neutral position.

Press the switch (B) to the left, right, up or down to adjust the mirror position.

- 1- Up
- 2- Down
- 3- Right
- 4- Left

To fold the mirror

E00601100467

The outside mirror can be folded in towards the side window to prevent damage when parking in narrow areas.

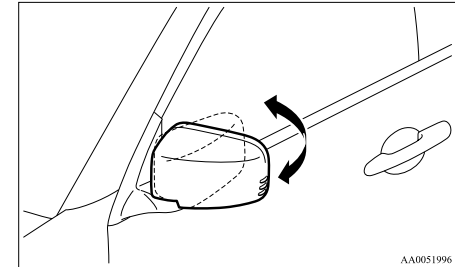

Mirror retractor switch*

The mirror retractor switch can be operated with the ignition switch in the "ON" or "ACC" position.

Starting and driving

Push the switch to fold the mirrors inward, and push the switch again to return them to extended position.

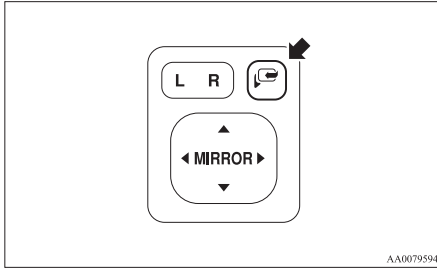

NOTE

- It is also possible to fold and return the mirrors by hand.
- When freezing has occurred and mirrors fail to operate as intended, please refrain from repeated pushing of the retractor switch as this action can result in burn-out of the mirror motor circuits.

Heated mirror*

E00601200253

When the rear window demister switch (C) is pressed, the outside rear-view mirrors are demisted or defrosted. Current will flow through the heater element inside the mirrors, thus clearing away frost or condensation.

The indication lamp (D) will illuminate while the demister is on. The heater will be turned off automatically in about 20 minutes.

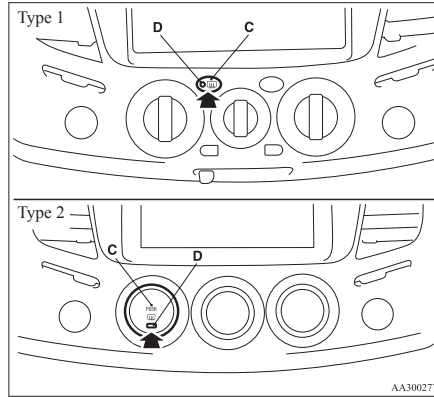

Ignition switch

E00601402044

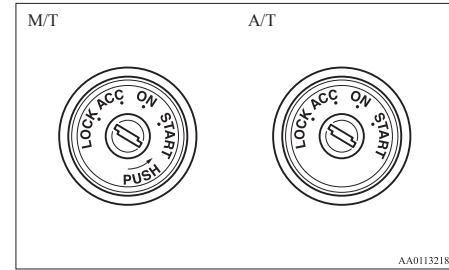

LOCK

The engine is stopped and the steering wheel locked. The key can only be inserted and removed when the switch is in this position.

ACC

The engine is stopped, but the electrical devices such as the radio and cigarette lighter can be operated.

ON

The engine is running, and all the vehicle's electrical devices can be operated.

START

The starter motor operates. After the engine has started, release the key and it will automatically return to the "ON" position.

NOTE

- If your vehicle is equipped with the Daytime Running Lamp, when the ignition switch is in the “ON”, the headlamp low beams etc. are turned on.
Refer to “Headlamps” on page 3-30.
- Your vehicle is equipped with an electronic immobilizer.
To start the engine, the ID code which the transponder inside the key sends must match the one registered in the immobilizer computer.
Refer to “Electronic immobilizer” on page 1-03.

To remove the key

For vehicles with a M/T, when removing the key, push the key in at the “ACC” position and keep it depressed until it is turned to the “LOCK” position, and remove it.

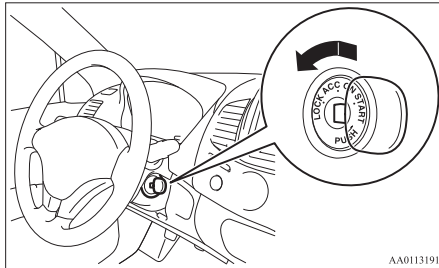

For vehicles with an A/T, when removing the key, first set the selector lever to the “P” (PARK) position, and then turn the key to the “LOCK” position, and remove it.

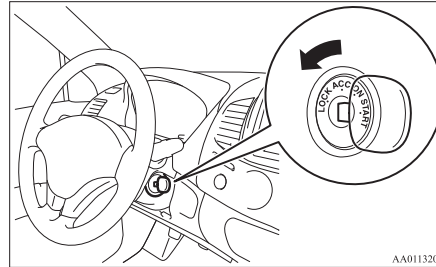

NOTE

- For vehicles with an A/T, when the selector lever is in the “P” (PARK) position, do not operate the lock button of selector lever repeatedly for more than 30 seconds. You may not be able to remove the key from the ignition switch, because the protection circuit is activated. If this occurs, wait a few moments before removing the key.
Refer to “Selector lever operation” on page 4-17.

CAUTION

- Do not remove the ignition key from the ignition switch while driving. The steering wheel will lock, causing loss of control.
- If the engine is stopped while driving, the brake servomechanism will cease to function and braking efficiency will deteriorate. Also, the power steering system will not function and it will require greater manual effort to operate the steering.
- Do not leave the key in the “ON” position for a long time when the engine is not running, doing so will cause the battery to be discharged.
- Do not turn the key to the “START” position when the engine is running, doing so could damage the starter motor.

Steering wheel lock

E00601500227

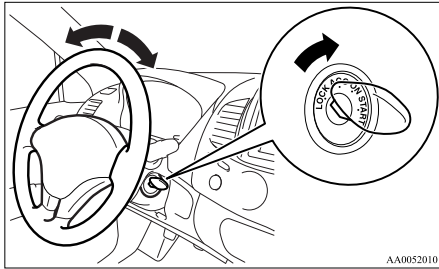

AA0052010

To lock

Remove the key at the “LOCK” position. Turn the steering wheel until it is locked.

To unlock

Turn the key to the “ACC” position while moving the steering wheel slightly.

CAUTION

- Remove the key when leaving the vehicle.

NOTE

- If the front wheels are turned, the anti-theft lock may sometimes make it difficult to turn the key from “LOCK” to “ACC”. Firmly turn the steering wheel to the left or to the right as you turn the key.

Starting

E00601600404

Tips for starting

- Do not operate the starter motor continuously for anything longer than 10 seconds; doing so could run down the battery. If the engine does not start, turn the ignition switch back to “LOCK” position, wait a few seconds, and then try again.
Trying repeatedly with the starter motor still turning will damage the starter mechanism.
- If the engine cannot be started because the battery is weak or dead, refer to the “Emergency starting” section for instructions on starting the engine.
- The engine is well warmed up if the coolant temperature gauge needle starts to move (the engine speed decreases). Extended warming-up operation will result in excessive fuel consumption.

WARNING

- Never run the engine in a closed or poorly ventilated area any longer than is needed to move your vehicle in or out of the area. Carbon monoxide gases are odourless and can be fatal.

CAUTION

- Never attempt to start the engine by pushing or pulling the vehicle. Especially the automatic transmission, since the structure is different from a manual transmission, it is not possible to start the engine by using this technique. Never attempt this or it could damage the automatic transmission.
- Do not run the engine at high rpm or drive the vehicle at high speed until the engine has had a chance to warm up.
- Release the ignition key as soon as the engine starts to avoid damaging the starter motor.
- Do not stop the engine immediately after high-speed or uphill driving. First allow the engine to idle to give the turbocharger a chance to cool down.

Starting the engine

E00601702223

1. Insert the ignition key and fasten the seat belt.
2. Make sure the parking brake is applied.
3. Depress and hold the brake pedal.
4. On vehicles with manual transmission, place the gearshift lever in the “N” (Neutral) position and depress the clutch pedal all the way.

On vehicles with automatic transmission, make sure the selector lever is in the “P” (PARK) position.

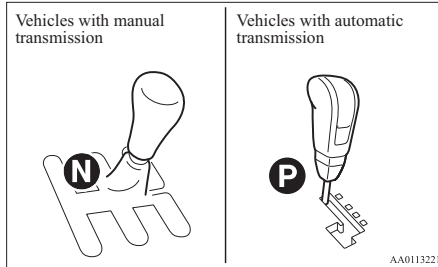

NOTE

- On vehicles with automatic transmission, the engine will not start if the selector lever is in any position other than “P” (PARK) or “N” (NEUTRAL) position. For safety, start the engine with the selector lever in the “P” (PARK) position because in this position the rear wheels are locked in place.
5. Turn the ignition key to the “ON” position. The diesel preheat indication lamp will first illuminate, and then after a short time go out, indicating that preheating is completed.

NOTE

- If the engine is cold, the diesel preheat indication lamp is on for a longer time.

- When the engine has not been started within about 5 seconds after the diesel preheat indication lamp went out, return the ignition key to the “LOCK” position. Then, turn the key to the “ON” position to preheat the engine again.
- When the engine is warm, the diesel preheat indication lamp does not come on even if the ignition key is placed in the “ON” position. Start the engine by turning the ignition key right to the “START” position.

6. Operate the accelerator pedal as described below in accordance with the atmospheric temperature and/or engine condition and then start the engine.

- When the atmospheric temperature is moderate or the engine is warm, start the engine without depressing the accelerator pedal.
- When the atmospheric temperature is low and the engine is cold, start the engine while depressing the accelerator pedal.

Fuel injection amount learning process

E0061600028

To keep exhaust emissions and engine noise low, the engine very occasionally performs a learning process for the fuel injection amount.

The engine sounds slightly different from usual while the learning process is taking place. The change in the engine sound does not indicate a fault.

Diesel particulate filter (DPF)*

E00619800232

The diesel particulate filter (DPF) is a device that captures most of the particulate matter (PM) in the exhaust emissions of the diesel engine. The DPF automatically burns away trapped PM during vehicle operation. Under certain driving conditions, however, the DPF is not able to burn away all of the trapped PM and, as a result, an excessive amount of PM accumulates inside it.

⚠ WARNING

- The DPF reaches very high temperatures. Do not park your vehicle in areas where combustible materials such as dry grass or leaves can come in contact with a hot exhaust system since a fire could occur.

⚠ CAUTION

- Do not use any type of fuel or engine oil that is not specified for your vehicle. Also, do not use any moisture-removing agent or other fuel additive. Such substances could have a detrimental effect on the DPF. Refer to “Fuel selection” on page 02 and “Engine oil” on page 8-04.

NOTE

- To minimize the likelihood of excessive accumulation of PM, try to avoid driving for long periods at low speeds and repeatedly driving short distances.

Starting and driving

DPF warning lamp

The DPF warning lamp comes on or flashes in the event of an abnormality in the DPF system. Provided the DPF system is working normally, the DPF warning lamp comes on when the ignition switch is turned to the “ON” position and goes off a few seconds later.

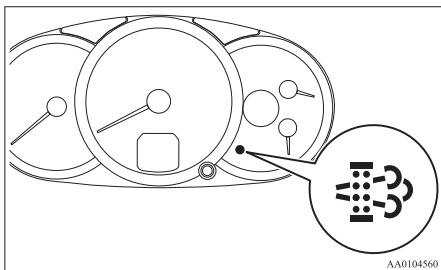

4

If the DPF warning lamp comes on during vehicle operation

Steady illumination of the DPF warning lamp shows that the DPF has not been able to burn away all of the trapped PM and that, as a result, an excessive amount of PM has accumulated inside it. To enable the DPF to burn away the PM, try to drive the vehicle as follows:

- With the needle of the water temperature gauge stabilized in roughly the middle of the scale, drive for about 20 minutes at a speed of at least 40 km/h (24 mph).

If the DPF warning lamp subsequently stays on, contact your MITSUBISHI MOTORS Authorized Service Point.

CAUTION

- You do not have to continuously drive exactly as indicated above. Always strive to drive safely in accordance with road conditions.

If the DPF warning lamp flashes during vehicle operation

Flashing of the DPF warning lamp indicates an abnormality in the DPF system. Have the system inspected at a MITSUBISHI MOTORS Authorized Service Point.

CAUTION

- Continuing to drive with the DPF warning lamp flashing could result in engine trouble and DPF damage.

Manual transmission

E00602000199

The shift pattern is shown on the gearshift lever knob. Be sure to always fully depress the clutch pedal before attempting to shift the lever.

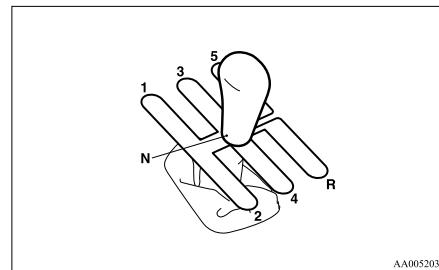

AA0052036

CAUTION

- Do not move the gearshift lever into reverse while the vehicle is moving forward; doing so will damage the transmission.
- Do not rest your foot on the clutch pedal while driving as this will cause premature clutch wear or damage.

 **CAUTION**

- If the clutch is engaged suddenly while the engine revolution is high, an extremely large load will be applied instantaneously to the power train, possibly leading to the breakage of that component. Please ensure, therefore, that the clutch pedal is always applied in a slow yet firm manner. Your vehicle has a special feature to protect the power train from damage; the engine is controlled in such a way that excessive increase in engine revolution is prevented in situations where the accelerator pedal is depressed while the gearshift lever is in the 1st position and the clutch pedal has been depressed.

NOTE

- If it is hard to shift into 1st, depress the clutch pedal again; the shift will then be easier to make.
- To shift into reverse from 5th gear, move the gearshift lever to the “N” (Neutral) position, and then shift it into reverse.

Changing gears

E00610600136

Always take care to change the gear with the vehicle speed matched to the engine speed. Proper shifting will prolong engine life.

Avoid shifting down at high speed, as this may cause excessive engine speed (the tachometer needle into the red zone) and damage the engine.

Starting and driving

Possible driving speed

E00610801151

Shift point	Speed limit				
	2WD	Vehicles with easy select 4WD		Vehicles with super select 4WD	
		2H, 4H	4L	2H, 4H, 4HLc	4LLc
1 st gear	30 km/h (19 mph)	35 km/h (22 mph)	15 km/h (9 mph)	35 km/h (22 mph)	15 km/h (9 mph)
2 nd gear	60 km/h (37 mph)	65 km/h (40 mph)	35 km/h (22 mph)	65 km/h (40 mph)	30 km/h (19 mph)
3 rd gear	100 km/h (62 mph)	105 km/h (65 mph)	55 km/h (34 mph)	105 km/h (65 mph)	55 km/h (34 mph)
4 th gear	145 km/h (90 mph)	155 km/h (96 mph)	80 km/h (50 mph)	150 km/h (93 mph)	80 km/h (50 mph)

5th gear is an overdrive ratio and its use reduces engine speed below that of the 4th gear. Use 5th gear whenever vehicle speed allows, for maximum fuel economy.

Automatic transmission Sports Mode 4A/T, 5A/T

E00603200710

NOTE

- During running-in period or immediately after reconnection of the battery cable, there may be a case where gear shifts are not made smoothly. This does not indicate a faulty transmission. Gear shifts will become smooth after the transmission has been shifted several times by the electronic control system.

Selector lever operation

E00603301082

The transmission has 4 forward gears (4A/T), 5 forward gears (5A/T) and 1 reverse gear. The individual gears are selected automatically, depending on the position of the gear selector lever, the speed of the vehicle and the position of the accelerator pedal.

The selector lever has 2 gates; the main gate (1) and the manual gate (2).

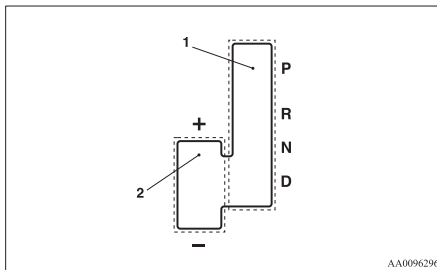



NOTE

- For information on manual gate operation, please refer to “Sports mode” on page 4-19.

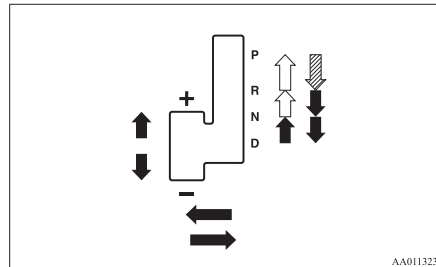
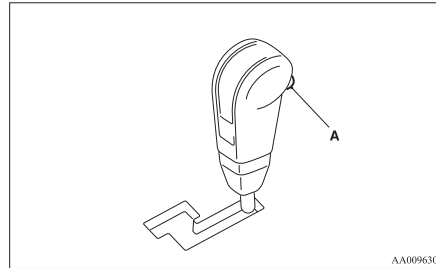
In the main gate, the selector lever has 4 positions, and is equipped with a lock button (A) to avoid inadvertent selection of the wrong gear.



	The lock button must be pushed while the brake pedal is depressed to move the selector lever.
---	---

	The lock button must be pushed to move the selector lever.
	The lock button need not be pushed to move the selector lever.

WARNING

- If the lock button is always pushed to operate the selector lever, the lever may be accidentally shifted into the “P” (PARK) or “R” (REVERSE) position. Be sure not to push the lock button when performing the operations indicated by  in the illustration.
- Always depress the brake pedal when shifting the selector lever into a gear from the “P” (PARK) or “N” (NEUTRAL) position. When beginning to drive, do not shift the selector lever from the “P” (PARK) or “N” (NEUTRAL) position while depressing the accelerator pedal, doing so is dangerous because the vehicle will “jump” forward or backward.

When the selector lever cannot be shifted from the “P” (PARK) position

When the selector lever cannot be shifted from the “P” (PARK) position to another position while the brake pedal is pressed and held down with the ignition switch at the “ON” position, the battery may be flat or the shift-lock mechanism may be malfunctioning.

Immediately have your vehicle checked by an authorized MITSUBISHI MOTORS dealer. If you need to move the vehicle, shift the selector lever as follows.

Starting and driving

1. Make sure the parking brake is applied.
2. Stop the engine if it is running.
3. Depress the brake pedal with the right foot.
4. Turn the ignition switch to the “ACC” position.
5. Insert a straight blade (or minus) screwdriver in the shiftlock release hole (A). Shift the selector lever to the “N” (NEUTRAL) position while pressing the straight blade (or minus) screwdriver down.

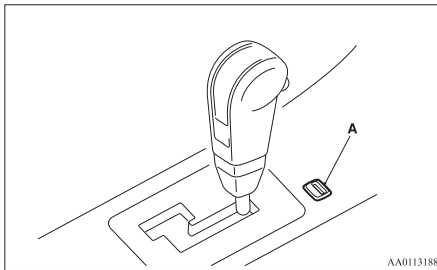

Selector lever position indicator

E00603500885

When the ignition switch is turned to the “ON” position, the current position of the selector lever is indicated by the indicator (A) shown on the instrument cluster {i.e. “P” (PARK), “R” (REVERSE), “N” (NEUTRAL), “D” (DRIVE)}.

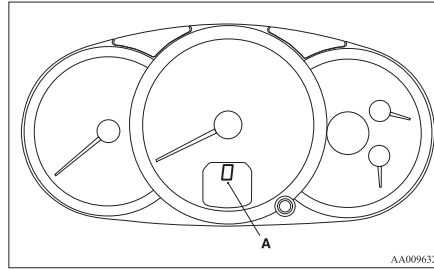

Selector lever positions (Main gate)

E00603800729

“P” PARK

This position locks the transmission to prevent the vehicle from moving. The engine can be started in this position.

“R” REVERSE

This position is to back up.

CAUTION

- Never shift into the “P” (PARK) or “R” (REVERSE) position while the vehicle is in motion to avoid transmission damage.

“N” NEUTRAL

At this position the transmission is disengaged. It is the same as the neutral position on a M/T, and should only be used when the vehicle is stationary for an extended length of time during driving, such as in a traffic jam.

WARNING

- Never move the selector lever to the “N” (NEUTRAL) position while driving. A serious accident could occur since you could accidentally move the lever into the “P” (PARK) or “R” (REVERSE) position or you will lose engine braking.
- On a gradient the engine should be started in the “P” (PARK) position, not in the “N” (NEUTRAL) position.
- Always keep your right foot on the brake pedal when shifting into or out of “N” (NEUTRAL), to minimize the risk of loss of control.

“D” DRIVE

This position is for normal driving. The transmission automatically selects a suitable gear ratio for your speed and acceleration.

CAUTION

- Never shift into the “D” (DRIVE) position from the “R” (REVERSE) position while the vehicle is in motion to avoid transmission damage.

Sports mode

E00603901323

Whether the vehicle is stationary or in motion, sports mode is selected by gently pushing the selector lever from the “D” (DRIVE) position into the manual gate (A). To return to “D” range operation, gently push the selector lever back into the main gate (B).

In sports mode, gear shifts can be made rapidly simply by moving the selector lever backward and forward. In contrast to a manual transmission, the sports mode allows gear shifts with the accelerator pedal depressed.

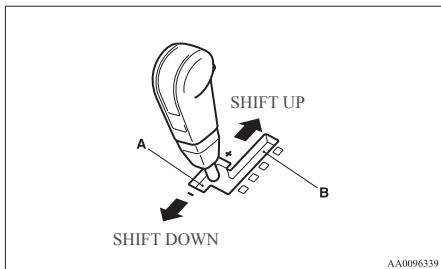

AA0096339

+ (SHIFT UP)

Push the lever forward once to shift up one gear.

- (SHIFT DOWN)

Pull the lever backward once to shift down one gear.

CAUTION

- In sports mode, the driver must execute upward shifts in accordance with prevailing road conditions, taking care to keep the engine speed below the red zone.
- By rapidly moving the selector lever backward (SHIFT DOWN) twice, it is possible to skip one gear, i.e., 3rd to 1st, 4th to 2nd or 5th to 3rd. Since sudden engine braking and/or rapid acceleration can cause a loss of traction, downshifts must be made carefully in accordance with the vehicle's speed.

NOTE

- In sports mode, only the 4 or 5 forward gears can be selected. To reverse or park the vehicle, move the selector lever to the “R” (REVERSE) or “P” (PARK) position as required.
- To maintain good running performance, the transmission may refuse to perform an up-shift when the selector lever is moved to the “+ (SHIFT UP)” position at certain vehicle speeds. Also, to prevent over-revving of the engine, the transmission may refuse to perform a downshift when the lever is moved to the “- (SHIFT DOWN)” position at certain vehicle speeds.
- In sports mode, downward shifts are made automatically when the vehicle slows down. When the vehicle stops, 1st gear is automatically selected.

Starting and driving

- When driving away on a slippery road, push the selector lever forward into the “+ (SHIFT UP)” position. This causes the transmission to shift into the 2nd gear which is better for smooth driving away on a slippery road. Push the selector lever to the “- (SHIFT DOWN)” side to shift back to the 1st gear.

Sports mode indicator

E00612300498

In sports mode, the currently selected position is indicated by the indicator (A) shown on the instrument panel.

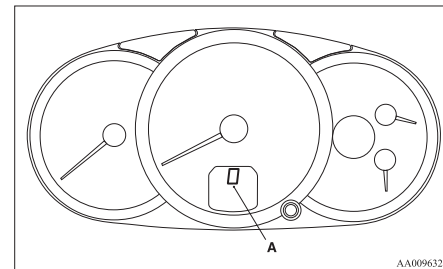

AA0096326

Starting and driving

When a malfunction occurs in the automatic transmission

E00615100152

When the selector lever position indicator blinks

E00615200238

When the selector lever position indicator blinks while you are driving, there could be a malfunction in the automatic transmission system.

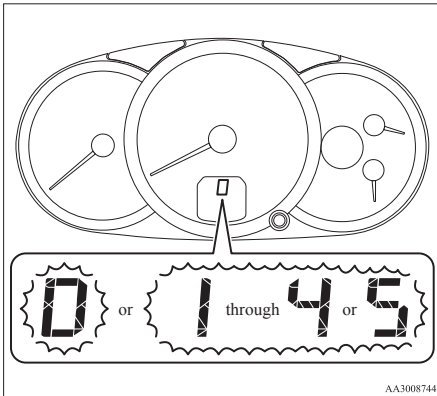

CAUTION

- If the selector lever position indicator blinks while you are driving, it is likely that a safety device is operating because of a malfunction in the automatic transmission. We recommend you to have your vehicle inspected as soon as possible.

CAUTION

- The selector lever position indicator warning function does not operate with the selector lever in the “P” (PARK), “R” (REVERSE) or “N” (NEUTRAL) position.

When the A/T (automatic transmission) fluid temperature warning lamp comes on

E00615300141

The automatic transmission fluid temperature warning lamp comes on when the automatic transmission fluid temperature becomes abnormally high. Normally the warning lamp comes on when the ignition switch is turned to the “ON” position, and then will go out after a few seconds.

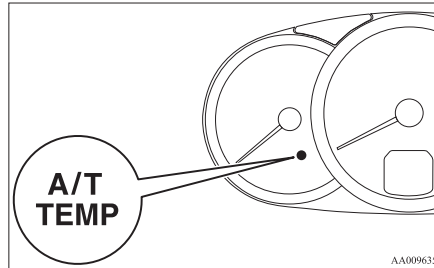

CAUTION

- If the lamp comes on, reduce the engine speed and stop the vehicle in a safe area. Then set the selector lever to the “P” (PARK) position and idle the engine until the warning lamp goes off. When the warning lamp goes off, resume normal driving. If the warning lamp does not go off, we recommend you to have your vehicle inspected.

Operation of the automatic transmission

E00604200528

CAUTION

- Before selecting a gear with the engine running and the vehicle stationary, fully depress the brake pedal to prevent the vehicle from creeping. The vehicle will begin to move as soon as the gear is engaged, especially when the engine speed is high, at fast idle or with the air conditioning operating, the brakes should only be released when you are ready to drive away.
- Depress the brake pedal with the right foot at all times. Using the left foot could cause driver movement delay in case of an emergency.
- To prevent sudden acceleration, never race the engine when shifting from the “P” (PARK) or “N” (NEUTRAL) position.

CAUTION

- Operating the accelerator pedal while the other foot is resting on the brake pedal will affect braking efficiency and may cause premature wear of brake pads.
- Use the selector lever in the correct shift position in accordance with driving conditions.
Never coast downhill backward with the driving shift position {"D" (DRIVE) or sports mode} or coast forward with the "R" (REVERSE) position.
The engine stops and the brake pedal effort or the steering wheel handling weight increasing could lead to an accident.
- Do not race the engine with brake pedal pressed when the vehicle is stationary. This can damage the automatic transmission.

Passing acceleration

E00604500329

To gain extra acceleration in "D" (DRIVE) position, push the accelerator to the floor. The automatic transmission will automatically downshift.

NOTE

- In "Sports mode", downshifts do not take place when the accelerator is depressed all the way to the floor.

Waiting

E00604600304

For short waiting periods, such as at traffic signals, the vehicle can be left in gear and held stationary with the service brake.

For longer waiting periods with the engine running, place the selector lever in the "N" (NEUTRAL) position..

CAUTION

- Never hold the vehicle stationary on a hill using the accelerator pedal (without using the brake pedal). Always apply the parking brake and/or service brakes.
- Unexpected acceleration may occur if the selector lever is in a position other than "P" (PARK) or "N" (NEUTRAL). Prior to moving off after having stopped the vehicle, make sure that the selector lever is in the "D" (DRIVE) position.

Parking

E00604700262

To park the vehicle, first bring it to a complete stop, fully engage the parking brake, and then move the selector lever to the "P" (PARK) position. If you are going to leave the vehicle unattended, always switch off the engine and remove the ignition key.

NOTE

- On a slope, be sure to apply the parking brake before moving the selector lever to the "P" (PARK) position. If you move the selector lever to the "P" (PARK) position before applying the parking brake, it may be difficult to disengage the selector lever from the "P" (PARK) position when next you drive the vehicle, requiring application of a strong force to the selector lever to move from the "P" (PARK) position.

When the automatic transmission makes no speed change

E00604800683

If the transmission does not change speeds while driving, or your vehicle does not pick up enough speed when starting on an uphill slope, it may be that there is something unusual happening in the transmission, causing a safety device to activate. We recommend you to have your vehicle checked as soon as possible.

1. If your vehicle has difficulty moving uphill, shift the selector lever into 2nd gear of the "Sports mode".
This method might not work depending on the type of transmission malfunction.
2. Once the vehicle is moving on a level road, move the selector lever back to "D" (DRIVE).

NOTE

- When the selector lever position indicator in the instrument panel blinks, it means that there is an abnormal condition in the transmission. Refer to "When the selector lever position indicator blinks" on page 4-20.

Easy select 4WD*

E00614700148

Shifting to rear-wheel drive or 4-wheel drive can be made by operating the transfer shift lever (A). Shift the transfer shift lever to an appropriate position according to the road surface conditions. In addition, the 2WD/4WD operation indication lamp indicates the transfer shift lever shifting state. Refer to “2WD/4WD operation indication lamp” on page 4-24.

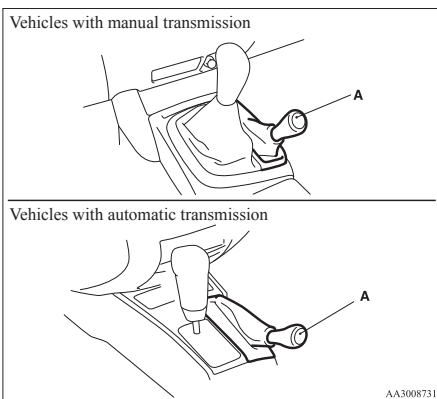

Transfer shift lever position and 2WD/4WD operation indication lamp

E00614800080

Transfer shift lever position		2WD/4WD operation indication lamp	Driving conditions
2H	Rear-wheel drive		When driving on dry paved road.
4H	4-wheel drive		When driving on rough, sand or snow covered roads.
4L	Low range 4-wheel drive		When driving up or down steep hills, on rough or muddy roads (especially when increased torque is required).

: Illuminate
 : Remain off

NOTE

- On vehicles with automatic transmission, when the transfer shift lever is in “4L”, the transmission will not shift into the overdrive gear.

CAUTION

- The “4L” range gives maximum torque for lowspeed driving on steep slopes, as well as sandy, muddy, and other difficult surfaces. On vehicles with automatic transmission, do not exceed speeds of approximately 70 km/h (43 mph) in “4L” range.
- Do not drive your vehicle in the “4H” or “4L” on dry paved roads and highways. Doing so may result in excessive tyre wear, increased fuel consumption, and possible noise generation. It may also increase the differential oil temperature, which may damage the drive system. Further, the drive train will be subjected to excessive loading, resulting in oil leakage, component seizure, or other serious problems. On dry paved roads and highways, drive the vehicle in “2H” only.

Transfer shift lever operation

E00614900111

The shift pattern is shown on the transfer shift lever knob.

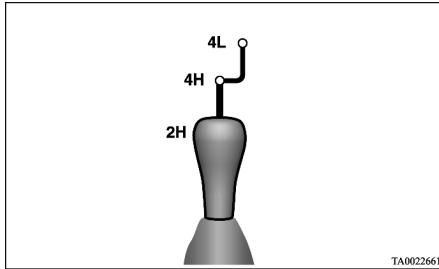

The transfer shift lever should be positioned in accordance with the following operating conditions:

To shift from	To	Procedure	
		Vehicles with manual transmission	Vehicles with automatic transmission
2H	4H	<p>The transfer shift lever can be operated while the vehicle is either moving or stationary.</p> <p>When the vehicle is not in motion, shift the gearshift lever to the “N” (Neutral) position before operating the transfer shift lever.</p> <p>When the vehicle is moving, and only while it can be steered straight ahead, release the accelerator pedal before operating the transfer shift lever.</p>	<p>The transfer shift lever can be operated while the vehicle is either moving or stationary.</p> <p>When the vehicle is not in motion, shift the selector lever to the “N” (NEUTRAL) position before operating the transfer shift lever.</p> <p>When the vehicle is moving, and only while it can be steered straight ahead, shift the selector lever to the “D” (DRIVE) position, and release the accelerator pedal before operating the transfer shift lever.</p>
4H	2H		
4H	4L	<p>Stop the vehicle, depress the clutch pedal to the floor and operate the transfer shift lever.</p>	<p>Stop the vehicle, shift the selector lever to the “N” (NEUTRAL) position, and operate the transfer shift lever.</p> <p>If operation is made with the selector lever placed in any other position than “N” (NEUTRAL) position, a gear noise may be generated, with a possible failure to shift into a proper gear.</p>
4L	4H		

Starting and driving

NOTE

- Shifting of the transfer shift lever between “2H” ↔ “4H” should only be done at speeds below 100 km/h (62 mph).
- During driving, never attempt to shift from “4H” to “4L”.
- When shifting from “2H” to “4H” in cold weather while the vehicle is in motion, the transmission gear may make some noise. In cold weather, try to shift the gear while the vehicle is stopped.
- There may be a case that the transfer shift lever feels heavy when it is moved from “4H” to “2H” with the steering wheel in turned position. This is normal and not any indication of trouble.

4

CAUTION

- Do not operate the transfer shift lever while the rear wheels of the vehicle are slipping on snow or ice.

2WD/4WD operation indication lamp

E00615000122

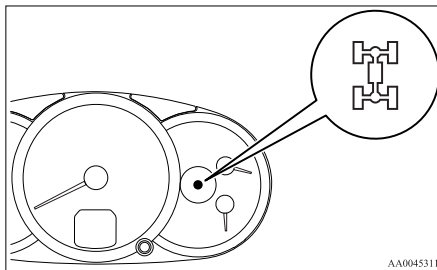

AA0045311

When the ignition switch is in the “ON” position, the 2WD/4WD operation indication lamp shows the shifting condition. The 2WD/4WD operation indication lamp illuminates at each transfer shift lever position as follows:

“2H” ↔ “4H”

Transfer shift lever position	2WD/4WD operation indication lamp	
2H		
	↓	↑

Transfer shift lever position	2WD/4WD operation indication lamp	
Drive mode switching in progress		
	↓	↑
4H		

: Illuminate



: Remain off



NOTE



- When the transfer shift lever is shifted between 2H ↔ 4H, the 2WD/4WD operation indication lamp does not switch to illuminate or remain off while the selection is in process. Take the following precautions when the indication lamp remains on or off.
 - Keep the steering wheel in the straight ahead position while making range selections. If you attempt to drive forward with the steering wheel turned, gear rattling may occur and the desired range may not actually be selected.

- When the transfer shift lever is shifted between “2H” ↔ “4H” while the vehicle is stopped, the 2WD/4WD operation indication lamp does not switch to illuminate or remain off while the selection is in process. Drive slowly and normally after confirming that the lamp is switched.
- Do not move the selector lever while the 2WD/4WD operation indication lamp is switched.
- If the 2WD/4WD operation indication lamp does not switch after a “2H” ↔ “4H” selection has been made with the vehicle moving, hold the steering wheel in the straight ahead position and slowly depress the accelerator pedal several times.

“4H” ↔ “4L”

Transfer shift lever position	2WD/4WD operation indication lamp
4H	 
Drive mode switching in progress	

Transfer shift lever position	2WD/4WD operation indication lamp
	
4L	

 : Illuminate
 : Remain off

NOTE

- The 2WD/4WD operation indication lamp will go out momentarily during shifting process from “4H” to “4L” or vice versa, as the transfer shift lever passes through the neutral position. Be sure to operate the transfer shift lever until the 2WD/4WD operation indication lamp illuminates again.

- If, after a “4H” ↔ “4L” selection has been made, the 2WD/4WD operation indication lamp remains off and the desired range is not actually selected, return the transfer shift lever to its previous position. Place the steering wheel in the straight ahead position, drive the vehicle forward, and release the accelerator pedal. Next, hold down the clutch pedal (with manual transmission) or place the selector lever in the “N” (NEUTRAL) position (with automatic transmission) and make the range selection again.

Super select 4WD*

E00605700214

Shifting to rear-wheel drive or 4-wheel drive can be made by operating the transfer shift lever (A). Shift the transfer shift lever to an appropriate position according to the road surface conditions. In addition, the 2WD/4WD operation indication lamp indicates the transfer shift lever shifting state. Refer to “2WD/4WD operation indication lamp” on page 4-28.

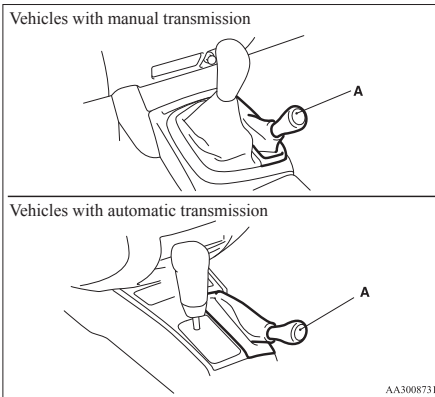

Transfer shift lever position and 2WD/4WD operation indication lamp

E00605800228

Transfer shift lever position		2WD/4WD operation indication lamp	Driving conditions
2H	Rear-wheel drive		When driving on dry paved road.
4H	Full-time 4-wheel drive		The basic position for super select 4WD. When driving on dry paved or slippery roads.
4HLc	Centre differential lock engaged 4-wheel drive		When driving on rough, sand or snow covered roads.
4LLc	Low range centre differential lock engaged 4-wheel drive		When driving up or down steep hills, on rough or muddy roads (especially when increased torque is required).

: Illuminate
 : Remain off

NOTE

- On vehicles with automatic transmission, when the transfer shift lever is in “4LLc”, the transmission will not shift into the overdrive gear.

CAUTION

- The “4LLc” range gives maximum torque for low-speed driving on steep slopes, as well as sandy, muddy, and other difficult surfaces. On vehicles with automatic transmission, do not exceed speeds of approximately 70 km/h (43 mph) in “4LLc” range.
- Do not drive your vehicle in the “4HLc” or “4LLc” on dry paved roads and highways. Doing so may result in excessive tyre wear, increased fuel consumption, and possible noise generation. It may also increase the differential oil temperature, which may damage the drive system. Further, the drive train will be subjected to excessive loading, resulting in oil leakage, component seizure, or other serious problems. On dry paved roads and highways, drive the vehicle in “2H” or “4H” only.

Transfer shift lever operation

E00605900173

The shift pattern is shown on the transfer shift lever knob.

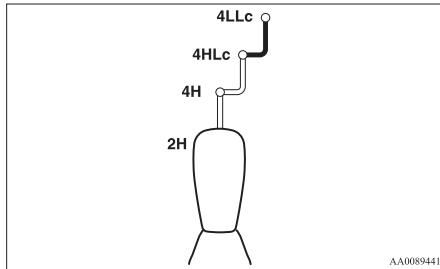

AA0089441

The transfer shift lever should be positioned in accordance with the following operating conditions:

□ : Not push down the transfer shift lever

■ : Push down the transfer shift lever

To shift from	To	Procedure	
		Vehicles with manual transmission	Vehicles with automatic transmission
2H	4H	The transfer shift lever can be operated while the vehicle is either moving or stationary.	The transfer shift lever can be operated while the vehicle is either moving or stationary.
4H	2H or 4HLc		
4HLc	4H	When the vehicle is not in motion, shift the gearshift lever to the “N” (Neutral) position before operating the transfer shift lever. When the vehicle is moving, and only while it can be steered straight ahead, and release the accelerator pedal before operating the transfer shift lever.	When the vehicle is not in motion, shift the selector lever to the “N” (NEUTRAL) position before operating the transfer shift lever. When the vehicle is moving, and only while it can be steered straight ahead, shift the selector lever to the “D” (DRIVE) position, and release the accelerator pedal before operating the transfer shift lever.
4HLc	4LLc	Stop the vehicle, depress the clutch pedal to the floor and operate the transfer shift lever while keeping the transfer shift lever pushed down. Keep depressing the clutch pedal while the 2WD/4WD operation indication lamp continues to blink.	Stop the vehicle, shift the selector lever to the “N” (NEUTRAL) position, and operate the transfer shift lever while keeping the transfer shift lever pushed down. If operation is made with the selector lever placed in any other position than “N” (NEUTRAL) position, a gear noise may be generated, with a possible failure to shift into a proper gear.
4LLc	4HLc		

Starting and driving

NOTE

- Shifting of the transfer shift lever between “2H” ↔ “4H” should only be done at speeds below 100 km/h (62 mph).
 - During driving, never attempt to shift from “4HLc” to “4LLc”.
 - When shifting from “2H” to “4H” in cold weather while the vehicle is in motion, the transmission gear may make some noise. In cold weather, try to shift the gear while the vehicle is stopped.
 - When the transfer shift lever is shifted from “4H” to “4HLc” while the vehicle is stopped, the 2WD/4WD operation indication lamp blinks while the selection is in process. Drive slowly and normally after confirming that the lamp is illuminated. (Refer to “2WD/4WD operation indication lamp” on page 4-28.)
 - Do not move the selector lever while the 2WD/4WD operation indication lamp is blinking.
 - The 2WD/4WD operation indication lamp will go out momentarily during shifting process from “4HLc” to “4LLc” or vice versa, as the transfer shift lever passes through the neutral position.
- Be sure to operate the transfer shift lever until the 2WD/4WD operation indication lamp illuminates again.
- There may be a case that the transfer shift lever feels heavy when it is moved from “2H” to “4H” with the steering wheel in turned position.
- This is normal and not any indication of trouble.

CAUTION

- Do not operate the transfer shift lever while the rear wheels of the vehicle are slipping on snow or ice.

2WD/4WD operation indication lamp

E0062590036

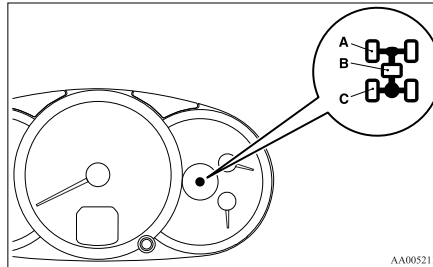









AA0052111

- A- Front wheel lamp
- B- Centre differential lock lamp
- C- Rear wheel lamp

When the ignition switch is in the “ON” position, the 2WD/4WD operation indication lamp shows the shifting condition. The 2WD/4WD operation indication lamp comes on at each transfer shift lever position as follows:

“2H” ↔ “4H”

Transfer shift lever position	2WD/4WD operation indication lamp
2H	 
Drive mode switching in progress	 
4H	

- : Blink
- : Illuminate
- : Remain off

“4H” ↔ “4HLc”

Transfer shift lever position	2WD/4WD operation indication lamp
4H	
Drive mode switching in progress	
4HLc	

: Blink
: Illuminate
: Remain off

“4HLc” ↔ “4LLc”

Transfer shift lever position	2WD/4WD operation indication lamp
4HLc	
Drive mode switching in progress	
4LLc	

: Blink
: Illuminate
: Remain off

NOTE

- The 2WD/4WD operation indication lamp blinks while the selection is in process. Take

the following precautions when the indication lamp is blinking or remains off.

- Keep the steering wheel in the straight ahead position while making range selections. If you attempt to drive forward with the steering wheel turned, gear rattling may occur and the desired range may not actually be selected.
- If you move the transfer shift lever from “4H” to “4HLc” while the vehicle is stationary, keep your speed initially very low when you subsequently make a standing start. Before driving at normal speeds, confirm that the centre differential lock lamp has changed from blinking to steady illumination.
- If you move the transfer shift lever from “4HLc” to “4H” and the centre differential lock lamp does not stop blinking, place the steering wheel in the straight ahead position and slowly depress the accelerator pedal several times.
- If you move the transfer shift lever from “4H” to “2H” and the front wheel lamp does not stop blinking, confirm safety around the vehicle then accelerate, decelerate, and reverse until the front wheel lamp goes off. When the front wheel lamp goes off, you can then proceed to drive the vehicle.

If you accelerate, decelerate, and reverse but the front wheel lamp still does not stop blinking, return the transfer shift lever to “4H” then have your vehicle inspected.

Starting and driving

- When you move the transfer shift lever from “4H” to “4HLc”, there may be a slight delay before the centre differential lock lamp illuminates.

Rear differential lock*

E00606200115

If one wheel starts to spin freely and the vehicle becomes stuck and cannot be freed even using 4-wheel drive, the rear differential lock switch (A) can be used to activate the rear differential lock for extra traction.

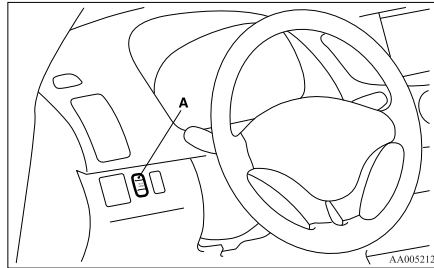

Operating the rear differential lock

1. Move the transfer shift lever to “4L” or “4H” position (easy select 4WD), “4LLc” or “4HLc” position (super select 4WD).
2. To activate the rear differential lock, press the rear differential lock switch (1).

3. To deactivate the rear differential lock, press the rear differential lock switch (2).

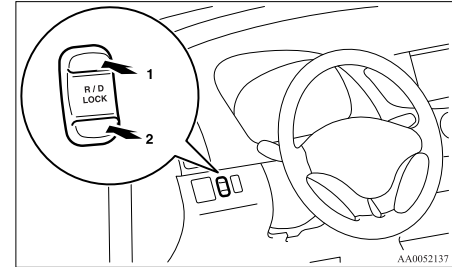

⚠ CAUTION

- Operate the rear differential lock switch after the wheels are stopped. Operating the switch with the wheels turning may cause the vehicle to dart in unexpected directions.

NOTE

- The rear differential lock does not operate when the transfer shift lever is in “2H” position (easy select 4WD), “2H” or “4H” position (super select 4WD).
- When the rear differential is locked with the transfer shift lever in “4L” or “4H” position (easy select 4WD), “4LLc” or “4HLc” position (super select 4WD) changing the shift lever to “2H” position (easy select 4WD), “2H” or “4H” position (super select 4WD) makes the rear differential unlock automatically.

The rear differential lock indication lamp

E00606300350

When the ignition switch is turned to the “ON” position, the rear differential lock indication lamp (A) in the meter cluster illuminates for a few seconds then indicates the rear differential lock’s operating status (activated or deactivated).

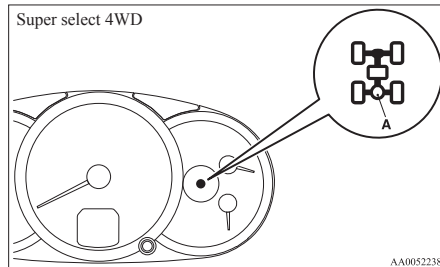
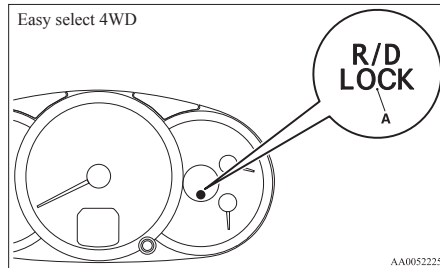

NOTE

- The 2WD/4WD operation indication lamp also illuminates for a few seconds when the ignition switch is turned to the “ON” position. Refer to “2WD/4WD operation indication lamp” on pages 4-24, 4-28.

The status of the rear differential lock (resulting from depression of the rear differential lock switch) is shown by blinking or steady illumination of the rear differential lock indication lamp.

The operation state of rear differential lock	Rear differential lock indication lamp	
	Easy select 4WD	Super select 4WD
Rear differential lock deactivated	 R/D LOCK	
Switching in progress	 R/D LOCK	

The operation state of rear differential lock	Rear differential lock indication lamp	
Rear differential lock activated	R/D LOCK	

: Blink

: Illuminate (steady)

: Remain off

NOTE

- The indication lamp blinks while the rear differential lock is being switched between its activated and deactivated conditions. When the switching operation is complete, the indication lamp is either illuminated steadily or not illuminated.
- On vehicles with the active stability & traction control (ASTC) and anti-lock brake system (ABS), the ASTC and ABS functions are suspended while the rear differential lock is activated. ASTC indication lamp, ASTC OFF indication lamp and ABS warning lamp are illuminated while these functions are suspended. It does not indicate a problem. When the rear differential lock is disengaged, these lamps go out and function again. Refer to “ABS warning lamp” on page 4-40, “ASTC indication lamp, ASTC OFF indication lamp” on page 4-43.

Starting and driving

- On vehicles with the anti-lock brake system (ABS), the ABS function is suspended while the rear differential lock is activated. The ABS warning lamp is illuminated while ABS functionality is suspended. Refer to “ABS warning lamp” on page 4-40.
- If the indication lamp continues blinking after the switch has been pressed to deactivate the rear differential lock, hold the steering wheel in the straight ahead position then slowly depress and release the accelerator pedal several times.
- If the indication lamp continues blinking after the switch has been pressed to activate the rear differential lock, bear in mind the following instructions:
 - If the vehicle speed is 12 km/h (7 mph) or higher, decelerate to a speed of 6 km/h (4 mph) or lower. The indication lamp will illuminate steadily and the rear differential lock will be activated.
 - If the vehicle speed is 12 km/h (7 mph) or lower, turn the steering wheel from side to side until the indication lamp illuminates steadily. If the vehicle is stuck in soft ground, make sure the area around the vehicle is clear then repeatedly attempt to drive forward and backward. The indication lamp will illuminate steadily and the rear differential lock will be activated.

Examples of effective use of the rear differential lock

E00606400058

CAUTION

- Use the rear differential lock only as an emergency measure when the vehicle is stuck and cannot be freed with the transfer shift lever in “4L” or “4H” position (easy select 4WD) or in “4LLc” or “4HLc” position (super select 4WD). Deactivate the rear differential lock immediately after using it.

When one of the wheels has fallen in a ditch

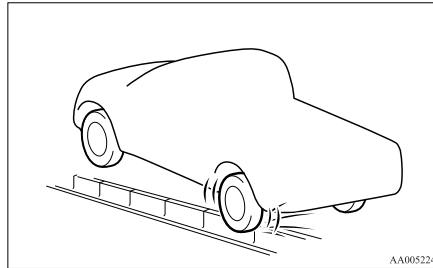

AA0052241

When driving on rocky roads

When the vehicle is unable to move because one of the wheels is suspended in the air.

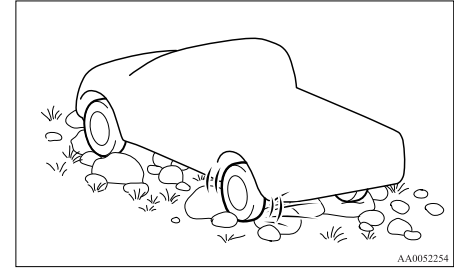

AA0052254

When getting out of snow

When the vehicle is unable to get going because one of the wheels is on the snow and the other on a paved road.

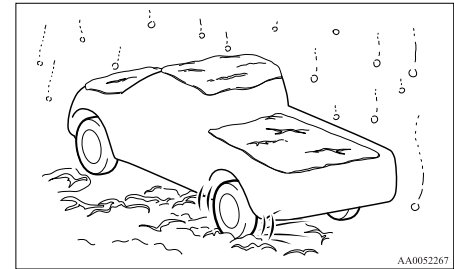

AA0052267

Examples of incorrect use of the rear differential lock

E00606500059

⚠ WARNING

- If the “4L” or “4H” position (easy select 4WD), “4LLc” or “4HLc” position (super select 4WD) is selected along with the rear differential lock, the following phenomena appear and it is very dangerous. Please be sure to release the rear differential lock on normal roads.
 - If the rear differential lock is used by mistake when driving on a paved road: With the rear differential lock on, the power to drive the vehicle straight ahead becomes very strong, which may make it difficult to turn the steering wheel.

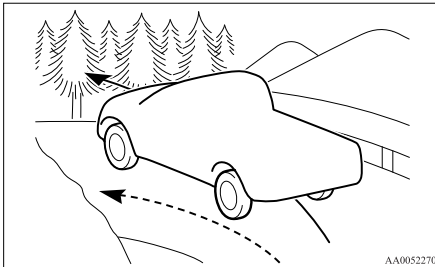

⚠ WARNING

- If the rear differential lock is used by mistake when turning a curve or making a right or left turn at a crossing or the like: The vehicle is unable to make a turn and may go straight ahead.

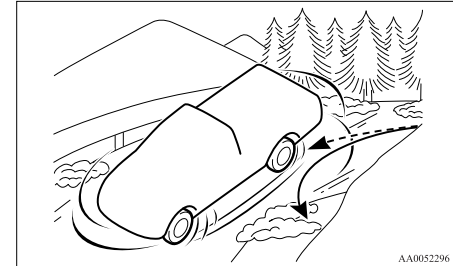
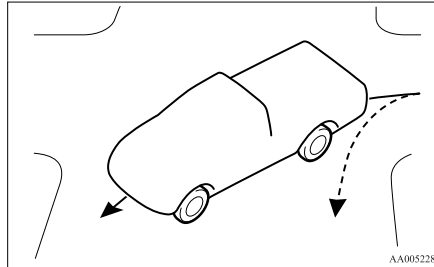

⚠ WARNING

- If the rear differential lock is used by mistake except when making an emergency escape on snow or frozen road: It becomes difficult to make a steady turn.
- In the case where the condition of the road is different for the right tyre to drive from the left tyre (such as one tyre on a paved road and the other on ice), direction of the vehicle may change abruptly when engine braking or accelerating. Do not use the rear differential lock except when making an emergency escape on a snow or frozen road, but drive with 4WD.

Starting and driving

4-wheel drive operation

E00606601028

By selecting 4-wheel drive, both axles of the vehicle are rigidly connected with each other. This improves the traction characteristics. When turning sharp corners or moving forward and backward repeatedly, however, the drive line is stressed, which is felt as a braking effect. A 4-wheel drive vehicle can accelerate more quickly and smoothly.

However, note that the braking distance is not shorter than that of a rear-wheel drive vehicle.

When using 4-wheel drive on rough roads (snow, mud, sand, etc.), it is important to operate the vehicle correctly.

NOTE

- The driving posture should be more upright and closer to the wheel than usual; adjust the seat to a good position for easy steering and pedal operation. Be sure to wear the seat belt.
- After driving on rough roads, check each part of the vehicle and wash it thoroughly with water. Refer to the "Vehicle care" section and "Inspection and maintenance following rough road operation" on page 4-36.

Driving on dry paved road and highway

Select "2H" position (easy select 4WD), "2H" or "4H" position (super select 4WD) to drive on the dry paved road. Especially on dry highway, never select the "4H" or "4L" position (easy select 4WD), "4HLc" or "4LLc" position (super select 4WD).



CAUTION

- **Selecting "4H" or "4L" position (easy select 4WD), "4HLc" or "4LLc" position (super select 4WD) to drive on dry paved road will increase the fuel consumption with possible noise generation and early tyre wear.**

It may also increase the differential oil temperature, resulting in possible damage to the driving system.

Further, the drive train will be subjected to excessive loading, possibly leading to oil leakage, component seizure, or other serious faults.

Driving on snowy or icy roads

Set the transfer shift lever to "4H" or "4L" position (easy select 4WD), "4H" or "4HLc" position (super select 4WD) in accordance with the road conditions, and then gradually depress the accelerator pedal for a smooth start.

NOTE

- The use of snow tyres and/or tyre chains is recommended.
- Maintain a safe distance between vehicles, avoid sudden braking, and use engine braking (downshifting).



CAUTION

- **Avoid sudden braking, sudden acceleration, and sharp turning; such operations could cause skidding and spinouts.**

Driving on sandy or muddy roads

Set the transfer shift lever to "4H" or "4L" position (easy select 4WD), "4HLc" or "4LLc" position (super select 4WD) and then gradually depress the accelerator pedal for a smooth start. Keep the pressure on the accelerator pedal as constant as possible, and drive at low speed.



CAUTION

- **Do not force the vehicle or drive recklessly on sandy surfaces. In comparison with normal road surfaces, the engine and other drive-system components are put under excessive strain when driving on such a surface, and this could lead to accidents.**
- **If any of following conditions occur while the vehicle is being driven, immediately park your vehicle in a safe place and follow these procedures:**
 - **The needle in the temperature gauge approaches the overheating zone. Refer to "Engine overheating" on page 6-04.**
 - **Automatic transmission fluid temperature warning lamp comes on. Refer to "When the A/T (automatic transmission) fluid temperature warning lamp comes on" on page 4-20.**

WARNING

- When attempting to rock your vehicle out of a stuck position, be sure that the area around the vehicle is clear of people and physical objects. The rocking motion may cause the vehicle to suddenly launch forward or backward, causing injury or damage to nearby people or objects.

NOTE

- Avoid sudden braking, acceleration, and turning; such operations could result in the vehicle becoming stuck.
- If the vehicle becomes stuck in sandy or muddy roads, it can often be moved a rocking motion. Move the selector lever rhythmically between the “D” (DRIVE) and “R” (REVERSE) position (with M/T, between 1st and Reverse), while applying slight pressure to the accelerator pedal.
- It is recommended to start the vehicle with parking brake partially, but not completely, applied by slightly pulling the parking brake lever. After the vehicle has become free, do not forget to release the parking brake.
- If it is necessary to drive in extremely muddy conditions, the use of tyre chains is recommended. Because the extent of muddy conditions is difficult to judge and the vehicle could become bogged down very deeply, operation should be at a low speed. If possible, get out of the vehicle and check the conditions ahead before proceeding.

- Driving over roads in coastal areas or roads on which anti-skid preparations have been spread can cause rust on the vehicle; wash the vehicle thoroughly as soon as possible after such use.

Climbing sharp grades

Set the transfer shift lever to “4L” position (easy select 4WD), “4LLc” position (super select 4WD) to maximize the engine torque.

WARNING

- Go straight up. Do not try to traverse across a steep slope.
- If you begin to lose traction, ease off the accelerator pedal and gently turn the steering wheel alternately left and right to regain adequate traction again.

NOTE

- Choose as smooth a slope as possible with few stones or other obstacles.
- Before attempting to drive up the slope, walk up it to confirm that the vehicle can handle the grade.

Descending sharp grades

Set the transfer shift lever to “4L” position (easy select 4WD), “4LLc” position (super select 4WD), use the engine brake (downshifting) and descend slowly.

WARNING

- Avoid snaking down a sharp grade. Descend the grade as straight as possible.

NOTE

- When descending a sharp grade, if the brakes are applied suddenly because of an obstacle encountered, control of the vehicle could be lost. Before descending the slope, walk down it and confirm the path.
- Before descending a grade, it is necessary to choose the appropriate gear. Avoid changing gears or depressing the clutch while descending the grade.
- MITSUBISHI MOTORS is not responsible to the operator for any damage or injury caused or liability incurred by improper and negligent operation of a vehicle. All techniques of vehicle operation described herein depend on the skill and experience of the operator and other participating parties and any deviation from the recommended operation instructions above is at their own risk.

Turning sharp corners

When turning a sharp corner in “4H” or “4L” position (easy select 4WD), “4HLc” or “4LLc” position (super select 4WD) at low speed, a slight difference in steering may be experienced similar to as if the brakes were applied. This is called tight corner braking and results from each of the 4 tyres being at a different distance from the corner. The phenomenon is peculiar to 4-wheel drive vehicles. If this occurs, either straighten the steering wheel, or change to rear-wheel drive.

Starting and driving

Crossing a stream

4-wheel drive vehicles are not necessarily waterproof. If the electrical circuits become wet, further operation of the vehicle will be impossible; therefore, avoid crossing streams unless absolutely necessary. If crossing a stream is unavoidable, use the following procedure:

1. Check depths of a stream and geographical features before attempting to cross a stream and ford the stream where the water is as shallow as practicable.
2. Set the transfer shift lever to “4L” position (easy select 4WD), “4LLc” position (super select 4WD).
3. Drive slowly at a speed of approximately 5 km/h (3 mph) to avoid splashing too much water.

4

CAUTION

- Never cross a stream where the water is deep.
Do not change gears while crossing the stream.
Frequent crossing of streams can adversely affect the life span of the vehicle; we recommend you to take the necessary measures to prepare, inspect, and repair the vehicle.

After crossing a stream, apply the brakes to be sure they are functioning properly. If the brakes are wet and not functioning properly, dry them out by driving slowly while lightly depressing the brake pedal. Inspect each part of the vehicle carefully.

Inspection and maintenance following rough road operation

E00606700048

After operating the vehicle in rough road conditions, be sure to perform the following inspection and maintenance procedures:

- Check that the vehicle has not been damaged by rocks, gravel, etc.
- Carefully wash the vehicle with water.
After washing, drive the vehicle slowly while lightly depressing the brake pedal in order to dry out the brakes. If the brakes still do not function properly, we recommend you to have the brakes checked as soon as possible.
- Remove the insects, dried grass, etc. clogging the radiator core.
- After crossing a stream, be sure to have the following items inspected at a MITSUBISHI MOTORS Authorized Service Point and take the necessary measures.
 - Check the brake system and, if necessary, have it serviced.
 - Check the engine, transmission, transfer, and differential oil or grease level and turbidity. If the oil or grease is milky, it indicates water contamination. Replace it with new oil or grease.
 - Grease the propeller shaft.
 - Check the inside of the vehicle. If ingress of water is found, dry the carpet etc.
 - Inspect the headlamps. If the headlamp bulb is flooded with water, we recommend you to have it drained.

Cautions on handling of 4-wheel drive vehicles

E00606800368

Tyres and wheels

Since the driving torque can be applied to the 4 wheels, the performance of the vehicle when operating in 4-wheel drive is greatly affected by the condition of the tyres.

Pay close attention to the tyres.

- Install specified tyres on all wheels. Refer to “Tyres and wheels” on page 9-17.
- Be sure to fit all 4 tyres and wheels of the same size and type.
When replacement of any of the tyres or wheels is necessary, replace all of them.
- All tyres should be rotated whenever the wear difference between the front and rear tyres is recognizable.

Good vehicle performance cannot be expected if there is a difference in wear between tyres. Refer to “Tyre rotation” on page 8-13.

- Check the tyre inflation pressure regularly.

CAUTION

- Always use tyres of the same size, same type, and same brand, and which have no wear differences. Using tyres of different size, type, brands or degree of wear, will increase the differential oil temperature, resulting in possible damage to the driving system. Further, the drive train will be subjected to excessive loading, possibly leading to oil leakage, component seizure, or other serious faults.

Towing

If towing is necessary, we recommend you to have it done by your MITSUBISHI MOTORS Authorized Service Point or a commercial tow truck service. In the following cases, transport the vehicle using a tow truck.

- The engine runs but the vehicle does not move or abnormal noise is produced.
- Inspection of the vehicle's underside reveals that oil or some other fluid is leaking.

Only when you cannot receive a towing service from a MITSUBISHI MOTORS Authorized Service Point or commercial tow truck service, tow your vehicle carefully in accordance with the instructions given in "Towing" on page 6-20.

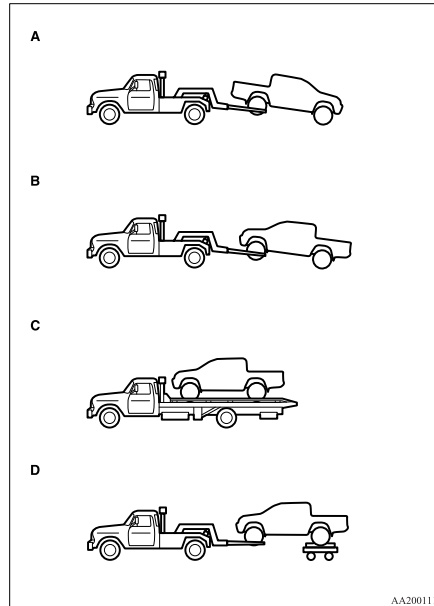

CAUTION

- Be sure to shift the transfer shift lever to "2H" position and transport the vehicle with the driving wheels on a carriage (Type A, C or D) as illustrated. Never try to tow with the transfer shift lever in "4H" or "4L" position (easy select 4WD), "4H", "4HLc" or "4LLc" position (super select 4WD) and with the front or rear wheels on the ground (Type A or B) as illustrated. This could result in damage to the drivetrain, or unstable towing. If you cannot shift the transfer shift lever to "2H" position or the transmission is malfunctioning or damaged, transport the vehicle with all the wheels on a carriage (Type C or D) as illustrated.

Jacking up a 4-wheel drive vehicle

WARNING

- Do not crank the engine while jacking up the vehicle. The tyre on the ground may turn and the vehicle may roll off the jack.

Clutch operation

Quick or slight clutch engagement made while the engine is running at high speed will cause damage to the clutch and transmission because the tractive force is very great.

Operate the pedal slowly and positively.

Starting and driving

Limited-slip differential*

E00606900037

A limited-slip differential is applied for the rear wheel differential only. The features of this limited-slip differential are described below:

Just as with a conventional differential, the wheel on one side is allowed to turn at a different speed from the wheel on the other side when the vehicle is cornering. The difference between the limited-slip differential and a conventional differential is that if the wheel on one side of the vehicle loses traction, a greater amount of torque is applied to the wheel on the other side to improve traction.

NOTE

- Even if there is a difference in the amount of traction the wheels can get, if both of them are spinning, the limited-slip differential will not be effective.

CAUTION

- Never start the engine while one of the rear wheels is jacked up and the other in contact with the ground; doing so may cause the vehicle to jump forward.
- When attempting to extract the vehicle from snow, mud, etc., and the engine is run continuously at high speed, the limited-slip differential will be adversely affected.

Braking

E00607001928

All the parts of the brake system are critical to safety. We recommend you to have the vehicle checked at regular intervals according to the service booklet.

CAUTION

- Avoid driving habits that cause heavy braking and never “ride” the brakes by resting your foot on the brake pedal while driving. It causes brake overheating and fade.

Brake system

The service brake is divided into two brake circuits. And your vehicle is equipped with power brakes. If one brake circuit fails, the other is available to stop the vehicle. If you should lose the power assist for some reason, the brakes will still work. In these situations, even if the brake pedal moves down to the very end of its possible stroke or resists being depressed, keep depressing the brake pedal down harder and further than usual; stop driving as soon as possible and have the brake system repaired.

WARNING

- Do not turn off the engine while your vehicle is in motion. If you turn off the engine while driving, the power assistance for the braking system will stop working and your brakes will not work effectively.

WARNING

- If the power assist is lost or if either brake hydraulic system stops working properly, have your vehicle checked immediately.

Warning lamp

The brake warning lamp illuminates to indicate a fault in the braking system. Refer to “Brake warning lamp” on page 3-08.

When brakes are wet

Check the brake system while driving at a low speed immediately after starting, especially when the brakes are wet, to confirm they work normally. A film of water can be formed on the brake discs or brake drums and prevent normal braking after driving in heavy rain or through large puddles, or after the vehicle is washed. If this occurs, dry the brakes out by driving slowly while lightly depressing the brake pedal.

When driving downhill

It is important to take advantage of the engine braking by shifting to a lower shift position while driving on steep downhill roads in order to prevent the brakes from overheating.

⚠ WARNING

- Do not leave any objects near the brake pedal or let a floor mat slide under it; doing so could prevent the full pedal stroke that would be necessary in an emergency. Make sure that the pedal can be operated freely at all times. Make sure the floor mat is securely held in place.

Brake pads and linings

- Avoid hard braking situations. New brakes need to be broken-in by moderate use for the first 200 km (124 miles).
- The disc brakes are provided with a warning device which emits a shrieking metallic sound while braking if the brake pads have reached their wear limit. If you hear this sound, have the brake pads replaced.

⚠ WARNING

- Driving with worn brake pads will make it harder to stop, and can cause an accident.

Brake assist system*

E00627000392

The brake assist system is a device assisting drivers who cannot depress the brake pedal firmly when it is necessary to do so (such as in emergency stop situations) and provides greater braking force. If the brake pedal is depressed suddenly, the brakes will be applied with more force than usual.

⚠ CAUTION

- The brake assist system is not a device designed to exercise braking force greater than its capacity. Make sure to always keep a sufficient distance between vehicles in front of you without relying too much on the brake assist system.

NOTE

- Once the brake assist system is operational, it maintains great braking force even if the brake pedal is lightly released. To stop its operation, completely remove your foot from the brake pedal.
- When the brake assist system is in use while driving, you may feel the brake pedal attempt to resist, the pedal moves in small motions in conjunction with the operation noise, or the vehicle body and the steering wheel vibrate. This occurs when the brake assist system is operating normally and does not indicate faulty operation. Continue to firmly depress the brake pedal.
- When the active stability & traction control (ASTC) indication lamp is illuminated, the brake assist system may not function.

Anti-lock brake system (ABS)*

E00607100775

Environmental conditions can have an effect on braking. During sudden braking when there is snow, ice, oil, water etc. on the road surface, a skid may occur. In this situation, steering control and braking effectiveness is reduced and the stopping distance is increased. The vehicle may also go into an uncontrolled spin.

The ABS helps prevent the wheels from locking during braking, thus maintaining directional stability, ensuring controllability and providing optimum braking force.

Driving hints

- With ABS fitted, steering during sudden braking (when the ABS functions) differs slightly from when the brakes are not being applied. Steer the vehicle carefully in these conditions.
- Always maintain the same distance from the vehicle in front of you as you would for a vehicle not equipped with ABS. Compared with vehicles not fitted with ABS, your vehicle may require a longer stopping distance in the following cases:
 - Driving on gravel or snow-covered roads.
 - Driving with tyre chains installed.
 - Driving on roads where the road surface is pitted or has other differences in surface height.
 - Driving on bumpy roads or other poor driving surfaces.

Starting and driving

- Operation of ABS is not restricted to situations where brakes are applied suddenly. This system may also operate to prevent wheel lock when you are driving over manholes, steel road-work plates, or the vehicle is driven over steps or level differences in the road, road markings, or other surfaces which are difficult for the wheels to grip.
- When the ABS is activated, you may feel the brake pedal pulsation and hear a characteristic noise. Also at this time, you may feel as if the pedal attempts to resist being depressed. **In this situation, to let the ABS work for you, just hold the brake pedal down more firmly. Do not pump the brake. This pumping will result in reduced braking performance.**

4

⚠ CAUTION

- Even the ABS cannot prevent the natural laws of physics from acting on the vehicle. It cannot for instance avoid accidents that may result from excessive speed on bends or following another vehicle too closely or aquaplaning. It should remain the driver's task to observe safety precautions to judge speeds and brake applications correctly in such conditions.
- Be sure to use tyres of the same type and size on 4 wheels.
If tyre types or sizes are mixed, ABS may not function normally.

⚠ CAUTION

- Never install a limited-slip differential, which is not a MITSUBISHI MOTORS genuine part, as the ABS may not function normally.
We recommend you to consult a MITSUBISHI MOTORS Authorized Service Point.

ABS warning lamp

E00607201164

The ABS warning lamp should illuminate when the ignition switch is turned "ON", and should go off in a few seconds.

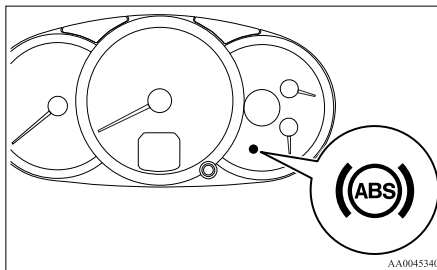

⚠ CAUTION

- If the warning lamp stays on or does not illuminate when you start the vehicle, it indicates that the ABS is not functioning and that only the standard brake system is in operation. (In this condition the standard hydraulic brake system will still function.) We recommend you to have your vehicle inspected as soon as possible.

NOTE

- On vehicles with the rear differential lock, ABS and the active stability & traction control (ASTC) functions are suspended while the rear differential lock is activated. ASTC indication lamp, Active Stability Control function OFF indication lamp, ABS warning lamp and brake warning lamp are illuminated while these functions are suspended. It does not indicate a problem. When the rear differential lock is disengaged, these lamps go out and function again. Refer to "ASTC indication lamp, ASTC OFF indication lamp" on page 4-43.
- On vehicles with rear differential lock, ABS functionality is suspended while the rear differential lock is operating. The ABS warning lamp is illuminated while ABS functionality is suspended. It does not indicate a problem. When the rear differential lock is disengaged, the ABS warning lamp goes off and the ABS functions again. Refer to "Rear differential lock" on page 4-30.

If the warning lamp illuminates while driving

E00607300663

If only the ABS warning lamp illuminates

- Avoid hard braking and high-speed driving. Stop the vehicle in a safe place. Restart the engine and check to see whether the lamp goes out after a few minutes driving; if it then remains off during driving, there is no problem. However, if the lamp does not go out, or if it lights up again when the vehicle is driven, we recommend you to have the vehicle checked as soon as possible.
- The ABS warning lamp can illuminate if the battery voltage is insufficient when the engine is started. In this case, it does not indicate an ABS fault. Charge the battery by allowing the engine to idle for a while. If the battery has been charged but the ABS warning lamp continues to illuminate or illuminates intermittently, have the vehicle inspected.

If the ABS warning lamp and brake warning lamp illuminate at the same time

- The ABS and brake force distribution function may not work, so hard braking could make the vehicle unstable. Avoid hard braking and high-speed driving. Stop the vehicle in a safe place and contact a MITSUBISHI MOTORS Authorized Service Point.

NOTE

- Immediately after the vehicle starts moving after engine start up, a whining sound of a motor will be heard from the engine compartment. If the brake pedal is depressed at that moment, you can feel the brake pedal pulsating. This pulsation is due to the self-diagnosis operation of the ABS and does not indicate a malfunction.
- After driving on snowy roads, remove any snow and ice which may have become adhered to the wheel areas. When doing this, be careful not to damage the wheel speed sensors (A) and cables located at each wheel on vehicles equipped with an ABS.

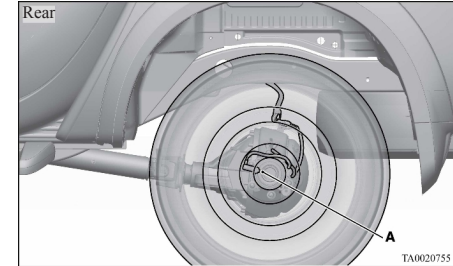
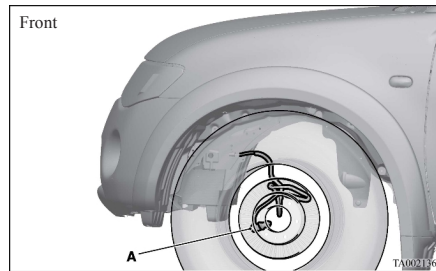

- The ABS becomes operative after the vehicle has accelerated to a speed in excess of approximately 10 km/h (6 mph). It stops operating when the vehicle decelerates to a speed below approximately 7 km/h (4 mph).

Power steering system

E00607400387

The power steering system operates while the engine is running. It helps reduce the effort needed to turn the steering wheel.

The power steering system has mechanical steering capability in case the power assist is lost. If the power assist is lost for some reason, you will still be able to steer your vehicle, but you will notice it takes much more effort to steer. If this happens, have your vehicle inspected at an authorized MITSUBISHI MOTORS service point.

WARNING

- Do not stop the engine while the vehicle is moving. Stopping the engine would make the steering wheel extremely hard to turn, possibly resulting in an accident.

4

CAUTION

- Do not leave the steering wheel turned all the way in one direction. This can cause damage to the power steering system.

Active Stability & Traction Control (ASTC)*

E00616700344

The active stability & traction control (ASTC) takes overall control of the anti-lock brake system, traction control function and Active Stability Control function to help maintain the vehicle's control and traction. Please read this section in conjunction with the page on the anti-lock brake system, traction control function and Active Stability Control function.

Anti-lock brake system (ABS) → p. 4-39
Active Traction Control function → p. 4-43
Active Stability Control function → p. 4-43

CAUTION

- Do not over-rely on the ASTC. This system, like any other system, has limits and cannot help you to maintain traction and control of the vehicle in all circumstances. Reckless driving may lead to accidents. Always drive carefully, taking into account the traffic, road and environmental conditions.
- Be sure to use the same specified type and size of tyre on all 4 wheels. Otherwise, the ASTC may not work correctly.

NOTE

- After your vehicle is driven a short distance after starting the engine, a click is heard from the engine compartment; however, this is only the sound of ASTC being checked.

- Some vibration will be felt in the vehicle body and a whining sound of a motor will be heard from the engine compartment when the ASTC functions. This is a normal result of the ASTC operation, and does not indicate a malfunction.
- The ASTC does not operate while the ABS warning lamp is illuminated.
- On vehicles with the rear differential lock, the ASTC and ABS functions are suspended while the rear differential lock is activated. ASTC indication lamp, ASTC OFF indication lamp and ABS warning lamp are illuminated while these functions are suspended. It does not indicate a problem. When the rear differential lock is disengaged, these lamps go out and function again. Refer to “ABS warning lamp” on page 4-40, “ASTC indication lamp, ASTC OFF indication lamp” on page 4-43.

Driving hints

E0061680039

When extricating the vehicle from mud, sand or fresh snow, you may find that operation of the ASTC prevents the engine speed from increasing in response to depression of the accelerator pedal. If this happens and the vehicle remains stuck as a result, deactivate the ASC function by pressing the “ASC OFF” switch. The vehicle will then be easier to extricate. (Brake control of the ATC function is still working to prevent wheel spins when the ASC function is deactivated by pressing the “ASC OFF” switch.)

Active Stability Control function

E00616900115

The Active Stability Control function is designed to improve the vehicle's stability by restraining its tendency to slip sideways (for example, when rounding a curve in slippery conditions, or when the driver takes rapid steering action to avoid an obstacle). It works by controlling the engine output and brake on each wheel.

NOTE

- On vehicles with rear differential locks, the Active Stability Control function does not operate when the rear differential lock is activated.

“ASC OFF” switch

The Active Stability Control function is automatically activated when the ignition switch is turned to the “ON” position. You can deactivate the system by pressing the “ASC OFF” switch when the vehicle speed is below 40 km/h (25 mph). To reactivate the Active Stability Control function, press the ASC OFF switch again. It is strongly recommended that the Active Stability Control function normally be kept activated.

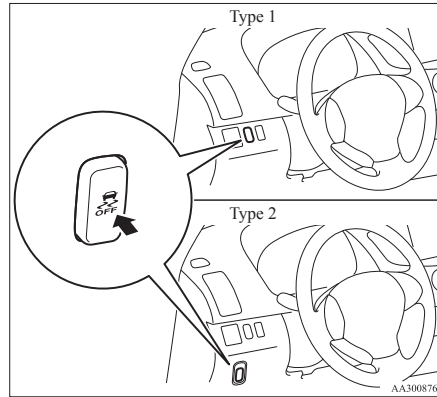

NOTE

- If the vehicle speed increases to about 120 km/h (74 mph) with the Active Stability Control function deactivated, the Active Stability Control function automatically starts operating. To subsequently stop the Active Stability Control function, stop the vehicle and press the ASC OFF switch again.

Active Traction Control function

E00617000025

On slippery surfaces, active traction control function prevents the drive wheels from excessive spinning, thus helping the vehicle to start moving from a stop. It also provides sufficient driving force and steering performance as the vehicle turns at accelerated speeds.

⚠ CAUTION

- When driving a vehicle on a snowy or icy road, be sure to install snow tyres and drive the vehicle at moderate speeds.

ASTC indication lamp, ASTC OFF indication lamp

E00617100114

The Active Stability Control function and active traction control function share the same indication lamp.

The indication lamps should illuminate when the ignition switch is turned to the “ON” position and should go off after a few seconds.

If the indication lamps stay on or do not illuminate when the ignition switch is turned to the “ON” position, we recommend you to have your vehicle inspected as soon as possible.

⚠ indication lamp blinks when the Active Stability Control function or active traction control function is operating.

Starting and driving

⚠ indication lamp is illuminated when the Active Stability Control function is OFF.

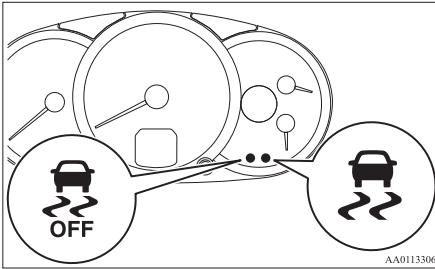

⚠ CAUTION

- When ⚠ indication lamp blinks, Active Stability Control function or active traction control function is operating, which means that the road is slippery or that your vehicle's wheels are slipping excessively. If this happens, drive slower with less accelerator input.
- If an abnormal condition occurs in the system while driving, the ⚠ indication lamp will illuminate.
In these cases, follow these procedures:

⚠ CAUTION

- If the temperature in the braking system continues to increase due to continuous brake control on a slippery road surface, the ⚠ indication lamp will illuminate, and operation of the Active Stability Control function and active traction control function will be suspended to protect the brake system. (Normal operation of the vehicle will not be affected.) Park your vehicle in a safe place. When the temperature in the braking system has come down, the ⚠ indication lamp will go off and the Active Stability Control function and active traction control function will start operating again.
- If the ⚠ indication lamp does not go out even though the above procedure is followed, there could be a problem in the system.
Stop the engine and start the engine again and check whether the ⚠ indication lamp goes out. If the indication lamp goes out, there is no abnormal condition.
If the ⚠ indication lamp illuminates even after your vehicle is driven a short distance after restarting the engine, we recommend you to have your vehicle checked as soon as possible.

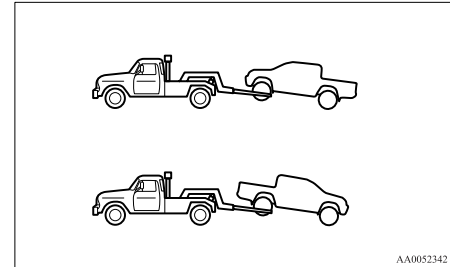

⚠ CAUTION

- If the vehicle is towed with the ignition switch in the "ON" position and only the front wheels or only the rear wheels raised off the ground, the ASTC may operate, resulting in an accident. When towing the vehicle with the front wheels raised, keep the ignition switch in the "LOCK" or "ACC" position. When towing the vehicle with the rear wheels raised, keep the ignition switch in the "ACC" position.
Refer to "Towing" on page 6-20.

Cruise control*

E00609100779

Cruise control is an automatic speed control system that keeps a set speed. It can be activated at about 40 km/h (25 mph) or more.

CAUTION

- When you do not wish to drive at a set speed, turn off the cruise control for safety.
- Do not use cruise control when driving conditions will not allow you to stay at the same speed, such as in heavy traffic or on roads that are winding, icy, snow-covered, wet, slippery, on a steep downhill slope.
- On vehicles with manual transmission, do not move the gearshift lever to the “N” (Neutral) position while driving at a set speed without depressing the clutch pedal. The engine will run too fast and might be damaged.

NOTE

- Cruise control may not be able to keep your speed on uphills or downhills.
- Your speed may decrease on a steep uphill. You may use the accelerator pedal if you want to stay at your set speed.
- Your speed may increase to more than the set speed on a steep downhill. You must use the brake to control your speed. As a result, the set speed driving is deactivated.

Cruise control switches

E00624100103

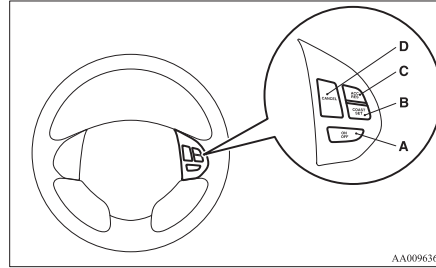

AA0096368

A- “ON OFF” switch

Used to turn on and off the cruise control.

B- “COAST SET” switch

Used to reduce the set speed and to set the desired speed.

C- “ACC RES” switch

Used to increase the set speed and to return to the original set speed.

D- “CANCEL” switch

Used to deactivate the set speed driving.

NOTE

- When operating the cruise control switches, press the cruise control switches correctly. The set speed driving may be deactivated automatically if two or more switches of the cruise control are pressed at the same time.

To activate

E00609300771

1. With the ignition switch in the “ON” position, press the “ON OFF” switch (A) to turn on the cruise control. The “CRUISE” indication lamp in the meter cluster will come on.

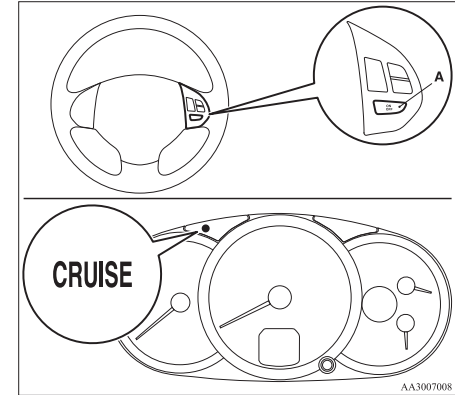

AA3007008

NOTE

- If the cruise control is on when the ignition switch is turned to the “LOCK” or “ACC” position, cruise control will be on automatically the next time you start the engine. The “CRUISE” indication lamp will also be on.
- If the battery voltage is insufficient, the memory data for the cruise control may be erased. As a result, the “CRUISE” indication lamp may not come on when you restart the engine. If this happens, press the “ON OFF” switch once again to turn on the cruise control.

Starting and driving

2. Accelerate or decelerate to your desired speed, then press and release the “COAST SET” switch (B) when the “CRUISE” indication lamp is illuminated. The vehicle will then maintain the desired speed.

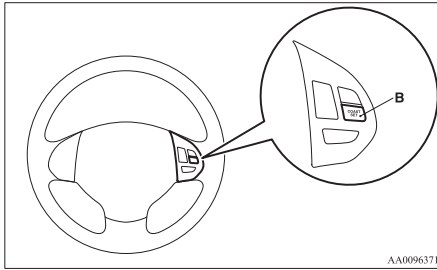

4

NOTE

- When you release the “COAST SET” switch, the vehicle speed will be set.

To increase the set speed

E00609400570

There are 2 ways to increase the set speed.

“ACC RES” switch

Press and hold the “ACC RES” switch (C) while driving at the set speed, and your speed will then gradually increase.

When you reach your desired speed, release the switch. Your new cruising speed is now set.

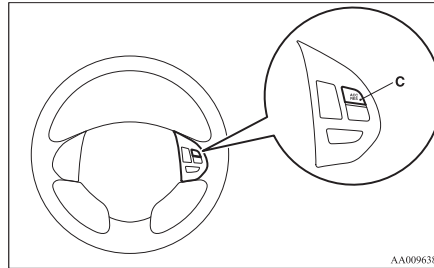

To increase your speed in small amounts, press the “ACC RES” switch for less than about 1 second and release it. Each time you press the “ACC RES” switch, your vehicle will go about 1.6 km/h (1 mph) faster.

Accelerator pedal

While driving at the set speed, use the accelerator pedal to reach your desired speed and then press the “COAST SET” switch (B) and release the switch momentarily to set a new desired cruising speed.

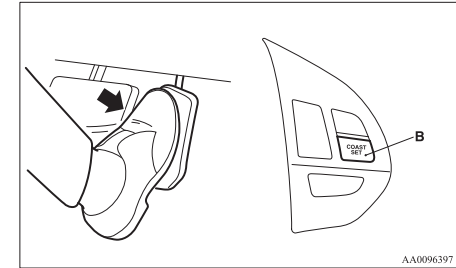

To decrease the set speed

E00609500500

There are 2 ways to decrease the set speed.

“COAST SET” switch

Press and hold the “COAST SET” switch (B) while driving at the set speed, and your speed will slow down gradually.

When you reach your desired speed, release the switch. Your new cruising speed is now set.

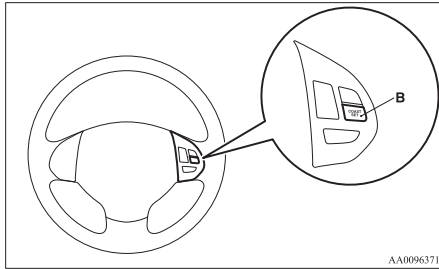

To slow down your speed in small amounts, press the “COAST SET” switch for less than about 1 second and release it.

Each time you press the “COAST SET” switch, your vehicle will slow down by about 1.6 km/h (1 mph).

Brake pedal

While driving at the set speed, use the brake pedal, which disengages the cruise control, then press the “COAST SET” switch (B) and release the switch momentarily to set a new desired cruising speed.

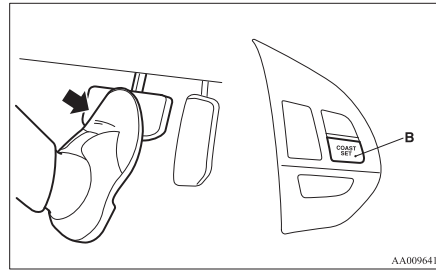

To temporarily increase or decrease the speed

E00619500154

To temporarily increase the speed

Depress the accelerator pedal as you would normally. When you release the pedal, you will return to your set speed.

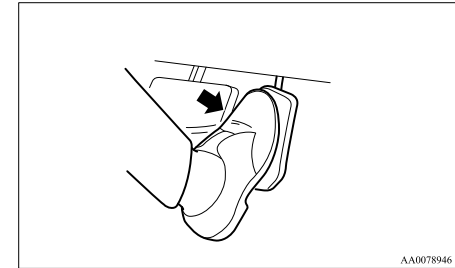

To temporarily decrease the speed

Depress the brake pedal to decrease the speed. To return to the previously set speed, press the “ACC RES” switch (C).

Refer to “To resume the set speed” on page 4-48.

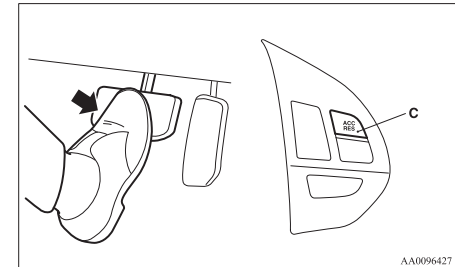

Starting and driving

To deactivate

E00609701088

The set speed driving can be deactivated as follows:

- Press the “ON OFF” switch (A). (Cruise control will be turned off.)
- Press the “CANCEL” switch (D).
- Depress the brake pedal.

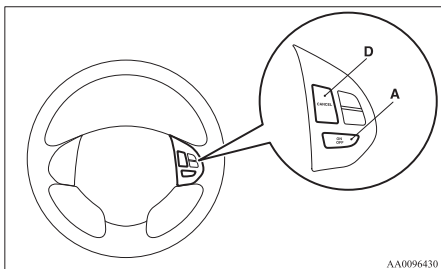

4

The set speed driving is deactivated automatically in any of the following ways.

- When you depress the clutch pedal (on vehicles with M/T).
- When your speed slows to about 15 km/h (9 mph) or more below the set speed because of a hill, etc.
- When your speed slows to about 40 km/h (25 mph) or less.
- When the active stability & traction control (ASTC) starts operating. (if so equipped) Refer to “Active Stability & Traction Control (ASTC)” on page 4-42.

⚠ WARNING

- **On vehicles with A/T, although, the set speed driving will be deactivated when shifting to the “N” (NEUTRAL) position, never move the selector lever to the “N” (NEUTRAL) position while driving. You would have no engine braking and could cause a serious accident.**

Also, the set speed driving may be deactivated as follows:

- When the engine speed rises and approaches the tachometer's red zone (the red-coloured part of the tachometer dial).

⚠ CAUTION

- **When the set speed driving is deactivated automatically in any situation other than those listed above, there may be a system malfunction. Press the “ON-OFF” switch to turn off the cruise control and have it inspected by a MITSUBISHI MOTORS Authorized Service Point.**

To resume the set speed

E00609800561

If the set speed driving is deactivated by the condition described in “To deactivate” on page 4-48, you can resume the previously set speed by pressing the “ACC RES” switch (C) while driving at a speed of about 40 km/h (25 mph) or higher.

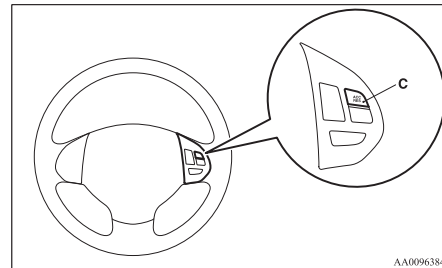

Under either of the following conditions, however, using the switch does not allow you to resume the previously set speed. In these situations, repeat the speed setting procedure:

- The “ON OFF” switch is pressed.
- The ignition switch is turned OFF.
- “CRUISE” indication lamp is turned OFF.

Cargo loads

E00609901123

Cargo loads precautions

CAUTION

- When loading luggage, be careful to the following.
 - Stow cargo and luggage in the cargo area whenever possible.
 - Distribute cargo or luggage evenly not to be unbalanced in weight.
 - Do not place cargo or luggage on the instrument panel.

Also, do not stack up cargo or luggage on the front passenger's seat or the rear seat.

Having the driver's vision blocked, and your cargo being thrown inside the cabin if you suddenly have to brake can cause a serious accident or injury.

Trailer towing

E0061000677

In order to tow a trailer with your vehicle, when having a trailer towing device mounted that meets all relevant regulations in your area, consult a MITSUBISHI MOTORS Authorized Service Point. The regulations concerning the towing of a trailer may differ from country to country. You are advised to obey the regulations in each area.

CAUTION

- **Danger of Accident!**
A towing bar should be fitted according to MITSUBISHI MOTORS guidelines.

NOTE

- If you are going to tow a trailer, pay careful attention to the following points.

Maximum towable weight with brake and maximum trailer-nose weight

Never exceed the maximum towable weight with brake and the maximum trailer-nose weight as listed in the specifications. (Refer to "Vehicle weight" on page 9-10.)

If you tow a trailer at an altitude of more than 1,000 m above sea-level, reduce your weight by 10 % of the gross combination weight for every increase of 1,000 m above sea-level, as the engine output is lowered owing to decrease in atmospheric pressure.

Towing bar mounting specifications

See the following table for fixing points (A) for the towing bar.

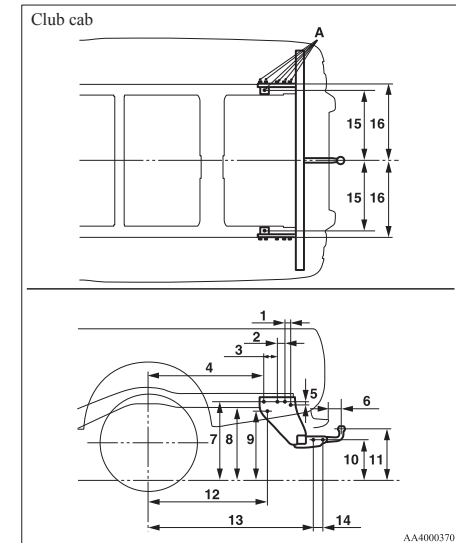

Starting and driving

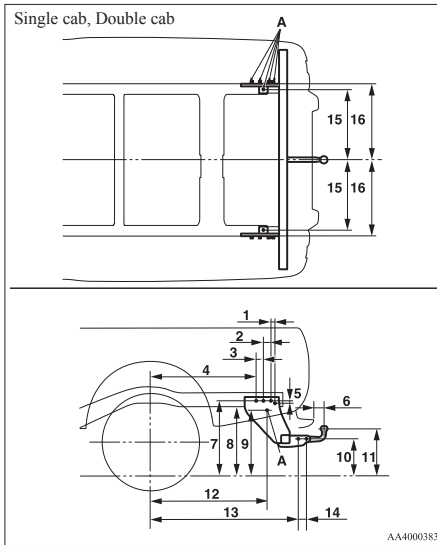

4

	Club cab	Single cab, Double cab (Vehicles without long bed)	Double cab (Vehicles with long bed)
1	30 mm	30 mm	30 mm
2	55 mm	55 mm	55 mm
3	115 mm	60 mm	60 mm
4	872 mm	812 mm	812 mm
5	20 mm	20 mm	20 mm
6	85 mm	85 mm	85 mm
7	687 - 698 mm	681 - 690 mm, 579 - 581 mm*	681 - 682 mm, 576 mm*
8	642 - 653 mm	639 - 649 mm, 537 - 539 mm*	639 - 640 mm, 534 mm*
9	612 - 623 mm	609 - 619 mm, 507 - 509 mm*	609 - 610 mm, 504 mm*
10	406 - 418 mm	399 - 410 mm, 292 - 294 mm*	395 - 413 mm, 302 mm*
11	486 - 499 mm	479 - 491 mm, 486 - 488 mm*	475 - 493 mm, 486 mm*
12	897 mm	897 mm	897 mm
13	1,251 mm	1,136 mm	1,316 mm
14	70 mm	70 mm	70 mm
15	502.5 mm	502.5 mm	502.5 mm
16	540.5 mm	540.5 mm	540.5 mm

Item 7, 8, 9, 10, 11: at kerb weight

*: 2WD vehicles with 15 inch tyres

NOTE

- The values under item 7, 8, 9, 10, 11 are applicable to unladen vehicles. These values can also be varied depending on the tyre size, optional equipment and suspension conditions.

Operating hints

- Do not let the clutch slip (vehicles with a M/a only) and do not increase the engine speed more than necessary when starting.
- Be sure that the driving speed does not exceed the maximum speed for trailer operation.
- To prevent shocks from the overrun brake, depress the brake pedal lightly at first and then more strongly.

- To make full use of engine braking, change to a lower gear before descending a slope.
- The body, brakes, clutch, and chassis will be under additional strain when towing a trailer.
- The heavier weight and higher rolling and air resistance will increase fuel consumption.

Starting and driving

Additional precautions for vehicles equipped with an automatic transmission

The 2nd gear (in “Sports mode”) is recommended on slopes or at low speed. Use the 1st gear (in “Sports mode”) in mountainous areas in order to make better use of engine braking and to assist the brake system. However, be sure that the speed does not exceed the maximum speed limit for the selected gear.

For pleasant driving

Ventilators.....	5-02
Heater/Manual air conditioning*.....	5-03
Automatic air conditioning*.....	5-08
Important operation tips for the air conditioning.....	5-12
Air purifier*.....	5-12
LW/MW/FM electronic tuning radio with CD player*.....	5-13
To play tracks from USB device*.....	5-28
To play tracks from a Bluetooth® device (vehicles with Bluetooth® 2.0 interface).....	5-37
To use the external audio input function*.....	5-40
Steering wheel remote control switch*.....	5-41
Error codes.....	5-43
Error codes (iPod).....	5-45
Error codes (USB memory device).....	5-47
Audio system anti-theft feature.....	5-49
Handling of compact discs.....	5-49
Antenna.....	5-51
Link System*.....	5-52
Bluetooth® 2.0 interface.....	5-52
USB input terminal*.....	5-68
Sun visors.....	5-70
Vanity mirror*.....	5-71
Ashtray.....	5-71
Cigarette lighter.....	5-72
Accessory socket*.....	5-73
Digital clock*.....	5-74
Interior lamps.....	5-74
Storage spaces.....	5-76
Cup holder*.....	5-79
Bottle holder.....	5-80

Convenient hook.....	5-80
Coat hook*.....	5-81
First-aid kit and warning triangle securing bands*.....	5-81

For pleasant driving

Ventilators

E00700100344

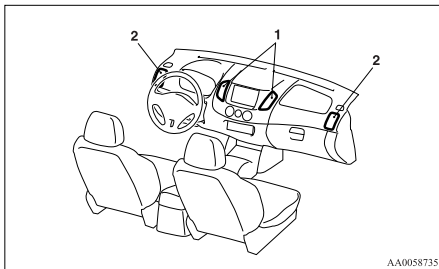

AA0058735

- 1- Centre ventilators
- 2- Side ventilators

Air flow and direction adjustments

E00700200749

Centre ventilators

Adjust the direction of the air flow by moving the knob (A).

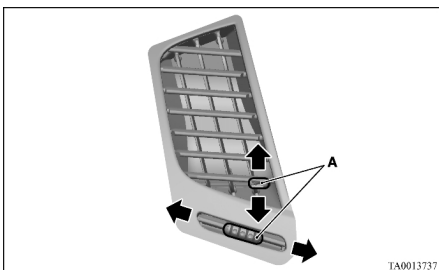

TA0013737

Side ventilators

The ventilator can be opened and closed with the dial (B).

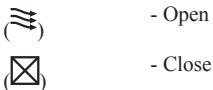

Adjust the direction of the air flow by moving the knob (C).

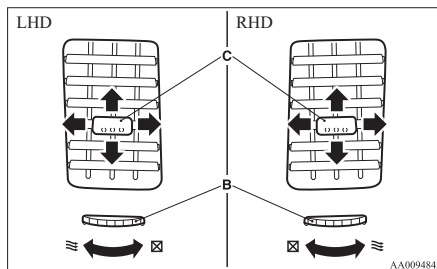

AA0094843

NOTE

- On air conditioned vehicles, the cool air from the ventilators may appear as a mist. This is due to moist air being suddenly cooled by the air conditioning. This will clear after a few moments.

Changing the mode selection

E00700301008

To change the position and amount of air flowing from the ventilators, turn the mode selection dial. (Refer to "Mode selection dial" on pages 5-04, 5-09.)

These symbols are used in the next several illustrations to demonstrate the quantity of air coming from the ventilators.

- : Small amount of air from the ventilators
- ➔: Medium amount of air from the ventilators
- ➔➔: Large amount of air from the ventilators

Face position

Air flows only to the upper part of the passenger compartment.

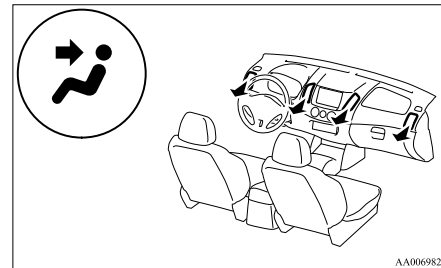

AA0069823

Foot/Face position

Air flows to the upper part of the passenger compartment, and flows to the leg area.

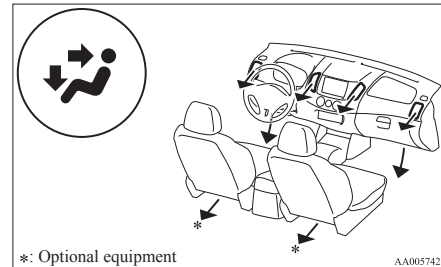

*: Optional equipment

AA0057422

NOTE

- With the mode selection dial between the “

Foot position

Air flows mainly to the leg area.

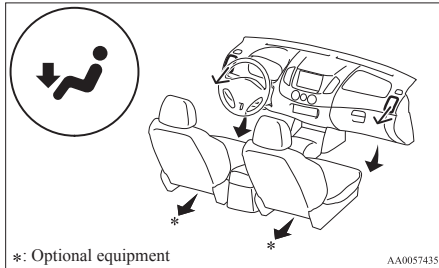

Foot/Demister position

Air flows to the leg area, the windscreen and the door windows.

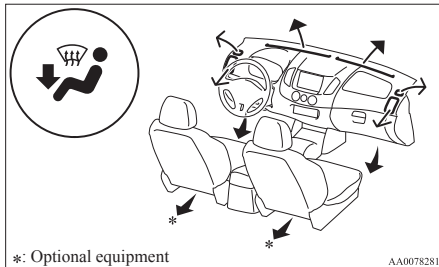

NOTE

- With the mode selection dial between the “

Demister position

Air flows mainly to the windscreen and the door windows.

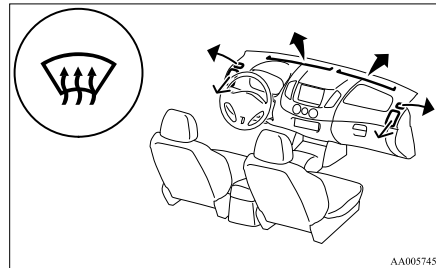

Heater/Manual air conditioning*

E00700500410

The heater/air conditioning can only be used while the engine is running.

Control panel

E00700600512

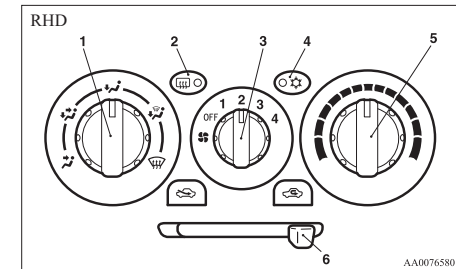
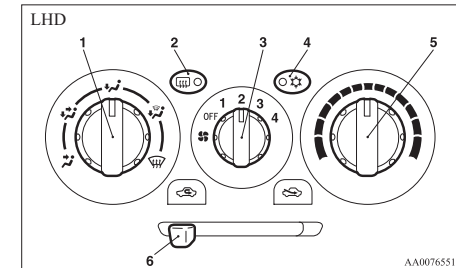

- 1- Mode selection dial
- 2- Rear window demister switch → p. 3-39
- 3- Blower speed selection dial
- 4- Air conditioning switch*
- 5- Temperature control dial
- 6- Air selection lever

For pleasant driving

Blower speed selection dial

E00700700119

Select the blower speed by turning the blower speed selection dial clockwise or anticlockwise. The blower speed will gradually increase as the dial is turned to the right. When the blower speed selection dial is set to the "OFF" position, all fan-driven airflow will stop.

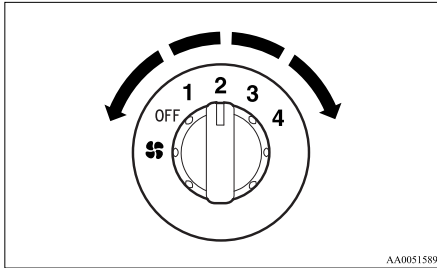

Temperature control dial

E00700900209

Turn the temperature control dial clockwise to make the air warmer. Turn it anticlockwise to make the air cooler.

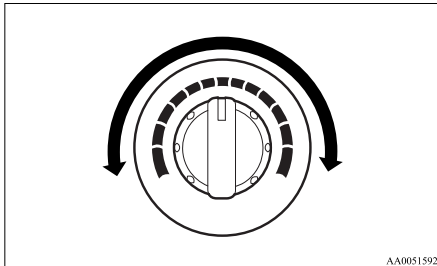

NOTE

- While the engine coolant temperature is low, the temperature of the air from the heater will be cool/cold until the engine warms up, even if you have selected warm air with the dial.

Mode selection dial

E00701100266

To change the position and amount of air flowing from the ventilators, turn the mode selection dial. (Refer to "Changing the mode selection" on page 5-02.)

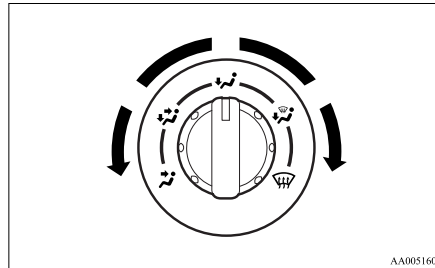

Air selection lever

E00701300460



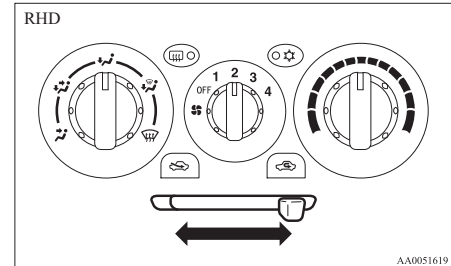
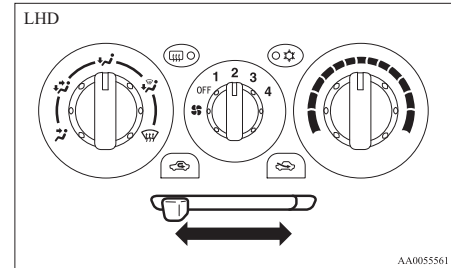

To change the air selection, use the air selection lever.

- "Outside air" icon: Outside air is introduced into the passenger compartment.
- "Recirculated air" icon: Recirculated air.

Air is recirculated inside the passenger compartment.



CAUTION

- Normally, use the “” (outside) position to keep the windscreen and side windows clear and quickly remove fog or frost from the windscreen. If high cooling performance is desired, or if the outside air is dusty or otherwise contaminated, use the “” (recirculation) position. Set the air selection lever to the “” (outside) position periodically to increase ventilation so that the windows do not become fogged up.
- Use of the “” (recirculation) position for extended time may cause the windows to fog up.

*Air conditioning switch**

E00701500781

Push the switch, and the air conditioning compressor will turn on. The air conditioning indication lamp (A) will come on.

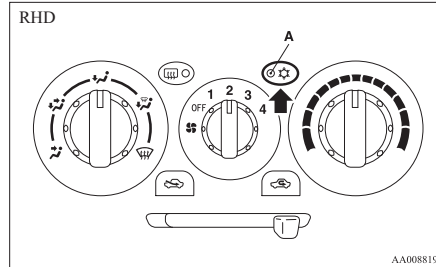
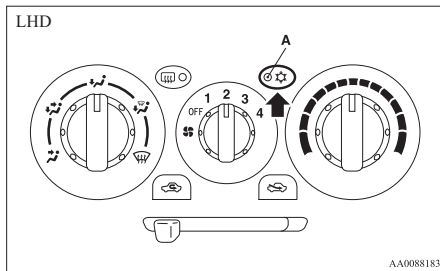

Push the switch again and the air conditioning compressor will stop and the indication lamp goes off.



CAUTION

- When using the air conditioning, the idling speed may slightly increase as the air conditioning compressor is switched on/off automatically. While the vehicle with an A/T is stationary, fully depress the brake pedal to prevent the vehicle from creeping.

Operating the air conditioning system

E00701800247

Heating

Set the mode selection dial to the “” position and set the air selection lever to the “” (outside) position.

Turn the temperature control dial clockwise or anti-clockwise to the desired temperature. Select the desired blower speed.

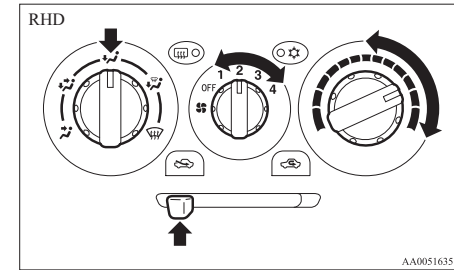
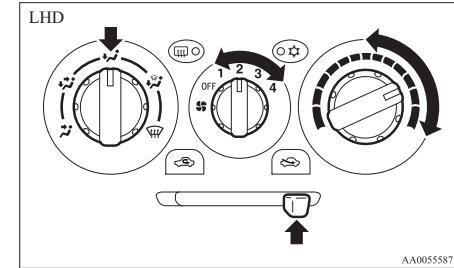

NOTE

- For maximum heat, set the blower speed at the 3rd position.

For pleasant driving

Cooling (vehicles with air conditioning)

E00701900424

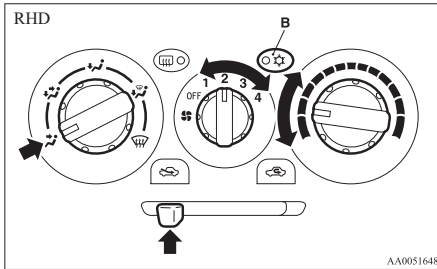
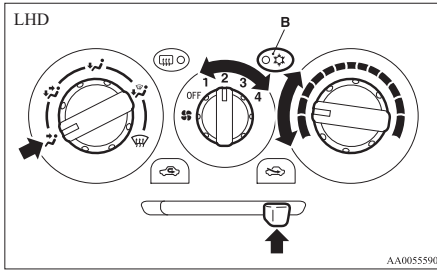

1. Set the mode selection dial to the "outside" position.
2. Set the air selection lever to the "outside" position.
3. Push the air conditioning switch (B).
4. Change the temperature by turning the control dial clockwise or anticlockwise.
5. Select the desired blower speed.

CAUTION

- If the outside air is dusty or otherwise contaminated, or if high cooling performance is desired, set air selection lever to the "recirculation" position and the temperature control dial all the way to the left. Set to the "outside" position periodically to increase ventilation so that the windows do not become fogged up.

Combination of unheated air and heated air

E00702000451

Select the mode selection dial to the position shown in the illustration and set the air selection lever to the "outside" position. The air flow will be directed to the leg area and the upper part of the passenger compartment. Select the desired blower speed.

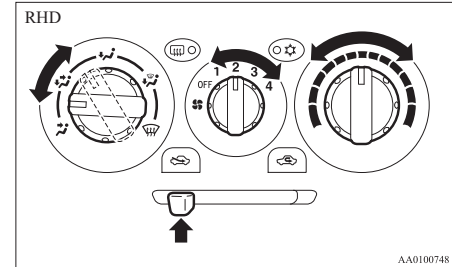
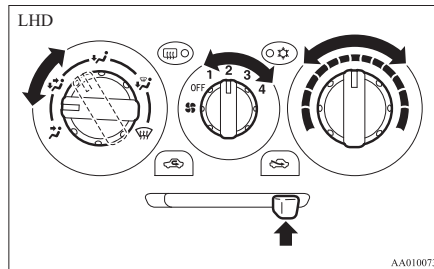

Warm air flows to the leg area and unheated or slightly warm air (depending upon temperature setting) flows to the upper part of the passenger compartment.

Demisting of the windscreen and door windows

E00702100579

CAUTION

- For safety, make sure you have a clear view through all the windows.

To remove frost or mist from the windscreen and door windows, use the mode selection dial ("windscreen" or "door windows").

For ordinary demisting

Use this setting to keep the windscreen and door windows clear of mist, and to keep the leg area heated (when driving in rain or snow).

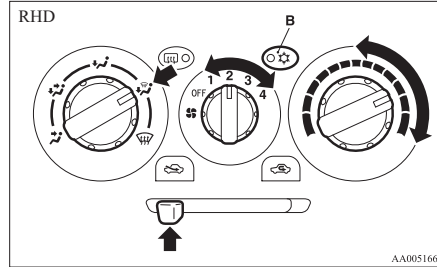
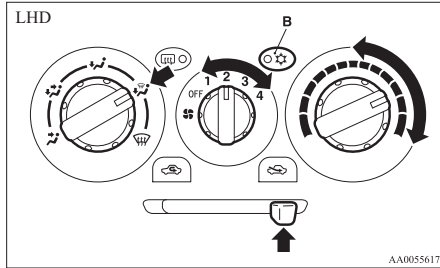

1. Set the air selection lever to the “” (outside) position.
2. Set the mode selection dial to the “” position.
3. Select your desired blower speed by turning the blower speed selection dial.
4. Select your desired temperature by turning the temperature control dial.
5. Push the air conditioning switch (B).
(vehicles with air conditioning)

For quick demisting

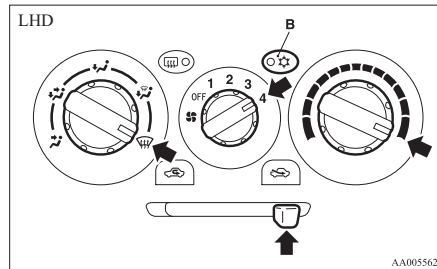

For pleasant driving

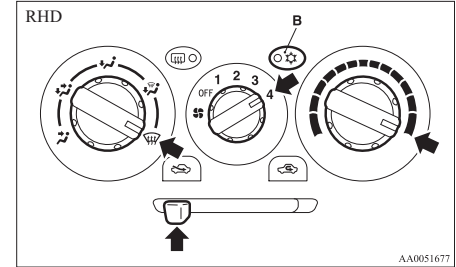

1. Set the air selection lever to the “” (outside) position.
2. Set the mode selection dial to the “” position.
3. Set the blower to the maximum speed.
4. Set the temperature to the maximum temperature position.
5. Push the air conditioning switch (B).
(vehicles with air conditioning)

NOTE

- To demist effectively, direct the air flow from the side ventilators towards the door windows.
- Do not set the temperature control dial to the max. cool position. Cool air will blow against the window glasses and form mist on them.

For pleasant driving

Introduction of outside air

E00702200235

To introduce air into the vehicle during hot weather, set the air selection lever to the “” (outside) position and set the temperature control dial to the positions shown in the illustration. Be sure to set the temperature control dial all the way to the left. Select the desired blower speed.

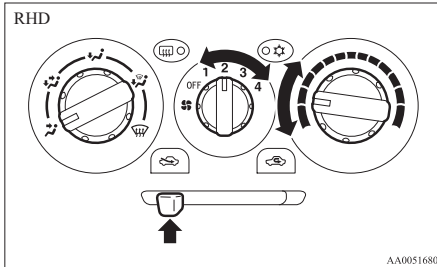
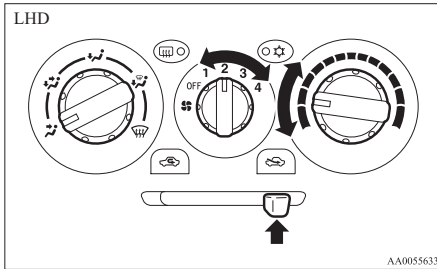

NOTE

- Turn the mode selection dial clockwise and air will flow to the leg area and the windscreen.

Automatic air conditioning*

E00702400110

The air conditioning can only be used while the engine is running.

Control panel

E00702501192

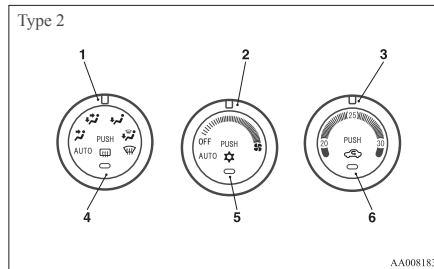
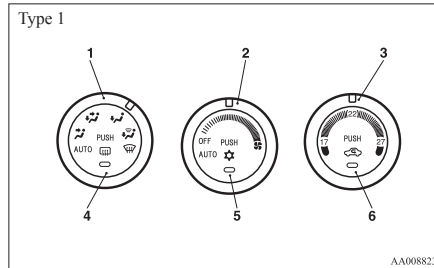

- 1- Mode selection dial
- 2- Blower speed selection dial
- 3- Temperature control dial
- 4- Rear window demister switch → p. 3-39
- 5- Air conditioning switch
- 6- Air selection switch

NOTE

- There is an interior air temperature sensor (A) in the illustrated position. Never place anything on top of the sensor, since doing so will prevent it from functioning properly.

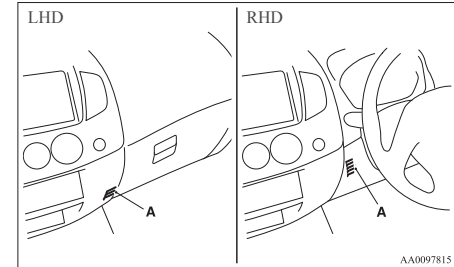

Blower speed selection dial

E00702800273

Select the blower speed by turning the blower speed selection dial clockwise or anticlockwise. The blower speed will gradually increase as the dial is turned to the right.

When the blower speed selection dial is set to the “OFF” position, all fan-driven airflow will stop.

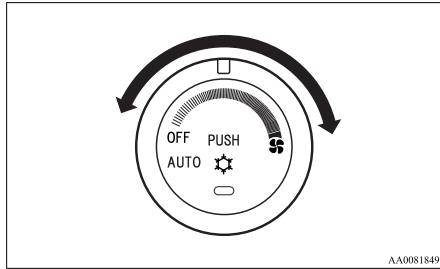

Temperature control dial

E00703000575

Turn the temperature control dial clockwise to make the air warmer. Turn it anticlockwise to make the air cooler.

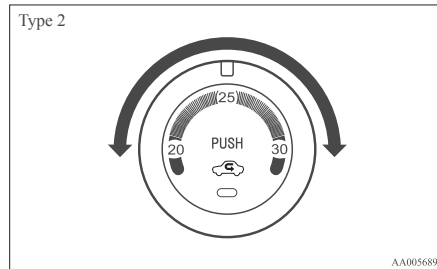
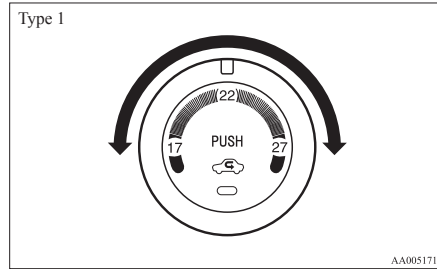

NOTE

- While the engine coolant temperature is low, the temperature of the air from the heater will be cool/cold until the engine warms up, even if you have selected warm air with the dial.

Mode selection dial

E00703200274

To change the position and amount of air flowing from the ventilators, turn the mode selection dial. (Refer to “Changing the mode selection” on page 5-02.)

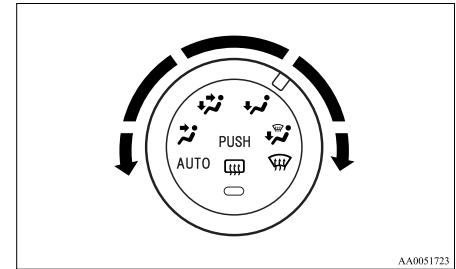

Air selection switch

E00703400638

To change the air selection, simply press the air selection switch.

- Outside air {Indication lamp (A) is OFF}
 Outside air is introduced into the passenger compartment.

For pleasant driving

- Recirculated air {Indication lamp (A) is ON}
Air is recirculated inside the passenger compartment.

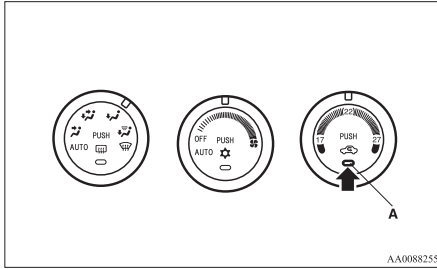

⚠ CAUTION

- Normally, use the outside position to keep the windscreen and side windows clear and quickly remove fog or frost from the windscreen. If high cooling performance is desired, or if the outside air is dusty or otherwise contaminated use the recirculation position. Switch to the outside position periodically to increase ventilation so that the windows do not become fogged up.
- Use of the recirculation position for extended time may cause the windows to fog up.

Air conditioning switch

E00703501128

Push the switch, and the air conditioning compressor will turn on. The air conditioning indication lamp (A) will come on.

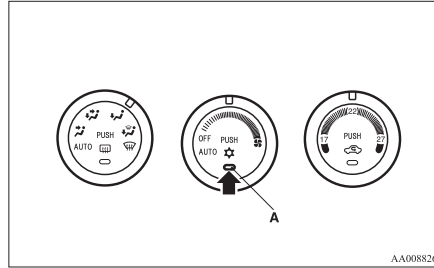

Push the switch again, and the air conditioning compressor will stop and the indication lamp goes off.

⚠ CAUTION

- When using the air conditioning, the idling speed may slightly increase as the air conditioning compressor is switched on/off automatically. While the vehicle with an A/T is stationary, fully depress the brake pedal to prevent the vehicle from creeping.

Operating the system in automatic mode

E00704100919

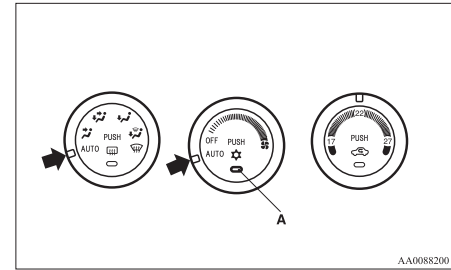

In normal conditions, use the system in the AUTO mode and follow these procedures:

1. Set the blower speed selection dial to the “AUTO” position.
2. Select the temperature control dial to the desired temperature. The temperature can be set within a range of 17 to 27 (Type 1) or 20 to 30 (Type 2). The temperature will gradually increase as the dial is turned to the right.
3. Set the mode selection dial to the “AUTO” position.
4. Push the air conditioning switch to operate the air conditioning. When the air conditioning operates, the indication lamp (A) in the dial will come on.

The outlet port (except “”) and blower speed, and ON/OFF of air conditioning will be controlled automatically.

NOTE

- Set the temperature at about 22 (Type 1) or 25 (Type 2) under normal conditions.
- When the temperature is set to the highest or the lowest setting under the AUTO operation, the air selection, mode selection, blower speed and the air conditioning will be automatically changed as follows.

Also, if manually operated after an automatic changeover, manual operation will be selected.

- Quick Heating (When the temperature is set to the highest setting)
Outside air will be introduced, the air flow will select foot position, and the air conditioning will stop.
- Quick Cooling (When the temperature is set to the lowest setting)
Inside air will be recirculated, the air flow will select face position, and the air conditioning will operate.

Operating the system in manual mode

E00704200040

Blower speed and ventilator mode may be controlled manually by setting the blower speed selection dial and the mode selection dial to the desired positions. To return to automatic operation, set the dials to the "AUTO" position.

Demisting of the windscreen and door windows

E00704300689

CAUTION

- For safety, make sure you have a clear view through all the windows.

To remove frost or mist from the windscreen and door windows, use the mode selection dial ("☀️") or ("❄️").

For ordinary demisting

Use this setting to keep the windscreen and door windows clear of mist, and to keep the leg area heated (when driving in rain or snow).

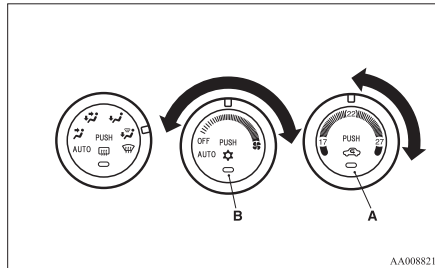

1. Set the air selection switch (A) to the outside position.
2. Set the mode selection dial to the "☀️" position.
3. Select your desired blower speed by turning the blower speed selection dial.
4. Select your desired temperature by turning the temperature control dial.
5. Push the air conditioning switch (B).

For quick demisting

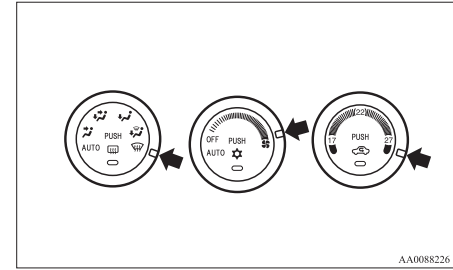

1. Set the mode selection dial to the "☀️" position.
2. Set the blower to the maximum speed.
3. Set the temperature to the highest position.

NOTE

- While the mode selection dial is set to the "☀️" position, the air conditioning will operate automatically and the outside air position will also be selected automatically.
- To demist effectively, direct the air flow from the side ventilators towards the door windows.
- Do not set the temperature control dial to the max. cool position. Cool air will blow against the window glasses and form mist on them.

For pleasant driving

Important operation tips for the air conditioning

E00708300951

- Park the vehicle in the shade.
Parking in the hot sun will make the vehicle inside extremely hot, and it will require more time to cool the interior.
If it is necessary to park in the sun, open the windows for the first few minutes of air conditioning operation to expel the hot air.
- Close the windows when the air conditioning is in use. The entry of outside air through open windows will reduce the cooling efficiency.
- Too much cooling is not good for the health. The inside air temperature should only be 5 to 6 °C below the outside air temperature.
- When operating the system, make sure the air intake, which is located in front of the windscreen, is free of obstructions such as leaves and snow. Leaves collected in the air-intake plenum may reduce air flow and plug the plenum water drains.

It is recommended that the refrigerant be recovered and recycled for further use.

During a long period of disuse

The air conditioning should be operated for at least five minutes each week, even in cold weather. This is to prevent poor lubrication of the compressor internal parts and to maintain the air conditioning in the best operating condition.

Air purifier*

E00708400675

An air filter has been incorporated into this air conditioning so that dirt and dust are cleaned from the air.

Replace the air filter periodically as its ability to clean the air will be reduced as it collects pollen and dirt. For the maintenance interval, refer to the “SERVICE BOOKLET”.

NOTE

- Operation in certain conditions such as driving on a dusty road and frequent use of the air conditioning can lead to reduction of service life of the filter. When you feel that the air flow is lower than normal or when the windscreen or windows start to fog up easily, replace the air filter.

We recommend you to have it checked.

Air conditioning system refrigerant and lubricant recommendations

If the air conditioning seems less effective than usual, the cause might be a refrigerant leak. We recommend you to have the system inspected.

The air conditioning system in your vehicle must be charged with the refrigerant HFC-134a and the lubricant ZXL-100PG.

Use of any other refrigerant or lubricant will cause severe damage which will result in the need to replace your vehicle’s entire air conditioning system. The release of refrigerant into the atmosphere should be prevented.

LW/MW/FM electronic tuning radio with CD player*

E00708501745

The audio system can be used when the ignition switch is in the “ON” or “ACC” position.

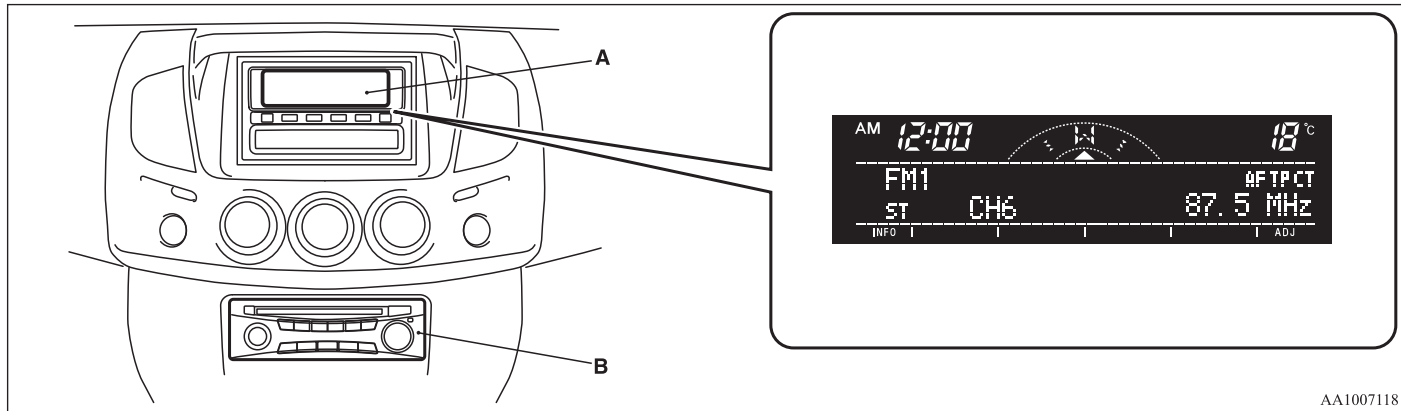

AA1007118

A- Display window

B- Audio system

NOTE

- To listen to the audio system while the engine is stopped, turn the ignition key to the “ACC” position.
- If a cellular phone is used inside the vehicle, it may create noise from the audio equipment. This does not mean that anything is wrong with your audio equipment. In such a case, use the cellular phone at a place as far away as possible from the audio equipment.
- If foreign objects or water get into the audio equipment, or if smoke or a strange odour comes from it, immediately turn off the audio system. We recommend you to have it checked. Never try to repair it by yourself. Avoid continuous usage without inspection by a qualified person.
- The audio system’s control knob can be removed to deter thieves. For details, refer to “Audio system anti-theft feature” on page 5-49.
- The audio amplifier (if so equipped) is located under the front right seat.
Do not subject the amplifier to a strong impact.
It could damage the amplifier or malfunctioning could result.

Volume and tone control panel

E00708601140

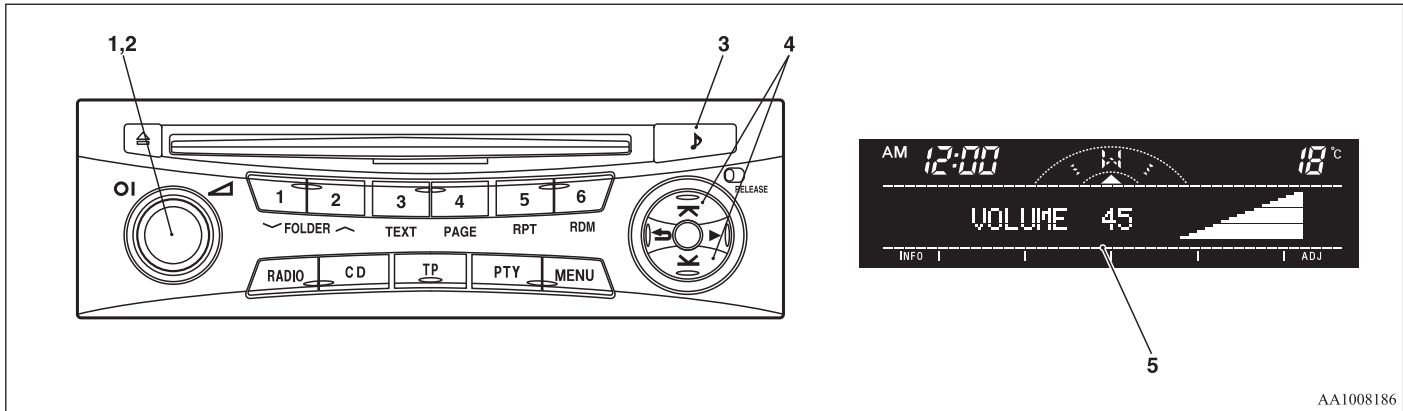

- 1- PWR (On-Off) switch
- 2- VOL (Volume control) knob
- 3- (Mode change) button
- 4- Audio adjust button
- 5- Display

5

AA1008186

To adjust the volume

E00708700665

VOL (Volume control)

Turn the VOL knob (2) clockwise to increase the volume; anticlockwise to decrease the volume. The status will be displayed in the display (5).

To adjust the tone

E00708801269

Press the **▶** button (3) to select BASS → TREBLE → FADER → BALANCE → SCV → Audio adjust mode off. The status will be displayed in the display (5).

BASS (Bass tone control)

Press the audio adjust button (4) either **⏪** or **⏩** to select the desired bass level.

TREBLE (Treble tone control)

Press the audio adjust button (4) either **⏪** or **⏩** to select the desired treble level.

FADER (Front/Rear balance control)

Press the audio adjust button (4) either **⏪** or **⏩** to balance the volume of sound from the front and the rear speakers.

BALANCE (Left/Right balance control)

Press the audio adjust button (4) either **⏪** or **⏩** to balance the volume of sound from the left and the right speakers.

SCV (Speed Compensated Volume) function

The Speed Compensated Volume function is a feature that automatically adjusts the VOL, BASS, MID, and TREBLE settings in accordance with the vehicle speed.

The effects of the SCV function can be selected either of three levels (LOW, MID and HIGH). Select the degree of your choice by pressing the audio adjust button (4) either **⏪** or **⏩**. If you want to stop the SCV function, select the OFF.

NOTE

- Audio adjust mode will be cancelled when another mode is selected or no adjustment is performed for more than 10 seconds.

Radio control panel and display

E00708901228

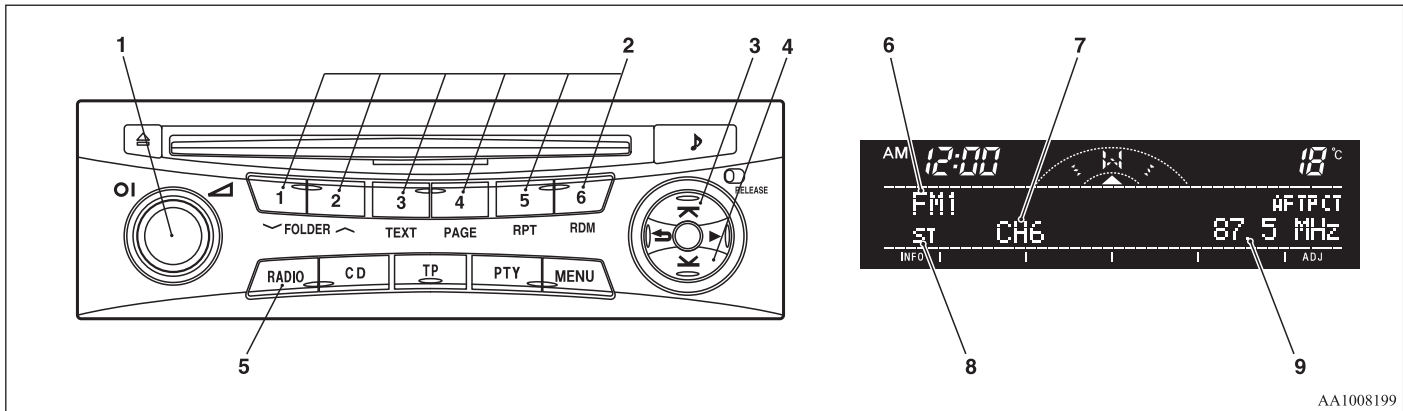

AA1008199

5

- 1- PWR (On-Off) switch
- 2- Memory select buttons
- 3- TUNE/SEEK (Up-step/Up-seek) button
- 4- TUNE/SEEK (Down-step/Down-seek) button
- 5- RADIO (FM/MW/LW selection) button
- 6- FM/MW/LW indicator
- 7- Preset memory number display
- 8- ST (Stereo) indicator
- 9- Frequency display window

To listen to the radio

E00709000896

1. Press the PWR switch (1) to turn the audio system ON and OFF. The system turns on in the last mode used.
2. Press the RADIO buttons (5) to select the desired band.
3. Press the TUNE/SEEK button (3 or 4) to tune to a station, or press one of the memory select buttons (2) to recall a station memorised for that button.

To tune the radio

E00709100451

Automatic tuning

After keeping the TUNE/SEEK button (3 or 4) depressed, release the button, and the selected station reception will start.

Manual tuning

The frequency changes every time the TUNE/SEEK button (3 or 4) is pressed. Press the button to select the desired station.

To enter frequencies into the memory

E00716101173

Manual setting

You can assign to the memory select buttons (2) a maximum of 18 stations in the FM band (6 FM1, 6 FM2 and 6 FM3 stations) and 6 stations each in the MW and LW band. (Stations already assigned to the memory select buttons are replaced by any newly assigned stations.)

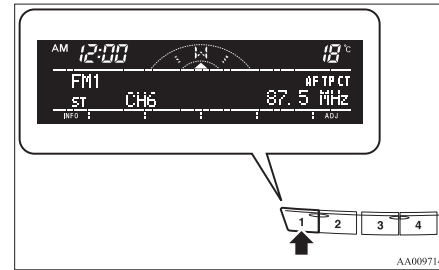

Follow the steps described below.

1. Press either the TUNE/SEEK button (3 or 4) to tune the frequency to be entered in the memory.
2. Press one of the memory select buttons (2) for 2 seconds or longer.
The number of the button corresponding to the entry in the memory and the frequency are displayed.

3. The preset memory setting is retrieved by pressing the button and then releasing it within 2 seconds.

Automatic setting

With the method, all manually set stations in the band currently selected for reception are replaced with stations in the same band that are automatically selected in order of signal strength. The radio automatically selects 6 stations in the FM band (FM3 station only) and 6 stations each in the MW and LW band.

Follow the steps described below.

1. With the radio mode selected, hold down the RADIO button (5) for 2 seconds or longer. The 6 stations with the best signal strength will automatically be assigned to the memory select buttons (2), with the lowest-frequency station being assigned to the lowest-number button.
2. When you subsequently press a memory select button to select a channel number, the radio will begin receiving the station assigned to that number.

NOTE

- If you press the RADIO button (5) for 2 seconds or longer while tuning in the FM1 or FM2 band, the radio will automatically switch to the FM3 band, where the automatic seeking/storing will be activated.

Radio data system (RDS)

E00709200452

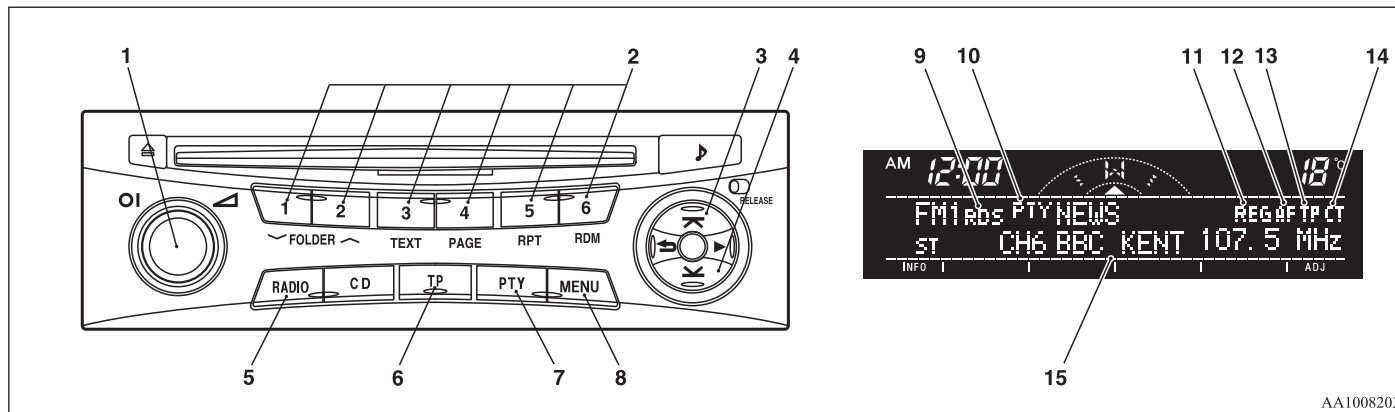

AA1008203

5

RDS uses PI (program identification) signal and AF (alternative frequency) list transmitted in addition to the normal FM broadcasting programs, and picks up the FM stations that are transmitting the same program from the AF list and automatically tunes to the station with the strongest signal intensity.

Therefore, you can continue listening to one program in, for example, a long distance driving without retuning to the other station transmitting the same program when you are leaving the service area of the currently receiving station.

The RDS radio also features the limited reception of the program types, the break-in reception of the traffic announcement to the EON (enhanced other network) and emergency broadcast, and the limited/unlimited reception of the regional programs.

For pleasant driving

AF (Alternative Frequencies) function

E0072090061

The AF function finds a station broadcasting the same program and selects the station with the strongest signal of AF lists.

The AF function is turned on (with the AF indicator (12) shown on the display) at all times unless you manually switch it off.

The AF function can be turned ON and OFF. Refer to “Function setup mode” on page 5-22.

CT (Clock Time) function

E00721000131

The clock can be set automatically by using the signal from the local RDS stations. Refer to “Adjusting the time” on page 3-12.

REG (Regional) function

E00721100057

REG function limits to receive the stations broadcasting regional programs. Regional programming and regional networks are organized differently depending on the country or area (they may be changed according to the hour, state, or broadcast area), so if you don't want to receive the regional programs automatically, you can set up REG ON not to receive regional programs.

The REG function can be turned ON and OFF. Refer to “Function setup mode” on page 5-22.

PI (Program Identification) search function

E00721200221

When travelling long distance and the recalled preset station is weak, the radio searches another frequency broadcasting the same programming with the same PI code in AF list.

If there are no frequencies broadcasting the same programming, the radio searches a frequency broadcasting the regional programming. The radio succeeds in searching the regional programming, then the display shows the REG indicator (11).

If the radio does not succeed in searching the regional programming, the radio returns to the recalled preset station.

The PI function can be turned ON and OFF. Refer to “Function setup mode” on page 5-22.

NOTE

- While searching, the audio system is muted. The display shows “WAIT” or “SEARCH”.

PTY (Program type)

E00721300349

RDS broadcasts are classified according to program type (PTY) as follows. Use the TUNE/SEEK button (3 or 4) to select your desired PTY.

1. NEWS
2. AFFAIRS (Current affairs)
3. INFO (Information)
4. SPORT
5. EDUCATE (Education)
6. DRAMA
7. CULTURE
8. SCIENCE
9. VARIED
10. POP M (Pop music)
11. ROCK M (Rock music)
12. EASY M (Easy music)
13. LIGHT M (Light classics)
14. CLASSICS
15. OTHER M (Other music)
16. WEATHER (Weather information)
17. FINANCE
18. CHILDREN

19. SOCIAL
20. RELIGION
21. PHONE IN
22. TRAVEL
23. LEISURE
24. JAZZ
25. COUNTRY
26. NATION M (National music)
27. OLDIES
28. FOLK M (Folk music)
29. DOCUMENT

To search for a broadcast of desired program type:

1. Press the PTY button (7).
2. Press the TUNE/SEEK button (3 or 4) for less than 1 second repeatedly to select your desired PTY.
3. Two seconds after a desired PTY has been selected, the radio will begin to search for a broadcast of your selected PTY. During search, the selected PTY on the display blinks.
4. When the radio picks up a station with your desired PTY, the display will show the name of the station.

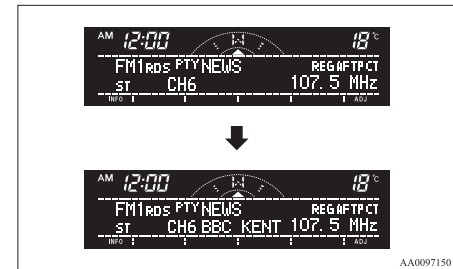

NOTE

- If the TUNE/SEEK button (3 or 4) is pressed for more than 1 second, the radio will try to find out another broadcast of the same program type as currently selected.
- If no station is found with your desired PTY, the display will show “EMPTY” for about 5 seconds and the radio will return to the previous station.

How to enter PTYs in the memory

E00721400135

As many as 6 PTYs can be entered in the memory. Follow the steps described below.

1. Press either the TUNE/SEEK button (3 or 4) to tune the PTY to be entered in the memory.
2. Press one of the memory select buttons (2) for 2 seconds or longer. The number of the button corresponding to the entry into the memory and the PTY are displayed.
3. The preset memory setting is retrieved by pressing the button and then releasing it within about 2 seconds.

Traffic information

E00721600254

The radio will automatically tune in to traffic information broadcasts while receiving FM broadcasts or playing compact discs etc.

To select this function, follow the instructions below.

1. Press the TP button (6). The display will show “TP” (13). If the RDS data can be read, the display will show “RDS” (9). If not, the display will show “NO RDS” for about 5 seconds.

2. If the radio detects traffic information on either the station currently selected or another station, the display will show “TRAF INF” for 5 seconds followed by a 2-second indication of the frequency. Then, it will show the name of the station broadcasting the traffic information to which you will listen. The volume level is set separately for listening to normal audio programs and for listening to traffic information. The volume level will therefore change automatically to that set when traffic information was last received. When the traffic information broadcast is over, the radio will return to the previously received program and to the corresponding volume level.
3. Press the TP button (6) to return to the previous condition.

NOTE

- While “TP” is illuminated, the radio stops only at TP stations even if the TUNE/SEEK button (3 or 4) is pressed.

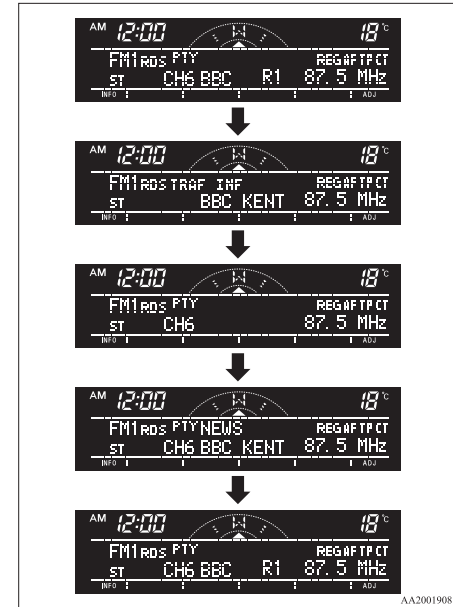
**TP (Traffic information Program) search function**

E00721800168

The traffic information program standby function is turned on (with the TP indicator (13) shown on the display) and after about 45 seconds since the RDS indicator (9) turns off due to weak signal or the tuning station is changed over from a TP station to a station which does not broadcast traffic information, and seeks out a TP station in all frequencies automatically.

The TP search function can be turned ON and OFF. Refer to “Function setup mode” on page 5-22.

For pleasant driving

Emergency broadcasts

E00721700213

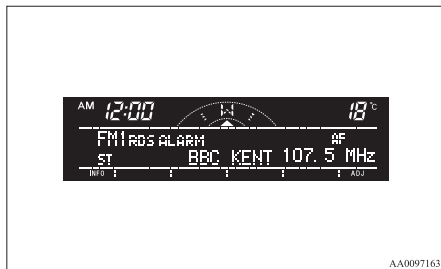

AA0097163

5 If an emergency broadcast is caught while receiving a FM broadcast or playing back a compact disc with the ignition switch in “ACC” or “ON” position, the display will show “ALARM” and the emergency broadcast will interrupt the current program. The volume level is set separately for listening to normal audio programs and for listening to emergency broadcasts. The volume level will therefore change automatically to that set when an emergency broadcast or traffic information broadcast was last received. When the emergency broadcast is over, the radio will return to the previously received program and to the corresponding volume level.

Function setup mode

E00722500449

It is possible to change the following functions:

- Gracenote Database*
- AF
- CT
- REG*
- TP-S
- PI-S*
- PHONE

1. Press the “MENU” button to select the function setup mode.

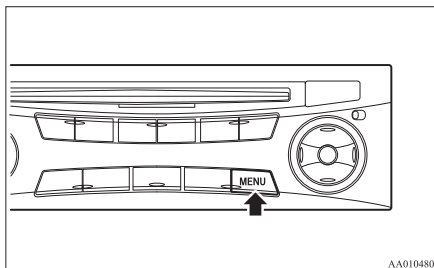

AA0104805

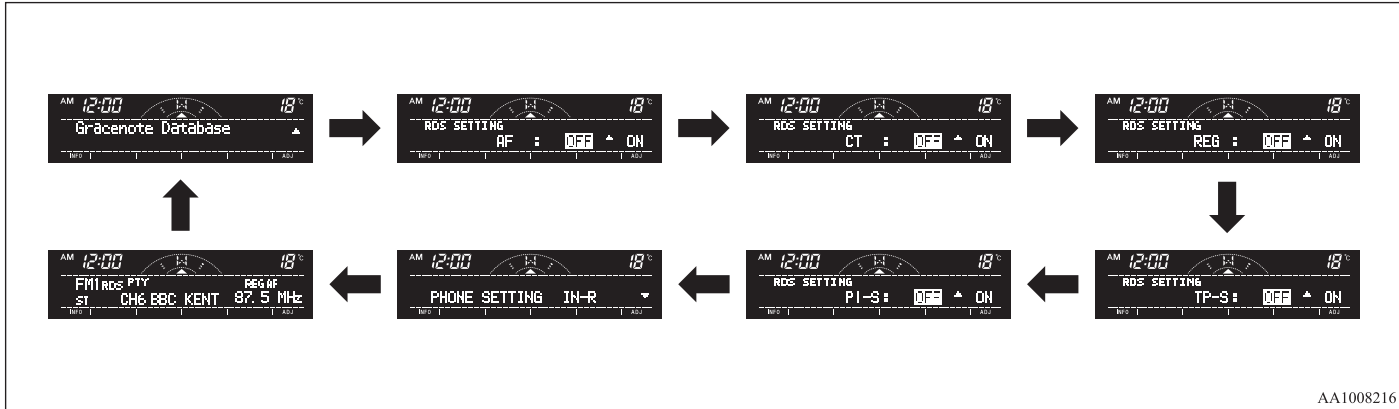

2. Press the “MENU” button repeatedly to select the mode you wish to change.
 The order is: Gracenote Database* → AF → CT → REG* → TP-S → PI-S* → PHONE → Function setup mode OFF.

NOTE

- Although “Gracenote Database” and “PHONE” appear on the display, these functions are inoperative.
3. Select the desired setting for each mode to be turned ON and OFF as shown below.

The setting will be shown on the display.

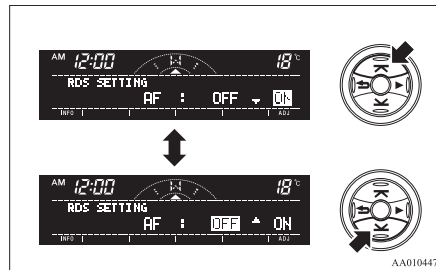

NOTE

- After selecting a mode, you can leave the function setup mode by taking either of the following steps:
 - Press the “MENU” button for at least 2 seconds.
 - Make no entry for 10 seconds.

CD control panel and display

E00709501205

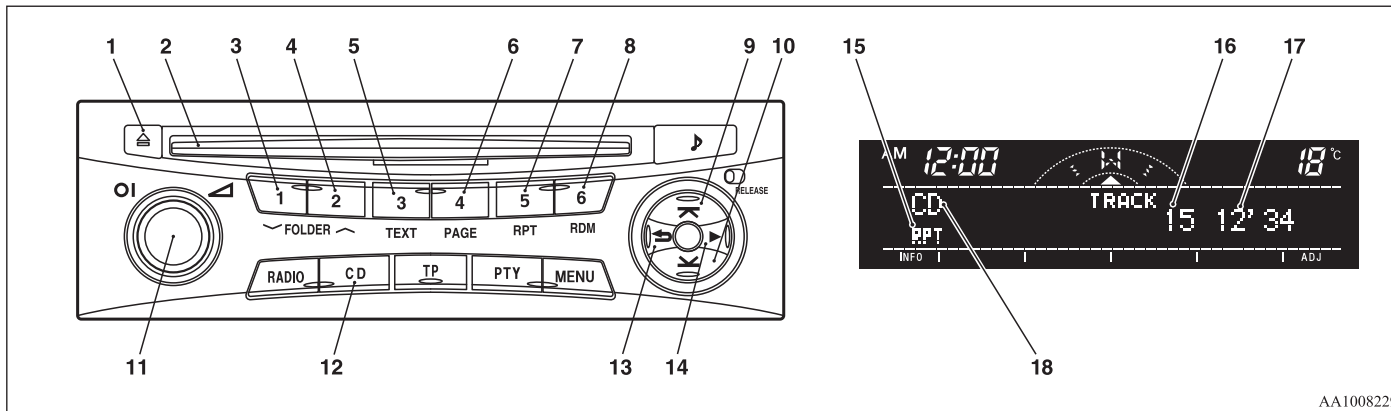

AA1008229

5

- 1- CD eject button
- 2- Disc-loading slot
- 3- FOLDER (Folder down) button
- 4- FOLDER (Folder up) button
- 5- TEXT (Title display) button
- 6- PAGE (Title scroll) button
- 7- RPT (Repeat) button
- 8- RDM (Random) button
- 9- **⏭** (Fast-forward/Track up) button
- 10- **⏮** (Fast-reverse/Track down) button

- 11- PWR (On-Off) switch
- 12- CD (CD mode changeover) button
- 13- **↩** (Return) button
- 14- **▶** (Select) button
- 15- RPT/RDM indicator
- 16- Track number indicator
- 17- Track play time indicator
- 18- CD indicator

To listen to a CD

E00709602290

1. Insert a disc with the label facing up, and the CD player will begin playing even if another mode is being used. The CD indicator (18), the track number (16), the playing time (17) will appear on the display.
2. When the CD mode is selected by pressing the CD (12) button several times with the disc in the player, the CD player will start playback.
3. To stop the CD, turn off the power by pressing the PWR switch (11) or change over to the another mode by pressing the RADIO button or CD button, or eject the disc by pressing the eject button (1).

NOTE

- To adjust the volume and tone, refer to “To adjust the volume” on page 5-15 and “To adjust the tone” on page 5-15.
- An 8 cm compact disc cannot be played on this CD player.
- For information concerning the handling of compact discs, refer to “Handling of compact discs” on page 5-49.

To fast-forward/fast-reverse the disc

Fast-forward

You can fast-forward the disc by pressing the **⏩** button (9). While the button is kept pressed, the disc will be fast-forwarded.

Fast-reverse

You can fast-reverse the disc by pressing the **⏪** button (10). While the button is kept pressed, the disc will be fast-reversed.

NOTE

- When you have fast-forwarded/fast-reversed the disc, the playing-time may be shown with deviation.

To listen to an MP3 CD

This CD player allows you to play MP3 (MPEG Audio Layer-3) files recorded on CD-ROMs, CD-Rs (recordable CDs), and CD-RWs (rewritable CDs) in ISO9660 Level 1/Level 2, Joliet, and Romeo formats. Each disc may have a maximum of 16 trees, 100 folders, and 255 files per disc. During MP3 playback, the unit can display ID3 tag information. For information concerning ID3 tag, refer to “CD text and MP3 title display” on page 5-27.

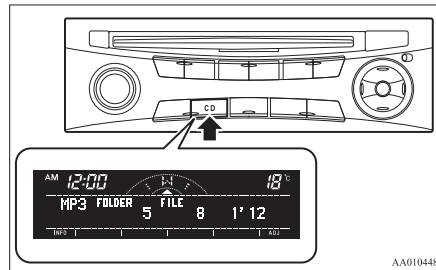

1. Insert a disc containing MP3 files into the slot.
2. The display shows the folder number and the file number, then playback will begin.

NOTE

- While listening to a disc on which CD-DA (CD-Digital Audio) and MP3 files have both been recorded, you can switch between reading of the CD-DA, reading of the MP3 files, and the external audio input mode (AUX) by pressing the CD button for 2 seconds or longer.
- With a disc that contains both CD-DA and MP3 files, the CD-DA files are automatically played first.
- The playback sound quality differs depending on the encoding software and the bit rate. For details, refer to the user manual of your encoding software.
- Depending on file/folder configurations on a disc, it may take some time before playback starts.
- MP3 encoding software and writing software are not supplied with this unit.
- You may encounter trouble in playing an MP3 or displaying the information of MP3 files recorded with certain writing software or CD recorders (CD-R/RW drivers).
- If you record too many folders or files other than MP3 onto a disc, it may take some time before playback starts.
- This unit does not record MP3 files.
- For information concerning CD-Rs/RWs, refer to “Notes on CD-Rs/RWs” on page 5-50.

⚠ CAUTION

- Attempting to play a file not in the MP3 format which has a “.mp3” file name may produce noise from the speakers and speaker damage, and can damage your hearing.

For pleasant driving

Folder selection order/MP3 file playback order (Example)

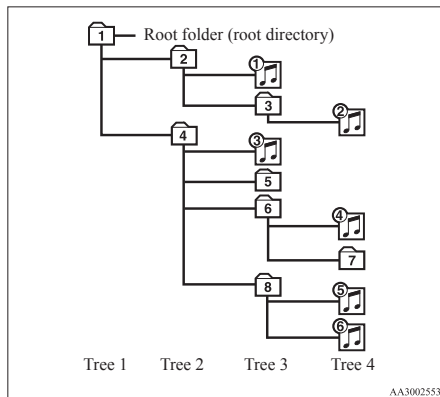

5

Folder selection

In the order

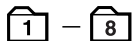

File selection

In the order



To select a desired folder (MP3 CDs only)

Folder up

Press the FOLDER button (4) until the desired folder number appears on the display.

Folder down

Press the FOLDER button (3) until the desired folder number appears on the display.

To select a desired track

Track up

Press the **▲** button (9) repeatedly until the desired track number appears on the display.

Track down

Press the **▼** button (10) repeatedly until the desired track number appears on the display.

NOTE

- Pressing the **▼** button (10) once during the song will cause the CD player to restart playback from the beginning of the song.

To find a file (MP3 CDs only)

Press the following buttons to select desired file. The selected folder or file is shown in the display.

↵ button (14) : To start this mode or cancel the selection.

▲ button (9) or **▼** button (10) : To show the folder or file.

▶ button (15) : To select the folder or file.

NOTE

- If no operation is performed for 10 seconds or more or another button is operated after the **▲** button or **▼** button has been pressed, searching of the desired file is cancelled.

- If no operation is performed for 5 seconds or more after the file is displayed, playback starts.

To repeat a track

Press the RPT button (7) briefly while the track is playing. “RPT” will appear on the display. To exit the repeat mode, press the RPT button.

To repeat a folder (MP3 CDs only)

Press the RPT button (7) for 1 second or longer (until you hear a beep). “F-RPT” will appear on the display. You can listen to all the files in the currently selected folder repeatedly.

NOTE

- With a disc that contains both CD-DA and MP3 files, the repeat mode causes only files of the same format (CD-DA only or MP3 files only) to be repeated.

To play tracks in random order

Random playback for a disc (music CDs only)

Press the RDM button (8) briefly. “RDM” will appear on the display. Tracks on the currently selected disc will be played in a random sequence. To exit the random mode, press the RDM button again.

Random playback for a folder (MP3 CDs only)

Press the RDM button (8) briefly. “F-RDM” will appear on the display. Files on the currently selected folder will be played in a random sequence. To exit the random mode, press the RDM button again.

Random playback for all folders on a disc (MP3 CDs only)

Press the RDM button (8) for 1 second or longer (until you hear a beep). “RDM” will appear on the display. Files from all the folders on the currently selected disc will be played in a random sequence. To exit the random mode, briefly press the RDM button again.

NOTE

- With a disc that contains both CD-DA and MP3 files, the random mode causes only files of the same format (CD-DA only or MP3 files only) to be played in a random sequence.

To eject a disc

When the CD eject button (1) is pressed, the disc automatically stops and is ejected.

NOTE

- If you do not remove the disc before 15 seconds have elapsed, the CD player will automatically reload the disc and stop.

CD text and MP3 title display

E00725000676

This CD player can display CD text and MP3 titles including ID3 tag information.

CD text

The CD player can display disc and track titles for discs encoded with disc and track title information. Press the TEXT button (5) repeatedly to make selections in the following sequence: disc name → track name → normal display mode.

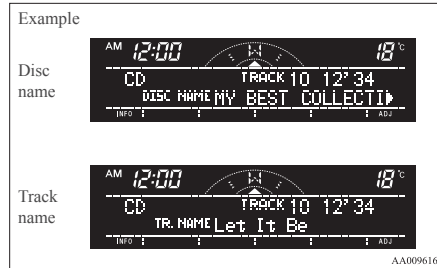

NOTE

- The display can show up to 16 characters. If a disc name or track name has more than 16 characters, press the PAGE button (6) to view the next 16 characters.
- When there is no title information to be displayed, the display shows “NO TITLE”.
- Characters that the CD player cannot display are shown as “ ”.

MP3 title

The CD player can display folder and file titles for discs encoded with folder and file information. Press the TEXT button (5) for less than 1 second repeatedly to make selections in the following sequence: folder name → file name → normal display mode.

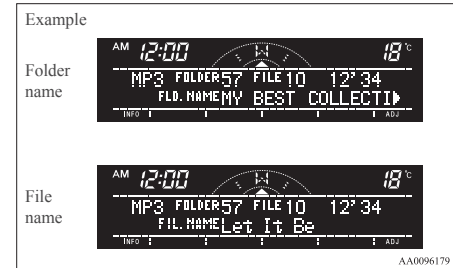

ID3 tag information

The CD player can display ID3 tag information for files that have been recorded with ID3 tag information.

1. Press the TEXT button (5) for 2 seconds or longer to switch to the ID3 tag information.
2. Then press the TEXT button for less than 1 second repeatedly to make selections in the following sequence: album name → title name → artist name → normal display mode.

NOTE

- To return from ID3 tag information to the folder name, press the TEXT button (5) again for 2 seconds or longer.
- When there is no title information to be displayed, the display shows “NO TITLE”.

For pleasant driving

- The display can show up to 16 characters. If a folder name, track name, or item of ID3 tag information has more than 16 characters, press the PAGE button (6) to view the next 16 characters.
- Folder names and track names can each be displayed up to a length of 32 characters. Items of ID3 tag information can each be displayed up to a length of 30 characters.
- Characters that the CD player cannot display are shown as “ ”.

*To play tracks from USB device**

E00756100149

You can connect your iPod or USB memory device to the USB input terminal and play music files stored in the iPod or USB memory device.

See the following section for the types of connectable devices and supported files.

Refer to “Types of connectable devices and supported file specifications” on page 5-69.

See the following sections for the connecting methods, “How to connect an iPod” on page 5-68 and “How to connect a USB memory device” on page 5-68.

If your vehicle is equipped with a Bluetooth® 2.0 interface, you can play music files in your iPod or USB memory device via voice operation.

Refer to “To play iPod tracks via voice operation” on page 5-31 and “To play USB memory device tracks via voice operation” on page 5-37.

NOTE

- The protected file by copyright might not be able to start playback.
- It is recommended to adjust the equalizer of the connected device is flat.

iPod control panel and display

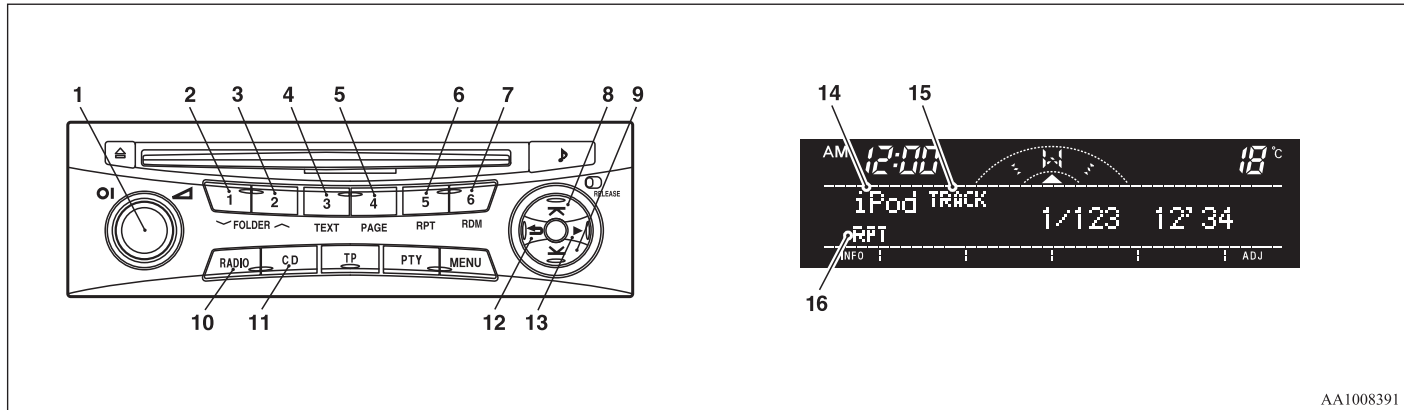

AA1008391

- 1- PWR (On-Off) button
- 2- FOLDER (Folder down) button
- 3- FOLDER (Folder up) button
- 4- TEXT button
- 5- PAGE (Title scroll) button
- 6- RPT (Repeat) button
- 7- RDM (Random) button
- 8- ⏭ (Fast-forward/Track up) button
- 9- ⏮ (Fast-reverse/Track down) button
- 10- RADIO button
- 11- CD (Mode change) button
- 12- ⏪ (Return) button
- 13- ⏩ (Select) button
- 14- iPod indicator
- 15- TRACK indicator
- 16- RPT/SHUFFLE/A-SHUFFLE indicator

For pleasant driving

To play from an iPod

E00756300372

1. Press the PWR button (1) to turn on the audio system. The system turns on in the last mode used.
2. Connect your iPod to the USB input terminal. Refer to “How to connect an iPod” on page 5-68.
3. Press the CD button (11) several times to switch to the iPod mode. The mode changes every time the CD button is pressed.

CD mode → iPod mode → Bluetooth® mode*

NOTE

- If your vehicle is equipped with Auxiliary Audio connector (RCA), pressing and holding the CD button for 2 seconds or more switches the system to the AUX mode.
4. Once the device is selected, playback starts and “iPod” appears on the display.

NOTE

- Depending on the condition of your iPod, it may take a longer time before the playback starts.
5. To stop the playback, change over to a different mode.

NOTE

- Buttons on the iPod are disabled while the iPod is connected to the audio system.
- To adjust the volume and tone, refer to “To adjust the volume” and “To adjust the tone”.

To fast-forward/reverse the track

E00756400113

Fast-forward

To fast-forward the current track, press the **⏩** button (8). While the button is pressed, the track will be fast-forwarded.

Fast-reverse

To fast-reverse the current track, press the **⏮** button (9). While the button is pressed, the track will be fast-reversed.

To select a desired track

E00756500097

Track up

Press the **⏮** button (8) repeatedly until the desired track number appears on the display.

Track down

Press the **⏭** button (9) repeatedly until the desired track number appears on the display.

NOTE

- Pressing the **⏭** button (9) once during the song will cause the audio system to restart playback from the beginning of the song.

To find a track from the iPod menu

E00756600186

You can select desired tracks from the “Playlists”, “Artists”, “Albums”, “Songs” or “Genre” (vehicles with Bluetooth® 2.0 interface) menus on your iPod.

Press the following buttons to select desired tracks. The selected menu or category or track is shown in the display.

⏩ button (12) : To start this mode or cancel the selection.

⏮ button (8) : To show the menu or category or track.
or **⏭** button (9)

▶ button (13) : To select the menu or category or track.

NOTE

- If no operation is performed for 10 seconds or more or another button is operated after the **⏮** button or **⏭** button has been pressed, searching of the desired tracks is cancelled.
- If no operation is performed for 5 seconds or more after the track is displayed, playback starts.

To play the same track repeatedly

E00756700099

Press the RPT button (6) during playback to show “RPT” in the display.

To exit this mode, press the button again.

To play tracks in random order

E00756900091

Press the RDM button (7) to show “SHUFFLE” in the display. The iPod randomly selects tracks from the current category and plays the selected tracks.

To exit this mode, press the button again.

To play tracks in each album in random order

E00757000099

Press and hold the RDM button (7) until you hear a beep to show “A-SHUFFLE” in the display. The iPod randomly selects tracks in the album from the current category and play the selected tracks.

To exit this mode, press the button again.

To switch the display

E00757100090

The display changes as follows every time the TEXT button (4) is pressed during playback.

Album title → Track name → Artist name → Genre (vehicles with Bluetooth® 2.0 interface) → Normal display

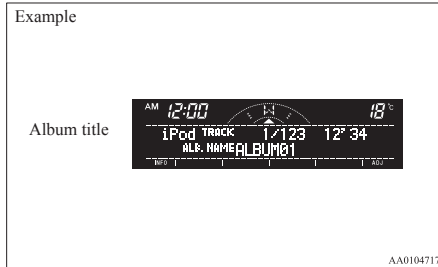
**NOTE**

- Up to 16 characters are shown in the display at once. If the title is cut off in the middle, press the PAGE button (5). The next characters are displayed every time this button is pressed.
- If no title is stored, “NO TITLE” is shown in the display.
- Characters that cannot be displayed are substituted by “ ”.

To play iPod tracks via voice operation (vehicles with Bluetooth® 2.0 interface)

E00757200046

Desired tracks can be selected and played from your iPod by “Artist”, “Album”, “Playlist” and “Genre” using voice commands.

For information concerning the voice recognition function or speaker enrollment function, refer to “Bluetooth® 2.0 interface” on page 5-52.

The following explains how to prepare for voice operation and play the tracks.

Preparation for voice operation

E00757300135

To use the voice operation, press the SPEECH button (1) first.

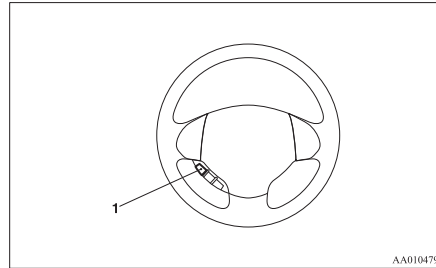
**To search by artist name**

E00757400019

1. Say “Play” on the main menu.

NOTE

- The Bluetooth® 2.0 interface starts recognizing the connected device. If the connected device cannot be recognized or a connection error occurs, the Bluetooth® 2.0 interface starts an appropriate voice guide. Follow the voice guide.
2. After the voice guide says “Would you like to play by Artist, Album, Playlist or Genre?,” say “Artist”.

NOTE

- If you say “Artist <name>,” you can skip step 3.
3. After the voice guide says “What Artist would you like to play?,” say the artist name.
 4. If there is only one match, the system proceeds to step 6.
 5. If there are two or more matches, the voice guide will say “More than one match was found, would you like to play <artist name>?” If you say “Yes,” the system proceeds to step 6. If you say “No,” the next matching artist is uttered by the system.

NOTE

- If you say “No” to three or all artist names uttered by the system, the voice guide will say “Artist not found, please try again” and the system returns to step 2.
- Search time is dependant on the number of songs on your connected device. Devices containing a large number of songs may take longer to return search results.

For pleasant driving

6. After the voice guide says “Playing <artist name>,” the system creates a playlist index for the artist.

NOTE

- If the confirmation function is active, the voice guide confirms if the artist name is correct. If the artist name is correct, say “Yes”. If not, say “No”. After the voice guide says “Artist not found, please try again,” the system returns to step 2.

7. The system exits the voice recognition mode and starts playback.

To search by album title

E00757500010

1. Say “Play” on the main menu.

NOTE

- The Bluetooth® 2.0 interface starts recognizing the connected device. If the connected device cannot be recognized or a connection error occurs, the Bluetooth® 2.0 interface starts an appropriate voice guide. Follow the voice guide.

2. After the voice guide says “Would you like to play by Artist, Album, Playlist or Genre?,” say “Album”.

NOTE

- If you say “Album<title>,” you can skip step 3.

3. After the voice guide says “What Album would you like to play?” say the album title.

4. If there is only one match, the system proceeds to step 6.

5. If there are two or more matches, the voice guide will say “More than one match was found, would you like to play <album title>?” If you say “Yes,” the system proceeds to step 6.

If you say “No,” the next matching album is uttered by the system.

NOTE

- If you say “No” to three or all album titles uttered by the system, the voice guide will say “Album not found, please try again” and the system returns to step 2.

6. After the voice guide says “Playing <album title>,” the system creates a playlist index for the album title.

NOTE

- If the confirmation function is active, the voice guide confirms if the album title is correct. If the album title is correct, say “Yes”. If not, say “No”. After the voice guide says “Album not found, please try again,” the system returns to step 2.

7. The system exits the voice recognition mode and starts playback.

To search by playlist

E00757600011

1. Say “Play” on the main menu.

NOTE

- The Bluetooth® 2.0 interface starts recognizing the connected device.

If the connected device cannot be recognized or a connection error occurs, the Bluetooth® 2.0 interface starts an appropriate voice guide. Follow the voice guide.

2. After the voice guide says “Would you like to play by Artist, Album, Playlist or Genre?,” say “Playlist”.

NOTE

- If you say “Playlist <playlist>,” you can skip step 3.

If the device has no playlist, the voice guide will say “There are no playlists stored on device” and the system returns to step 2.

3. After the voice guide says “What Playlist would you like to play?,” say the playlist name.

4. If there is only one match, the system proceeds to step 6.

5. If there are two or more matches, the voice guide will say “More than one match was found, would you like to play <playlist>?” If you say “Yes,” the system proceeds to step 6. If you say “No,” the next matching playlist name is uttered by the system.

NOTE

- If you say “No” to three or all playlist names uttered by the system, the voice guide will say “Playlist not found, please try again” and the system returns to step 2.

6. After the voice guide says “Playing <playlist>,” the system creates an index for the playlist.

NOTE

- If the confirmation function is active, the voice guide confirms if the playlist name is correct. If the playlist name is correct, say “Yes”. If not, say “No”. After the voice guide says “Playlist not found, please try again,” the system returns to step 2. Refer to “Confirmation function setting” on page 5-55.
7. The system exits the voice recognition mode and starts playback.

To search by genre

E00757700041

1. Say “Play” on the main menu.

NOTE

- The Bluetooth® 2.0 interface starts recognizing the connected device. If the connected device cannot be recognized or a connection error occurs, the Bluetooth® 2.0 interface starts an appropriate voice guide. Follow the voice guide.
2. After the voice guide says “Would you like to play by Artist, Album, Playlist or Genre?,” say “Genre”.

NOTE

- If you say “Genre <type>,” you can skip step 3.

3. After the voice guide says “What Genre would you like to play?,” say the music type.
4. If there is only one match, the system proceeds to step 6.
5. If there are two or more matches, the voice guide will say “More than one match was found, would you like to play <genre>?” If you say “Yes,” the system proceeds to step 6. If you say “No,” the next matching genre is uttered by the system.

NOTE

- If you say “No” to three or all genres uttered by the system, the voice guide will say “Genre not found, please try again” and the system returns to step 2.
6. After the voice guide says “Playing <genre>,” the system creates an index for the genre.

NOTE

- If the confirmation function is active, the voice guide confirms if the genre is correct. If the genre is correct, say “Yes”. If not, say “No”. After the voice guide says “Genre not found, please try again,” the system returns to step 2. Refer to “Confirmation function setting” on page 5-55.
7. The system exits the voice recognition mode and starts playback.

USB control panel and display

E00758100231

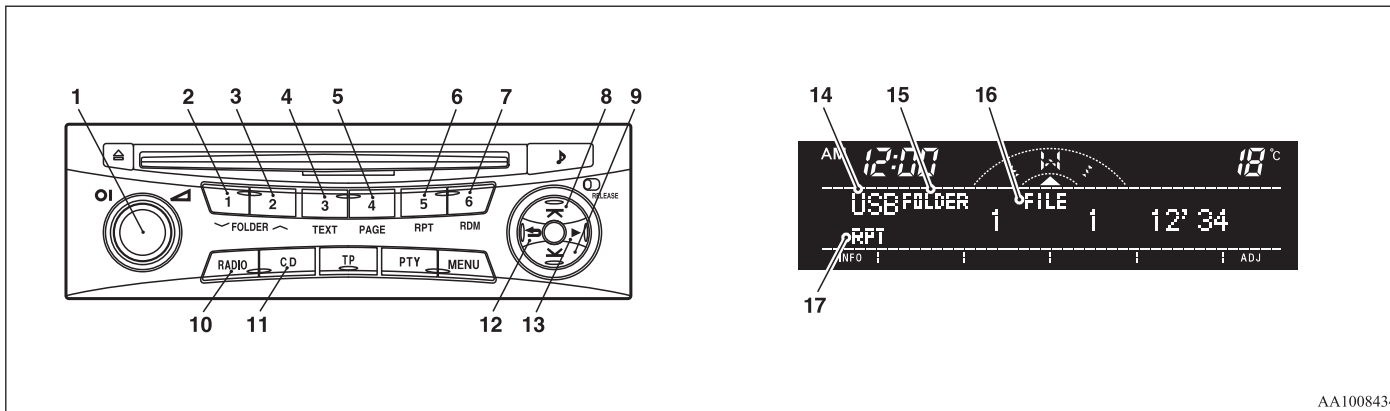

AA1008434

5

- 1- PWR (On-Off) button
- 2- FOLDER (Folder down) button
- 3- FOLDER (Folder up) button
- 4- TEXT button
- 5- PAGE (Title scroll) button
- 6- RPT (Repeat) button
- 7- RDM (Random) button
- 8- ⏩ (Fast-forward/File up) button
- 9- ⏪ (Fast-reverse/File down) button
- 10- RADIO button
- 11- CD (Mode change) button
- 12- ↵ (Return) button
- 13- ▶ (Select) button
- 14- USB indicator
- 15- FOLDER indicator
- 16- FILE indicator
- 17- RPT/F-RPT/F-RDM/RDM/SCAN/F-SCAN indicator

To play from a USB memory device

E00762500366

1. Press the PWR button (1) to turn on the audio system. The system turns on in the last mode used.
2. Connect your USB memory device to the USB input terminal.
Refer to “How to connect a USB memory device” on page 5-68.
3. Press the CD button (11) several times to switch to the USB mode. The mode changes as follows every time the CD button is pressed.
CD mode → USB mode → Bluetooth® mode*

NOTE

- If your vehicle is equipped with Auxiliary Audio connector (RCA), pressing and holding the CD button for 2 seconds or more switches the system to the AUX mode.
4. Once the device is selected, playback starts and “USB” appears on the display.

NOTE

- Depending on the condition of your USB device, it may take a longer time before the playback starts.
5. To stop the playback, change over to a different mode.

NOTE

- To adjust the volume and tone, refer to “To adjust the volume” and “To adjust the tone”.

Supported compressed music files

E00758300305

This audio can play MP3, WMA, AAC and WAV files recorded in a USB memory device. This audio supports up to 65,535 files in 700 folders on 8 levels.

Folder selection order/file playback order (example)

The folder and file hierarchy in the USB memory device is shown below.

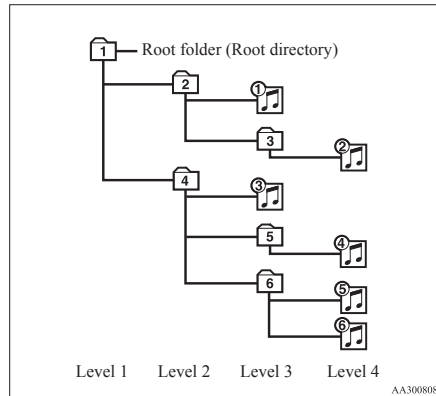

Folder selection

In the order

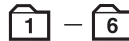

File selection

In the order

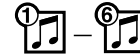

NOTE

- If a file protected by copyrights is played, the file will be skipped.

To fast-forward/reverse the track

E00758400090

Fast-forward

To fast-forward the current track, press the **⏭** button (8). While the button is pressed, the track will be fast-forwarded.

Fast-reverse

To fast-reverse the current track, press the **⏮** button (9). While the button is pressed, the track will be fast-reversed.

To select a file

E00758500088

File up

Press the **⏶** button (8) repeatedly until the desired file number appears on the display.

File down

Press the **⏵** button (9) repeatedly until the desired file number appears on the display.

NOTE

- Pressing the **⏵** button (9) once during the song will cause the audio system to restart playback from the beginning of the song.

For pleasant driving

To find a file

E00758600311

You can select a folder to find a desired track.

Press the following buttons to select desired folder or file.

The selected folder or file is shown in the display.

↵ button (12) : To start this mode or cancel the selection.

⏮ button (8) : To show the folder or file.

or **⏭** button (9)

▶ button (13) : To select the folder or file.

NOTE

- If no operation is performed for 10 seconds or more or another button is operated after the **⏮** button or **⏭** button has been pressed, searching of the desired file is cancelled.
- If no operation is performed for 5 seconds or more after the file is displayed, playback starts.

To play the same file repeatedly

E00758700093

Press the RPT button (6) to show “RPT” in the display.

To exit this mode, press the button again.

To play the files in the same folder repeatedly

E00758800094

Press and hold the RPT button (6) until you hear a beep to show “F-RPT” in the display.

All files in the current folder are played repeatedly.

To exit this mode, press the button again.

To play a folder in random order

E00758900095

Press the RDM button (7) to show “F-RDM” in the display.

The audio randomly selects files from the current folder and plays the selected files.

To exit this mode, press the button again.

To play all folders in random order

E00759000093

Press and hold the RDM button (7) until you hear a beep to show “RDM” in the display.

The audio randomly selects files from all folders and plays the selected files.

To exit this mode, press the button again.

To switch the display

E00759300155

The display changes as follows every time the TEXT button (4) is pressed during playback.

Folder title → File title → Normal display

ID3 tag information

1. Press and hold the TEXT button (4) until you hear a beep to show “TAG” in the display.

2. The display changes as follows every time the TEXT button (4) is pressed briefly.

Album title → Track title → Artist name → Genre (vehicles with Bluetooth® 2.0 interface) → Normal display

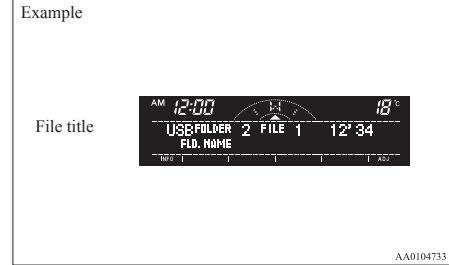

NOTE

- Press and hold the TEXT button (4) again until you hear a beep, and the tag information display returns to the folder title display.
- Up to 16 characters are shown in the display at once. If the title is cut off in the middle, press the PAGE button (5). The next characters are displayed every time this button is pressed.
- If no title is stored, “NO TITLE” is shown in the display.
- Characters that cannot be displayed are substituted by “ ”.

To play USB memory device tracks via voice operation (vehicles with Bluetooth® 2.0 interface)

E00759400130

Desired tracks can be selected and played from your USB memory device by “Artist”, “Album”, “Playlist” and “Genre” using voice commands.

For information concerning the voice recognition function or speaker enrollment function, refer to “Bluetooth® 2.0 interface” on page 5-52.

The playback sequence of tracks is the same as when an iPod is connected. Refer to the “To play iPod tracks via voice operation” on page 5-31.

Preparation for voice operation

To use the voice operation, press the SPEECH button (1) first.

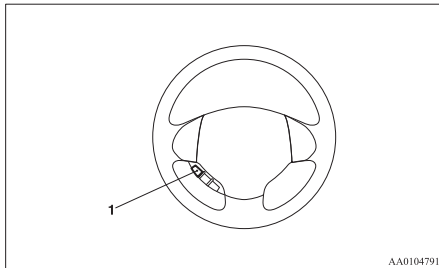

AA0104791

To play tracks from a Bluetooth® device (vehicles with Bluetooth® 2.0 interface)

E00759700162

You can wirelessly connect a digital audio player or cellular phone supporting Bluetooth® to listen to the tracks on the connected device.

Refer to “Bluetooth® 2.0 interface” on page 5-52.

The following explains the basic playback method.

NOTE

- According to the connected device, it is not to operate correctly or the limitation might be provided in available function.
- The protected file by copyright might not be able to start playback.
- It is recommended to adjust the equalizer of the connected device is flat.
- The voice operation is not available to access music files on the connected Bluetooth® device.

Bluetooth® device control panel and display

E00762600181

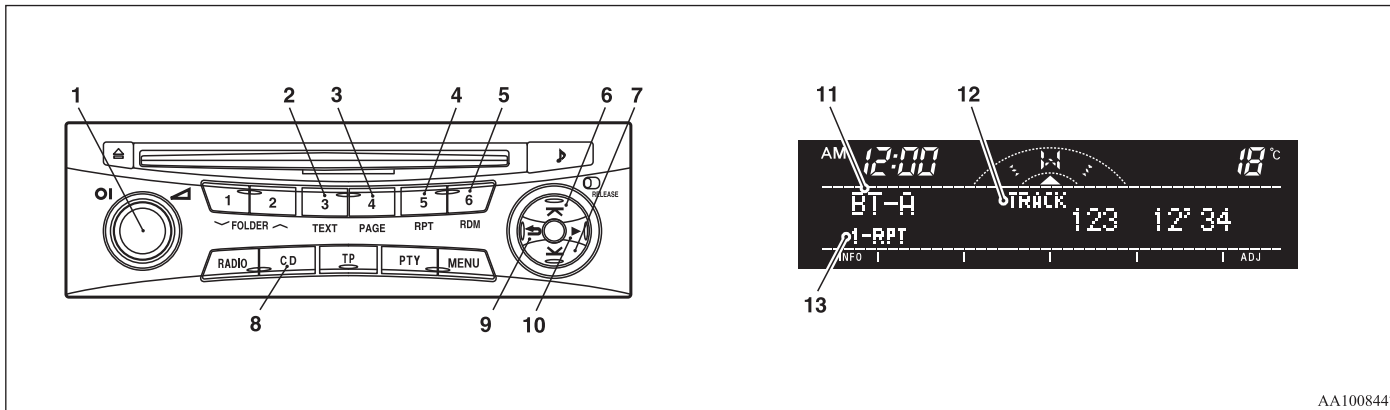

AA1008447

5

- 1- PWR (On-Off) button
- 2- TEXT (Title display) button
- 3- PAGE (Title scroll) button
- 4- RPT (Repeat) button
- 5- RDM (Random) button
- 6- **⏭** (Fast-forward/File up) button
- 7- **⏮** (Fast-reverse/File down) button
- 8- CD (Mode change) button
- 9- **⏸** (Stop/Pause) button
- 10- **▶** (Play) button
- 11- BT-A (Bluetooth®) indicator
- 12- TRACK indicator
- 13- 1-RPT/A-RPT/RDM/SCAN indicator

To listen to tracks from a device connected via Bluetooth®

E00762700225

1. Press the PWR button (1) to turn on the audio system. The system turns on in the last mode used.
2. Press the CD button (8) several times to switch to the BT-A (Bluetooth®) mode. The mode changes as follows every time the CD button is pressed.
CD mode → USB (iPod) mode → Bluetooth® mode

NOTE

- For vehicles equipped with Auxiliary Audio connector (RCA), pressing and holding the CD button for 2 seconds or more switches the system to the AUX mode.
3. Connect your Bluetooth® device.
Refer to “Connecting the Bluetooth® 2.0 interface and Bluetooth® device” on page 5-57.
 4. Playback starts automatically.

NOTE

- Depending on the connected device, the playback may not start automatically.
In this case, operate the connected device to start the playback.

To stop the playback (if supported by the device)

E00762800079

- To stop the playback, press and hold the **⏏** button (9) until you hear a beep.
To restart the playback, press the **▶** button (10).

To pause the playback (if supported by the device)

E00762900083

- To pause the playback, press the **⏸** button (9).
To restart the playback, press the **▶** button (10).

To fast-forward/reverse the track (if supported by the device)

E00765600010

Fast-forward

To fast-forward the current track, press the **⏩** button (6). While the button is pressed, the track will be fast-forwarded.

Fast-reverse

To fast-reverse the current track, press the **⏪** button (7). While the button is pressed, the track will be fast-reversed.

To select a track (if supported by the device)

E00763000094

Track up

Press the **⏴** button (6) repeatedly until the desired track number appears on the display.

Track down

Press the **⏵** button (7) repeatedly until the desired track number appears on the display.

NOTE

- Pressing the **⏵** button (7) once during the song will cause the audio system to restart playback from the beginning of the song.

To play the same track or all tracks repeatedly (if supported by the device)

E00763100079

Press the RPT button (4) several times to show “1-RPT” (same track repeat mode) or “A-RPT” (all tracks repeat mode) in the display.

The mode changes as follows every time the RPT button is pressed.

1-RPT mode → A-RPT mode → mode off

To exit these mode, press the RPT button several times until the 1-RPT indicator or the A-RPT indicator goes off.

To play tracks in random order (if supported by the device)

E00763200070

Press the RDM button (5) to show “RDM” in the display.

The system randomly selects and plays tracks from all tracks in the Bluetooth® device.

To exit this mode, press the button again.

To switch the display (if supported by the device)

E00763400072

The display changes as follows every time the TEXT button (2) is pressed briefly.

Album title → Title name → Artist name → Genre → Normal display

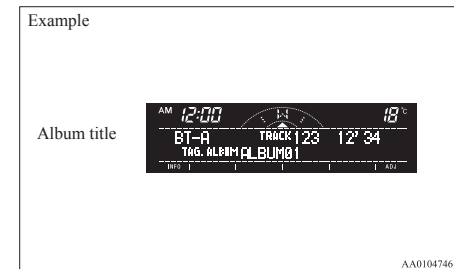

For pleasant driving

NOTE

- Press and hold the TEXT button (2) again until you hear a beep, and the tag information disappears.
- Up to 16 characters are shown in the display at once. If the title is cut off in the middle, press the PAGE button (3). The next characters are displayed every time this button is pressed.
- If no title is stored, “NO TITLE” is shown in the display.
- Characters that cannot be displayed are substituted by “ ”.

To use the external audio input function*

E00732200957

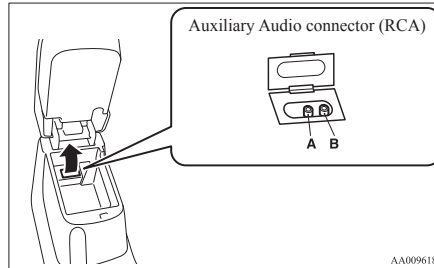

Auxiliary Audio connector (RCA)

- A- Left audio input connector (white)
- B- Right audio input connector (red)

You can listen to commercially available audio equipment, such as a portable audio system, from your vehicle's speakers, by connecting the audio equipment to the audio input connectors, which are external input connectors (pin jacks).

To activate the external audio input mode

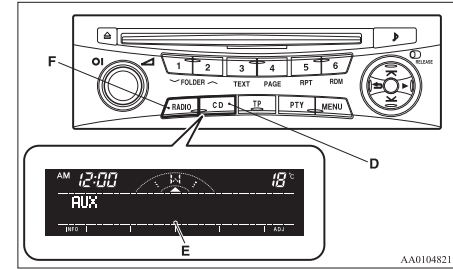

1. Use a commercially available audio cable to connect the audio equipment to the external audio input connector.
2. Press the CD button (D) for more than 2 seconds. The display (E) will show “AUX” and then the external audio input mode will be activated.
3. To deactivate the external audio input mode, press the RADIO button (F) or the CD button (D) to switch to another mode.

⚠ CAUTION

- Do not operate the connected audio equipment while driving. This could distract you and an accident might occur.

NOTE

- The connected audio equipment cannot be operated with the vehicle's audio system.
- Depending on the connected audio equipment, it may produce noise from the speakers.
- Use the connected audio equipment's own power source, such as its battery. Noise may be produced from the speakers if the connected audio equipment is used while charging it using the accessory socket of the vehicle.
- Do not activate the external audio input mode when no audio equipment is connected. Otherwise, noise may be produced from the speakers.
- Connect audio equipment when the external audio input mode is deactivated or lower the vehicle's speaker volume before connecting it. Noise may be produced from the speakers if audio equipment is connected after the external audio input mode is activated.
- For information on how to connect and operate the audio equipment, refer to the owner's manual for the equipment.

Steering wheel remote control switch*

E0071000955

The remote control switches are located on the left side of the steering wheel.

These switches can be used when the ignition switch is in the "ON" or "ACC" position.

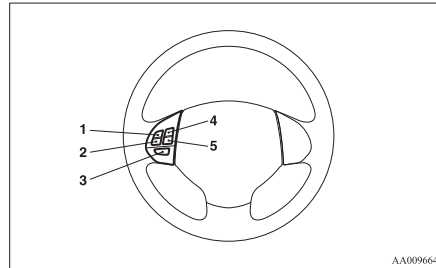

- 1- Volume up button
- 2- Volume down button
- 3- PWR (ON-OFF)/Mode change button
- 4- Seek up/Fast-forward/Track up/File up button
- 5- Seek down/Fast-reverse/Track down/File down button

NOTE

- Do not push two or more of the steering wheel remote control switches at the same time.

To turn on the power

PWR (ON-OFF) button - 3

When the power is off, press this button to turn the power on. To turn the power off, press this button for 2 seconds or longer.

To adjust the volume

Volume up button - 1

The volume will increase when this button is pressed.

Volume down button - 2

The volume will decrease when this button is pressed.

Mode selection

Press the mode change button (3) to select the desired mode. The mode changes in the following order.

FM1 → FM2 → FM3 → MW → LW → CD → USB or iPod* → Bluetooth®* → FM1

To listen to the radio

To select FM/MW/LW mode

Press the mode change button (3) to select the desired mode. (AM/FM or LW/MW/FM)

Automatic radio tuning

Seek up button - 4/Seek down button - 5

After pressing these buttons, the reception of the selected station will begin.

To listen to a CD

To fast-forward/fast-reverse the disc

To fast-forward or fast-reverse the disc, press the fast-forward button (4) or the fast-reverse button (5).

Fast-forward button - 4

You can fast-forward the disc by pressing the fast-forward button. While the button is kept pressed, the disc will be fast-forwarded.

For pleasant driving

Fast-reverse button - 5

You can fast-reverse the disc by pressing the fast-reverse button. While the button is kept pressed, the disc will be fastreversed.

NOTE

- In the case of an MP3 CD, you can fast-forward and fast-reverse tracks in the same folder.

To select a desired track

Track up button - 4

Press the button repeatedly until the desired track number appears on the display.

Track down button - 5

Press the button repeatedly until the desired track number appears on the display.

To listen to an iPod

Press the mode change button (3) and select iPod mode.

To select a desired track

Track up button - 4

Press the button repeatedly until the desired track number appears on the display.

NOTE

- The track number increases continuously while the button is pressed.

Track down button - 5

Press the button repeatedly until the desired track number appears on the display.

NOTE

- The track number decreases continuously while the button is pressed.

To listen to a USB memory device

Press the mode change button (3) and select USB mode.

To select a desired file

File up button — 4

Press the button repeatedly until the desired track number appears on the display.

NOTE

- The track number increases continuously while the button is pressed.

File down button — 5

Press the button repeatedly until the desired track number appears on the display.

NOTE

- The track number decreases continuously while the button is pressed.

Error codes

E00710101142

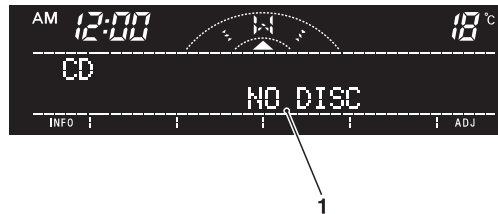

AA1007176

If an error code (1) appears in the display, take action in accordance with the table below.

Error display	Problem	Description	Repair
NO DISC	No disc inserted	Disc is not in CD player.	Insert disc.
ERROR 01	Focus error	Disc is not loaded correctly, or condensation on disc.	Insert disc with label facing up. Remove moisture from disc.
ERROR 02	Disc error	Disc is dirty, scratched, or deformed; or excessive vehicle vibration.	Clean or replace disc. Retry when vibrations stop.
ERROR 03	Mechanism error	Loading or eject error. Pick-up is out of position.	Eject disc and reload. If disc will not eject, have the equipment inspected.
ERROR HOT	High temperature	Internal protection against high temperatures.	Allow CD player to cool by waiting about 30 minutes.

For pleasant driving

Error display	Problem	Description	Repair
ERROR	Communication or power supply error	Communication error between external device and audio equipment. Power supply error of external device.	Consult a MITSUBISHI MOTORS Authorized Service Point.

Error codes (iPod)

E00763500158



1

AA1008258

If an error code (1) appears in the display, take action in accordance with the table below.

Error display	Item	Repair
NO SONG	There are no playable music files.	Record music files in the iPod.
VERSION ERROR (Blink)	The iPod or its software cannot be recognized.	Connect a supported iPod.
USB BUS PWR (Blink)	An overcurrent or other power-supply error has occurred.	Remove the iPod. Have the vehicle inspected at a MITSUBISHI MOTORS Authorized Service Point.
USB LSI ERROR (Blink)	Internal device errors	Have the vehicle inspected at a MITSUBISHI MOTORS Authorized Service Point.

For pleasant driving

Error display	Item	Repair
CONNECT RETRY (Blink)	If the iPod indicator illuminates, the iPod cannot be authenticated.	Reconnect the iPod.
	If the iPod indicator goes out, it shows the USB communication error.	Reconnect the iPod correctly. If this error is displayed again, have the vehicle inspected at a MITSUBISHI MOTORS Authorized Service Point.

Error codes (USB memory device)

E00763600146

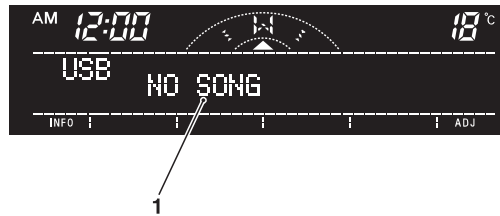

AA1008261

If an error code (1) appears in the display, take action in accordance with the table below.

Error display	Item	Repair
NO SONG	There are no playable music files.	Record music files in the format supported by the USB memory device.
USB FILE ERROR (Blink)	The file cannot be played.	The file is protected by copyrights, etc. An error is displayed for several seconds, and then the next playable file is played automatically.
UNSUPPORTED FORMAT (Blink)	The USB memory device format cannot be recognized.	Remove the USB memory device.
USB BUS POWER (Blink)	An overcurrent or other power-supply error has occurred.	Remove the USB memory device. Have the vehicle inspected at a MITSUBISHI MOTORS Authorized Service Point.
USB LSI ERROR (Blink)	Internal device errors	Have the vehicle inspected at a MITSUBISHI MOTORS Authorized Service Point.

For pleasant driving

Error display	Item	Repair
CONNECT RETRY (Blink)	USB communication error	Reconnect the USB memory device correctly. If this error is displayed again, have the vehicle inspected at a MITSUBISHI MOTORS Authorized Service Point.

Audio system anti-theft feature

E00710200348

To prevent theft of the audio system, the control knob can be removed. Always remove the control knob when you leave the vehicle.

Removing the control knob

Slide the release button (A) to the right and remove the control knob from the audio system.

The anti-theft function operates in two ways depending on the position of the ignition key.

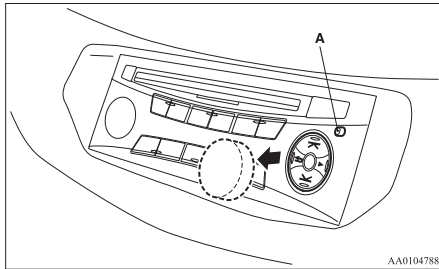

1. With the key in the "ON" or "ACC" position

The "Please refit the control panel." indicator will appear on the display. Any audio system operation will be disabled while the "Please refit the control panel." indicator is displayed.

2. With the key in the "LOCK" position

The lamp (B) will start flashing to deter thieves.

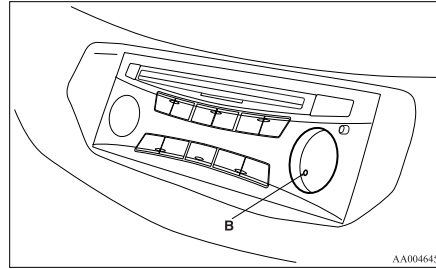

NOTE

- When sliding the release button, place one hand on the control knob to prevent it from falling out.

Refitting the control knob

Put the control knob back into the original position and then push it until it clicks. The "Please refit the control panel." indicator will disappear or the lamp (B) will stop flashing.

NOTE

- Do not leave the control knob in any place where it may become hot (for example, the dashboard) or in any place where it may become wet.
- If you lose the control knob, contact a MITSUBISHI MOTORS Authorized Service Point.

Handling of compact discs

E00723000034

- Use only the type of compact discs that have the mark shown in the illustration below. (Playback of CD-R or CD-RW discs may cause problems.)



For pleasant driving

- The use of special shaped, damaged compact discs (like cracked discs) or low-quality compact discs (like warped discs or burrs on the discs) such as those shown will damage the CD player.

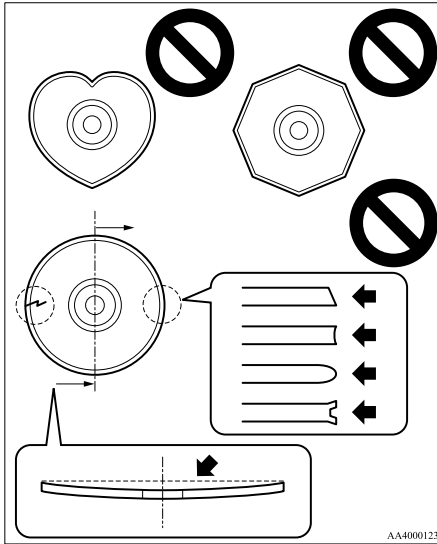

- In the following circumstances, moisture can form on discs and inside the audio system, preventing normal operation.
 - When there is high humidity (for example, when it is raining).

- When the temperature suddenly rises, such as right after the heater is turned on in cold weather.

In this case, wait until the moisture has had time to dry out.

- When the CD player is subjected to violent vibrations, such as during off-road driving, the tracking may not work.
- When storing compact discs, always store them in their separate cases. Never place compact discs in direct sunlight, or in any place where the temperature or humidity is high.
- Never touch the flat surface of the disc without a label. This will damage the disc surface and could affect the sound quality. When handling a compact disc, always hold it by the outer edge and the centre hole.
- To clean a disc, use a soft, clean, dry cloth. Wipe directly from the centre hole towards the outer edge. Do not wipe in a circle. Never use any chemicals such as benzine, paint thinner, a disc spray cleaner, or an anti-static agent on the disc.

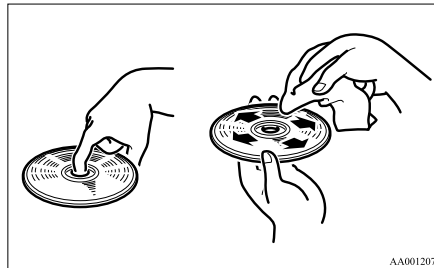

- Do not use a ball point pen, felt pen, pencil, etc. to write on the label surface of the disc.
- Do not put additional labels (A) or stickers (B) on compact discs. Also, do not use any compact disc on which a label or sticker has started to peel off or any compact disc that has stickiness or other contamination left by a peeled-off label or sticker. If you use such a compact disc, the CD player may stop working properly and you may not be able to eject the compact disc.

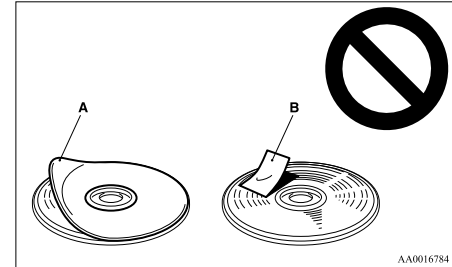

Notes on CD-Rs/RWs

E00725100039

- You may have trouble playing back some CD-R/RW discs recorded on CD recorders (CD-R/RW drives), either due to their recording characteristics or dirt, fingerprints, scratches, etc. on the disc surface.
- CD-R/RW discs are less resistant to high temperatures and high humidity than ordinary music CDs. Leaving them inside a vehicle for extended periods may damage them and make playback impossible.

- The unit may not successfully play back a CD-R/RW that was made by the combination of writing software, a CD recorder (CD-R/RW drive) and a disc if they are incompatible with one another.
- This player cannot play the CD-R/RW discs if the session is not closed.
- This player cannot play CD-R/RW discs which contain other than CD-DA or MP3 data (Video CD, etc.).
- Be sure to observe the handling instructions for the CD-R/RW disc.

⚠ WARNING

- **Operating the CD player in a manner other than specifically instructed herein may result in hazardous radiation exposure. Do not remove the cover and attempt to repair the CD player by yourself. There are no user serviceable parts inside. In case of malfunction, we recommend you to have it checked.**

Antenna

E00710500022

Pillar antenna*

E00710700109

When listening to the radio, fully extend the antenna.

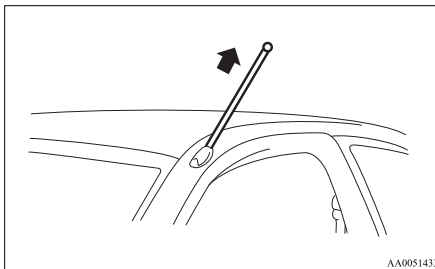

NOTE

- Be sure to retract the pillar antenna in the following cases:
 - When entering a place with low clearance.
 - When using an automatic car wash.
 - When placing a car cover over the vehicle.

For pleasant driving

Roof antenna*

E00710900071

When listening to the radio, raise the antenna up until you hear it click.

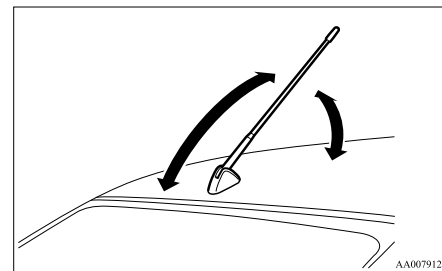

To remove

Turn the pole (A) anticlockwise.

To install

Screw the pole (A) clockwise into the base (B) until it is securely retained.

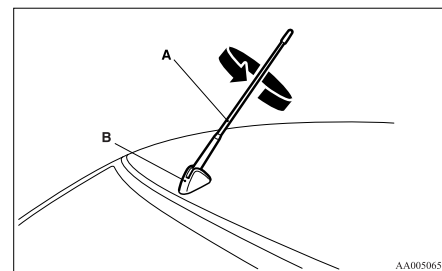

For pleasant driving

NOTE

- Be sure to remove the roof antenna in the following cases:
 - When using an automatic car wash.
 - When placing a car cover over the vehicle.
- Before driving into a structure that has a low ceiling, fold down the antenna to prevent it from hitting the ceiling.

Link System*

E00764500012

The Link System takes overall control of the devices connected via the USB input terminal or the Bluetooth® 2.0 interface allowing the connected devices to be operated by using the switches in the vehicle or voice commands. See the following section for details on how to operate.

Refer to “Bluetooth® 2.0 interface” on page 5-52.

Refer to “USB input terminal” on page 5-68.

Refer to “To play tracks from USB device” on page 5-28.

Refer to “To play tracks from a Bluetooth® device” on page 5-37.

Refer to “To use the external audio input function” on page 5-40.

Bluetooth® is a registered trademark of BLUE-TOOTH SIG, INC.

Link System End User Licence Agreement

E00764600013

You have acquired a device that includes software licensed by MITSUBISHI MOTORS CORPORATION from JOHNSON CONTROLS Inc (the automotive experience business unit), and their subsequent 3rd party suppliers. For a complete list of these 3rd party products and their end user licence agreements, please go to the following website.
<http://www.jciblueconnect.com/faq/fulldisclosure.pdf>

Bluetooth® 2.0 interface

E00726000703

The Bluetooth® 2.0 interface allows for making/receiving hands-free calls in the vehicle using a Bluetooth® compatible cellular phone based on the wireless communication technology commonly known as Bluetooth®. It also allows the user to play music, saved in a Bluetooth® music player, from the vehicle’s speakers.

The system is equipped with a voice recognition function, which allows you to make hands-free calls by simple switch operations and voice command operations using a defined voice tree.

The Bluetooth® 2.0 interface can be used when the ignition switch is in the “ON” or “ACC” position.

Before you can use the Bluetooth® 2.0 interface, you must pair the Bluetooth® device and Bluetooth® 2.0 interface. Refer to “Connecting the Bluetooth® 2.0 interface and Bluetooth® device” on page 5-57.

Bluetooth® is a registered trademark of BLUE-TOOTH SIG, INC.

⚠ WARNING

- Although the Bluetooth® 2.0 interface allows you to make hands-free calls, if you choose to use the cellular phone while driving, you must not allow yourself to be distracted from the safe operation of your vehicle. Anything, including cellular phone usage, that distracts you from the safe operation of your vehicle increases your risk of an accident.
- Refer to and comply with all state and local laws in your area regarding cellular phone usage while driving.

NOTE

- The Bluetooth® 2.0 interface cannot be used if the Bluetooth® device has a flat battery or the device power is turned off.
- Hands-free calls will not be possible if your phone does not have service available.
- If you place the Bluetooth® device in the cargo area, you may not be able to use the Bluetooth® 2.0 interface.
- Some Bluetooth® devices are not compatible with the Bluetooth® 2.0 interface.
- You can confirm the Link System software version by pressing the HANG-UP button 3 times (press and hold 2 times and then press briefly) within 10 seconds.

- For details on the Bluetooth® 2.0 interface, you can see them by accessing the MITSUBISHI MOTORS website. Please read and agree on the “Warning about Links to the Web Sites of Other Companies” because it connects to other than MITSUBISHI MOTORS website. <http://www.mitsubishi-motors.com/en/products/index.html>
- Software updates by cellular phone/digital audio device manufacturers may change/alter device connectivity.

Steering control switch and microphone → p. 5-53

Voice recognition function → p. 5-54

Useful voice commands → p. 5-55

Speaker enrollment function → p. 5-56

Connecting the Bluetooth® 2.0 interface and Bluetooth® device → p. 5-57

Operating a music player connected via Bluetooth® → p. 5-60

How to make or receive hands-free calls → p. 5-60

Phone book function → p. 5-62

Steering control switch and microphone

E00727200324

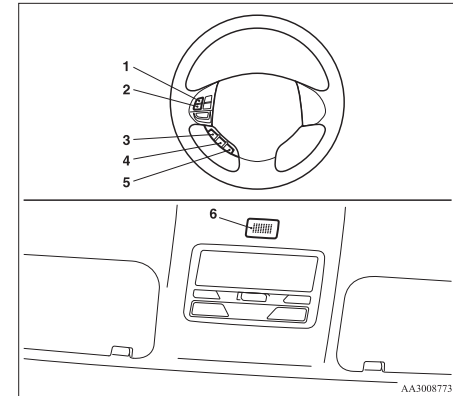

- 1- Volume up button
- 2- Volume down button
- 3- SPEECH button
- 4- PICK-UP button
- 5- HANG-UP button
- 6- Microphone

Volume up button

Press this button to increase the volume.

Volume down button

Press this button to decrease the volume.

For pleasant driving

SPEECH button

- Press this button to change to voice recognition mode.
While the system is in voice recognition mode, “Listening” will appear on the audio display.
- If you press the button briefly while in voice recognition mode, it will interrupt prompting and allow voice command input.
Pressing the button longer will deactivate the voice recognition mode.
- Pressing this button briefly during a call will enable voice recognition and allow voice command input.

PICK-UP button

- Press this button when an incoming call is received to answer the telephone.
- When another call is received during a call, press this button to put the first caller on hold and talk to the new caller.
 - In such circumstances, you can press the button briefly to switch between callers. You will switch to the first caller and the other caller will be put on hold.
 - To establish a three-way call in such situations, press the SPEECH button to enter voice recognition mode and then say “Join calls”.

HANG-UP button

- Press this button when an incoming call is received to refuse the call.
- Press this button during a call to end the current call.
When another call is on hold, you will switch to that call.

- If this button is pressed in the voice recognition mode, the voice recognition mode will be deactivated.

NOTE

- When you press the SPEECH button to enter voice recognition mode with a cellular phone paired to the system, current information on the cellular phone, such as “remaining battery life,” “signal strength” or “roaming,” will be displayed on the audio display.*
*: Some cellular phones will not send this information to the Bluetooth® 2.0 interface.
- Call waiting and three-way calls can be used by the Bluetooth® 2.0 interface, only if it is possible to use those services with your cellular phone.

Microphone

Your voice will be recognized by a microphone in the overhead console, allowing you to make hands-free calls with voice commands.

NOTE

- If a cellular phone is brought close to the microphone, it may create noise in the voice on the phone. In such a case, take the cellular phone at a place as far as possible from the microphone.

Voice recognition function

E00727300527

The Bluetooth® 2.0 interface is equipped with a voice recognition function.
Simply say voice commands and you can perform various operations and make or receive hands-free calls.

With the Bluetooth® 2.0 interface, voice recognition is possible for English, French, Spanish, Italian, German, Dutch, Portuguese and Russian. The factory setting is “English” or “Russian.”

NOTE

- If the voice command that you say differs from the predefined command or cannot be recognised due to ambient noise or some other reason, the Bluetooth® 2.0 interface will ask you for the voice command again up to 3 times.
- For best performance and further reduction of ambient noise, close the vehicle windows, lower the blower speed and refrain from conversation with your passengers while engaging the voice recognition function.
- Depending on the selected language, some functions may not be available.

Selecting the Language

1. Press the SPEECH button.
2. Say “Setup”.
3. Say “Language.”
4. The voice guide will say “Select a language: English, French, Spanish, Italian, German, Dutch, Portuguese or Russian” Say the desired language. (Example: Say “English.”)
5. The voice guide will say “English (French, Spanish, Italian, German, Dutch, Portuguese or Russian) selected. Is this correct?” Say “Yes.”

Answer “No” to return to Step 4.

NOTE

- The voice guide will repeat the same message twice. The first message is in the current language, and the second message is in the selected language.
 - If many entries are registered in the vehicle phone book, changing the language will take longer.
 - Changing the language deletes the mobile phone book imported to the Bluetooth® 2.0 interface. If you wish to use it, you will have to import it again.
6. When the voice guide says “English (French, Spanish, Italian, German, Dutch, Portuguese or Russian) selected,” the language change process will be completed and the system will return to the main menu.

Useful voice commands**Help function**

E0076000019

E00760100010

The Bluetooth® 2.0 interface is equipped with a help function. If you say “Help” when the system is waiting for a voice command input, the system will tell you a list of the commands that can be used under the circumstances.

Cancelling

E00760200011

There are two cancel functions. If you are at the main menu, say “Cancel” to exit from the Bluetooth® 2.0 interface. If you are anywhere else within the system, say “Cancel” to return to the main menu.

Confirmation function setting

E00760400013

The Bluetooth® 2.0 interface is equipped with a confirmation function.

With the confirmation function activated, you are given more opportunities than normal to confirm a command when making various settings to the Bluetooth® 2.0 interface. This allows you to decrease the possibility that a setting is accidentally changed. The confirmation function can be turned on or off by following the steps below.

1. Press the SPEECH button.
2. Say “Setup”.
3. Say “Confirmation prompts”.
4. The voice guide will say “Confirmation prompts are <on/off>. Would you like to turn confirmation prompts <off/on>”. Answer “Yes” to change the setting or answer “No” to keep the current setting.
5. The voice guide will say “Confirmation prompts are <off/on>” and then the system will return to the main menu.

Security function

E00760500131

It is possible to use a password as a security function by setting a password of your choice for the Bluetooth® 2.0 interface.

When the security function is turned on, it is necessary to make a voice input of a 4-digit password in order to use all functions of the Bluetooth® 2.0 interface, except for reception.

Setting the password

Use the following procedure to turn on the security function by setting a password.

1. Press the SPEECH button.
2. Say “Setup”.
3. Say “Password.”

4. The voice guide will say “Password is disabled. Would you like to enable it?” Answer “Yes.”
Answer “No” to cancel the setting of the password and return to the main menu.
5. The voice guide will say “Please say a 4-digit password. Remember this password. It will be required to use this system”.
Say a 4-digit number which you want to set as a password.
6. For confirmation purposes, the voice guide will say “Password <4-digit password>. Is this correct?” Answer “Yes.”
Answer “No” to return to the password input in Step 5.
7. When the registration of the password is completed, the voice guide will say “Password is enabled” and the system will return to the main menu.

NOTE

- Password will be required to access the system after the next ignition cycle.
- It is required for a little time after engine stop that the entered password is actually recorded in the system.
If the ignition switch is made to “ACC” or “ON” or the engine is started immediately after engine stop, there is a case when the entered password is not recorded in the system. At this time, please try to enter the password again.

For pleasant driving

Entering the password

If a password has been set and the security function is enabled, the voice guide will say “Hands-free system is locked. State the password to continue” when the SPEECH button is pressed to enter voice recognition mode. Say the 4-digit password number to enter the password.

If the entered password is wrong, the voice guide will say “<4- digit password>, Incorrect password. Please try again”. Enter the correct password.

NOTE

- You can re-enter the password as many times as you want.
- If you have forgotten your password, say “Cancel” to quit the voice input mode and then check with a MITSUBISHI MOTORS Authorized Service Point.

Disabling the password

Use the following procedure to turn off the security function by disabling the password.

5

NOTE

- System must be unlocked to disable the password.

1. Press the SPEECH button.
2. Say “Setup”.
3. Say “Password.”
4. The voice guide will say “Password is enabled. Would you like to disable it?”
Answer “Yes.” Answer “No” to cancel the disabling of the password and return to the main menu.

5. When the disabling of the password is completed, the voice guide will say “Password is disabled” and the system will return to the main menu.

Speaker enrollment function

E00727400209

The Bluetooth® 2.0 interface can use the speaker enrollment function to create a voice model for one person per language.

This makes it easier for the Bluetooth® 2.0 interface to recognise voice commands said by you. You can turn a voice model registered with the speaker enrollment function on and off whenever you want.

Speaker enrollment

E00727500196

It takes about 2 to 3 minutes to complete the speaker enrollment process.

To ensure the best results, run through the process while in the driver’s seat, in an environment that is as quiet as possible (when there is no rain or strong winds and the vehicle windows are closed). Please turn off your phone while in speaker enrollment to prevent interruption of the process.

Use the following procedure for speaker enrollment.

1. Stop your vehicle in a safe area, put the gear-shift lever in the “N” (Neutral) position (M/T), or the selector lever in the “P” (PARK) position (A/T), and pull the parking brake lever.

NOTE

- Speaker enrollment is not possible unless the vehicle is parked. Make sure you park the vehicle in a safe area before attempting speaker enrollment.

2. Press the SPEECH button.
 3. Say “Voice training”.
 4. The voice guide will say “This operation must be performed in a quiet environment while the vehicle is stopped. See the owner’s manual for the list of required training phrases. Press and release the SPEECH button when you are ready to begin. Press the HANG-UP button to cancel at any time”.
- Press the SPEECH button to start the speaker enrollment process.

NOTE

- If you do not start the speaker enrollment process within 3 minutes of pressing the SPEECH button, the speaker enrollment function will time out.

The voice guide will say “Speaker Enrollment has timed out”. The system will then beep and the voice recognition mode will be deactivated.

5. The voice guide will prompt for phrase 1. Repeat the corresponding phrase listed in table “Enrollment commands” on page 5-67.
The system will register your voice and then move on to the registration of the next command. Continue the process until all phrases have been registered.

NOTE

- To repeat the most recent voice training command, press and release the SPEECH button.
- If you press the HANG-UP button anytime during the process, the system will beep and stop the speaker enrollment process.

- When all enrollment commands have been read out, the voice guide will say “Speaker enrollment is complete”. The system will then end the speaker enrollment process and return to the main menu.

NOTE

- Completing the speaker enrollment process will turn on the voice model automatically.
- The commands “Help” and “Cancel” will not work in this mode.

Enabling and disabling the voice model and re-training

E00727600096

You can turn a voice model registered with the speaker enrollment function on and off whenever you want.

You can also retrain the system.

Use the following procedure to perform these actions.

- Press the SPEECH button.
- Say “Voice training”.
- If you have completed a speaker enrollment process once already, the voice guide will say either “Enrollment is enabled. Would you like to disable or retrain?” or “Enrollment is disabled. Would you like to enable or retrain?”
- When enrollment is “enabled”, the voice model is on; when enrollment is “disabled”, the voice model is off. Say the command that fits your needs.
Say “Retrain” to start the speaker enrollment process and recreate a new voice model. (Refer to “Speaker enrollment” on page 5-56.)

Connecting the Bluetooth® 2.0 interface and Bluetooth® device

E00760600204

Before you can make or receive hands-free calls or play music using the Bluetooth® 2.0 interface function, you must pair the Bluetooth® device and Bluetooth® 2.0 interface.

NOTE

- Pairing is required only when the device is used for the first time. Once the device has been paired with the Bluetooth® 2.0 interface, you only need to bring the device into the vehicle next time and the device will automatically connect to the Bluetooth® 2.0 interface (if supported by the device).

Up to 7 Bluetooth® devices can be paired with the Bluetooth® 2.0 interface.

If multiple paired Bluetooth® devices are available in the vehicle, the cellular phone or music player most recently connected is automatically connected to the Bluetooth® 2.0 interface.

You can also change a Bluetooth® device to be connected.

To pair

To pair a Bluetooth® device with the Bluetooth® 2.0 interface, follow the steps below.

- Stop your vehicle in a safe area, put the gear-shift lever in the “N” (Neutral) position (M/T), or the selector lever in the “P” (PARK) position (A/T), and pull the parking brake lever.

NOTE

- You cannot pair Bluetooth® devices with the Bluetooth® 2.0 interface unless the vehicle is parked. Before pairing a Bluetooth® device with the Bluetooth® 2.0 interface, confirm that the vehicle is parked in a safe location.

- Press the SPEECH button.
- Say “Setup”.
- Say “Pairing options.”
- The voice guide will say “Select one of the following: pair, edit, delete, or list.” Say “Pair.”

NOTE

- If 7 devices have already been paired, the voice guide will say “Maximum devices paired” and then the system will end the pairing process. To register a new device, delete one device and then repeat the pairing process. (Refer to “Deleting a device” on page 5-58.)

- The voice guide will say “Please say a 4-digit pairing code.” Say a 4-digit number. When the confirmation function is on, the system will confirm whether the number said is acceptable. Answer “Yes.” Answer “No” to return to pairing code selection.

NOTE

- Some Bluetooth® devices require a specific pairing code. Please refer to the device manual for pairing code requirements.

For pleasant driving

- The pairing code entered here is only used for the Bluetooth® connection certification. It is any 4-digit number the user would like to select.
Remember the pairing code as it needs to be keyed into the Bluetooth® device later in the pairing process.
Depending on the connection settings of the Bluetooth® device, this code may have to be entered each time you connect the Bluetooth® device to the Bluetooth® 2.0 interface. For the default connection settings, refer to the instructions for the device.
7. The voice guide will say “Start pairing procedure on the device. See the device manual for instructions.” Enter in the Bluetooth® device the 4-digit number you have registered in Step 6.

NOTE

- According to the corresponding device to Bluetooth®, it might take a few minutes to pair the Bluetooth® device with the Bluetooth® 2.0 interface.
- If the Bluetooth® 2.0 interface cannot recognize the Bluetooth® device, the voice guide will say “Pairing has timed out” and the pairing process will be cancelled.
Confirm that the device you are pairing supports Bluetooth®, and try pairing it again.
- If you enter the wrong number, the voice guide will say “Pairing failed” and the pairing process will be cancelled. Confirm the number is right, and try pairing it again.

8. The voice guide will say “Please say the name of the device after the beep.” You can assign a desired name for the Bluetooth® device and register it as a device tag. Say the name you want to register after the beep.

NOTE

- When the confirmation function is on, after repeating the device tag you have said, the voice guide will ask “Is this correct?” Answer “Yes.”
To change the device tag, answer “No” and then say the device tag again.
9. The voice guide will say “Pairing complete,” after which a beep will be played and the pairing process will end.

Selecting a device

E00760700016

If multiple paired Bluetooth® devices are available in the vehicle, the cellular phone or music player most recently connected is automatically connected to the Bluetooth® 2.0 interface.
You can connect to the other cellular phone or music player by following setting change procedures.

To select a cellular phone

1. Press the SPEECH button.
2. Say “Setup”.
3. Say “Select phone.”
4. After the voice guide says “Please say,” the numbers of the cellular phones and device tags of corresponding cellular phones will be read out in order, starting with the cellular phone that has been most recently connected. Say the number of the cellular phone that you want to connect to.

When the confirmation function is on, the system will ask you again whether the phone that you want to connect to is correct. Answer “Yes” to continue and connect to the cellular phone.
Answer “No,” and the voice guide will say “Please say.” Say the number of the phone that you want to connect to.

NOTE

- You can connect to a phone at any time by pressing the SPEECH button and saying the number, even before all of the paired numbers and device tags of corresponding cellular phones are read out by the system.
5. The selected phone will be connected to the Bluetooth® 2.0 interface. The voice guide will say “<device tag> selected” and then the system will return to the main menu.

To select a music player

1. Press the SPEECH button.
2. Say “Setup”.
3. Say “Select music player.”
4. After the voice guide says “Please say,” the numbers of the music players and device tags of corresponding music players will be read out in order, starting with the music player that has been most recently connected. Say the number of the music player that you want to connect to.
When the confirmation function is on, the system will ask you again whether the music player that you want to connect to is correct. Answer “Yes” to continue and connect to the music player.

Answer “No,” and the voice guide will say “Please say.” Say the number of the music player that you want to connect to.

NOTE

- You can connect to a music player at any time by pressing the SPEECH button and saying the number, even before all of the paired numbers and device tags of corresponding music players are read out by the system.
5. The selected music player will be connected to the Bluetooth® 2.0 interface. The voice guide will say “<device tag> selected” and then the system will return to the main menu.

Deleting a device

Use the following procedure to delete a paired Bluetooth® device from the Bluetooth® 2.0 interface.

1. Press the SPEECH button.
2. Say “Setup”.
3. Say “Pairing options.”
4. The voice guide will say “Select one of the following: pair, edit, delete, or list.” Say “Delete.”
5. After the voice guide says “Please say,” the numbers of the devices and device tags of corresponding devices will be read out in order, starting with the device that has been most recently connected. After it completes reading all pairs, the voice guide will say “or all.” Say the number of the device that you want to delete from the system. If you want to delete all paired phones from the system, say “All.”

6. For confirmation purposes, the voice guide will say “Deleting <device tag> <number>. Is this correct?” or “Deleting all devices. Is this correct?” Answer “Yes” to delete the phone(s). Answer “No” to return to Step 4.
7. The voice guide will say “Deleted,” and then the system will end the device deletion process.

NOTE

- If the device deletion process fails for some reason, the voice guide will say “Delete failed” and then the system will cancel deleting the device.

To check a paired Bluetooth® device

E00760800017

You can check a paired Bluetooth® device by following the steps below.

1. Press the SPEECH button.
2. Say “Setup”.
3. Say “Pairing options.”
4. The voice guide will say “Select one of the following: pair, edit, delete, or list.” Say “List.”
5. The voice guide will read out device tags of corresponding devices in order, starting with the Bluetooth® device that has been connected most recently.
6. After the device tags of all paired Bluetooth® devices have been read, the system will say “End of list, would you like to start from the beginning?” To hear the list again from the beginning, answer “Yes.” When you are done, answer “No” to return to the main menu.

NOTE

- If you press and release the SPEECH button and say “Continue” or “Previous” while the list is being read, the system will advance or rewind the list. Say “Continue” to proceed to the device with the next highest number or “Previous” to return to the phone with the previous number.
- You can change the device tag by pressing and releasing the SPEECH button and then saying “Edit” while the list is being read.
- You can change the phone to be connected by pressing and releasing the SPEECH button and then saying “Select phone” while the list is being read.
- You can change the music player to be connected by pressing and releasing the SPEECH button and then saying “Select music player” while the list is being read.

Changing a device tag

E00760900018

You can change the device tag of a paired cellular phone or music player.

Follow the steps below to change a device tag.

1. Press the SPEECH button.
2. Say “Setup”.
3. Say “Pairing options.”
4. The voice guide will say “Select one of the following: pair, edit, delete, or list.” Say “Edit.”
5. The voice guide will say “Please say,” and read out the numbers of the Bluetooth® devices and device tags of corresponding devices in order, starting with the Bluetooth® that has been most recently connected. After all paired device tags have been read, the voice guide will say “Which device,

For pleasant driving

please?” Say the number of the device tag you want to change.

NOTE

- You can press and release the SPEECH button while the list is being read, and immediately say the number of the device tag you want to change.

6. The voice guide will say “New name, please.” Say the name you want to register as a new device tag.

When the confirmation function is on, the voice guide will say “<New device tag>. Is this correct?” Answer “Yes.”

Answer “No,” to say the new device tag you want to register again.

7. The device tag is changed.

When the change is complete, the voice guide will say “New name saved” and then the system will return to the main menu.

“To make a call” on page 5-60

“SEND function” on page 5-61

“Receiving calls” on page 5-61

“MUTE function” on page 5-61

“Switching between hands-free mode and private mode” on page 5-62

NOTE

- The hands-free calls might not be operated correctly when it makes calling or receiving by operating the cellular phone directly.

To make a call

E00761200122

You can make a call in the following 3 ways using the Bluetooth® 2.0 interface:

Making a call by saying a telephone number, making a call using the Bluetooth® 2.0 interface’s phone book, and making a call by redialing.

Making a call by using the telephone number

You can make a call by saying the telephone number.

1. Press the SPEECH button.
2. Say “Dial.”
3. After the voice guide says “Number please,” say the telephone number.
4. The voice guide will say “Dialing <number recognised>.” The Bluetooth® 2.0 interface will then make the call.

When the confirmation function is on, the system will confirm again the telephone number. To continue with that number, answer “Yes.”

To change the telephone number, answer “No.” The system will say “Number please” then say the telephone number again.

NOTE

- In the case of English, the system will recognise both “zero” and “oh” (Letter “o”) for the number “0.”
- The Bluetooth® 2.0 interface supports numbers (0 to 9) and characters (+, # and *).
- The maximum supported telephone number length is as follows:
 - International telephone number: + and telephone numbers (to 18 digits).
 - Except for international telephone number: telephone numbers (to 19 digits).

Making a call using a phone book

You can make calls using the vehicle phone book or mobile phone book of the Bluetooth® 2.0 interface.

For details on the phone books, refer to “Phone book function” on page 5-62.

1. Press the SPEECH button.
2. Say “Call.”

NOTE

- If you say “Call” when the vehicle phone book and the mobile phone book are empty, the voice guide will say “The vehicle phone book is empty. Would you like to add a new entry now?” Answer “Yes,” and the voice guide will say “Entering the phone book - new entry menu.” You can now create data in the vehicle phone book. Answer “No,” to return to the main menu.

3. After the voice guide says “Name please,” say the name you want to call, from those registered in the phone book.
4. If there is only 1 match, the system will proceed to Step 5. If there are 2 or more match-

Operating a music player connected via Bluetooth®

E00761000016

For the operation of a music player connected via Bluetooth®, refer to “To play tracks from a Bluetooth® device” on page 5-37.

How to make or receive hands-free calls

E00761100020

You can make or receive hands-free calls using a Bluetooth® compatible cellular phone connected to the Bluetooth® 2.0 interface.

You can also use the phone books in the Bluetooth® 2.0 interface to make calls without dialling telephone numbers.

es, the voice guide will say “More than one match was found, would you like to call <returned name>.” If that person is the one you want to call, answer “Yes.” Answer “No,” and the name of the next matching person will be uttered by the voice guide.

NOTE

- If you say “No” to all names read by the system, the voice guide will say “Name not found, returning to main menu” and the system will return to the main menu.
- 5. If only one telephone number is registered under the name you just said, the voice guide proceeds to Step 6.

If two or more telephone numbers are registered that match the name you just said, the voice guide will say “Would you like to call <name> at [home], [work], [mobile], or [other]?” Select the location to call.

NOTE

- If the name you selected has matching data in the vehicle phone book but no telephone number is registered under the selected location, the voice guide will say “{home/work/mobile/other} not found for <name>. Would you like to add location or try again?” Say “Try again,” and the system will return to Step 3. Say “Add location” and you can register an additional telephone number under the selected location.

- If the name you selected has matching data in the mobile phone book but no telephone number is registered under the selected location, the voice guide will say “{home/work/mobile/other} not found for <name>. Would you like to try again?” Answer “Yes,” and the system will return to Step 3. Answer “No,” and the call will be cancelled. Start over again from Step 1.

6. The voice guide will say “Calling <name> <location>” and then the system will dial the telephone number.

NOTE

- When the confirmation function is on, the system will ask if the name and location of the receiver are correct. If the name is correct, answer “Yes.” To change the name or location to call, answer “No.” The system will return to Step 3.

Redialing

You can redial the last number called, based on the history of dialed calls in the paired cellular phone. Use the following procedure to redial.

1. Press the SPEECH button.
2. Say “Redial.”

SEND function

During a call, press the SPEECH button to enter voice recognition mode, then say “<numbers> SEND” to generate DTMF tones.

For example, if during a call you need to simulate the press of a phone button as a response to an automated system, press the SPEECH button and speak “1 2 3 4 pound SEND” and the 1234# will be sent on your cellular phone.

Receiving calls

E00761600012

If an incoming phone call is received while the ignition switch is in the “ACC” or “ON” position, the audio system will be automatically turned on and switched to the incoming call, even when the audio system was originally off.

The voice guide announcement for the incoming call will be output from the front passenger’s seat speaker.

If the CD player or radio was playing when the incoming call was received, the audio system will mute the sound from the CD player or radio and output only the incoming call.

To receive the call, press the PICK-UP button on the steering wheel control switch.

When the call is over, the audio system will return to its previous state.

MUTE function

E00760300041

At any time during a call, you can mute the vehicle microphone.

Pressing the SPEECH button and then saying “Mute” during a call will turn ON the MUTE function and mute the microphone.

Saying “Mute off” in the same way will turn off the MUTE function and cancel the mute on the microphone.

For pleasant driving

Switching between hands-free mode and private mode

E00761400036

The Bluetooth® 2.0 interface can switch between Hands-free mode (Hands-free calls) and private mode (calls using cellular phone).

If you press the SPEECH button and say “Transfer call” during a Hands-free call, you can stop the Hands-free mode and talk in private mode.

To return to Hands-free mode, press the SPEECH button again and say “Transfer call”.

Phone book function

E00763700017

The Bluetooth® 2.0 interface has 2 types of unique phone books that are different from the phone book stored in the cellular phone. They are the vehicle phone book and the mobile phone book.

These phone books are used to register telephone numbers and to make calls to desired numbers via the voice recognition function.

NOTE

- Disconnecting the battery cable will not delete information registered in the phone book.

Vehicle phone book

E00763800177

This phone book is used when making calls with the voice recognition function.

Up to 32 names can be registered in the vehicle phone book per language.

Also, each entry has 4 locations associated with: home, work, mobile and other. You can register one telephone number for each location.

You can register a desired name as a name for any phone book entry registered in the vehicle phone book.

Names and telephone numbers can be changed later on.

The vehicle phone book can be used with all paired cellular phones.

To register a telephone number in the vehicle phone book

You can register a telephone number in the vehicle phone book in the following 2 ways: Reading out a telephone number, and selecting and transferring 1 phone book entry from the phone book of the cellular phone.

To register by reading out a telephone number

1. Press the SPEECH button.
2. Say “Phone book.”
3. The voice guide will say “Select one of the following: new entry, edit number, edit name, list names, delete, erase all, or import contact.” Say “New entry.”
4. The voice guide will say “Name please.” Say your preferred name to register it.

NOTE

- If the maximum number of entries are already registered, the voice guide will say “The phone book is full. Would you like to delete a name?” Say “Yes” if you want to delete a registered name. Say “No,” to return to the main menu.
5. When the name has been registered, the voice guide will say “home, work, mobile, or other?” Say the location for which you want to register a telephone number.

NOTE

- When the confirmation function is on, the voice guide will say “<Location>. Is this correct?” Answer “Yes.” Answer “No” to return to location selection in Step 5.
- If a telephone number has been registered for the selected location, the voice guide will say “The current number is <telephone number>, number please.”
- If you do not want to change the telephone number, say “cancel” or the original number to keep it registered.

6. The voice guide will say “Number please.” Say the telephone number to register it.

NOTE

- In the case of English, the system will recognise both “zero” and “oh” (Letter “o”) for the number “0.”
7. The voice guide will repeat the telephone number you have just read, and then register the number.
- When the telephone number has been registered, the voice guide will say “Number saved. Would you like to add another number for this entry?”
- To add another telephone number for a new location for the current entry, answer “Yes.” The system will return to location selection in Step 5.
- Answer “No” to end the registration process and return to the main menu.

NOTE

- When the confirmation function is on, after repeating the telephone number you have read, the voice guide will ask “Is this correct?” Answer “Yes.” Answer “No” to return to telephone number registration in step 6.

To select and transfer one phone book entry from the phone book of the cellular phone

You can select 1 phone book entry from the phone book of the cellular phone and register it in the vehicle phone book.

NOTE

- Transfer is not permitted unless the vehicle is parked. Before transferring, make sure that the vehicle is parked in a safe location.
- All or part of data may not be transferred, even when the cellular phone supports Bluetooth®, depending on the compatibility of the device.
- The maximum supported telephone number length is 19 digits. Any telephone number of 20 digits or more will be truncated to the first 19 digits.
- If telephone numbers contain characters other than 0 to 9, *, # or +, these characters are deleted before the transfer.
- For the connection settings on the cellular phone side, refer to the instructions for the cellular phone.

1. Press the SPEECH button.
2. Say “Phone book.”

3. The voice guide will say “Select one of the following: new entry, edit number, edit name, list names, delete, erase all, or import contact.” Say “Import contact.”
4. The voice guide will say “Would you like to import a single entry or all contacts?” Say “Single entry.”
The Bluetooth® 2.0 interface will become ready to receive transferred phone book data.

NOTE

- If the maximum number of entries are already registered, the voice guide will say “The phone book is full. Would you like to delete a name?” Say “Yes” if you want to delete a registered name. Say “No,” to return to the main menu.
5. After the voice guide says “Ready to receive a contact from the phone. Only a home, a work, and a mobile number can be imported,” the Bluetooth® 2.0 interface will receive the phone book data from the Bluetooth® compatible cellular phone.
 6. Operate the Bluetooth® compatible cellular phone to set it up so that the phone book entry you want to register in the vehicle phone book can be transferred to the Bluetooth® 2.0 interface.

NOTE

- If the Bluetooth® 2.0 interface cannot recognise the Bluetooth® compatible cellular phone or the connection takes too much time, the voice guide will say “Import contact has timed out” and then the system will cancel the registration. In such case, start over again from Step 1.
 - Pressing the HANG-UP button or pressing and holding the SPEECH button will cancel the registration.
7. When the reception is complete, the voice guide will say “<Number of telephone numbers that had been registered in the import source> numbers have been imported. What name would you like to use for these numbers?”
Say the name you want to register for this phone book entry.

NOTE

- If the entered name is already used for other phone book entry or similar to a name used for other phone book entry, that name cannot be registered.
8. The voice guide will say “Adding <name>.” When the confirmation function is on, the system will ask if the name is correct. Answer “Yes.” Answer “No,” and the voice guide will say “Name please.” Register a different name.
 9. The voice guide will say “Numbers saved.”

For pleasant driving

10. The voice guide will say “Would you like to import another contact?”

Answer “Yes” if you want to continue with the registration. You can continue to register a new phone book entry from Step 5.

Answer “No,” to return to the main menu.

To change the content registered in the vehicle phone book

You can change or delete a name or telephone number registered in the vehicle phone book.

You can also listen to the list of names registered in the vehicle phone book.

NOTE

- The system must have at least one entry.

[Editing a telephone number]

1. Press the SPEECH button.
2. Say “Phone book.”
3. The voice guide will say “Select one of the following: new entry, edit number, edit name, list names, delete, erase all, or import contact.” Say “Edit number.”
4. The voice guide will say “Please say the name of the entry you would like to edit, or say list names.” Say the name of the phone book entry you want to edit.

NOTE

- Say “List names,” and the names registered in the phone book will be read out in order. Refer to “Listening to the list of registered names” on page 5-62.

5. The voice guide will say “Home, work, mobile or other?” Select and say the location where the telephone number you want to change or add is registered.

When the confirmation function is on, the system will check the target name and location again. Answer “Yes” if you want to continue with the editing.

Answer “No” to return to Step 3.

6. The voice guide will say “Number please.” Say the telephone number you want to register.

NOTE

- If the telephone number is already registered in the selected location, the voice guide will say “The current number is <current number>. New number, please.” Say a new telephone number to change the current number.

7. The voice guide will repeat the telephone number.

When the confirmation function is on, the system will ask if the number is correct. Answer “Yes.”

Answer “No” to return to Step 3.

8. Once the telephone number is registered, the voice guide will say “Number saved” and then the system will return to the main menu.

NOTE

- If the location where a telephone number was already registered has been overwritten with a new number, the voice guide will say “Number changed” and then the system will return to the main menu.

[Editing a name]

1. Press the SPEECH button.

2. Say “Phone book.”

3. The voice guide will say “Select one of the following: new entry, edit number, edit name, list names, delete, erase all, or import contact.” Say “Edit name.”

4. The voice guide will say “Please say the name of the entry you would like to edit, or say list names.” Say the name you want to edit.

NOTE

- Say “List names,” and the names registered in the phone book will be read out in order. Refer to “Vehicle phone book: Listening to the list of registered names” on page 5-62.

5. The voice guide will say “Changing <name>.” When the confirmation function is on, the system will ask if the name is correct. Answer “Yes” if you want to continue with the editing based on this information.

Answer “No” to return to Step 4.

6. The voice guide will say “Name please.” Say the new name you want to register.

7. The registered name will be changed. When the change is complete, the system will return to the main menu.

[Listening to the list of registered names]

1. Press the SPEECH button.
2. Say “Phone book.”
3. The voice guide will say “Select one of the following: new entry, edit number, edit name, list names, delete, erase all, or import contact.” Say “List names.”
4. Bluetooth® 2.0 interface will read out the entries in the phone book in order.

- When the voice guide is done reading the list, it will say “End of list, would you like to start from the beginning?”
When you want to check the list again from the beginning, answer “Yes.”
When you are done, answer “No” to return to the previous or main menu.

NOTE

- You can call, edit or delete a name that is being read out.
Press the SPEECH button and say “Call” to call the name, “Edit name” to edit it, or “Delete” to delete it.
The system will beep and then execute your command.
- If you press the SPEECH button and say “Continue” or “Previous” while the list is being read, the system will advance or rewind the list. Say “Continue” to proceed to the next entry or “Previous” to return to the previous entry.

[Deleting a telephone number]

- Press the SPEECH button.
- Say “Phone book.”
- The voice guide will say “Select one of the following: new entry, edit number, edit name, list names, delete, erase all, or import contact.” Say “Delete.”
- The voice guide will say “Please say the name of the entry you would like to delete, or say list names.” Say the name of the phone book entry in which the telephone number you want to delete is registered.

NOTE

- Say “List names,” and the names registered in the phone book will be read out in order. Refer to “Vehicle phone book: Listening to the list of registered names” on page 5-62.
- If only one telephone number is registered in the selected phone book entry, the voice guide will say “Deleting <name> <location>.”
If multiple telephone numbers are registered in the selected phone book entry, the voice guide will say “Would you like to delete [home], [work], [mobile], [other], or all?”
Select the location to delete, and the voice guide will say “Deleting <name> <location>.”

NOTE

- To delete the telephone numbers from all locations, say “All.”
- The system will ask if you really want to delete the selected telephone number(s) to go ahead with the deletion, answer “Yes.”
Answer “No,” the system will cancel deleting the telephone number(s) and then return to Step 4.
 - When the deletion of the telephone number is completed, the voice guide will say “<name> <location> deleted” and then the system will return to the main menu.
If all locations are deleted, the system will say “<name> and all locations deleted” and the name will be removed from the phone book. If numbers still remain under the entry, the name will retain the other associated numbers.

Erasing the phone book

You can delete all registered information from the vehicle phone book.

- Press the SPEECH button.
- Say “Phone book.”
- The voice guide will say “Select one of the following: new entry, edit number, edit name, list names, delete, erase all, or import contact.” Say “Erase all.”
- For confirmation purposes, the voice guide will ask “Are you sure you want to erase everything from your handsfree system phone book?” Answer “Yes.”
Answer “No” to cancel the deletion of all registered information in the phone book and return to the main menu.
- The voice guide will say “You are about to delete everything from your hands-free system phone book. Do you want to continue?” Answer “Yes” to continue.
Answer “No” to cancel the deletion of all registered information in the phone book and return to the main menu.
- The voice guide will say “Please wait, erasing the handsfree system phone book” and then the system will delete all data in the phone book.
When the deletion is complete, the voice guide will say “Hands-free system phone book erased” and then the system will return to the main menu.

Mobile phone book

E00763900048

All entries in the phone book stored in the cellular phone can be transferred in a batch and registered in the mobile phone book.

Up to 7 mobile phone books, each containing up to 1,000 names, can be registered.

For pleasant driving

The Bluetooth® 2.0 interface automatically converts from text to voice the names registered in the transferred phone book entries, and creates names.

NOTE

- Only the mobile phone book transferred from the connected cellular phone can be used with that cellular phone.
- You cannot change the names and telephone numbers in the phone book entries registered in the mobile phone book. You cannot select and delete specific phone book entries, either. To change or delete any of the above, change the applicable information in the source phone book of the cellular phone and then transfer the phone book again.

To import a devices phone book

Follow the steps below to transfer to the mobile phone book the phone book stored in the cellular phone.

5

NOTE

- Transfer should be completed while the vehicle is parked.
Before transferring, make sure that the vehicle is parked in a safe location.
- The already stored phone book in the mobile phone book is overwritten by the stored phone book in the cellular phone.
- All or part of data may not be transferred, even when the cellular phone supports Bluetooth®, depending on the compatibility of the device.
- Only a home, a work, and a mobile number can be imported.

- The maximum supported telephone number length is 19 digits. Any telephone number of 20 digits or more will be truncated to the first 19 digits.
- If telephone numbers contain characters other than 0 to 9, *, # or +, these characters are deleted before the transfer.
- For the connection settings on the cellular phone side, refer to the instructions for the cellular phone.

1. Press the SPEECH button.
2. Say “Phone book.”
3. The voice guide will say “Select one of the following: new entry, edit number, edit name, list names, delete, erase all, or import contact.” Say “Import contact.”
4. The voice guide will say “Would you like to import a single entry or all contacts?” Say “All contacts.”
5. The voice guide will say “Importing the contact list from the mobile phone book. This may take several minutes to complete. Would you like to continue?” Answer “Yes,” transferring to the mobile phone book the phone book stored in the cellular phone will start.
Answer “No,” to return to the main menu.

NOTE

- The transfer may take some time to complete depending on the number of contacts.
- If the Bluetooth® 2.0 interface could not be connected to the Bluetooth® compatible cellular phone, the voice guide will say “Unable to transfer contact list from phone” and then the system will return to the main menu.

- If you press the HANG-UP button or press and hold the SPEECH button during the data transfer, the transfer will be cancelled and the system will return to the main menu.
 - If an error occurs during the data transfer, all transfer will be cancelled and the voice guide will say “Unable to complete the phone book import” and then the system will return to the main menu.
 - If there are no contacts in the phone book, the voice guide will say “There are no contacts on the connected phone.”
6. When the transfer is complete, the voice guide will say “Import complete” and then the system will return to the main menu.

Enrollment commands

E00732400249

Phrase	English	French	Spanish	Italian	German	Dutch	Portuguese	Russian
1	123456789	123456789	123456789	123456789	123456789	123456789	123456789	123456789
2	888 555 1212	888 555 1212	888 555 1212	888 555 1212	888 555 1212	888 555 1212	888 555 1212	888 555 1212
3	Call	Appeler	Lllamar	Chiama	Anrufen	Bellen	Ligar	Вызов
4	Dial	Composer	Marcar	Componi	Wählen	Nummer keuze	Marcar	Набор
5	Setup	Configurer	Configuración	Configura	Einrichtung	Setup	Configurar	Настройка
6	Cancel	Annuler	Cancelar	Annulla	Abbrechen	Annuleren	Cancelar	Отмена
7	Continue	Continuer	Continuar	Continua	Weiter	Doorgaan	Continuar	Продолжить
8	Help	Aide	Ayuda	Aiuto	Hilfe	Help	Ajuda	Справка

For pleasant driving

USB input terminal*

E00761900015

You can connect your USB memory device or iPod* to play music files stored in the USB memory device or iPod.

The following explains how to connect and remove a USB memory device or iPod.

Refer to the following sections for details on how to play music files:

Refer to “To play tracks from USB device” on page 5-28.

*: “iPod” is a registered trademark of Apple Inc. in the United States and other countries.

How to connect a USB memory device

E00762000202

To connect

1. Park your vehicle in a safe place and turn the ignition switch to the “LOCK” position.
2. Open the glove box and remove the connector cable (A) from clips (B).

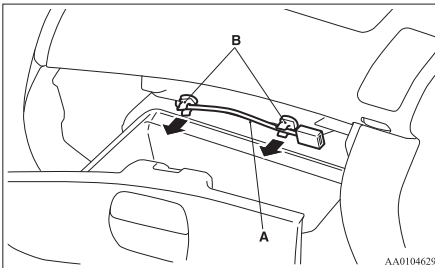

AA0104629

3. Connect the USB memory device (C) to the connector cable (A).

Be sure to hold the terminal part (D) of the connector cable as shown in the illustration.

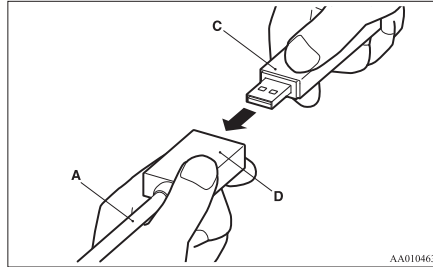

AA0104632



CAUTION

- Keep the lid of the glove box closed while driving the vehicle. A lid or the contents of the glove box could otherwise cause injuries.

NOTE

- When closing the glove box, be careful not to trap the connector cable and USB memory device.

To remove

1. Turn the ignition switch to the “LOCK” position.
2. Remove the USB memory device (C).

Be sure to hold the terminal part (D) of the connector cable as shown in the illustration.

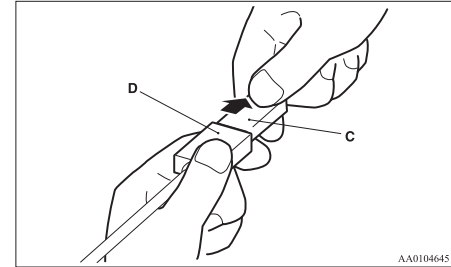

AA0104645

3. Fix the connector cable on the clips and close the glove box.

How to connect an iPod

E00762100186

To connect

1. Park your vehicle in a safe place and turn the ignition switch to the “LOCK” position.
2. Open the glove box and remove the connector cable (A) from clips (B).

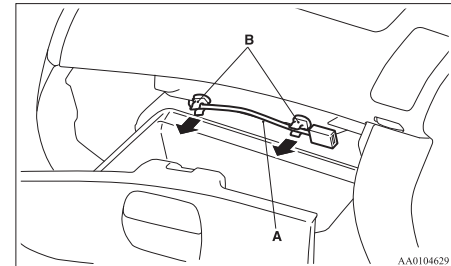

AA0104629

3. Connect the Dock connector (C) to the iPod (D).

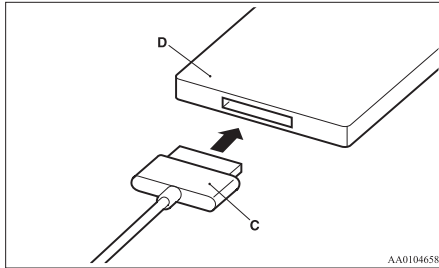

NOTE

- Use a genuine Dock connector from Apple Inc.

4. Connect the Dock connector (C) to the connector cable (A).
Be sure to hold the terminal part (E) of the connector cable as shown in the illustration.

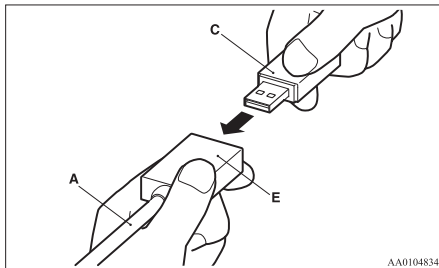

CAUTION

- Keep the lid of the glove box closed while driving the vehicle. A lid or the contents of the glove box could otherwise cause injuries.

NOTE

- When closing the glove box, be careful not to trap the connector cable and iPod.

To remove

1. Turn the ignition switch to the “LOCK” position.
2. Remove the Dock connector (C).
Be sure to hold the terminal part (E) of the connector cable as shown in the illustration.

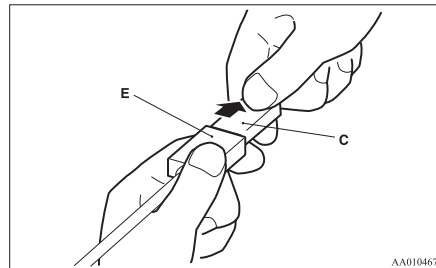

3. Fix the connector cable on the clips and close the glove box.

Types of connectable devices and supported file specifications

E00762200015

Device types

E00762300306

Devices of the following types can be connected.

Model name	Condition
USB memory device	Storage capacity of 256 Mbytes or more
iPod touch*	F/W Ver.1.1.1 or later
iPod classic*	F/W Ver.1.0 or later
iPod (fifth generation)*	F/W Ver.1.2.2 or later
iPod nano (fifth generation)*	F/W Ver.1.2 or later
iPod nano (second generation)*	F/W Ver.1.1.2 or later
Models other than USB memory devices and iPods	Digital audio player supporting mass storage class

*: “iPod touch,” “iPod classic,” “iPod” and “iPod nano” are registered trademarks of Apple Inc. in the United States and other countries.

NOTE

- Depending on the type of the USB memory device or other device connected, the connected device may not function properly or the available functions may be limited.
- It is recommended to use an iPod with firmware updated to the latest version.

For pleasant driving

- You can charge your iPod by connecting it to the USB input terminal when the ignition switch is in the “ACC” or “ON” position.
- Do not keep your USB memory device or iPod in your vehicle.
- It is recommended that you back up files in case of data damage.
- Do not connect to the USB input terminal any device (hard disk, card reader, memory reader, etc.) other than the connectable devices specified in the previous section. The device and/or data may be damaged. If any of these devices was connected by mistake, remove it after turning the ignition switch to the “LOCK” position.

File specifications

E00762400017

You can play music files of the following specifications that are saved in a USB memory device or other device supporting mass storage class.

Item	Condition
File format	MP3, WMA, AAC, WAV
Maximum number of levels (including the root)	Level 8
Number of folders	700
Number of files	65,535

Sun visors

E00711200693

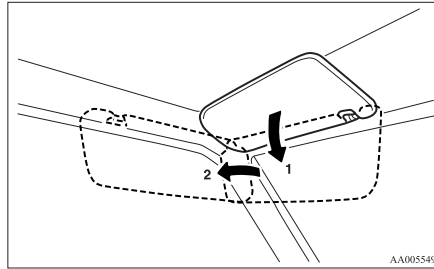

- 1- To eliminate front glare
- 2- To eliminate side glare

AA0055499

Card holder*

Cards can be slipped into the front (A) of the lid of the passenger side vanity mirror.

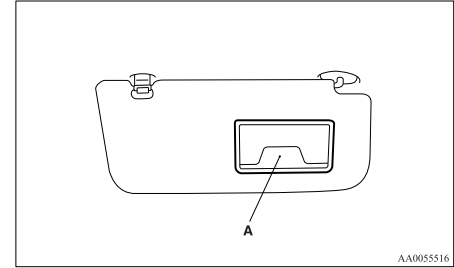

AA0055516

Ticket holder*

The driver's sun visor is provided with a ticket holder (A) on the backside.

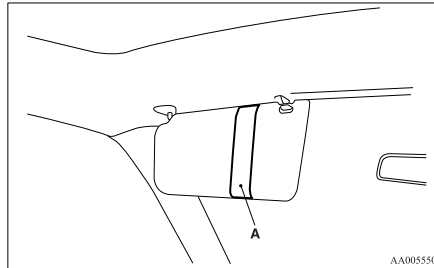

AA0055503

Vanity mirror*

E00711300489

A vanity mirror is fitted to the back of the sun visor on the passenger side.

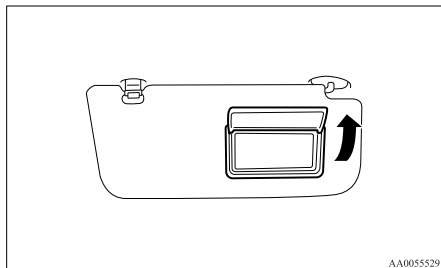

AA0055529

Ashtray

E00711400826

CAUTION

- Put out matches and cigarettes before they are placed in the ashtray.
- Don't put papers and other things that burn into your ashtrays. If you do, cigarettes or other smoking materials could set them on fire, causing damage.
- Always close the ashtray. If left open, other cigarette butts in the ashtray may be re-kindled.

Type 1 (fixed position)

To use the ashtray, pull it out.

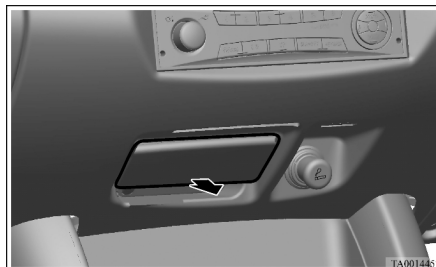

TA0014437

For pleasant driving

To remove the ashtray, pull it out while pressing the stop (A).

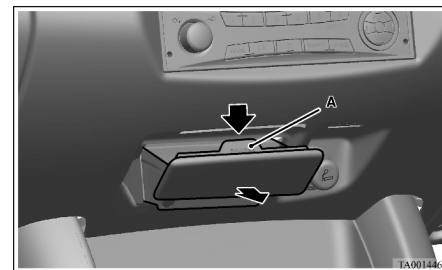

TA0014460

Type 2 (moveable)

To use the moveable ashtray, open the lid.

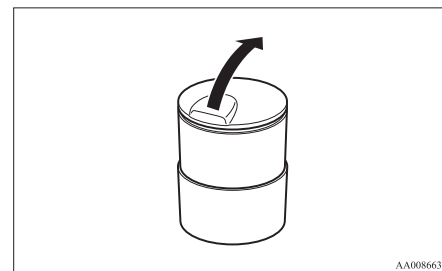

AA0086639

Mounting position for moveable ashtray

The moveable ashtray can be fitted at the indicated position.

For pleasant driving

Refer to “Cup holder” on page 5-79.

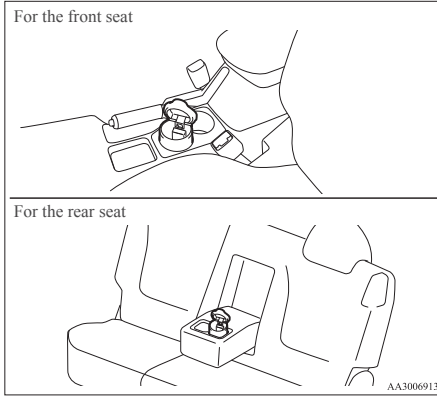

Cigarette lighter

E00711501257

The cigarette lighter can be used while the ignition switch is in the “ON” or “ACC” position.

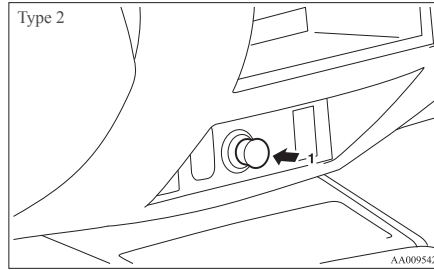
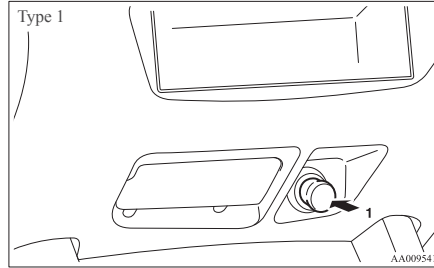

1- Push all the way in.

The lighter will automatically return to its original position with a “click” when ready. Pull it out for use.

After use, insert the lighter to its original position in the socket.

NOTE

- Do not leave the cigarette lighter removed from its socket, because the socket might become clogged by foreign material and be short-circuited.

⚠ CAUTION

- Do not touch heating element or lighter housing. Hold only the knob to prevent burns.
- Do not allow children to operate or play with the cigarette lighter as burns may occur.
- Something is wrong with the cigarette lighter if it does not pop back out within approximately 30 seconds of being pushed in.

Leaving the cigarette lighter pushed in for an extended period could cause fire. If it does not pop out by itself, we recommend you to have it checked.

- Do not leave the cigarette lighter pushed in or insert the cigarette lighter from another vehicle. Otherwise, the lighter may overheat and cause fire.
- It is recommended that only the lighter be inserted in its socket.

Use of “plug-in” type accessories may damage the socket and result in poor retention of the lighter.

CAUTION

- When the cigarette lighter socket is used as a power source for an electric appliance, be sure that the electric appliance operates at 12 V and has an electric capacity of 120 W or less. In addition, long use of the electric appliance without running the engine may run down the battery.

Accessory socket*

E00711601160

The accessory socket can be used while the ignition switch is in the “ON” or “ACC” position. Open the cap (A) to uncover the socket. Use it to plug in an electrical device.

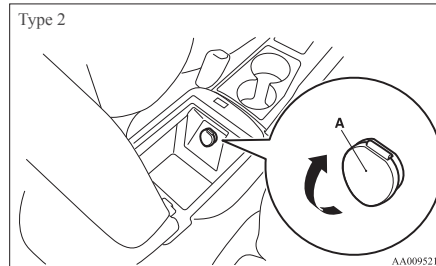
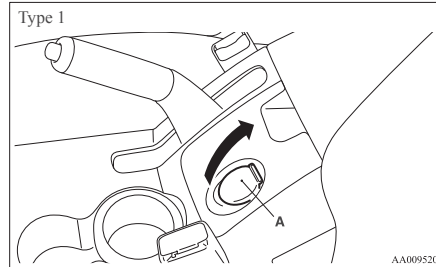

CAUTION

- When you connect an electrical device, make sure it is rated at 12 V and its electrical capacity does not exceed 120 W. Remember that prolonged use of an electrical device with the engine off could run down the battery.
- When the accessory socket is not in use, be sure to close the cap, because the socket might become clogged by foreign material and be short-circuited.

NOTE

- Long use of the electric appliance without running the engine may run down the battery. Especially avoid using it with the cigarette lighter.

For pleasant driving

Digital clock*

E00711700193

The digital clock indicates the time with the ignition switch in either "ON" or "ACC" position.

To set the time

Set the time by pressing the various buttons as described below.

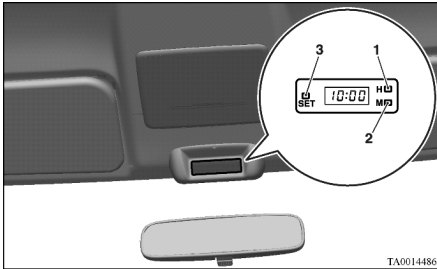

TA0014486

- 1- To adjust the hour
- 2- To adjust the minutes
- 3- To reset the minutes to zero

10:30 - 11:29..... Changes to 11:00

11:30 - 12:29..... Changes to 12:00

NOTE

- If the battery cables are disconnected during repairs or for any other reason, reset the clock to the correct time after they are reconnected.

Interior lamps

E00712000917

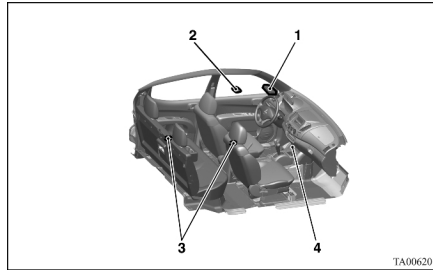

TA0062012

- 1- Room lamp (Front)*
Personal lamps*
- 2- Room lamp (Rear)*
- 3- Door courtesy lamps*
- 4- Centre console downlight

NOTE

- If you leave the lamps on without running the engine, you will run down the battery. Before you leave the vehicle, make sure that all the lamps are off.

Room lamps

E00712101289



TA0063530

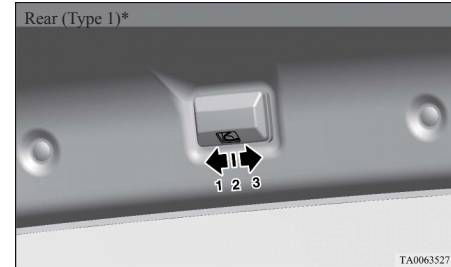

TA0063527

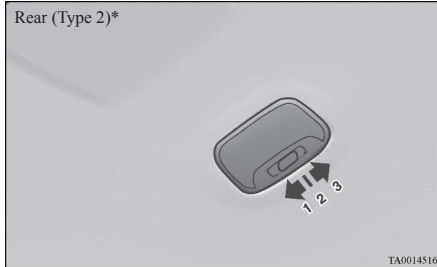

1
(ON/☑) - The lamp illuminates.

2
(●) -

[Vehicles without central door locks system]

The room lamp goes on when a door is opened. When all doors are closed, the room lamp is illuminated and dimmed gradually for 7 seconds then goes out.

However, the lamp goes out immediately without being dimmed when the ignition switch is turned to the “ON” position.

[Vehicles with central door locks system]

The room lamp goes on when a door is opened. When all doors are closed, the room lamp is illuminated and dimmed gradually for 15 seconds then goes out.

However, the lamp goes out immediately without being dimmed in case of the followings:

- All doors are closed and the ignition switch is turned to the “ON” position.
- All doors are locked using the key mechanism of the driver’s door, the lock knob of the driver’s door, or the remote control switch of the keyless entry system (if so equipped).

NOTE

- On vehicles with keyless entry system, when the ignition key is removed with the doors closed, the lamp is illuminated and after about 15 seconds it goes off.

The dimming period is also adjustable.

For further information, we recommend you to consult a MITSUBISHI MOTORS Authorized Service Point.

3
(OFF/○) - The lamp goes off.

Personal lamps*

E00712500156

Push the switch (A) to turn on the lamp. Push it again to turn it off.

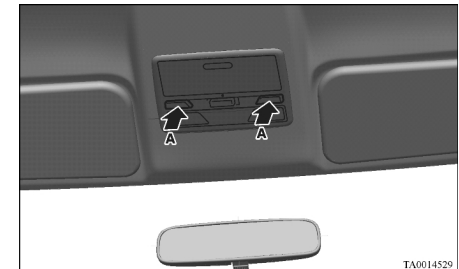

For pleasant driving

Door courtesy lamps*

E0071750034

Each door courtesy lamp comes on when the relevant door is opened and goes off when the door is closed.

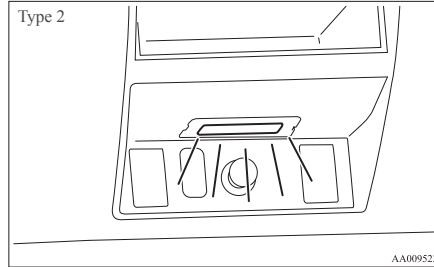

Centre console downlight

E00733300043

The centre console downlight goes on when the lamp switch is in the "☰" or the "☷" position. Refer to "Combination headlamps and dipper switch" on page 3-30.

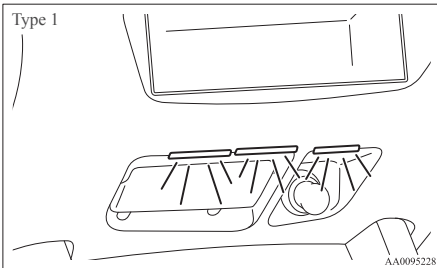

Storage spaces

E00713101938

⚠ CAUTION

- Never leave lighters, cans of carbonated drink, and spectacles in the cabin when parking the vehicle in hot sunshine. The cabin will become extremely hot, so lighters and other flammable items may catch fire and unopened drink cans (including beer cans) may rupture. The heat may also deform or crack plastic spectacle lenses and other spectacle parts that are made of plastic.
- Keep the lids of storage spaces closed while driving the vehicle. A lid or the contents of a storage space could otherwise cause injuries.

NOTE

- Do not leave valuables in any storage space when leaving the vehicle.

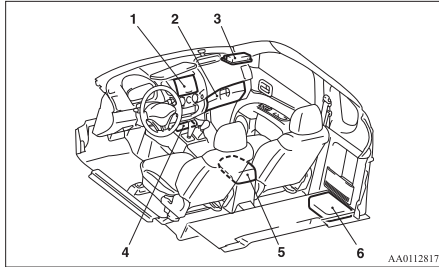

- 1- Utility box*
- 2- Glove box
- 3- Sunglasses holder*
- 4- Front console box*
- 5- Floor console box*
- 6- Secret box (Club cab)

Glove box

E00717601478

NOTE

- When the lamp switch is in the “☀️” or “☞” position, the glove box lamp illuminates. Refer to “Combination headlamps and dipper switch” on page 3-30.
- The USB input terminal (if so equipped) is located in the glove box. For details, refer to “USB input terminal” on page 5-68.

Type 1
To open, pull the lever (A).

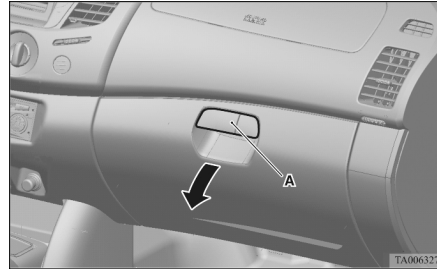

Type 2
The glove box can be locked and unlocked using the key.

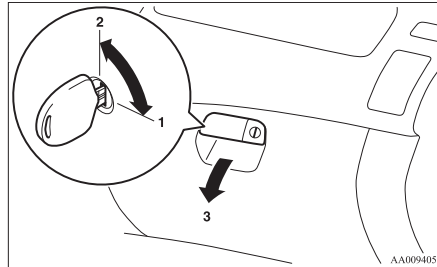

- 1- To lock
- 2- To unlock
- 3- To open, pull the lever

Front console box*

E00733400161

To open, pull up the knob (A).

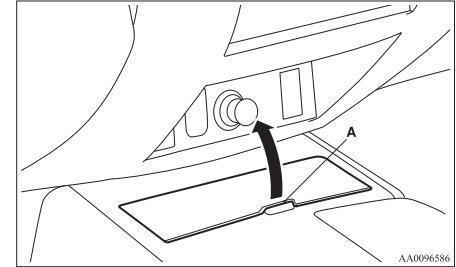

Floor console box*

E00723300574

Type 1
To open, raise the lid.

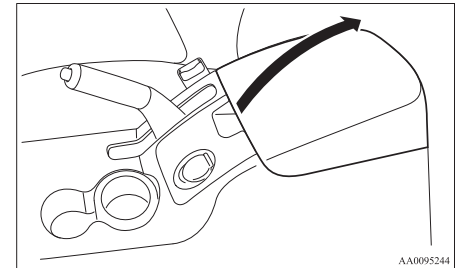

Type 2
Upper and lower boxes are located inside the floor console box.

For pleasant driving

The floor console box can also be used as an armrest.

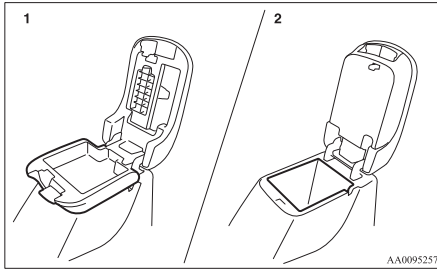

- 1- Upper box
- 2- Lower box

NOTE

- The Auxiliary Audio connector (RCA) is located in the lower box (if so equipped). For details, refer to “To use the external audio input function” on page 5-40.

Upper box

To open the upper box, lift the right release lever (A) and raise the lid.

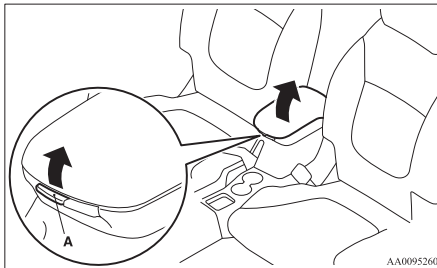

Lower box

To open the lower box, lift the left release lever (B) and raise the lid.

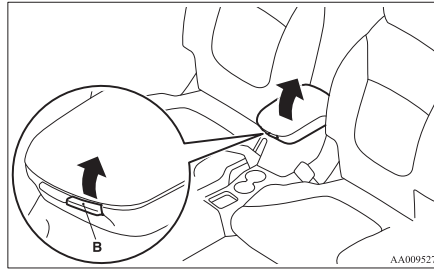

Utility box*

To open, pull up the knob (A).

E00717900100

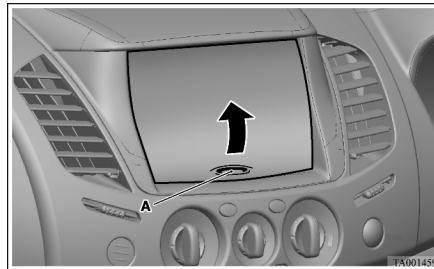

Sunglasses holder*

Push the lid to open.

E00718600250

Close the lid by pushing it till it clicks.

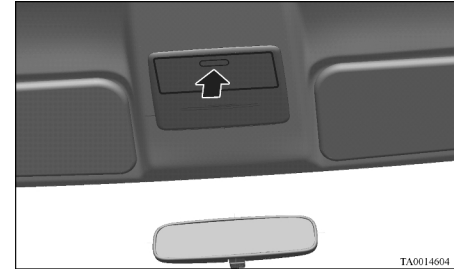

CAUTION

- The holder should not be used to store anything heavier than sunglasses. These objects could drop out.

NOTE

- The holder may not be able to accommodate every possible size and shape of sunglasses; it is advisable to check compatibility before use.

Secret box (Club cab)

The secret box is in the floor behind the seat.

E00724900043

To use the box, open the lid.

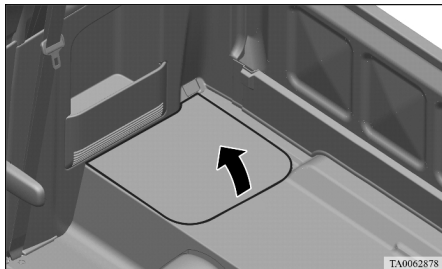

Cup holder*

E00714500802

CAUTION

- Do not drink beverages while driving the vehicle; doing so could distract you and result in an accident.

For the front seat

The cup holder is located between the front seats.

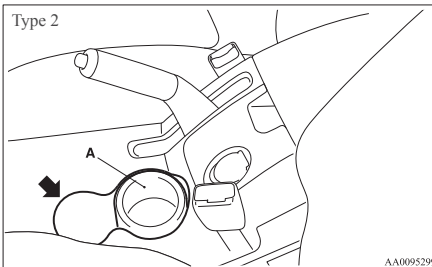
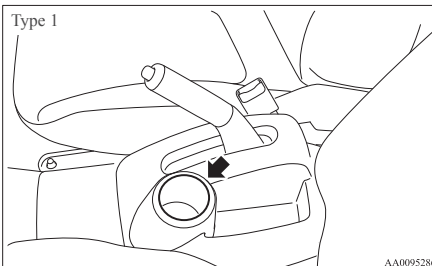

For pleasant driving

NOTE

- The cup holder adapter (A) can be removed to enable the cup holder to hold relatively large cup. Remove the cup holder adapter when necessary.

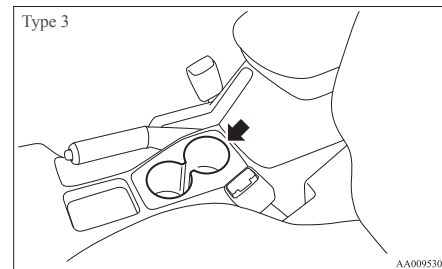

For the rear seat (Double cab)

E00716900389

In order to use the cup holder, allow the armrest to drop down.

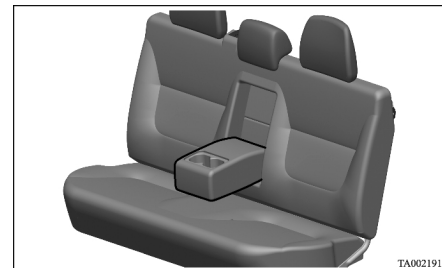

For pleasant driving

Bottle holder

E00718200171

CAUTION

- Do not drink beverages while driving the vehicle; doing so could distract you and result in an accident.
- Beverages can spill due to vibration or other movement during vehicle operation. Be careful not to get scalded by a hot beverage if spilled

NOTE

- Make sure the cap of any plastic bottle placed in a bottle holder is tightly closed.
- The bottle holders may not accommodate bottles of certain shapes and sizes.

For the front seat

The bottle holders are provided at both sides.

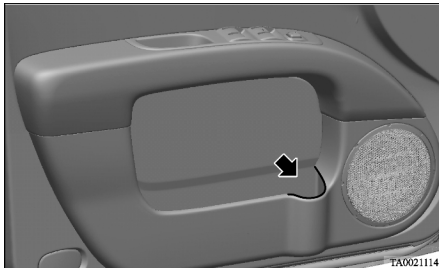

For the rear seat (Double cab)

The bottle holders are provided at both sides.

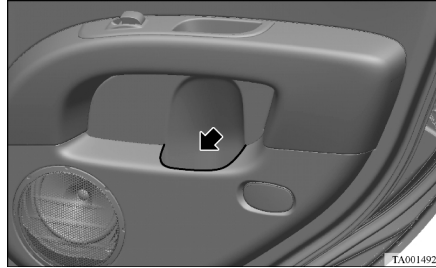

Convenient hook

E00732900071

Light items of luggage can be hung from the hook.

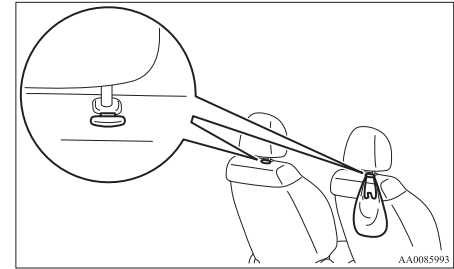

NOTE

- Do not hang heavy luggage (more than about 4 kg) on the hook. Doing so could cause damage to the hook.

Coat hook*

E00725600438

There is a coat hook on the rear seat assist grip.

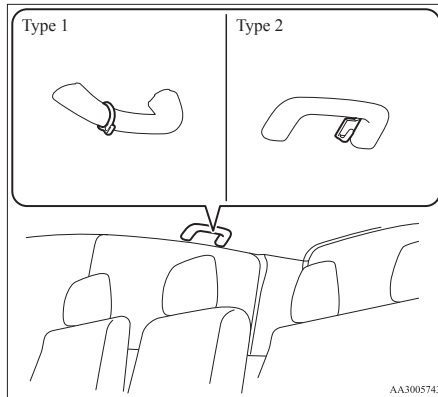

⚠ WARNING

- Do not put a hanger or any heavy or pointed object on the coat hook. If the curtain airbag was activated, any such item could be propelled away with great force and could prevent the curtain airbag from inflating correctly. Hang clothes directly on the coat hook (without using a hanger). Make sure there are no heavy or sharp objects in the pockets of clothes that you hang on the coat hook.

First-aid kit and warning triangle securing bands*

E00717200028

A first-aid kit and a warning triangle can be secured with the band(s) installed in the illustrated position.

Single cab, Double cab

The wall behind the seat is provided with a band for securing a first-aid kit and a warning triangle.

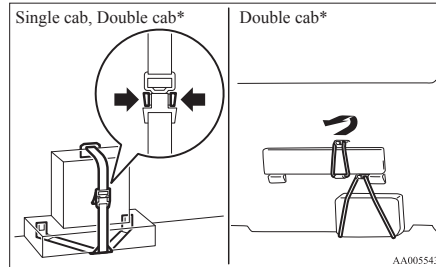

Club cab

A band for securing a first-aid kit is installed in the secret box.

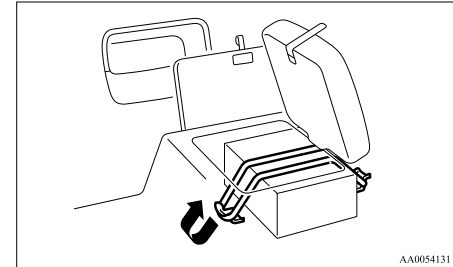

A band for securing a warning triangle is installed left under the rear seat.

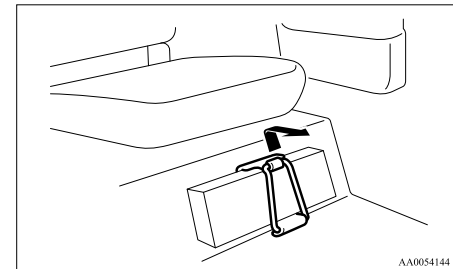

A series of 15 horizontal dashed lines spanning the width of the page, providing a template for handwriting practice.

For emergencies

If the vehicle breaks down.....	6-02
Emergency starting.....	6-02
Engine overheating.....	6-04
Bleeding the fuel system.....	6-05
Removal of water from the fuel filter.....	6-06
Tools, jack and jack handle.....	6-07
Jacking up the vehicle.....	6-13
Spare wheel.....	6-16
How to change a tyre.....	6-17
Towing.....	6-20
Operation under adverse driving conditions.....	6-24

For emergencies

If the vehicle breaks down

E00800101166

If the vehicle breaks down on the road, move it to the shoulder and use the hazard warning flashers and/or the warning triangle etc.

Refer to “Hazard warning flasher switch” on page 3-34.

If the engine stops/fails

Vehicle operation and control are affected if the engine stops.

Before moving the vehicle to a safe area, be aware of the following:

- The brake booster becomes inoperative and the pedal effort will increase. Press down the brake pedal harder than usual.
- Since the power steering pump is no longer operative, the steering wheel feels heavy when turning it.

Emergency starting

E00800502112

If the engine cannot be started because the battery is weak or dead, the battery from another vehicle can be used with jumper cables to start the engine.

⚠ WARNING

- **To start the engine using jumper cables connected from another vehicle, perform the correct procedures according to the instruction manual. Incorrect procedures could result in a fire or explosion or damage to the vehicles.**

1. Get the vehicles close enough so the jumper cables can reach, but be sure the vehicles aren't touching each other.
If they are, it could cause a ground connection you don't want. The vehicle will not start, and the bad grounding could damage the electrical systems.

⚠ CAUTION

- **Check the other vehicle. It must have a 12-volt battery. If the other system isn't 12-volt, shorting can damage both vehicles.**

2. You could be injured if the vehicles move. Set the parking brake firmly on each vehicle. Put an automatic transmission in “P” (PARK) or a manual transmission in “N” (Neutral). Turn off the ignition switch.

⚠ WARNING

- **Turn off the ignition on both vehicles beforehand. Make sure that the cables or your clothes cannot be caught by the fan or drive belt. Personal injury could result.**

NOTE

- Turn off all lamps, heater and other electrical loads. This will avoid sparks and help save both batteries.
3. Make sure battery electrolyte is at the proper level.
Refer to “Battery” on page 8-10.

⚠ WARNING

- **If electrolyte fluid is not visible, or appears to be frozen, Do Not Attempt Jump Starting! A battery might rupture or explode if the temperature is below the freezing point or if it is not filled to the proper level.**

4. Connect one end of one jumper cable to the positive (+) terminal of the discharged battery (A), and the other end to the positive (+) terminal of the booster battery (B).

Vehicles with 1 battery

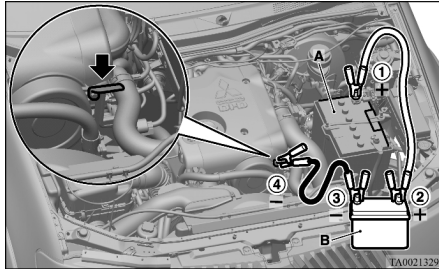

Vehicles with 2 batteries

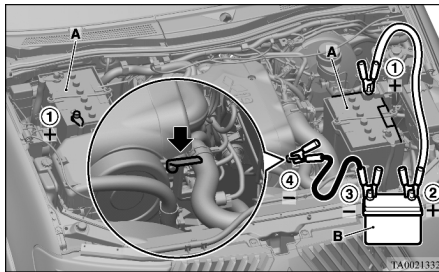

5. Connect one end of the other jumper cable to the negative (-) terminal of the booster battery (B), and the other end to the engine block of the vehicle with the discharged battery at the point farthest from the battery.

NOTE

- Open the cover before connecting the jumper cable to the positive (+) terminal of the battery. (Refer to “Battery” on page 8-10.)

⚠ WARNING

- Be sure to observe the connecting sequence of ①→②→③→④.
- Make sure that the connection ④ is made to the appointed position (shown in the illustration). If the connection is made directly to the negative side of the battery, the inflammable gasses generated from the battery might catch fire and explode.
- When connecting the jumper cables, do not connect the positive (+) cable to the negative (-) terminal. Otherwise sparks might cause explosion of the battery.

⚠ CAUTION

- Take care not to get the jumper cable caught in the cooling fan or other rotating part in the engine compartment.
- Use the proper cables suitable for the battery size. Otherwise heat damage to the cables could result.
- Check the jumper cables for damage and corrosion before use.

6. Start the engine in the vehicle which has the booster battery, let the engine idle a few minutes, then start the engine in the vehicle with the discharged battery.

⚠ CAUTION

- Keep the engine of the vehicle giving assistance running.

7. After the engine is started, disconnect the cables in the reverse order.

⚠ WARNING

- Charging the battery while it is installed in the vehicle might cause the battery to catch fire and explode. Or damage to the vehicle could result. If it has to be charged in that condition for unavoidable reasons, disconnect the vehicle side negative (-) terminal connected to the battery.
- Keep sparks, cigarettes and flames away from the battery because the battery may produce an explosion.
- Use adequate ventilation when charging or using the battery in an enclosed space.
- Remove all the caps before charging the battery.
- Electrolyte is corrosive diluted sulphuric acid. If electrolyte (battery acid) comes into contact with your hands, eyes, clothes and the painted surface of your vehicle, it should be thoroughly flushed with water. If electrolyte gets in your eyes, flush them with water immediately and thoroughly, and get prompt medical attention.

⚠ CAUTION

- Do not attempt to start the engine by pulling or pushing the vehicle. It could damage your vehicle.
- Always wear protective eye goggles when working near the battery.
- Keep the battery out of the reach of children.

NOTE

- On vehicles with anti-lock brake system, if the vehicle is put in motion without fully charging the battery, it might cause the loss of smooth engine operation and the antilock brake warning lamp to illuminate. Refer to “Anti-lock brake system (ABS)” on page 4-39.

Engine overheating

E00800602777

If the water temperature gauge indication remains in the overheating zone for a long time, the engine may be overheating. If this occurs, take the following corrective measures:

1. Stop the vehicle in a safe place.
2. Check whether steam is coming from the engine compartment.

[If steam does not come from the engine compartment]

With the engine still running, raise the bonnet to ventilate the engine compartment.

[If steam is coming from the engine compartment]

Stop the engine, and when the steam stops, raise the bonnet to ventilate the engine compartment. Restart the engine.

⚠ WARNING

- Do not open the bonnet while steam is coming from the engine compartment. It could cause steam or hot water to spurt out, causing burns. Hot water could spurt out even when there is no steam coming out, and some parts will be very hot. Be very careful when opening the bonnet.
- Be careful of hot steam, which could be blowing off the reserve tank cap.
- Do not attempt to remove the radiator cap while the engine is hot.

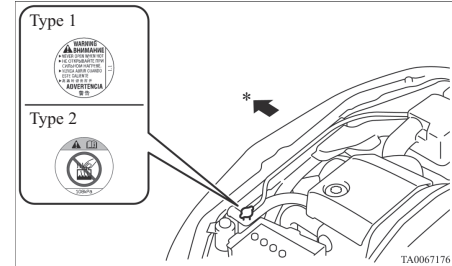

*: Front of the vehicle

3. Confirm that the cooling fan is turning. If the fan is not turning, stop the engine immediately and have it checked.

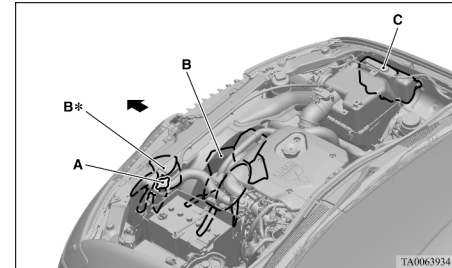

- A- Radiator cap
- B- Cooling fan
- C- Reserve tank
- *: if so equipped

⚠ WARNING

- Be careful not to get your hands or clothes caught in the cooling fan.

4. After the engine coolant temperature has dropped to the normal temperature, stop the engine.

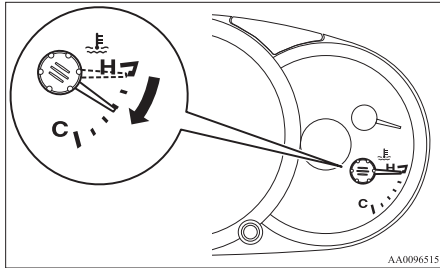

5. Check the coolant level in the reserve tank.

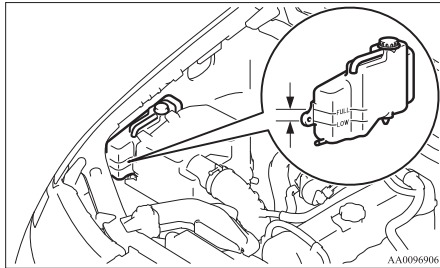

⚠ WARNING

- If there is none, make sure that the engine has cooled down before removing the radiator cap, because hot steam or boiling water otherwise will gush from the filler port and may scald you.

6. Add coolant to the radiator and/or reserve tank if necessary (refer to the "Maintenance" section.)

⚠ CAUTION

- Do not add coolant while the engine is hot. Suddenly adding cold coolant could damage the engine. Wait for the engine to cool down, then add coolant a little at a time.

7. Examine the radiator hoses for coolant leakage and the drive belt for looseness or damage. If there is anything wrong with the cooling system or drive belt, we recommend you to have it checked and repaired.

Bleeding the fuel system

E00800700312

The fuel system should be bled to remove air as described below if the fuel supply is exhausted during travel.

Type 1

1. Loosen the air plug (A) at the top of the fuel filter.

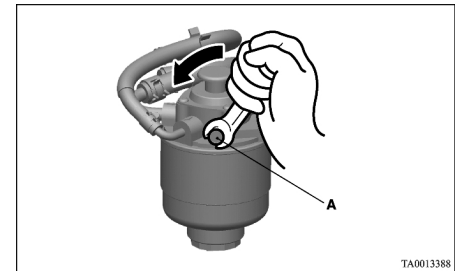

For emergencies

2. Pump the hand pump (B) until there are no more bubbles in the fuel coming out of the air plug (A). When doing this, place a cloth around the air plug (A) to prevent the escaping fuel from spraying out.

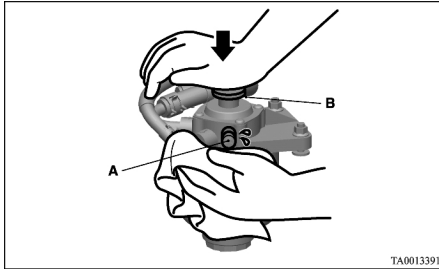

3. Tighten the air plug (A) when there are no more bubbles in the fuel.
4. Continue pumping until the hand pump (B) becomes stiff.
5. Finally, check to be sure that there is no leakage of fuel.
If in doubt, we recommend you to consult a specialist for necessary information.

Type 2, 3

Pump the hand pump (A) at the top of the fuel filter until the hand pump becomes stiff.
Then try again to start the engine.

If the engine does not start, repeat the process above.

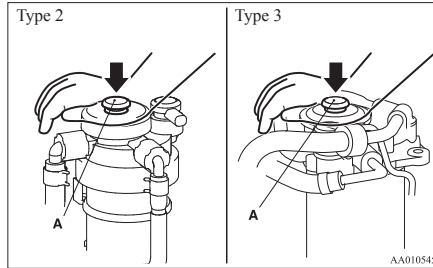

⚠ CAUTION

- Do not smoke or have any other open flame near the vehicle while bleeding the fuel system.
- Be sure to carefully clean away any spilt fuel which could ignite and cause a fire.

Removal of water from the fuel filter

E00800800342

If the fuel filter indication lamp in the instrument panel illuminates during driving, it indicates that water has accumulated in the fuel filter. If this occurs, remove the water as described below.

Type 1, 2

1. Loosen the drain plug (A) of the fuel filter.

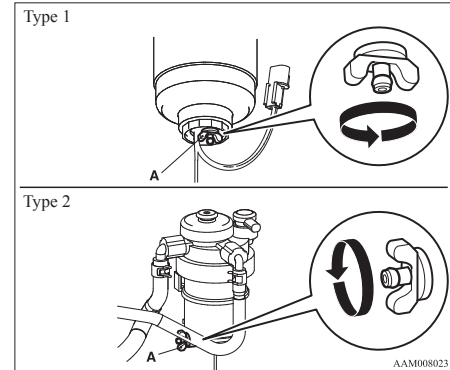

- Operate the hand pump (B) slowly 6 or 7 times in order to force the water out through the drain plug (A).

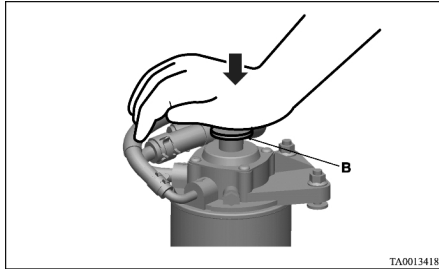

- Tighten the drain plug (A) when water no longer comes out.
- Bleed the air in the fuel system. (Refer to “Bleeding the fuel system” on page 6-05.)
- Check to be sure that the fuel filter indication lamp illuminates when the ignition switch is turned to “ON”, and that it goes off when the engine is started. If in doubt, we recommend you to consult a specialist for necessary information.

⚠ CAUTION

- Do not smoke or have any other open flame near the vehicle while bleeding the fuel system.
- Be sure to carefully clean away any water drained out because any fuel mixed with the water could ignite and cause a fire.

Type 3

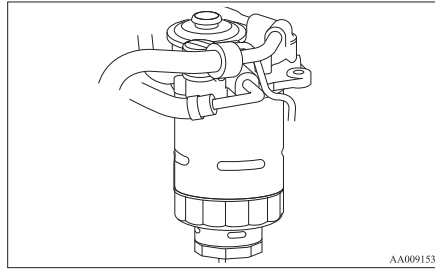

Take your vehicle to a MITSUBISHI MOTORS Authorized Service Point to remove the water from the fuel filter.

Tools, jack and jack handle

E00800900819

Storage

The storage location of the tools, jack and jack handle should be remembered in case of an emergency.

Single cab

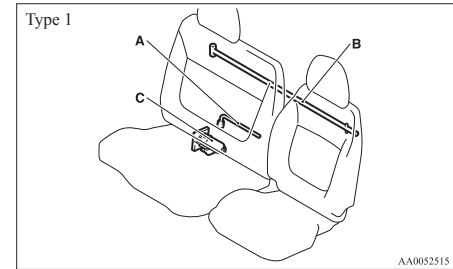

- A- Tool (wheel nut wrench)
- B- Jack handle
- C- Jack

For emergencies

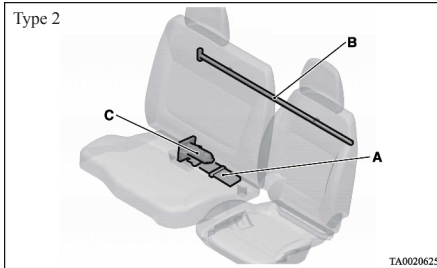

- A- Tools
- B- Jack handle
- C- Jack

Club cab

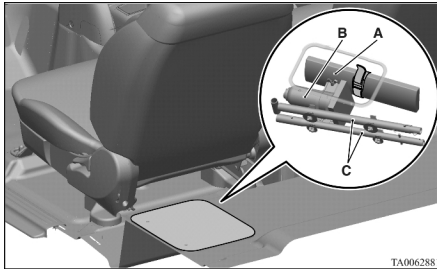

- A- Tools
- B- Jack
- C- Jack handle

Double cab
Except for vehicles with rear retractable power window

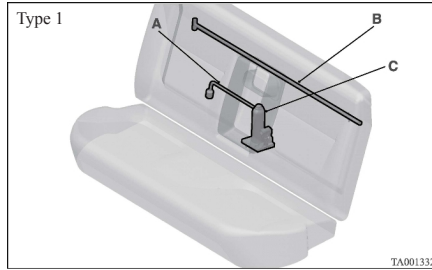

- A- Tool (wheel nut wrench)
- B- Jack handle
- C- Jack

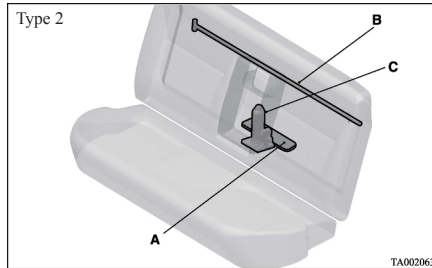

- A- Tools
- B- Jack handle
- C- Jack

Vehicles with rear retractable power window

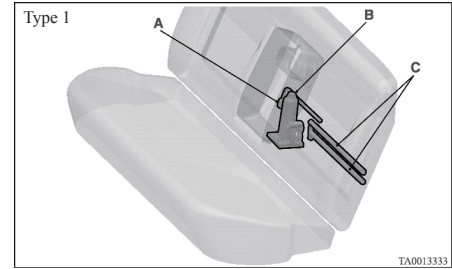

- A- Tool (wheel nut wrench)
- B- Jack
- C- Jack handle

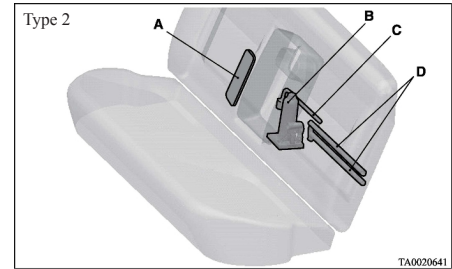

- A- Tools
- B- Jack
- C- Wheel nut wrench
- D- Jack handle

Tools

E00801900382

Type 1

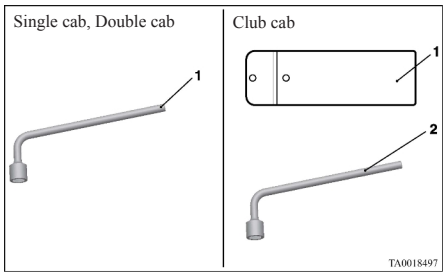

Single cab, Double cab

- 1- Wheel nut wrench

Club cab

- 1- Tool bag
- 2- Wheel nut wrench

Type 2

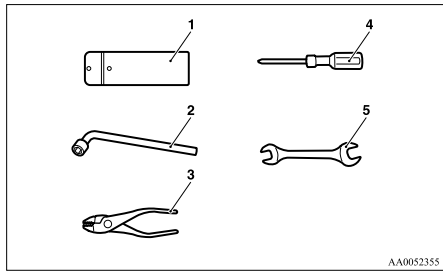

Single cab, Club cab, Double cab

- 1- Tool bag
- 2- Wheel nut wrench
- 3- Plier
- 4- Driver
- 5- Spanner

Removing and storing the tools, jack and jack handle

E00802300240

Single cab

The tools, jack, and jack handle are located behind the seat.

1. Tip forward the seatback.
(Refer to “Folding the seatback forward” on page 2-06.)
- <Type 1>
Remove the wheel nut wrench (A) from the holder (B), and take out the wrench.
<Type 2>
Remove the securing band (C), and then take out the tools (D).

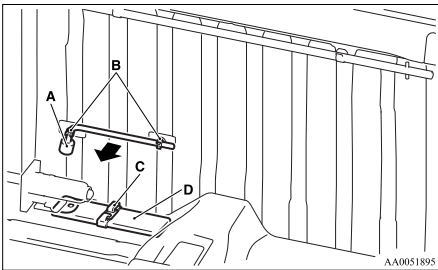

3. Remove the securing nut (E), and then take out the jack (F).

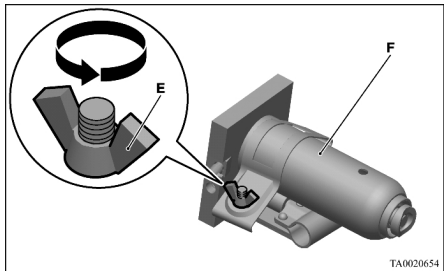

4. Remove the jack handle (G) from the holder (H), and take out the handle.

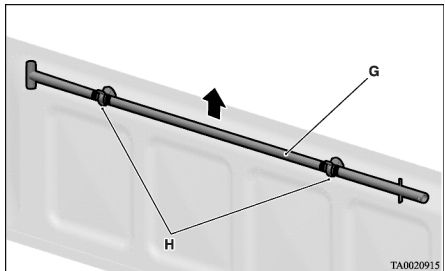

5. Reverse the removing procedure when storing the tool, jack and jack handle.

For emergencies

NOTE

- When stowing the jack handle, align the black-marked part (I) of the jack handle with the holder (J).

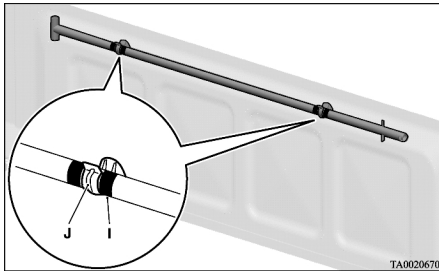

Club cab

The tools, jack, and jack handle are stored under the floor on the left-hand side of the cargo space.

1. Raise the left side seat cushion. Refer to “Folding up the seat cushion (Club cab)” on page 2-07.
Tip forward the seatback of the driver seat. Slide the driver seat forward.
2. Open the lid.

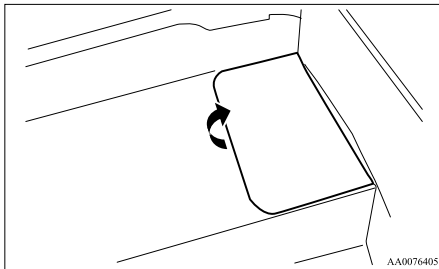

3. Remove the securing band (A), and then take out the tools (B).

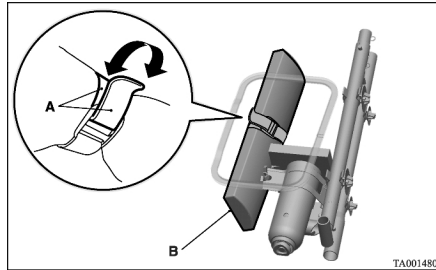

4. Remove the securing nut (C), and then take out the jack (D).

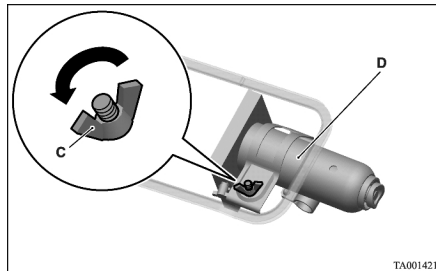

5. Remove the jack handle (E) from the holder (F), and then take out the jack handle.

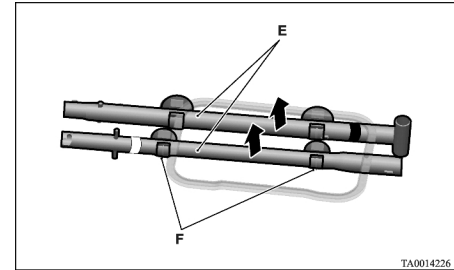

6. Reverse the removing procedure when stowing the tools, jack and jack handle.

NOTE

- When stowing the jack handle, align the coloured marking on the jack handle with that on the holder, and fit the jack in the holder.

Double cab

Except for vehicles with rear retractable power window

The tool (wheel nut wrench only), jack, and jack handle are located behind the rear seat.

1. Tip forward the seatback of the rear seat. (Refer to “Folding the seatback forward” on page 2-07.)
2. <Type 1>
Remove the wheel nut wrench (A) from the holder (B), and take out the wrench.
<Type 2>

Remove the securing band (C), and then take out the tools (D).

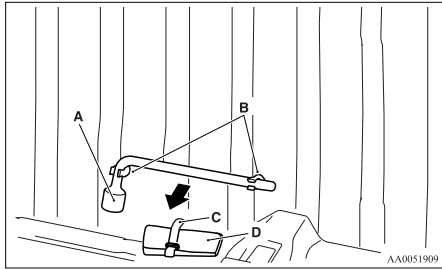

3. Remove the securing nut (E), and then take out the jack (F).

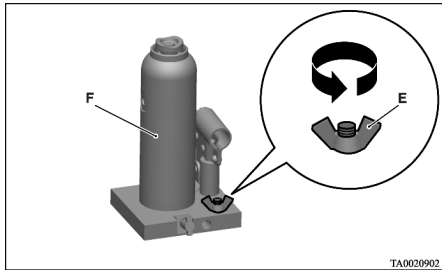

4. Remove the jack handle (G) from the holder (H), and take out the handle.

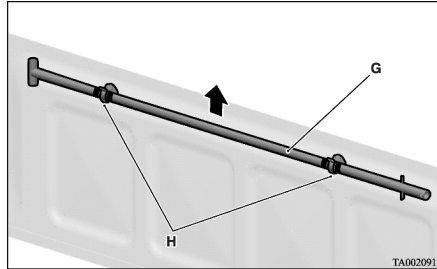

5. Reverse the removing procedure when storing the tool, jack and jack handle.

NOTE

- When storing the jack handle, align the black-marked part (I) of the jack handle with the holder (H).

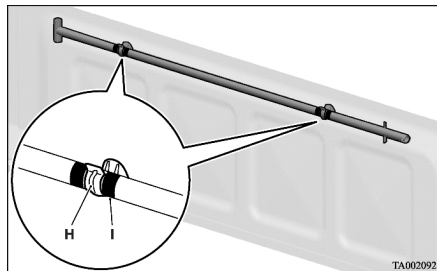

Vehicles with rear retractable power window

The tools, jack, and jack handle are located behind the rear seat.

1. Tip forward the seatback of the rear seat. (Refer to “Folding the seatback forward” on page 2-07.)

2. <Type 1>

Remove the wheel nut wrench (A) from the holder of the back panel (B), and take out the wrench.

<Type 2>

Take out the tools (C) from the rear back trim (D).

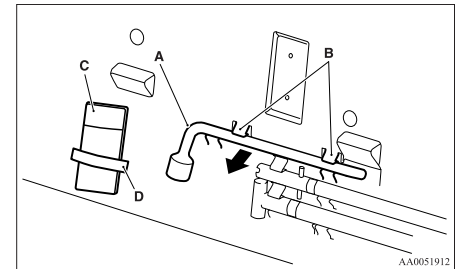

3. Remove the securing nut (E), and then take out the jack (F).

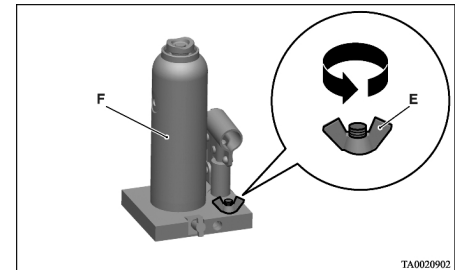

For emergencies

4. Remove the jack handle (G) from the holder of the back panel (H), and take out the handle.

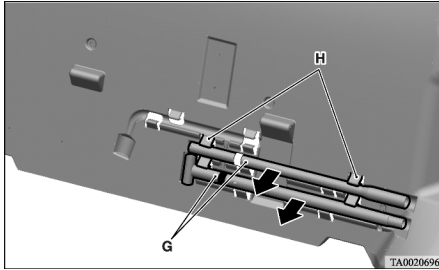

5. Reverse the removing procedure when storing the tool, jack and jack handle.

NOTE

- When stowing the wheel nut wrench, insert it into the holder on the back panel as illustrated.

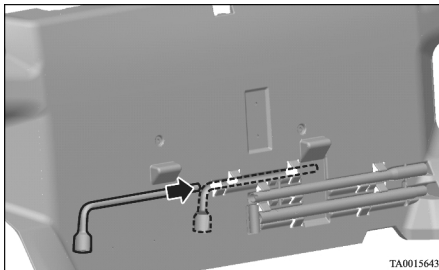

To use the jack handle (Club cab, Double cab with rear retractable power window only)

E00802400124

1. While pressing the snap pin (A) on the handle that has a black marking, withdraw and remove the inner handle (B).

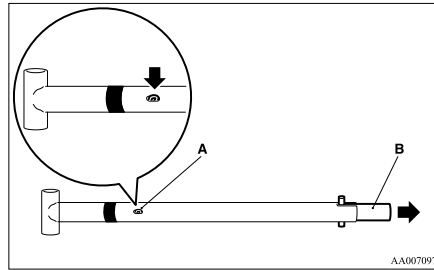

2. Reverse the inner handle (B) then, while pressing the snap pin (C), insert it into the outer handle (D) until it is locked by snap pin as illustrated.

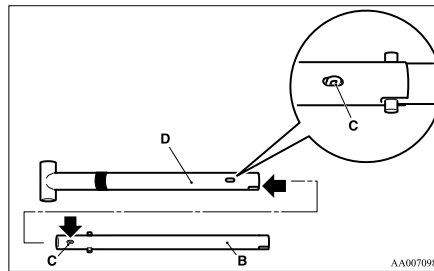

3. While pressing the snap pin (F) on the assembled handle (E), insert the white-marked handle (G) until it is locked by snap pin as illustrated.

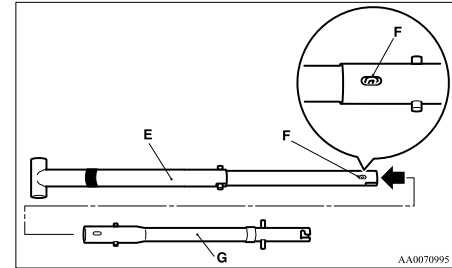

Jacking up the vehicle

E00801001436

1. Park the vehicle on level and stable ground.
2. Set the parking brake firmly.
3. On vehicles with manual transmission, turn the ignition key to the “LOCK” position, move the gearshift lever to the “R” (Reverse) position.
On vehicles with automatic transmission, move the selector lever to the “P” (PARK) position, turn the ignition key to the “LOCK” position.
4. Turn on the hazard warning flashers and set up a warning triangle, flashing signal lamp, etc., at an adequate distance from the vehicle, and have all your passengers leave the vehicle.
5. To prevent the vehicle from rolling when it is raised on the jack, place chocks or blocks (A) at the tyre that is diagonally opposite from the tyre (B) you are changing.

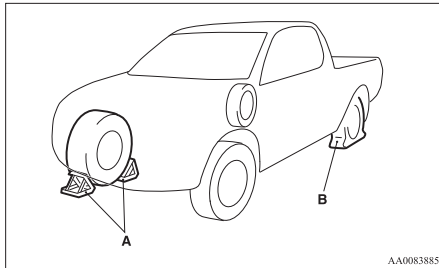

WARNING

- Be sure to apply chocks or blocks to the correct tyre when jacking up the vehicle. If the vehicle moves while jacked up, the jack could slip out of position, leading to an accident.

NOTE

- The chocks shown in the illustration do not come with your vehicle. It is recommended that you keep one in the vehicle for use if needed.
 - If chocks are not available, use stones or any other objects that are large enough to hold the wheel in position.
6. Get the spare wheel, jack and jack handle ready.
 7. Place the jack under one of the jacking points shown in the illustration. Use the jacking point closest to the tyre you wish to change.

2WD vehicles with 15 inch wheels

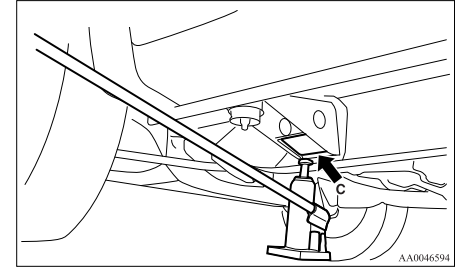

C- Front jacking point (2WD vehicles with 15 inch wheels)

2WD vehicles with 16 inch wheels and 4WD vehicles

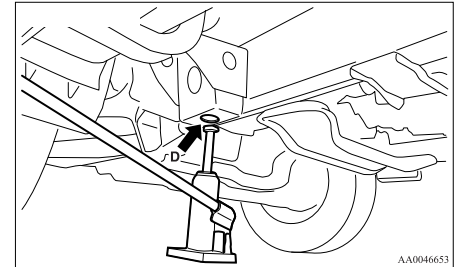

D- Front jacking point (2WD vehicles 16 inch wheels and 4WD vehicles)

For emergencies

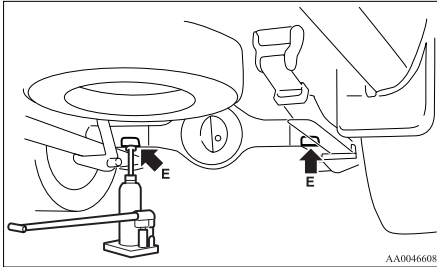

E- Rear jacking point

⚠ WARNING

- Set the jack only at the positions shown here. If the jack is set at a wrong position, it could dent your vehicle or the jack might fall over and cause personal injury.
- Do not use the jack on a tilted or soft surface. Otherwise, the jack might slip and cause personal injury. Always use the jack on a flat, hard surface. Before setting the jack, make sure there are no sand or pebbles under the jack base.

NOTE

- When jacking up the rear of the vehicle, turn the tip of the jack so that the grooved portion (F) properly meets the designated point.

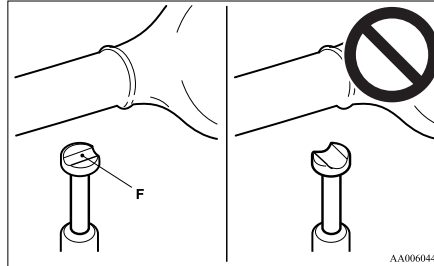

To raise the vehicle

1. Using the jack handle, turn the release valve (G) clockwise until it stops.

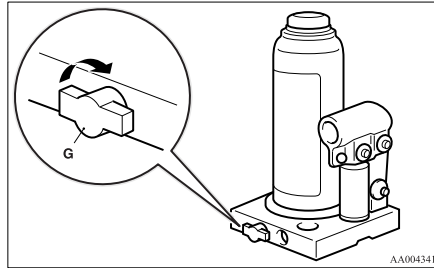

2. Insert the jack handle in the bracket of the jack and hook the notch (H) on the jack handle end to the claw (I) of the bracket.

3. Move the jack handle up and down to raise the ram until just before the jack contacts the jacking point of the vehicle. Ensure that the jack will properly contact the vehicle jacking point. Move the jack handle up and down to raise the vehicle.

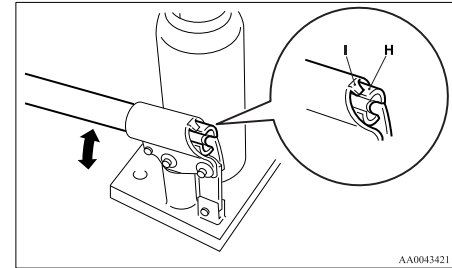

NOTE

- This jack is a 2 stage expansion type.

To lower the vehicle

1. Put the notch (J) provided on the jack handle end on the valve (K) of the jack.

- Using the jack handle, turn the release valve anticlockwise slowly to lower the ram and remove the jack.

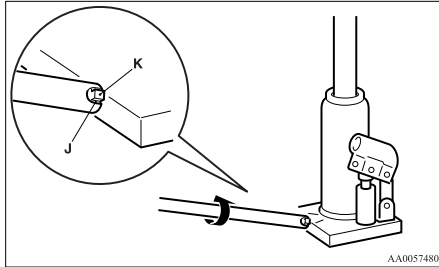

- Press the piston down all the way, and turn the release valve clockwise as far as possible.
- Store jack, jack handle and chocks.

⚠ WARNING

- Be sure to open the release valve slowly. If it is opened quickly, the vehicle will drop abruptly and the jack may come out of position, causing a serious accident.

⚠ CAUTION

- If the release valve is loosened too much (2 or more turns) in the anticlockwise direction, the jack's oil will leak and the jack cannot be used.

⚠ CAUTION

- Close the release valve slowly when lowering the vehicle, or the valve may be damaged.

NOTE

- Occasionally when the vehicle is jacked up, the grooved portion of the designated point will not come off. When this happens, rock the vehicle to lower the ram.
- If the jack is difficult to remove by hand, insert the jack handle (L) into the bracket (M). Then using the handle, remove the jack.

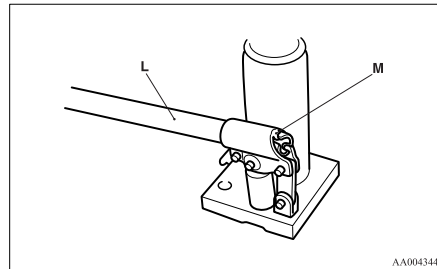

⚠ WARNING

- Stop jacking up the vehicle as soon as the tyre is raised off the ground. It is dangerous to raise the vehicle any higher.
- Do not get under your vehicle while using the jack.

⚠ WARNING

- Do not bump the raised vehicle or leave it sitting on the jack for a long time. Both are very dangerous.
- Do not use a jack except the one that came with your vehicle.
- The jack should not be used for any purpose other than to change a tyre.
- No one should be in your vehicle when using the jack.
- Do not start or run the engine while your vehicle is on the jack.
- Do not turn the raised wheel. The tyres still on the ground could turn and make your vehicle fall off the jack.

For emergencies

Spare wheel

E00801100094

The spare wheel is stored under the floor of the cargo bed.

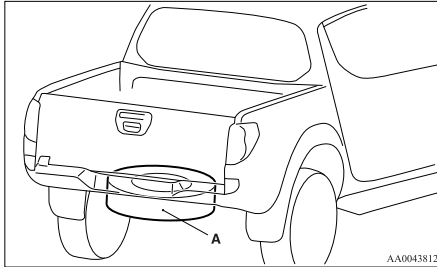

A- Spare wheel

⚠ CAUTION

- When removing the spare wheel, put on gloves. Removing the spare wheel with your bare hands may cause injury to the fingers.

⚠ CAUTION

- Check the air pressure of the spare wheel frequently and make sure it is ready for emergency use at any time. Driving with an insufficient tyre pressure can lead to an accident. If you have no choice but to drive with an insufficient tyre pressure, keep your speed down and inflate the tyre to the correct pressure as soon as possible. (Refer to “Tyre inflation pressures” on page 8-12.) Maintaining the spare wheel at the highest specified air pressure will ensure that it can always be used under any conditions (city/high-speed driving, varying load weight, etc.).

To remove

1. Set the jack handle. (Club cab, Double cab with rear retractable power window only) (Refer to “To use the jack handle” on page 6-12.)
2. Insert the jack handle (A) in the hole (B) below the rear gate.

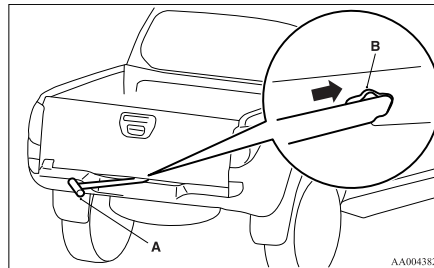

3. Securely insert the pin (C) on the jack handle into the holder (D) of the spare wheel carrier.

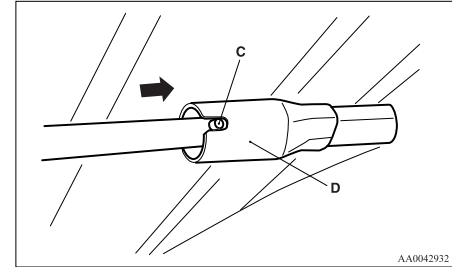

4. Insert the wheel nut wrench (E) through the end of the jack handle hole (F), and then turn it anticlockwise to lower the spare wheel completely to the ground and to slack the chain.

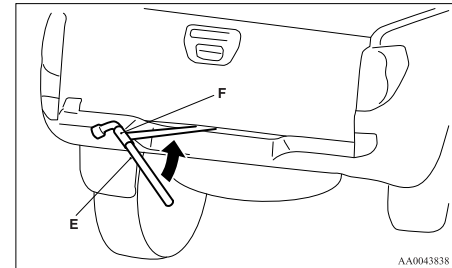

- Remove the hanger disc (G) from the spare wheel.

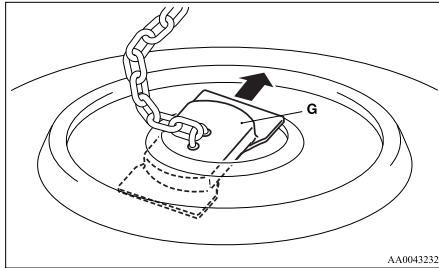

To install

- Install the hanger disc (A) in the wheel disc hole.

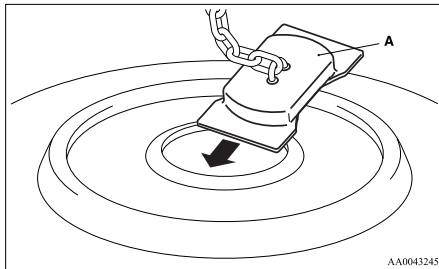

- Turn the wheel nut wrench (B) clockwise to wind up the chain.

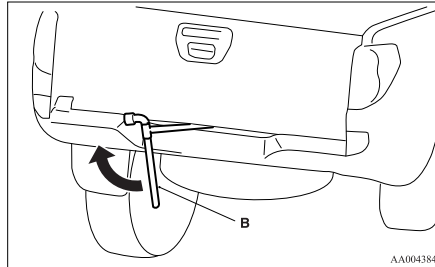

NOTE

- Confirm that the hanger disc is securely fitted in the wheel disc hole when the wheel is just lifted off the ground.
- After winding up the spare wheel sufficiently, make sure it is not loose (the tightening torque should be approximately 40 Nm) then withdraw the jack handle, taking care not to turn it in the reverse direction.

⚠ CAUTION

- The spare wheel should always be securely in position. If a flat tyre is changed, put the flat tyre in the spare wheel mounting position with the wheel outer surface upward, and use the wheel nut wrench firmly.

How to change a tyre

E00801202653

Before changing a tyre, first stop your vehicle in a safe, flat location.

- Park the vehicle on level and stable ground.
- Set the parking brake firmly.
- On vehicles with manual transmission, turn the ignition key to the “LOCK” position, move the gearshift lever to the “R” (Reverse) position.

On vehicles with automatic transmission, move the selector lever to the “P” (PARK) position, turn the ignition key to the “LOCK” position.

- Turn on the hazard warning flashers and set up a warning triangle, flashing signal lamp, etc., at an adequate distance from the vehicle, and have all your passengers leave the vehicle.
- To prevent the vehicle from rolling when it is raised on the jack, place chocks or blocks (A) at the tyre that is diagonally opposite from the tyre (B) you are changing.

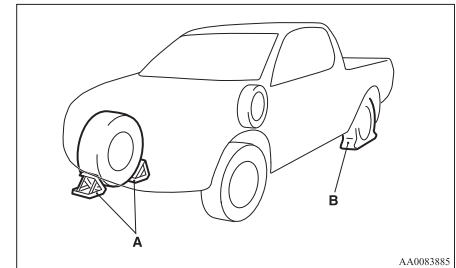

For emergencies

⚠ WARNING

- Be sure to apply chocks or blocks to the correct tyre when jacking up the vehicle. If the vehicle moves while jacked up, the jack could slip out of position, leading to an accident.

NOTE

- The chocks shown in the illustration do not come with your vehicle. It is recommended that you keep one in the vehicle for use if needed.
- If chocks are not available, use stones or any other objects that are large enough to hold the wheel in position.

6. Get the spare wheel, jack, jack handle and wheel nut wrench ready.

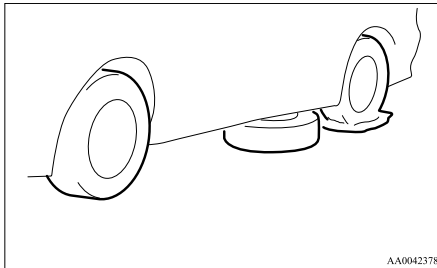

NOTE

- Put the spare wheel under the vehicle body near the flat tyre. This makes it safer if the jack slips out of position.

7. Loosen the wheel nuts with the wheel nut wrench. Do not remove the wheel nuts yet.

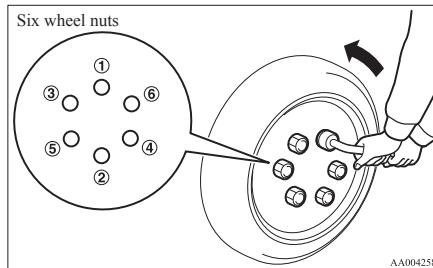
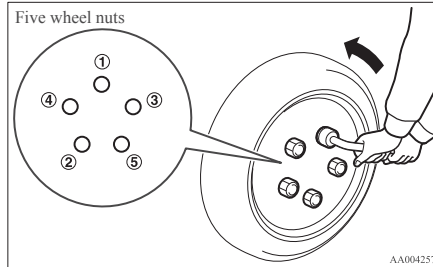

8. Find the closest jacking point to the flat tyre (refer to “Jacking up the vehicle” on page 6-13). Then position the jack and raise the vehicle until the tyre is slightly off the ground.
9. Remove the wheel nuts with the wheel nut wrench, then take the wheel off.

⚠ CAUTION

- Handle the wheel carefully when changing the tyre, to avoid scratching the wheel surface.

10. Clean out any mud, etc. on the hub surface (C), hub bolts (D) or in the installation holes (E) in the wheel, and then mount the spare wheel.

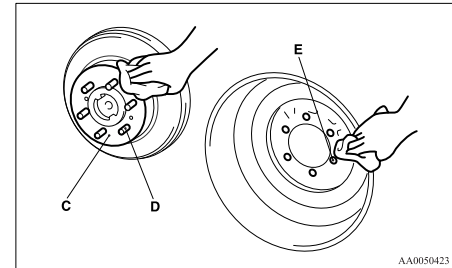

⚠ WARNING

- Mount the spare wheel with the valve stem (F) facing outboard. If you cannot see the valve stem (F), you have installed the wheel backwards. Operating the vehicle with the spare wheel installed backwards can cause vehicle damage and result in an accident.

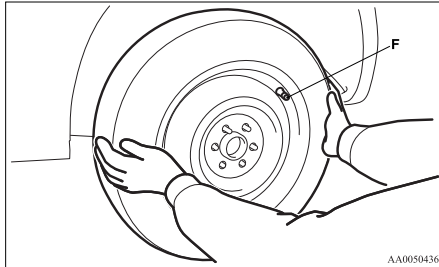

11. Finger-tighten the wheel nuts. (Turn them clockwise.)

Vehicles with steel wheels

Tighten the wheel nuts (tapered nuts) until the tapered parts of the wheel nuts make light contact with the seats of the wheel holes and the wheel is not loose.

With a spare wheel, tighten the wheel nuts in the same way.

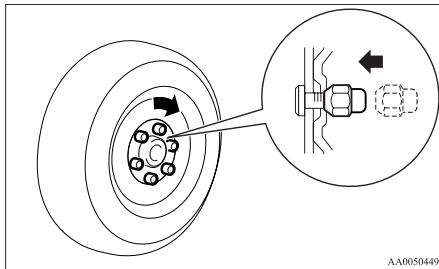

Vehicles with aluminium wheels

Tighten the wheel nuts (flange nuts) until the flanges of the wheel nuts touch the wheel and the wheel is not loose.

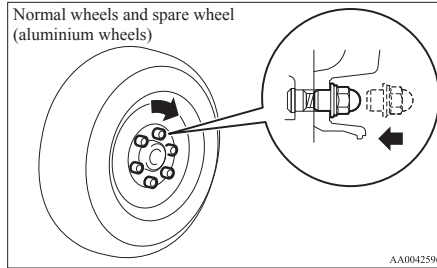

With a spare wheel, tighten the wheel nuts until the tapered parts of the wheel nuts make light contact with the seats of the wheel holes and the wheel is not loose.

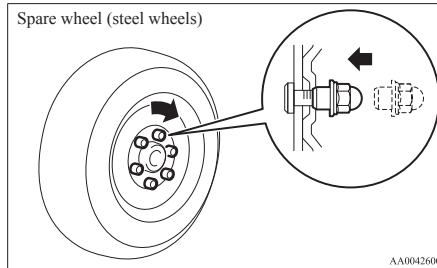

CAUTION

- Never apply oil to either the wheel bolts or the nuts, or they will tighten too much.

NOTE

- Flange nuts can be temporarily used on the spare wheel, but return to the original wheel and tyre as soon as possible.
- If all four aluminium wheels are changed to steel wheels, use tapered nuts.

12. Lower the vehicle slowly and then tighten the nuts crisscross in 2 or 3 steps until each nut has been tightened securely.

Tightening torque

Steel wheel: 137 to 157 Nm

Aluminium wheel: 118 to 137 Nm

(Achieved by applying a force at the end of the wheel nut wrench supplied with the vehicle.)

Steel wheel: 510 to 580 N

Aluminium wheel: 440 to 500 N)

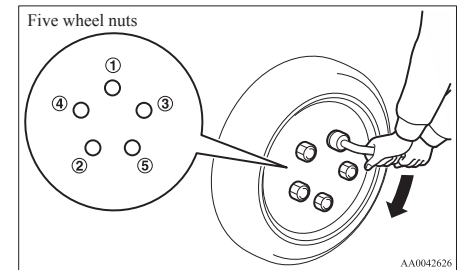

For emergencies

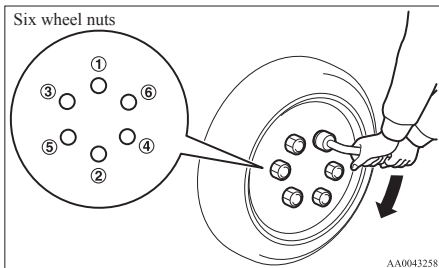

⚠ CAUTION

- Never use your foot or a pipe extension for extra force in the wheel nut wrench. If you do so, you will tighten the nut too much.

13. Lower and remove the jack, then store the jack, jack handle, wheel nut wrench, flat tyre, and chocks. Have your damaged tyre repaired as soon as possible.
14. Check your tyre inflation pressure. The correct pressures are shown on the door label. See the illustration.

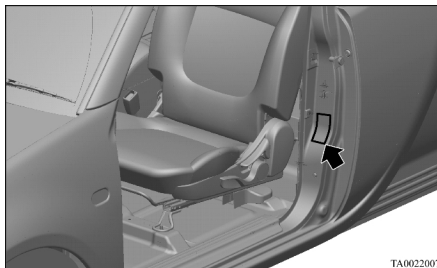

⚠ CAUTION

- The tyre pressure should be periodically checked and maintained at the specified pressure while the tyre is stowed.
- After changing the tyre and driving the vehicle about 1,000 km (620 miles), retighten the wheel nuts to make sure that they have not come loose.
- If the steering wheel vibrates when driving after changing the tyre, we recommend you to have the tyres checked for balance.
- Do not mix one type of tyre with another or use a different size from the one listed. This would cause early wear and poor handling.

Towing

E00801503640

If your vehicle needs to be towed

If towing is necessary, we recommend you to have it done by your MITSUBISHI MOTORS Authorized Service Point or a commercial tow truck service.

In the following cases, transport the vehicle using a tow truck.

- The engine runs but the vehicle does not move or abnormal noise is produced.
- Inspection of the vehicle's underside reveals that oil or some other fluid is leaking.

If a wheel gets stuck in a ditch, do not try to tow the vehicle. Please contact your MITSUBISHI MOTORS Authorized Service Point or a commercial tow truck service for assistance.

Only when you cannot receive a towing service from a MITSUBISHI MOTORS Authorized Service Point or commercial tow truck service, tow your vehicle carefully in accordance with the instructions given in "Emergency towing" in this part.

The regulations concerning towing may differ from country to country. It is recommended that you obey the regulations of the area where you are driving your vehicle.

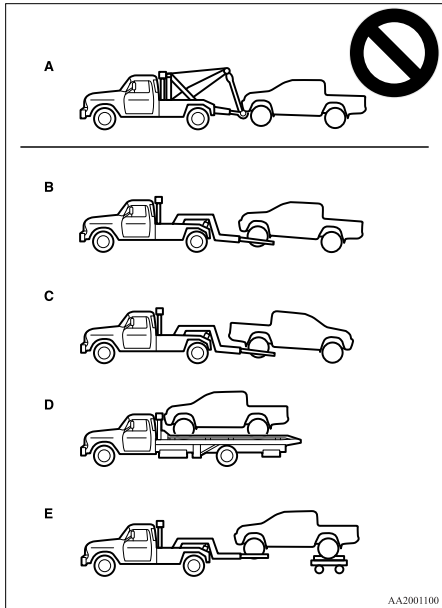

Towing the vehicle by a tow truck

⚠ CAUTION

- This vehicle must not be towed by a tow truck using sling lift type equipment (Type A) as illustrated. Using a sling lift will damage the bumper and front end.
- On 4WD vehicles, be sure to shift the transfer shift lever to “2H” position and transport the vehicle with the driving wheels on a carriage (Type C, D or E) as illustrated. Never try to tow with the transfer shift lever in “4H” or “4L” position (easy select 4WD), “4H”, “4HLc” or “4LLc” position (super select 4WD) and with the front or rear wheels on the ground (Type B or C) as illustrated. This could result in driving system damage or the vehicle may jump at the carriage. If you cannot shift the transfer shift lever to the “2H” position or the transmission is malfunctioning or damaged, transport the vehicle with all wheels on a carriage (Type D or E) as illustrated.
- If your vehicle equipped with the Active Stability & Traction Control system (ASTC), if the vehicle is towed with the ignition switch in the “ON” position and only the front wheels or only the rear wheels raised off the ground, the active Traction Control System may operate, resulting in an accident.
- On 2WD vehicles, if the transmission is malfunctioning or damaged, transport the vehicle with the driving wheels on a carriage (Type C, D or E) as illustrated.

⚠ CAUTION

- If you tow a vehicle with automatic transmission with the driving wheels on the ground (Type B) as illustrated, make sure that the towing speed and distance given below are never exceeded, causing damage to the transmission.

Towing speed: 50 km/h (30 mph)
Towing distance: 50 km (30 miles)

For the towing speed and the towing distance, follow the local driving laws and regulations.

Towing with front wheels off the ground (Type B)

Place the gearshift lever in the “N” (Neutral) position (manual transmission) or the selector lever in the “N” (NEUTRAL) position (automatic transmission).

Release the parking brake.

⚠ CAUTION

- Never tow an automatic transmission vehicle with the front wheels up (and the rear wheels on the ground) (Type B) when the automatic transmission fluid level is low. This may cause serious and expensive damage to the transmission.

For emergencies

Towing with rear wheels off the ground (Type C)

Place the gearshift lever in the “N” (Neutral) position (manual transmission) or the selector lever in the “N” (NEUTRAL) position (automatic transmission). Turn the ignition key to the “ACC” position and secure the steering wheel in a straight ahead position with a rope or tie-down strap. Never place the ignition switch in the “LOCK” position when towing.

Emergency towing

If towing service is not available in an emergency, your vehicle may be temporarily towed by a cable or chain secured to the towing hook.

If your vehicle is to be towed by another vehicle, pay careful attention to the following points.

If your vehicle is to be towed by another vehicle

1. The front towing hooks (A) and rear towing hook (B) are located as shown in the illustration. Secure the tow rope to the towing hook.

Front (2WD vehicles with 15 inch wheels)

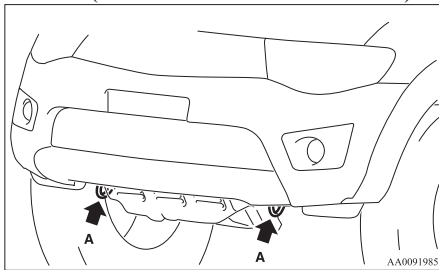

Front (2WD vehicles with 16 inch wheels and 4WD vehicles)

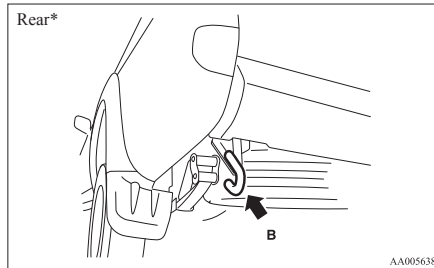
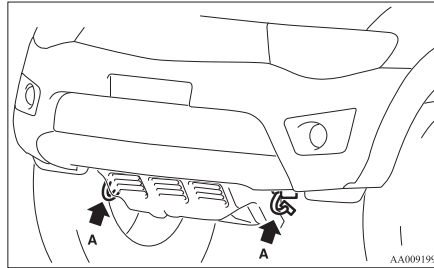

NOTE

- Using any part other than the designated towing hooks could result in damage to the vehicle body.
- Using a wire rope or metal chain can result in damage to the vehicle body. It is best to use a non-metallic rope. If you use a wire rope or metal chain, wrap it with cloth at any point where it touches the vehicle body.

- Take care that the tow rope is kept as horizontal as possible. An angled tow rope can damage the vehicle body.
- Secure the tow rope to the same side towing hook, to keep the tow rope as straight as possible.

2. Keep the engine running.

If the engine is not running, turn the ignition key to the “ACC” or “ON” position to unlock the steering wheel.

⚠ CAUTION

- When the engine is not running, the brake booster and power steering pump do not operate. This means higher brake depression force and higher steering effort are required. Therefore, vehicle operation is more difficult than usual.
- Do not leave the key in the “LOCK” position. The steering wheel will lock, causing loss of control.

3. Place the gearshift lever in the “N” (Neutral) position (manual transmission) or the selector lever in the “N” (NEUTRAL) position (automatic transmission).
4. On 4WD vehicles, the transfer shift lever to “2H” position.
5. Turn on the hazard warning lamps if required by law. (Follow the local driving laws and regulations.)
6. During towing make sure that close contact is maintained between the drivers of both vehicles, and that the vehicles travel at low speed.

⚠ WARNING

- To prevent entry of exhaust gas from the towing vehicle, set your air selection lever to the recirculation position.

⚠ CAUTION

- Avoid sudden braking, sudden acceleration and sharp turning; such operation could cause damage to the towing hooks or the tow rope. People in the vicinity could be injured as a result.
- When towing or being towed down a long slope, the brakes may overheat reducing the effectiveness. In this situation, have your vehicle transported by a tow truck.
- When the vehicle with automatic transmission is to be towed by another vehicle with all the wheels on the ground, make sure that the towing speed and distance given below are never exceeded, causing damage to the transmission.

Towing speed: 50 km/h (30 mph)
Towing distance: 50 km (30 miles)

For the towing speed and the towing distance, follow the local driving laws and regulations.

If your vehicle tows another vehicle (vehicles with rear towing hook only)

The rear towing hook is located as shown in the illustration. Secure the tow rope to the rear towing hook.

NOTE

- Using any part other than the designated towing hook could result in damage to the vehicle body.

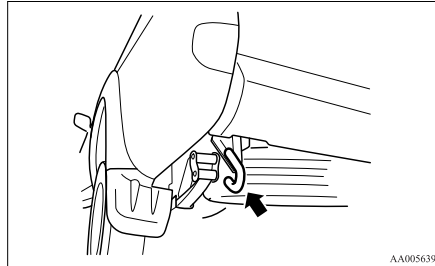

⚠ CAUTION

- On vehicles with super select 4WD, when you are going to tow another vehicle, move the transfer shift lever to “4H” position. Selecting “2H” drive may increase the differential oil temperature, resulting in possible damage to the driving system. Further, the drive train will be subjected to excessive loading possibly leading to oil leakage, component seizure, or other serious faults.

NOTE

- Your vehicle should only be used to tow another vehicle if the weight of the other vehicle is less than the weight of your vehicle.

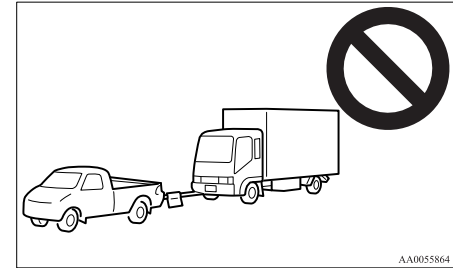

Operation under adverse driving conditions

E00801702762

If your vehicle becomes stuck in sand, mud or snow

If the vehicle becomes stuck in snow, sand, or mud, it can often be moved with a rocking motion. Move the selector lever alternately between the Sport Mode and “R” (REVERSE) position (with manual transmission, between 1st and Reverse), while applying slight pressure to the accelerator pedal.

Avoid racing the engine or spinning the wheels. Prolonged efforts to free a stuck vehicle may result in overheating and transmission failure. Allow the engine to idle for a few minutes to let the transmission cool between rocking attempts.

If the vehicle remains stuck after several rocking attempts, seek other assistance.

WARNING

- When attempting to rock your vehicle out of a stuck position, be sure that the area around the vehicle is clear of people and physical objects. The rocking motion may cause the vehicle to suddenly launch forward or backward, causing injury or damage to nearby people or objects.

On 2WD vehicles, it is recommended to start the vehicle with parking brake partially, but not completely, applied by slightly pulling the parking brake lever.

After the vehicle has become free, do not forget to release the parking brake.

NOTE

- Depress the accelerator pedal gradually when starting the vehicle.

On a flooded road

- Avoid flooded roads. Water could enter the brake discs, resulting in temporarily ineffective brakes. In such cases, lightly depress the brake pedal to see if the brakes operate properly. If they do not, lightly depress the pedal several times while driving in order to dry the brake pads.
- When driving in rain or on a road with many puddles a layer of water may form between the tyres and the road surface. This reduces a tyre’s frictional resistance on the road, resulting in loss of steering stability and braking capability.

To cope with this, observe the following items:

- (a) Drive your vehicle at slow speed.
- (b) Do not drive on worn tyres. Always maintain the specified tyre inflation pressures.

On a snow-covered or frozen road

- When driving on a snow-covered or frozen road, it is recommended that you use snow tyres or tyre chains. Refer to the “Snow tyres” and “Tyre chains” sections.
- Avoid high-speed operation, sudden acceleration, abrupt brake application and sharp cornering.

- Depressing the brake pedal during travel on snowy or icy roads may cause tyre slippage and skidding. When traction between the tyres and the road is reduced the wheels may skid and the vehicle cannot readily be brought to a stop by conventional braking techniques. Braking will differ, depending upon whether you have anti-lock brake system (ABS). If you do have ABS, brake by pressing the brake system pedal hard, and keeping it pressed. If you do not have ABS, pump the brake pedal with short rapid jabs, each time fully applying and fully releasing for greatest effect.
- Allow extra distance between your vehicle and the vehicle in front of you, and avoid sudden braking.
- Accumulation of ice on the braking system can cause the wheels to lock. Pull away from a standstill slowly after confirming safety around the vehicle.

CAUTION

- Do not press the accelerator pedal rapidly. If the wheels break free of the ice, the vehicle could suddenly start moving and possibly cause an accident.

On a bumpy or rutted road

- Drive as slow as possible when driving on bumpy or rutted roads.

 **CAUTION**

- The impact on tyres and/or wheels when driving on a bumpy or rutted road can damage the tyre and/or wheel.

A series of 15 horizontal dashed lines spanning the width of the page, providing a template for handwriting practice.

Vehicle care

Vehicle care precautions.....	7-02
Cleaning the interior of your vehicle.....	7-02
Cleaning the exterior of your vehicle.....	7-03

Vehicle care precautions

E00900100870

In order to maintain the value of your vehicle, it is necessary to perform regular maintenance using the proper procedures. Always maintain your vehicle in compliance with environmental pollution control regulations. Carefully select the materials used for washing, etc., to be sure that they do not contain corrosives. If in doubt, we recommend you to consult a specialist for selection of these materials.

CAUTION

- Cleaning products can be dangerous. Some are poisonous. Others can burst into flame if you strike a match or drop them on a hot part of the vehicle. Some are dangerous if you breathe their fumes in a closed space. When you use anything in a container to clean your vehicle, always follow the instructions and always open your vehicle doors or windows when you're cleaning the inside. Never use the following to clean your vehicle:

- Petrol
- Paint Thinner
- Benzine
- Kerosene
- Turpentine
- Naphtha
- Lacquer Thinner
- Carbon Tetrachloride
- Nail Polish Remover
- Acetone

- These are all dangerous, and can damage your vehicle.

Cleaning the interior of your vehicle

E00900200288

After cleaning the interior of your vehicle with water, cleaner or similar, wipe and dry in a shady, well-ventilated area.

CAUTION

- Do not use organic substances (solvents, benzine, kerosene, alcohol, petrol, etc.) or alkaline or acidic solutions. These chemicals can cause discolouring, staining or cracking of the surface. If you use cleaners or polishing agents, make sure their ingredients do not include the substances mentioned above.

NOTE

- Always read the instructions on the cleaner label.

Plastic, vinyl leather, fabric and flocked parts

E00900300377

1. Gently wipe off with gauze or other soft cloth soaked with a 3 % aqueous solution of neutral detergent.
2. Dip cloth in fresh water and wring out well. Using this cloth, wipe off the detergent thoroughly.

NOTE

- Do not use cleaners, conditioners, and protectants containing silicones or wax. Such products, when applied to the instrument panels or other parts, may cause reflections on the windscreen and obscure vision. Also, if such products get on the switches of the electrical accessories, it may lead to failure of these accessories.

Upholstery

E00900500018

1. To maintain the value of your new vehicle, handle the upholstery carefully and keep the interior clean. Use a vacuum cleaner and brush to clean the seats. If stained, vinyl and synthetic leather should be cleaned with an appropriate cleaner, and cloth fabrics can be cleaned with either upholstery cleaner or a 3 % solution of neutral detergent in lukewarm water.
2. Clean the carpeting with a vacuum cleaner and remove any stains with carpet cleaner. Oil and grease can be removed by lightly dabbing with a clean colourfast cloth and stain remover.

Genuine leather*

E00900600817

1. Gently wipe off with gauze or other soft cloth soaked with a 5 % aqueous solution of neutral detergent.
2. Dip cloth in fresh water and wring it out well. Using this cloth, wipe off the detergent thoroughly.
3. Apply leather protecting agent to the genuine leather surface.

NOTE

- If genuine leather is wet with water or is washed in water, wipe off water as quickly as possible with a dry, soft cloth. If left damp, mildew may grow.
- The genuine leather surface may be damaged if a nylon brush or synthetic fibre is rubbed hard against it.
- Organic solvents such as benzine, kerosene, alcohol and petrol, acid or alkaline solvents may discolour the genuine leather surface. Be sure to use neutral detergents.
- Remove dirty patches or oil substances quickly as they can stain genuine leather.
- The genuine leather surface may harden and shrink if it is exposed to direct sun for long hours. When your vehicle is parked, place it in the shade as much as possible.
- When the temperature of the vehicle interior rises in summer, vinyl products left on the genuine leather seat may deteriorate and stick to the seat.

Cleaning the exterior of your vehicle

E00900700010

If the following is left on your vehicle, it may cause corrosion, discolouration and stains, wash the vehicle as soon as possible.

- Seawater, anti-freeze for road use.
- Soot and dust, iron powder from factories, chemical substance (acids, alkalis, coal-tar, etc.).
- Droppings from birds, carcasses of insects, tree sap, etc.

Washing

E00900902016

Chemicals contained in the dirt and dust picked up from the road surface can damage the paint coat and body of your vehicle if left in prolonged contact. Frequent washing and waxing is the best way to protect your vehicle from this damage. This will also be effective in protecting it from environmental elements such as rain, snow, salt air, etc.

Do not wash the vehicle in direct sunlight. Park the vehicle in the shade and spray it with water to remove dust. Next, using an ample amount of clean water and a car washing brush or sponge, wash the vehicle from top to bottom.

Use a mild car washing soap if necessary. Rinse thoroughly and wipe dry with a soft cloth. After washing the vehicle, carefully clean the joints and flanges of the doors, bonnet, etc., where dirt is likely to remain.

CAUTION

- When washing the under side of your vehicle or wheel, be careful not to injure your hands.
- Refrain from using a car wash as its brushes may scratch the paint surface, causing it to lose its gloss. Scratches will be especially visible on darker coloured vehicles.
- Never spray or splash water on the electrical components in the engine compartment, as this may adversely affect engine starting. Exercise caution also when washing the underbody; be careful not to spray water into the engine compartment.
- Some types of hot water washing equipment apply high pressure and heat to the vehicle. They may cause heat distortion and damage to the vehicle resin parts and may result in flooding of the vehicle interior. Therefore; observe the following.
 - Maintain a distance of approx. 50 cm or more between the vehicle body and the washing nozzle.
 - When washing around the door glass, hold the nozzle at a distance of more than 50 cm and at right angles to the glass surface.

CAUTION

- After washing the vehicle, drive the vehicle slowly while lightly depressing the brake pedal several times in order to dry out the brakes.
Leaving the brakes wet could result in reduced braking performance. Also, there is a possibility that they could freeze up or become inoperative due to rust, rendering the vehicle unable to move.
- When using an automatic car wash, pay attention to the following items, referring to the operation manual or consulting a car wash operator. If the following procedure is not followed, it could result in damage to your vehicle.
 - The outside mirrors are retracted.
 - If your vehicle is equipped with the pillar antenna, it can be retracted.
 - If your vehicle is equipped with the roof antenna, it can be removed.

During cold weather

Salt and other chemicals spread on the roads in some areas in winter can have a harmful effect on the vehicle body. You should therefore wash the vehicle as often as possible in accordance with our care-instructions. It is recommended to have a preservative applied and the underfloor protection checked before and after the cold weather season. After washing your vehicle, wipe off all water-drops from the rubber parts around the doors to prevent the doors from freezing.

NOTE

- To prevent freezing of the weatherstripping on the doors, bonnet, etc., they should be treated with silicone spray.

Waxing

E00901000687

Waxing the vehicle will help prevent the adherence of dust and road chemicals to the paintwork. Apply a wax solution after washing the vehicle, or at least once every three months to assist displacing of water. Do not wax your vehicle in direct sunlight. You should wax after the surfaces have cooled.

CAUTION

- Waxes containing high abrasive compounds should not be used. Such waxes remove rust and stains effectively from the paintwork but they are harmful to the lustre on the painted surface and the plated surface.
Further, they are harmful to glossy surfaces such as grille, garnish, mouldings, etc.
- Do not use petrol or paint thinners to remove road tar or other contamination to the vehicle surface.
- Do not apply wax on the areas having black mat coating as it can cause uneven discolouration, patches, blurs, etc. If stained with wax, immediately wipe off with a piece of soft cloth and warm water.

CAUTION

- On vehicles with a sunroof, be careful when waxing the area around the sunroof opening, not to put any wax on the weatherstrip (black rubber). If stained with wax, the weatherstrip cannot maintain a weatherproof seal with the sunroof.

Polishing

E00901100011

The vehicle should only be polished if the paintwork has become stained or lost its lustre. Matt-finish parts and plastic bumpers must not be polished, polishing these parts will stain them or damage their finish.

Damaged paint

E00901200155

Small cracks and scratches in the paint coat should be touched up as soon as possible with MITSUBISHI touch-up paint to prevent corrosion. Check body areas facing the road or the tyres carefully for damage to the paint coat caused by flying stones, etc. The paint code number for your vehicle can be found on the vehicle information code plate. (Refer to “Vehicle labeling” on page 9-02.)

Cleaning plastic parts

E00901300446

Use a sponge or chamois leather. If a car wax adheres on a grey or black rough surface of the bumper, moulding or lamps, the surface becomes white. In such a case, wipe it off using lukewarm water and soft cloth or chamois leather.

CAUTION

- Do not use a scrubbing brush or other hard tools as they may damage the plastic part surface.
- Do not use wax containing compound (polishing powder) which may damage the plastic part surface.
- Do not bring the plastic parts into contact with petrol, light oil, brake fluids, engine oils, greases, paint thinners, and sulphuric acid (battery electrolyte) which may crack, stain or discolour the plastic parts. If they touch the plastic parts, wipe them off with soft cloth, chamois or the like and an aqueous solution of neutral detergent then immediately rinse the affected parts with water.

Chrome parts

E00901400014

In order to prevent spots and corrosion of chrome parts, wash with water, dry thoroughly, and apply a special protective coating. This should be done more frequently in winter.

Aluminium wheels*

E00901500116

1. Remove dirt using a sponge while sprinkling water on the vehicle.
2. Use neutral detergent on any dirt that cannot be removed easily with water.
Rinse off the neutral detergent after washing the vehicle.
3. Dry the vehicle thoroughly using a chamois leather or a soft cloth.

CAUTION

- Do not use a brush or other hard implement on the wheels.
Doing so could scratch the wheels.
- Do not use any cleaner that contains an abrasive substance or is acidic or alkaline. Doing so could cause the coating on the wheels to peel or become discoloured or stained.
- Do not directly apply hot water using a steam cleaner or by any other means.
- Contact with seawater and road deicer can cause corrosion. Rinse off such substances as soon as possible.

Window glass

E00901600058

The window glass can normally be cleaned using only a sponge and water.

Glass cleaner can be used to remove oil, grease, dead insects, etc. After washing the glass, wipe dry with a clean, dry, soft cloth. Never use the same cloth to wipe the window glass as would be used to wipe the paintwork; wax from the painted surfaces could adhere to the glass and reduce its transparency and visibility.

NOTE

- To clean the inside of the rear window, always use a soft cloth and wipe the window glass along the demister heater element so as not to cause damage.

Wiper blades

E00901700017

Use a soft cloth and glass cleaner to remove grease, dead insects, etc., from the wiper blades. Replace the wiper blades when they no longer wipe properly. (Refer to page “Wiper blades” on page 8-17.)

Cleaning the sunroof*

E00901800180

Clean the inside of the sunroof with a soft cloth. Hard deposits should be wiped away with a cloth dipped in warm, neutral detergent solution. Wipe away the solution with a sponge dipped in fresh water.

NOTE

- The surface treatment on the inside of the glass may be removed if hard cloth or organic solvent (benzine, kerosene, thinner, etc.) is used.

Engine compartment

E00902100265

Clean the engine compartment at the beginning and end of winter. Pay particular attention to flanges, crevices and peripheral parts where dust containing road chemicals and other corrosive materials might collect.

If salt and other chemicals are used on the roads in your area, clean the engine compartment at least every three months.

Never spray or splash water on the electrical components in the engine compartment, as this may cause damage.

Do not bring the nearby parts, the plastic parts and so on into contact with sulphuric acid (battery electrolyte) which may crack, stain or discolour them.

Vehicle care

If they are in contact, wipe off with soft cloth, chamois or the like and an aqueous solution of neutral detergent then immediately rinse the affected parts with plenty of water.

Maintenance

Service precautions.....	8-02
Catalytic converter.....	8-02
Bonnet.....	8-03
Engine oil.....	8-04
Engine coolant.....	8-06
Automatic transmission fluid*.....	8-07
Washer fluid.....	8-08
Brake fluid.....	8-08
Clutch fluid*.....	8-09
Power steering fluid.....	8-09
Battery.....	8-10
Tyres.....	8-11
Clutch pedal free play*.....	8-15
Brake pedal free play.....	8-16
Parking brake lever stroke.....	8-16
Wiper blades.....	8-17
General maintenance.....	8-18
For cold and snowy weather.....	8-19
Fusible links.....	8-19
Fuses.....	8-20
Replacement of lamp bulbs.....	8-23

Service precautions

E01000100706

Adequate care of your vehicle at regular intervals serves to preserve the value and appearance as long as possible.

Maintenance items as described in this owner's manual can be performed by the owner.

We recommend you to have the periodic inspection and maintenance performed by a MITSUBISHI MOTORS Authorized Service Point or another specialist.

In the event a malfunction or other problem is discovered, we recommend you to have it checked and repaired. This section contains information on inspection maintenance procedures that you can do yourself. Follow the instructions and cautions for each of the various procedures.

WARNING

- When checking or servicing the inside of the engine compartment, make sure the engine is switched off and has had a chance to cool down.
- If it is necessary to do work in the engine compartment with the engine running, be especially careful that your clothing, hair, etc., does not become caught by the fans, drive belts, or other moving parts.
- For vehicle with air conditioning, the fan may turn on automatically even if the engine is not running; turn the ignition key to "LOCK" position and remove the key to ensure safety while you work in the engine compartment.

WARNING

- Do not smoke, cause sparks or allow open flames around fuel or battery. The fumes are flammable.
- Be extremely cautious when working around the battery. It contains poisonous and corrosive sulphuric acid.
- Do not get under your vehicle with just the body jack supporting it. Always use automotive jack stands.
- Improper handling of components and materials used in the vehicle can endanger your personal safety. We recommend you to consult a specialist for necessary information.

Catalytic converter

E01000200925

For ordinary use, there are no particular precautions. The exhaust gas scavenging devices used with the catalytic converter are extremely efficient for the reduction of noxious gases. The catalytic converter is installed in the exhaust system.

It is important to keep the engine properly tuned to ensure proper catalyst operation and prevent possible catalyst damage.

CAUTION

- Damage to the catalytic converter can result if your vehicle is not kept in proper operating condition. In the event of an engine malfunction particularly involving engine misfire or other apparent loss of performance, have your vehicle serviced promptly. Continued operation of your vehicle with a severe overheated condition may result in possible damage to the converter and vehicle.

WARNING

- As with any vehicle, do not park or operate this vehicle in areas where combustible materials such as dry grass or leaves can come in contact with a hot exhaust since a fire could occur.
- Paint should not be applied to the catalytic converter.

The catalytic converter itself gets hot quickly, and may be damaged if overheated. The following points should be noted in order to prevent the ignition of unburned fuel within the catalytic converter.

- Do not drive with an extremely low fuel level; running out of fuel could cause damage to the catalytic converter.
- Do not switch OFF the ignition switch while driving.
- Do not attempt to start the engine by pushing the vehicle. If the battery is weak or discharged, use another battery to start the engine.
- Do not idle the engine for prolonged periods during very rough idle or malfunctioning operating conditions.
- Do not race the engine when turning off the ignition switch. This will cause the catalytic converter to be damaged due to contact with unburnt fuel.
- Stop driving the vehicle if you think the performance is noticeably low, or if the engine has a malfunction such as with the ignition, etc.
- If it is impractical to stop driving immediately, reduce the speed and drive for only a short time. We recommend you to have your vehicle inspected as soon as possible.
- In unusual situations involving major engine problems, a burnt smell may indicate severe and abnormal catalyst overheating.

If this occurs, the vehicle should be stopped in a safe place, the engine switched off and the vehicle allowed to cool. Once the engine is cool, a service, including a tune-up to manufacturer's specifications, should be obtained immediately.

Bonnet

E01000302281

To open

Pull the release lever towards you to unlock the bonnet.

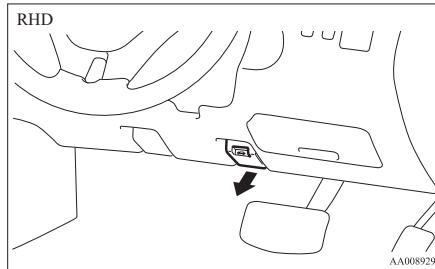
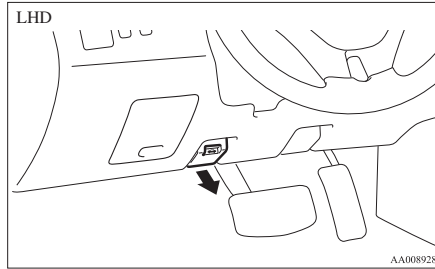

Raise the bonnet while pressing the safety lock.

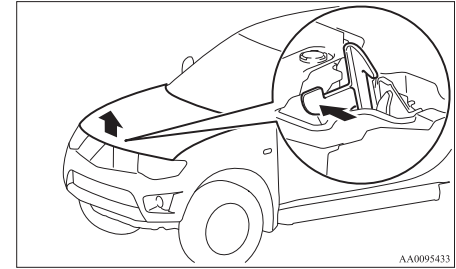

NOTE

- Only open the bonnet when the wipers are in the parked position. Failure to do so may cause damage to the bonnet, wiper arms or front windscreen.

Support the bonnet by inserting the support bar in its slot.

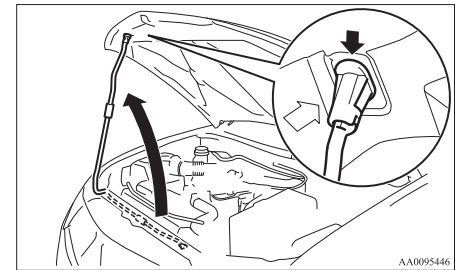

⚠ CAUTION

- Note that the support bar may disengage the bonnet if the open bonnet is lifted by a strong wind.
- Always insert the support bar into the hole provided specifically for this purpose. Supporting the bonnet at any other location could result in the support bar slipping out and lead to an accident.

To close

Unlatch the support bar and clip it in its holder. Slowly lower the bonnet to a position about 20 cm above the closed position, then let it drop.

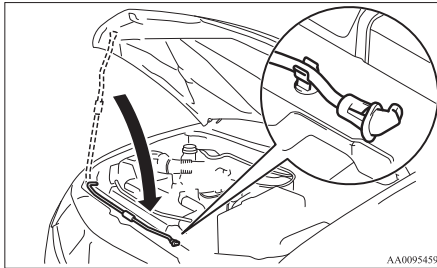

NOTE

- If this does not close the bonnet, release it from a slightly higher position.
- Do not press down the bonnet hard with a hand as it may damage the bonnet.

⚠ CAUTION

- Be careful that hands or fingers are not trapped when closing the bonnet.
- Before driving, make sure that the bonnet is securely locked. An incompletely locked bonnet can suddenly open while driving. This can be extremely dangerous.

Engine oil

E01000402820

To check and refill engine oil

- A- Minimum level
- B- Maximum level
- C- Oil replacement indication mark

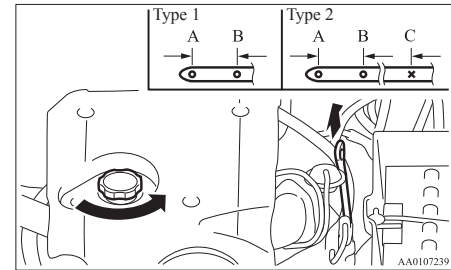

The engine oil used has a significant effect on the engine's performance, service life and startability. Be sure to use oil of the recommended quality and appropriate viscosity.

All engines consume a certain amount of oil during normal operation. Therefore, it is important to check the oil level at regular intervals or before starting a long trip.

1. Park the car on a horizontal surface.
2. Switch off the engine.
3. Wait a few minutes.
4. Remove the dipstick and wipe it with a clean cloth.
5. Reinsert the dipstick as far as it goes.
6. Remove the dipstick and read the oil level, which should always be within the range indicated.

7. If the oil level is below the specified limit, remove the cap located on the cylinder head cover and add enough oil to raise the level to within the specified range. Do not overfill to avoid engine damage. Be sure to use the specified engine oil and do not mix various types of oil.
8. After adding oil, close the cap securely.
9. Confirm the oil level by repeating step 4 to 6.

Use only the recommended oils with an ACEA or API classification as specified in this manual.

NOTE

- Check or refill the oil according to the following manner.
 - When the oil level is checked in step 6 above, check it on a low side of the dipstick because it is different in appearance of oil level in the two sides of the dipstick.
 - On vehicles without diesel particulate filter (DPF), the oil level should be within the range (A) to (B) on the dipstick.
 - On vehicles with DPF, the oil level should be within the range (A) to (C) (oil replacement indication mark) on the dipstick.

If the oil level is beyond the oil replacement indication mark (C), replace the oil as soon as possible. Then, the oil should be refilled to the maximum level (B).

- On vehicles with DPF, the engine oil will increase due to a little fuel getting mixed in the engine oil when the DPF regenerates to burn away the PM (particulate matter). However, it does not indicate a malfunction.
- The engine oil will deteriorate rapidly if the vehicle is subjected to severe conditions, requiring earlier oil replacement. Please refer to the maintenance schedule.
- For handling of used engine oils, refer to page 05.

Selection of engine oil

Vehicles without diesel particulate filter (DPF)

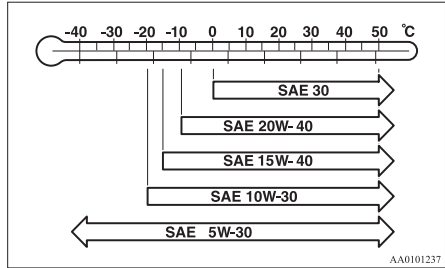

- Select engine oil of the proper SAE viscosity number according to the atmospheric temperature.
- Use engine oil conforming to the following classification:
 - ACEA classification: “For service A1/ B1, A3/B3, A3/B4, A5/B5”

- API classification: “For service CF-4”

NOTE

- Use of additives is not recommended since they may reduce the effectiveness of additives already included in the engine oil. It may result in failure of the mechanical assembly.

Vehicles with diesel particulate filter (DPF)

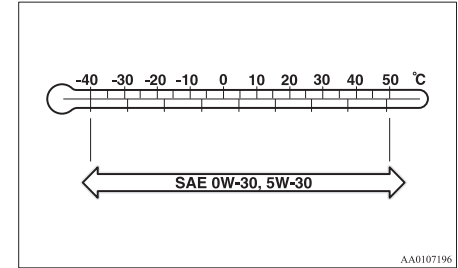

- Select engine oil of the proper SAE viscosity number according to the atmospheric temperature.
- Use engine oil conforming to the following classification:
 - ACEA classification: “For service C1, C2, C3 or C4”
 - JASO classification: “For service DL-1”

If those classifications are not available, contact a MITSUBISHI MOTORS Authorized Service Point.

NOTE

- Use of additives is not recommended since they may reduce the effectiveness of additives already included in the engine oil. It may result in failure of the mechanical assembly.

Engine coolant

E01000502153

To check the coolant level

A transparent coolant reserve tank (A) is located in the engine compartment.

The coolant level in this tank should be kept between the “LOW” and “FULL” marks when measured while the engine is cold.

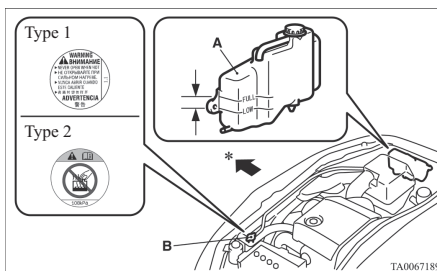

*: Front of the vehicle

To add coolant

The cooling system is a closed system and normally the loss of coolant should be very slight. A noticeable drop in the coolant level could indicate leakage. If this occurs, we recommend you to have the system checked as soon as possible.

If the level should drop below the “LOW” level on the reserve tank, open the lid and add coolant.

Also, if the reserve tank is completely empty, remove the radiator cap (B) and add coolant until the level reaches the filler neck.

⚠ WARNING

- Do not open the radiator cap (B) while the engine is hot. The coolant system is under pressure and any hot coolant escaping could cause severe burns.

Anti-freeze

The engine coolant contains an ethylene glycol anti-corrosion agent. The cylinder head and water pump housing are cast aluminium alloy, and periodic changing of the engine coolant is necessary to prevent corrosion of these parts.

Use “MITSUBISHI MOTORS GENUINE SUPER LONG LIFE COOLANT” or equivalent.

MITSUBISHI MOTORS GENUINE Coolant has excellent protection against corrosion and rust formation of all metals including aluminium and can avoid blockages in the radiator, heater, cylinder head, engine block, etc.

Because of the necessity of this anti-corrosion agent, the coolant must not be replaced with plain water even in summer. The required concentration of anti-freeze differs depending on the expected ambient temperature.

Ambient temperature (minimum) °C	-15	-20	-25	-30	-35	-50
Anti-freeze concentration %	30	35	40	45	50	60

⚠ CAUTION

- Do not use alcohol or methanol anti-freeze or any engine coolants mixed with alcohol or methanol anti-freeze. The use of an improper anti-freeze can cause corrosion of the aluminium components.
- For effective anti-corrosion and anti-freeze performance, keep the anti-freeze concentration within the range of 30 to 60 %. Concentrations exceeding 60 % will result in a reduction of both the anti-freeze and cooling performance thus adversely affecting the engine.
- Do not top up with water only. Water by itself reduces the rust-protective and anti-freeze qualities of the coolant and has a lower boiling point. It can also cause damage to the cooling system if it should freeze. Do not use tapwater, as it can cause corrosion and rust formation.

During cold weather

If the temperatures in your area drop below freezing, there is the danger that the coolant in the engine or radiator could freeze and cause severe damage to the engine and/or radiator. Add a sufficient amount of anti-freeze to the coolant to prevent it from freezing. The concentration should be checked before the start of cold weather and anti-freeze added to the system if necessary.

Automatic transmission fluid*

E01000601030

The proper amount of automatic transmission fluid is essential to the life and operation of the automatic transmission. Either insufficient fluid or excessive fluid could cause transmission trouble. The transmission fluid filler port cap is equipped with a dipstick. Use the following procedure to check the fluid level.

Procedure for checking the fluid level

1. Check the fluid level after the vehicle has been driven enough to warm up the transmission fluid.
2. Park the vehicle on a flat, level surface and apply the parking brake.
3. With the engine idling and the brake pedal fully depressed, move the transmission selector lever through all the positions from “P” (PARK) to “D” (DRIVE), stopping momentarily at each position.
4. Move the selector lever to the “P” (PARK) position.
5. Remove the dipstick and wipe it with a clean lint-free cloth.
6. Reinsert the dipstick as far as it goes.

7. Remove dipstick and read the automatic transmission fluid level. The fluid level should always be between the two marks on the dipstick.

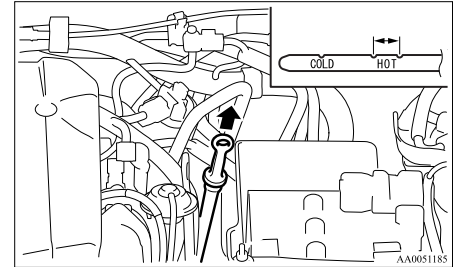

⚠ WARNING

- Do not spill the fluid onto a hot exhaust manifold during topping up or inspection, or a fire may occur.

Fluid type

Use only “MITSUBISHI MOTORS GENUINE ATF SP III” transmission fluid to ensure optimum transmission performance.

Maintenance

Washer fluid

E01000700672

The windscreen washer fluid reservoir is in the engine compartment. Check the washer fluid level at regular intervals and add washer fluid to reservoir if necessary.

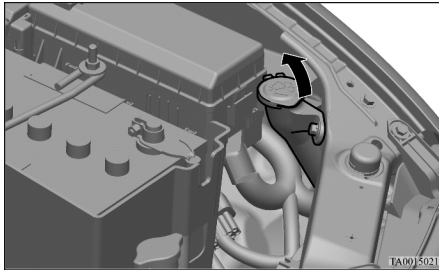

NOTE

- The washer fluid container serves the windscreen and headlamps (if so equipped).

During cold weather

To ensure proper operation of the washers at low temperatures, use a fluid containing an anti-freezing agent.

Brake fluid

E01000900935

To check the fluid level

Check the brake fluid level in the reservoir. The brake fluid level must be between the “MAX” and “MIN” marks on the reservoir.

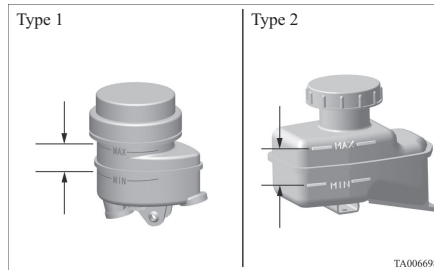

The brake fluid level is monitored by a float. When the brake fluid level falls below the “MIN” mark, the brake fluid warning lamp lights up. The fluid level falls slightly with wear of the brake pads, but this does not indicate any abnormality. If the brake fluid level falls markedly in a short length of time, it indicates leaks from the brake system. If this occurs, we recommend you to have the vehicle checked.

Fluid type

Use brake fluid conforming to DOT3 or DOT4. The brake fluid is hygroscopic. Too much moisture in the brake fluid will adversely affect the brake system, reducing the brake performance.

In addition, the brake fluid reservoir is equipped with a special cap to prevent the entrance of air, and this cap should not be removed.

CAUTION

- Take care in handling brake fluid as it is harmful to the eyes, may irritate your skin and also damage painted surfaces.
- Use only the specified brake fluid. Do not mix or add different brands of brake fluid to prevent chemical reactions. Do not let any petroleum-based fluid touch, mix with, or get into the brake fluid. This will damage the seals.
- Keep the reservoir tank cap closed to prevent the brake fluid from deteriorating except maintenance.
- Clean the filler cap before removing and close the cap securely after maintenance.

Clutch fluid*

E01001000281

To check the fluid level

The clutch fluid in the master cylinder should be checked when performing other underhood service. In addition, the system should be checked for leakage at the same time.

Check to make certain that the clutch fluid level is always between the “MAX” and “MIN” level markings on the fluid reservoir.

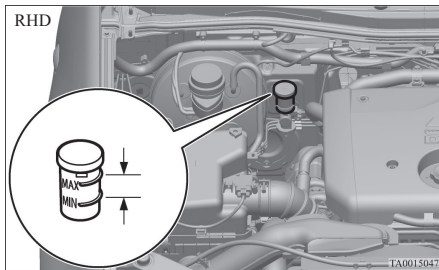
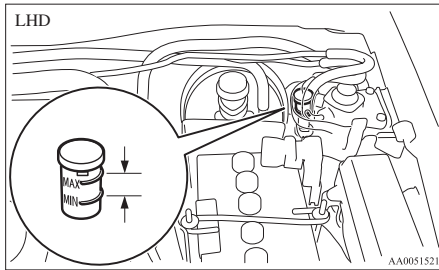

A rapid fluid loss indicates a leak in the clutch system which should be inspected by a MITSUBISHI MOTORS Authorized Service Point or another specialist and repaired immediately.

Fluid type

Brake fluid conforming to DOT 3 or DOT 4 should be used.

The reservoir cap must be fully tightened to avoid contamination from foreign matter or moisture. DO NOT ALLOW PETROLEUM-BASED FLUID TO CONTACT, MIX WITH, OR OTHERWISE CONTAMINATE THE BRAKE FLUID. SEAL DAMAGE WILL RESULT.

⚠ WARNING

- Take care in handling brake fluid as it is harmful to the eyes and may also cause damage to painted surfaces. Wipe up any spills immediately.

Power steering fluid

E01001101407

To check the fluid level

Check the fluid level in the reservoir while the engine is idling.

Check to make certain that the power steering fluid level is always between the “MAX” and “MIN” level markings on the fluid reservoir and refill the fluid if necessary.

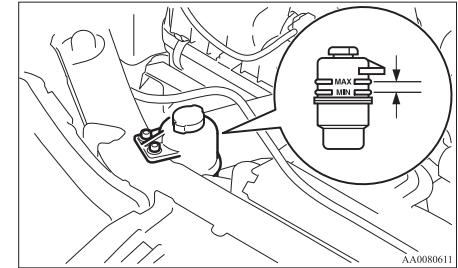

Fluid type

Use “MITSUBISHI MOTORS GENUINE PSF (Power Steering Fluid)”.

Battery

E01001202144

The condition of the battery is very important for quick starting of the engine and proper functioning of the vehicle's electrical system. Regular inspection and care are especially important in cold weather.

NOTE

- On vehicles equipped with 2 batteries, when the batteries are replaced, the 2 batteries should be replaced at the same time. If only a battery is replaced, it will cause shortening the batteries life.

Checking battery electrolyte level

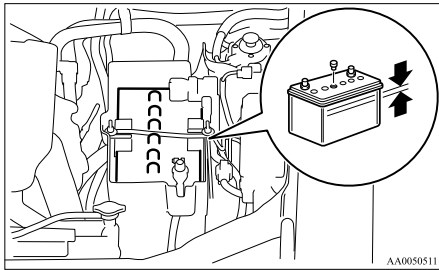

The electrolyte level must be between the specified limit on the outside of the battery. Replenish with distilled water as necessary.

The inside of the battery is divided into several compartments; remove the cap from each compartment and fill to the upper mark. Do not top up beyond the upper mark because spillage during driving could cause damage.

Check the electrolyte level at least once every 4 weeks, depending on the operating conditions. If the battery is not used, it will discharge by itself with time.

Check it once every 4 weeks and charge with low current as necessary.

During cold weather

The capacity of the battery is reduced at low temperatures. This is an inevitable result of its chemical and physical properties.

This is why a very cold battery, particularly one that is not fully charged, will only deliver a fraction of the starter current which is normally available.

We recommend you to have the battery checked before the start of cold weather and, if necessary, have it charged or replaced.

This does not only ensure reliable starting, but a battery which is kept fully charged also has a longer life.

Disconnection and connection

To disconnect the battery cable, stop the engine, first disconnect the negative (-) terminal and then the positive (+) terminal.

When connecting the battery, first connect the positive (+) terminal and then the negative (-) terminal.

NOTE

- Open the terminal cover (A) before disconnecting or connecting the positive (+) terminal of the battery.

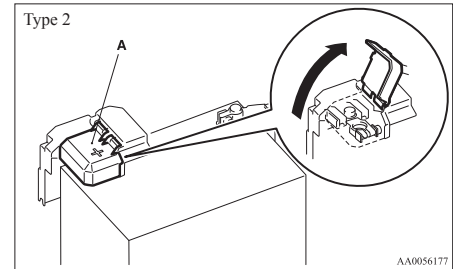
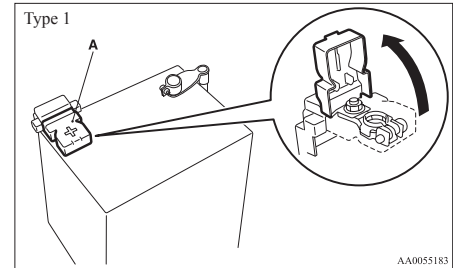

⚠ WARNING

- Keep sparks, cigarettes, and flames away from the battery because the battery could explode.

Tyres

E01001300239

⚠ WARNING

- The battery electrolyte is extremely caustic. Do not allow it to come in contact with your eyes, skin, clothing, or the painted surfaces of the vehicle. Spilt electrolyte should be flushed immediately with ample amounts of water. Irritation to eyes or skin from contact with electrolyte requires immediate medical attention.
- Ventilate when charging or using the battery in an enclosed space.

⚠ CAUTION

- Never disconnect the battery with the ignition switch in the "ON" position; doing so could damage the vehicle's electrical components.
- Never short-circuit the battery; doing so could cause it to overheat and be damaged.
- Always wear protective eye goggles when working near the battery.
- If the battery is to be quick-charged, first disconnect the battery cables.
- In order to prevent a short circuit, be sure to disconnect the negative (-) terminal first.
- Keep it out of reach of children.

⚠ CAUTION

- Do not bring the nearby parts, the plastic parts and so on into contact with sulphuric acid (battery electrolyte) which may crack, stain or discolour them. If they are in contact, wipe off with soft cloth, chamois or the like and an aqueous solution of neutral detergent then immediately rinse the affected parts with plenty of water.

NOTE

- Keep the terminals clean. After the battery is connected, apply terminal protection grease. To clean the terminals, use lukewarm water.
- Check to see if the battery is securely installed and cannot be moved during travel. Also check each terminal for tightness.
- When the vehicle is to be left unused for a long period of time, remove the battery and store it in a place where the battery fluid will not freeze. The battery should be stored only in a fully charged condition.

⚠ WARNING

- Driving with tyres that are worn, damaged or improperly inflated can lead to a loss of control or blow out of the tyres which can result in a collision with serious or fatal injury.

Tyre inflation pressures

E01001402423

Tyre size	UP TO 3 PASSENGERS		MAX. LOAD OR TRAILER TOWING	
	Front	Rear	Front	Rear
195R15C 106/104R 8PR, 215/70R15C 109/107R*	2.2 bar (220 kPa) {32 psi}	2.2 bar (220 kPa) {32 psi}	2.2 bar (220 kPa) {32 psi}	4.5 bar (450 kPa) {65 psi}
205R16C 110/108R 8PR	2.4 bar (240 kPa) {35 psi}	2.4 bar (240 kPa) {35 psi}	2.4 bar (240 kPa) {35 psi}	4.5 bar (450 kPa) {65 psi}
205/80R16 104S RF	2.2 bar (220 kPa) {32 psi}	2.2 bar (220 kPa) {32 psi}	2.2 bar (220 kPa) {32 psi}	2.9 bar (290 kPa) {42 psi}
245/70R16 111S RF	2.0 bar (200 kPa) {29 psi}	2.0 bar (200 kPa) {29 psi}	2.0 bar (200 kPa) {29 psi}	2.9 bar (290 kPa) {42 psi}
245/65R17 111S RF	2.0 bar (200 kPa) {29 psi}	2.0 bar (200 kPa) {29 psi}	2.0 bar (200 kPa) {29 psi}	2.9 bar (290 kPa) {42 psi}

*: On vehicles with 195 size tyres, this size of snow tyres can also be used instead.

Check the tyre inflation pressure of all the tyres while they are cold; if insufficient or excessive, adjust to the specified value. After the tyre inflation pressure has been adjusted, check the tyres for damage and air leaks. Be sure to put caps on the valves.

Wheel condition

E01001800797

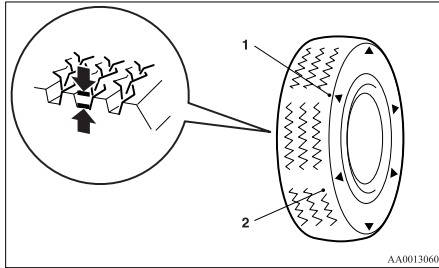

- 1- Location of the tread wear indicator
2- Tread wear indicator

Check the tyres for cuts, cracks and other damage. Replace the tyres if there are deep cuts or cracks. Also check each tyre for pieces of metal or pebbles. The use of worn tyres can be very dangerous because of the greater chance of skidding or hydroplaning. The tread depth of the tyres must exceed 1.6 mm in order for the tyres to meet the minimum requirement for use.

If there are tread wear indicators on the tyres, they will appear in six places on the surface of the tyre as the tyre wears, thereby indicating that the tyre no longer meets the minimum requirement for use. When these wear indicators appear, the tyres must be replaced with new ones.

Check that the wheel nuts are tightened correctly. Refer to the section entitled “For emergencies” for information concerning replacement of the tyres.

NOTE

- The mark and the location of the tyre tread wear indicators are different depending on the tyre manufacturer.

On 4-wheel drive vehicles, when replacement of any of the tyres is necessary, replace all of them.

⚠ CAUTION

- Always use tyres of the same size, same type, and same brand, and which have no wear differences.

Using tyres of different size, type, brands or degree of wear, will increase the differential oil temperature, resulting in possible damage to the driving system. Further, the drive train will be subjected to excessive loading, possibly leading to oil leakage, component seizure, or other serious faults.

Replacing tyres and wheels

E01007200038

⚠ CAUTION

- Avoid using different size tyres from the one listed and the combined use of different types of tyres, as this can affect driving safety. Refer to “Tyres and wheels” on page 9-17.

⚠ CAUTION

- Even if a wheel has the same rim size and offset as the specified type of wheel, its shape may prevent it from being fitted correctly. We recommend you to consult a specialist before using wheels that you have.

Tyre rotation

E01001900990

Tyre wear varies with vehicle conditions, road surface conditions and individual driver’s driving habits. To equalize the wear and help extend tyre life, it is recommended to rotate the tyres immediately after discovery of abnormal wear, or whenever the wear difference between the front and rear tyres is recognizable.

Maintenance

When rotating tyres, check for uneven wear and damage. Abnormal wear is usually caused by incorrect tyre pressure, improper wheel alignment, out of balance wheel, or severe braking. We recommend you to have it checked to determine the cause of irregular tread wear.

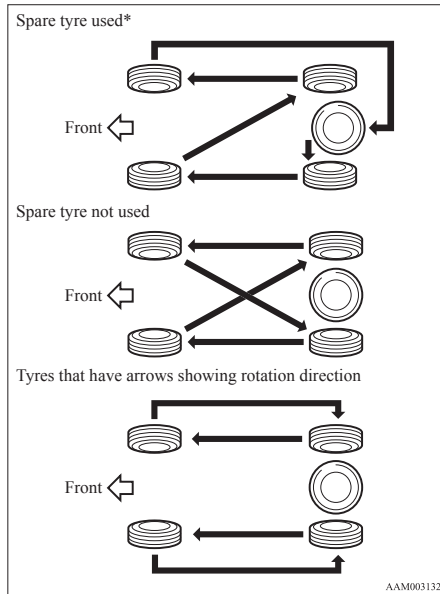

*- If the spare tyre wheel differs from the standard tyre wheel, do not perform tyre rotation using a spare wheel.

⚠ CAUTION

- If the tyres have arrows (A) indicating the correct direction of rotation, swap the front and rear wheels on the left hand side of the vehicle and the front and rear wheels on the right hand side of the vehicle separately. Keep each tyre on its original side of the vehicle. When fitting the tyres, make sure the arrows point in the direction in which the wheels will turn when the vehicle moves forward. Any tyre whose arrow points in the wrong direction will not perform to its full potential.

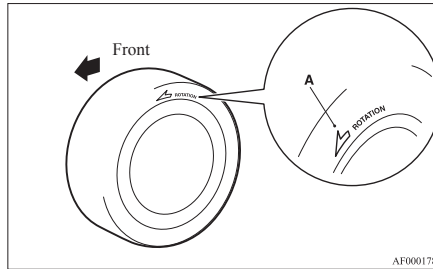

⚠ CAUTION

- Avoid the combined use of different types of tyres. Using different types of tyres can affect vehicle performance and safety.

Snow tyres

E01002000725

The use of snow tyres is recommended for driving on snow and ice. To preserve driving stability, mount snow tyres of the same size and tread pattern on all 4 wheels.

Snow tyres worn more than 50% are no longer suitable for use as snow tyres.

Snow tyres which do not meet specifications must not be used.

⚠ CAUTION

- Observe permissible maximum speed for your snow tyres and the legal speed limit.

NOTE

- The laws and regulations concerning snow tyres (driving speed, required use, type, etc.) vary. Find out and follow the laws and regulations in the area you intend to drive.
- If flange nuts are used on your vehicle, change to tapered nuts when steel wheels are used.

Tyre chains

E01002101983

It is recommended that snow chains are carried in snow regions and fitted when required to the rear wheels.

On 4WD vehicles in which the driving power is distributed preferentially to the rear wheels, ensure that the tyre chains are fitted on the rear.

Use only tyre chains which are designed for use with the tyres mounted on the vehicle: use of the incorrect size or type of chain could result in damage to the vehicle body.

Clutch pedal free play*

E01002200222

Press down the clutch pedal with your fingers until initial resistance is felt.

This distance should be within the specified range.

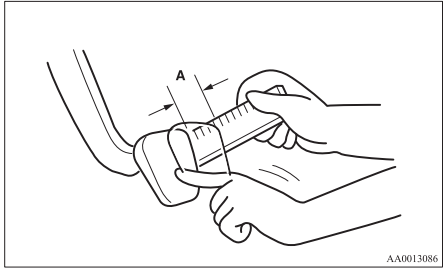

AA0013086

A- Free play: 4 to 13 mm

If the clutch pedal free play is not within the standard range, we recommend you to have it checked.

Before fitting tyre chains, we recommend you to consult a MITSUBISHI MOTORS Authorized Service Point. The max. chain height is as follows.

Tyre size	Wheel size	Max. chain height [mm]
195R15C, 215/70R15C*	15x6 JJ	22
205R16C	16x6 JJ	
205/80R16	16x6 JJ	
245/70R16	16x7 J	
245/65R17	17x7 1/2 J	

*: 215/70R15C size should only be used as snow tyres.

The speed limit for tyre chain is 50 km/h (30 mph) and remove the tyre chains as soon as possible on snow free roads.

WARNING

- DO NOT use a jack when fitting the chains, as in these conditions, the tyres may slip on the icy road causing the vehicle to slip off the jack.

CAUTION

- Practice fitting the chains before you need them.
Don't expect help from other people in the cold.
- Choose a clear straight stretch of road where you can pull over and still be seen while you are fitting the chains.

CAUTION

- Do not fit chains before you need them. This will wear out your tyres and the road surface.
- After driving around 100-300 metres, stop and retighten the chains.
- Drive carefully and do not exceed 50 km/h (30 mph). Remember, fitting chains is not going to stop accidents from happening.
- When tyre chains are installed, take care that they do not damage the disc wheel or body.
- An aluminium wheel can be damaged by a tyre chain while driving. When fitting a tyre chain on an aluminium wheel, take care that any part of the chain and fitting cannot be brought into contact with the wheel.
- When installing or removing the tyre chains, take care that hands and other parts of your body are not injured by the sharp edges of the vehicle body.
- Install the chains only on the rear tyres and tighten them as tightly as possible with the ends securely fastened.

NOTE

- The laws and regulations concerning the use of tyre chains vary. Find out and follow the laws and regulations of the area you're driving in.
In most countries, it is prohibited by law to use tyre chains on roads without snow.

Maintenance

Brake pedal free play

E01002300281

Stop the engine, depress the brake pedal several times, and press down the pedal with your fingers until initial resistance is felt. This distance should be within the specified range.

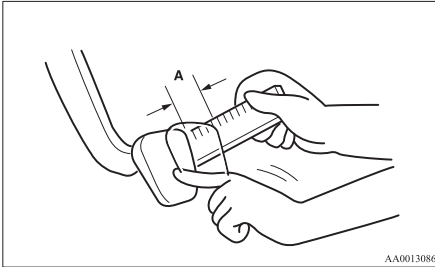

A- Free play: 3 to 8 mm

If the brake pedal free play is not within the standard range, we recommend you to have it checked.

Parking brake lever stroke

E01002400527

Pull the parking brake lever up to check the number of “clicks” that the ratchet makes. One click represents a lever movement of one notch. The lever should move the specified number of notches for normal brake application.

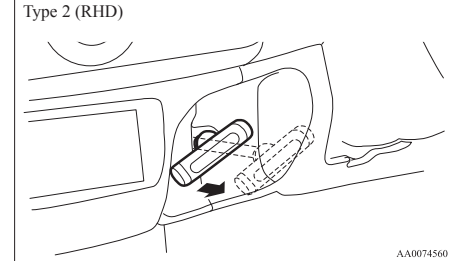
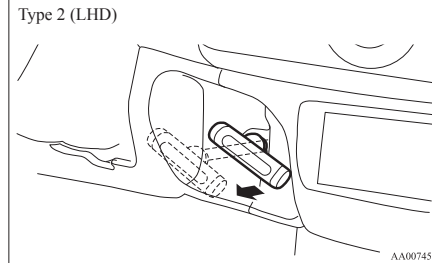
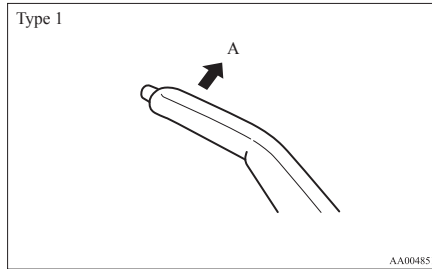

A- Parking brake lever stroke
Type 1 8 to 9 notches
Type 2 11 to 13 notches
(Parking brake adjustment when pulled with the force of 200 N)

If the parking brake lever stroke is out of the standard range, we recommend you to have it checked.

⚠ WARNING

- Continued operation of the vehicle with the parking brake lever out of adjustment may result in the vehicle moving when unattended.

Wiper blades

E01002600385

When lifting the wiper arms off the windscreen, first raise the driver's side wiper arm and then the passenger's side wiper arm.

When returning them to their original positions, first put the passenger's side wiper arm back in place and then the driver's side wiper arm.

If the blades are frozen to the windscreen, do not operate the wipers until the ice has melted and the blades are freed, otherwise the wiper motor may be damaged.

Wiper blade rubber replacement

Driver's side

1. Lift the wiper arm off the windscreen.
2. Pull the wiper blade until its stopper (A) disengages from the hook (B). Then, pull the wiper blade further to remove it.

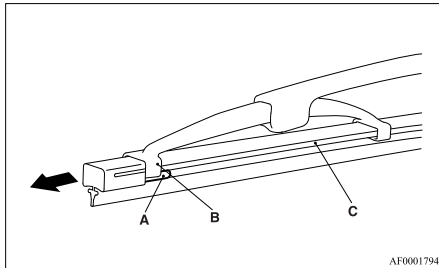

AF0001794

NOTE

- Do not allow the wiper arm to fall onto the windscreen; it could damage the glass.

3. Attach the retainers (C) to a new wiper blade.

For LHD vehicles refer to the illustration to ensure that the retainers are correctly aligned as you attach them.

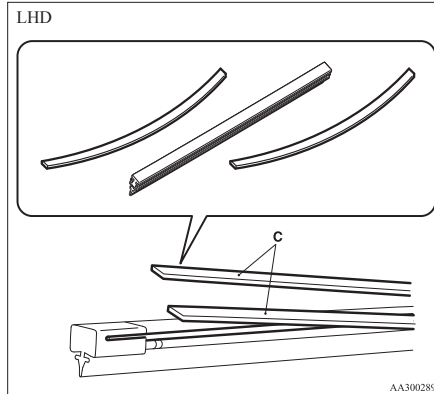

AA3002898

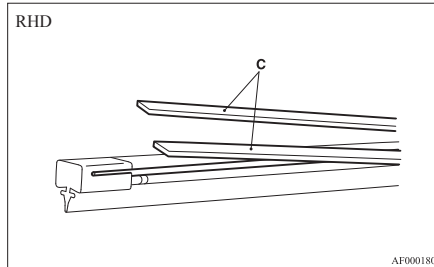

AF0001808

4. Insert the wiper blade into the arm, starting with the opposite end of the blade from the stopper. Make sure the hook (B) is fitted correctly in the grooves in the blade.

NOTE

- If retainers are not supplied with the new wiper blade, use the retainers from the old blade.

5. Push the wiper blade until the hook (B) engages securely with the stopper (A).

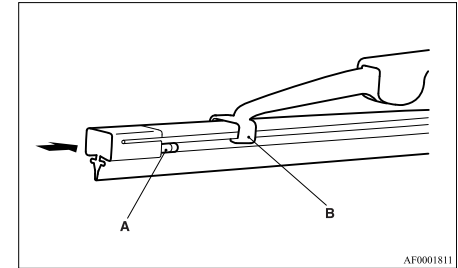

AF0001811

Passenger's side

1. Lift the wiper arm off the windscreen.
2. Pull the wiper blade until its stopper (A) disengages from the hook (B). Then, pull the wiper blade further to remove it.

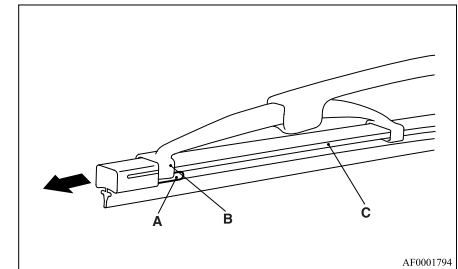

AF0001794

Maintenance

NOTE

- Do not allow the wiper arm to fall onto the windshield; it could damage the glass.

3. Attach the retainers (C) to a new wiper blade. Refer to the illustration to ensure that the retainers are correctly aligned as you attach them.

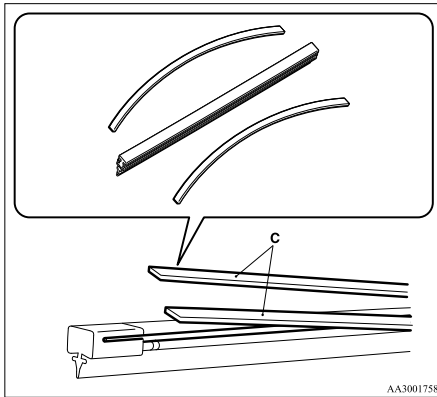

4. Insert the wiper blade into the arm, starting with the opposite end of the blade from the stopper. Make sure the hook (B) is fitted correctly in the grooves in the blade.

NOTE

- If retainers are not supplied with the new wiper blade, use the retainers from the old blade.

5. Push the wiper blade until the hook (B) engages securely with the stopper (A).

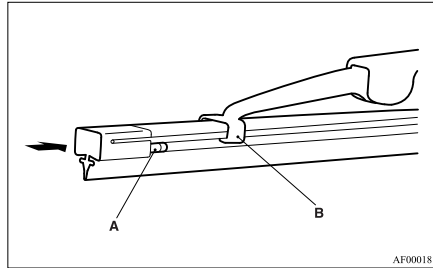

General maintenance

E01002700113

Fuel, engine coolant, oil and exhaust gas leakage

Look under the body of your vehicle to check for fuel, engine coolant, oil and exhaust gas leaks.

⚠ WARNING

- If you see a suspicious fuel leak or if you smell fuel, do not operate the vehicle; we recommend you to call for assistance.

Exterior and interior lamp operation

Operate the combination lamp switch to check that all lamps are functioning properly.

If the lamps do not illuminate, the probable cause is a blown fuse or defective lamp bulb. Check the fuses first. If there is no blown fuses, check the lamp bulbs.

For information regarding the inspection and replacement of the fuses and the lamp bulbs, refer to "Fuses" on page 8-20 and "Replacement of lamp bulbs" on page 8-23.

If the fuses and bulbs are all OK, we recommend you to have your vehicle checked and repaired.

Meter, gauge and indicator/warning lamps operation

Run the engine to check the operation of all meters, gauges, and indicator/warning lamps.

If there is anything wrong, we recommend you to have your vehicle inspected.

Hinges and latches lubrication

Check all latches and hinges, and lubricate if necessary by first cleaning and then applying multipurpose grease.

For cold and snowy weather

E01002800257

Ventilation slots

The ventilation slots in front of the windscreen should be kept clear of leaves or brushed clear after heavy snowfall, so that the operation of the heating and ventilation systems will not be impaired.

Weatherstripping

To prevent freezing of the weatherstripping on the doors, bonnet, etc., they should be treated with silicone grease or spray.

Additional equipment

It is a good idea to carry a shovel or a short-handled spade in the vehicle during the winter so that you can clear away snow if you get stranded. A small hand-brush for sweeping snow off the vehicle and a plastic scraper for the windscreen and rear window are also useful.

Fusible links

E01002900030

The fusible links will melt to prevent a fire if a large current attempts to flow through certain electrical systems.

In case of a melted fusible link, we recommend you to have your vehicle inspected.

Fuses

Fuse block location

E01003000849

E01007600032

To prevent damage to the electrical system due to shortcircuiting or overloading, each individual circuit is provided with a fuse.

There are fuse blocks in the passenger compartment and in the engine compartment.

Passenger compartment

The fuse block in the passenger compartment is located in front of the driver's seat at the position shown in the illustration.

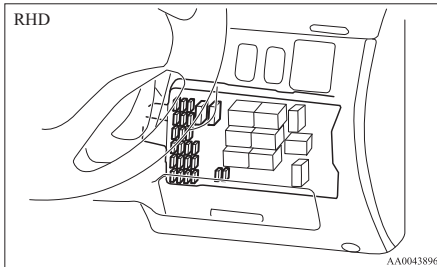
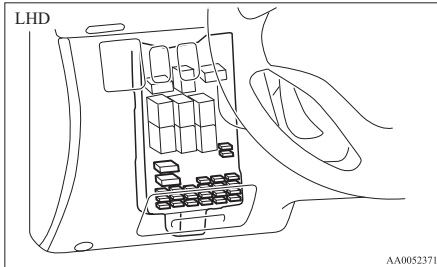

Engine compartment

In the engine compartment, the fuse block is located as shown in the illustration.

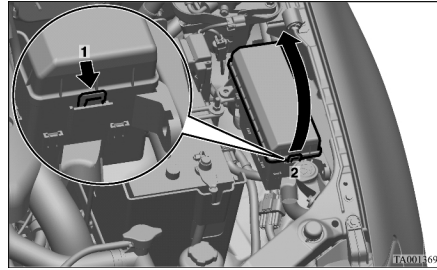

- 1- Push the knob.
- 2- Remove the cover.

Fuse load capacity

E01007700033

The fuse capacity and the name of the electrical systems protected by the fuses are indicated on the inside of the fuse lid located at the driver's leg area and on the inside of the fuse block cover for fuses located in the engine compartment.

Passenger compartment fuse location table

E01007900501

NOTE

- Spare fuses are contained in the fuse lid. Always use a fuse of the same capacity for replacement.

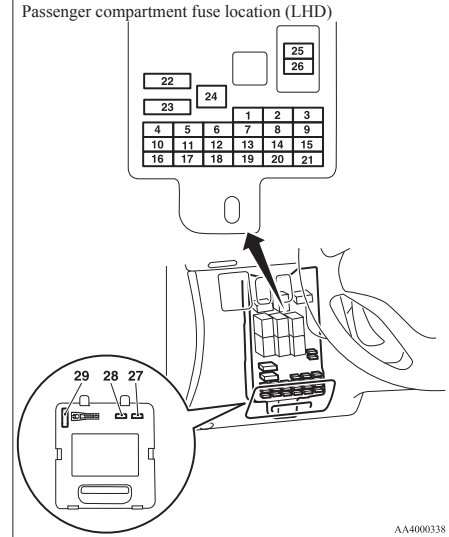

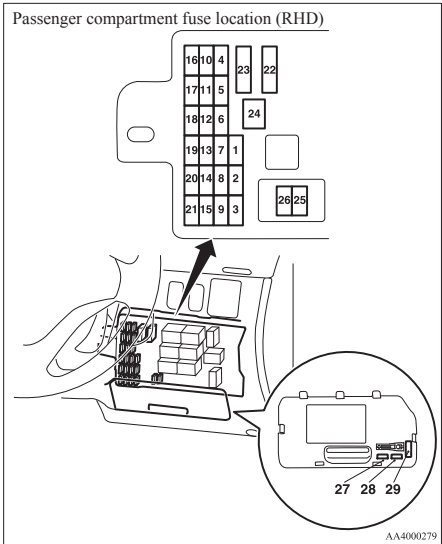

No.	Symbol	Electrical system	Capacity
1		Tail lamp (left)	7.5 A
2		Cigarette lighter	15 A
3		Ignition coil	10 A
4		Starter motor	7.5 A
5		Sunroof	20 A
6		Accessory socket	15 A

No.	Symbol	Electrical system	Capacity
7		Tail lamp (right)	7.5 A
8		Outside rear-view mirrors	7.5 A
9		Engine control unit	7.5 A
10		Control unit	7.5 A
11		Rear fog lamp	10 A
12		Central door lock	15 A
13		Room lamp	10 A
14		Rear window wiper	15 A
15		Gauge	7.5 A
16		Relay	7.5 A
17		Heated seat	20 A
18	OPTION	Option	10 A
19		Heated door mirror	7.5 A
20		Windscreen wiper	20 A
21		Reversing lamps	7.5 A
22		Demister	30 A
23		Heater	30 A
24		Power seat	40 A
25		Radio	10 A

No.	Symbol	Electrical system	Capacity
26		Electronic controlled unit	15 A
27	—	Spare fuse	7.5 A
28	—	Spare fuse	20 A
29	—	Spare fuse	30 A

- Some fuses may not be installed on your vehicle, depending on the vehicle model or specifications.
- The table above shows the main equipment corresponding to each fuse.
The fuse block does not contain spare 10 A and 15 A fuses. If a fuse of one of these capacities blows, replace it temporarily by borrowing the one that matches from:
10 A: Radio
15 A: Cigarette lighter
 Replace the borrowed fuse as soon as possible.

Maintenance

Engine compartment fuse location table

E01008000583

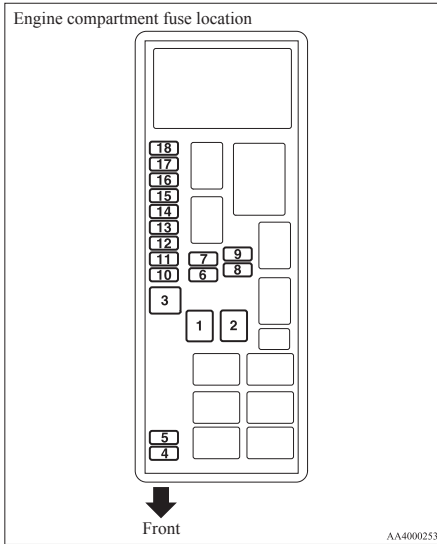

AA4000253

No.	Symbol	Electrical system	Capacity
1	—	—	—
2		Electric window system	40 A
3		Ignition switch	40 A
4		Air conditioning compressor	10 A
5		Condenser fan motor	20 A

No.	Symbol	Electrical system	Capacity
6		Headlamp high-beam (left)	10 A
7		Headlamp high-beam (right)	10 A
8		Headlamp low beam (left)	10 A
9		Headlamp low beam (right)	10 A
10		Engine control	20 A
11		Alternator	7.5 A
12	STOP	Stop lamps	15 A
13		Horn	10 A
14	A/T	Automatic transmission	20 A
15		Hazard warning flasher	10 A
16		Fuel pump	15 A
17		Front fog lamps	15 A
18		Audio amp	20 A

- Some fuses may not be installed on your vehicle, depending on the vehicle model or specifications.
- The table above shows the main equipment corresponding to each fuse.

Identification of fuse

E01008100308

Capacity	Colour
7.5 A	Brown
10 A	Red
15 A	Blue
20 A	Yellow
30 A	Green (fuse type)/ Pink (fusible link type)
40 A	Green (fusible link type)

Fuse replacement

E01007800656

1. Before replacing a fuse, always turn off the electrical circuit concerned and place the ignition switch in the "LOCK" position.
2. Pull the fuse lid (A) to remove it.
3. Remove the fuse puller (B) from the fuse lid (A).

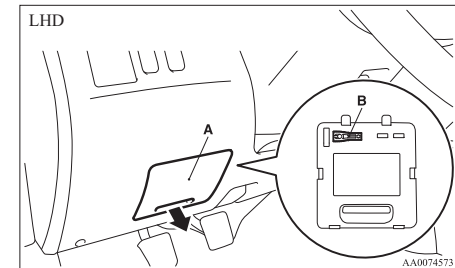

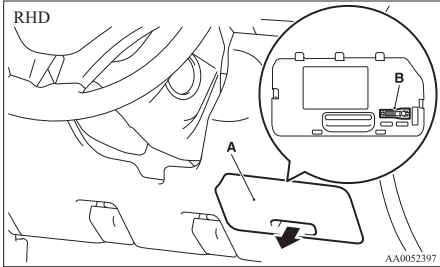

4. Referring to the fuse load capacity table, check the fuse pertaining to the problem.

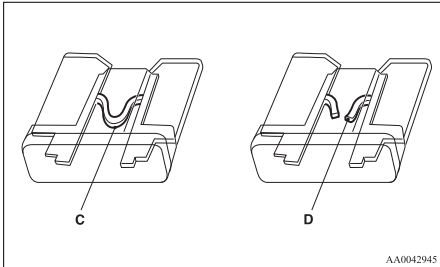

C- Fuse is OK
D- Blown fuse

NOTE

- If any system does not function but the fuse corresponding to that system is normal, there may be a fault in the system elsewhere. We recommend you to have your vehicle checked.

5. Insert a new fuse of the same capacity by using the fuse puller into the same place at the fuse block.

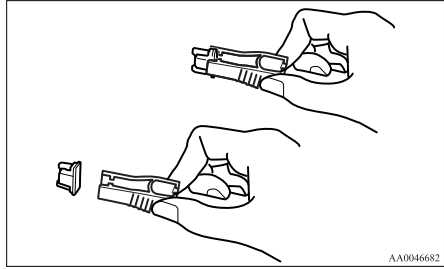

⚠ CAUTION

- If the newly inserted fuse blows again after a short time, we recommend you to have the electrical system checked to find the cause and rectify it.
- Never use a fuse with a capacity larger than that specified or any substitute, such as wire, foil, etc.; doing so will cause the circuit wiring to heat up and could cause a fire.

Replacement of lamp bulbs

E01003100710

Before replacing a bulb, ensure the lamp is off. Do not touch the glass part of the new bulb with your bare fingers; the skin oil left on the glass will evaporate when the bulb gets hot and the vapour will condense on the reflector and dim the surface.

⚠ CAUTION

- Bulbs are extremely hot immediately after being turned off. When replacing a bulb, wait for it to cool sufficiently before touching it. You could otherwise be burnt.

NOTE

- If you are unsure of how to carry out the work as required, we recommend you to consult a specialist.
- Be careful not to scratch the vehicle body when removing a lamp or lens.
- When it rains or when the vehicle has been washed, the inside of the lens sometimes becomes foggy. This is the same phenomenon as when window glass mists up on a humid day, and does not indicate a functional problem. When the lamp is switched on, the heat will remove the fog. However, if water gathers inside the lamp, we recommend you to have the lamp checked.

Bulb capacity

E01003200085

When replacing a bulb, use a new bulb with the same wattage and colour.

Maintenance

Outside

E01003302846

Front

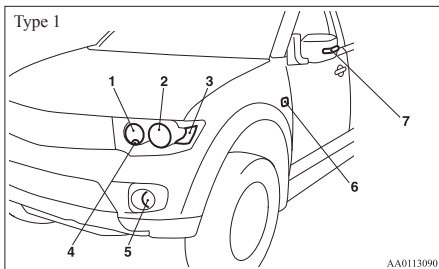

- 1- Headlamps, high-beam: 60 W (HB3)
- 2- Headlamps, low beam: 55 W (H11)
- 3- Front turn-signal lamps: 21 W (PY21W)
- 4- Position lamps: 5 W (W5W)
- 5- Front fog lamps*: 55 W (H11)
- 6- Side turn-signal lamps (on fender)*: 5 W (WY5W)
- 7- Side turn-signal lamps (on outside rear-view mirror)*

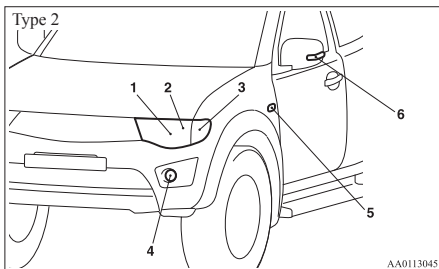

- 1- Headlamps, high/low beam: 60/55 W (H4)
- 2- Position lamps: 5 W (W5W)
- 3- Front turn-signal lamps: 21 W (PY21W)
- 4- Front fog lamps*: 55 W (H11)
- 5- Side turn-signal lamps (on fender)*: 5 W (WY5W)
- 6- Side turn-signal lamps (on outside rear-view mirror)*

Codes in parentheses indicate bulb types.

NOTE

- The side turn-signal lamp (on outside rear-view mirror) uses an LED instead of a bulb. For repair and replacement, contact a MITSUBISHI MOTORS Authorized Service Point.

Rear

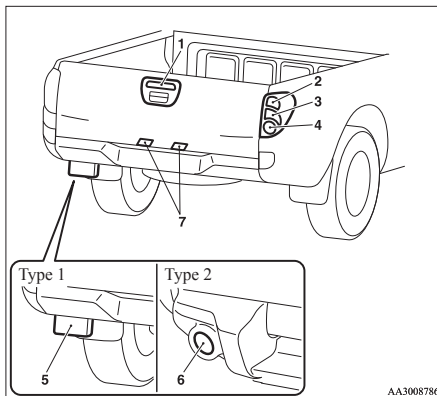

- 1- High-mounted stop lamp: 5 W (W5W)
- 2- Rear turn-signal lamps: 16 W (W16W)
- 3- Tail and stop lamps: 21/5 W (P21/5W)
- 4- Reversing lamps: 16 W (W16W)
- 5- Rear fog lamp (Type 1, Driver's side only): 21 W (P21W)
- 6- Rear fog lamp (Type 2, Driver's side only): 21 W (W21W)
- 7- Licence plate lamps: 5 W (W5W)

Codes in parentheses indicate bulb types.

Inside

E01003401518

Single cab

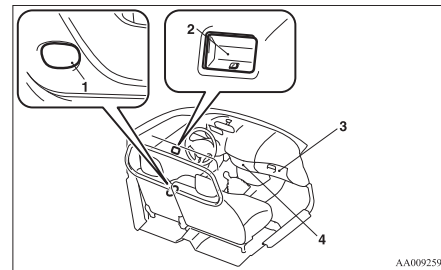

- 1- Door courtesy lamps*: 3.4 W
- 2- Room lamp: 8 W
- 3- Glove box lamp: 1.4 W
- 4- Centre console downlight: 1.4 W

Club cab

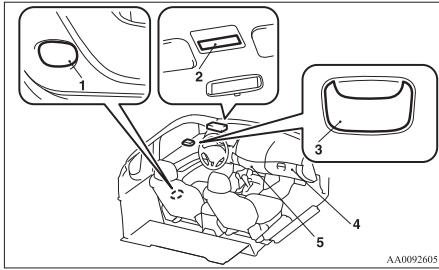

- 1- Door courtesy lamps*: 3.4 W
- 2- Front room lamp and personal lamps*: 7.5 W
- 3- Rear room lamp: 8 W
- 4- Glove box lamp: 1.4 W
- 5- Centre console downlight: 1.4 W

Double cab

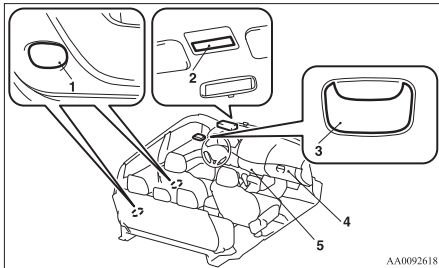

- 1- Door courtesy lamps*: 3.4 W
- 2- Front room lamp and personal lamps: 7.5 W
- 3- Rear room lamp*: 8 W
- 4- Glove box lamp: 1.4 W
- 5- Centre console downlight: 1.4 W

Headlamps

E01003501375

Type 1

1. Remove the bulb and connector assembly (A) by turning it anticlockwise.

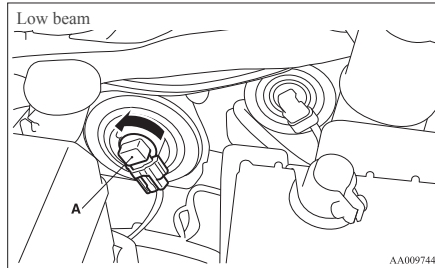
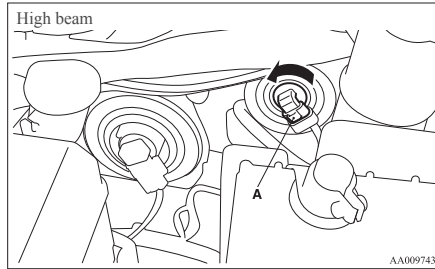

2. Depress the tab (B) on the harness connector and pull the harness connector (C) to remove it.

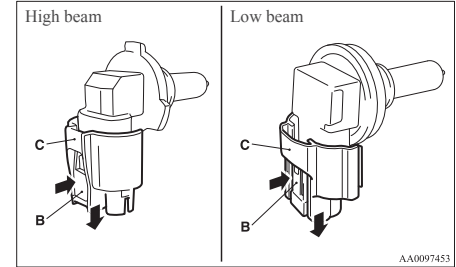

3. To install the bulb, perform the removal steps in reverse.

CAUTION

- Handle halogen lamp bulbs with care. The gas inside halogen lamp bulbs is highly pressurized, so dropping, knocking, or scratching a halogen lamp bulb can cause it to shatter.
- Never hold the halogen lamp bulb with a bare hand, dirty glove, etc. The oil from your hand could cause the bulb to break the next time the headlamps are operated. If the glass surface is dirty, it must be cleaned with alcohol, paint thinner, etc., and refit it after drying it thoroughly.

Maintenance

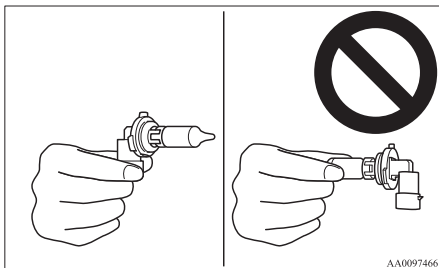

Type 2

1. Disconnect the connector (A).

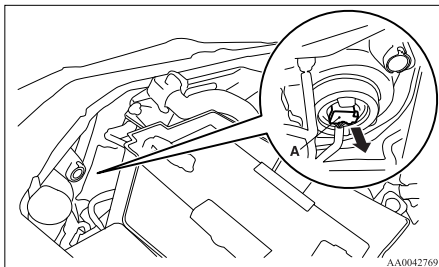

2. Remove the sealing cover (B).

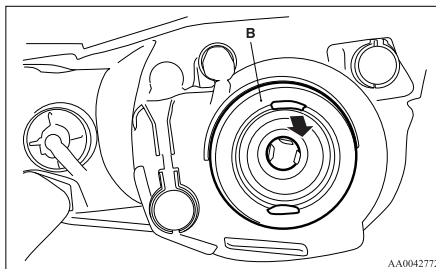

3. Unhook the spring (C) which secures the bulb, and then remove the headlamp bulb.

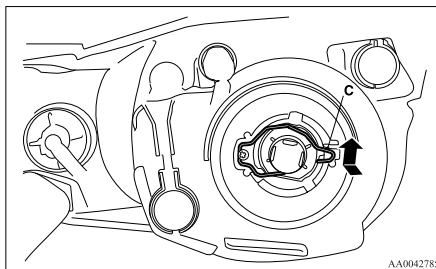

4. To install the bulb, perform the removal steps in reverse.

⚠ CAUTION

- Handle halogen lamp bulbs with care. The gas inside halogen lamp bulbs is highly pressurized, so dropping, knocking, or scratching a halogen lamp bulb can cause it to shatter.
- Never hold the halogen lamp bulb with a bare hand, dirty glove, etc. The oil from your hand could cause the bulb to break the next time the headlamps are operated. If the glass surface is dirty, it must be cleaned with alcohol, paint thinner, etc., and refit it after drying it thoroughly.

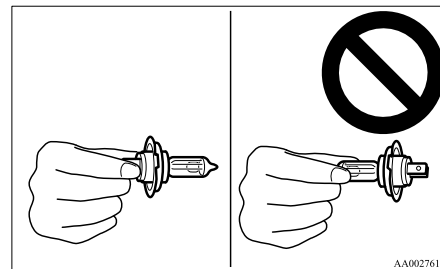

Position lamps

E01003700833

Type 1

1. Turn the bulb socket anticlockwise to remove it. And remove the bulb from the socket by pulling out.

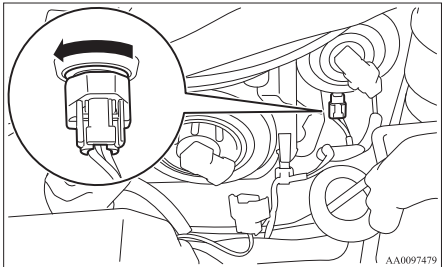

2. To install the bulb, perform the removal steps in reverse.

Type 2

1. Turn the bulb socket anticlockwise to remove it. And remove the bulb from the socket by pulling out.

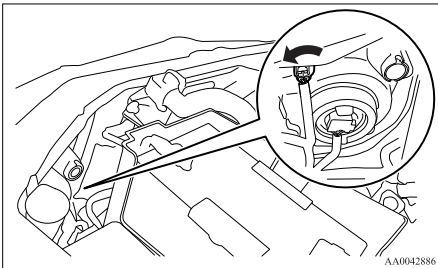

2. To install the bulb, perform the removal steps in reverse.

Front turn-signal lamps

E01003800818

Type 1

1. Turn the bulb socket anticlockwise to remove it. And remove the bulb from the socket

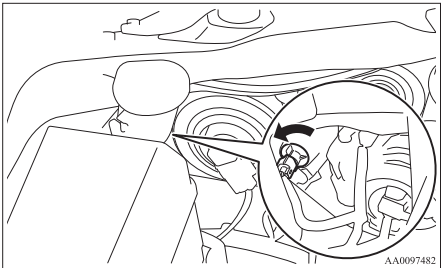

2. To install the bulb, perform the removal steps in reverse.

Type 2

1. Turn the bulb socket anticlockwise to remove it. And remove the bulb from the socket by turning it anticlockwise while pressing in.

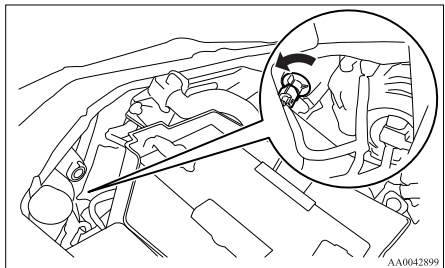

Maintenance

2. To install the bulb, perform the removal steps in reverse.

Side turn-signal lamps (on fender)*

E01003900633

1. To remove a side turn-signal lamp, insert a straight blade (or minus) screwdriver at the end of the lamp nearer the front of the body and use it to gently lever the lamp out of the body.

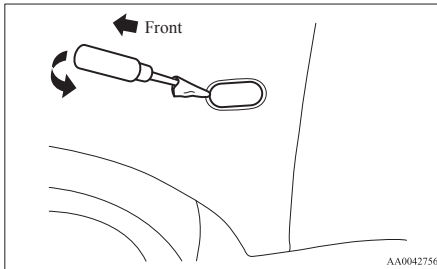

NOTE

- Wrap a piece of cloth around the tip of the screwdriver in order to avoid scratching the lens and the body.

2. Remove the socket and bulb assembly together by turning it anticlockwise, and then remove the bulb by pulling it out.

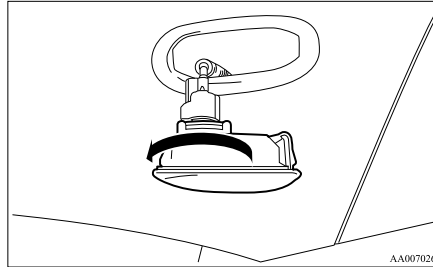

3. To install the bulb, perform the removal steps in reverse.

NOTE

- When replacing the lamp assembly, push in the end facing the rear of the vehicle first.

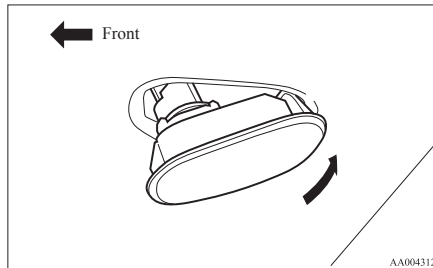

Side turn-signal lamps (on outside rear-view mirrors)*

E01003900646

The side turn-signal lamp (on outside rear-view mirror) uses an LED instead of a bulb. For repair and replacement, contact a MITSUBISHI MOTORS Authorized Service Point.

Front fog lamps*

E01004001537

1. Insert a straight blade (or minus) screwdriver with a cloth over its tip at the edge of the cover and pry gently to remove the cover.

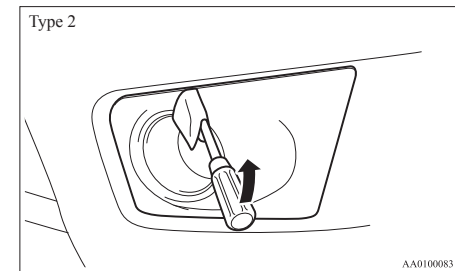
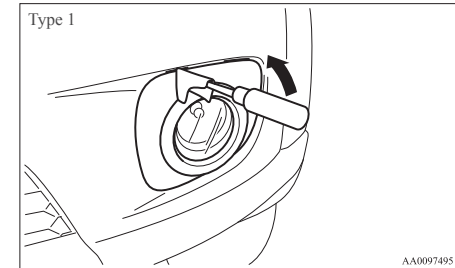

- Turn the 3 bolts (A) anticlockwise to remove them. And then remove the lamp assembly.

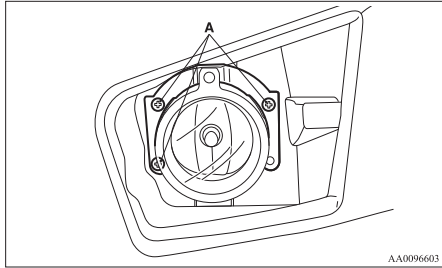

- Turn the entire socket and bulb assembly (D) anticlockwise to remove it.

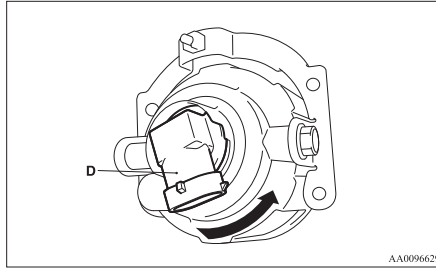

- Depress the tab (B) on the harness connector and pull the harness connector (C) to remove it.

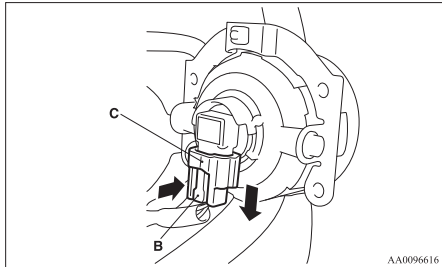

- To install the bulb, perform the removal steps in reverse.

⚠ CAUTION

- Handle halogen lamp bulbs with care. The gas inside halogen lamp bulbs is highly pressurized, so dropping, knocking, or scratching a halogen lamp bulb can cause it to shatter.
- Never hold the halogen lamp bulb with a bare hand, dirty glove, etc. The oil from your hand could cause the bulb to break the next time the fog lamps are operated. If the glass surface is dirty, it must be cleaned with alcohol, paint thinner, etc., and refit it after drying thoroughly.

Maintenance

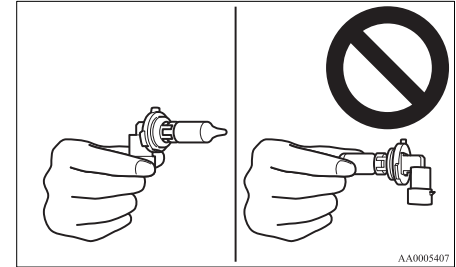

Rear fog lamp

E01004100384

Type 1 (Driver's side only)

- Remove the screws (A) from the rear fog lamp lens, and then remove the lens (B).

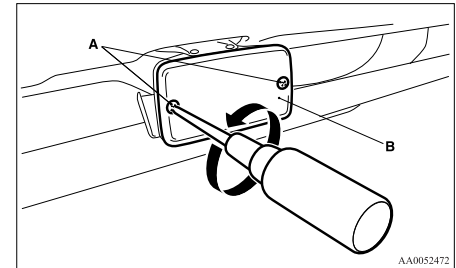

Maintenance

2. Remove the bulb (C) by turning it anticlockwise while pressing it inward.

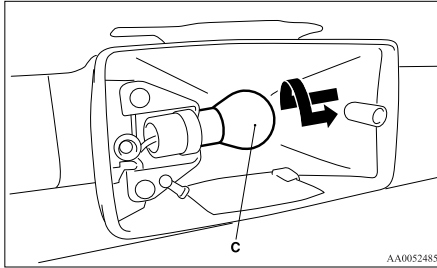

3. To install the bulb, perform the removal steps in reverse.

Type 2 (Driver's side only)

1. Remove the socket and bulb assemblies by turning it anticlockwise, and then remove the bulb by pulling out.

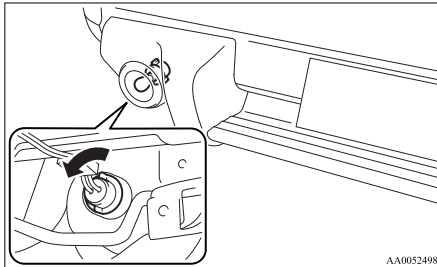

2. To install the bulb, perform the removal steps in reverse.

Rear combination lamps

E01004200763

1. Open the rear gate.
(Refer to "Rear gate" on page 1-13.)
2. Remove the screws (A) that hold the lamp unit.

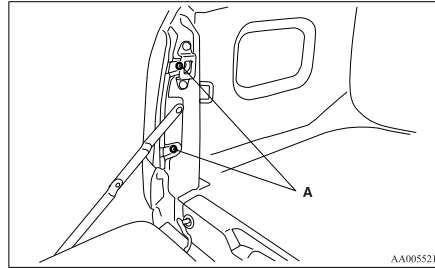

3. Move the lamp unit towards the rear of the vehicle and remove the clips (B).

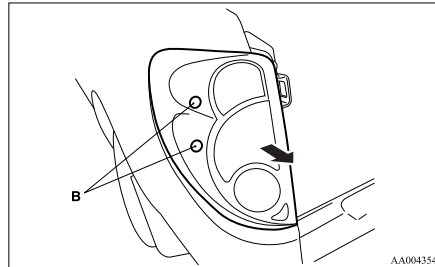

4. Remove each socket and bulb assembly by turning it anticlockwise.

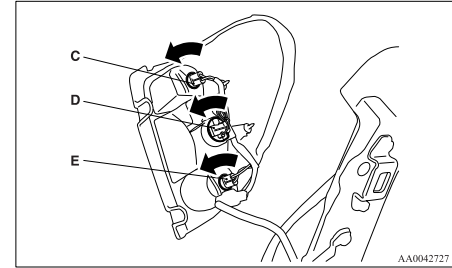

- C- Rear turn-signal lamp
Remove the bulb by pulling it out.
- D- Tail and stop lamp
Remove the bulb from the socket by turning it anticlockwise while pressing in.
- E- Reversing lamp
Remove the bulb by pulling it out.

5. To install the bulb, perform the removal steps in reverse.

NOTE

- When mounting the lamp unit, align the pins (F) and clip (G) on the lamp unit with the holes (H) in the body.

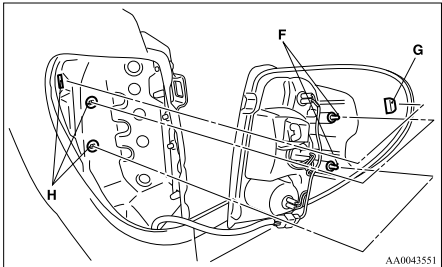

AA0043551

High-mounted stop lamp

E01004500577

1. Open the rear gate.
(Refer to "Rear gate" on page 1-13.)
2. Remove the 8 screws (A) from the inner surface of the rear gate. Remove the rear gate cover (B).

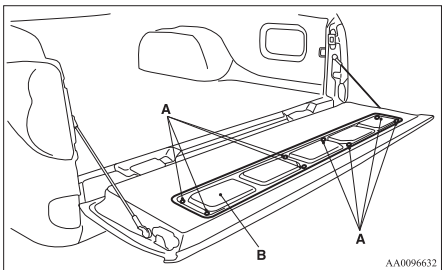

AA0096632

3. Remove the socket and bulb assembly together by turning it anticlockwise, and then remove the bulb by pulling it out.

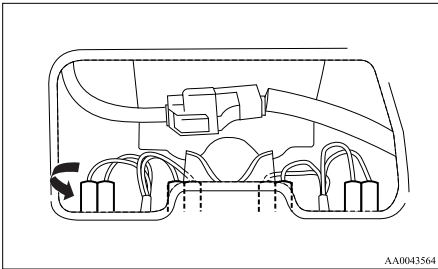

AA0043564

4. To install the bulb, perform the removal steps in reverse.

Licence plate lamps

E01004601025

1. Insert a straight blade (or minus) screwdriver into the lamp assembly and pry gently to remove it.

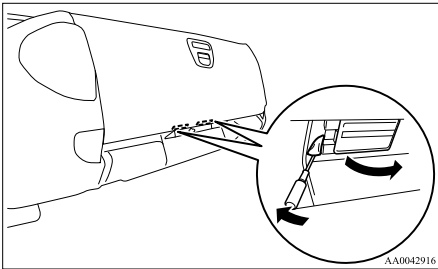

AA0042916

NOTE

- Wrap a piece of cloth around the tip of the screwdriver in order to avoid scratching the lens and the body.

2. Remove the socket and bulb assembly together by turning it anticlockwise, and then remove the bulb by pulling it out.

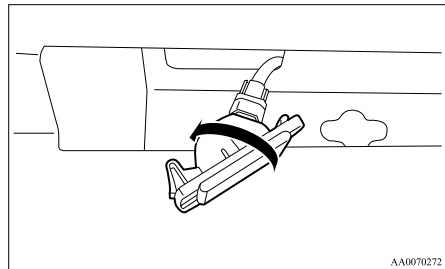

AA0070272

3. To install the bulb, perform the removal steps in reverse.

NOTE

- When mounting the lamp unit, put the hook (A) on the right side of the lamp unit into the body first.

Maintenance

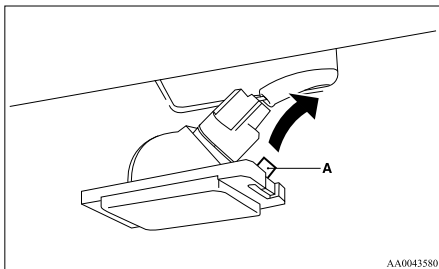

Front room lamp and personal lamps*

E01004700364

1. Insert a straight blade (or minus) screwdriver into the notch of the lens and pry gently to remove it.
Remove the bulb from the lamp holder.

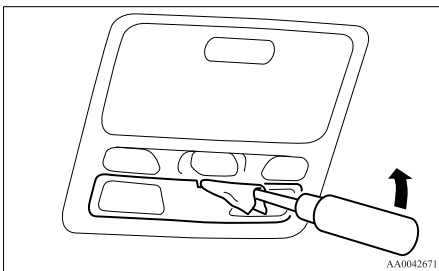

NOTE

- Wrap a piece of cloth around the tip of the screwdriver in order to avoid scratching the lens.
2. To install the bulb, perform the removal steps in reverse.

NOTE

- When installing the lens, align the 2 tabs on the lens with the holes on the vehicle side.

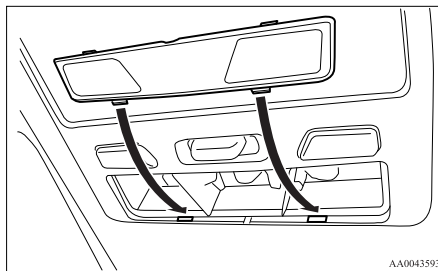

Rear room lamp*

E01004900119

Type 1

1. Insert a straight blade (or minus) screwdriver into the notch of the lens and pry gently to remove it. Remove the bulb from the lamp holder.

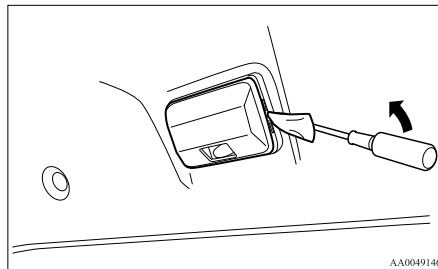

NOTE

- Wrap a piece of cloth around the tip of the screwdriver in order to avoid scratching the lens.
2. To install the bulb, perform the removal steps in reverse.

NOTE

- When installing the lens, fit the two tabs on one side of the lens into the holes on the vehicle side before fitting the two tabs on the opposite side of the lens into the holes on the vehicle side.

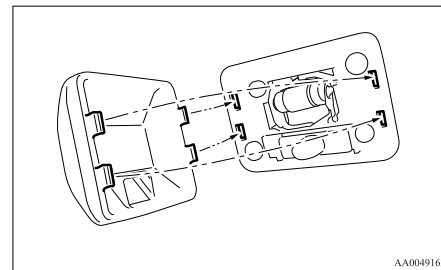

Type 2

1. Insert a straight blade (or minus) screwdriver into the notch of the lens and pry gently to remove it. Remove the bulb from the lamp holder.

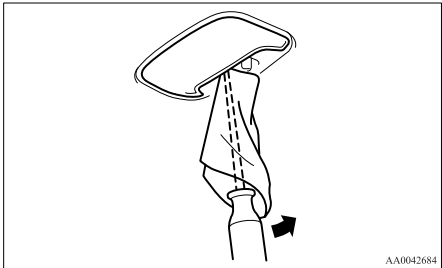

AA0042684

NOTE

- Wrap a piece of cloth around the tip of the screwdriver in order to avoid scratching the lens.

2. To install the bulb, perform the removal steps in reverse.

NOTE

- When installing the lens, align the 2 tabs on the lens with the holes on the vehicle side.

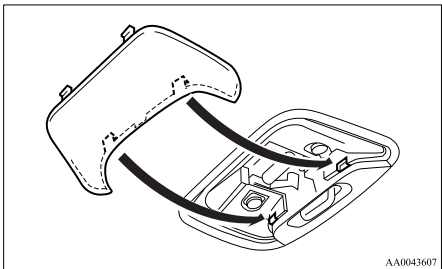

AA0043607

Door courtesy lamps*

E01005400238

1. Insert a straight blade (or minus) screwdriver into the lens and pry gently to remove it. Remove the bulb from the lamp holder.

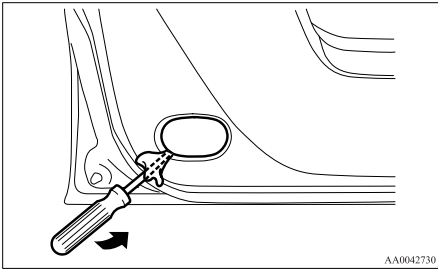

AA0042730

NOTE

- Wrap a piece of cloth around the tip of the screwdriver in order to avoid scratching the lens.

2. To install the bulb, perform the removal steps in reverse.

NOTE

- When installing the lens, align the 2 tabs on the lens with the holes on the vehicle side.

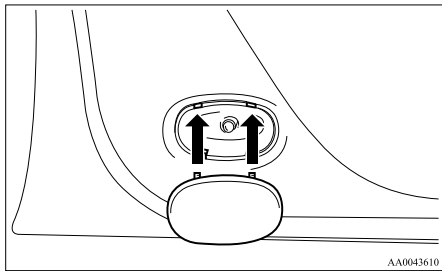

AA0043610

Glove box lamp

E01006100069

We recommend you to have the glove box lamp replaced by a specialist.

Centre console downlight

E01008700144

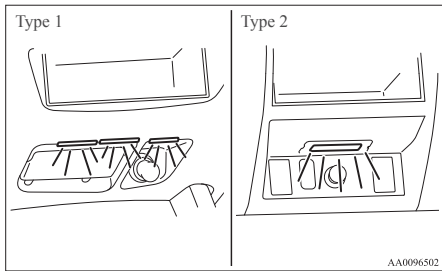

AA0096502

Maintenance

Type 1

We recommend you to have the centre console downlight replaced by a specialist.

Type 2

1. Insert a straight blade (or minus) screwdriver with a cloth over its tip at edge of the garnish (A) and pry gently to remove it.

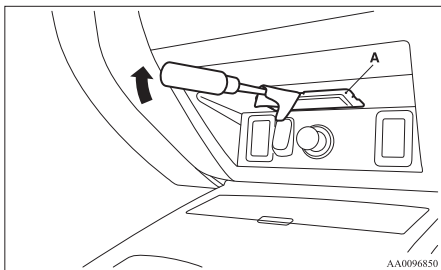

2. Turn the bulb socket (B) anticlockwise to remove it.

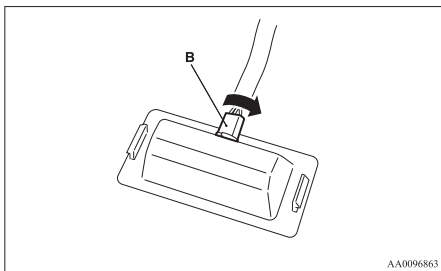

3. Remove the bulb by pulling out.

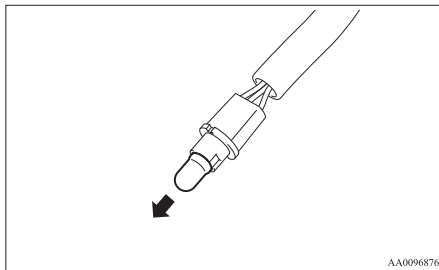

4. To install the bulb, perform the removal steps in reverse.

Specifications

Vehicle labeling.....	9-02
Vehicle dimensions.....	9-03
Vehicle performance.....	9-09
Vehicle weight.....	9-10
Engine specifications.....	9-14
Transmission specifications.....	9-15
Electrical system.....	9-16
Tyres and wheels.....	9-17
Other specifications.....	9-18
Fuel consumption.....	9-19
Refill capacities.....	9-21

Specifications

Vehicle labeling

E01100101791

Vehicle identification number

The vehicle identification number is stamped as shown in the illustration.

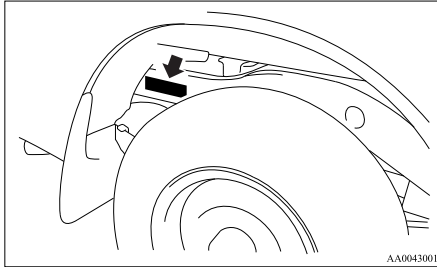

Vehicle information code plate

The vehicle information code plate is located as shown in the illustration.

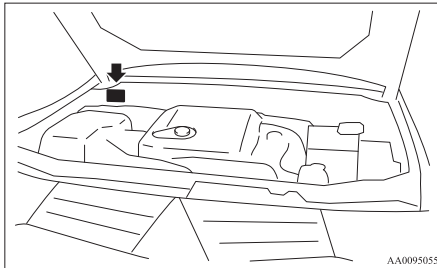

Please use this number when ordering replacement parts.

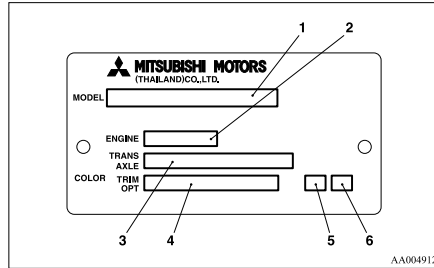

- 1- Model code
- 2- Engine model code
- 3- Transmission model code
- 4- Body colour code
- 5- Interior code
- 6- Option code

Vehicle identification number plate (RHD vehicles only)

The vehicle identification number is stamped on the plate riveted to the left front corner of the instrument panel pad. It is visible from outside of the vehicle through the windscreen.

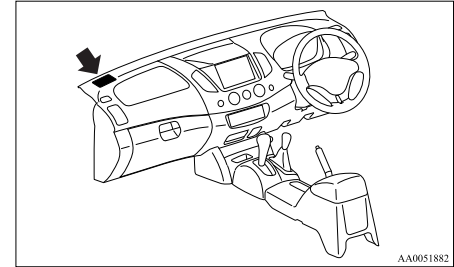

Engine number

The engine number is stamped on the engine cylinder block as shown in the illustration.

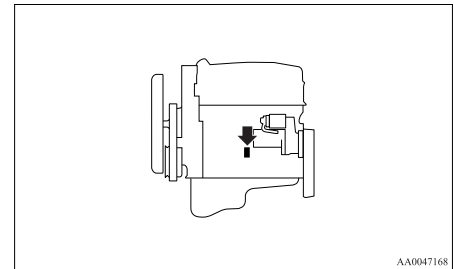

9 The plate shows model code and engine model, transmission model and body colour code, etc.

Vehicle dimensions

Single cab

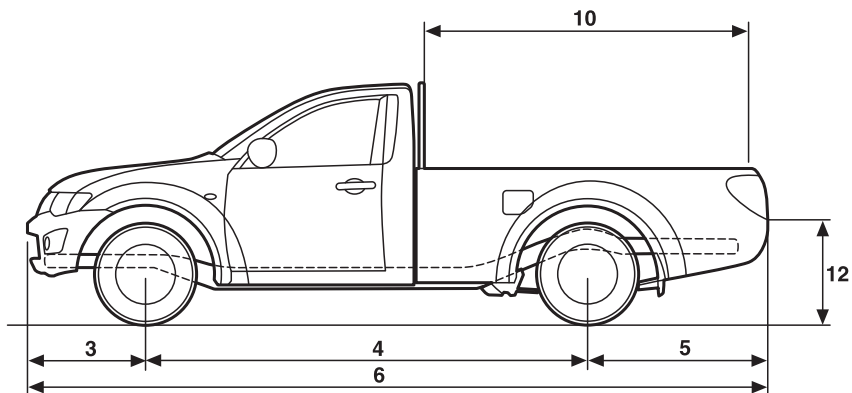
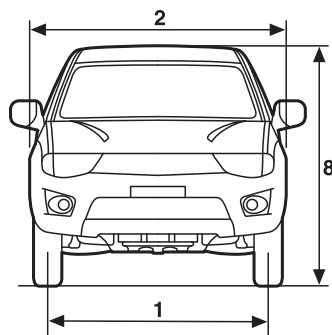
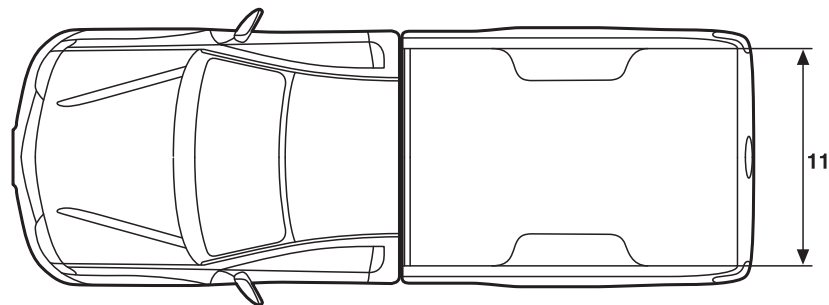
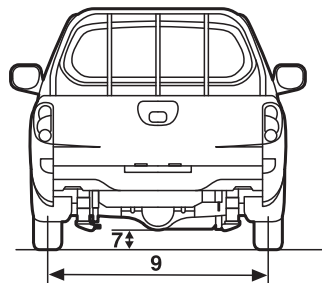

Specifications

Single cab

Item		2WD	4WD
1	Front track	1,505 mm	
2	Overall width	1,750 mm	
3	Front overhang	830 mm	
4	Wheel base	3,000 mm	
5	Rear overhang	1,210 mm	
6	Overall length	5,040 mm	
7	Ground clearance (unladen)	200 mm	
8	Overall height (unladen)	1,655 mm	1,775 mm
9	Rear track	1,500 mm	
10	Cargo bed length	2,220 mm	
11	Cargo bed width	1,470 mm	
12	Cargo bed height	715 mm	845 mm

Club cab

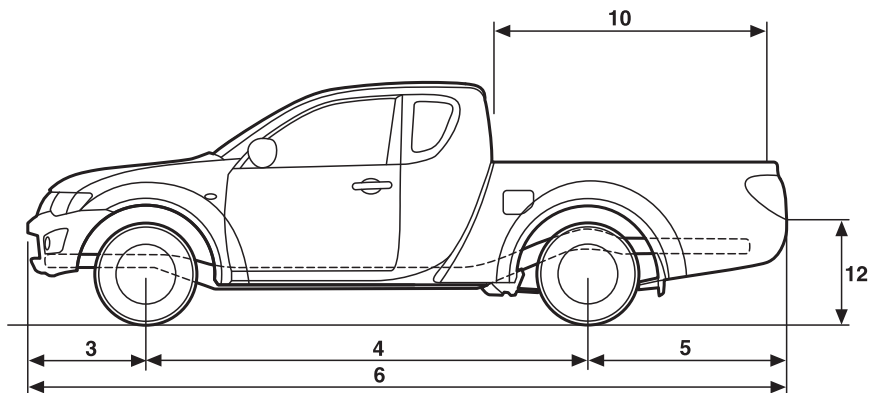
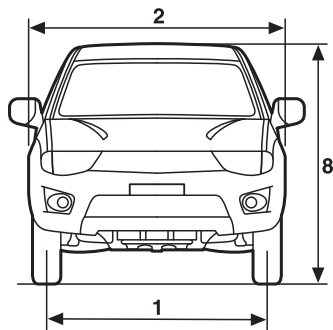
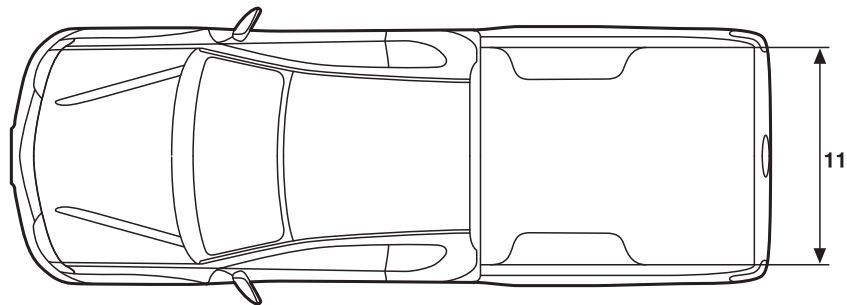
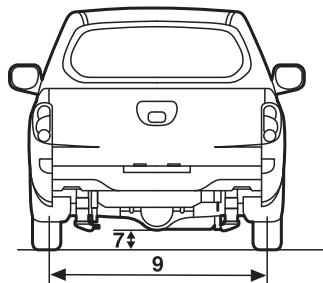

AA5010194

Specifications

Club cab

Item		Easy select 4WD	Super select 4WD
1	Front track	1,505 mm	1,520 mm
2	Overall width	1,750 mm	1,815 mm
3	Front overhang	795 mm	
4	Wheel base	3,000 mm	
5	Rear overhang	Without rear bumper	1,325 mm
		With rear bumper	1,400 mm
6	Overall length	Without rear bumper	5,120 mm
		With rear bumper	5,195 mm
7	Ground clearance (unladen)	200 mm	205 mm
8	Overall height (unladen)	1,775 mm, 1,790 mm* ¹	1,780 mm
9	Rear track	1,500 mm	1,515 mm
10	Cargo bed length	1,805 mm	
11	Cargo bed width	1,470 mm	
12	Cargo bed height	855 mm	860 mm

*1: Vehicles with rear guard frame

Double cab

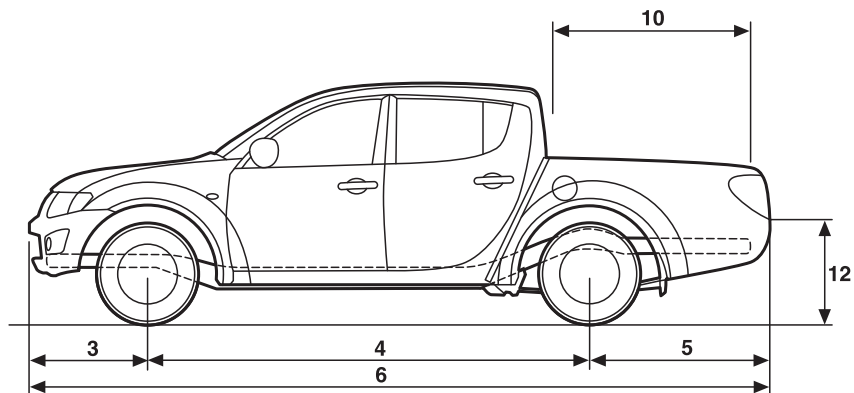
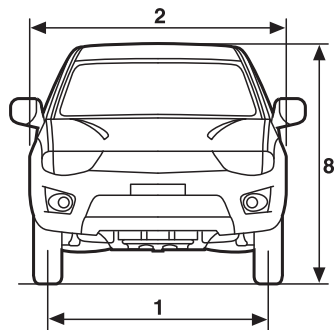
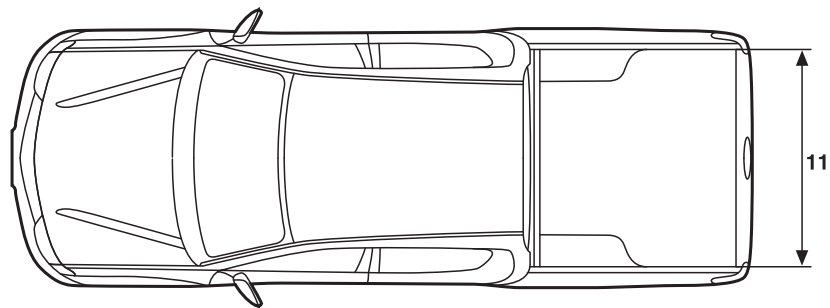
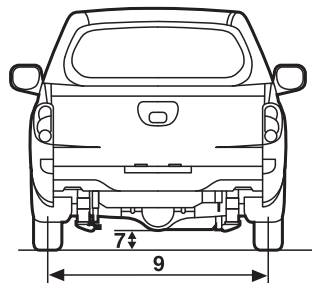

AA5010165

Specifications

Double cab

Item		2WD and Easy select 4WD	Super select 4WD
1	Front track	1,505 mm	1,520 mm
2	Overall width	1,750 mm	1,815 mm, 1,800 mm* ¹
3	Front overhang	795 mm, 830 mm* ¹ , * ²	
4	Wheel base	3,000 mm	
5	Rear overhang	Without rear bumper	1,210 mm, 1,390 mm* ³
		With rear bumper	1,285 mm, 1,465 mm* ³
6	Overall length	Without rear bumper	5,005 mm, 5,185 mm* ³ , 5,040 mm* ¹ , * ² , 5,220 mm* ⁴ , * ⁵
		With rear bumper	5,080 mm, 5,260 mm* ³ , 5,115 mm* ¹ , 5,295 mm* ⁴
7	Ground clearance (unladen)	200 mm	205 mm
8	Overall height (unladen)	1,775 mm, 1,655 mm* ²	1,780 mm
9	Rear track	1,500 mm	1,515 mm
10	Cargo bed length	1,325 mm, 1,505 mm* ³	
11	Cargo bed width	1,470 mm	
12	Cargo bed height	845 mm, 715 mm* ²	850 mm

*¹: Vehicles for Russia, Kazakhstan and Ukraine

*²: 2WD vehicles with 15 inch tyres

*³: Vehicles with long bed

*⁴: Vehicles for Russia, Kazakhstan and Ukraine with long bed

*⁵: 2WD vehicles with 15 inch tyres and long bed

Vehicle performance

E01100302442

Item		M/T	A/T
Maximum speed	Vehicles with standard power engine	167 km/h (104 mph), 164 km/h (102 mph)* ¹	166 km/h (102 mph), 165 km/h (102 mph)* ²
	Vehicles with high power engine	179 km/h (111 mph)	175 km/h (109 mph)
Minimum turning radius	Body	6.3 m, 6.1 m* ¹	
	Wheel	5.9 m, 5.7 m* ¹	

*¹: 2WD vehicles with 15 inch tyres

*²: Vehicles for Russia, Kazakhstan and Ukraine

Vehicle weight

E01100405848

Single cab

Item		2WD	4WD	
			LHD	RHD
Kerb weight	Without optional parts	1,560 kg	1,745 kg	
	With full optional parts	1,575 kg	1,805 kg	1,790 kg
Maximum gross vehicle weight		2,630 kg	2,850 kg	2,890 kg
Maximum axle weight	Front	1,030 kg	1,260 kg	
	Rear	1,700 kg	1,800 kg	
Maximum towable weight	With brake	1,800 kg	2,700 kg	
	Without brake	750 kg		
Maximum trailer-nose weight		77 kg	115 kg	
Maximum gross combination weight		4,400 kg	5,500 kg	5,540 kg
Maximum permissible weight of the coupling device		45 kg	45 kg ^{*1}	
Seating capacity (including a driver)		2 persons, 3 persons ^{*2}		

*1: Crossmember (weight = 10 kg) must be dismantled

*2: Vehicles equipped with bench seat

NOTE

- Trailer specifications indicate the manufacturer's recommendation.
- When loading luggage and/or towing a trailer, make sure not to exceed any of the above maximum weights all the time.

Club cab

Item		Easy select 4WD		Super select 4WD
		LHD	RHD	
Kerb weight	Without optional parts	1,800 kg		1,820 kg
	With full optional parts	1,900 kg	1,880 kg	1,910 kg
Maximum gross vehicle weight		2,850 kg		
Maximum axle weight	Front	1,260 kg		
	Rear	1,800 kg		
Maximum towable weight	With brake	2,700 kg		
	Without brake	750 kg		
Maximum trailer-nose weight		115 kg		
Maximum gross combination weight		5,500 kg		
Maximum permissible weight of the coupling device		45 kg*		
Seating capacity (including a driver)		4 persons		

*: Crossmember (weight = 10 kg) must be dismantled

NOTE

- Trailer specifications indicate the manufacturer’s recommendation.
- When loading luggage and/or towing a trailer, make sure not to exceed any of the above maximum weights all the time.

Specifications

Double cab

Item		2WD		
		M/T		A/T
		Vehicles with 15 inch tyres	Vehicles with 16 inch tyres	
Kerb weight	Without optional parts	1,650 kg	1,765 kg	1,775 kg
	With full optional parts	1,710 kg	1,890 kg	1,900 kg
Maximum gross vehicle weight		2,630 kg	2,800 kg	
Maximum axle weight	Front	1,030 kg	1,260 kg	
	Rear	1,700 kg	1,800 kg	
Maximum towable weight	With brake	1,800 kg	2,700 kg	
	Without brake	750 kg		
Maximum trailer-nose weight		75 kg	112 kg	
Maximum gross combination weight		4,400 kg	5,465 kg	
Maximum permissible weight of the coupling device		45 kg	45 kg*	
Seating capacity (including a driver)		5 persons		

*: Crossmember (weight = 10 kg) must be dismantled

NOTE

- Trailer specifications indicate the manufacturer's recommendation.
- When loading luggage and/or towing a trailer, make sure not to exceed any of the above maximum weights all the time.

Item		4WD						
		Easy select 4WD			Super select 4WD			
		M/T		A/T	M/T		A/T	
		LHD	RHD		LHD	RHD	LHD	RHD
Kerb weight	Without optional parts	1,870 kg, 1,835 kg * ¹	1,830 kg	1,860 kg	1,885 kg, 1,895 kg * ² , 1,875 kg * ¹	1,880 kg	1,910 kg, 1,895 kg * ¹	1,885 kg, 1,890 kg * ³
	With full optional parts	2,000 kg, 1,955 kg * ¹	1,960 kg	1,990 kg	2,030 kg, 2,000 kg * ¹	2,020 kg	2,030 kg, 2,010 kg * ¹	2,025 kg, 2,020 kg * ³
Maximum gross vehicle weight		2,850 kg	2,900 kg	2,850 kg		2,930 kg	2,850 kg	2,945 kg
Maximum axle weight		Front		1,260 kg				
		Rear		1,800 kg				
Maximum towable weight		With brake		2,700 kg				
		Without brake		750 kg				
Maximum trailer-nose weight		115 kg						
Maximum gross combination weight		5,500 kg	5,550 kg	5,500 kg		5,580 kg	5,500 kg	5,595 kg
Maximum permissible weight of the coupling device		45 kg * ⁴						
Seating capacity (including a driver)		5 persons						

*¹: Vehicles for Russia, Kazakhstan and Ukraine

*²: Vehicles with high power engine

*³: Vehicles for Singapore

*⁴: Crossmember (weight = 10 kg) must be dismantled

NOTE

- Trailer specifications indicate the manufacturer’s recommendation.
- When loading luggage and/or towing a trailer, make sure not to exceed any of the above maximum weights all the time.

Engine specifications

E01100602979

Item	Standard power engine		High power engine	
	2WD with 15 inch tyres	2WD with 16 inch tyres, 4WD	M/T	A/T
Engine type	Four-cylinder, in line, water cooled four-cycle, double overhead camshaft with small-sized intercooler and turbocharger	Four-cylinder, in line, water cooled four-cycle, double overhead camshaft with intercooler and turbocharger		
Engine models	4D56			
Total displacement	2,477 cc			
Bore	91.1 mm			
Stroke	95.0 mm			
Compression ratio	16.5:1, 17.0:1 *1		16.5:1	
Valve clearance	Intake	0.09 mm (cold)		
	Exhaust	0.14 mm (cold)		
Maximum output (EEC net)	94 kW/4,000 r/min	100 kW/4,000 r/min, 100 kW/3,500 r/min*2	131 kW/3,750 r/min	
Maximum torque (EEC net)	240 Nm/1,250 to 3,750 r/min	314 Nm/1,500 to 2,680 r/min, 314 Nm/2,000 r/min *2	400 Nm/2,000 to 2,850 r/min	350 Nm/1,800 to 3,500 r/min

*1: Vehicles to comply with the Euro 3 or Euro 4 regulation

*2: Vehicles for Russia, Kazakhstan and Ukraine

Transmission specifications

E01100701670

Item		M/T					A/T			
		2WD		4WD			2WD	4WD		
		Vehicles with 15 inch tyres	Vehicles with 16 inch tyres	Easy select 4WD	Super select 4WD			Easy select 4WD	Super select 4WD	
					High power engine	Standard power engine			4A/T	5A/T
Transmission	1 st gear ratio	4.313					2.842			3.789
	2 nd gear ratio	2.330					1.495			2.057
	3 rd gear ratio	1.436					1.000			1.421
	4 th gear ratio	1.000					0.731			1.000
	5 th gear ratio	0.788					—			0.731
	Reverse gear ratio	4.220					2.720			3.865
Transfer	High gear ratio	—		1.000			—	1.000		
	Low gear ratio	—		1.900			—	1.900		
Final gear ratio		3.909	3.917			3.917, 4.100*		3.917	4.100	3.917

*: Vehicles for Russia, Kazakhstan and Ukraine

Electrical system

E01100802391

Voltage		12 V	
Battery	Type (JIS)	95D31L	80D26L*
	Capacity (5HR)	64 Ah	55 Ah*
Alternator capacity	Vehicles for Russia, Kazakhstan, Ukraine, Morocco and Turkey	90 A	120 A*
	Except for vehicles for Russia, Kazakhstan, Ukraine, Morocco and Turkey	95 A	130 A*

*: Optional equipment

Tyres and wheels

E01100902204

Tyre		195R15C 106/104R 8PR, 215/70R15C 109/107R*	205/80R16 104S RF, 205R16C 110/108R 8PR	245/70R16 111S RF	245/65R17 111S RF
Wheel	Size	15x6JJ	16x6JJ	16x7J	17x7 1/2J
	Offset	46 mm		38 mm	

*: On vehicles with 195 size tyres, this size of snow tyres can also be used instead.

NOTE

- Contact your MITSUBISHI MOTORS Authorized Service Point for details on the combination used on your vehicle.

Other specifications

E01101000862

Fuel system	Fuel control		Direct injection common rail system
	Fuel pump		Electronic controlled rotary type
Clutch			Dry single disc clutch with diaphragm spring, hydraulic action
Steering system			Rack & pinion type, power assisted
Suspension	Front		Independent type, wishbone, coil spring
	Rear		Rigid type, leaf spring
Service brakes	Type	Vehicles without ABS	Hydraulic, front and rear split double circuit system with power assistance
		Vehicles with ABS	Hydraulic, diagonal split double circuit system with power assistance
	Front		Ventilated disc brakes
	Rear		Drum brakes
Parking brakes			Parking brake acts mechanically on rear wheels

Fuel consumption

E01101100821

Item			Combined		Urban conditions	Extra-urban conditions		
			CO ₂ (g/km)	Fuel consumption (L/100 km)	Fuel consumption (L/100 km)	Fuel consumption (L/100 km)		
Single cab	2WD			190	7.2	9.1	6.1	
	4WD	Standard		195	7.4	8.7	6.7	
		Full option		199	7.5	8.9	6.8	
Club cab			Standard		199	7.5	8.9	6.8
			Full option		204	7.7	9.1	7.0
Double cab	2WD with 15 inch tyres		Standard		190	7.2	9.1	6.1
			Full option		194	7.4	9.2	6.3
	2WD with 16 inch tyres	M/T	Standard		195	7.4	8.7	6.7
			Full option		204	7.7	9.1	7.0
		A/T	Standard		222	8.4	10.2	7.4
			Full option		227	8.6	10.5	7.6
	4WD	M/T	Standard		199, 204*	7.5, 7.7*	8.9, 9.1*	6.8, 7.0*
			Full option		208	7.9	9.2	7.2
		A/T	Standard		222, 225*	8.4, 8.5*	10.2	7.4, 7.6*
			Full option		234, 233*	8.9, 8.8*	10.8, 10.6*	7.8, 7.9*

*: Vehicles with wide fender

Specifications

NOTE

- The results given do not express or imply any guarantee of the fuel consumption of the particular vehicle. The vehicle itself has not been tested and there are inevitably differences between individual vehicles of the same model. In addition, this vehicle may incorporate particular modifications. Furthermore, the driver's style and road and traffic conditions, as well as the extent to which the vehicle has been driven and the standard of maintenance, will all affect its fuel consumption.

Refill capacities

E01101304687

LHD

M/T

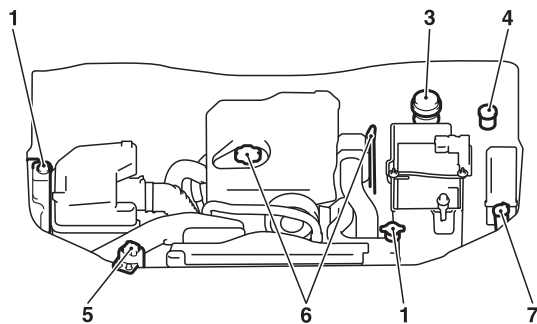

A/T

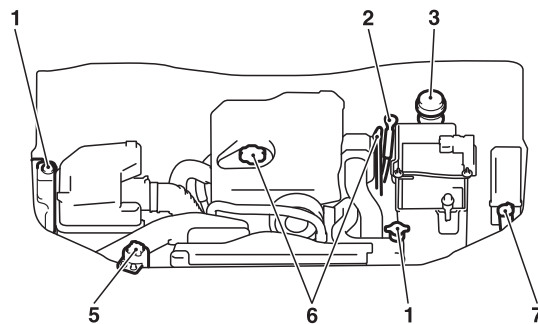

RHD

M/T

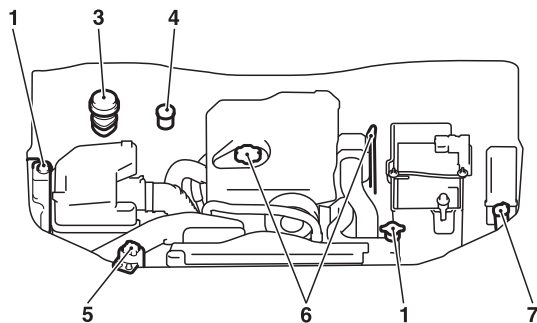

A/T

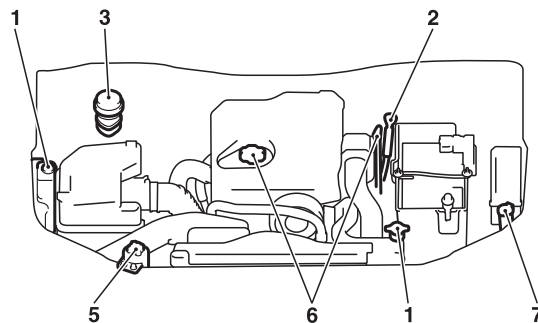

AA5004072

Specifications

No.	Item		Quantity	Lubricants	
1	Engine coolant		8.2 litres [includes 0.65 litre in the reserve tank]	MITSUBISHI MOTORS GENUINE SUPER LONG LIFE COOLANT or equivalent	
2	Automatic transmission fluid		9.7 litres	MITSUBISHI MOTORS GENUINE ATF SP III	
3	Brake fluid		As required	Brake fluid DOT3 or DOT4	
4	Clutch fluid		As required	Brake fluid DOT3 or DOT4	
5	Power steering fluid		As required	MITSUBISHI MOTORS GENUINE PSF (Power Steering Fluid)	
6	Engine oil	Oil pan	2WD with 15 inch tyres	6.5 litres	Refer to page 8-04.
			2WD with 16 inch tyres, 4WD	5.5 litres	
		Oil filter	0.8 litre		
		Oil cooler	0.1 litre		
7	Washer fluid		4.8 litres, 4.5 litres* ¹	—	
8	Manual transmission oil	2WD	2.3 litres	MITSUBISHI MOTORS GENUINE MTF API classification GL-3 SAE 75W-85	
		4WD	3.4 litres		
9	Transfer oil		2.5 litres	MITSUBISHI MOTORS GENUINE MTF API classification GL-3 SAE 75W-85 or MITSUBISHI MOTORS GENUINE Multi Gear Oil API classification GL-4 SAE 75W-85	

*1: Vehicles with “front (Type 1)” (Refer to “Outside” on page 8-24)

*2: 4WD vehicles only

*3: Double cab with capacity up air conditioning

No.	Item			Quantity	Lubricants	
10	Differential oil	Front*2		1.2 litres	MITSUBISHI MOTORS GENUINE Super Hypoid Rear Gear Oil API classification GL-5 SAE 80	
		Rear	Standard power engine	2WD with 15 inch tyres		1.5 litres
				2WD with 16 inch tyres, 4WD		2.1 litres
			High power engine			
11	Refrigerant (air conditioning)			480-520 g, 535-575 g*3	HFC-134a	

*1: Vehicles with “front (Type 1)” (Refer to “Outside” on page 8-24)

*2: 4WD vehicles only

*3: Double cab with capacity up air conditioning

A series of 15 horizontal dashed lines spanning the width of the page, providing a template for handwriting practice.

4

4-wheel drive operation 4-34

A

Accessory (Installation) 04
 Accessory socket 5-73
 Active Stability & Traction Control (ASTC) 4-42
 Additional equipment 8-19
 Air conditioning
 Automatic air conditioning 5-08
 Important operation tips for the air conditioning 5-12
 Manual air conditioning 5-03
 Air purifier 5-12
 Airbag 2-26
 Antenna 5-51
 Anti-lock brake system (ABS) 4-39
 Warning lamp 4-40
 Armrest (Double cab) 2-07
 Ashtray 5-71
 Audio
 Audio system anti-theft feature 5-49
 Error codes 5-43
 Handling of compact discs 5-49
 LW/MW/FM electronic tuning radio with CD player 5-13
 Steering wheel remote control switch 5-41
 Automatic air conditioning 5-08
 Automatic transmission Sports Mode 4A/T, 5A/T 4-17
 Fluid 8-07,9-21
 Selector lever operation 4-17
 Selector lever position indicator 4-18
 Selector lever positions 4-18
 Sports mode 4-19
 Sports mode indicator 4-19

B

Battery 8-10
 Discharged battery (Emergency starting) 6-02
 Specification 9-16
 Bleeding the fuel system 6-05
 Bluetooth® 2.0 interface 5-52
 Bonnet 8-03
 Bottle holder 5-80
 Brake
 Anti-lock brake 4-39
 Brake assist system 4-39
 Braking 4-38
 Fluid 8-08,9-21
 Parking brake 4-06
 Parking brake lever stroke 8-16
 Pedal free play 8-16
 Warning lamp 3-08

C

Cargo loads 4-49
 Catalytic converter 8-02
 Cautions on handling of 4-wheel drive vehicles 4-36
 Central door locks 1-07
 Centre console downlight 5-76
 Bulb capacity 8-24
 Replacement 8-34
 Centre information display 3-10
 Changing a fuse 8-22
 Changing gears 4-15
 Check engine warning lamp 3-08
 Child restraint 2-13
 Child-protection rear doors 1-08
 Cigarette lighter 5-72
 Cleaning
 Exterior of your vehicle 7-03

Genuine leather 7-02
 Interior of your vehicle 7-02
 Plastic, vinyl leather, etc 7-02
 Sunroof 7-05
 Waxing 7-04
 Clock 3-19,5-74
 Clutch
 Fluid 8-09,9-21
 Pedal free play 8-15
 Coat hook 5-81
 Combination headlamps and dipper switch 3-30
 Convenient hook 5-80
 Coolant (engine) 8-06,9-21
 Cruise control 4-45
 Switch 4-45
 Cup holder 5-79
 Curtain airbag system 2-34

D

Demister (rear window) 3-39
 Diesel particulate filter (DPF) 4-13
 Differential oil 9-21
 Digital clock 3-19,5-74
 Dimensions 9-03
 Dipper (High/Low beam change) 3-31
 Door courtesy lamps 5-76
 Replacement 8-33
 Doors
 Central door locks 1-07
 Child-protection 1-08
 Lock and unlock 1-06
 Driving, alcohol and drugs 4-02

E

Easy select 4WD 4-22
 Economical driving 4-02
 Electric window control 1-08

Alphabetical index

Switch 1-08
 Electrical system 9-16
 Electronic immobilizer (Anti-theft starting system) 1-03
 Emergency starting 6-02
 Engine specifications 9-14
 Engine
Coolant 8-06,9-21
Number 9-02
Oil 8-04,9-21
Overheating 6-04
Specifications 9-14
Used engine oils safety instructions and disposal information 05
Water temperature gauge 3-05
 Error codes 5-43
 Exterior and interior lamp operation 8-18

F

First-aid kit and warning triangle band for securing 5-81
Floor console box 5-77
Fluid
Automatic transmission fluid 8-07,9-21
Brake fluid 8-08,9-21
Clutch fluid 8-09,9-21
Engine coolant 8-06,9-21
Power steering fluid 8-09,9-21
Washer fluid 8-08,9-21
 For cold and snowy weather 8-19
 Front console box 5-77
 Front fog lamps
Bulb capacity 8-24
Indication lamp 3-07
Replacement 8-28
Switch 3-34
 Front room lamp
Bulb capacity 8-25

Replacement 8-32
 Front seat 2-03
 Front turn-signal lamps
Bulb capacity 8-24
Replacement 8-27
 Fuel consumption 9-19
 Fuel
Filling the fuel tank 02
Fuel filter indication lamp 3-07
Fuel gauge 3-04
Fuel selection 02
Low fuel warning lamp 3-04
Modification/alterations to the electrical or fuel systems 04
Tank capacity 02
 Fuses 8-20
 Fusible links 8-19

G

Gauges 3-02
General maintenance 8-18
General vehicle data 9-03
Genuine parts 05
Glove box 5-77
Glove box lamp
Bulb capacity 8-24
Replacement 8-33

H

Handling of compact discs 5-49
Hazard warning flasher switch 3-34
Hazard warning indication lamps 3-07
Head restraints 2-08
Headlamp levelling switch 3-32
Headlamps
Bulb capacity 8-24
Headlamp flasher 3-31

Replacement 8-25
Switch 3-30
Washer switch 3-39
 Heated mirror 4-10
 Heated seats 2-06
 Heater 5-03
 High-mounted stop lamp
Bulb capacity 8-24
Replacement 8-31
 Hinges and latches lubrication 8-19
 Hooks
Coat hook 5-81
Convenient hook 5-81
Horn switch 3-40

I

If the vehicle breaks down 6-02
Ignition switch 4-10
Indication and warning lamps 3-06
Indication lamps 3-07
Inside rear-view mirror 4-08
Inspection and maintenance following rough road operation 4-36
Installation of accessories 04
Instruments 3-02
Interior lamps 5-74

J

Jack handle 6-12
Storage 6-07
Jacking up the vehicle 6-13
Jack
Storage 6-07
Jump starting (Emergency starting) 6-02

K

Keyless entry system 1-04
 Keys 1-02

L

Labeling 9-02
 Lamp monitor buzzer 3-31
 Lamps (headlamps, fog lamp, etc.) auto-cutout function 3-31
 Leakage (Fuel, engine coolant, oil and exhaust gas) 8-18
 Licence plate lamps
 Bulb capacity 8-24
 Replacement 8-31
 Limited-slip differential (LSD) 4-38
 Link System 5-52
 Low fuel warning lamp 3-04
 Lubricants 9-21
 LW/MW/FM electronic tuning radio with CD player 5-13

M

Manual transmission 4-14
 Oil 9-21
 Manual window control 1-08
 Mirror
 Inside rear-view mirror 4-08
 Outside rear-view mirrors 4-09
 Vanity mirror 5-71
 Modification/alterations to the electrical or fuel systems 04

O

Odometer 3-03

Oil
 Differential oil 9-21
 Engine oil 8-04,9-21
 Manual transmission fluid 9-21
 Transfer oil 9-21
 Operation under adverse driving conditions 6-24
 Other specifications 9-18
 Outside rear-view mirrors 4-09
 Overheating 6-04

P

Parking 4-07
 Parking brake 4-06
 Parking brake lever stroke 8-16
 Personal lamps 5-75
 Replacement 8-32
 Position lamps
 Bulb capacity 8-24
 Replacement 8-27
 Power steering
 Fluid 8-09,9-21
 System 4-42
 Precautions to observe when using wipers and washers 3-39
 Pregnant women restraint 2-12
 Puncture (Tyre changing) 6-17

R

Radio
 LW/MW/FM electronic tuning radio with CD player 5-13
 Rear combination lamps
 Bulb capacity 8-24
 Replacement 8-30
 Rear differential lock 4-30
 Rear fog lamp
 Bulb capacity 8-24

Indication lamp 3-07
 Replacement 8-29
 Switch 3-35
 Rear room lamp 5-74
 Bulb capacity 8-25
 Replacement 8-32
 Rear seat 2-07
 Rear side/quarter window 1-12
 Rear turn-signal lamps
 Bulb capacity 8-24
 Replacement 8-30
 Rear window demister switch 3-39
 Rear-view mirror
 Inside 4-08
 Outside 4-09
 Refill capacities 9-21
 Removal of water from the fuel filter 6-06
 Replacement of lamp bulbs 8-23
 Reversing lamps
 Bulb capacity 8-24
 Replacement 8-30
 Room lamp 5-74,5-75
 Running-in recommendations 4-04

S

Safe driving techniques 4-03
 Seat belt 2-09
 Adjustable seat belt anchor 2-11
 Child restraint 2-13
 Inspection 2-26
 Pregnant women restraint 2-12
 Pretensioner 2-12
 Seat belt reminder/warning lamp 2-11
 Seat
 Adjustment 2-03
 Armrest (Double cab) 2-07
 Front seat 2-03
 Head restraints 2-08

Alphabetical index

Heated seats 2-06
Rear seat 2-07
 Secret box 5-78
 Service precaution 8-02
 Side airbag system 2-34
 Side turn-signal lamps
Bulb capacity 8-24
Replacement 8-28
 Snow tyres 8-14
 Spare wheel 6-16
 Spark plug 9-16
 Specifications 9-02
 Speedometer 3-03
 Starting 4-12
 Steering
Power steering fluid 8-09,9-21
Power steering system 4-42
Steering wheel height adjustment 4-08
Steering wheel lock 4-12
Steering wheel remote control switch 5-41
 Stop lamps
Bulb capacity 8-23
Replacement 8-30
 Storage spaces 5-76
 Sun visors 5-70
 Sunglasses holder 5-78
 Sunroof 1-13
Safety mechanism 1-14
Sunshade 1-14
Switch 1-13
 Super select 4WD 4-26
 Supplemental restraint system 2-26
How the Supplemental Restraint System works 2-28
Servicing 2-38
Warning lamp 2-37

T

Tachometer 3-03
Tail lamps
 Bulb capacity 8-24
 Replacement 8-30
 Tank capacity 02
 Ticket holder 5-70
 Tools 6-09
Storage 6-07
Towing 6-20
 Trailer towing 4-49
 Transfer oil 9-21
 Transmission
Automatic transmission Sports Mode 4A/T, 5A/
T 4-17
Fluid 8-07,9-21
Manual transmission 4-14
Specifications 9-15
 Tripmeter 3-03
 Turn-signal indication lamps 3-07
 Turn-signals lever 3-33
 Tyres 8-11
How to change a tyre 6-17
Inflation pressures 8-12
Rotation 8-13
Size (tyre and wheel) 9-17
Snow tyres 8-14
Tyre chains 8-14
Wheel condition 8-13

U

USB input terminal 5-68
How to connect an iPod 5-68
 USB input terminal
How to connect a USB memory device 5-68

Used engine oils safety instructions and disposal information 05
Utility box 5-78

V

Vanity mirror 5-71
Vehicle care precautions 7-02
Vehicle dimensions 9-03
Vehicle identification number 9-02
Vehicle identification number plate 9-02
Vehicle information code plate 9-02
Vehicle labeling 9-02
Vehicle performance 9-09
Vehicle weight 9-10
Ventilators 5-02

W

Warning lamps 3-08
Washer
Fluid 8-08,9-21
Switch 3-36,3-39
Washing 7-03
Water temperature gauge 3-05
Waxing 7-04
Weatherstripping 8-19
Weight 9-10
Wheel condition 8-13
Wheel
Specification 9-17
Wiper
Switch 3-36
Wiper blade rubber replacement 8-17
Wiper blades 8-17

EC-Declaration of Conformity

Manufacturer / responsible person Johnson Controls Interior Experience
Address: 915 E. 32nd Street
Holland Michigan USA 49423

Declares that the product:
type: BlueTooth Hands Free for Automotive
model: 1872669_1872721
intended use/: Hands Free cellphone interface to vehicle audio system

complies with the essential requirements of Article 3 of the R&TTE 1999/5/EC Directive, if used as intended and that the following standards has been applied:

- 1 Safety (Article 3.1.a of the R&TTE Directive)
applied standard(s) EN 60 950-1 issue 2001
+ A 11 issue 2004
EN 50371 issue 2008
- 2 Electromagnetic compatibility (Article 3.1.b of the R&TTE Directive)
applied standard(s) ETSI EN 301 489-1 V1.6.1 issue 2005-09
ETSI EN 301 489-17 V1.2.1 issue 2002-08
- 3 Efficient use of the radio frequency spectrum (Article 3.2 of the R&TTE Directive)
applied standard(s) ETSI EN 300 328 V1.7.1 issue 2006-10

Holland, MI USA 8/30/2009
(Place and date of the declaration of conformity)

John D. Spencer
(Name and signature)

Česky [Czech]:	Toto zařízení je v souladu se základními požadavky a ostatními odpovídajícími ustanoveními Směrnice 1999/5/EC.
Dansk [Danish]:	Deette udstyr er i overensstemmelse med de væsentlige krav og andre relevante bestemmelser i Direktiv 1999/5/EF.
Deutsch [German]:	Dieses Gerät entspricht den grundlegenden Anforderungen und den weiteren einschließenden Vorgaben der Richtlinie 1999/5/EU.
Eesti [Estonian]:	See seade vastab direktiivi 1999/5/EÜ olulistele nõuetele ja teistele asjakohastele sätetele.
English:	This equipment is in compliance with the essential requirements and other relevant provisions of Directive 1999/5/EC.
Español [Spanish]:	Este equipo cumple con los requisitos esenciales así como con otras disposiciones de la Directiva 1999/5/CE.
Ελληνική [Greek]:	Αυτός ο εξοπλισμός είναι σε συμμόρφωση με τις ορισώδεις απαιτήσεις και άλλες σχετικές διατάξεις της Οδηγίας 1999/5/ΕΚ.
Français [French]:	Cet appareil est conforme aux exigences essentielles et aux autres dispositions pertinentes de la Directive 1999/5/EC.
Íslenska [Icelandic]:	Þetta tæki er samkvæmt grunnkröfum og öðrum viðeigandi ákvæðum Tilskipunar 1999/5/EC.
Italiano [Italian]:	Questo apparato è conforme ai requisiti essenziali ed agli altri principi sanciti dalla Direttiva 1999/5/CE.
Latviski [Latvian]:	Šī iekārta atbilst Direktīvas 1999/5/EK būtiskajām prasībām un citiem ar to saistītajiem noteikumiem.
Lietuvių [Lithuanian]:	Šis įrenginys tenkina 1999/5/EB Direktyvos esminius reikalavimus ir kitas šios direktyvos nuostatas.
Nederlands [Dutch]:	Dit apparaat voldoet aan de essentiële eisen en andere van toepassing zijnde bepalingen van de Richtlijn 1999/5/EC.
Malti [Maltese]:	Dan l-apparat huwa konformi mal-hiġriet essenzjali u l-provedimenti l-oħra rilevanti tad-Direttiva 1999/5/EC.
Magyar [Hungarian]:	Ez a készülék teljesíti az alappelv követelményeket és más 1999/5/EK irányelvben meghatározott vonatkozó rendelkezéseket.
Norsk [Norwegian]:	Deette utstyret er i samsvar med de grunnleggende krav og andre relevante bestemmelser i EU-direktiv 1999/5/EF.
Polski [Polish]:	Urządzenie jest zgodne z ogólnymi wymaganiami oraz szczegółowymi warunkami określonymi Dyrektywą UE: 1999/5/EC.
Português [Portuguese]:	Este equipamento está em conformidade com os requisitos essenciais e outras provisões relevantes da Directiva 1999/5/EC.
Slovensko [Slovenian]:	Ta naprava je skladna z bistvenimi zahtevami in ostalimi relevantnimi pogoji Direktive 1999/5/EC.
Slovensky [Slovak]:	Toto zariadenie je v zhode so základnými požiadavkami a inými príslušnými nariadeniami direktivy 1999/5/EC.
Suomi [Finnish]:	Tämä laite täyttää direktiivin 1999/5/EY olennaiset vaatimukset ja on siinä asetettujen muiden laitteita koskevien määräysten mukainen.
Svenska [Swedish]:	Denna utrustning är i överensstämmelse med de väsentliga kraven och andra relevanta bestämmelser i Direktiv 1999/5/EC.

OMRON

OMRON Corporation

6368 NENJO-ZAKA, OKUSA, KOMAKI-CITY,

AICHI 485-0802 JAPAN

PHONE: +81-568-78-6159

FAX : +81-568-78-7659

DECLARATION of CONFORMITY

We, **OMRON Corporation, AUTOMOTIVE ELECTRONIC COMPONENTS COMPANY** hereby declare, at our sole responsibility, that the following product conforms to the Essential Requirements of the Radio and Telecommunications Terminal Equipment Directive 1999/5/EC in accordance with the tests conducted to the appropriate requirements of the relevant standards, as listed herewith.

Product : **Keyless Entry System for vehicle**

Model/ Type Number : **G8C-930M, G8C-931M, G8C-932M for receiver and immobilizer**
: **G8D-571M-A for transmitter**

Directive and Standards used as appropriate: **Radio** : EN 300 220-1 V2.1.1

EN 300 220-2 V2.1.2

EN 300 330-1 V1.3.2 *1

EN 300 330-2 V1.3.1 *1

EMC : EN 301 489-1 V1.8.1 *2

EN 301 489-1 V1.6.1 *3

EN 301 489-3 V1.4.1

Safety : EN 60065:2002+Amd.1:2006+Amd.11:2008 *2

EN 60065:2002+Amd.1:2006 *3

*1 except G8C-931M *2 except G8D-571M-A *3 only G8D-571M-A

Year of affixing CE marking : **2010**

Signature

: *Fumio Hayashi*

Name

: Fumio Hayashi

Title and position

: Manager
DEVELOPMENT STRATEGY DEPT.
DEVELOPMENT & DESIGN DIV.

Date

: March 24, 2010

CE 1731

[Czech]	OMRON Corporation tímto prohlašuje, že tento [G8D-407M-A* G8D-410M-B*, G8D-520M-A* G8C-500M*, G8D-581M-B*, G8D-571M-A* G8D-518M-A* G8C-507M*, G8C-223M-3C, G8C-541M*, G8D-621M-A*, G8C-519M*, G8C-518M*, G8C-527M*, G8C-546M*, G8C-930M*, G8C-931M*, G9C-932M*] je ve shodě se základními požadavky a dalšími příslušnými ustanoveními směrnice 1999/5/EC.
[Danish]	Undertegnede OMRON Corporation erklærer herved, at følgende udstyr [G8D-407M-A* G8D-410M-B*, G8D-520M-A*, G8C-500M*, G8D-581M-B*, G8D-571M-A* G8D-518M-A* G8C-507M*, G8C-546M*, G8C-930M*, G8C-931M*, G9C-932M*] overholder de væsentlige krav og øvrige relevante krav i direktiv 1999/5/EF.
[German]	Hiermit erklärt OMRON Corporation, dass sich das Gerät [G8D-407M-A* G8D-410M-B*, G8D-520M-A* G8C-500M*, G8D-581M-B*, G8D-571M-A* G8D-518M-A* G8C-507M*, G8C-223M-3C, G8C-541M*, G8D-621M-A*, G8C-519M*, G8C-518M*, G8C-527M*, G8C-546M*, G8C-930M*, G8C-931M*, G9C-932M*] in Übereinstimmung mit den grundlegenden Anforderungen und den übrigen einschlägigen Bestimmungen der Richtlinie 1999/5/EG befindet.
[Estonian]	Käesolevaga kinnitab OMRON Corporation seadme [G8D-407M-A* G8D-410M-B*, G8D-520M-A* G8C-500M*, G8D-581M-B*, G8D-571M-A* G8D-518M-A* G8C-507M*, G8C-223M-3C, G8C-541M*, G8D-621M-A* G8C-519M*, G8C-518M*, G8C-527M*, G8C-546M*, G8C-930M*, G8C-931M*, G9C-932M*] vastavust direktiivi 1999/5/EÜ põhinõuetele ja nimetatud direktiivist tulenevatele teistele asjakohastele sätetele.
[English]	Hereby, OMRON Corporation, declares that this [G8D-407M-A* G8D-410M-B*, G8D-520M-A* G8C-500M*, G8D-581M-B*, G8D-571M-A* G8D-518M-A* G8C-507M*, G8C-223M-3C, G8C-541M*, G8D-621M-A* G8C-519M*, G8C-518M*, G8C-527M*, G8C-546M*, G8C-930M*, G8C-931M*, G9C-932M*] is in compliance with the essential requirements and other relevant provisions of Directive 1999/5/EC.
[Spanish]	Por medio de la presente OMRON Corporation declara que el [G8D-407M-A* G8D-410M-B*, G8D-520M-A* G8C-500M*, G8D-581M-B*, G8D-571M-A* G8D-518M-A* G8C-507M*, G8C-223M-3C, G8C-541M*, G8D-621M-A* G8C-519M*, G8C-518M*, G8C-527M*, G8C-546M*, G8C-930M*, G8C-931M*, G9C-932M*] cumple con los requisitos esenciales y cualesquiera otras disposiciones aplicables o exigibles de la Directiva 1999/5/CE.
[Greek]	ΜΕ ΤΗΝ ΠΑΡΟΥΣΑ ΟΜΡΟΝ Corporation δηλώνει ότι [G8D-407M-A* G8D-410M-B*, G8D-520M-A* G8C-500M*, G8D-581M-B*, G8D-571M-A* G8D-518M-A* G8C-507M*, G8C-223M-3C, G8C-541M*, G8D-621M-A* G8C-519M*, G8C-518M*, G8C-527M*, G8C-546M*, G8C-930M*, G8C-931M*, G9C-932M*] ΕΥΜΜΟΡΦΟΝΕΤΑΙ ΠΡΟΣ ΤΙΣ ΟΥΣΙΩΔΕΙΣ ΑΠΑΙΤΗΣΕΙΣ ΚΑΙ ΤΙΣ ΑΠΗΡΕΣ ΣΥΝΤΗΚΕΣ ΔΙΑΤΑΞΕΙΣ ΤΗΣ ΟΑΗΤΑΣ 1999/5/ΕΚ.
[French]	Par la présente OMRON Corporation déclare que l'appareil [G8D-407M-A* G8D-410M-B*, G8D-520M-A* G8C-500M*, G8D-581M-B*, G8D-571M-A* G8D-518M-A* G8C-507M*, G8C-223M-3C, G8C-541M*, G8D-621M-A* G8C-519M*, G8C-518M*, G8C-527M*, G8C-546M*, G8C-930M*, G8C-931M*, G9C-932M*] est conforme aux exigences essentielles et aux autres dispositions pertinentes de la directive 1999/5/CE.
[Italian]	Con la presente OMRON Corporation dichiara che questo [G8D-407M-A* G8D-410M-B*, G8D-520M-A* G8C-500M*, G8D-581M-B*, G8D-571M-A* G8D-518M-A* G8C-507M*, G8C-223M-3C, G8C-541M*, G8D-621M-A* G8C-519M*, G8C-518M*, G8C-527M*, G8C-546M*, G8C-930M*, G8C-931M*, G9C-932M*] è conforme ai requisiti essenziali ed alle altre disposizioni pertinenti stabilite dalla direttiva 1999/5/CE.
[Latvian]	Ar šo OMRON Corporation deklarē, ka [G8D-407M-A* G8D-410M-B*, G8D-520M-A* G8C-500M*, G8D-581M-B*, G8D-571M-A* G8D-518M-A* G8C-507M*, G8C-223M-3C, G8C-541M*, G8D-621M-A* G8C-519M*, G8C-518M*, G8C-527M*, G8C-546M*, G8C-930M*, G8C-931M*, G9C-932M*] atbilst Direktīvas 1999/5/EK būtiskajām prasībām un citiem ar to saistītajiem noteikumiem.
[Lithuanian]	Šiuo OMRON Corporation deklaruoja, kad šis [G8D-407M-A* G8D-410M-B*, G8D-520M-A* G8C-500M*, G8D-581M-B*, G8D-571M-A* G8D-518M-A* G8C-507M*, G8C-223M-3C, G8C-541M*, G8D-621M-A* G8C-519M*, G8C-518M*, G8C-527M*, G8C-546M*, G8C-930M*, G8C-931M*, G9C-932M*] atitinka esminius reikalavimus ir kitas 1999/5/EB Direktivos nuostatas.
[Dutch]	Hierbij verklaart OMRON Corporation dat het toestel [G8D-407M-A* G8D-410M-B*, G8D-520M-A* G8C-500M*, G8D-581M-B*, G8D-571M-A* G8D-518M-A* G8C-507M*, G8C-223M-3C, G8C-541M*, G8D-621M-A* G8C-519M*, G8C-518M*, G8C-527M*, G8C-546M*, G8C-930M*, G8C-931M*, G9C-932M*] in overeenstemming is met de essentiële eisen en de andere relevante bepalingen van richtlijn 1999/5/EG.

[Maltese]	Hawmhlek, OMRON Corporation, jiddikjarja li dan [G8D-407M-A* G8D-410M-B* G8D-520M-A* G8C-500M* G8D-581M-B* G8D-571M-A* G8C-518M-A* G8C-507M* G8C-223M-3C G8C-541M* G8D-621M-A* G8C-519M* G8C-518M* G8C-527M* G8C-546M* G8C-930M* G8C-931M* G9C-932M*] jikkonforma mal-hiġijiet essenzjali u ma procevdiment i oħrajn relevanti li hemm fuq-Direttiva 1999/5/EC.
[Hungarian]	Alulírók, OMRON Corporation nyilatkozik, hogy a [G8D-407M-A* G8D-410M-B* G8D-520M-A* G8C-500M* G8D-581M-B* G8D-571M-A* G8C-518M-A* G8C-507M* G8C-223M-3C G8C-541M* G8D-621M-A* G8C-519M* G8C-518M* G8C-527M* G8C-546M* G8C-930M* G8C-931M* G9C-932M*] megfelel a vonatkozó alapvető követelményeknek és az 1999/5/EC irányelv egyéb előírásainak.
[Polish]	[OMRON Corporation] niniejszym oświadcza, że [G8D-407M-A* G8D-410M-B* G8D-520M-A* G8C-500M* G8D-581M-B* G8D-571M-A* G8C-518M-A* G8C-507M* G8C-223M-3C G8C-541M* G8D-621M-A* G8C-519M* G8C-518M* G8C-527M* G8C-546M* G8C-930M* G8C-931M* G9C-932M*] spełnia zasadnicze wymagania oraz inne istotne postanowienia dyrektywy 1999/5/EC.
[Portuguese]	OMRON Corporation declara que este [G8D-407M-A* G8D-410M-B* G8D-520M-A* G8C-500M* G8D-581M-B* G8D-571M-A* G8C-518M-A* G8C-507M* G8C-223M-3C G8C-541M* G8D-621M-A* G8C-519M* G8C-518M* G8C-527M* G8C-546M* G8C-930M* G8C-931M* G9C-932M*] está conforme com os requisitos essenciais e outras disposições da Directiva 1999/5/CE.
[Slovenian]	OMRON Corporation izjavlja, da je ta [G8D-407M-A* G8D-410M-B* G8D-520M-A* G8C-500M* G8D-581M-B* G8D-571M-A* G8C-518M-A* G8C-507M* G8C-223M-3C G8C-541M* G8D-621M-A* G8C-519M* G8C-518M* G8C-527M* G8C-546M* G8C-930M* G8C-931M* G9C-932M*] v skladu z bistvenimi zahtevami in ostalimi relevantnimi določili direktive 1999/5/ES.
[Slovak]	OMRON Corporation týmto vyhlasuje, že [G8D-407M-A* G8D-410M-B* G8D-520M-A* G8C-500M* G8D-581M-B* G8D-571M-A* G8C-518M-A* G8C-507M* G8C-223M-3C G8C-541M* G8D-621M-A* G8C-519M* G8C-518M* G8C-527M* G8C-546M* G8C-930M* G8C-931M* G9C-932M*] spĺňa základné požiadavky a všetky príslušné ustanovenia Smernice 1999/5/ES.
[Finnish]	OMRON Corporation vakuuttaa täten että [G8D-407M-A* G8D-410M-B* G8D-520M-A* G8C-500M* G8D-581M-B* G8D-571M-A* G8C-518M-A* G8C-507M* G8C-223M-3C G8C-541M* G8D-621M-A* G8C-519M* G8C-518M* G8C-527M* G8C-546M* G8C-930M* G8C-931M* G9C-932M*] täyttää sen olennaiset ja muut relevantit vaatimukset ja sitä koskevien direktiivin muiden ehtojen mukaisesti.
[Swedish]	Härmed intygar OMRON Corporation att denna [G8D-407M-A* G8D-410M-B* G8D-520M-A* G8C-500M* G8D-581M-B* G8D-571M-A* G8C-518M-A* G8C-507M* G8C-223M-3C G8C-541M* G8D-621M-A* G8C-519M* G8C-518M* G8C-527M* G8C-546M* G8C-930M* G8C-931M* G9C-932M*] står i överensstämmelse med de väsentliga egenskapskrav och övriga relevanta bestämmelser som framgår av direktiv 1999/5/EG.
[Icelandic]	Hér með lýsir OMRON Corporation yfir því að [G8D-407M-A* G8D-410M-B* G8D-520M-A* G8C-500M* G8D-581M-B* G8D-571M-A* G8C-518M-A* G8C-507M* G8C-223M-3C G8C-541M* G8D-621M-A* G8C-519M* G8C-518M* G8C-527M* G8C-546M* G8C-930M* G8C-931M* G9C-932M*] er í samræmi með grunnkröfur og aðrar kröfur, sem gerðar eru í tilskipun 1999/5/EC.
[Norwegian]	OMRON Corporation erklærer herved at utstyret [G8D-407M-A* G8D-410M-B* G8D-520M-A* G8C-500M* G8D-581M-B* G8D-571M-A* G8C-518M-A* G8C-507M* G8C-223M-3C G8C-541M* G8D-621M-A* G8C-519M* G8C-518M* G8C-527M* G8C-546M* G8C-930M* G8C-931M* G9C-932M*] er i samsvar med de grunnleggende krav og øvrige relevante krav i direktiv 1999/5/EF.
[Turkish]	İşbu belge ile OMRON Corporation, bu [G8D-407M-A* G8D-410M-B* G8D-520M-A* G8C-500M* G8D-581M-B* G8D-571M-A* G8C-518M-A* G8C-507M* G8C-223M-3C G8C-541M* G8D-621M-A* G8C-519M* G8C-518M* G8C-527M* G8C-546M* G8C-930M* G8C-931M* G9C-932M*] in 1995/5/EC Yönetmeliği esas gereksinimlerini ve diğer şartlarını uygun olduğuna beyan eder.
[Romania]	„Noi OMRON Corporation declaram că aparatură [G8D-407M-A* G8D-410M-B* G8D-520M-A* G8C-500M* G8D-581M-B* G8D-571M-A* G8C-518M-A* G8C-507M* G8C-223M-3C G8C-541M* G8D-621M-A* G8C-519M* G8C-518M* G8C-527M* G8C-546M* G8C-930M* G8C-931M* G9C-932M*] este în conformitate cu cerințele esențiale și cu alte prevederi relevante ale Hotărârii Guvernului nr. 88/2003 și Directivelor 1999/5/EC.
[Bulgarian]	С настоящия документ OMRON Corporation декларира, че [G8D-407M-A* G8D-410M-B* G8D-520M-A* G8C-500M* G8D-581M-B* G8D-571M-A* G8C-518M-A* G8C-507M* G8C-223M-3C G8C-541M* G8D-621M-A* G8C-519M* G8C-518M* G8C-527M* G8C-546M* G8C-930M* G8C-931M* G9C-932M*] е в съгласие с основните изисквания и съответните постановления на Директива 1999/5/EC.

A series of 15 horizontal dashed lines spanning the width of the page, providing a template for handwriting practice.

A series of 15 horizontal dashed lines spanning the width of the page, providing a template for writing.

A series of 15 horizontal dashed lines spanning the width of the page, providing a template for handwriting practice.

A series of 15 horizontal dashed lines spanning the width of the page, providing a template for handwriting practice.