

MIRAGE - EN-UK - 0A0X13E4

MIRAGE

OWNER'S MANUAL



MIRAGE - EN-UK - 0A0X13E4

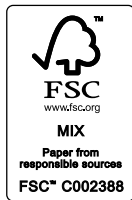

Foreword

E09200104601

Thank you for selecting a MIRAGE as your new vehicle. This owner's manual will add to your understanding and full enjoyment of the many fine features of this vehicle. It contains information prepared to acquaint you with the proper way to operate and maintain your vehicle for the utmost in driving pleasure.

MITSUBISHI MOTORS Europe B.V. reserves the right to make changes in design and specifications and/or to make additions to or improvements in this product without obligation to install them on products previously manufactured.

It is an absolute requirement for the driver to strictly observe all laws and regulations concerning vehicles.

This owner's manual has been written in compliance with such laws and regulations, but some of the contents may become contradictory with later amendment of the laws and regulations.

Please leave this owner's manual in this vehicle at time of resale. The next owner will appreciate having access to the information contained in this owner's manual.

Repairs to your vehicle:
Vehicles in the warranty period:
All warranty repairs must be carried out by a MITSUBISHI MOTORS Authorized Service Point.

Vehicles outside the warranty period:
Where the vehicle is repaired is at the discretion of the owner.

Throughout this owner's manual the words **WARNING** and **CAUTION** appear.

These serve as reminders to be especially careful. Failure to follow instructions could result in personal injury or damage to your vehicle.

WARNING

indicates a strong possibility of severe personal injury or death if instructions are not followed.

CAUTION

means hazards or unsafe practices that could cause minor personal injury or damage to your vehicle.

You will see another important symbol:

NOTE: gives helpful information.

*****: indicates optional equipment.

It may differ according to the sales classification; refer to the sales catalogue.

Abbreviations used in this owner's manual:

LHD: Left-Hand Drive

RHD: Right-Hand Drive

M/T: Manual Transmission

CVT: Continuously Variable Transmission

Information for station service

E09300102842

Fuel	Fuel tank capacity	35 litres
	Fuel requirements	Unleaded petrol octane number (EN228) 95 RON or higher Refer to the "General information" section for the fuel selection.
Engine oil		Refer to the "Maintenance" section for the selection of engine oil.
Tyre inflation pressure		Refer to the "Maintenance" section for the tyre inflation pressure.

Table of contents

<i>Overview/Quick guide</i>	
<i>General information</i>	
<i>Locking and unlocking</i>	1
<i>Seat and seat belts</i>	2
<i>Instruments and controls</i>	3
<i>Starting and driving</i>	4
<i>For pleasant driving</i>	5
<i>For emergencies</i>	6
<i>Vehicle care</i>	7
<i>Maintenance</i>	8
<i>Specifications</i>	9

Instruments and controls

E08500100074

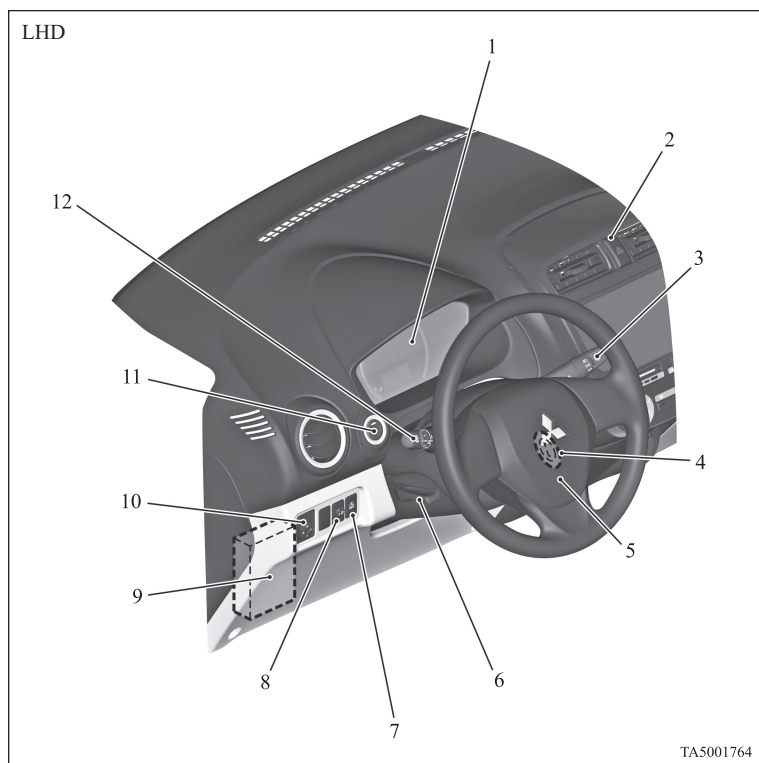

1. Instruments p. 3-02
2. Hazard warning flasher switch p. 3-18
3. Windscreen wiper and washer switch p. 3-19
Rear window wiper and washer switch p. 3-22
4. Ignition switch* p. 4-08
5. Supplemental restraint system (SRS) -airbag (for driver) p. 2-17
Horn switch p. 3-24
6. Steering wheel height adjustment p. 4-06
7. Auto Stop & Go (AS&G) OFF switch* p. 4-18
8. Headlamp levelling switch p. 3-16
9. Fuse box p. 8-15
10. Electric remote-controlled outside rear-view mirror switch* p. 4-07
11. Engine switch* p. 4-09
12. Combination headlamps and dipper switch p. 3-14
Turn-signal lever p. 3-17
Front fog lamp switch* p. 3-18
Rear fog lamp switch p. 3-18

RHD

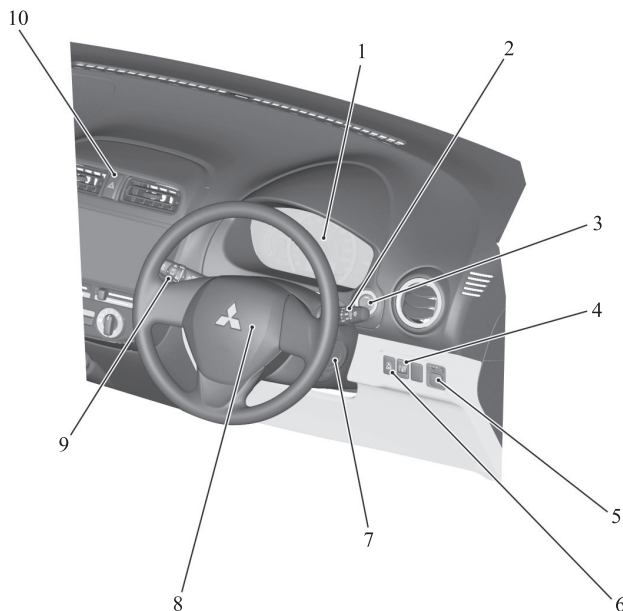

TA5001777

1. Instruments p. 3-02
2. Windscreen wiper and washer switch p. 3-19
Rear window wiper and washer switch p. 3-22
3. Engine switch* p. 4-09
4. Headlamp levelling switch p. 3-16
5. Electric remote-controlled outside rear-view mirror switch* p. 4-07
6. Auto Stop & Go (AS&G) OFF switch* p. 4-18
7. Ignition switch* p. 4-08
8. Supplemental restraint system (SRS) -airbag (for driver) p. 2-17
Horn switch p. 3-24
9. Combination headlamps and dipper switch p. 3-14
Turn-signal lever p. 3-17
Front fog lamp switch* p. 3-18
Rear fog lamp switch p. 3-18
10. Hazard warning flasher switch p. 3-18

LHD

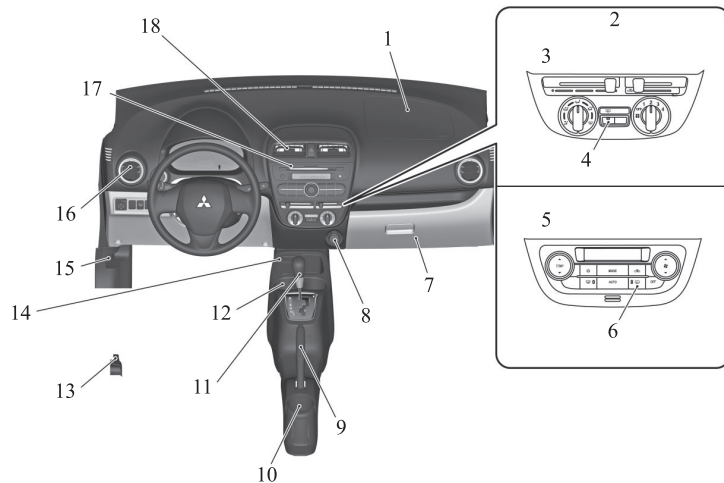

TA5001780

1. Supplemental restraint system (SRS)-airbag (for front passenger) p. 2-17
2. Heater* p. 5-03
3. Manual air conditioning* p. 5-03
4. Rear window demister switch p. 3-23
5. Automatic air conditioning* p. 5-06
6. Rear window demister switch p. 3-23
7. Glove box p. 5-36
8. Accessory socket p. 5-35
9. Parking brake lever p. 4-04
10. Cup holder (for the rear seat) p. 5-37
11. Gearshift lever* p. 4-19
Selector lever* p. 4-21
12. Cup holder (for the front seat) p. 5-37
13. Fuel tank filler door release lever p. 02
14. Key slot* p. 4-14
15. Bonnet release lever p. 8-04
16. Side ventilators p. 5-02
17. Audio* p. 5-13
MITSUBISHI Multi Entertainment System*
Refer to the separate "MITSUBISHI Multi Entertainment System owner's manual"
Digital clock* p. 5-20
18. Centre ventilators p. 5-02

RHD

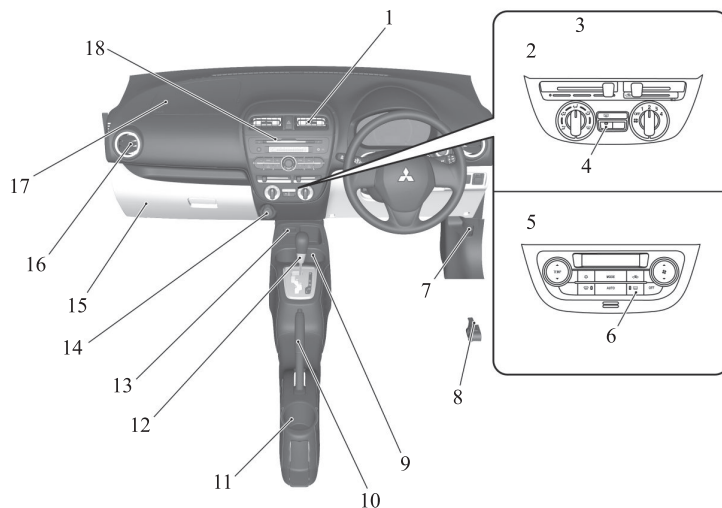

TA5001618

1. Centre ventilators p. 5-02
 2. Manual air conditioning* p. 5-03
 3. Heater* p. 5-03
 4. Rear window demister switch p. 3-23
 5. Automatic air conditioning* p. 5-06
 6. Rear window demister switch p. 3-23
 7. Bonnet release lever p. 8-04
 8. Fuel tank filler door release lever p. 02
 9. Cup holder (for the front seat) p. 5-37
 10. Parking brake lever p. 4-04
 11. Cup holder (for the rear seat) p. 5-37
 12. Gearshift lever* p. 4-19
 - Selector lever* p. 4-21
 13. Key slot* p. 4-14
 14. Accessory socket p. 5-35
 15. Glove box p. 5-36
 16. Side ventilators p. 5-02
 17. Supplemental restraint system (SRS)-airbag (for front passenger) p. 2-17
 18. Audio* p. 5-13
- MITSUBISHI Multi Entertainment System*
 Refer to the separate "MITSUBISHI Multi Entertainment System owner's manual"
 Digital clock* p. 5-20

Interior

E08500200075

LHD

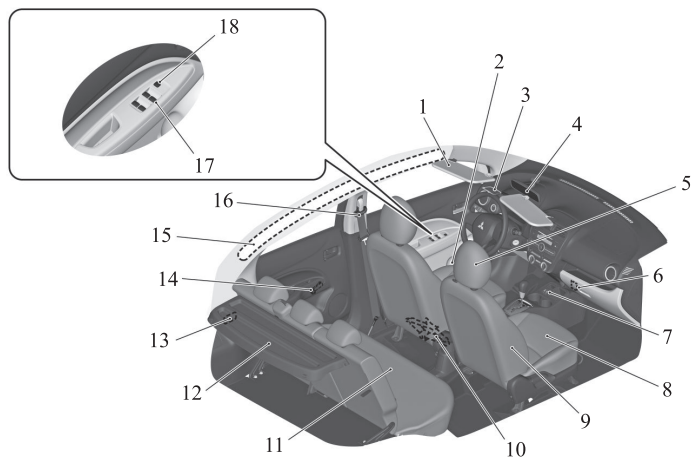

TA5001881

1. Sun visors p. 5-34
Vanity mirror p. 5-34
Card holder p. 5-34
2. Bottle holder p. 5-38
3. Room lamp p. 5-35, 8-21
4. Inside rear-view mirror p. 4-06
5. Head restraints p. 2-04
6. USB input terminal* p. 5-31
7. Heated seat switches* p. 2-03
8. Front seat p. 2-02
9. Supplemental restraint system (SRS) - side airbag (for front seat) p. 2-23
10. Jack* p. 6-05
11. Rear seat p. 2-03
12. Rear shelf panel* p. 5-38
13. Luggage room lamp* p. 5-36, 8-21
14. Manual window control* p. 1-15
15. Supplemental restraint system (SRS) - curtain airbag p. 2-23
16. Seat belts p. 2-05
Adjustable seat belt anchor* p. 2-07
17. Electric window control switch* p. 1-15
18. Electric window lock switch* p. 1-16

RHD

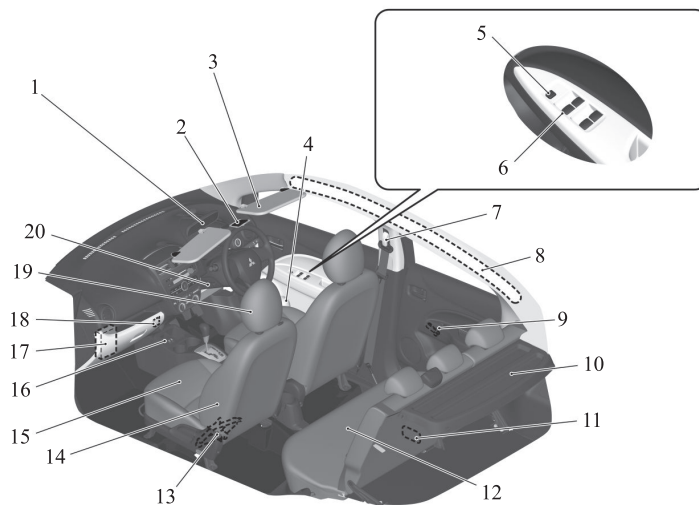

TA5001894

1. Inside rear-view mirror p. 4-06
2. Room lamp p. 5-35, 8-21
3. Sun visors p. 5-34
Vanity mirror p. 5-34
Card holder p. 5-34
4. Bottle holder p. 5-38
5. Electric window lock switch* p. 1-16
6. Electric window control switch* p. 1-15
7. Seat belts p. 2-05
Adjustable seat belt anchor* p. 2-07
8. Supplemental restraint system (SRS) - curtain airbag p. 2-23
9. Manual window control* p. 1-15
10. Rear shelf panel* p. 5-38
11. Luggage room lamp* p. 5-36, 8-21
12. Rear seat p. 2-03
13. Jack* p. 6-05
14. Supplemental restraint system (SRS) - side airbag (for front seat) p. 2-23
15. Front seat p. 2-02
16. Heated seat switches* p. 2-03
17. Fuse box p. 8-15
18. USB input terminal* p. 5-31
19. Head restraints p. 2-04
20. Steering wheel height adjustment p. 4-06

Luggage area

E0850030047

Type 1

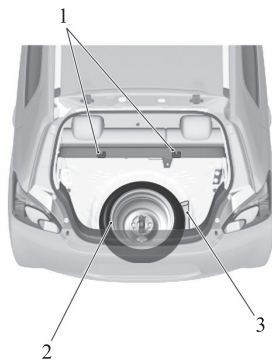

Type 2

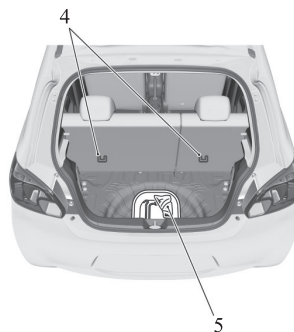

1. Tether anchorages for child restraint system p. 2-15
2. Spare wheel p. 6-12
3. Tools p. 6-05
4. Tether anchorages for child restraint system p. 2-15
5. Tools p. 6-05
Tyre repair kit p. 6-06

TA5001908

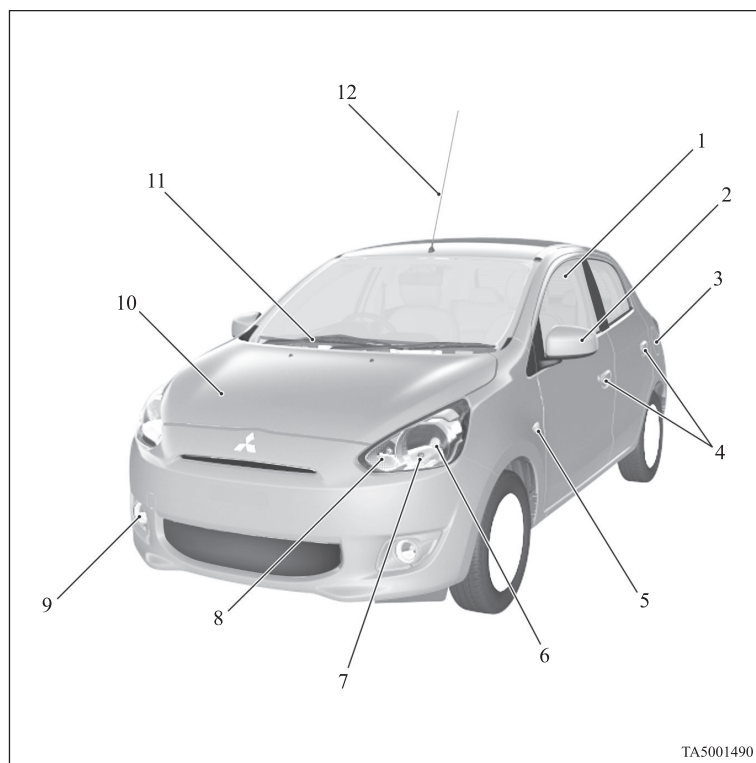
Outside (Front)

1. Electric window control* p. 1-15
2. Outside rear-view mirror p. 4-07
3. Fuel tank filler p. 02
4. Locking and unlocking the doors p. 1-12
Keyless entry system* p. 1-03
Keyless operation system* p. 1-04
5. Side turn-signal lamps p. 3-17, 8-20
6. Headlamps p. 3-14, 8-20, 8-21
7. Position lamps p. 3-14, 8-20, 8-21
8. Front turn-signal lamps p. 3-17, 8-20, 8-21
9. Front fog lamps* p. 3-18, 8-20, 8-22
Daytime running lamps* p. 8-20, 8-22
10. Engine compartment p. 8-02, 9-13
Bonnet p. 8-04
11. Windscreen wiper and washer p. 3-19
12. Antenna p. 5-30

Outside (Rear)

E08500400123

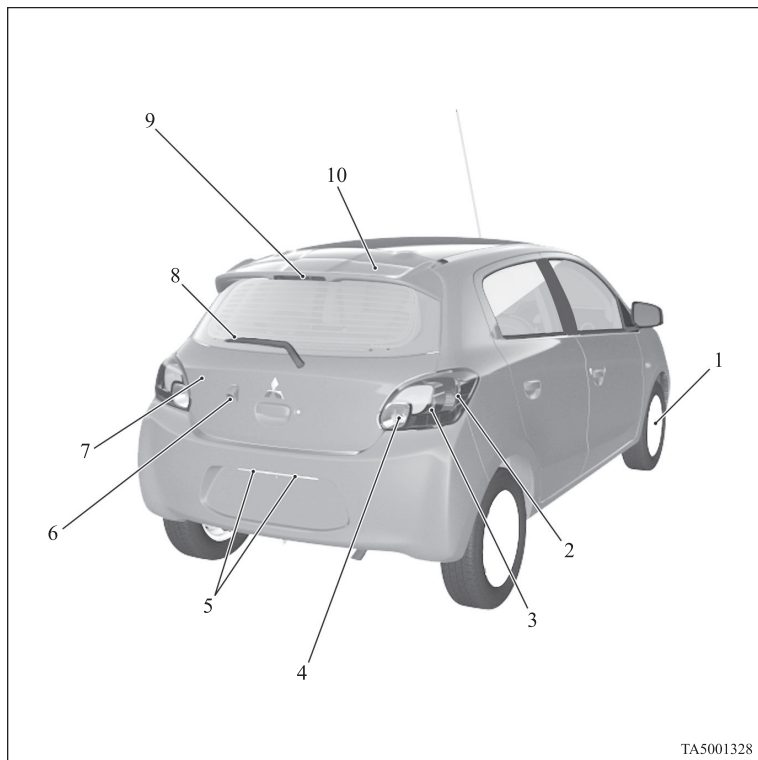

1. Tyre p. 8-09
Tyre inflation pressures p. 8-10
Wheel condition p. 8-11
Tyre rotation p. 8-11
Snow traction device (Tyre chains) p. 8-12
Size of tyres and wheels p. 9-10
2. Stop and tail lamps p. 8-20, 8-23
3. Rear turn-signal lamps p. 3-17, 8-20, 8-23
4. Reversing lamps (passenger's side) p. 8-20, 8-23
Rear fog lamp (driver's side) p. 8-20, 8-23
5. Licence plate lamps p. 8-20, 8-24
6. Rear-view camera* p. 4-32
7. Tailgate p. 1-14
8. Rear window wiper and washer p. 3-22
9. High-mounted stop lamp* p. 8-20, 8-24
10. Rear spoiler*

Quick guide

E08500500010

Lock and unlock the doors and tailgate

E08500600040

Keyless entry system*

Press the remote control switch, and all doors and the tailgate will be locked or unlocked as desired. The remote control switch will operate within approximately 4 m from the vehicle.

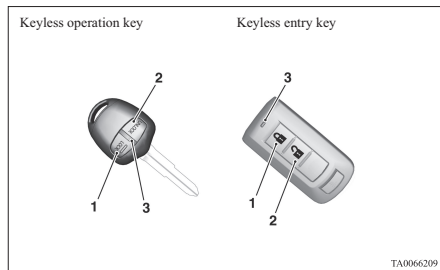

TA0066209

- 1- LOCK switch
- 2- UNLOCK switch
- 3- Indication lamp

Refer to “Keyless entry system*” on page 1-03.

Keyless operation system*

When you are carrying the keyless operation key, if you press the driver’s door switch (A), or the tailgate switch (B) within the operating range, the doors and the tailgate are locked/unlocked.

The operating range is approximately 70 cm from the driver’s door switch and the tailgate switch.

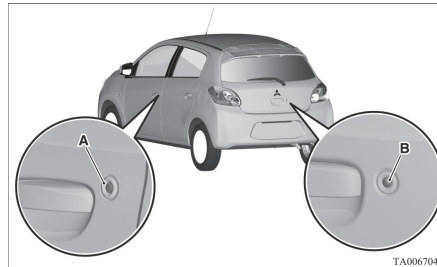

TA0067046

Refer to “Keyless operation system*” on page 1-04.

Around the driver’s seat

E08500800068

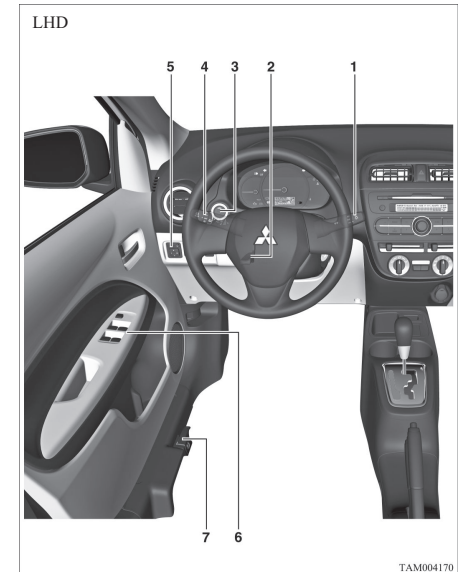

TAM004170

Overview/Quick guide



1-Wiper and washer switch

Except for vehicles equipped with rain sensor

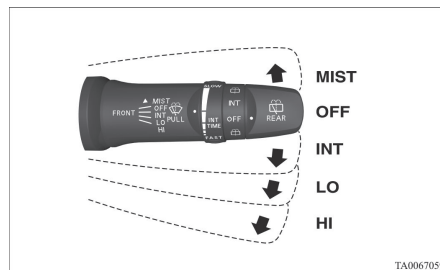

MIST- Misting function
The wipers will operate once.

OFF- Off

INT- Intermittent (Speed sensitive)

LO- Slow

HI- Fast

Vehicles with rain sensor

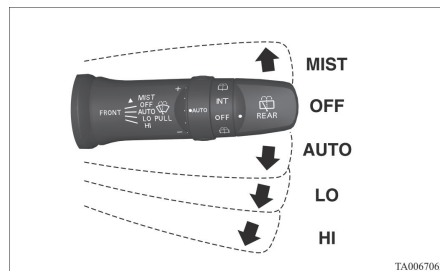

MIST- Misting function
The wipers will operate once.

OFF- Off

AUTO- Auto-wiper control
Rain sensor
The wipers will automatically operate depending on the degree of wetness on the windscreen.

LO- Slow

HI- Fast

The washer fluid will be sprayed onto the windscreen by pulling the lever towards you.
Refer "Wiper and washer switch" on page 3-19.

2-Steering wheel height adjustment

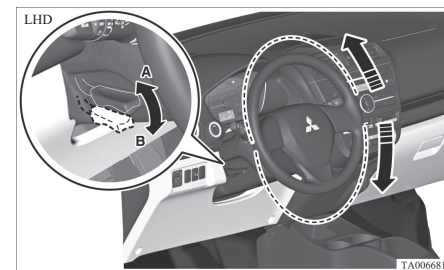

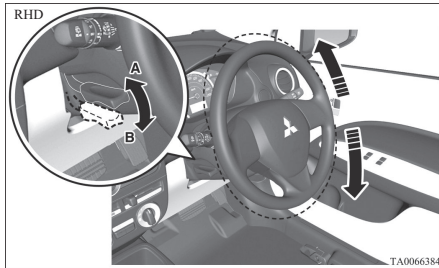

A- Locked
B- Release

1. Release the lever while holding the steering wheel up.
2. Adjust the steering wheel to the desired position.
3. Securely lock the steering wheel by pulling the lever fully upward.

Refer “Steering wheel height adjustment” on page 4-06.

3-Engine switch*

[For vehicles equipped with keyless operation system]

If you are carrying the keyless operation key, you can start the engine. If you press the engine switch without depressing the brake pedal (CVT) or the clutch pedal (M/T), you can change the operation mode in the order of OFF, ACC, ON, OFF.

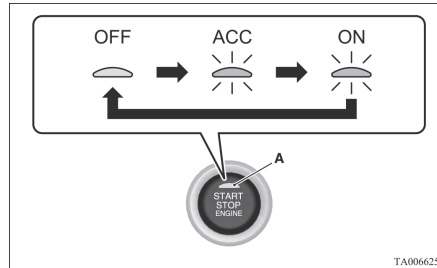

OFF- The indication lamp (A) on the engine switch turns off.

ACC- The indication lamp on the engine switch illuminates orange.

ON- The indication lamp on the engine switch illuminates green.

Refer “Engine switch” on page 4-09.

4-Combination headlamps

Type 1

Rotate the switch to turn on the lamps.

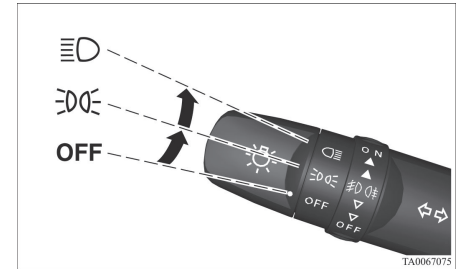



OFF	All lamps off
	Position, tail, licence plate and instrument panel lamps on
	Headlamps and other lamps go on

Rotate the switch to turn on the lamps.

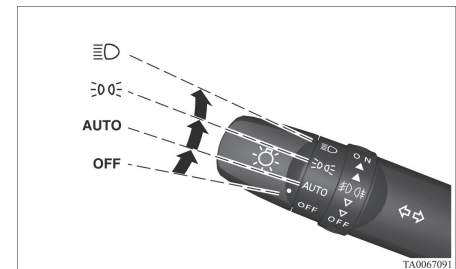
Type 2



Overview/Quick guide

OFF	All lamps off
AUTO	With the ignition switch or the operation mode is in ON, head-lamps, position, tail, licence plate, and instrument panel lamps turn on and off automatically in accordance with outside light level. All lamps turn off automatically when the ignition switch is turned to "OFF" position or the operation mode is put in OFF.
	Position, tail, licence plate and instrument panel lamps on
	Headlamps and other lamps go on

Refer "Combination headlamps and dipper switch" on page 3-14.

4-Turn-signal lever

The turn-signal lamps flash when the lever is operated

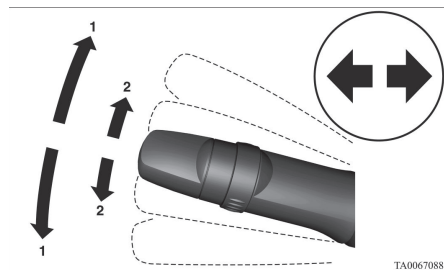

- 1- Turn-signals
- 2- Lane-change signals

Refer "Turn-signal lever" on page 3-17.

5-Electric remote-controlled outside rear-view mirrors*

To adjust the mirror position

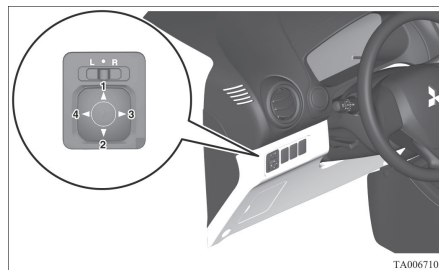

- L- Left outside mirror adjustment
- R- Right outside mirror adjustment
- 1- Up
- 2- Down
- 3- Right
- 4- Left

Refer "Electric remote-controlled outside rear-view mirrors" on page 4-07.

6-Electric window control*

Press the switch down for opening the window, and pull the switch for closing.

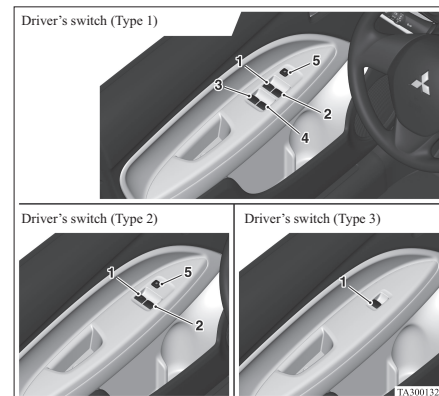

- 1- Driver's door window
- 2- Front passenger's door window
- 3- Rear left door window
- 4- Rear right door window
- 5- Lock switch

Lock switch (Type 1 and 2)

If you press the switch (5), the passenger's switches cannot be operated. To cancel, press it once again.

Refer "Electric window control" on page 1-15.

7-Fuel tank filler door release lever

Open the fuel tank filler door.

The fuel tank filler is located on the rear left side of your vehicle.

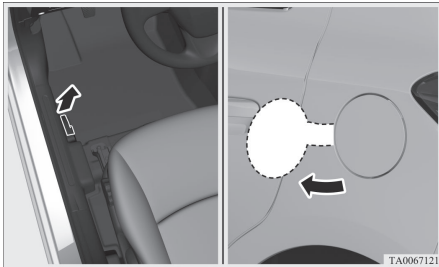

Refer “Filling the fuel tank” on page 02.

Automatic transmission INVECS-III CVT (Intelligent & Innovative Vehicle Electronic Control System III)*

E08501000054

Selector lever operation

The CVT selects an optimum gear ratio automatically, depending on the speed of the vehicle and the position of the accelerator pedal.

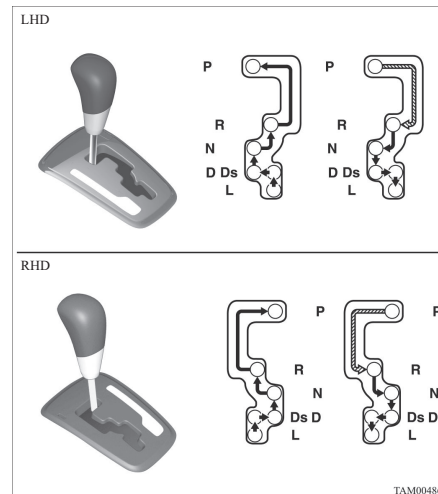

	While depressing the brake pedal, move the selector lever through the gate.
	Move the selector lever through the gate.

Selector lever positions

“P” PARK

This position locks the transmission to prevent the vehicle from moving. The engine can be started in this position.

“R” REVERSE

This position is to back up.

“N” NEUTRAL

At this position the transmission is disengaged.

“D” DRIVE

This position is used for most city and highway driving.

“Ds” (DOWNSHIFT & SPORTY DRIVING)

Use when engine braking is needed, or for high-power sport drive.

“L” (LOW)

This position is for driving up very steep hills and for engine braking at low speeds when driving down steep hills.

Refer to “Automatic transmission INVECS-III CVT (Intelligent & Innovative Vehicle Electronic Control System III)” on page 4-21.

Instruments

E08501100039

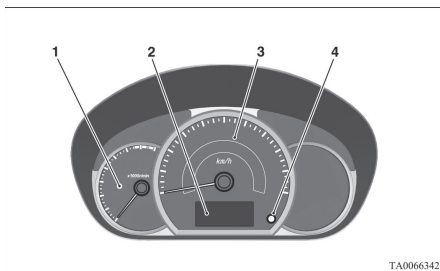

1- Tachometer*

The tachometer indicates the engine speed (r/min). The tachometer helps you to obtain more economical driving and also warns you of excessive engine speeds (Red zone).

- 2- Multi-information display
- 3- Speedometer (km/h or mph + km/h)
- 4- Multi-information display switch

Refer to “Instruments” on page 3-02.

Multi-information display

Always stop the vehicle in a safe place before operating.

The following information is included on the multi-information display: odometer, tripmeter, meter illumination control, service reminder, fuel remaining, driving range and average fuel consumption, etc.

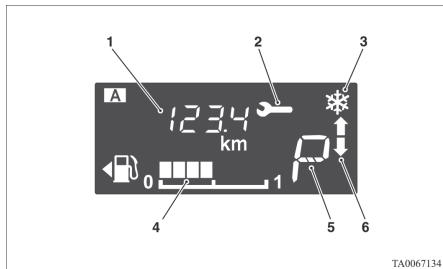

- 1- Information display
- 2- Service reminder
- 3- Frozen road warning*
- 4- Fuel remaining display
- 5- Selector lever position display*
- 6- Gearshift indicator*

Refer to “Multi-information display” on page 3-02.

Indication and warning lamps

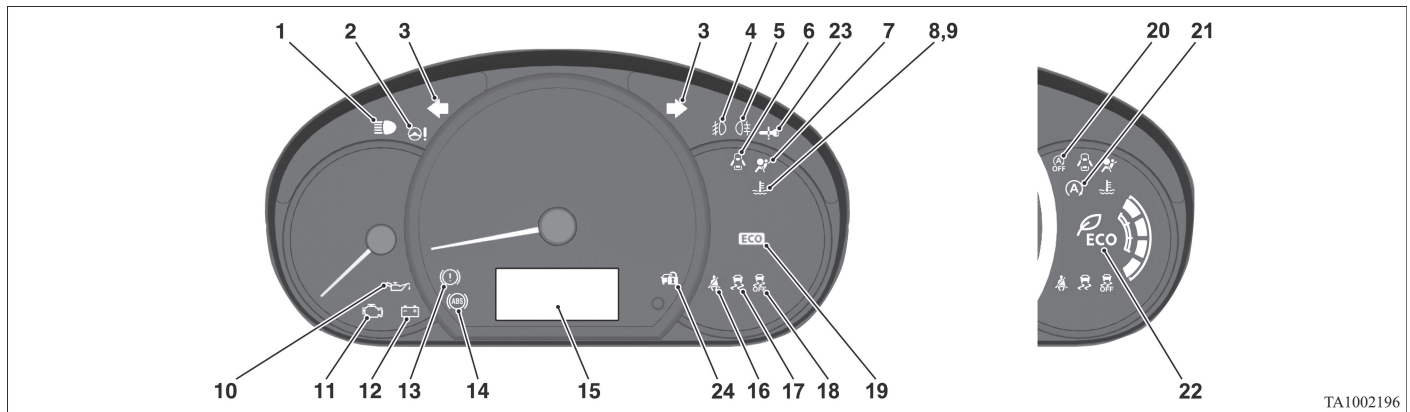

TA1002196

- 1- High-beam indication lamp → p. 3-11
- 2- Electric power steering system (EPS) warning lamp → p. 4-30
- 3- Turn-signal indication lamps/Hazard warning indication lamps → p. 3-11
- 4- Front fog lamp indication lamp* → p. 3-11
- 5- Rear fog lamp indication lamp → p. 3-11
- 6- Door ajar warning lamp → p. 3-14
- 7- Supplement Restraint System (SRS) warning lamp → p. 2-25
- 8- High coolant temperature warning lamp (red) → p. 3-13
- 9- Low coolant temperature indication lamp (green) → p. 3-11
- 10- Oil pressure warning lamp → p. 3-13
- 11- Check engine warning lamp → p. 3-12
- 12- Charge warning lamp → p. 3-13
- 13- Brake warning lamp → p. 3-12
- 14- Anti-lock brake system (ABS) warning lamp → p. 4-28
- 15- Multi-information display → p. 3-02
- 16- Seat belt warning lamp → p. 2-06
- 17- Active Stability Control (ASC) indication lamp → p. 4-31
- 18- Active Stability Control (ASC) OFF indication lamp → p. 4-31
- 19- ECO indication lamp* → p. 3-11
- 20- Auto Stop & Go (AS&G) OFF indication lamp* → p. 4-18
- 21- Auto Stop & Go (AS&G) indication lamp* → p. 4-15
- 22- ECO drive assist* → p. 3-11
- 23- For details, refer to “Warning activator” on page 1-09. (if so equipped)
- 24- For details, refer to “Warning activator” on page 1-09. (if so equipped)

A series of 15 horizontal dashed lines spanning the width of the page, providing a template for writing.

General information

Fuel selection.....	02
Filling the fuel tank.....	02
Installation of accessories.....	04
Modification/alterations to the electrical or fuel systems.....	04
Genuine parts.....	05
Safety and disposal information for used engine oil.....	05
Disposal information for used batteries.....	05

General information

Fuel selection

E00200103249

Recommended fuel	Unleaded petrol octane number (EN228) 95 RON or higher
------------------	---

CAUTION

- The use of leaded fuel can result in serious damage to the engine and catalytic converter. Do not use leaded fuel.

NOTE

- Your vehicles have the knock control system so that you can use unleaded petrol 90 RON as an emergent measure in case unleaded petrol 95 RON or higher is not available on journey, etc.
In such a case, you don't need to adjust the engine specially. In case of using unleaded petrol 90 RON, the engine performance level is reduced.

- Repeatedly driving short distances at low speeds can cause deposits to form in the fuel system and engine, resulting in poor starting and poor acceleration. If these problems occur, you are advised to add a detergent additive to the gasoline when you refuel the vehicle. The additive will remove the deposits, thereby returning the engine to a normal condition. Be sure to use a MITSUBISHI MOTORS GENUINE FUEL SYSTEM CLEANER. Using an unsuitable additive could make the engine malfunction. For details, please contact a MITSUBISHI MOTORS Authorized Service Point.
- Poor quality petrol can cause problems such as difficult starting, stalling, engine noise and hesitation. If you experience these problems, try another brand and/or grade of petrol. If the check engine warning lamp flashes, have the system checked as soon as possible at a MITSUBISHI MOTORS Authorized Service Point.

E10 type petrol

E00203200019

The petrol engines are compatible with the E10 type petrol (containing 10 % ethanol) conforming to European standards EN 228.

CAUTION

- Do not use more than 10 % concentration of ethanol (grain alcohol) by volume. Use of more than 10 % concentration may lead to damage to your vehicle fuel system, engine, engine sensors and exhaust system.

Filling the fuel tank

E00200202575

WARNING

- When handling fuel, comply with the safety regulations displayed by garages and filling stations.
- Gasoline is highly flammable and explosive. You could be burned or seriously injured when handling it. When refueling your vehicle, always turn the engine off and keep away from flames, sparks, and smoking materials. Always handle fuel in well-ventilated outdoor areas.
- Before removing the fuel cap, be sure to get rid of your body's static electricity by touching a metal part of the car or the fuel pump. Any static electricity on your body could create a spark that ignites fuel vapour.
- Perform the whole refueling process (opening the fuel tank filler door, removing the fuel cap, etc.) by yourself. Do not let any other person come near the fuel tank filler. If you allowed a person to help you and that person was carrying static electricity, fuel vapour could be ignited.
- Do not move away from the fuel tank filler until refueling is finished. If you moved away and did something else (for example, sitting on a seat) partway through the refueling process, you could pick up a fresh charge of static electricity.
- If the tank cap must be replaced, use only a MITSUBISHI MOTORS original part.

Fuel tank capacity

35 litres

Refueling

1. Before filling with fuel, stop the engine.
2. The fuel tank filler is located on the rear left side of your vehicle.
Open the fuel tank filler door by pulling the release lever located on the side of the driver's seat.

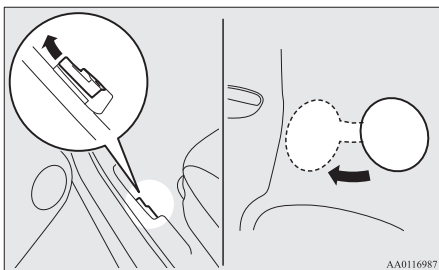

3. Open the fuel tank filler tube by slowly turning the cap anticlockwise.

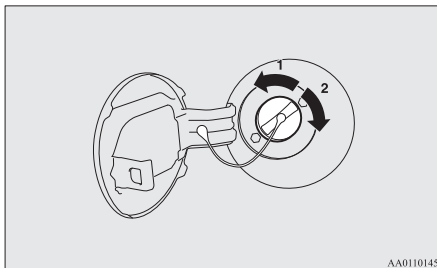

- A- Remove
B- Close

⚠ CAUTION

- Since the fuel system may be under pressure, remove the fuel tank filler tube cap slowly. This relieves any pressure or vacuum that might have built up in the fuel tank. If you hear a hissing sound, wait until it stops before removing the cap. Otherwise, fuel may spray out, injuring you or others.

General information

4. While filling with fuel, hang the fuel cap cord on the hook located on the inside of the fuel tank filler door.

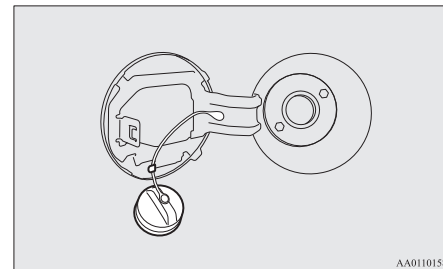

5. Insert the gun in the tank port as far as it goes.

⚠ CAUTION

- Do not tilt the gun.

6. When the gun stops automatically, do not fill with fuel any more.
7. To close, turn the fuel tank filler tube cap slowly clockwise until you hear clicking sounds, then gently push the fuel tank filler door closed.

General information

Installation of accessories

E00200301045

We recommend you to consult a MITSUBISHI MOTORS Authorized Service Point.

- The installation of accessories, optional parts, etc., should only be carried out within the limits prescribed by law in your country, and in accordance with the guidelines and warnings contained within the documents accompanying this vehicle.
- Installing electric components incorrectly could lead to a fire. Please refer to Modification/alteration to the electrical or fuel systems section within this owner's manual.
- Using a cellular phone or radio set inside the vehicle without an external antenna may cause electrical system interference, which could lead to unsafe vehicle operation.
- Tyres and wheels which do not meet specifications must not be used.
Refer to the "Specifications" section for information regarding wheel and tyre sizes.
- When fitting accessories, ensure that maximum gross vehicle weight and maximum axle weight are not exceeded.

Important points!

Due to large number of accessory and replacement parts of different manufactures available in the market, it is not possible, not only for MITSUBISHI MOTORS, but also for a MITSUBISHI MOTORS Authorized Service Point, to check whether the attachment or installation of such parts affects the overall safety of your MITSUBISHI-vehicle.

Even when such parts are officially authorized, for example by a "general operators permit" (an appraisal for the part) or through the execution of the part in an officially approved manner of construction, or when a single operation permit following the attachment or installation of such parts, it cannot be deduced from that alone, that the driving safety of your vehicle has not been affected.

Consider also that there basically exists no liability on the part of the appraiser or the official. Maximum safety can only be ensured with parts recommended, sold and fitted or installed by a MITSUBISHI MOTORS authorized Service Point (MITSUBISHI MOTORS GENUINE replacement parts and MITSUBISHI MOTORS accessories). The same also pertains to modifications of MITSUBISHI vehicles with respect to the production specifications. For safety reasons, do not attempt any modifications other than those that follow the recommendations of a MITSUBISHI MOTORS authorized Service Point.

Modification/alterations to the electrical or fuel systems

E00200400368

MITSUBISHI MOTORS CORPORATION has always manufactured safe, high quality vehicles. In order to maintain this safety and quality, it is important that any accessory that is to be fitted, or any modifications carried out which involve the electrical or fuel systems, should be carried out in accordance with MITSUBISHI guidelines.



CAUTION

- If the wires interfere with the vehicle body or improper installation methods are used (protective fuses not included, etc.), electronic devices may be adversely affected, resulting in a fire or other accident.

Genuine parts

E00200500499

MITSUBISHI MOTORS has gone to great lengths to bring you a superbly crafted automobile offering the highest quality and dependability.

Use MITSUBISHI MOTORS GENUINE Parts, designed and manufactured to maintain your MITSUBISHI MOTORS automobile at top performance. MITSUBISHI MOTORS GENUINE Parts are identified by this mark and are available at all MITSUBISHI MOTORS Authorized Service Points.

**MITSUBISHI MOTORS
GENUINE PARTS**

Safety and disposal information for used engine oil

E00200600155



WARNING

- Prolonged and repeated contact may cause serious skin disorders, including dermatitis and cancer.
- Avoid contact with the skin as far as possible and wash thoroughly after any contact.
- Keep used engine oils out of reach of children.

Protect the environment

It is illegal to pollute drains, water courses and soil. Use authorized waste collection facilities, including civic amenity sites and garages providing facilities for disposal of used oil and used oil filters. If in doubt, contact your local authority for advice on disposal.

General information

Disposal information for used batteries

E00201300032



Your vehicle contains batteries and/or accumulators. Do not mix with general household waste.

For proper treatment, recovery and recycling of used batteries, please take them to applicable collection points, in accordance with your national legislation and the Directives 2006/66/EC. By disposing of these batteries correctly, you will help to save valuable resources and prevent any potential negative effects on human health and the environment which could otherwise arise from inappropriate waste handling.

A series of 15 horizontal dashed lines spanning the width of the page, providing a template for writing.

Locking and unlocking

Keys.....	1-02
Key number tag.....	1-02
Electronic immobilizer (Anti-theft starting system).....	1-03
Keyless entry system*.....	1-03
Keyless operation system*.....	1-04
Doors.....	1-12
Central door locks*.....	1-13
“Child-protection” rear doors.....	1-14
Tailgate.....	1-14
Manual window control*.....	1-15
Electric window control*.....	1-15

Locking and unlocking

Keys

E00300102575

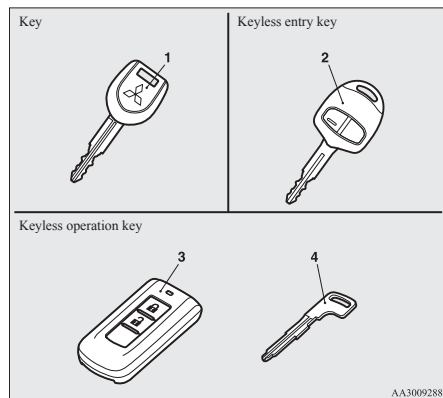

- 1- Master key
- 2- Keyless entry key
- 3- Keyless operation key
- 4- Emergency key

⚠ WARNING

- When carrying a remote control key on flights, do not press any switches on the key while on the plane. If a switch is pressed on the plane, the key emits electromagnetic waves, which could adversely affect the plane's flight operation. When carrying a remote control key in a bag, be careful that no switches on the key can be easily pressed by mistake.

NOTE

- The key is a precision electronic device with a built-in signal transmitter. Please observe the following in order to prevent a malfunction.
 - Do not leave in a place that is exposed to direct sunlight, for example on the dashboard.
 - Do not disassemble or modify.
 - Do not excessively bend the key or subject it to strong impacts.
 - Do not expose to water.
 - Keep away from magnetic key rings.
 - Keep away from audio systems, personal computers, TVs, and other equipment that generates a magnetic field.
 - Keep away from devices that emit strong electromagnetic waves, such as cellular phones, wireless devices and high frequency equipment (including medical devices).
 - Do not clean with ultrasonic cleaners or similar equipment.
 - Do not leave the key where it may be exposed to high temperature or high humidity.
- The engine is designed so that it will not start if the ID code registered in the immobilizer computer and the key's ID code do not match. Refer to the "Electronic immobilizer" section for details and key usage.

Key number tag

E00312700024

The key number is stamped on the tag as indicated in the illustration.

Make a record of the key number and store the key and key number tag in separate places, so that you can order a key from your MITSUBISHI MOTORS Authorized Service Point in the event the original keys are lost.

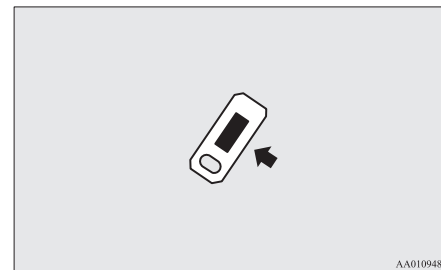

Electronic immobilizer (Anti-theft starting system)

E00300201999

The electronic immobilizer is designed to significantly reduce the possibility of vehicle theft. The purpose of the system is to immobilize the vehicle if an invalid start is attempted. A valid start attempt can only be achieved by using a key “registered” to the immobilizer system.

NOTE

- [Vehicles without keyless operation system]
In the following cases, the vehicle may not be able to receive the registered ID code from the registered key and engine may not start.
 - When the key contacts a key ring or other metallic or magnetic object
 - When the key grip contacts metal of another key
 - When the key contacts or is close to other immobilizing keys (including keys of other vehicles)

In cases like these, remove the object or additional key from the vehicle key. Then try again to start the engine. If the engine does not start, we recommend you to contact a MITSUBISHI MOTORS Authorized Service Point.

- If you lose one of the master keys, the keyless entry keys or the keyless operation keys, contact a MITSUBISHI MOTORS Authorized Service Point as soon as possible. Refer to “Keys” on page 1-02.

To obtain a key, take your vehicle and all remaining keys to a MITSUBISHI MOTORS Authorized Service Point.

If you need an extra spare key, take your vehicle and all the keys to a MITSUBISHI MOTORS Authorized Service Point. All the keys have to be re-registered in the immobilizer computer unit.

For further information, please contact a MITSUBISHI MOTORS Authorized Service Point.

CAUTION

- **Don't make any alterations or additions to the immobilizer system; alterations or additions could cause failure of the immobilizer.**

Keyless entry system*

E00300302724

Press the remote control switch, and all doors and the tailgate will be locked or unlocked as desired.

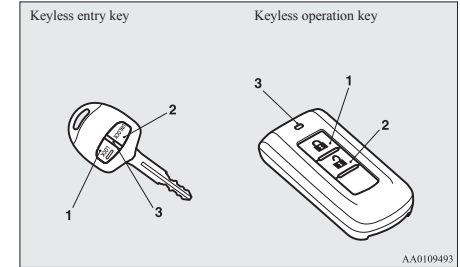

- 1- LOCK switch
- 2- UNLOCK switch
- 3- Indication lamp

To lock

Press the LOCK switch (1). All the doors and the tailgate will be locked. The turn-signal lamps will blink once. When they are locked with the room lamp switch in the middle (•) position, the room lamp also blink once.

To unlock

Press the UNLOCK switch (2). All the doors and the tailgate will be unlocked. If the room lamp switch is in the middle (•) position at this time, the room lamp will come on for approximately 15 seconds and the turn-signal lamps will blink twice.

Locking and unlocking

NOTE

- For vehicles equipped with the mirror retractor switch, the outside rear-view mirrors automatically retract or extend when all the doors and the tailgate are locked or unlocked using the remote control switches of the keyless entry system. Refer to “Starting and driving: Outside rear-view mirrors” on page 4-07.
- If the UNLOCK switch (2) is pressed and no door or tailgate is opened within approximately 30 seconds, relocking will automatically occur.
- It is possible to modify functions as follows: For further information, please contact a MITSUBISHI MOTORS Authorized Service Point.
 - The time from pressing the UNLOCK switch (2) to the moment of automatic locking can be changed.
 - Activating the operation confirmation function (blinking of the turn-signal lamps) only during locking, or only during unlocking.
 - The confirmation function (this indicates locking or unlocking of the doors and tailgate with the flash of the turn-signal lamps) can be deactivated.
 - The number of times the turn-signal lamps are flashed by the confirmation function can be changed.
 - On vehicles with keyless operation system, the buzzer sound can be activated when a keyless operation is done.
- The keyless entry system does not operate in the following conditions:
 - The key is left in the ignition switch. (except for vehicles with keyless operation system)
 - The operation mode is not in OFF. (vehicles with keyless operation system)
 - The door or tailgate is open.
- The remote control switch will operate within approximately 4 m from the vehicle. However, the operating range of the remote control switch may change if the vehicle is located near a power station, or radio/TV broadcasting station.
- If either of the following problems occurs, the battery may be exhausted.
 - The remote control switch is operated at the correct distance from the vehicle, but the doors and tailgate are not locked/unlocked in response.
 - The indication lamp (3) is dim or does not come on.
For further information, please contact a MITSUBISHI MOTORS Authorized Service Point.
- If your remote control switch is lost or damaged, please contact a MITSUBISHI MOTORS Authorized Service Point for a replacement remote control switch.
- If you wish to add a remote control switch, please contact a MITSUBISHI MOTORS Authorized Service Point.
The following numbers of the remote control switches are available.
 - Keyless entry key: up to 4 keys
 - Keyless operation key: up to 4 keys

Keyless operation system*

E00305600601

The keyless operation system allows you to lock and unlock the doors and tailgate, start the engine and change the operation mode simply by carrying the keyless operation key with you.

The keyless operation key can also be used as the keyless entry system remote control switch.

Refer to “Starting” on page 4-12.

Refer to “Keyless entry system” on page 1-03.

The driver should always carry the keyless operation key. This key is necessary for locking and unlocking the doors and tailgate, starting the engine and otherwise operating the vehicle, so before locking and leaving the vehicle, be sure to check that you have the keyless operation key.

WARNING

- **People with implantable cardiac pacemakers or implantable cardiovascular-defibrillators should not go near the exterior transmitters (A) or the interior transmitters (B). The radio waves used by the keyless operation system could adversely affect implantable cardiac pacemakers or implantable cardiovascular-defibrillators.**

Operating range of the keyless operation system

E00305700543

If you are carrying the keyless operation key, enter the operating range of the keyless operation system, and press the driver's door switch, or the tailgate switch, the ID code for your key is verified. You can only lock and unlock the doors and tailgate, start the engine and change the operation mode if the ID codes of your keyless operation key and the vehicle match.

NOTE

- If the keyless operation key battery is wearing out or there are strong electromagnetic waves or noise present, the operating range may become smaller and operation may become unstable.

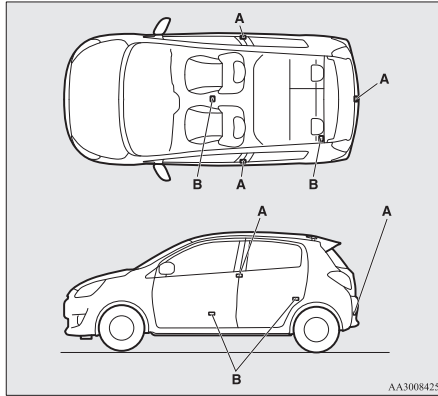

AA3008425

⚠ WARNING

- When using electro-medical devices other than implantable cardiac pacemakers or implantable cardiovascular-defibrillators, contact the electro-medical device manufacturer ahead of time to determine the affects of radio waves on the devices. Electro-medical device operations could be affected by radio waves.

You can limit the possible operations of the keyless operation system. Please consult a MITSUBISHI MOTORS Authorized Service Point for details.

NOTE

- The keyless operation key uses an ultra-weak electromagnetic wave. In the following ca-

ses, the keyless operation system may not operate properly or may be unstable.

- When there is equipment nearby that emits strong radio waves, such as: a power station, a radio/TV broadcasting station or an airport.
- The keyless operation system is carried together with a communications device such as a cellular phone or radio set, or with an electronic device such as a personal computer.
- The keyless operation key is touching or covered by a metal object.
- A keyless entry system is being used nearby.
- When the keyless operation key battery is worn out.
- When the keyless operation key is placed in an area with strong radio waves or noise. In such cases, use the emergency key. Refer to "To operate without using the keyless operation function" on page 1-07.
- Because the keyless operation key receives signals in order to communicate with the transmitters in the vehicle, the battery continually wears down regardless of keyless operation key use. The battery life is 1 to 3 years, depending on usage conditions. When the battery wears out, have it replaced a MITSUBISHI MOTORS Authorized Service Point.
- Because the keyless operation key continually receives signals, strong radio wave reception could affect battery wear. Do not leave the key near a TV, personal computer, or other electronic device.

Locking and unlocking

Operating range for locking and unlocking the doors and tailgate

E00306200529

The operating range is approximately 70 cm from the driver's door switch and the tailgate switch.

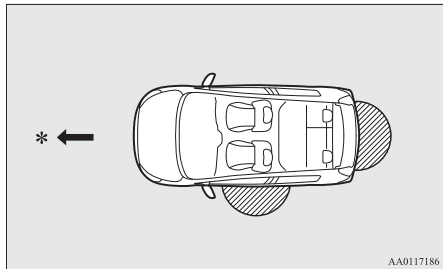

AA0117186

* : Forward direction

 : Operating range

NOTE

- Locking and unlocking are only possible when the door or tailgate is operated while the keyless operation key is being detected.
- Operation may not be possible if you are too close to the front door, door window, or tailgate.
- Even if the keyless operation key is within 70 cm of the driver's door switch or the tailgate switch, if the key is near to the ground or high up, the system may not operate.

- If the keyless operation key is within the operating range, even someone not carrying the key can lock and unlock the doors and tailgate by pressing the driver's door switch or the tailgate switch.

Operating range for starting the engine and changing the operation mode

E00306300272

The operating range is the interior of the vehicle.

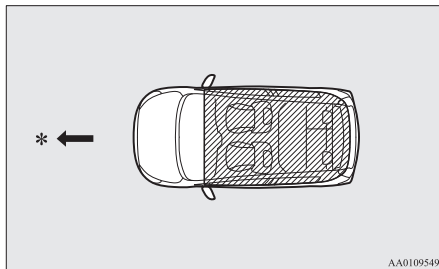

AA0109549

*: Forward direction

 : Operating range

NOTE

- Even if it is within the operating range, if the keyless operation key is in a small item holder such as the glove box, on top of the instrument panel, door pocket or in the luggage compartment, it may be impossible to start the engine and change the operation mode.
- If you are too close to the door or door window, the engine may start even though the keyless operation key is outside the vehicle.

To operate using the keyless operation function

E00305800977

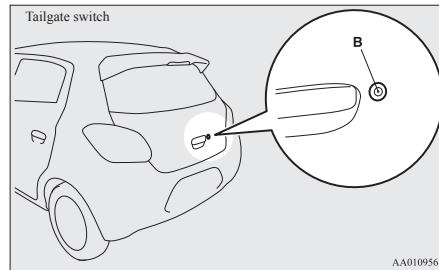
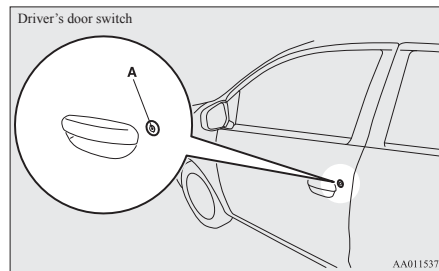

Locking the doors and tailgate

When you are carrying the keyless operation key, if you press the driver's door switch (A), or the tailgate switch (B) within the operating range, the doors and the tailgate are locked.

The turn-signal lamps will blink once and the outer buzzer will sound once.

Also refer to "Locking and unlocking: Doors, Central door locks, tailgate" on pages 1-12, 1-13 and 1-14.

To lock/unlock without using the keyless operation function

E00306000165

Emergency key

E00307200467

The emergency key (A) can only be used to lock and unlock the front passenger's door. To use the emergency key, unlock the lock knob (B) and remove it from the keyless operation key (C).

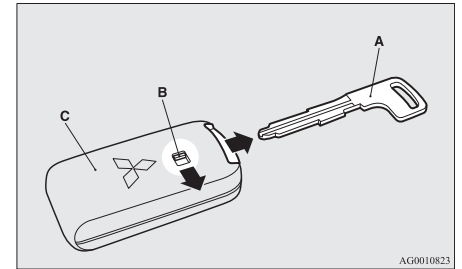

NOTE

- Only use the emergency key for emergencies. If the keyless operation key battery wears out, replace it as quickly as possible so that you can use the keyless operation key.
- The emergency key is built in the keyless operation key.
- After using the emergency key, always return it into the original position.

Unlocking the doors and tailgate

When you are carrying the keyless operation key, if you press the driver's door switch (A), or the tailgate switch (B) within the operating range, all the doors and tailgate are unlocked.

If the room lamp switch is in the middle (•) position at this time, the room lamp will turn on for 15 seconds. The turn-signal lamps will blink twice and the outer buzzer will sound twice.

If the driver's door switch is pressed and any of the doors or tailgate is not opened within approximately 30 seconds, relocking will automatically occur.

Refer to "Locking and unlocking: Doors, Central door locks, tailgate" on pages 1-12, 1-13 and 1-14.

NOTE

- The keyless operation function does not operate under the following conditions:
 - The keyless operation key is inside the vehicle.
 - A door or the tailgate is open or ajar.
 - The operation mode is not in OFF.
- The time between unlocking and automatic locking can be adjusted. Consult a MITSUBISHI MOTORS Authorized Service Point.

Operation confirmation when locking and unlocking

Operation can be confirmed as shown below. However, the room lamp will illuminate only if the room lamp switch is in the middle (•) position.

When locking:

The turn-signal lamps blink once and the outer buzzer sounds once.

When unlocking:

The room lamp illuminates for approximately 15 seconds, the turn-signal lamps blink twice, and the outer buzzer sounds twice.

NOTE

- Functions can be modified as stated below. For further information, please contact a MITSUBISHI MOTORS Authorized Service Point.
 - Activating the operation confirmation function (blinking of the turn-signal lamps) only during locking, or only during unlocking.
 - Disabling the operation confirmation function (blinking of the turn-signal lamps) and outer buzzer.
 - Changing the number of blinks for the operation confirmation function (blinking of the turn-signal lamps).

Locking and unlocking

Locking and unlocking the front passenger's door

Turning the emergency key in the forward direction locks the door, and turning it in the rear direction unlocks the door. Also refer to “Locking and unlocking: Doors” on page 1-12.

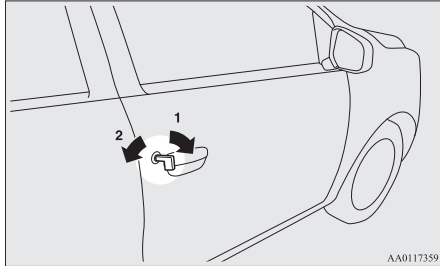

- 1- Lock
- 2- Unlock

Warning activator

In order to prevent vehicle theft or the accidental operation of the keyless operation system, the lamp and buzzer are used to alert the driver.

Lamp 	Buzzer	Item	Cause	Note (Solution)
Blinks	Outer buzzer sounds 4 times. Inner buzzer sounds.	Keyless operation key take-out monitoring system	When the vehicle is parked with the operation mode in any mode other than OFF, if you close the door after opening any of the doors and taking the keyless operation key out of the vehicle.	<ul style="list-style-type: none"> ● If you take the keyless operation key out of the vehicle through a window without opening a door, this system does not operate. ● It is possible to change the setting to make the system operate if you take the keyless operation key out from the vehicle through a window without opening a door. For further information, please contact a MITSUBISHI MOTORS Authorized Service Point. ● Even if you have the keyless operation key within the engine start operating range, if the key and vehicle ID codes cannot be matched, for example due to the ambient environment or electromagnetic conditions, the warning may be activated.
Blinks	Outer buzzer sounds approximately 3 seconds	Key lock-in prevention system	When the operation mode is in OFF, if you close all the doors and the tailgate with the keyless operation key left in the vehicle and you try to lock the doors and tailgate by pressing the driver's switch, or the tailgate switch.	Make sure you have the keyless operation key with you before locking the doors. Even if you leave the keyless operation key inside the vehicle, it is possible that the doors will lock depending on the surrounding environment and wireless signal conditions.
Blinks	Outer buzzer sounds approximately 3 seconds	Door ajar prevention system	When the operation mode is in OFF, if you try to lock the doors and tailgate by pressing the driver's door switch, or the tailgate switch with one of the doors or the tailgate not completely closed.	—

Locking and unlocking

Lamp 	Buzzer	Item	Cause	Note (Solution)
Blinks	No sounds	Keyless operation system	The battery in the keyless operation key has worn out.	Replace the battery as soon as possible at a MITSUBISHI MOTORS Authorized Service Point.
Illuminates			There is a fault in the keyless operation system.	If the warning lamp illuminates, please contact a MITSUBISHI MOTORS Authorized Service Point.
			There is a fault in the electrical system.	
	Inner buzzer sounds (intermittent sounds)			Immediately stop the vehicle in a safe place and contact a MITSUBISHI MOTORS Authorized Service Point.
	Inner buzzer sounds (continuous sounds)			
Blinks	Outer buzzer sounds approximately 3 seconds Inner buzzer sounds approximately 1 minute.	Keyless operation key reminder	When the operation mode is in OFF with the keyless operation key left in the key slot, if you try to open the driver's door.	Remove the keyless operation key from the key slot. Refer to "Starting" on page 4-12.
Illuminates	Inner buzzer sounds	Steering wheel lock	There is a fault in the steering wheel lock system.	Refer to "Steering wheel lock" on page 4-11.
Blinks	Outer buzzer sounds approximately 3 seconds	Operation mode OFF reminder system	When the operation mode is in any mode other than OFF with all the doors and the tailgate are closed, if you try to lock by using the driver's door switch or the tailgate switch.	Refer to "Operation mode OFF reminder system" on page 4-10.

Lamp 	Buzzer	Item	Cause	Note (Solution)
Illuminates	No sounds	Immobilizer system	There is a fault in the electronic immobilizer (Anti-theft starting system).	Put the operation mode in OFF and then start the engine again. If the warning is not cancelled, contact a MITSUBISHI MOTORS Authorized Service Point.

Lamp 	Buzzer	Item	Cause	Note (Solution)
Blinks	Inner buzzer sounds	Steering wheel lock	Steering wheel does not unlock.	Unlock the steering wheel lock following the procedure of reference page. Refer to “Steering wheel lock” on page 4-11.
Illuminates	No sounds		Steering wheel lock is abnormal.	Refer to “Steering wheel lock” on page 4-11.

Locking and unlocking

Doors

E00300402334

CAUTION

- Make sure the doors are closed: driving with doors not completely closed is dangerous.
- Never leave children in the vehicle unattended.
- Be careful not to lock the doors while the key is inside the vehicle.

To lock or unlock with the key

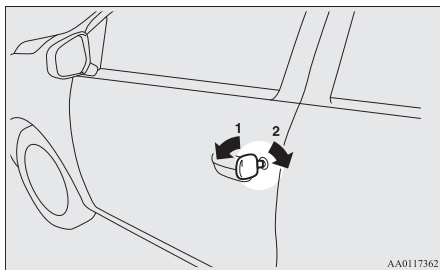

- 1- Lock
- 2- Unlock

To lock or unlock from inside the vehicle

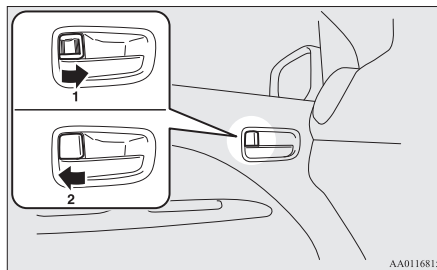

- 1- Lock
- 2- Unlock

NOTE

- The driver's door can be opened without using the lock knob by pulling on the inside door handle.

To lock without using the key

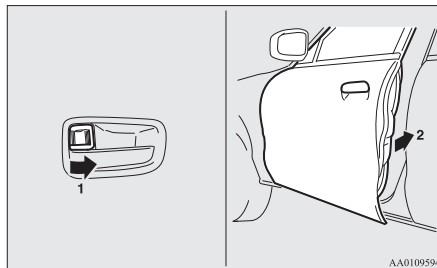

Set the inside lock knob (1) to the locked position, and close the door (2).

NOTE

- The driver's door cannot be locked using the inside lock knob while the driver's door is opened.

Ignition key reminder*

E00300500126

Except for vehicles equipped with the keyless operation system

If the ignition switch is turned off and the driver's door is opened with the key in the ignition switch, the key reminder buzzer will sound intermittently to remind you to remove the key.

“Forgotten-key-prevention” mechanism*

E00300600329

If the key is in the ignition switch or the operation mode is other than OFF, when you push the lock knob forward with the driver's door open, the lock knob will automatically return to the unlocked position.

Central door locks*

E00300801995

NOTE

- Repeated continuous operation between lock and unlock could activate the central door locking systems built-in protection circuit and prevent the system from operating. If this occurs, wait approximately 1 minute before operating the central door lock system.

All of the doors and the tailgate can be locked and unlocked as described hereafter.

Driver's door with key (except for vehicles with keyless operation system)

Using the key on the driver's door locks or unlocks.

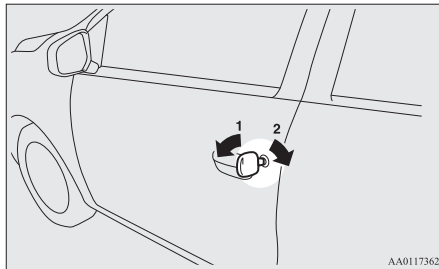

- 1- Lock
- 2- Unlock

Driver's door with inside lock knob

Using the door lock knob on the driver's door locks or unlocks all doors and the tailgate.

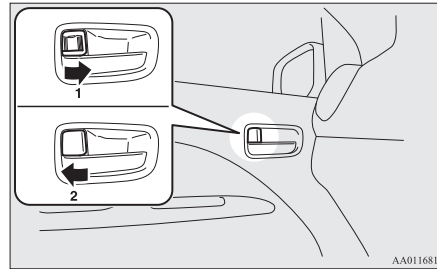

- 1- Lock
- 2- Unlock

NOTE

- Be careful not to lock the doors while the key is inside the vehicle when getting off the vehicle.

Using the selector lever position (CVT)

On vehicles with the keyless entry system or the keyless operation system, it is possible to unlock all of the doors and the tailgate using the selector lever by placing the selector lever in the "P" (PARK) position while the ignition switch or the operation mode is in the "ON" position.



NOTE

- The vehicle is shipped from the factory with a setting established such that the doors and the tailgate are not unlocked when the selector lever is placed in the "P" (PARK) position with the ignition switch in the "ON" position. If you wish to change the setting such that the doors are unlocked, please contact a MITSUBISHI MOTORS Authorized Service Point.

Locking and unlocking

“Child-protection” rear doors

E00300901039

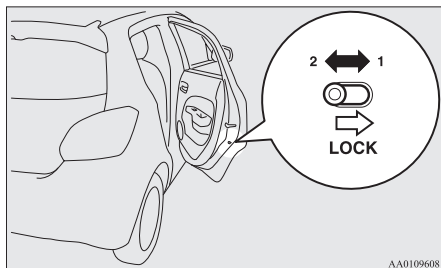

- 1- Lock
2- Unlock

Child protection helps prevent doors from being opened accidentally, especially when small children are in the rear seat.

A lever is provided on each rear door.

If the lever is set to the locked position, the rear door cannot be opened using the inside handle.

To open the rear door while the child protection is in use, pull the outside door handle.

If the lever is set to the “Unlock” position, the child protection mechanism does not function.

CAUTION

- When driving with a child in the rear seat, please use the child protection to prevent accidental door opening which may cause an accident.

Tailgate

E00301401275

WARNING

- It is dangerous to drive with the tailgate open, since carbon monoxide (CO) gas can enter the cabin. You cannot see or smell CO. It can cause unconsciousness and even death.
- When opening and closing the tailgate, make sure that there are no people nearby and be careful not to hit your head or pinch your hands, neck, etc.

NOTE

- Locking/unlocking with the inside lock knob of the driver's door, the keyless entry system or the keyless operation function also locks/unlocks the tailgate.

To open

After unlocking the tailgate, pull the tailgate handle upward to open.

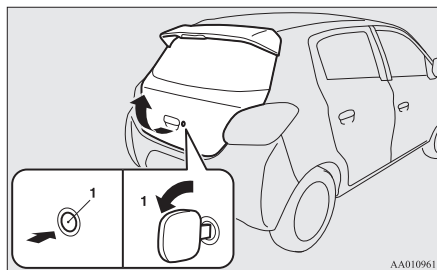

- 1- Unlock

CAUTION

- Make sure there is no one standing nearby when opening the tailgate.

To close

Pull the tailgate grip (A) downward as illustrated. Gently push the tailgate from the outside with enough force so that it is completely closed. Always ensure the tailgate is securely closed.



CAUTION

- When closing the tailgate, always ensure your or other person's fingers cannot be caught by the tailgate.
- Before driving, make sure that the tailgate is securely closed. If the tailgate opens while driving the vehicle, objects stored in the luggage compartment could fall out onto the road.

NOTE

- Gas struts (B) are installed to support the tailgate. To prevent damage or faulty operation,
 - Do not hold the gas struts when closing the tailgate.
 - Also, do not push or pull the gas struts.
 - Do not attach any plastic material, tape, etc., to the gas struts.
 - Do not tie string, etc., around the gas struts.
 - Do not hang any object on the gas struts.

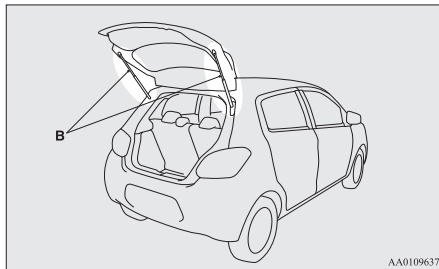

Manual window control*

E00302100096

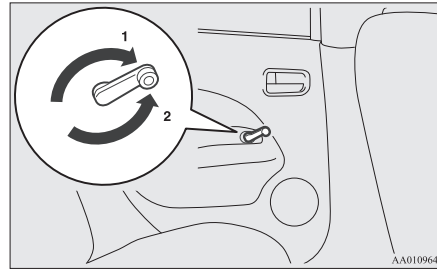

- 1- To open
- 2- To close

Electric window control*

E00302200576

The electric windows can only be operated with the ignition switch or the operation mode in ON.

Electric window control switch

E00302301893

Each door window opens or closes while the corresponding switch is operated.

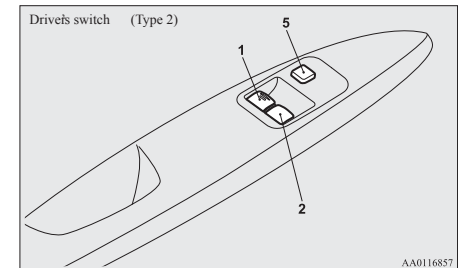
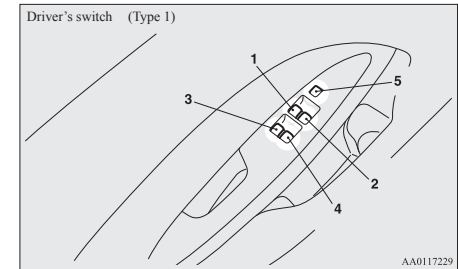

Locking and unlocking

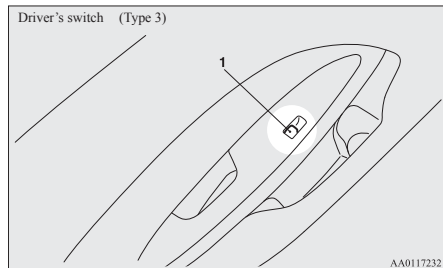

- 1- Driver's door window
- 2- Front passenger's door window
- 3- Rear left door window
- 4- Rear right door window
- 5- Lock switch

A WARNING

- Before operating the electric window control, make sure that nothing can get trapped (head, hand, finger, etc.).
- Never leave the vehicle without removing the key.
- Never leave a child (or other person who might not be capable of safe operation of the electric window control) in the vehicle alone.

Driver's switches

Type 1

The driver's switches can be used to operate all door windows.

A window can be opened or closed by operating the corresponding switch.

Press the switch down to open the window, and pull up the switch to close it.

If the switch for the driver's window is fully pressed down/pulled up, the door window automatically opens/closes completely.

If you want to stop the window movement, operate the switch lightly in the reverse direction.

Type 2

The driver's switches can be used to operate front door windows. Press the switch down to open the window, and pull up the switch to close it.

If the switch for the driver's window is fully pressed down, the door window automatically opens completely.

If you want to stop the window movement, operate the switch lightly in the reverse direction.

Type 3

Press the switch down for opening the window, and pull up the switch for closing it.

Passenger's switches*

The passenger's switches can be used to operate the corresponding passenger's door windows.

Press the switch down for opening the window, and pull up the switch for closing it.

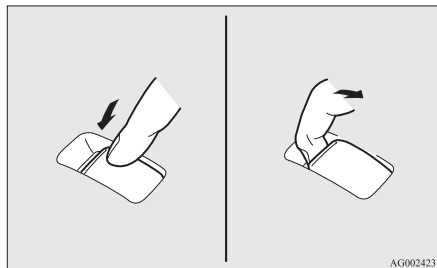

NOTE

- Repeated operation with the engine stopped will run down the battery. Operate the window switches only while the engine is running.
- The rear door windows only open halfway.

Lock switch (Type 1 and 2)

E00303101292

When this switch is operated, the passenger's switches cannot be used to open or close the door windows and the driver's switch cannot open or close any door windows other than the driver's door window.

To unlock, press it once again.

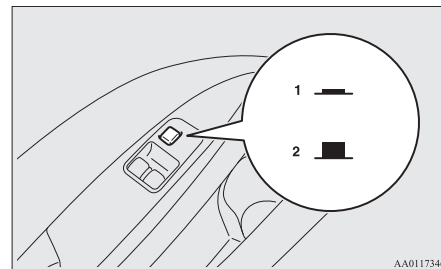

- 1- Lock
- 2- Unlock

⚠ WARNING

- A child may tamper with the switch at the risk of its hands or head being trapped in the window. When driving with a child in the vehicle, please press the window lock switch to disable the passenger's switches.

Timer function

E00302401041

The door windows can be opened or closed for 30 seconds after the engine is stopped.

However, once the driver's door or the front passenger's door is opened, the windows cannot be operated.

Safety mechanism (driver's window of Type 1 only)

E00302500827

If a hand or head is trapped in the closing window, it will lower automatically.

Nonetheless, make sure that nobody puts their head or hand out of the window when closing the driver's door window.

The lowered window will become operational after a few seconds.

⚠ WARNING

- If the battery terminals are disconnected or the fuse for electric window is replaced, the safety mechanism will be cancelled.
If a hand or head got trapped, a serious injury could result.

⚠ CAUTION

- The safety mechanism is cancelled just before the window is fully closed. This allows the window to close completely. Therefore be especially careful that no fingers are trapped in the window.
- The safety mechanism is deactivated while the switch is pulled up. Therefore be especially careful that fingers are not trapped in the door window opening.

NOTE

- The safety mechanism can be activated if the driving conditions or other circumstances cause the driver's door window to be subjected to a physical shock similar to that caused by a trapped hand or head.
- If the battery terminals are disconnected or the fuse for electric window is replaced, the safety mechanism will be cancelled and the door window will not automatically open/close completely.
If the window is open, repeatedly raise the driver's door window switch until the window has been fully closed. Following this, release the switch, raise the switch once again and hold it in this condition for at least 1 second, then release it. You should now be able to operate the driver's door window in the normal fashion.

A series of 15 horizontal dashed lines spanning the width of the page, providing a template for writing.

Seat and seat belts

Seat adjustment.....	2-02
Front seat.....	2-02
Rear seat.....	2-03
Head restraints.....	2-04
Seat belts.....	2-05
Pregnant women restraint.....	2-08
Seat belt pretensioner system and force limiter system.....	2-08
Child restraint.....	2-09
Seat belt inspection.....	2-17
Supplemental restraint system (SRS) - airbag.....	2-17

Seat adjustment

E00400300558

Adjust the driver's seat so that you are comfortable and that you can reach the pedals, steering wheel, switches etc. while retaining a clear field of vision.

A WARNING

- Do not attempt to adjust the seat while driving. This can cause loss of vehicle control and result in an accident. After adjustments are made, ensure the seating is locked in position by attempting to move the seat forward and rearward without using the adjusting mechanism.
- Do not allow people or children to ride in any area of your vehicle that is not equipped with seats and seat belts, and make sure that everyone travelling in your vehicle is in a seat and wearing a seat belt, or in the case of a child is strapped in a child restraint.
- To minimize the risk of personal injury in the event of a collision or sudden braking, the seatbacks should always be in the almost upright position while the vehicle is in motion. The protection provided by the seat belts may be reduced significantly when the seatback is reclined. There is greater risk that the passenger will slide under the seat belt, resulting in serious injury, when the seatback is reclined.

A CAUTION

- Make sure the seat is adjusted by an adult or with adult supervision for correct and safe operation.
- Do not place a cushion or the like between your back and the seatback while driving. The effectiveness of the head restraints will be reduced in the event of an accident.
- When sliding the seats, be careful not to catch your hand or foot.

Front seat

E00400400230

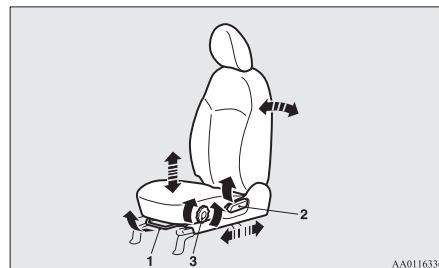

- 1- To adjust forward or backward
Lift the handle and adjust the seat to the desired position, and release the handle.
- 2- To recline the seatback
Pull the lever up and then lean backward to the desired position, and release the lever.
- 3- To adjust seat cushion height (driver's side only)*
Turn the dial and adjust the seat cushion height to the desired position.

A CAUTION

- The reclining mechanism of the seatback is spring loaded, causing it to return to the vertical position when the lock lever is operated. When using the lever, sit close to the seatback or hold it with your hand to control its return motion.

Heated seats*

E00401101130

The heated seats can be operated with the ignition switch or the operation mode is in ON. Operate the switch as indicated by arrows. The indication lamp (A) will illuminate while the heater is on.

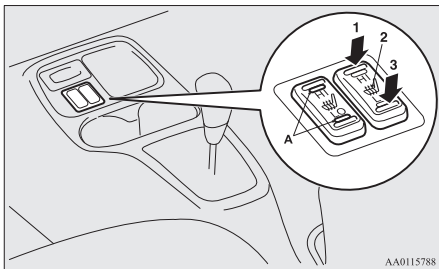

AA0115788

- 1 (HI) - Heater high (for quick heating).
 2 - Heater off.
 3 (LO) - Heater low (to keep the seat warm).

A CAUTION

- Operate in the high position for quick heating. Once the seat is warm, set the heater to low to keep it warm. Slight variations in seat temperature may be felt while using the heated seats. This is caused by the operation of the heater's internal thermostat and does not indicate a malfunction.
- If the following types of persons use the heated seats, they might become too hot

A CAUTION

or receive minor burns (red skin, heat blisters, etc.):

- Children, elderly or ill people
 - People with sensitive skin
 - Excessively tired people
 - People under the influence of alcohol or sleep inducing medication (cold medicine, etc.)
- Do not place heavy objects on the seat or stick pins, needles, or other pointed objects into it.
 - Do not use a blanket, cushion, or other material with high heat insulation properties on the seat while using the heater; this might cause the heater element to overheat
 - Do not use benzine, kerosene, petrol, alcohol or other organic solvents when cleaning the seats. Doing so could damage not only the seat cover, but also the heater element.
 - If water or any other liquid is spilled on the seat, allow it to dry thoroughly before attempting to use the heater.
 - Turn the heater off immediately if it appears to be malfunctioning during use.

Rear seat

E00401300018

Folding the seatbacks forward

E00401600428

The passenger and luggage compartments can be joined by folding the rear seatback forward. This is useful for carrying long objects.

To fold

1. If your vehicle is equipped with head restraints, place each head restraint in its lowest position. (Refer to "Head restraints" on page 2-04.)
2. Pull the left or right release bands (A), and fold the rear seatbacks forward.

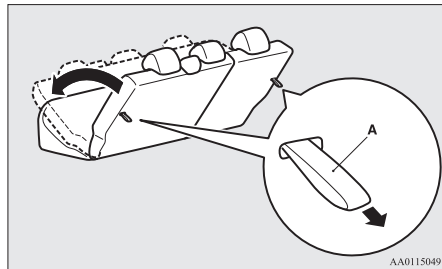

AA0115049

3. Store the seat belt plate of the outboard seating position. (Refer to "Rear seat belt storage" on page 2-07.)

To return

1. Confirm that the seat belt plate of the outboard seating position is stored.

Seat and seat belts

2. Raise the seatbacks until it locks securely into place.
Push lightly on the seatbacks to confirm that it has actually been secured.

Head restraints

E00403301644

WARNING

- Driving without the head restraints in place can cause you and your passengers serious injury or death in an accident. To reduce the risk of injury in an accident, always make sure the head restraints are installed and properly positioned when the seat is occupied.
- Never place a cushion or similar device on the seatback. This can adversely affect head restraint performance by increasing the distance between your head and the restraint.
- When a person sits in the rear seat, pull up the head restraint to a height at which it locks in position. Be sure to make this adjustment before starting to drive. Serious injuries could otherwise be suffered as the result of an impact.

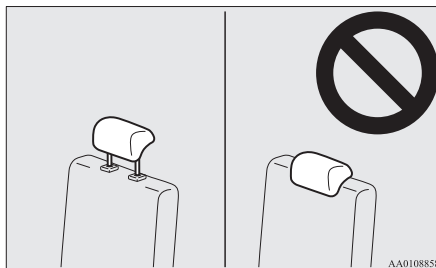

To adjust height

Adjust the head restraint height so that the centre of the restraint is as close as possible to ear level to reduce the chances of injury in the event of collision. Any person too tall for the restraint to reach their seated ear level, should adjust the restraint as high as possible.

To raise the head restraint, move it upward. To lower the restraint, move it downward while pushing the height adjusting knob (A) in the direction of the arrow. After adjustment, push the head restraint downward and make sure that it is locked.

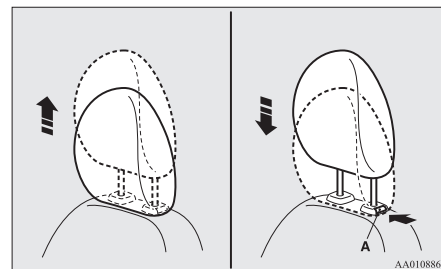

To remove

Lift the head restraint with the height adjusting knob (A) pushed in.

To install

Confirm that the head restraint is facing the correct direction, and then insert it into the seatback while pressing the height adjusting knob (A) in the direction indicated by the arrow.

The head restraint stalk with the adjustment notches (B) must be installed in the hole with the adjustment knob (A).

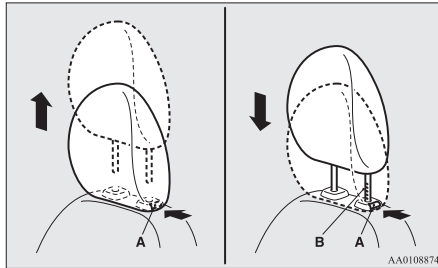

CAUTION

- Confirm that the height adjusting knob (A) is correctly adjusted as shown in the illustration, and also lift the head restraints to ensure that they do not come out of the seatback.

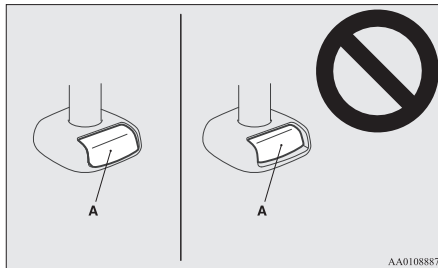

CAUTION

- The shape and size of the head restraint differs according to the seat. Always use the correct head restraint provided for the seat and do not install the head restraint in the wrong direction.

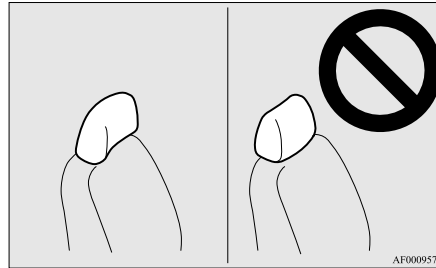

Seat belts

E00404800883

To protect you and your passengers in the event of an accident, it is most important that the seat belts are worn correctly while driving.

The front seat belt have a pretensioner system.

These belts are used the same way as a conventional seat belt.

Refer to “Seat belt pretensioner system and force limiter system” on page 2-08.

WARNING

- Seat belts should always be worn by every adult who drives or rides in this vehicle, and by all children who are tall enough to wear seat belts properly. Other children should always use proper child restraint systems.
- Always place the shoulder belt over your shoulder and across your chest. Never put it behind you or under your arm.
- One seat belt should be used by only one person. Doing otherwise can be dangerous.
- The seat belt will provide its wearer with maximum protection if the recliner seatback is placed in fully upright position. When the seatback is reclined, there is greater risk that the passenger will slide under the belt, especially in a forward impact accident, and may be injured by the belt or by striking the instrument panel or seatbacks.
- Remove any twists when using the belt.

Seat and seat belts

⚠ WARNING

- No modifications or additions should be made by the user which will either prevent the seat belt adjusting devices from operating to remove slack, or prevent the seat belt assembly from being adjusted to remove slack.
- Never hold a child in your arms or on your lap when riding in this vehicle, even if you are wearing your seat belt. To do so risks severe or fatal injury to the child in a collision or sudden stop.
- Always adjust the belt to a snug fit.
- Always wear the lap portion of the belt over your hips.

3-point type seat belt (with emergency locking mechanism)

E00404901155

This type of belt requires no length adjustment. Once worn, the belt adjusts itself to the movement of the wearer, but in the event of a sudden or strong shock, the belt automatically locks to hold the wearer's body.

NOTE

- You can check if the belt locks by pulling it forward quickly.

To fasten

1. Pull the seat belt out slowly while holding the latch plate.

NOTE

- When the seat belts cannot be pulled out in a locked condition, pull the belts once forcefully and then return them. After that, pull the belts out slowly once again.
2. Insert the latch plate into the buckle until a "click" is heard.

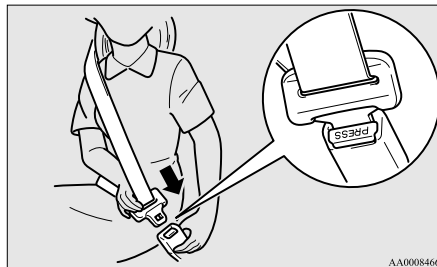

⚠ WARNING

- Never wear the lap portion of the belt across your abdomen. During accidents it can press sharply against the abdomen and increase the risk of injury.
- The seat belts must not be twisted when worn.

3. Pull the belt slightly to adjust slackness as desired.

To unfasten

Hold the latch plate and push the button on the buckle.

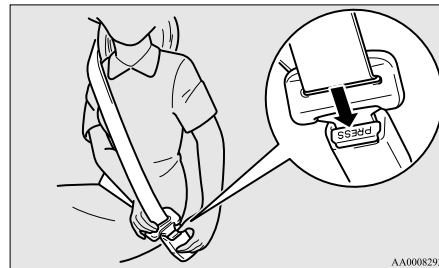

NOTE

- As the belt retracts automatically, keep holding the latch plate while retracting so that the belt stows slowly. Failure to do this could damage the vehicle.

Seat belt reminder

E00409800947

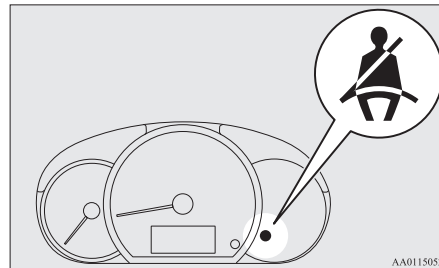

If the ignition switch is turned to the “ON” position or the operation mode is put in ON while a seat belt is not fastened, the warning lamp comes on and the tone sounds for about 6 seconds to remind the driver and the front passenger to fasten the seat belt.

If the vehicle is driven with the seat belt still unfastened, the warning lamp will blink and the tone will sound intermittently until the seat belt is fastened.

NOTE

- If the seat belt subsequently remains unfastened, the warning lamp and the tone will issue further warnings each time the vehicle starts moving from a stop.
- For the front passenger seat, the warning function works only while a person is sitting on the seat.
- When luggage is placed on the front passenger seat, a sensor in the seat cushion may, depending on the weight and position of the luggage, cause the warning tone to sound and the warning lamp to come on.

Adjustable seat belt anchor (front seats)*

E00405000563

The seat belt anchor height can be adjusted.

To move the anchor, pull the lock knob (A) and slide the anchor to the desired position. Release the lock knob to lock the anchor into position.

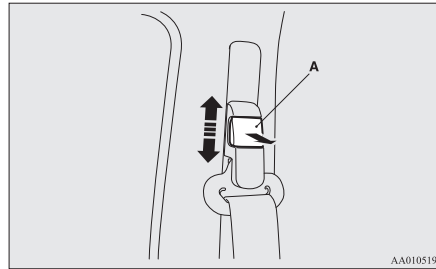

AA0105192

⚠ WARNING

- **When adjusting the seat belt anchor, set it at a position that is sufficiently high so that the belt will make full contact with your shoulder but will not touch your neck.**

Rear seat belt storage

E00405400059

When folded the rear seatbacks forward, store the seat belts as shown in the illustration.

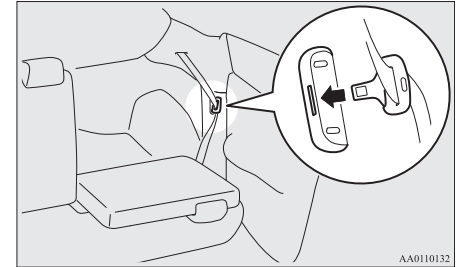

AA0110132

Pregnant women restraint

E00405600064

WARNING

- Seat belts work for everyone, including pregnant women. Pregnant women should use the available seat belts. This will reduce the likelihood of injury to both the woman and the unborn child. The lap belt should be worn across the thighs and as snug against the hips as possible, but not across the waist. Consult your doctor if you have any additional questions or concerns.

Seat belt pretensioner system and force limiter system

E00405700166

The driver's seat and front passenger's seat each have a seat belt equipped with a pretensioner system.

Pretensioner system

E00405801249

When the ignition switch or the operation mode is under the following conditions, if there is a frontal impact severe enough to injure the and/or front passenger, the pretensioner system will retract their respective seat belts instantaneously, thus maximizing the seat belt's effectiveness.

[Except for vehicles equipped with keyless operation system]

The ignition switch is in the "ON" or "START" position.

[Vehicles equipped with keyless operation system]

The operation mode is in ON.

WARNING

- To obtain the best results from your pretensioner seat belt, make sure you have adjusted your seat correctly and wear your seat belt properly.

CAUTION

- Installation of audio equipment or repairs in the vicinity of the pretensioner seat belts or floor console must be performed in line with MITSUBISHI MOTORS guidelines. It is important to do so because the work could affect the pretensioner systems.

CAUTION

- If you need to scrap the vehicle, please consult a MITSUBISHI MOTORS Authorized Service Point. It is important to do so because unexpected activation of the pretensioner seat belts could cause injuries.

NOTE

- The pretensioner seat belts will be activated if the vehicle suffers a severe frontal impact, even if the seat belts are not worn.
- The pretensioner seat belts are designed to work only once. After the pretensioner seat belts have been activated, we recommend you have them replaced by a MITSUBISHI MOTORS Authorized Service Point.

SRS warning lamp

E00405900083

This warning lamp is shared by the SRS airbags and the pretensioner seat belts.

Refer to "SRS warning lamp" on page 2-25.

Force limiter system

E00406000153

In the event of a collision, each force limiter system will effectively absorb the load applied to the seat belt to minimize the impact to the passenger.

Child restraint

E00406401835

When transporting children in your vehicle, some type of child restraint system should always be used according to the size of the child. This is required by law in most countries.

The regulations concerning driving with children in the front seat may differ from country to country. You are advised to comply with the relevant regulations.

▲ WARNING

- When possible, put children in the rear seat. Accident statistics indicate that children of all sizes and ages are safer when properly restrained in the rear seat rather than in the front seat.
- Holding a child in your arms is no substitute for a restraint system. Failure to use a proper restraint system can result in severe or fatal injury to the child.
- Each child restraint device or fixing is to be used only by one child.
- When attaching a child restraint system to the rear seat, prevent the front seat-backs from touching the child restraint system. Otherwise, the child could be seriously injured in the event of hard braking or a collision.

Caution for installing the child restraint on vehicles with a front passenger airbag

E00406500510

The label shown here is attached on vehicles with a front passenger airbag.

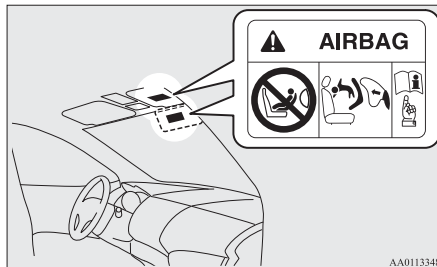

▲ WARNING

- **Extreme Hazard!**
NEVER use a rearward facing child restraint on a seat protected by an ACTIVE AIRBAG in front of it, DEATH or SERIOUS INJURY to the CHILD can occur.

Seat and seat belts

Use rearward facing child restraints in the rear seat or turn off the front passenger's airbag ON-OFF switch. (Refer to "To turn an airbag off" on page 2-19)

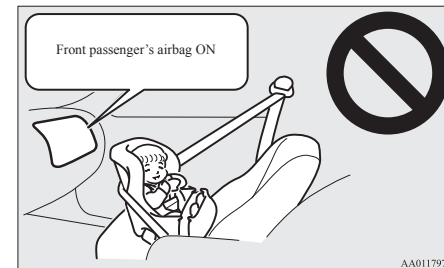

▲ WARNING

- A REARWARD FACING CHILD RESTRAINT must NOT be used in the front passenger seat if the front passenger's airbag has not been deactivated. The force of an inflating airbag could kill or cause serious injuries to the child. A rearward facing child restraint should be used in the rear seat.
- A FORWARD FACING CHILD RESTRAINT should be used in the rear seat whenever possible; if it must be used in the front passenger seat, turn off the front passenger's airbag ON-OFF switch. Failure to do so could kill or cause serious injuries to the child.

Seat and seat belts

Infants and small children

E00406600872

When transporting infants and small children in your vehicle, follow the instruction given below.

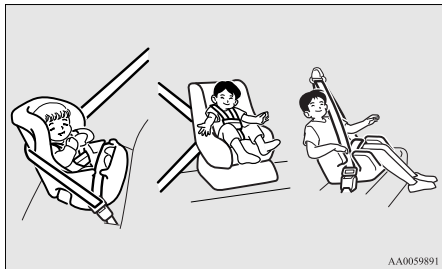

Instruction:

- For small infants, an infant carrier should be used. For small children whose height when seated allows the shoulder belt to lie in contact with the face or the throat, a child seat should be used.
- The child restraint system should be appropriate for the child's weight and height and properly fit in the vehicle. For a higher degree of safety: **THE CHILD RESTRAINT SYSTEM SHOULD BE INSTALLED IN THE REAR SEAT.**

- Before purchasing a child restraint system, try installing it in the rear seat to make sure there is a good fit. Because of the location of the seat belt buckles and the shape of the seat cushion, it may be difficult to securely install some manufacturer's child restraint systems. If the child restraint system can be pulled forward or to either side easily on the seat cushion after the seat belt has been tightened, choose another manufacturer's child restraint system.

⚠ WARNING

- **When installing a child restraint system, refer to the instructions provided by the manufacturer of the restraint system. Failure to do so can result in severe or fatal injury to the child.**
- **After installation, push and pull the child restraint system back and forth, and side to side, to see that it is properly secured. If the child restraint system is not installed securely, it may cause injury to the child or other occupants in the case of accident or sudden stops.**
- **When the child restraint system is not in use, keep your child restraint system secured with the seat belt or remove it from the vehicle in order to prevent it from being thrown around inside the vehicle during an accident.**

NOTE

Depending on the seating position in the vehicle and the child restraint system that you

have, the child restraint can be attached using one of the following two locations:

- To the lower anchorage in the rear seat, **ONLY** if the child restraint has ISOFIX mountings (See page 2-15).
- To the seat belt (See 2-16).

Older children

E00406700310

Children who have outgrown the child restraint system should be seated in the rear seat and wear combination lap shoulder belt.

The lap portion of the belt should be snug and positioned low on the abdomen so that it is below the top of the hip-bone. Otherwise, the belt could intrude into the child's abdomen during an accident and cause injury.

Suitability for various ISOFIX positions

Mass group	Size class	Fixture	Vehicle ISOFIX positions	Recommended Child Restraint System*1	ECE No.
			Rear (Left side/Right side)		
Carycot	F	ISO/L1	X	—	—
	G	ISO/L2	X	—	—
0 - Up to 10 kg	E	ISO/R1	X	—	—
0+ - Up to 13 kg	E	ISO/R1	IL	BABY-SAFE plus: MZ314393 BABY-SAFE ISOFIX BASE: MZ314394	E1-04301146
	D	ISO/R2	IL	G 0/1 S (Child restraint system for East area): MZ314390E G 0/1 S (Child restraint system for Central-South area): MZ314390CS	E4-04443718
	C	ISO/R3	IL		
I - 9 to 18 kg	D	ISO/R2	IL	0/1 S (Child restraint system for North area): MZ314390N RWF ISOFIX BASE (Rearward facing ISOFIX base for ALL area): MZ314417	—
	C	ISO/R3	IL		
	B	ISO/F2	IUF		
	B1	ISO/F2X	IUF, IL	DUO plus: MZ313045	E1-04301133
	A	ISO/F3	IUF	—	—
	II - 15 to 25 kg			X	—
III - 22 to 36 kg			X	—	—

*1: MITSUBISHI MOTORS Europe B.V. reserves the right to changes without prior announcement.
For further information, please contact a MITSUBISHI MOTORS Authorized Service Point.

 **CAUTION**

- When installing a child restraint system, remove the head restraint from the seat.

Definition of characters the above table:

- IUF- Suitable for ISOFIX forward child restraint systems of universal category approved for use in the mass group.
- IL- Suitable for particular ISOFIX child restraint systems of the categories for “specific vehicles”, “restricted”, or “semi-universal”, approved for this type of vehicle.
- X- ISOFIX position not suitable for ISOFIX child restraint systems in this mass group.

Suitability for various seating positions

Mass group	Seating position				Recommended Child Restraint System*2	ECE No.
	Front passenger		Rear			
	Activated airbag	Deactivated Air-bag*1	Left side/Right side	Centre		
0 - Up to 10 kg	X	U	U	X	—	—
0+ - Up to 13 kg	X	U, L	U, L	X	BABY-SAFE plus: MZ314393	E1-04301146
I - 9 to 18 kg	X	U, L	U, L	X	KING plus: MZ314451	E1-04301203
					DUO plus: MZ313045	E1-04301133
					G 0/1 S (Child restraint system for East area): MZ314390E G 0/1 S (Child restraint system for Central-South area): MZ314390CS G 0/1 S (Child restraint system for North area): MZ314390N	E4-03443416
II - 15 to 25 kg	X	U, L	U, L	X	KID plus: MZ314250	E1-04301169
III - 22 to 36 kg	X	U	U	X		

*1: With front passenger's airbag deactivated by means of front passenger's airbag ON-OFF switch

*2: MITSUBISHI MOTORS Europe B.V. reserves the right to changes without prior announcement.

For further information, please contact a MITSUBISHI MOTORS Authorized Service Point.

CAUTION

- When installing a child restraint system, remove the head restraint from the seat.
- When installing a child restraint system on the front passenger seat, adjust the front seatback angle to 2 steps rearward from the first locking position.

Seat and seat belts

Key of characters to be inserted in the table above:

- U- Suitable for “universal” category restraints approved for use in this mass group.
- L- Suitable for particular child restraint systems. See the above table of “Recommended Child Restraint Systems”.
- X- Seat position not suitable for children in this mass group.

Installing a child restraint system to the lower anchorage (ISOFIX child restraint mountings) and tether anchorage

E00408900882

Lower anchorage location

Your vehicle's rear seat is fitted with lower anchorages for attaching a child restraint system with ISOFIX mountings.

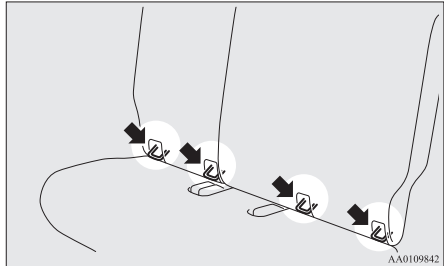

Tether anchorage locations

There are 2 attachment points located on the back of the rear seatbacks. These are for securing a child restraint system tether strap to each of the 2 rear seating positions in your vehicle.

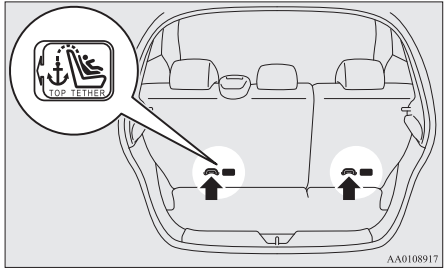

⚠ WARNING

- Child restraint anchorages are designed to withstand only those loads imposed by correctly fitted child restraints. Under no circumstances are they to be used for adult seat belts, harnesses, or for attaching other items or equipment to the vehicle.

Child restraint system with ISOFIX mountings

The child restraint system is designed only for seats that incorporate lower anchorages. Retain the child restraint system using the lower anchorages.

It is not necessary to retain the child restraint system using the vehicle's seat belts.

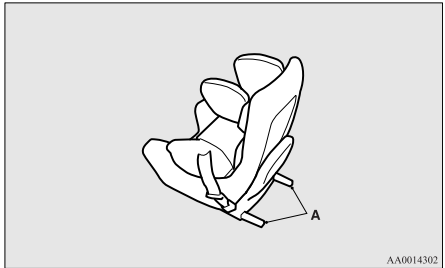

A- Child restraint system connectors

Installation:

1. Remove any foreign material in or around the connectors and ensure the vehicle seat belt is in its normal storage position.
2. Remove the head restraint from the location in which you wish to install a child restraint. Refer to "Head restraints" on page 2-04.
3. Open the gap a little between the seat cushion (A) and the seatback (B) with your hand to locate the lower anchorages (C).
4. Push the child restraint system's connectors (D) into the lower anchorages (C) in accordance with the instructions provided by the child restraint system's manufacturer.

Seat and seat belts

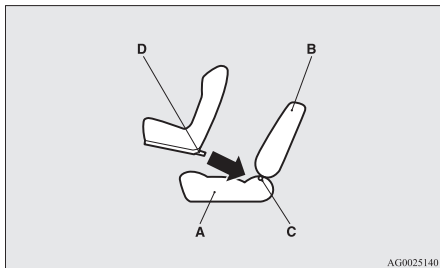

- 2
- A- Vehicle seat cushion
 - B- Vehicle seatback
 - C- Lower anchorage
 - D- Connector

If your child restraint system requires the use of a tether strap, fasten the tether strap in accordance with step 5.

5. Latch the top tether strap hook (E) of the child restraint system to the tether anchorage bracket (F) and tighten the top tether strap so it is securely fastened.

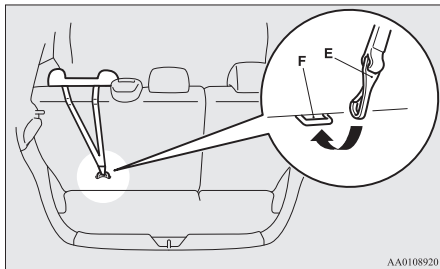

6. Push and pull the child restraint system in all directions to be sure it is firmly secured.

Installing a child restraint system to a 3-point type seat belt (with emergency locking mechanism)

E00407100702

Installation:

1. Put a child restraint system on the seat in which you wish to install it, and remove the head restraint from the seat. Refer to “Head restraints” on page 2-04.
2. When installing a child restraint system in the front passenger seat, adjust seat slide to its most rearward position.
3. Route the belt through the child restraint according to the child restraint system manufacturer’s instructions, then insert the latch plate into the buckle.
4. Remove all slack of a lap belt by pulling the webbing through the belt’s adjustment feature. 3-point type seat belt requires no length adjustment, remove all slack by using the locking clip.
5. Before putting the child in the restraint, push and pull the restraint in all directions to be sure it is secure. Do this before each use.

WARNING

- For some types of child restraint, the locking clip (C) should be used to help avoid personal injury during a collision or sudden manoeuvre. It must be fitted and used in accordance with the child restraint manufacturer’s instructions. The locking clip must be removed when the child restraint is removed.

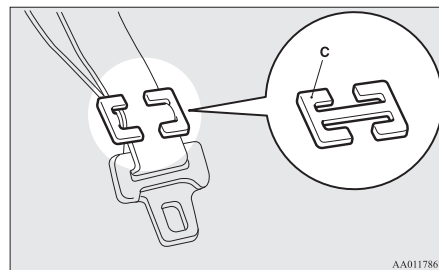

Seat belt inspection

E00406300576

- Check the belts for cuts, worn or frayed webbing and for cracked or deformed metallic parts. Replace the belt assembly if it is defective.
- A dirty belt should be cleaned with neutral detergent in warm water. After rinsing in water, let it dry in the shade. Do not attempt to bleach or re-dye the belts because this will affect their characteristics.

⚠ WARNING

- We recommend you to have all seat belt assemblies including retractors and attaching hardware inspected after any collision. We recommend that seat belt assemblies in use during a collision be replaced unless the collision was minor and the belts show no damage and continue to operate properly.
- Do not attempt to repair or replace any part of the seat belt assemblies; we recommend you to have this work done by a MITSUBISHI MOTORS Authorized Service Point. Incorrect repair or replacement could reduce the effectiveness of the belts and could result in serious injury in the event of a collision.
- Once the pretensioner has been activated, it cannot be re-used. It must be replaced together with the retractor.

Supplemental restraint system (SRS) - airbag

E00407202244

The information written in this Supplemental Restraint System (SRS) section contains important points concerning the driver front passenger, side and curtain airbags.

The SRS driver airbag and the SRS front passenger airbag are designed to supplement the primary protection of the driver and front passenger side seat belt systems by providing those occupants with protection against head and chest injuries in certain moderate-to-severe frontal collisions.

The SRS side airbags are designed to supplement properly worn seat belts and provide the driver and front passenger with protection against chest injuries in certain moderate-to-severe side impact collisions.

The SRS curtain airbags are designed to supplement properly worn seat belts and provide the driver and passengers on the front seat and rear outboard seat with protection against head injuries in certain moderate-to-severe side impact collisions.

The SRS is NOT a substitute for the seat belts; for maximum protection in all types of crashes and accidents, seat belts should ALWAYS be worn by everyone who drives or rides in this vehicle.

How the Supplemental Restraint System works

E00407301785

The SRS includes the following components:

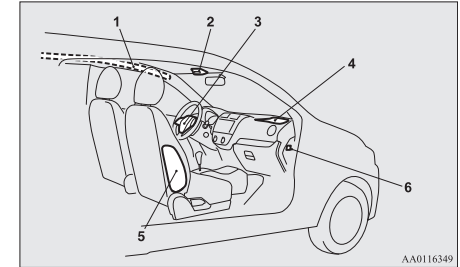

AA0116349

- 1- Curtain airbag modules
- 2- Front passenger's airbag OFF indication lamp
- 3- Airbag module (Driver)
- 4- Airbag module (Passenger)
- 5- Side airbag modules
- 6- Front passenger's airbag ON-OFF switch

Only when the ignition switch or the operation mode is under the following conditions, the airbags will operate.

[Except for vehicles equipped with keyless operation system]

The ignition switch is in the "ON" or "START" position.

[Vehicles equipped with keyless operation system]

The operation mode is in ON.

Seat and seat belts

The airbags deployment produces a sudden, loud noise, and releases some smoke and powder, but these conditions are not injurious, and do not indicate a fire in the vehicle. People with respiratory problems may feel some temporary irritation from chemicals used to produce the deployment; open the windows after airbag deployment, if safe to do so.

The airbags deflate very rapidly after deployment, so there is little danger of obscured vision.

CAUTION

- Airbags inflate at an extremely rapid speed. In certain situations, contact with inflating airbags can result in abrasions, light cuts, bruises, and the like.

WARNING

- IT IS VERY IMPORTANT TO BE PROPERLY SEATED.

A driver or front passenger too close to the steering wheel or instrument panel during airbag deployment can be killed or seriously injured.

Airbags inflate very fast, and with great force.

If the driver and passengers are not properly seated and restrained, the airbags may not protect you properly, and could cause serious or fatal injuries when it inflates.

- Do not sit on the edge of the seat, or lean head or chest close to the steering wheel or instrument panel. Do not put feet or legs on or against the instrument panel.

WARNING

- Place all infants and small children in the rear seat and properly restrained using an appropriate child restraint system. The rear seat is the safest place for infants and children.

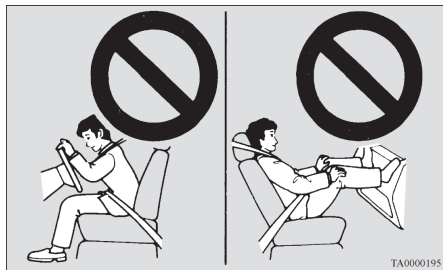

WARNING

- Infants and small children should never be unrestrained, stand up against the instrument panel or be held in your arms or on your lap. They could be seriously injured or killed in a collision, including when the airbag inflates. They should be properly seated in the rear seat in an appropriate child restraint system. See the “Child restraint” section of this owner’s manual.

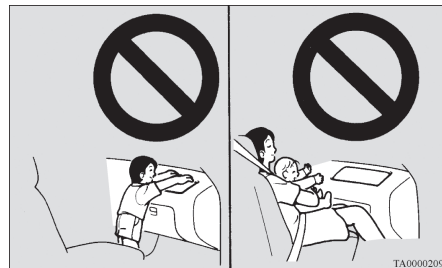

WARNING

- Older children should be seated in the rear seat, properly wearing the seat belt, with an appropriate booster seat if needed.

Caution for installing the child restraint on vehicles with a front passenger airbag

E00408800807

The label shown here is attached on vehicles with a front passenger airbag.

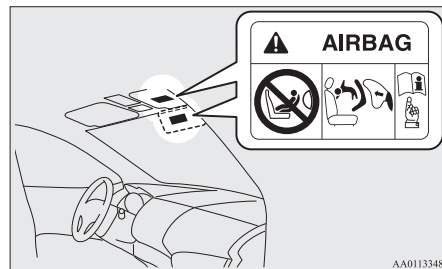

⚠ WARNING

- **Extreme Hazard!**
NEVER use a rearward facing child restraint on a seat protected by an ACTIVE AIRBAG in front of it, DEATH or SERIOUS INJURY to the CHILD can occur.

Front passenger's airbag ON-OFF switch

E00410100399

The front passenger's airbag ON-OFF switch can be used to disable the front passenger's airbag. If you have a child restraint system that cannot be fitted to any seat other than the front passenger seat, be sure to turn OFF the front passenger's airbag ON-OFF switch before using it. (Refer to "To turn an airbag off" on page 2-19.)

Front passenger's airbag ON-OFF switch is located at shown in the illustration.

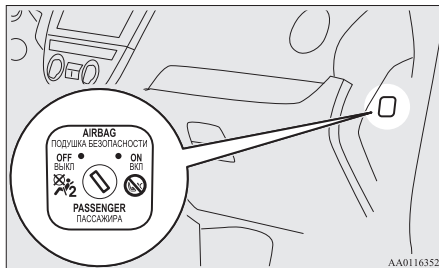

Front passenger's airbag OFF indication lamp

E00411500198

The front passenger's airbag OFF indication lamp is located at shown in the illustration.

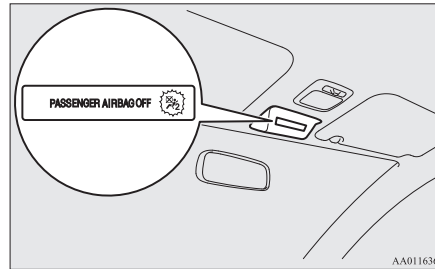

The indication lamp normally comes on when the ignition switch is turned to the "ON" position or the operation mode is put in ON, and goes off a few seconds later.

When the front passenger's airbag ON-OFF switch is turned OFF, the indication lamp will stay on to show that the front passenger's airbag is not operational.

When the front passenger's airbag ON-OFF switch is turned ON, the indication lamp goes off to show that the front passenger's airbag is operational.

⚠ WARNING

- Do not fit any accessory that makes the indication lamp impossible to see, and do not cover the indication lamp with a sticker. You would not be able to verify the status of the front passenger's airbag system.

To turn an airbag off

⚠ WARNING

- To reduce risk of serious or fatal injury:
 - Always remove the key from the ignition switch before operating a front passenger's airbag ON-OFF switch. Failure to do so could adversely affect the airbag performance.
 - Wait at least 60 seconds to operate the front passenger's airbag ON-OFF switch after turning the ignition switch to the "LOCK" position or putting the operation mode in OFF. The SRS airbag system is designed to retain enough voltage to deploy the airbag.
 - Always remove the key from the front passenger's airbag ON-OFF switch after operating that switch. Failure to do so could lead to improper position of the front passenger's airbag ON-OFF switch.
 - Do not turn OFF the front passenger's airbag ON-OFF switch except when a child restraint system is fitted to the front passenger seat.
- To reduce risk of serious or fatal injury:

⚠ WARNING

- If the indication lamp does not come on when the front passenger's airbag ON-OFF switch is turned OFF, do not fit a child restraint system to the front passenger seat. We recommend you to have the system inspected by a MITSUBISHI MOTORS Authorized Service Point.
- If the indication lamp remains on when the front passenger's airbag ON-OFF switch is turned ON, do not allow anyone to sit on the front passenger seat. We recommend you to have the system inspected by a MITSUBISHI MOTORS Authorized Service Point.

To turn an airbag off, follow these steps:

1. Insert the key into the front passenger's airbag ON-OFF switch, and turn it to the "OFF" position.
2. Remove the key from the key opening of the front passenger's airbag ON-OFF switch.

3. Turn the ignition switch to the "ON" position or put the operation mode in ON. The front passenger's airbag OFF indication lamp will stay on.

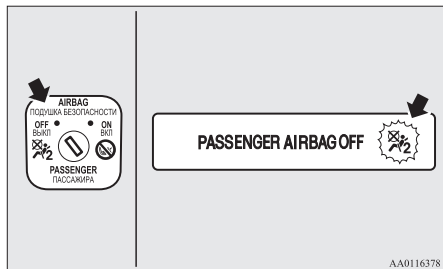

The front passenger's airbag is now deactivated and will not deploy until switched on again.

Driver's and passenger's front airbag system

E00407400864

The driver's airbag is located under the padded cover in the middle of the steering wheel. The front passenger's airbag is contained in the instrument panel above the glove box.

The front passenger's airbag deploys at the same time as the driver's airbag, even if the passenger seat is not occupied.

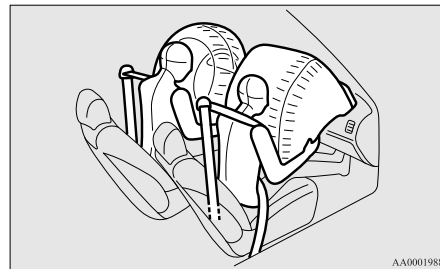

AA0001988

Deployment of front airbags

E00412500313

The front airbags ARE DESIGNED TO DEPLOY when...

The front airbags are designed to deploy when the vehicle suffers a moderate to severe frontal impact. A typical condition is shown in the illustration.

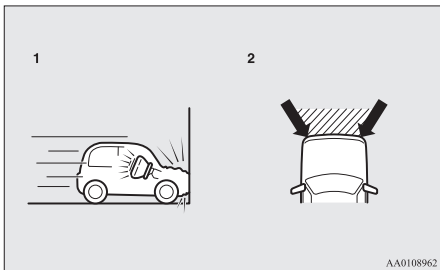

- 1- Head-on collision with a solid wall at a speed of approximately 25 km/h (16 mph) or higher
- 2- Moderate-to-severe frontal impact within the shaded area between the arrows

The front airbags will deploy if the severity of impact is above the designed threshold level, comparable to an approximately 25 km/h (16 mph) collision when impacting straight into a solid wall that does not move or deform. If the severity of the impact is below the above threshold level, the front airbags may not deploy. However, this threshold speed will be considerably higher if the vehicle strikes an object that absorbs the impact by either deforming or moving (for example, another stationary vehicle, pole or a guard rail).

Because frontal collisions can easily move you out of position, it is important to always properly wear your seat belts. Your seat belts will help keep you in a safe distance from the steering wheel and instrument panel during the initial stages of airbag deployment. The initial stage of airbag inflation is the most forceful, and can possibly cause serious or fatal injuries. Moreover, the seat belts in your vehicle are your primary means of protection in a collision. The SRS airbags are designed to provide additional protection. Therefore, for your safety and the safety of all occupants, be sure to always properly wear your seat belts.

The front airbags MAY NOT DEPLOY when...

With certain types of frontal collisions, the vehicle's body structure is designed to absorb the shock to help protect the occupants from harm. (The vehicle body's front area may deform significantly as it absorbs the impact.) Under such circumstances, the front airbags may not deploy irrespective of the deformation and damage to the vehicle body.

Examples of some typical conditions are shown in the illustration.

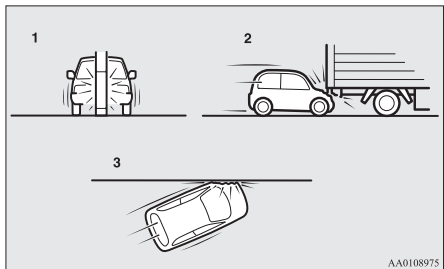

- 1- Collision with a utility pole, tree or other narrow objects
- 2- Vehicle slides under the rear body of a truck
- 3- Oblique frontal impacts

Because the front airbags do not protect the occupant in all types of frontal collisions, be sure to always properly wear your seat belts.

Seat and seat belts

The front airbags ARE NOT DESIGNED TO DEPLOY when...

The front airbags are not designed to deploy in conditions where they cannot typically provide protection to the occupant. Such conditions are shown in the illustration.

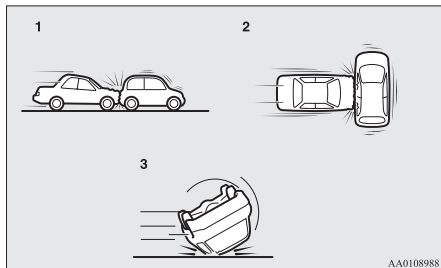

- 1- Rear end collisions
- 2- Side collisions
- 3- Vehicle rolls onto its side or roof

Because the front airbags do not protect the occupant in all types of collisions, be sure to always properly wear your seat belts.

The front airbags MAY DEPLOY when...

The front airbags may deploy if the bottom of the vehicle suffers a moderate-to-severe impact (undercarriage damage).

Examples of some typical conditions are shown in the illustration.

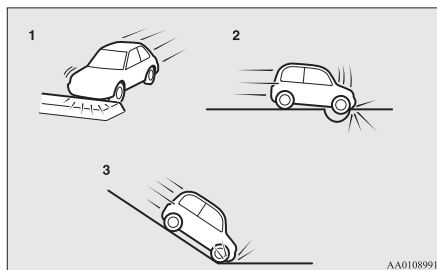

- 1- Collision with an elevated median/island or kerb
- 2- Vehicle travels over a deep hole/pothole
- 3- Vehicle drives down a steep slope and hits the ground

Because the front airbags may deploy in certain types of unexpected impacts as shown in the illustration that can easily move you out of position, it is important to always properly wear your seat belts. Your seat belts will help keep you in a safe distance from the steering wheel and instrument panel during the initial stages of airbag deployment. The initial stage of airbag inflation is the most forceful and can possibly cause serious or fatal injuries if you contact it at this stage.

⚠ WARNING

- Do not attach anything to the steering wheel's padded cover, such as trim material, badges, etc. It might strike and injure an occupant if the airbag inflates.

⚠ WARNING

- Do not set anything on, or attach anything to, the instrument panel above the glove box. It might strike and injure an occupant if the airbag inflates.

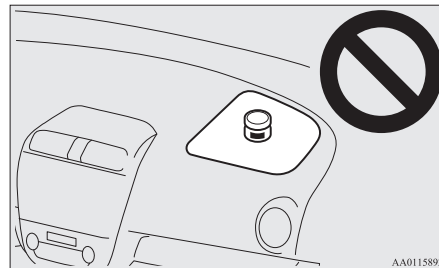

⚠ WARNING

- Do not attach accessories to, or put them in front of, the windscreen. These objects could restrict the airbag inflation, or strike and injure an occupant if the airbags inflate.
- Do not put packages, pets or other objects between the airbags and the driver or front passenger. It could affect airbag performance, or could cause injury when the airbag inflates.
- Right after the airbag inflation, several airbag system components will be hot. Do not touch them; you could be burned.

⚠ WARNING

- The airbag system is designed to work only once. Once the airbags have deployed, they will not work again. They must promptly be replaced, and we recommend you to have the entire airbag system inspected by a MITSUBISHI MOTORS Authorized Service Point.

Side airbag system

E00407600635

The side airbags (A) are contained in the driver and front passenger seatbacks.

The side airbag is designed to inflate only on the side of the vehicle that is impacted, even with no passenger in the front seat.

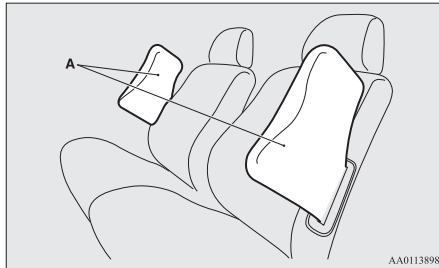

The label shown here is attached to the seatbacks with a side airbag.



Curtain airbag system

E00409100676

The curtain airbags are contained in the front pillars and roof side rail. The curtain airbag is designed to inflate only on the side of the vehicle that is impacted, even with no passenger in the front seat or rear seat.

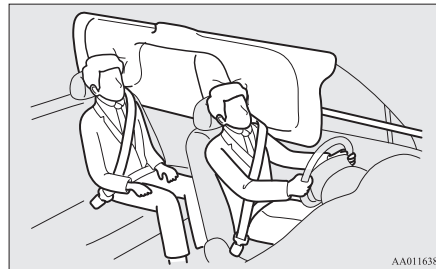

Deployment of side airbags and curtain airbags

E00407701503

The side airbags and curtain airbags ARE DESIGNED TO DEPLOY when...

The side airbags and curtain airbags are designed to deploy when the vehicle suffers a moderate-to-severe side impact to the middle of the passenger compartment.

The typical condition is shown in the illustration.

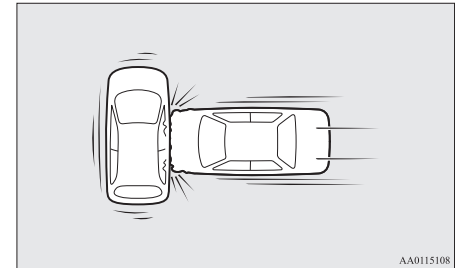

The seat belts in your vehicle are your primary means of protection in a collision. The SRS side airbags and curtain airbags are designed to provide additional protection. Therefore, for your safety and the safety of all occupants, be sure to always properly wear your seat belts.

Seat and seat belts

The side airbags and curtain airbags MAY NOT DEPLOY when...

With certain types of side collisions, the vehicle's body structure is designed to absorb the shock to help protect the occupants from harm. (The vehicle body's side area may deform significantly as it absorbs the impact.) Under such circumstances, the side airbags and curtain airbags may not deploy irrespective of the deformation and damage to the vehicle body. Examples of some typical conditions are shown in the illustration.

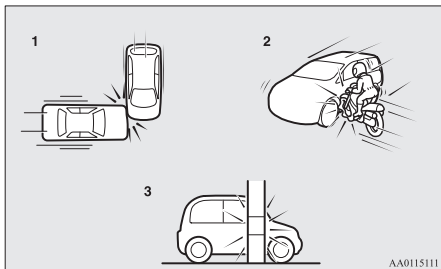

- 1- Side impacts in an area away from the passenger compartment
- 2- Motorcycle or other similar small vehicle collides with the side of vehicle

- 3- Collision with a utility pole, tree or other narrow object

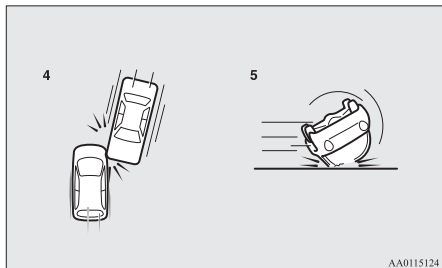

- 4- Oblique side impacts
- 5- Vehicle rolls onto its side or roof

Because the side airbags and curtain airbags do not protect the occupant in all types of side collisions, be sure to always properly wear your seat belts.

The side airbags and curtain airbags ARE NOT DESIGNED TO DEPLOY when...

The side airbags and curtain airbags are not designed to deploy in conditions where they cannot usually provide protection to the occupant. Typical conditions are shown in the illustration.

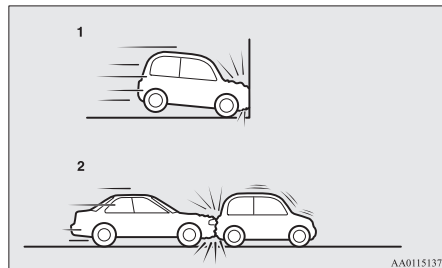

- 1- Head-on collisions
- 2- Rear end collisions

Because the side airbags and curtain airbags do not protect the occupant in all types of collisions, be sure to always properly wear your seat belts.

⚠ WARNING

- The side airbags and curtain airbags are designed to supplement the driver and passenger seat belts in certain side impacts. Seat belts should always be worn properly, and the driver and passenger should sit well back and upright without leaning against the window or door.

⚠ WARNING

- The side airbag and curtain airbag inflate with great force. The driver and passenger should not put their arms out of the window, and should not lean against the door, in order to reduce the risk of serious or possible fatal injury from the deploying side airbag and curtain airbag.



⚠ WARNING

- Do not allow any rear seat occupant to hold onto the seatback of either front seat, in order to reduce risk of injury from the deploying side airbags. Special care should be taken with children.
- Do not place any objects near or in front of the seatback of either front seat. They could interfere with proper side airbag inflation, and also could cause injury if thrown free by side airbag deployment.

⚠ WARNING

- Do not place stickers, labels or additional trim on the seatback of either front seat. They could interfere with proper side airbag inflation.
- Do not install seat covers on seats with side airbags. Do not re-cover seats that have side airbags. This could interfere with proper side airbag inflation.
- Do not attach a microphone (A) or any other device or object around the part where the curtain airbags activate such as on the windscreen, side door glass, front and rear pillars and roof side or assist grips. When the curtain airbags inflate, the microphone or other device or object will be hurled with great force or the curtain airbags may not activate correctly, resulting in death or serious injury.

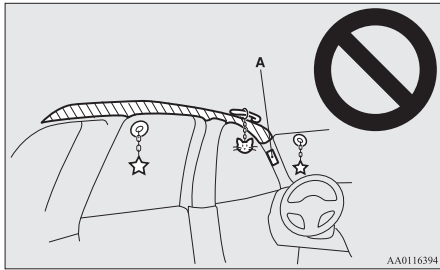

⚠ WARNING

- Never install a rearward facing child restraint in the front passenger seat. A forward facing child restraint should be used in the rear seat whenever possible. If a forward facing child restraint must be used in the front passenger seat, adjust the seat to the most rearward position, and ensure that the child stays in the child restraint and away from the door.
- Do not allow the child to lean against or close to the door even if the child is seated in a child restraint system. The child's head should also not be leaned against or be close to the area where the side airbags and curtain airbags are located. It is dangerous if the side airbags and curtain airbags inflate. Failure to follow all of these instructions could lead to serious or fatal injury to the child.
- We recommend work around and on the side airbags and curtain airbags system to be done by a MITSUBISHI MOTORS Authorized Service Point.

SRS warning lamp

E00407801650

There is a Supplemental Restraint System ("SRS") warning lamp on the instrument panel. The system checks itself and the lamp tells you if there is a problem. When the ignition key is turned to the "ON" or "START" position, or the operation mode is put in ON, the warning lamp should illuminate for several seconds and then should go out. This means the system is ready.

Seat and seat belts

In an SRS airbag or pretensioner seat belt is not operating properly, the warning lamp comes on and stays on.

The SRS warning lamp is shared by the SRS airbag and the seat belt pretensioner system.

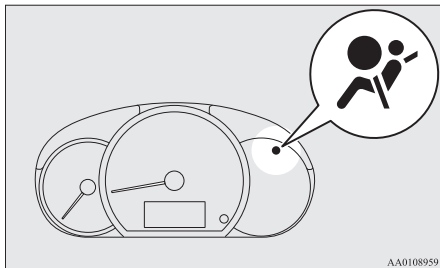

⚠ WARNING

- If any of the following conditions occur, the SRS and/or seat belt pretensioners are not working properly, and we recommend you to have it inspected by a MITSUBISHI MOTORS Authorized Service Point immediately.
 - The SRS warning lamp does not illuminate when you start the vehicle.
 - The SRS warning lamp does not go out after several seconds.
 - The SRS warning lamp illuminates while driving.

SRS servicing

E00407901648

⚠ WARNING

- We recommend any maintenance performed on or near the components of the SRS to be performed by a MITSUBISHI MOTORS Authorized Service Point. Improper work on the SRS components or wiring could result in inadvertent deployment of the airbags, or could render the SRS inoperative; either situation could result in serious injury.
- Do not modify your steering wheel, seat belt retractor or any other SRS components. For example, replacement of the steering wheel, or modifications to the front bumper or body structure can adversely affect SRS performance and lead to possible injury.
- If your vehicle has sustained any damage, we recommend you to have the SRS inspected to ensure it is in proper working order.
- Do not modify your front seats, centre pillar and centre console. It can adversely affect SRS performance and lead to possible injury.
- If you found any tear scratch, crack or damage to the portion where the airbag is stored, you should have the SRS inspected by a MITSUBISHI MOTORS Authorized Service Point.

NOTE

- If your vehicle has to be scrapped, do this in line with local legislation and contact a MITSUBISHI MOTORS Authorized Service Point to safely dismantle the airbag system.

Instruments and controls

Instruments.....	3-02
Multi-information display.....	3-02
Indication and warning lamps.....	3-10
Indication lamps.....	3-11
Warning lamps.....	3-12
Combination headlamps and dipper switch.....	3-14
Headlamp levelling switch.....	3-16
Turn-signal lever.....	3-17
Hazard warning flasher switch.....	3-18
Fog lamp switch.....	3-18
Wiper and washer switch.....	3-19
Rear window demister switch.....	3-23
Horn switch.....	3-24

Instruments

E00500101453

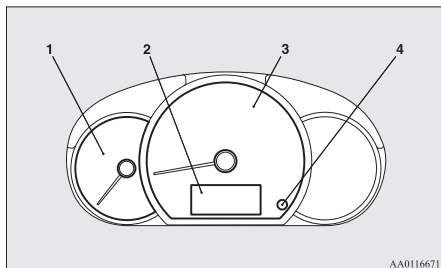

AA0116671

1- Tachometer*

The tachometer indicates the engine speed (r/min). The tachometer helps you to obtain more economical driving and also warns you of excessive engine speeds (Red zone).

- 2- Multi-information display → p. 3-02
- 3- Speedometer (km/h or mph + km/h)
- 4- Multi-information display switch

CAUTION

- When driving, watch the tachometer to make sure that the engine speed indication does not rise into the red zone (excessive engine rpm).

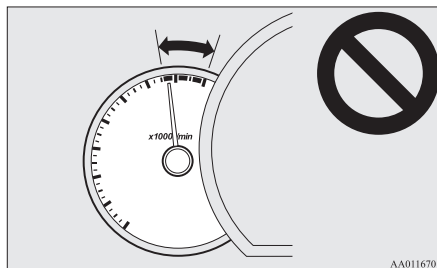

AA0116701

Multi-information display

E00519901109

Always stop the vehicle in a safe place before operating.

The following information is included on the multi-information display: odometer, tripmeter, meter illumination control, service reminder, fuel remaining, driving range and average fuel consumption, etc.

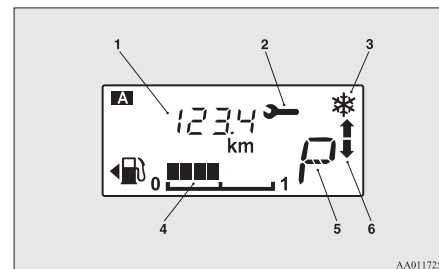

AA0117258

- 1- Information display → p. 3-03
- 2- Service reminder → p. 3-06
- 3- Frozen road warning* → p. 3-05
- 4- Fuel remaining display → p. 3-06
- 5- Selector lever position display* → p. 4-22
- 6- Gearshift indicator* → p. 4-19

NOTE

- When the ignition switch or the operation mode is OFF, the selector lever position display, gearshift indicator, fuel remaining display and frozen road warning are not displayed.

Information display

Each time you lightly press the multi-information display switch (A), the display switches in the following order.

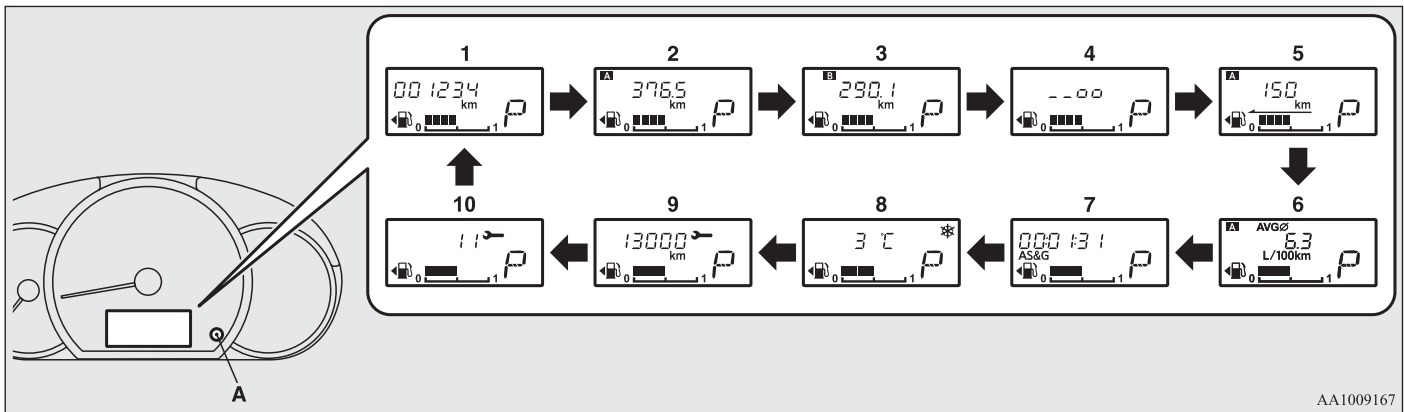

- 1- Odometer → p. 3-04
- 2- Tripmeter **A** → p. 3-04
- 3- Tripmeter **B** → p. 3-04
- 4- Meter illumination control → p. 3-04
- 5- Driving range display → p. 3-04

- 6- Average fuel consumption display → p. 3-05
- 7- AS&G monitor* → p. 3-05
- 8- Outside temperature display* → p. 3-05
- 9- Service reminder (distance) → p. 3-06
- 10- Service reminder (month) → p. 3-06

NOTE

- When the ignition switch or the operation mode is OFF, the driving range display, average fuel consumption display and outside temperature display are not displayed.
- While driving, the service reminder is not displayed even if you operate the multi-information display switch.

Instruments and controls

Odometer

E00527800067

The odometer indicates the distance travelled.

Tripmeter

E00527900071

The tripmeter indicates the distance travelled between two points.

Example usage of tripmeter **A** and tripmeter **B**

It is possible to measure two currently travelled distances, from home using tripmeter **A** and from a particular point on the way using tripmeter **B**.

To reset the tripmeter

To return the display to 0, hold down the multi-information display switch for about 1 second or more. Only the currently displayed value will be reset.

Example

If tripmeter **A** is displayed, only tripmeter **A** will be reset.

NOTE

- When disconnecting the battery terminal, the memory of tripmeter **A** and **B** are cleared, and the display returns to “0”.

Meter illumination control

E00537900045

Each time you press the multi-information display switch (2), there is a sound and the brightness of the instruments changes.

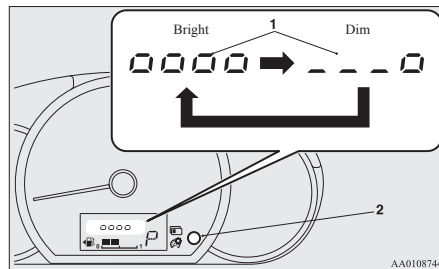

- 1- Brightness level
- 2- Multi-information display switch

NOTE

- You can adjust to 8 different levels for when the tail lamps are illuminated and 8 for when they are not. Each time you reduce two brightness levels, the segment display of the brightness level decreases one by one.
- The brightness level of the instruments is stored when the ignition switch is turned to the “LOCK” position or the operation mode is put in OFF.
- If you press and hold the switch for longer than about 1 second, the brightness automatically scrolls through its different levels, and stops scrolling when you release the switch. Select your desired level of brightness.

- If the vehicle is equipped with the automatic lamp control, when the lamp switch is in a position other than the “OFF” position, the meter illumination switches automatically to the adjusted brightness, depending on the brightness outside the vehicle.

Driving range display

E00538000014

This displays the approximate driving range (how many more kilometres or miles you can drive). When the driving range falls below approximately 50 km (30 miles), “---” is displayed.

NOTE

- The driving range is determined based on the fuel consumption data. This may vary depending on the driving conditions and habits. Treat the distance displayed as just a rough guideline.
- When you refuel, the driving range display is updated. However, if you only add a small amount of fuel, the correct value will not be displayed. Fill with a full tank whenever possible.
- On rare occasions, the value displayed for the driving range may change if you are parked on an extremely steep incline. This is due to the movement of fuel in the tank and does not indicate a malfunction.
- The display setting can be changed to the preferred units (km or miles). Refer to “Changing the function settings” on page 3-07.

Average fuel consumption display

E00531200017

This displays the average fuel consumption from the last reset to the present time.

The reset mode conditions for the average fuel consumption display can be switched between “Auto reset” and “Manual reset”.

For information on how to change the average fuel consumption display setting, refer to “Changing the function settings” on page 3-07.

NOTE

- The average fuel consumption display can be reset separately in both auto reset mode and manual reset mode.
- “----” is displayed when the average fuel consumption cannot be measured.
- The initial (default) setting is “Auto reset mode”.
- The average fuel consumption depends on the driving condition (road condition, driving behavior, etc.). The displayed fuel consumption may vary from the actual fuel consumption. Treat the fuel consumption displayed as just a rough guideline.
- The memory of the auto reset mode or manual reset mode for the average fuel consumption display is erased if the battery is disconnected.
- The display setting can be changed to the preferred units {km/L, L/100 km, mpg}. Refer to “Changing the function settings” on page 3-07.

AS&G monitor*

E00531100029

The accumulated time the engine has been stopped by Auto Stop & Go (AS&G) system is displayed.

Refer to “Auto Stop & Go (AS&G) system” on page 4-15.

NOTE

- When the ignition switch or the operation mode is ON again, the accumulated time will be reset.

Outside temperature display*

E00533500043

This shows the temperature outside the vehicle.

NOTE

- The display setting can be changed to the preferred units (°C or °F). Refer to “Changing the function settings” on page 3-07.
- Depending on factors such as the driving conditions, the displayed temperature may vary from the actual outside temperature.

Frozen road warning*

E00533400026

If the outside air temperature drops below approx. 3°C (37 °F), the alarm sounds and the outside air temperature warning symbol (A) flashes for about 10 seconds.

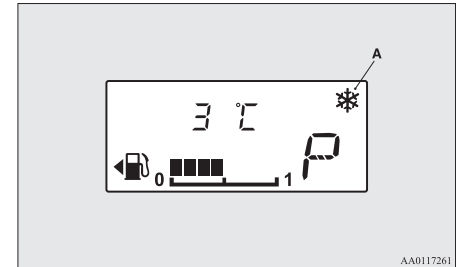

AA0117261

**CAUTION**

- There is a danger the road might be icy, even when this symbol is not flashing, so please take care when driving.

Instruments and controls

Fuel remaining display

E00522200545

The fuel remaining display indicates the fuel level in the fuel tank when the ignition switch or the operation mode is ON.

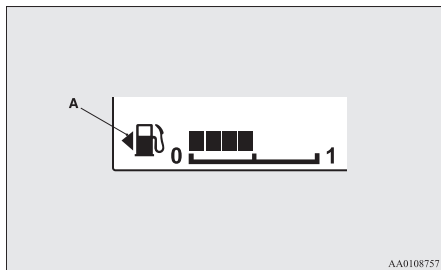

1- Full
0- Empty

NOTE

- It may take several seconds to stabilise the display after refilling the tank.
- If fuel is added with the ignition switch or the operation mode is ON, the fuel gauge may incorrectly indicate the fuel level.
- The fuel lid mark (A) indicates that the fuel tank filler door is located on the left side of the vehicle.

Fuel remaining warning display

E00522400723

If the remaining fuel level is approximately 6 litres or less (one segment displayed) when the ignition switch is turned to the “ON” position or the operation mode is changed to ON, the last segment of the fuel gauge flashes. If the remaining fuel level is approximately 3 litres or less (no segments displayed), “” and the bar graph flash.

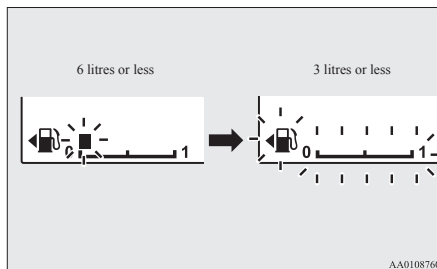

CAUTION

- Do not drive with an extremely low fuel level; running out of fuel could cause damage to the catalytic converter.

NOTE

- On inclines or curves, the display may be incorrect due to the movement of fuel in the tank.

Service reminder

E00522501011

Displays the approximate time until the next periodic inspection that MITSUBISHI MOTORS recommends. “---” is displayed when the inspection time has arrived.

The spanner mark indicates the periodic inspection.

NOTE

- Depending on the vehicle specifications, the displayed time until the next periodic inspection may differ from that recommended by MITSUBISHI MOTORS.

In addition, the display settings for the next periodic inspection time can be modified.

To modify the display settings, have it adjusted at a MITSUBISHI MOTORS Authorized Service Point.

For more details, contact a MITSUBISHI MOTORS Authorized Service Point.

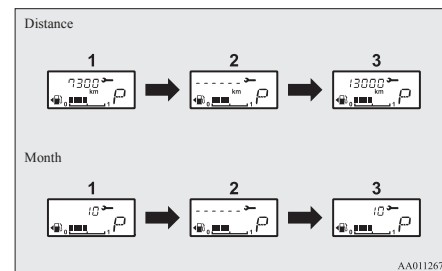

1. Displays the time until the next periodic inspection.

NOTE

- The distance is shown in units of 100 km (100 miles). The time is shown in units of months.
2. This informs you that a periodic inspection is due. Consult a MITSUBISHI MOTORS Authorized Service Point.
 3. After your vehicle is inspected at a MITSUBISHI MOTORS Authorized Service Point, it displays the time until the next periodic inspection.

To reset

The “---” display can be reset while the ignition switch or the operation mode is in OFF.

1. When you lightly press the multi-information display switch a few times, the information display switches to the service reminder display.

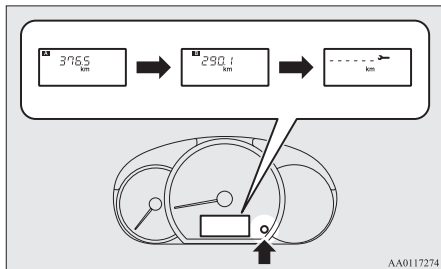

2. Press and hold the multi-information display switch for about 1 second or more to make the spanner mark start flashing. (If there is no operation for about 10 seconds with flashing, the display will revert to its original indication.)
3. Lightly press the multi-information display switch while the icon is flashing to change the display from “---” to “cLEAR”. After this, the time until the next periodic inspection will be displayed.

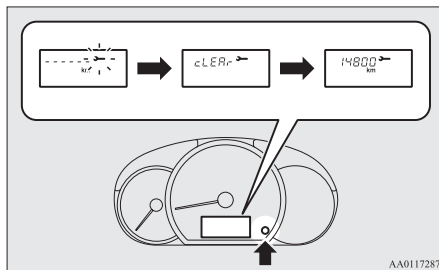

CAUTION

- **The customer is responsible for making sure that periodic inspection and maintenance are performed. Inspections and maintenance must be performed to prevent accidents and malfunctions.**

NOTE

- “---” display cannot be reset when the ignition switch or the operation mode is in ON.

- When “---” is displayed, after a certain distance and a certain period of time, the display is reset and the time until the next periodic inspection is displayed.
- If you accidentally reset the display, consult a MITSUBISHI MOTORS Authorized Service Point.

Changing the function settings

E00522700726

The average fuel consumption reset mode, fuel consumption unit and temperature unit setting can be modified as desired, when the ignition switch or the operation mode is ON.

CAUTION

- **The driver should not operate the display while the vehicle is in motion.**
- **When operating the system, stop the vehicle in a safe area.**

Changing the reset mode for average fuel consumption

E00522901044

The mode conditions for the average fuel consumption display can be switched between “Auto reset” and “Manual reset”.

1. When you lightly press the multi-information display switch a few times, the information display switches to the driving range display. Refer to “Information display” on page 3-03.

Instruments and controls

- Each time you press the multi-information display switch for 1 second or more on driving range display, you can switch reset mode for average fuel consumption.

(A: Auto reset mode, B: Manual reset mode)

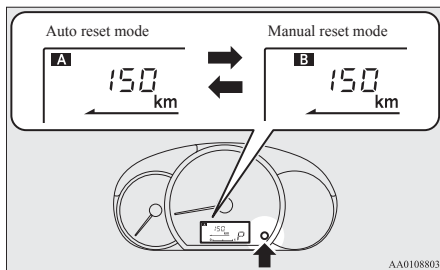

Manual reset mode

- When the average fuel consumption is being displayed, if you hold down the multi-information display switch, the average fuel consumption displayed at that time is reset.
- When the following operation is performed, the mode setting is automatically switched from manual to auto.

[Except for vehicles equipped with keyless operation system]

Turn the ignition switch from the “ACC” or “LOCK” position to the “ON” position.

[For vehicles equipped with keyless operation system]

Change the operation mode from ACC or OFF to ON.

Switching to auto occurs automatically. If switching to manual mode is done, however, the data from the last reset is displayed.

Auto reset mode

- When the average fuel consumption is being displayed, if you hold down the multi-information display switch, the average fuel consumption displayed at that time are reset.
- When the engine switch or the operation mode is in the following conditions, the average fuel consumption display is automatically reset.

[Except for vehicles equipped with keyless operation system]

The ignition switch is in the “ACC” or “LOCK” position for about 4 hours or longer.

[For vehicles equipped with keyless operation system]

The operation mode is in ACC or OFF for about 4 hours or longer.

NOTE

- The average fuel consumption display can be reset separately for the auto reset mode and for the manual reset mode.
- The memory of the auto reset mode or manual reset mode for the average fuel consumption display is erased if the battery is disconnected.
- The initial (default) setting is “Auto reset mode”.

Changing the fuel consumption display unit

E00523000768

The display unit for fuel consumption can be switched. The distance and amount units are also switched to match the selected fuel consumption unit.

- When you lightly press the multi-information display switch a few times, the information display switches to the average fuel consumption display.

Refer to “Information display” on page 3-03.

- Press and hold the multi-information display switch for about 5 seconds or more until buzzer sound is heard twice.
- Press and hold the multi-information display switch to switch in sequence from “km/L” → “L/100 km” → “mpg” → “km/L”.

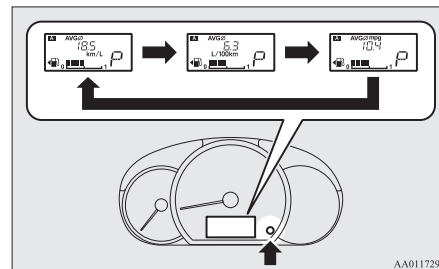

NOTE

- The display units for the driving range, the average fuel consumption are switched, but the units for the indicating needle (speedometer), the odometer, the tripmeter and the service reminder will remain unchanged.
- The memory of the unit setting is erased if the battery is disconnected, and it returns automatically to factory setting.

The distance units is also switched in the following combinations to match the selected fuel consumption unit.

Fuel consumption	Distance (driving range)
km/L	km
L/100 km	km

Fuel consumption	Distance (driving range)
mpg	mile(s)

*Changing the temperature unit**

E00523100730

The display unit for outside temperature can be switched.

1. When you lightly press the multi-information display switch a few times, the information display switches to the outside temperature display.
Refer to “Information display” on page 3-03.
2. Each time you press the multi-information display switch for 1 seconds or more on outside temperature display, you can switch from °C to °F or from °F to °C unit of outside temperature display.

NOTE

- The temperature unit on air conditioner panel is switched in conjunction with outside temperature display value of the multi information display.
However, “°C” or “°F” are not shown to temperature display of an air conditioner.

Indication and warning lamps

E00501502448

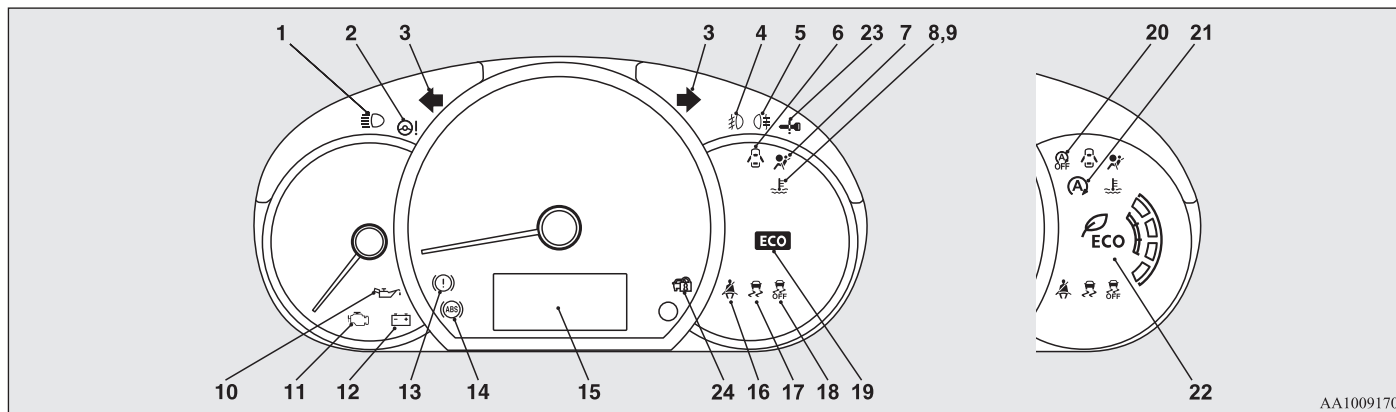

AA1009170

- 1- High-beam indication lamp → p. 3-11
- 2- Electric power steering system (EPS) warning lamp → p. 4-30
- 3- Turn-signal indication lamps/Hazard warning indication lamps → p. 3-11
- 4- Front fog lamp indication lamp* → p. 3-11
- 5- Rear fog lamp indication lamp → p. 3-11
- 6- Door ajar warning lamp → p. 3-14
- 7- Supplement Restraint System (SRS) warning lamp → p. 2-25
- 8- High coolant temperature warning lamp (red) → p. 3-13
- 9- Low coolant temperature indication lamp (green) → p. 3-11
- 10- Oil pressure warning lamp → p. 3-13
- 11- Check engine warning lamp → p. 3-12
- 12- Charge warning lamp → p. 3-13
- 13- Brake warning lamp → p. 3-12
- 14- Anti-lock brake system (ABS) warning lamp → p. 4-28
- 15- Multi-information display → p. 3-02
- 16- Seat belt warning lamp → p. 2-06
- 17- Active Stability Control (ASC) indication lamp → p. 4-31
- 18- Active Stability Control (ASC) OFF indication lamp → p. 4-31
- 19- ECO indication lamp* → p. 3-11
- 20- Auto Stop & Go (AS&G) OFF indication lamp* → p. 4-18
- 21- Auto Stop & Go (AS&G) indication lamp* → p. 4-15
- 22- ECO drive assist* → p. 3-11
- 23- For details, refer to “Warning activator” on page 1-09. (if so equipped)
- 24- For details, refer to “Warning activator” on page 1-09. (if so equipped)

Indication lamps

E00501600139



Turn-signal indication lamps/ Hazard warning indication lamps

E00501700420

These indication lamps blink in the following situations.

- When the turn-signal lever is moved to activate a turn-signal lamp. Refer to “Turn-signal lever” on page 3-17.
- When the hazard warning flasher switch is pressed to activate the hazard warning lamps. Refer to “Hazard warning flasher switch” on page 3-18.
- When the hazard warning lamps automatically activate due to sudden braking while driving. Refer to “Emergency stop signal system” on page 4-28.



High-beam indication lamp

E00501800186

This indication lamp illuminates when the high-beam is used.



Front fog lamp indication lamp*

E00501900480

This indication lamp illuminates while the front fog lamps are on.



Rear fog lamp indication lamp

E00502000215

This indication lamp illuminates while the rear fog lamp is on.



Low coolant temperature indication lamp

E00502200060

This indication lamp illuminates in green when the coolant temperature is low.

NOTE

- When the indication lamp goes out, this should be used as a rough indication of when the heating starts working.



ECO indication lamp*

E00529800117

This indication lamp illuminates when fuel-efficient driving is achieved.

ECO drive assist*

E00531700041

This function displays how fuel-efficiently you are driving under different driving conditions.

The ECO drive assist display will change as follows if you do fuel-efficient driving using the accelerator in a way well matched with the vehicle speed.

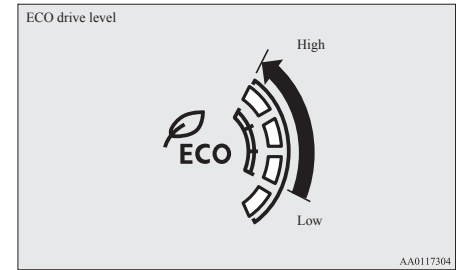

Warning lamps

E00502400479



Brake warning lamp

E00502502676

This lamp illuminates when the ignition switch is turned to the “ON” position or the operation mode is put in ON, and goes off after a few seconds.

Always make sure that the lamp goes off before driving.

With the ignition switch or the operation mode in ON, the brake warning lamp illuminates under the following conditions:

- When the parking brake lever has been engaged.
- When the brake fluid level in the reservoir falls to a low level.
- When the brake force distribution function is not operating correctly.

With the ignition switch or the operation mode in ON, a buzzer sounds under the following condition:

- The vehicle speed exceeds 8 km/h (5 mph) with the parking brake applied.

CAUTION

- In the situations listed below, brake performance may be compromised or the vehicle may become unstable if brakes are applied suddenly; consequently, avoid driving at high speeds or applying the brakes suddenly.

CAUTION

Furthermore, the vehicle should be brought to a stop in a safe location and to have it checked.

- The brake warning lamp does not illuminate when the parking brake is applied or does not turn off when the parking brake is released.
- The ABS warning lamp and brake warning lamp illuminate at the same time. For details, refer to “ABS warning lamp” on page 4-29.
- The brake warning lamp remains illuminated during driving.
- The vehicle should be brought to a halt in the following manner when brake performance has deteriorated.
 - Depress the brake pedal harder than usual. Even if the brake pedal moves down to the very end of its possible stroke, keep it pressed down hard.

CAUTION

- Should the brakes fail, use engine braking to reduce your speed and pull the parking brake lever. Depress the brake pedal to operate the stop lamp to alert the vehicles behind you.



Check engine warning lamp

E00502601931

This lamp is a part of an onboard diagnostic system which monitors the emissions, engine control system or CVT control system.

If a problem is detected in one of these systems, this lamp illuminates or flashes. Although your vehicle will usually be drivable and not need towing, we recommend you to have the system checked as soon as possible.

This lamp will also illuminate when the ignition switch is turned “ON” or the operation mode is put in ON, and goes off after the engine has started. If it does not go off after the engine has started, we recommend you to have the vehicle checked.

⚠ CAUTION

- Prolonged driving with this lamp on may cause further damage to the emission control system. It could also affect fuel economy and drivability.
- If the lamp does not illuminate when the ignition switch is turned to the “ON” position or the operation mode is put in ON, we recommend you to have the system checked.
- If the lamp illuminates while the engine is running, avoid driving at high speeds and have the system inspected by a MITSUBISHI MOTORS Authorized Service Point as soon as possible.
Accelerator pedal and brake pedal response may be negatively influenced under these conditions.

NOTE

- The engine electronic control module accommodating the onboard diagnostic system has various fault data (especially about the exhaust emission) stored. This data will be erased if a battery cable is disconnected which will make a rapid diagnosis difficult. Do not disconnect a battery cable when the check engine warning lamp is ON.

**Charge warning lamp**

E00502701280

This lamp illuminates when the ignition switch is turned to the “ON” position or the operation mode is put in ON, and goes off after the engine has started.

⚠ CAUTION

- If it illuminates while the engine is running, there is a problem in the charging system. Immediately park your vehicle in a safe place and we recommend you to have it checked.

**Oil pressure warning lamp**

E00502800718

This lamp illuminates when the ignition switch is turned to the “ON” position or the operation mode is put in ON, and goes off after the engine has started. If it illuminates while the engine is running, the oil pressure is too low. Turn the engine off and have it inspected.

⚠ CAUTION

- This warning lamp does not indicate the amount of oil level in the engine. This must be determined by checking the oil level on the dipstick, while the engine is switched off.

⚠ CAUTION

- If this lamp illuminates when the engine oil level is not low, have it inspected.
- If you continue driving with low engine oil level or with this warning lamp illuminated, engine seizure may occur.

**High coolant temperature warning lamp**

E00503000049

This lamp illuminates in red if the coolant temperature becomes excessively high.

⚠ CAUTION

- If the lamp illuminates during vehicle operation, it indicates that the engine is possibly overheating. Continued driving could make the engine fail. Immediately stop the vehicle in a safe place and take appropriate action. (Refer to “Engine overheating” on page 6-04.)

Instruments and controls

NOTE

- The high coolant temperature warning lamp may illuminate when the vehicle has been driven at high speeds or on hilly roads. This illuminating does not necessarily indicate a problem. It should stop if you keep the engine running for a while or continue driving the vehicle.



Door ajar warning lamp

E00503300895

This lamp illuminates when a door or the tailgate is either open or not completely closed.

If the vehicle speed reaches approximately 8 km/h (5 mph) with a door or the tailgate open or incompletely closed, a buzzer sounds 4 times as a warning.

CAUTION

- Before moving your vehicle, check that the warning lamp is OFF.

Combination headlamps and dipper switch

E00506002392

Headlamps

NOTE



- Do not leave the lights on for a long time while the engine is stationary (not running). A run-down battery could result.
- When it rains, or when the vehicle has been washed, the inside of the lens sometimes becomes foggy, but this does not indicate a functional problem.

When the lamp is switched on, the heat will remove the fog. However, if water gathers inside the lamp, we recommend you to have it checked.

Type 1

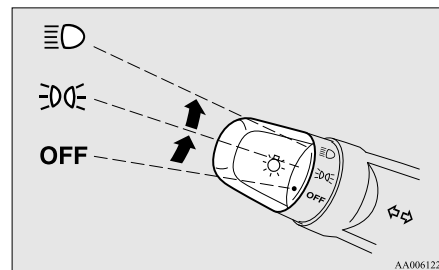
Rotate the switch to turn on the lamps.





OFF	All lamps off
	Position, tail, licence plate and instrument panel lamps on
	Headlamps and other lamps go on

Type 2

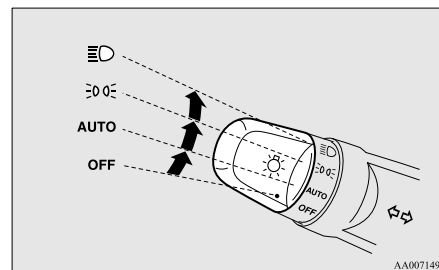
Rotate the switch to turn on the lamps.



OFF	All lamps off
-----	---------------

AUTO	With the ignition switch or the operation mode is in ON, head-lamps, position, tail, licence plate, and instrument panel lamps turn on and off automatically in accordance with outside light level. All lamps turn off automatically when the ignition switch is turned to “OFF” position or the operation mode is put in OFF.
	Position, tail, licence plate and instrument panel lamps on
	Headlamps and other lamps go on

NOTE

- The sensitivity of the automatic on/off control can be adjusted. For further information, contact a MITSUBISHI MOTORS Authorized Service Point.
- When the headlamps are turned off by the automatic on/off control with the ignition switch in the “ON” position or the operation mode in ON, the front fog lamps (if so equipped) and rear fog lamps also go off. When the headlamps are subsequently turned back on by the automatic on/off control, the front fog lamps also come on but the rear fog lamp stays off. If you wish to turn the rear fog lamp back on, operate the switch again.
- Do not cover the sensor (A) for the automatic on/off control by affixing a sticker or label to the windscreen.

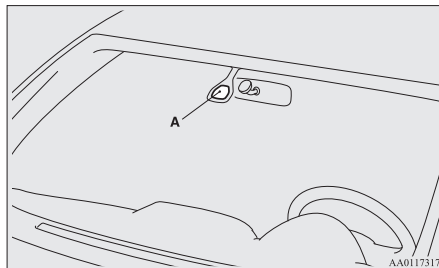

- If the lamps do not turn on or off with the switch in the “AUTO” position, manually operate the switch and we recommend you to have your vehicle checked.

Lamps (headlamps, fog lamp, etc.) auto-cutout function



- If the following operation is performed while the lamp switch is in the “” position, the lamps will turn off automatically when the driver’s door is opened.
[Except for vehicles equipped with keyless operation system]
The ignition switch is turned to the “LOCK” or “ACC” position, or the key is removed from the ignition switch.
[For vehicles equipped with keyless operation system]
The operation mode is in OFF or ACC.

- If the following operation is performed while the lamp switch is in the “” position, the lamps will remain on for about 3 minutes while the driver’s door is shut and will then automatically turn off.
[Except for vehicles equipped with keyless operation system]
The ignition switch is turned to the “LOCK” or “ACC” position, or the key is removed from the ignition switch.
[For vehicles equipped with keyless operation system]
The operation mode is in OFF or ACC.

NOTE

- The lamp auto-cutout will not function when the lamp switch is in the “” position.
- The lamp auto-cutout function can also be disabled.
For further information, we recommend you to consult a MITSUBISHI MOTORS Authorized Service Point.

When you want to keep the lamps on:

1. In the following cases, turn the lamp switch to the “OFF” position.
[Except for vehicles equipped with keyless operation system]
The ignition switch is in the “LOCK” or “ACC” position.
[For vehicles equipped with keyless operation system]
The operation mode is in OFF or ACC.
2. Turn on the lamps with the switch in the “” or “” position again, then the lamps will remain on.

Instruments and controls

Lamp monitor buzzer

E00506100621

If the following operation is performed, a buzzer will sound to remind the driver to turn off the lamps. [Except for vehicles equipped with keyless operation system]

If the driver's door is opened when the key is in the "LOCK" or "ACC" position or removed from the ignition switch while the lamps are on.

[For vehicles equipped with keyless operation system]

If the driver's door is opened when the operation mode is in ACC or OFF while the lamps are on.

3 In both cases, the buzzer will automatically stop if the auto-cutoff function is activated, the lamp switch is turned off, or the door is closed.

Daytime running lamp

E00530600043

The daytime running lamps comes on when the engine is running and the lamp switch is in the "OFF" or "AUTO" position and the tail lamps are off.

Dipper (High/Low beam change)

E00506200329

When the lamp switch is in the "☰D" position, the beam changes from high to low (or low to high) each time the lever is pulled fully (1). While the high-beam is on, the high-beam indication lamp in the instrument cluster will also illuminate.

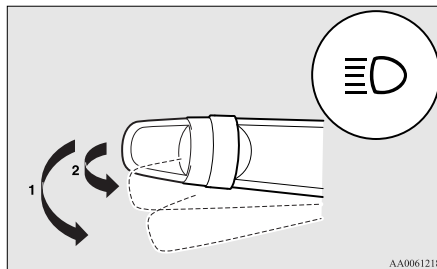

AA0061218

Headlamp flasher

E00506300199

The high-beams flash when the lever is pulled slightly (2), and will go off when it is released. When the high-beam is on, the high-beam indication lamp in the instrument cluster will illuminate.

NOTE

- The high-beams can also flash when the lamp switch is OFF.
- If you turn the lamps off with the headlamps set to high-beam, the headlamps are automatically returned to their low-beam setting when the lamp switch is next turned to the "☰D" position.

Headlamp levelling switch

E00506400871

The angle of the headlamp beam varies depending on the load carried by the vehicle.

The headlamp levelling switch can be used to adjust the headlamp illumination distance (when the lower beam is illuminated) so that the headlamps' glare does not distract other drivers.

Set the switch according to the following table.

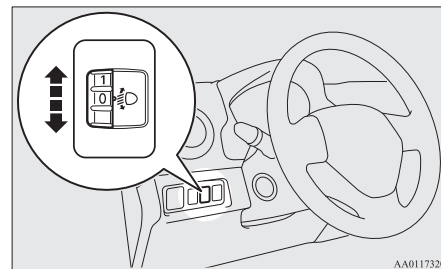

AA0117320

⚠ CAUTION

- Always perform adjustments before driving. Do not attempt to adjust while driving, as it could cause an accident.

NOTE

- When adjusting the beam position, first put the dial in the "0" position (the highest beam position).

Vehicle condition					
Switch position	"0"	"0"	"2"	"3"	"3"

•: 1 person

Full luggage loading

Switch position 0- Driver only/Driver + 1 front passenger

Switch position 2- 5 passengers (including driver)

Switch position 3- 5 passengers (including driver) + Full luggage loading/Driver + full luggage loading

Turn-signal lever

E00506501648

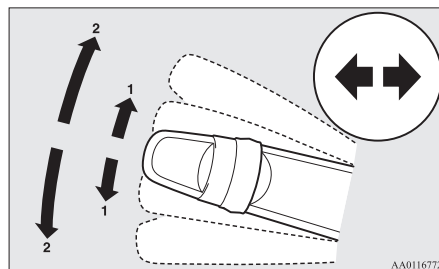

AA0116772

1- Turn-signals

When making a normal turn, use position (1). The lever will return automatically when cornering is completed.

2- Lane-change signals

When moving the lever to (2) slightly to change a lane, the turn-signal lamps and indication lamp in the instrument cluster will only flash while the lever is operated.

Also, when you move the lever to (2) slightly then release it, the turn-signal lamps and indication lamp in the instrument cluster will flash 3 times.

NOTE

- If the lamp flashes unusually quickly, the bulb in a turn-signal lamp may have burned out. We recommend you to have the vehicle inspected.
- It is possible to activate the following functions.

- Flashing of the turn-signal lamps when the lever is operated with the ignition switch or the operation mode is in ACC.
- Deactivate the turn-signal lamp 3-flash function for lane changes
- The time required to operate the lever for the 3-flash function can be adjusted.
- Changing of the tone of a sounding buzzer as the turn-signal lamps flash.

For further information, we recommend you to consult a MITSUBISHI MOTORS Authorized Service Point.

Hazard warning flasher switch

E00506601027

Use the hazard warning flasher switch when the vehicle has to be parked on the road for any emergency. The hazard warning flashers can always be operated, regardless of the ignition switch position or the operation mode.

Push the switch to turn on the hazard warning flashers, all turn-signal lamps flash continuously. To turn them off, push the switch again.

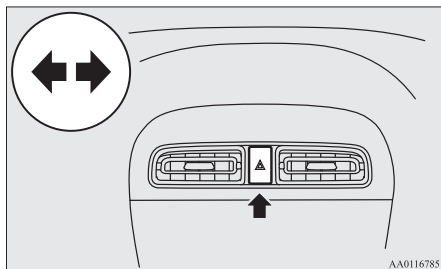

AA0116785

NOTE

- While the hazard warning lamps are blinking due to having manually pushed the switch, the emergency stop signal system does not operate. Refer to “Emergency stop signal system” on page 4-28.

Fog lamp switch

E00506700034

Front fog lamp switch*

E00508300685

The front fog lamps can be operated while the headlamps or tail lamps are on. Turn the knob in the “ON” direction to turn on the front fog lamps. An indication lamp in the instrument cluster will also come on. Turn the knob in the “OFF” direction to turn off the front fog lamps. The knob will automatically return to its original position when you release it.

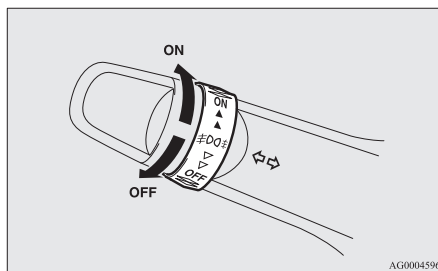

AG0004596

NOTE

- The front fog lamps are automatically turned off when the headlamps or tail lamps are turned off. To turn the front fog lamps on again, turn the knob in the “ON” direction after turning on the headlamps or tail lamps.
- Do not use fog lamps except in conditions of fog, otherwise excessive lamp glare may temporarily blind oncoming vehicle drivers.

Rear fog lamp switch

E00508400569

The rear fog lamp can be operated when the headlamps or front fog lamps (if so equipped) turn on. An indication lamp in the instrument cluster comes on when the rear fog lamp is turned on.

[Vehicle without front fog lamps]

Turn the knob once in the “ON” direction to turn on the rear fog lamp. To turn the rear fog lamp off, turn the knob once in the “OFF” direction. The knob will automatically return to its original position when you release it.

[Vehicle with front fog lamps]

Turn the knob once in the “ON” direction to turn on the front fog lamps. Turn the knob once more in the “ON” direction to turn on the rear fog lamp. To turn the rear fog lamp off, turn the knob once in the “OFF” direction. Turn the knob once more in the “OFF” direction to turn off the front fog lamps. The knob will automatically return to its original position when you release it.

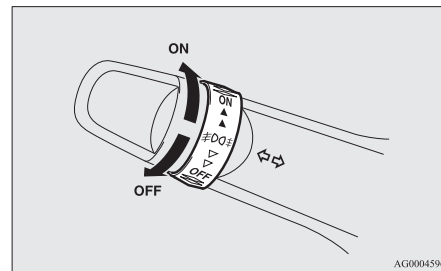

AG0004596

NOTE

- The rear fog lamp is automatically turned off when the headlamps or front fog lamps (if so equipped) are turned off.
- To turn the rear fog lamp on again, turn the knob once in the “ON” direction after turning on the headlamps. (Vehicle without front fog lamps)
- To turn the rear fog lamp on again, turn the knob twice in the “ON” direction after turning on the headlamps. (Vehicle with front fog lamps)

Wiper and washer switch

E00507101739

The windscreen wipers, rear window wiper and washer can be operated with the ignition switch or the operation mode in ON or ACC.

If the blades are frozen to the windscreen or rear window, do not operate the wipers until the ice has melted and the blades are freed, otherwise the wiper motor may be damaged.

CAUTION

- If the washer is used in cold weather, the washer fluid sprayed against the glass may freeze, which may hinder visibility. Warm the glass with the defroster or rear window demister before using the washer.

Windscreen wipers

E00516900680

Except for vehicles equipped with rain sensor

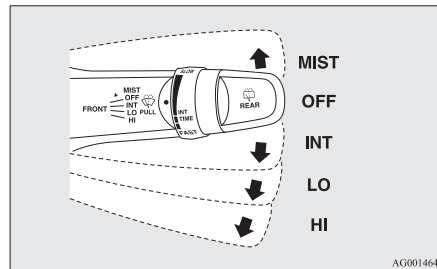

AG0014645

MIST- Misting function
The wipers will operate once.

OA0X13E4

OFF-	Off
INT-	Intermittent (Speed sensitive)
LO-	Slow
HI-	Fast

To adjust intermittent intervals

With the lever in the “INT” (speed-sensitive) position, the intermittent intervals can be adjusted by turning the knob (A).

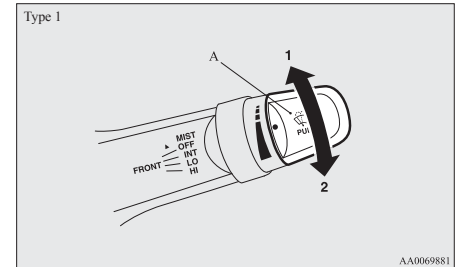

AA0069881

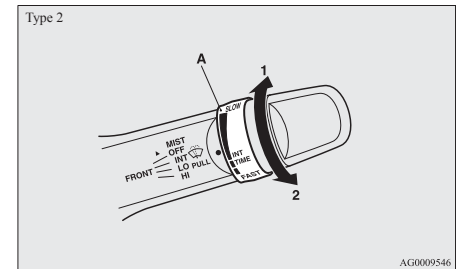

AG0009546

1- Fast
2- Slow

Instruments and controls

NOTE

- The speed-sensitive-operation function of the windscreen wipers can be deactivated. For further information, we recommend you to consult a MITSUBISHI MOTORS Authorized Service Point.

Misting function

Move the lever in the direction of the arrow and release, to operate the wipers once. Use this function when you are driving in mist or drizzle.

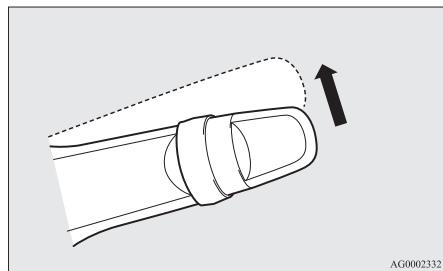

Vehicles with rain sensor

E00517000402

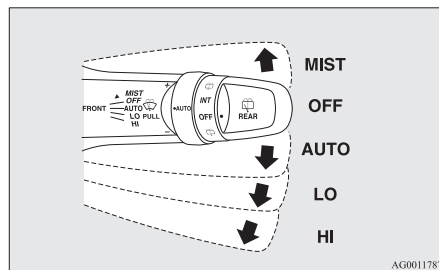

MIST-	Misting function The wipers will operate once.
OFF-	Off
AUTO-	Auto-wiper control Rain sensor The wipers will automatically operate depending on the degree of wetness on the windscreen.
LO-	Slow
HI-	Fast

Rain sensor

Can only be used when the ignition switch or the operation mode is in ON.

If the lever is put in the “AUTO” position, the rain sensor (A) will detect the extent of rain (or snow, other moisture, dust, etc.) and the wipers will operate automatically.

Keep the lever in the “OFF” position if the windscreen is dirty and the weather is dry.

Wiper operation under these conditions can scratch the windscreen and damage the wipers.

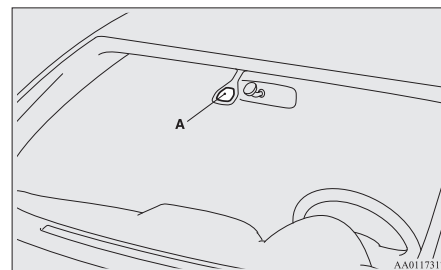

CAUTION

- With the ignition switch or the operation mode in ON and lever in the “AUTO” position, the wipers may automatically operate in the situations described below. If your hands get trapped, you could suffer injuries or the wipers could malfunction. Be sure to turn the ignition switch to the “LOCK” position or put the operation mode in OFF, or move lever to the “OFF” position to deactivate the rain sensor.
 - When cleaning the outside surface of the windscreen, if you touch on top of the rain sensor.
 - When cleaning the outside surface of the windscreen, if you wipe with a cloth on top of the rain sensor.
 - When using an automatic car wash.
 - A physical shock is applied to the windscreen.

A CAUTION

- A physical shock is applied to the rain sensor.

NOTE

- To protect the rubber parts of the wipers, this operation of the wipers does not take place when the vehicle is stationary and the ambient temperature is about 0 °C or lower.
- Do not cover the sensor by affixing a sticker or label to the windscreen. Also, do not put any water-repellent coating on the windscreen. The rain sensor would not be able to detect the extent of rain, and the wipers might stop working normally.
- In the following cases, the rain sensor may be malfunctioning.

For further information, we recommend you to consult a MITSUBISHI MOTORS Authorized Service Point.

 - When the wipers operate at a constant interval despite changes in the extent of rain.
 - When the wipers do not operate even though it is raining.
- The wipers may automatically operate when things such as insects or foreign objects are affixed to the windscreen on top of the rain sensor or when the windscreen is frozen. Objects affixed to the windscreen will stop the wipers when the wipers cannot remove them. To operate the wipers again, move the lever in the “LO” or “HI” position. Also, the wipers may operate automatically due to strong direct sunlight or electromagnetic wave. To stop the wipers, place the lever in the “OFF” position.

- Contact a MITSUBISHI MOTORS Authorized Service Point when replacing the windscreen or reinforcing the glass around the sensor.

To adjust the sensitivity of the rain sensor

With the lever in the “AUTO” (rain sensor) position, it is possible to adjust the sensitivity of the rain sensor by turning the knob (B).

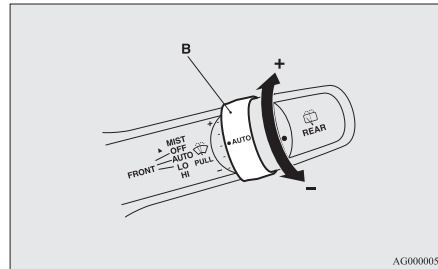

“+”- Higher sensitivity to rain

“-”- Lower sensitivity to rain

NOTE

- It is possible to activate the following functions.
 - Automatic operation (rain droplet sensitive) can be changed to intermittent operation (vehicle-speed sensitive).
 - Automatic operation (rain droplet sensitive) can be changed to intermittent operation (except vehicle-speed sensitive).

For further information, we recommend you to consult a MITSUBISHI MOTORS Authorized Service Point.

Misting function

Move the lever in the direction of the arrow and release, to operate the wipers once. Use this function when you are driving in mist or drizzle.

The wipers will operate once if the lever is raised to the “MIST” position and released when the ignition switch or the operation mode is in the “ON” or “ACC” position. The wipers will continue to operate while the lever is held in the “MIST” position.

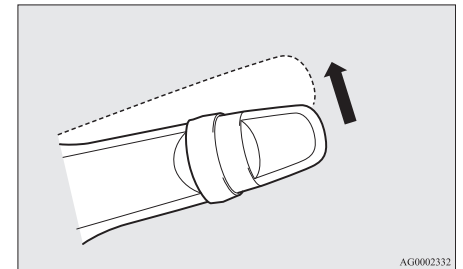

Instruments and controls

The wipers will operate once if the lever is moved to the “AUTO” position and the knob (C) is turned in the “+” direction when the ignition switch is in the “ON” position or the operation mode is in ON.

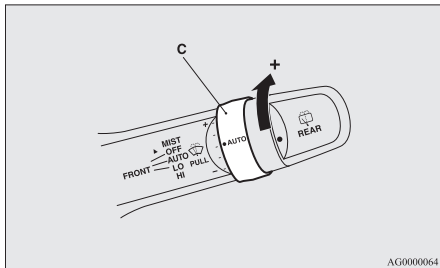

Windscreen washer

E00507201310

The washer fluid will be sprayed onto the windscreen by pulling the lever towards you. The wipers operate automatically several times while the washer fluid is being sprayed.

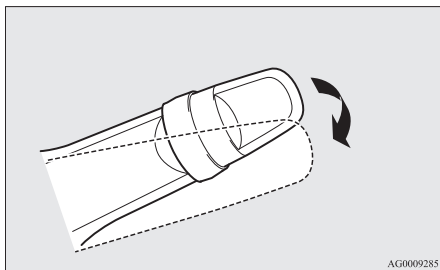

CAUTION

- If the washer is used in cold weather, the washer fluid sprayed against the glass may freeze resulting in poor visibility. Heat the glass with the defroster or demister before using the washer.

Rear window wiper and washer

E00507301379

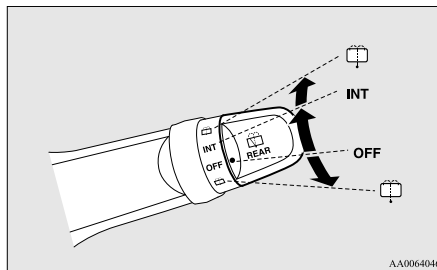

INT

- The wiper operates continuously for several seconds then operates intermittently at intervals of about every 8 seconds

OFF



- Off
- The washer fluid will be sprayed onto the rear window when the knob is turned fully in either direction. The wipers operate automatically several times while the washer fluid is being sprayed.

NOTE

- On vehicles with CVT, to ensure a clear rearward view, the wiper perform several continuous operations when the reverse gear is engaged and the switch is in the “INT” position. Following this continuous operation, the wiper will automatically switch to intermittent operation.
- It is possible to modify functions as follows:
 - Adjustment of the interval for intermittent operation.
 - Changing intermittent wiper operation to continuous wiper operation.

For further information, we recommend you to consult a MITSUBISHI MOTORS Authorized Service Point.

Precautions to observe when using wipers and washers

E00507600128

- If the moving wipers become blocked by ice or other deposits on the glass, the motor may burn out even if the wiper switch is turned to OFF. If obstruction occurs, park your vehicle in a safe place, turn off the engine, and clean the deposits from the glass so that the wipers operate smoothly.
- Do not use the wipers when the glass is dry. They may scratch the glass surface and the blades wear out prematurely.
- Before using the wipers in cold weather, check that the wiper blades are not frozen onto the glass. The motor may burn out if the wipers are used with the blades frozen onto the glass.
- Avoid using the washer continuously for more than 20 seconds. Do not operate the washer when the fluid reservoir is empty. Otherwise, the motor may burn out.

- Periodically check the level of washer fluid in the reservoir and refill if required. During cold weather, add a recommended washer solution that will not freeze in the washer reservoir. Failure to do so could result in loss of washer function and frost damage to the system components.

Rear window demister switch

E00507901287

The rear window demister switch can be operated when the engine is running.

Push the switch to turn on the rear window demister. It will be turned off automatically in about 20 minutes. To turn off the demister within about 20 minutes, push the switch again.

The indication lamp (A) will illuminate while the demister is on.

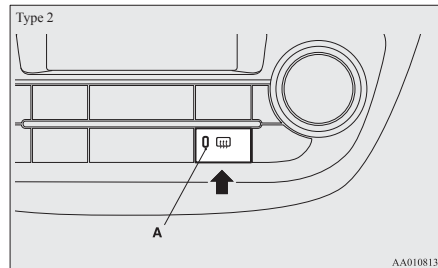
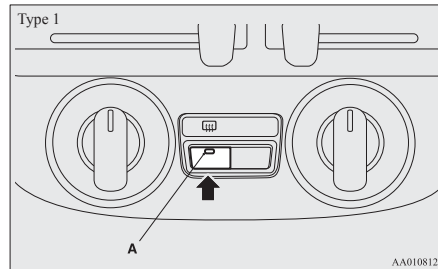

NOTE

- On vehicles equipped with heated mirrors, when the rear window demister switch is pressed, the outside rear-view mirrors are defogged or defrosted. Refer to “Heated mirror” on page 4-07.
- The demister switch is not to melt snow but to clear mist. Remove snow before use of the demister switch.
- To avoid unnecessary discharge of the battery, do not use the rear window demister during starting of the engine or when the engine is not running. Turn the demister off immediately after the window is clear.
- When cleaning the inside of the rear window, use a soft cloth and wipe gently along the heater wires, being careful not to damage the wires.
- Do not allow objects to touch the inside of the rear window glass, damaged or broken wires may result.

Instruments and controls

Horn switch

E00508000640

Press the steering wheel on or around the “” mark.

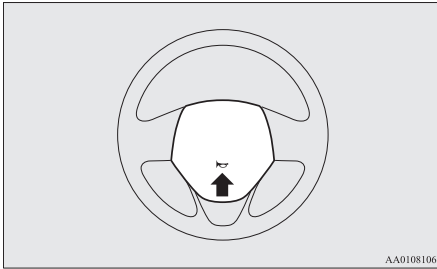

3

Starting and driving

Economical driving.....	4-02
Driving, alcohol and drugs.....	4-02
Safe driving techniques.....	4-03
Running-in recommendations.....	4-03
Parking brake.....	4-04
Parking.....	4-05
Steering wheel height adjustment.....	4-06
Inside rear-view mirror.....	4-06
Outside rear-view mirrors.....	4-07
Ignition switch*.....	4-08
Engine switch*.....	4-09
Steering wheel lock.....	4-11
Starting.....	4-12
Auto Stop & Go (AS&G) system*.....	4-15
Manual transmission*.....	4-19
Automatic transmission INVECS-III CVT (Intelligent & Innovative Vehicle Electronic Control System III)*.....	4-21
Braking.....	4-25
Hill start assist*.....	4-26
Brake assist system.....	4-27
Emergency stop signal system.....	4-28
Anti-lock brake system (ABS).....	4-28
Electric power steering system (EPS).....	4-30
Active stability control (ASC).....	4-30
Rear-view camera*.....	4-32
Cargo loads.....	4-34
Trailer towing (1200 models).....	4-35

Starting and driving

Economical driving

E00600101223

For economical driving, there are some technical requirements that have to be met. The prerequisite for low fuel consumption is a properly adjusted engine. In order to achieve longer life of the vehicle and the most economical operation, we recommend you to have the vehicle checked at regular intervals in accordance with the service standards.

Fuel economy and generation of exhaust gas and noise are highly influenced by personal driving habits as well as the particular operating conditions. The following points should be observed in order to minimize wear of brakes, tyres and engine as well as to reduce environmental pollution.

Starting

Avoid rapid acceleration and sudden starts; such operation will result in higher fuel consumption.

Shifting

Shift only at an appropriate speed and engine speed. Always use the highest shift position possible.

City traffic

Frequent starting and stopping increases the average fuel consumption. Use roads with smooth traffic flow whenever possible. When driving on congested roads, avoid use of a low shift position at high engine speeds.

Idling

The vehicle consumes fuel even during idling. Avoid extended idling whenever possible.

Speed

At higher vehicle speed, more fuel is consumed. Avoid driving at full speed. Even a slight release of the accelerator pedal will save a significant amount of fuel.

Tyre inflation pressure

Check the tyre inflation pressures at regular intervals. Low tyre inflation pressure increases road resistance and fuel consumption. In addition, low tyre pressures adversely affect tyre wear and driving stability.

Load

Do not drive with unnecessary articles in the luggage compartment. Especially during city driving where frequent starting and stopping is necessary, the increased weight of the vehicle will greatly affect fuel consumption. Also avoid driving with unnecessary luggage, etc., on the roof; the increased air resistance will increase fuel consumption.

Cold engine starting

Starting of a cold engine consumes more fuel. Unnecessary fuel consumption is also caused by keeping a hot engine running. After the engine is started, commence driving as soon as possible.

Air conditioning

The use of the air conditioning will increase the fuel consumption.

Driving, alcohol and drugs

E00600200096

Driving after drinking alcohol is one of the most frequent causes of accidents.

Your driving ability can be seriously impaired even with blood alcohol levels far below the legal minimum. If you have been drinking, don't drive. Ride with a designated non-drinking driver, call a cab or a friend, or use public transportation. Drinking coffee or taking a cold shower will not make you sober. Similarly, prescription and nonprescription drugs affect your alertness, perception and reaction time. Consult with your doctor or pharmacist before driving while under the influence of any of these medications.

WARNING

- **NEVER DRINK AND DRIVE.**
Your perceptions are less accurate, your reflexes are slower and your judgment is impaired.

Safe driving techniques

E00600300619

Driving safety and protection against injury cannot be fully ensured. However, we recommend that you pay extra attention to the following:

Seat belts

Before starting the vehicle, make sure that you and your passengers have fastened your seat belts.

Floor mats

⚠ WARNING

- Keep floor mats clear of the pedals by correctly laying floor mats that are suitable for the vehicle.

To prevent the floor mats from slipping out of position, securely retain them using the hook etc.

Note that laying a floor mat over a pedal or laying one floor mat on top of another can obstruct pedal operation and lead to a serious accident.

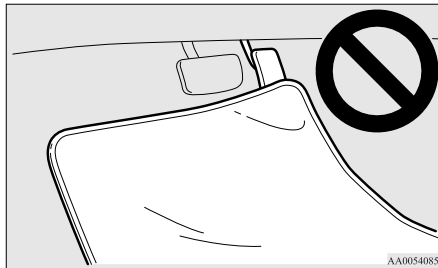

AA0054085

Carrying children in the vehicle

- Never leave your vehicle unattended with the key and children inside the vehicle. Children may play with the driving controls and this could lead to an accident.
- Make sure that infants and small children are properly restrained in accordance with the laws and regulations, and for maximum protection in case of an accident.
- Prevent children from playing in the luggage compartment. It is quite dangerous to allow them to play there while the vehicle is moving.

Loading luggage

When loading luggage, be careful not to load above the height of seats. This is dangerous not only because rearward vision will be obstructed, but also the luggage may be projected into the passenger compartment under hard braking.

Running-in recommendations

E00600402597

During the running-in period for the first 1,000 km (620 miles), it is advisable to drive your new vehicle using the following precautions as a guideline to aid long life as well as future economy and performance.

- Do not race the engine at high speeds.
- Avoid rapid starting, accelerating, braking and prolonged high-speed running.
- Keep to the running-in speed limit shown below.

Please note that the legal speed limits displayed must be adhered to.

- Do not exceed loading limits.
- Refrain from towing a trailer.

Vehicles with M/T

Shift point	Speed limit
1 st gear	35 km/h (22 mph)
2 nd gear	65 km/h (40 mph)
3 rd gear	95 km/h (59 mph)
4 th gear	120 km/h (74 mph)
5 th gear	145 km/h (90 mph)

Vehicles with CVT

Shift point	Speed limit
“D” (DRIVE)	100 km/h (62 mph)

Starting and driving

Parking brake

E00600501751

To park the vehicle, first bring it to a complete stop, fully apply the parking brake sufficiently to hold the vehicle.

To apply

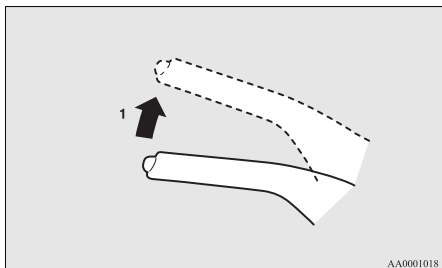

1- Firmly depress and hold the brake pedal, then pull the lever up without pushing the button at the end of hand grip.

CAUTION

- When you intend to apply the parking brake, firmly press the brake pedal to bring the vehicle to a complete stop before pulling the parking brake lever. Pulling the parking brake lever with the vehicle moving could make the rear wheels lock up, thereby making the vehicle unstable. It could also make the parking brake malfunction.

NOTE

- Apply sufficient force to the parking brake lever to hold the vehicle stationary after the foot brake is released.
- If the parking brake does not hold the vehicle stationary after the foot brake is released, have your vehicle checked immediately.

To release

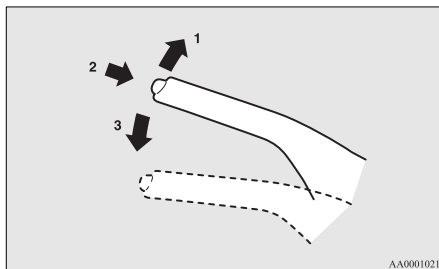

- 1- Firmly depress and hold the brake pedal, then pull the lever up slightly.
- 2- Push the button at the end of hand grip.
- 3- Lower the lever fully.

CAUTION

- Before driving, be sure that the parking brake is fully released and brake warning lamp is off. If you drive without the parking brake fully released, the warning lamp will illuminate and a buzzer sounds when the vehicle speed exceeds 8 km/h (5 mph). If a vehicle is driven without releasing the parking brake, the brake will be overheated, resulting in ineffective braking and possible brake failure.
- If the brake warning lamp does not extinguish when the parking brake is fully released, the brake system may be abnormal. Have your vehicle checked immediately. For details, refer to “Brake warning lamp” on page 3-12.

Parking

E00600601589

To park the vehicle, fully engage the parking brake, and then move the gearshift lever to 1st or “R” (Reverse) position for vehicles with M/T, or set the selector lever to “P” (PARK) position for vehicles with CVT.

Parking on a hill

To prevent the vehicle from rolling, follow these procedures:

Parking on a downhill slope

Turn the front wheels towards the kerb and move the vehicle forward until the kerb side wheel gently touches the kerb.

Apply the parking brake and place the gearshift lever into the “R” (Reverse) position (M/T) or the selector lever into the “P” (PARK) position (CVT). If necessary, apply chocks to wheels.

Parking on an uphill slope

Turn the front wheels away from the kerb and move the vehicle back until the kerb side wheel gently touches the kerb.

Apply the parking brake and place the gearshift lever into the 1st position (M/T) or the selector lever into the “P” (PARK) position (CVT). If necessary, apply chocks to wheels.

NOTE

- If your vehicle is equipped with CVT, be sure to apply the parking brake before moving the selector lever to the “P” (PARK) position. If you move the selector lever to the “P” (PARK) position before applying the parking brake, it may be difficult to disengage the selector lever from the “P” (PARK) position when next you drive the vehicle, requiring application of a strong force to the selector lever to move from the “P” (PARK) position.

Parking with the engine running

Never leave the engine running while you take a short sleep/rest. Also, never leave the engine running in a closed or poorly ventilated place.

WARNING

- Leaving the engine running risks injury or death from accidentally moving the gearshift lever (M/T) or the selector lever (CVT) or the accumulation of toxic exhaust fumes on the passenger compartment.

Where you park

WARNING

- Do not park your vehicle in areas where combustible materials such as dry grass or leaves can come in contact with a hot exhaust, since a fire could occur.

Do not keep the steering wheel fully turned for a long time

More effort could be required to turn the steering wheel.

Refer to “Electric power steering system (EPS)” on page 4-30.

When leaving the vehicle

Always carry the key and lock all doors and the tailgate when leaving the vehicle unattended.

Always try to park your vehicle in a well lit area.

Starting and driving

Steering wheel height adjustment

E00600700554

1. Release the lever while holding the steering wheel up.
2. Adjust the steering wheel to the desired position.
3. Securely lock the steering wheel by pulling the lever fully upward.

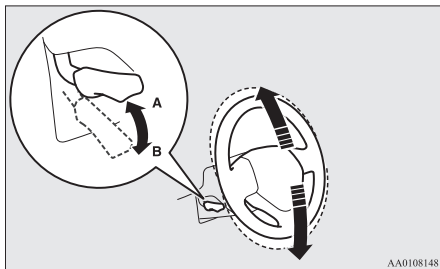

A- Locked
B- Release

⚠ WARNING

- Do not attempt to adjust the steering wheel while you are driving the vehicle.

⚠ CAUTION

- When releasing the lever, hold the steering wheel by hand to prevent it falling to the lowest position.

Inside rear-view mirror

E00600800816

Adjust the rear-view mirror only after making any seat adjustments so you have a clear view to the rear of the vehicle.

⚠ WARNING

- Do not attempt to adjust the rear-view mirror while driving. This can be dangerous. Always adjust the mirror before driving.

Adjust the rear-view mirror to maximize the view through the rear window.

To adjust the vertical mirror position

It is possible to move the mirror up and down to adjust its position.

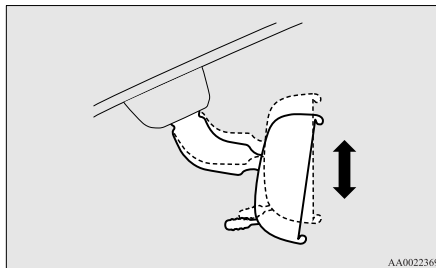

To adjust the mirror position

It is possible to move the mirror up/down and left/right to adjust its position.

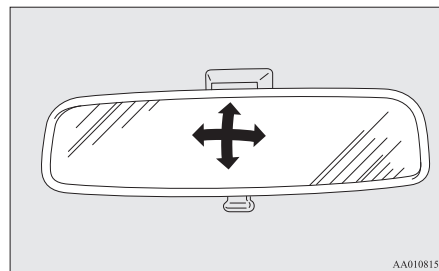

To reduce the glare

The lever (A) at the bottom of the mirror can be used to adjust the mirror to reduce the glare from the headlamps of vehicles behind you during night driving.

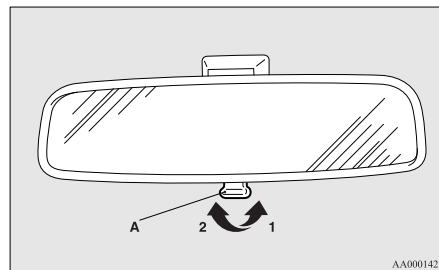

- 1- Normal
2- Anti-glare

Outside rear-view mirrors

E00600900761

⚠ WARNING

- Do not attempt to adjust the rear-view mirrors while driving. This can be dangerous. Always adjust the mirrors before driving.
- Your vehicle is equipped with convex type mirrors. Please take into consideration. Objects you see in the mirror will look smaller and farther away compared to a normal flat mirror. Do not use this mirror to estimate distance of following vehicles when changing lanes.

To adjust the mirror position

E00601000730

Manual outside rear-view mirrors*

Adjust the mirror surface by hands as indicated by the arrows.

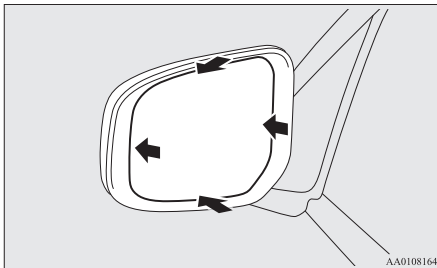

Electric remote-controlled outside rear-view mirrors*

E00610900067

The outside rear-view mirrors can be adjusted when the ignition switch or the operation mode is in ON or ACC.

1. Place the lever (A) to the same side as the mirror whose adjustment is desired.

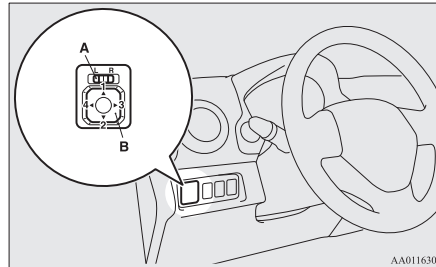

L- Left outside mirror adjustment
R- Right outside mirror adjustment

2. Press the switch (B) to the left, right, up or down to adjust the mirror position.
 - 1- Up
 - 2- Down
 - 3- Right
 - 4- Left
3. Return the lever (A) back to the middle position (•).

Retracting and extending the outside mirrors

E00618200444

The outside mirror can be folded in towards the side window to prevent damage when parking in narrow areas.

⚠ CAUTION

- Do not drive the vehicle with the mirror folded in. The lack of rearward visibility normally provided by the mirror could lead to an accident.

Push the mirror towards the back of the vehicle with your hand to retract it. When extending the mirror, pull it out towards the front of the vehicle until it clicks to lock in place.

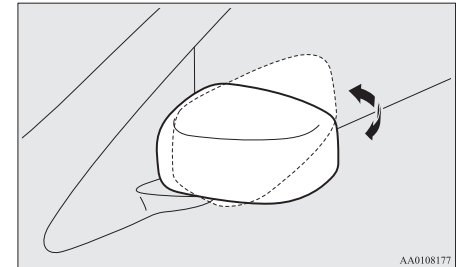

Heated mirror*

E00601200569

To demist or defrost the outside rear-view mirrors, press the rear window demister switch. The indication lamp (A) will illuminate while the demister is on.

Starting and driving

The heater will be turned off automatically in about 20 minutes.

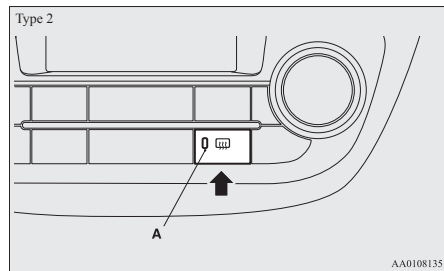
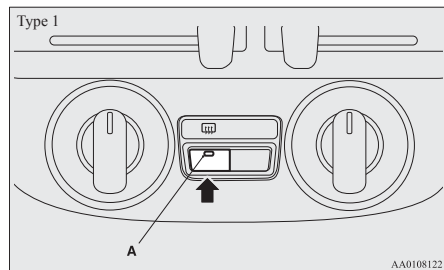

Ignition switch*

E00601401975



LOCK

The engine is stopped and the steering wheel locked. The key can only be inserted and removed in this position.

ACC

The engine is stopped, but the audio system and other electric devices can be operated.

ON

All the vehicle's electrical devices can be operated.

START

The starter motor operates. After the engine has started, release the key and it will automatically return to the "ON" position.

NOTE

- If your vehicle is equipped with an electronic immobilizer. To start the engine, the ID code which the transponder inside the key sends must match the one registered in the immobilizer computer.
(Refer to "Electronic immobilizer (Anti-theft starting system)" on page 1-03.)

To remove the key

E00620400502

For vehicles equipped with a M/T, when removing the key, push the key in at the "ACC" position and keep it depressed until it is turned to the "LOCK" position and remove it.

For vehicles equipped with CVT when removing the key, first set the selector lever to the "P" (PARK) position, and push the key in at the "ACC" position and keep it depressed until it is turned to the "LOCK" position, and remove it.

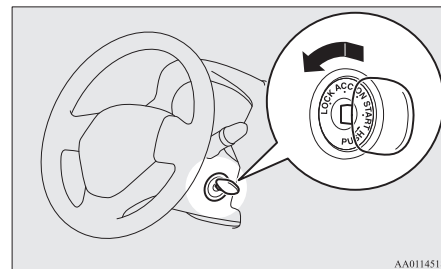

CAUTION

- Do not remove the ignition key from the ignition switch while driving. The steering wheel will be locked, causing loss of control.
- If the engine is stopped while driving, the brake servomechanism will cease to function and braking efficiency will deteriorate. Also, the power steering system will not function and it will require greater manual effort to operate the steering.
- Do not leave the key in the “ON” position for a long time when the engine is not running, doing so will cause the battery to be discharged.
- Do not turn the key to the “START” position when the engine is running, doing so could damage the starter motor.

Engine switch*

E00631800069

In order to prevent theft, the engine will not start unless a preregistered keyless operation key is used. (Engine immobilizer function)
If you are carrying the keyless operation key, you can start the engine.

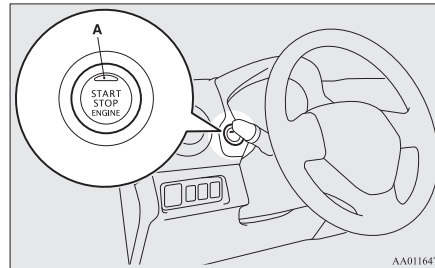
**CAUTION**

- The indication lamp (A) will flash orange when there is a problem or malfunction in the keyless operation system. Never drive if the indication lamp on the engine switch is flashing orange. Immediately contact a MITSUBISHI MOTORS Authorized Service Point.
- If the engine switch operation is not smooth and feels like it is sticking, do not operate the switch. Immediately contact a MITSUBISHI MOTORS Authorized Service Point.

NOTE

- When operating the engine switch, press the switch all the way in. If the switch is not fully pressed, the engine may not start or the operation mode may not change. If the engine switch is pressed correctly, there is no need to hold the engine switch down.
- When the battery in the keyless operation system key has worn out, and taking the keyless operation key out of the vehicle, a warning lamp will blink for 5 seconds.

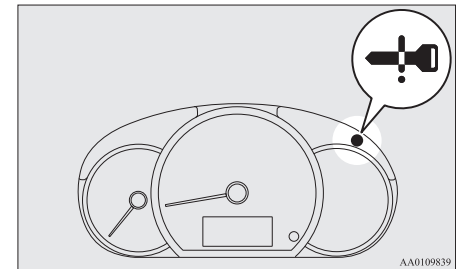
**Operation mode of the engine switch and its function****OFF**

The indication lamp on the engine switch turns off. The operation mode cannot be put in OFF when the selector lever is in any position other than the “P” (PARK) position (CVT).

ACC

Electrical devices such as the audio and accessory socket can be operated.

The indication lamp on the engine switch illuminates orange.

Starting and driving

ON

All vehicle's electrical devices can be operated. The indication lamp on the engine switch illuminates green. The indication lamp turns off when the engine is running.

NOTE

- Your vehicle is equipped with an electronic immobilizer. To start the engine, the ID code transmitted by the transponder inside the key must match the code registered in the immobilizer computer. Refer to "Electronic immobilizer (Anti-theft starting system)" on page 1-03.

Changing the operation mode

E00631900015

If you press the engine switch without depressing the brake pedal (CVT) or the clutch pedal (M/T), you can change the operation mode in the order of OFF, ACC, ON, OFF.

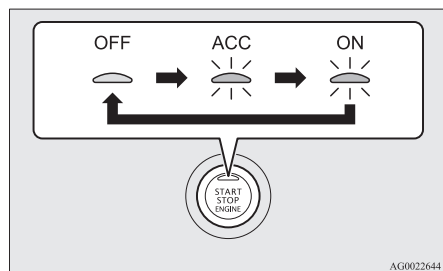

CAUTION

- When the engine is not running, put the operation mode in OFF. Leaving the operation mode in ON or ACC for a long time when the engine is not running may cause the battery to be discharged, making it impossible to start the engine, lock and unlock the steering wheel.
- When the battery is disconnected, the current operation mode is memorized. After reconnecting the battery, the memorized mode is selected automatically. Before disconnecting the battery for repair or replacement, make sure to put the operation mode in OFF.

Be careful if you are not sure which operation mode the vehicle is in when the battery is run down.

- The operation mode cannot be changed from OFF to ACC or ON if the keyless operation key is not detected to be in the vehicle. Refer to "Keyless operation system: operating range for starting the engine and changing the operation mode" on page 1-06.

Operation mode OFF reminder system

E00632200015

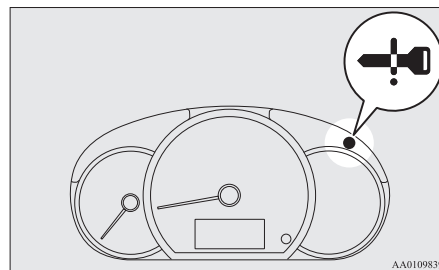

When the operation mode is in any mode other than OFF, if you close all the doors and the tailgate then try to lock the doors and tailgate by pressing the driver's door switch, or the tailgate switch, a warning lamp will blink and the outer buzzer will sound for approximately 3 seconds and you cannot lock the doors and tailgate.

Operation mode ON reminder system

E00632300016

If the driver's door is opened with the engine stopped and the operation mode in any mode other than OFF, the operation mode ON reminder inner buzzer sounds intermittently to remind you to put the operation mode in OFF.

Steering wheel lock

E00601500751

[Except for vehicles equipped with keyless operation system]

To lock

Remove the key at the “LOCK” position.
Turn the steering wheel until it is locked.

To unlock

Turn the key to the “ACC” position while moving the steering wheel slightly right and left.

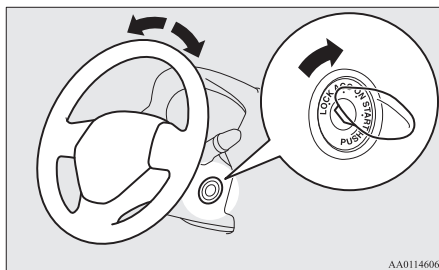

AA0114606

CAUTION

- Remove the key when leaving the vehicle. In some countries, it is prohibited to leave the key in the vehicle when parked.

[For vehicles equipped with keyless operation system]

To lock

After pressing the engine switch and operation mode in OFF, when driver's door is opened, the steering wheel is locked.

NOTE

- When the following operation is performed with the operation mode in OFF, the steering wheel is locked.
 - Open or close the driver's door.
 - Close all the doors.
 - Open one of the doors when all the doors are closed.
 - Press the LOCK switch on the keyless operation key, the driver's door switch or the tailgate switch.
 - The selector lever is the “P” (PARK) position (CVT).
- When the door is opened while the steering wheel does not unlock, the buzzer sounds to alert the steering wheel is unlocked.

To unlock

The following methods can be used to unlock the steering wheel.

- Put the operation mode in ACC.
- Start the engine.

CAUTION

- If the engine is stopped while driving, do not open a door or press the LOCK switch on the remote control switch until the vehicle stops in a safe place. This could cause the steering wheel to lock, making it impossible to operate the vehicle.
- Carry the key with you when leaving the vehicle.
If your vehicle needs to be towed, perform the following operation to unlock the steering wheel.
 - On vehicles with M/T, put the operation mode in ACC or ON.
 - On vehicles with CVT, put the operation mode in ON.

NOTE

- When the steering wheel does not unlock, the warning lamp will blink and the inner buzzer will sounds. Press the engine switch again while moving the steering wheel slightly right and left.
- When the steering wheel lock is abnormal, the warning lamp illuminates. Put the operation mode in OFF and then press the lock switch of the keyless operation key. And then press the engine switch, If the warning lamp illuminates again, contact a

Starting and driving

MITSUBISHI MOTORS Authorized Service Point.

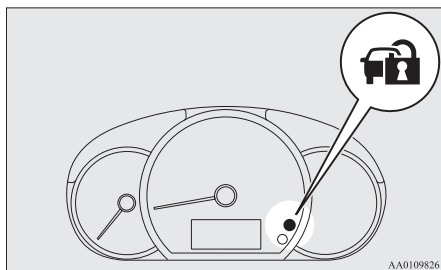

- If there is a fault in the steering wheel lock, the warning lamp illuminates and the inner buzzer sounds. Immediately stop the vehicle in a safe place and contact a MITSUBISHI MOTORS Authorized Service Point.

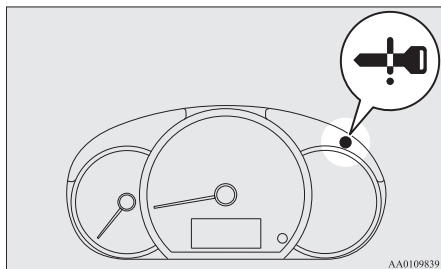

Starting

E00601601052

E00632400020

Tips for starting

[Except for vehicles equipped with keyless operation system]

Do not operate the starter motor continuously longer than 10 seconds; doing so could run down the battery. If the engine does not start, turn the ignition switch back to “LOCK”, wait a few seconds, and then try again.

Trying repeatedly with the starter motor still turning will damage the starter mechanism.

⚠ WARNING

- Never run the engine in a closed or poorly ventilated area any longer than is needed to move your vehicle in or out of the area. Carbon monoxide gases are odourless and can be fatal.

⚠ CAUTION

- Never attempt to start the engine by pushing or pulling the vehicle.
- Do not run the engine at high rpm or drive the vehicle at high speed until the engine has had a chance to warm up.
- Release the ignition key as soon as the engine starts to avoid damaging the starter motor.

[For vehicles equipped with keyless operation system]

- The operation mode can be in any mode to start the engine.
- The starter motor will be turning for up to approximately 15 seconds if the engine switch is released at once. Pressing the engine switch again while the starter motor is still turning will stop the starter motor. The starter motor will be turning for up to approximately 30 seconds while the engine switch is pressed.

If the engine does not start, wait for a while and then attempt to start the engine again. Trying repeatedly with the starter motor still turning will damage the starter mechanism.

⚠ WARNING

- Never run the engine in a closed or poorly ventilated area any longer than is needed to move your vehicle in or out of the area. Carbon monoxide gases are odourless and can be fatal.

⚠ CAUTION

- Never attempt to start the engine by pushing or pulling the vehicle.
- Do not run the engine at high rpm or drive the vehicle at high speed until the engine has had a chance to warm up.

Starting the engine

E00601702409

[Except for vehicles equipped with keyless operation system]

The starting procedure is as follows:

1. Insert the ignition key and fasten the seat belt.
2. Make sure the parking brake is applied.
3. Depress and hold the brake pedal.
4. Fully depress the clutch pedal (M/T).
5. On vehicles with M/T, place the gearshift lever in the “N” (Neutral) position. On vehicles with CVT, make sure the selector lever is in the “P” (PARK) position.

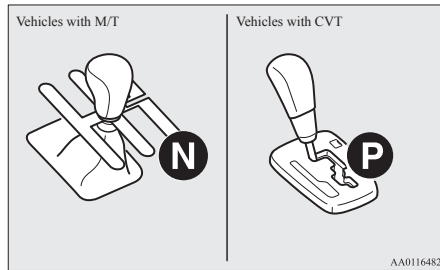

6. After turning the ignition key to the “ON” position, make certain that all warning lamps are functioning properly before starting the engine.
7. Turn the ignition key to the “START” position and release it when the engine starts.

NOTE

- Minor noises may be heard on engine start-up. These will disappear as the engine warms up.

When it is difficult to start the engine

After several attempts, you may experience that the engine still does not start.

1. Make sure that all electric devices, such as lamps, air conditioning blower and rear window demister, are turned off.
2. While depressing the brake pedal on vehicles equipped with CVT or the clutch pedal on the vehicles equipped with manual transmission, press the accelerator pedal halfway and hold it there, then crank the engine. Release the accelerator pedal, immediately after the engine starts.
3. If the engine still will not start, the engine could be flooded with too much petrol. While depressing the brake pedal on vehicles equipped with CVT or the clutch pedal on the vehicles equipped with manual transmission, push the accelerator pedal all the way down and hold it there, then crank the engine for 5 to 6 seconds. Return the ignition switch to the “LOCK” position and release the accelerator pedal. Wait a few seconds, and then crank the engine again for 5 to 6 seconds while depressing the brake pedal or the clutch pedal, but do not push the accelerator pedal. Release the ignition key if the engine starts. If the engine fails to start, repeat these procedures. If the engine still will not start, we recommend you to have the vehicle checked.

[For vehicles equipped with keyless operation system]

This vehicle is equipped with an electronically controlled fuel injection system. When starting the engine, do not depress the accelerator pedal.

The starting procedure is as follows:

1. Fasten the seat belt.
2. Make sure the parking brake is applied.
3. Depress and hold the brake pedal.
4. Fully depress and hold the clutch pedal (M/T).
5. On vehicles with M/T, place the gearshift lever in the “N” (Neutral) position. On vehicles with CVT, make sure the selector lever is in the “P” (PARK) position.

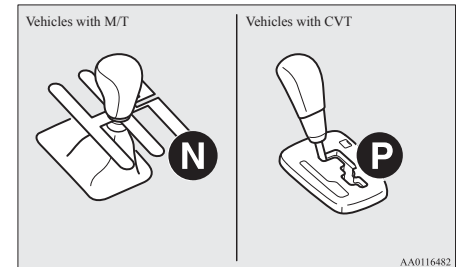

6. Press the engine switch.
7. Make sure that all warning lamps are functioning properly.

NOTE

- Minor noises may be heard on engine start-up. These will disappear as the engine warms up.

When it is difficult to start the engine

After several attempts, you may experience that the engine still does not start.

1. Make sure that all electric devices, such as lamps, air conditioning blower and rear window demister, are turned off.

Starting and driving

2. While depressing the brake pedal on vehicles equipped with CVT or the clutch pedal on the vehicles equipped with manual transmission, press the accelerator pedal halfway and hold it there, then crank the engine. Release the accelerator pedal, immediately after the engine starts.
3. If the engine still will not start, the engine could be flooded with too much petrol. While depressing the brake pedal on vehicles equipped with CVT or the clutch pedal on the vehicles equipped with manual transmission, push the accelerator pedal all the way down and hold it there, then press the engine switch to crank the engine. If the engine does not start after 5 to 6 seconds, push the engine switch to stop cranking the engine, and release the accelerator pedal. Put the operation mode in OFF. Wait a few seconds, and then press the engine switch to crank the engine again while depressing the brake pedal or the clutch pedal, but do not push the accelerator pedal. If the engine fails to start, repeat these procedures. If the engine still will not start, we recommend you to have the vehicle checked.

Stopping the engine

E00632700010

[For vehicles equipped with keyless operation system]

⚠ WARNING

- **Do not operate the engine switch while driving except in an emergency. If the engine is stopped while driving, the brake servomechanism will cease to function and braking efficiency will deteriorate. Also, the power steering system will not function and it will require greater manual effort to operate the steering. This could result in a serious accident.**

NOTE

- If you have to bring the engine to an emergency stop while driving, press and hold the engine switch for 3 seconds or more, or press it quickly 3 times or more. The engine will stop and the operation mode will go to ACC.
- Do not stop the engine with the selector lever in any position other than the “P” (PARK) position (CVT). If the engine is stopped with the selector lever in any position other than the “P” (PARK) position, the operation mode will go to ACC rather than OFF. Put the operation mode in OFF after placing the selector lever in the “P” (PARK) position.

1. Stop the vehicle.
2. Fully engage the parking brake while depressing the brake pedal.

3. On vehicles with M/T, press the engine switch to stop the engine, move the gearshift lever to the 1st (on a uphill) or “R” (Reverse) (on a downhill) position.
On vehicles with CVT, move the selector lever to the “P” (PARK) position, press the engine switch to stop the engine.

If the keyless operation key is not operating properly

E00632500050

Insert the keyless operation key into the key slot. Starting the engine and changing the operation mode should now be possible. Remove the keyless operation key from the key slot after starting the engine or changing the operation mode.

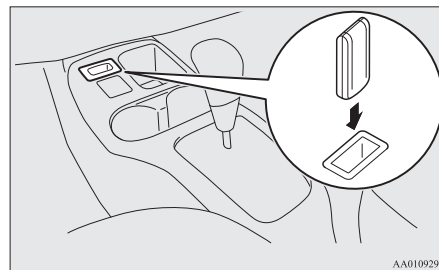

NOTE

- Do not insert into the key slot anything other than the keyless operation key. This could cause damage or a malfunction.

- Remove the object or additional key from the the keyless operation key before inserting the key into the key slot. The vehicle may not be able to receive the registered ID code from the registered key. Therefore, the engine may not start and the operation mode may not change.

Keyless operation key reminder*

E0063260022

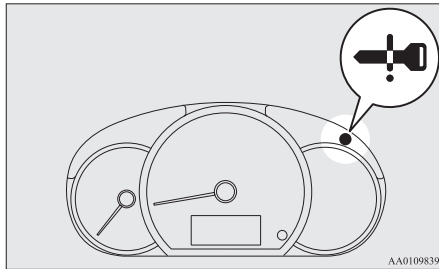

If the operation mode is in OFF and the driver's door is opened with the keyless operation key in the key slot, the warning lamp will blink and the outer buzzer sounds for approximately 3 seconds and the inner buzzer sounds for approximately 1 minute to remind you to remove the key.

Auto Stop & Go (AS&G) system*

E00627400080

The Auto Stop & Go (AS&G) system automatically stops and restarts the engine without operating the ignition switch or engine switch when the vehicle is stopped, such as at a traffic light or in a traffic jam, to reduce exhaust gases, increase fuel efficiency.

CAUTION

- If the vehicle will be stopped for a long time or if you will leave the vehicle unattended, stop the engine.

NOTE

- The accumulated time the engine has been stopped by Auto Stop & Go (AS&G) system is displayed in the multi information display. Refer to "AS&G monitor*" on page 3-05.

Automatically stopping the engine

E00627500124

The Auto Stop & Go (AS&G) system is automatically activated when the ignition switch is turned to the "ON" position or the operation mode is put in ON.

You can deactivate the system by pressing the "Auto Stop & Go (AS&G) OFF" switch.

Refer to "To deactivate" on page 4-18.

When the Auto Stop & Go (AS&G) system will operate, the indication lamp will turn on to inform the driver.

Indication lamp



[For vehicles with M/T]

1. Stop the vehicle.
2. While depressing the brake pedal, fully depress the clutch pedal and place the gearshift lever in the "N" (Neutral) position.

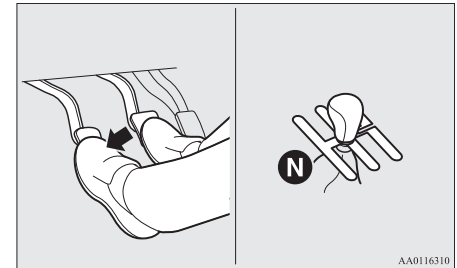

3. Release the clutch pedal. The engine will stop automatically.

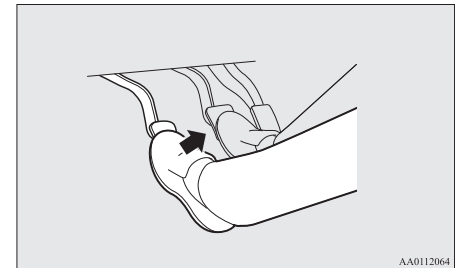

Starting and driving

[For vehicles with CVT]

1. Stop the vehicle.
2. Depressing the brake pedal. The engine will stop automatically.

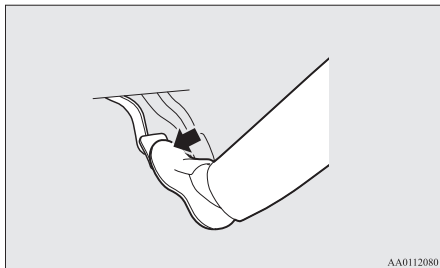

NOTE

- When the engine is automatically stopped, changes will occur in the driving operations. Pay close attention to the following.
 - The brake booster becomes inoperative and the pedal effort will increase. If the vehicle is moving, press down the brake pedal harder than usual.
 - The electric power steering system (EPS) becomes inoperative and it will become harder to turn the steering wheel.

⚠ CAUTION

- Observe the following precautions when the engine is stopped automatically. Otherwise, an unexpected accident might occur when the engine restarts automatically.

⚠ CAUTION

- Do not depress the accelerator pedal to race the engine while the vehicle is stopped (regardless of whether the engine is running or stopped). Otherwise, an unexpected accident might occur when the engine restarts automatically.
- If the driver's seat belt is unfastened and driver's door is opened or if the bonnet is opened, the indication lamp/indicator display will blink to inform the driver and buzzer sounds (CVT). If this occurs, the engine will not restart automatically, the seat belt is re-fastened, driver's door is closed and the bonnet is closed. On vehicles with M/T, while depressing the brake pedal, fully depress the clutch pedal to start the engine. On vehicles with CVT, while depressing the brake pedal, move the selector lever to the "P" (PARK) or "N" (NEUTRAL) position to start the engine. For details, refer to "Starting" on page 4-12.

⚠ CAUTION

- On vehicles with M/T, do not move the gearshift lever to a position other than the "N" (Neutral) position. If the gearshift lever is moved to a position other than the "N" (Neutral) position, the indication lamp/indicator display blinks and the buzzer sounds. If the gearshift lever is returned to the "N" (Neutral) position, the indication lamp/indicator display stops blinking and the buzzer stops sounding. The engine will not restart if the gearshift lever is in a position other than the "N" (Neutral) position.

NOTE

- In the following cases, the Auto Stop & Go (AS&G) system will not operate and the engine will not stop automatically even if the vehicle is stopped. The indication lamp/indicator display will not turn on.
 - Driver's seat belt is not fastened
 - When the driver's door is opened
 - Bonnet is open
 - After the engine restarts automatically, the vehicle speed has not exceeded approximately 5 km/h (3 mph)
 - After the engine start, approximately 30 seconds or more have not elapsed
 - After the engine restarts automatically and the vehicle stops again within 10 seconds.
 - Engine coolant temperature is low

- Ambient temperature is lower than approximately 3 °C
- When the heater is operated, vehicle indicator temperature is not still hot enough.
- Air conditioning is operating and passenger compartment has not sufficiently cooled
- Demister switch is pressed
Refer to “Demisting of the windscreen and door windows: For quick demisting” on page 5-11.
- When the air conditioner is operated in AUTO mode where the temperature control is set to the max. hot or the max. cool.
- Electric power consumption is high, such as when the rear window demister or other electrical components are operating or the blower speed is set to a high setting.
- Battery voltage or battery performance is low
- Check engine warning lamp is illuminated or the  indication lamp is blinking
- Brake booster vacuum pressure is low because the brake pedal is depressed repeatedly or depressed harder than usual (the indication lamp will turn on)
- The selector lever is other than in the “D” (DRIVE) position (CVT)
- ASC operation indicator and ASC OFF indicator is turn on (CVT)
- CVT warning lamp will turn on/warning display will display (CVT)
- In the following cause, the engine will not stop automatically even if indication lamp/indicator display turn on.
 - Push the accelerator pedal
 - Brake booster vacuum pressure is low
 - Operate the steering wheel

- Brake pedal is not sufficiently depressed (CVT)
- Parking on steep hill (CVT)
- Parking brake operates (CVT)
- If the Auto Stop & Go (AS&G) system operates while the air conditioner is operating, both the engine and the air conditioning compressor will stop. Therefore, only the blower will operate.
- If the demisting function and the Auto Stop & Go (AS&G) system are needed at the same time, it is recommended to set the mode selection to the Foot/Demister position. Refer to “Mode selection” on page 5-02.
- If the air conditioner is operating, set the temperature control higher to lengthen the time that the engine is stopped automatically.



Automatically restarting the engine

E00627600125

On vehicles with M/T, depress the clutch pedal while the gearshift lever is in the “N” (Neutral) position. The indication lamp turns off and the engine restarts automatically.

On vehicles with CVT, Release the brake pedal. The indication lamp turns off and the engine restart automatically.

NOTE

- If the engine does not restart automatically or if the engine stalls, the charge warning lamp and check engine warning lamp will illuminate. One vehicles with CVT,  indicator blinks, and buzzer sounds. If the engine is started, the buzzer stops sounding. But  indicator is blinking until the engine is stopped. If this occurs, on vehicles with M/T, the engine will not restart even if the clutch pedal is depressed again. While depressing the brake pedal, fully depress the clutch pedal to start the engine. On vehicles with CVT, the engine will not restart even if the release the brake pedal again.
While depressing the brake pedal, move the selector lever to the “P” (PARK) or “N” (NEUTRAL) position to start the engine.
For details, refer to “Starting” on page 4-12.



CAUTION

- In the following cases, the engine will restart automatically even if the engine was stopped by the Auto Stop & Go (AS&G) system. Pay attention, otherwise an unexpected accident might occur when the engine restarts.
 - Vehicle speed is 3 km/h (2 mph) or higher when coasting down a slope
 - Brake booster vacuum pressure is low because the brake pedal is depressed repeatedly or depressed harder than usual
 - Engine coolant temperature is low
 - When the air conditioning is operated by pressing the air conditioning switch.

CAUTION

- When the preset temperature of the air conditioning is changed significantly.
- When the air conditioner is operated in AUTO mode where the temperature control is set to the max. hot or the max. cool
- When the air conditioner is ON, the passenger compartment temperature rises and the air conditioning compressor operates to lower the temperature
- Demister switch is pressed
Refer to “For quick demisting” on page 5-11
- Electric power consumption is high, such as when the rear window demister or other electrical components are operating or the blower speed is set to a high setting.
- Push the accelerator pedal
- Battery voltage or battery performance is low
- Operate the steering wheel
- After the engine stop, 3 minute elapse (CVT)
- Move the selector lever to the “R” (REVERSE) position (CVT)
- Move the selector lever from the “N” (NEUTRAL) to “D” (DRIVE) position (CVT)

NOTE

- In the following cases, the engine will not restart automatically.

- While the engine is stopped automatically, the “Auto Stop & Go (AS&G) OFF” switch is pressed to deactivate the “Auto Stop & Go (AS&G) OFF” system.
- The driver has left the driver’s seat after unfastening the seat belt and opening the door.
 - When the engine restarts automatically, the audio volume may temporarily decrease. This does not indicate a malfunction.
 - While the engine is stopped automatically, the air volume change of the air conditioner may temporarily be experienced. This does not indicate a malfunction.
 - While the engine is stopped automatically, if the selector lever is moved to the “P” (PARK) position quickly with the brake pedal is kept depressed, the engine is kept stopped with blinking the AS&G indicator even if you release the brake pedal.
If you want to restart the engine, depress the brake pedal again.

To deactivate

E00627700100

The Auto Stop & Go (AS&G) system is automatically activated when the ignition switch is turned to the “ON” position or the operation mode put in ON. You can deactivate the system by pressing the “Auto Stop & Go (AS&G) OFF” switch.

When the Auto Stop & Go (AS&G) system is deactivated, the  indicator will be turned on.

To reactivate the Auto Stop & Go (AS&G) system, press the “Auto Stop & Go (AS&G) OFF” switch; the indicator will turn off.

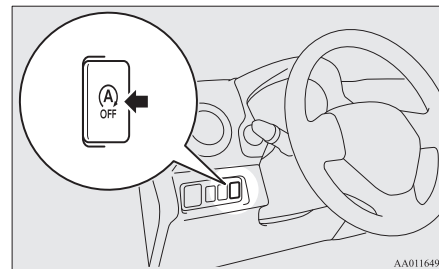

AA0116495

Indication lamp



NOTE

- This indicator will also turn on for a few seconds when the ignition switch is turned to the “ON” position or the operation mode put in ON.

If the indication lamp blinks while driving

E00627800084

If the  indication lamp blinks, the Auto Stop & Go (AS&G) system is malfunctioning and will not operate.

We recommend you to consult a MITSUBISHI MOTORS Authorized Service Point.

Manual transmission*

E00602000708

The shift pattern is shown on the gearshift lever knob. To start off, depress the clutch pedal all the way down and shift into 1st or “R” (Reverse) position. Then gradually release the clutch pedal while depressing the accelerator pedal.

CAUTION

- Do not put the gearshift lever into the reverse position while the vehicle is moving forward. Doing so could damage the transmission.
- Do not rest your foot on the clutch pedal while driving. Doing so could cause rapid wear to the clutch.
- Do not coast in the “N” (Neutral) position.
- Do not use the gearshift lever as a handrest, because this can result in premature wear of the transmission shift forks.

NOTE

- During cold weather, shifting may be difficult until the transmission lubricant has warmed up. This is normal and not harmful to the transmission.
- If it is hard to shift into 1st, depress the clutch pedal again; the shift will then be easier to make.
- To shift into the “R” (Reverse) position from 5th gear, move the gearshift lever to the “N” (Neutral) position, and then move it to the “R” (Reverse) position.

Changing gears

E00610600295

Always take care to change the gear with the vehicle speed matched to the engine speed. Proper shifting will improve fuel economy and prolong engine life.

Avoid shifting down at high speed, as this may cause excessive engine speed and damage the engine.

NOTE

- The gearshift indicator (if so equipped) shows recommended gearshift points for fuel-efficient driving. It shows a “↑” when an upshift is recommended, and it shows a “↓” when a downshift is recommended.

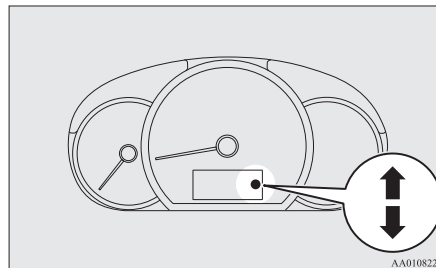

AA0108223

Starting and driving

Possible driving speed

E00610801555

Avoid shifting down at high speed, as this may cause excessive engine speed and damage the engine.

Shift point	Speed limit
1 st gear	50 km/h (30 mph)
2 nd gear	95 km/h (59 mph)
3 rd gear	145 km/h (90 mph)
4 th gear	180 km/h (112 mph)

Use 5th gear whenever vehicle speed allows, for maximum fuel economy.

Automatic transmission INVECS-III CVT (Intelligent & Innovative Vehicle Electronic Control System III)*

E00602100275

The CVT will automatically and continuously change its gear ratio depending on road and driving conditions. This helps achieve smooth driving and excellent fuel efficiency.

Selector lever operation

E00602200319

The CVT selects an optimum gear ratio automatically, depending on the speed of the vehicle and the position of the accelerator pedal.

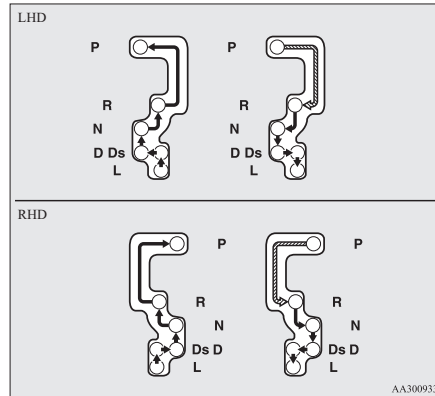
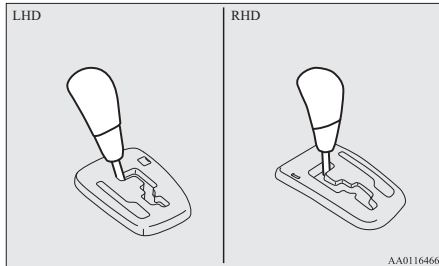

	While depressing the brake pedal, move the selector lever through the gate.
	Move the selector lever through the gate.

⚠ WARNING

- Always depress the brake pedal when shifting the selector lever into the other position from the “P” (PARK) or “N” (NEUTRAL) position. Never put your foot on the accelerator pedal while shifting the selector lever from the “P” (PARK) or “N” (NEUTRAL) position.

NOTE

- To avoid erroneous operation, move the selector lever firmly into each position and briefly hold it there. Always check the position shown by the selector lever position display after moving the selector lever.
- If the brake pedal is not depressed and held, the shift-lock device activates to prevent the selector lever from being moved from the “P” (PARK) position.

When the selector lever cannot be shifted from the “P” (PARK) position

E00629000367

When the selector lever cannot be shifted from the “P” (PARK) position to another position while the brake pedal is pressed and held down with the ignition switch or the operation mode in ON, the battery may be flat or the shift-lock mechanism may be malfunctioning. Immediately have your vehicle checked by a MITSUBISHI MOTORS Authorized Service Point. If you need to move the vehicle, shift the selector lever as follows.

For LHD vehicles

1. Make sure the parking brake is applied.
2. Stop the engine if it is running.

Starting and driving

3. Insert a straight blade (or minus) screwdriver with a cloth over its tip into notch (A) or the cover. Pry gently as shown to remove the cover.

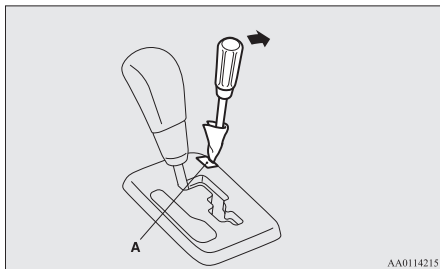

4. Depress the brake pedal with the right foot.
5. Insert a straight blade (or minus) screwdriver in the shiftlock release hole (B). Shift the selector lever to the “N” (NEUTRAL) position while pressing the straight blade (or minus) screwdriver down.

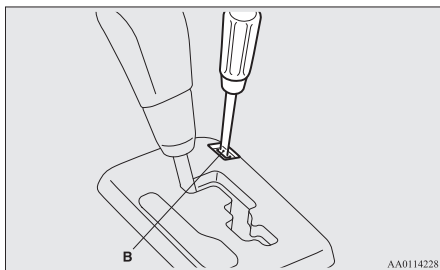

For RHD vehicles

1. Make sure the parking brake is applied.

2. Stop the engine if it is running.
3. Depress the brake pedal with the right foot.
4. Insert a straight blade (or minus) screwdriver in the shiftlock release hole (A). Shift the selector lever to the “N” (NEUTRAL) position while pressing the straight blade (or minus) screwdriver down.

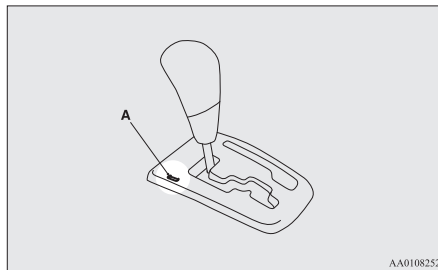

Selector lever position display

E00602300411

When the ignition switch is turned to the “ON” position or the operation mode is put in ON, the position of the selector lever is indicated in the multi-information display.

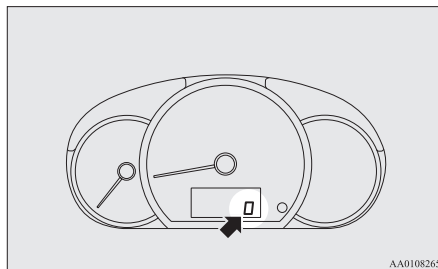

Selector lever positions

E00602400382

“P” PARK

This position locks the transmission to prevent the vehicle from moving. The engine can be started in this position.

“R” REVERSE

This position is to back up.

CAUTION

- Never shift into the “P” (PARK) or “R” (REVERSE) position while the vehicle is in motion to avoid transmission damage.

“N” NEUTRAL

At this position the transmission is disengaged. It is the same as the neutral position on a manual transmission, and should only be used when the vehicle is stationary for an extended length of time during driving, such as in a traffic jam.

WARNING

- Never move the selector lever to the “N” (NEUTRAL) position while driving. A serious accident could occur since you could accidentally move the lever into the “P” (PARK) or “R” (REVERSE) position or you will lose engine braking.
- On a gradient the engine should be started in the “P” (PARK) position, not in the “N” (NEUTRAL) position.

⚠ WARNING

- To prevent rolling, always keep your foot on the brake pedal when the vehicle is in “N” (NEUTRAL) position, or when shifting into or out of “N” (NEUTRAL) position.

“D” DRIVE

This position is used for most city and highway driving. The transmission will automatically and continuously change its gear ratio depending on road and driving conditions.

⚠ CAUTION

- To prevent transmission damage, never shift into the “D” (DRIVE) position from the “R” (REVERSE) position while the vehicle is in motion.

“Ds” (DOWNSHIFT & SPORTY DRIVING)

Use when engine braking is needed, or for high-power sport drive.

“L” (LOW)

This position is for driving up very steep hills and for engine braking at low speeds when driving down steep hills.

⚠ WARNING

- This position can be used for maximum engine braking. Be very careful not to shift into “L” (LOW) suddenly. Sudden engine braking may cause the tires to skid. Select this position according to the road conditions and vehicle speed.

When a malfunction occurs in the automatic transmission

E0063200013

When the selector lever position indicator blinks

E00632100043

When the selector lever position indicator blinks while you are driving, there could be a malfunction in the automatic transmission system or CVT fluid temperature becomes abnormally high.

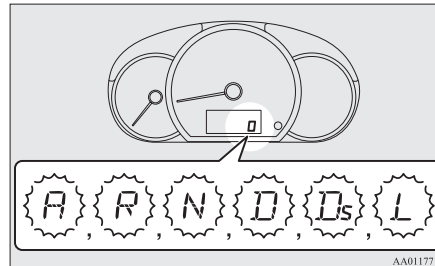
**NOTE**

- “A” indicator does blink only the condition that the CVT positional switch is broken. It does not indicate in normal driving condition.

⚠ CAUTION

- If a malfunction occurs in the CVT while driving, the indication lamp will blink. In this case, immediately park your vehicle in a safe place and follow these procedures:

[If the indication lamp blinks rapidly (once per second), the CVT fluid is overheating.]

Park your vehicle in a safe place but do not turn off the engine. Move the selector lever to the “P” (PARK) position and open the bonnet. Keep the engine idling. After a while, move the selector lever into any position other than “P” (PARK) position and confirm that the indication lamp stops blinking. It is safe to continue driving if the indication lamp no longer blinks. If the indication lamp continues blinking or blinks intermittently, have your vehicle inspected.

[If the indication lamp blinks slowly (once per 2 seconds), the CVT safety device may be operating due to a malfunction.]

Have the vehicle inspected as soon as possible.

Operation of the CVT

E00602600401

CAUTION

- Before selecting a position with the engine running and the vehicle stationary, fully depress the brake pedal to prevent the vehicle from creeping. The vehicle will begin to move as soon as the CVT is engaged, especially when the engine speed is high, at fast idle or with the air conditioning operating, the brakes should only be released when you are ready to drive away.
- Depress the brake pedal with the right foot at all times. Using the left foot could cause driver movement delay in case of an emergency.
- To prevent sudden acceleration, never race the engine when shifting from the “P” (PARK) or “N” (NEUTRAL) position.
- Operating the accelerator pedal while the other foot is resting on the brake pedal will affect braking efficiency and may cause premature wear of brake pads.

CAUTION

- Use the selector lever in the correct shift position in accordance with driving conditions. Never coast downhill backward with the selector lever in the “D” (DRIVE), “Ds” (DOWNSHIFT & SPORTY DRIVING), “L” (LOW) position or coast forward with the selector lever in the “R” (REVERSE) position. The engine may stop and the unexpected increase in brake pedal effort and steering wheel weight could lead to an accident.
- Do not race the engine with brake pedal pressed when the vehicle is stationary. This can damage the CVT. Also, when you depress the accelerator pedal while holding down the brake pedal with the selector lever in the “D” (DRIVE) position, the engine revolutions may not rise as high as when performing the same operation with the selector lever in the “N” (NEUTRAL) position.

Passing acceleration

E00602700112

To gain extra acceleration in “D” (DRIVE) position, push the accelerator to the floor. The CVT will automatically downshift.

Uphill/downhill driving

E00603000125

DRIVING UPHILL

The transmission prevents unnecessary upshifts even when the accelerator pedal is released and ensures smooth driving.

DRIVING DOWNHILL

According to the conditions, the transmission will automatically shift to a lower gear ratio to achieve stronger engine braking. This may help reduce your need to use the service brake.

Waiting

E00602800113

For short waiting periods, such as at traffic signals the vehicle can be left in selector lever position and held stationary with the service brake.

For longer waiting periods with the engine running, place the selector lever in the “N” (NEUTRAL) position and apply the parking brake, while holding the vehicle stationary with the service brake.

CAUTION

- Never hold the vehicle stationary while in CVT on a hill with the accelerator, always apply the parking brake and/or service brake.

Parking

E00602900039

To park the vehicle, first bring it to a complete stop, fully engage the parking brake, and then move the selector lever to the “P” (PARK) position. If you are going to leave the vehicle unattended, always switch off the engine and carry the key.

NOTE

- On a slope, be sure to apply the parking brake before moving the selector lever to the “P” (PARK) position. If you move the selector lever to the “P” (PARK) position before applying the parking brake, it may be difficult to disengage the selector lever from the “P” (PARK) position when next you drive the vehicle, requiring application of a strong force to the selector lever to move from the “P” (PARK) position.

When the CVT makes no speed change

E00603100171

If the transmission does not change speeds while driving, or your vehicle does not pick up enough speed when starting on an uphill slope, it may be that there is something unusual happening in the transmission, causing a safety device to activate. Have your vehicle checked as soon as possible.

Braking

E00607001957

All the parts of the brake system are critical to safety. Have the vehicle checked at regular intervals according to the service booklet.

CAUTION

- **Avoid driving habits that cause heavy braking and never “ride” the brakes by resting your foot on the brake pedal while driving. It causes brake overheating and fade.**

Brake system

The service brake is divided into two brake circuits. And your vehicle is equipped with power brakes. If one brake circuit fails, the other is available to stop the vehicle. If you should lose the power assist for some reason, the brakes will still work. In these situations, even if the brake pedal moves down to the very end of its possible stroke or resists being depressed, keep depressing the brake pedal down harder and further than usual; stop driving as soon as possible and have the brake system repaired.

WARNING

- **Do not turn off the engine while your vehicle is in motion. If you turn off the engine while driving, the power assistance for the braking system will stop working and your brakes will not work effectively.**

WARNING

- **If the power assist is lost or if either brake hydraulic system stops working properly, have your vehicle checked immediately.**

Warning lamp

The brake warning lamp illuminates to indicate a fault in the braking system. Refer to “Brake warning lamp” on page 3-12.

When brakes are wet

Check the brake system while driving at a low speed immediately after starting, especially when the brakes are wet, to confirm they work normally. A film of water can be formed on the brake discs or brake drums and prevent normal braking after driving in heavy rain or through large puddles, or after the vehicle is washed. If this occurs, dry the brakes out by driving slowly while lightly depressing the brake pedal.

When driving downhill

It is important to take advantage of the engine braking by shifting to a lower shift position while driving on steep downhill roads in order to prevent the brakes from overheating.

WARNING

- Do not leave any objects near the brake pedal or let a floor mat slide under it; doing so could prevent the full pedal stroke that would be necessary in an emergency. Make sure that the pedal can be operated freely at all times. Make sure the floor mat is securely held in place.

Brake pads

- New brakes need to be broken-in by moderate use for the first 200 km (125 miles). Avoid hard braking situations.
- The disc brakes are provided with a warning device which emits a shrieking metallic sound while braking if the brake pads have reached their wear limit. If you hear this sound, have the brake pads replaced immediately.

WARNING

- Driving with worn brake pads will make it harder to stop, and can cause an accident.

*Hill start assist**

E00628000142

The hill start assist makes it easy to start off on a steep uphill slope by preventing the vehicle from moving backwards. It keeps the braking force for about 2 seconds when you move your foot from the brake pedal to the accelerator pedal.

CAUTION

- Do not overly rely on the hill start assist to prevent backwards movement of the vehicle. Under certain circumstances, even when hill start assist is activated, the vehicle may move backwards if the brake pedal is not sufficiently depressed, if the vehicle is heavily loaded, or if the road is very steep or slippery.
- The hill start assist is not designed to keep the vehicle stopped in place on uphill slopes for more than 2 seconds.
- When facing uphill, do not rely on using the hill start assist to maintain a stopped position as an alternative to depressing the brake pedal. Doing so could result in an accident.
- Do not perform the following operation while the hill start assist is operating. [Except for vehicles equipped with keyless operation system] Turn the ignition switch to the “LOCK” or “ACC” position. [Vehicles equipped with keyless operation system] Put the operation mode in OFF or ACC. The hill start assist could stop operating, which could result in an accident.

To operate

E00628100358

1. Stop the vehicle completely using the brake pedal.
2. Place the selector lever into the “D” position.

NOTE

- When reversing on an uphill slope, the selector lever into the “R” position.
3. Release the brake pedal and the hill start assist will maintain the braking force applied while stopping for approximately 2 seconds.
 4. Depress the accelerator pedal and the hill start assist gradually will decrease the braking force as the vehicle starts moving.

NOTE

- The hill start assist is activated when all of the following conditions are met.
 - The engine is running. (The hill start assist will not be activated while the engine is starting or immediately after the engine is started.)
 - The selector lever is in any position other than “P” or “N”.
 - The vehicle is completely stationary, with the brake pedal depressed.
 - The parking brake is released.
- The hill start assist will not operate if the accelerator pedal is depressed before the brake pedal is released.
- The hill start assist also operates when reversing on an uphill slope.

- When the hill start assist activated, you may feel the operation sound or vibration from under the body.
This is a normal result of the hill start assist operation, and does not indicate a problem.

Warning indicator

E00628200359

If an abnormal condition occurs in the system, the indicator will turn on.



ASC indicator

CAUTION

- If the warning is turn on, the hill start assist will not operate. Start off carefully.
- Park your vehicle in a safe place and stop the engine.
Restart the engine and check whether the warning indicator went out, in which case the hill start assist is again working normally.
If the warning remains displayed or reappears frequently, it is not necessary to stop the vehicle immediately, but the vehicle should be inspected by a MITSUBISHI MOTORS Authorized Service Point.

Brake assist system

E00627000549

The brake assist system is a device assisting drivers who cannot depress the brake pedal firmly when it is necessary to do so (such as in emergency stop situations) and provides greater braking force.

If the brake pedal is depressed suddenly, the brakes will be applied with more force than usual.

CAUTION

- The brake assist system is not a device designed to exercise braking force greater than its capacity. Make sure to always keep a sufficient distance between vehicles in front of you without relying too much on the brake assist system.

NOTE

- Once the brake assist system is operational, it maintains great braking force even if the brake pedal is lightly released.
To stop its operation, completely remove your foot from the brake pedal.
- When the brake assist system is in use, you may feel as if the depressed brake pedal is soft, the pedal moves in small motions in conjunction with the sound of the ABS operation, or the vehicle body and the steering wheel vibrate. This occurs when the brake assist system is operating normally and does not indicate faulty operation. Continue to firmly depress the brake pedal.

- When the anti-lock brake system lamp is illuminated, the brake assist system is not functioning.

Starting and driving

Emergency stop signal system

E0062600050

This is a device that reduces the possibility of rear end collisions by the rapid and automatic blinking of the hazard warning lamps to alert vehicles approaching from behind during sudden braking. When the emergency stop signal system operates, the hazard warning indication lamp in the instrument cluster blinks rapidly at the same time.

CAUTION

- If the ABS warning or ASC warning is displayed, the emergency stop signal system may not operate.
Refer to “ABS warning lamp” on page 4-29.
Refer to “ASC warning indicator” on page 4-31.

NOTE

- [Activating condition for the emergency stop signal system]
It activates when all of the following conditions are met.
 - The vehicle speed is approximately 55 km/h (34 mph) or higher.
 - The brake pedal has been depressed, and the system judges that it was sudden braking from the vehicle deceleration and the operating condition of the anti-lock brake system (ABS).[Deactivating condition for the emergency stop signal system]
It deactivates when one of the following conditions is met.

- The brake pedal is released.
- The hazard warning flasher switch is pressed.
- The system judges that it was not sudden braking from the vehicle deceleration and the operating condition of the anti-lock brake system (ABS).

Anti-lock brake system (ABS)

E00607101479

The anti-lock brake system (ABS) helps prevent the wheels from locking during braking. This helps maintain vehicle drivability and steering wheel handling.

Driving hints

- Always keep a safe distance from the vehicle in front of you. Even if your vehicle is equipped with ABS, leave a greater braking distance when:
 - Driving on gravel or snow-covered roads.
 - Driving with snow traction device (tyre chains) installed.
 - Driving on uneven road surfaces.
- Operation of ABS is not restricted to situations where brakes are applied suddenly. This system may also prevent the wheels from locking when you drive over manholes, steel roadwork plates, road markings, or any uneven road surface.
- When the ABS is activated, you may feel the brake pedal pulsation and the vibrations of the vehicle body and steering wheel. It may also feel as if the pedal resists being pressed.
In this situation, simply hold the brake pedal down firmly. Do not pump the brake, which will result in reduced braking performance.
- An operation noise is emitted from the engine compartment or you can feel a shock from the brake pedal when starting to drive immediately after starting the engine. These are normal sounds or operations that the ABS makes when performing a self-check. It does not indicate a malfunction.

- The ABS can be used after the vehicle has reached a speed over approximately 10 km/h (6 mph). It stops working when the vehicle slows below approximately 5 km/h (3 mph).

A CAUTION

- The ABS cannot prevent accidents. It is your responsibility to take safety precautions and to drive carefully.
- To prevent failure of the ABS, be sure all 4 wheels and tyres are the same size and the same type.
- Do not install any aftermarket limited-slip differential (LSD) on your vehicle. The ABS may stop functioning properly.

ABS warning lamp

E00607201308

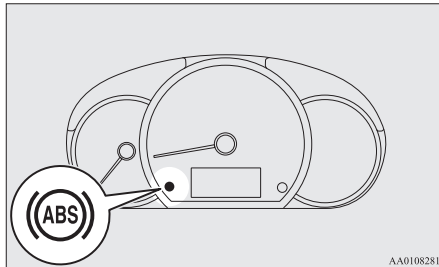

AA0108281

If there is a malfunction in the system, the ABS warning lamp will come on.

Under normal conditions, the ABS warning lamp comes on when the ignition switch is turned to the “ON” position or the operation mode is put in ON and goes off a few seconds later.

A CAUTION

- Any of the following indicates that the ABS is not functioning and only the standard brake system is functioning normally. (The standard brake system is functioning normally.) If this happens, we recommend you to have your vehicle inspected as soon as possible.
 - When the ignition switch is turned to the “ON” position or the operation mode is put in ON, the warning lamp does not come on or it remains on and does not go off.
 - The warning lamp comes on while driving

If the warning lamp illuminates while driving

E00607301383

If only the ABS warning lamp illuminate

Avoid hard braking and high-speed driving. Stop the vehicle in a safe place. Restart the engine and check to see whether the lamp goes out after a few minutes driving; if it then remains off during driving, there is no problem. However, if the warning lamp do not disappear, or if they come on again when the vehicle is driven, we recommend you to have the vehicle checked.

If the ABS warning lamp and brake warning lamp illuminate at the same time

The ABS and brake force distribution function may not work, so hard braking could make the vehicle unstable.

Avoid hard braking and high-speed driving. Stop the vehicle in a safe place and we recommend you to have it checked.

After driving on icy roads

E00618800206

After driving on snow or icy roads, remove any snow and ice which may have accumulated around the wheels. On vehicles that have an ABS, be careful not to damage the wheel speed sensors (A) or the cables located at each wheel.

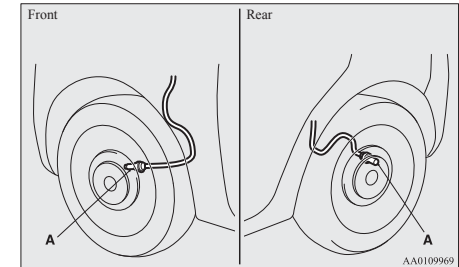

AA0109969

Starting and driving

Electric power steering system (EPS)

E00629200271

The power steering system operates while the engine is running.

It helps reduce the effort needed to turn the steering wheel.

If the power assist is lost, you will notice it takes much more effort to steer.

In this happens, have the vehicle inspected by a MITSUBISHI MOTORS Authorized Service Point.

⚠ WARNING

- Do not stop the engine while the vehicle is moving. Stopping the engine would make the steering wheel extremely hard to turn, possibly resulting in an accident.

NOTE

- During repeated full-lock turning of the steering wheel (for example, while you are manoeuvring the vehicle into a parking space), a protection function may be activated to prevent overheating of the power steering system. This function will make the steering wheel gradually harder to turn. In this event, limit your turning of the steering wheel for a while. When the system has cooled down, the steering action will return to normal.
- If you turn the steering wheel while the vehicle is stationary with the headlamps on, the headlamps may become dim. This behaviour is not abnormal. The headlamps will return to their original brightness after a short while.

Electric power steering system warning lamp

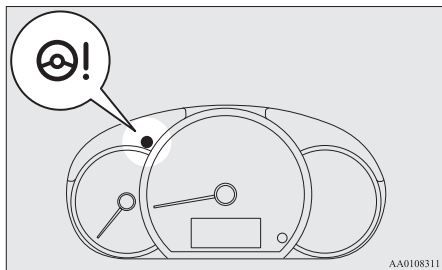

If there is a malfunction in the system, the warning lamp will come on.

Under normal conditions, the warning lamp comes on when the ignition switch is turned to the “ON” position or the operation mode is put in ON, and goes off after the engine has started.

⚠ CAUTION

- If the warning lamp comes on while the engine is running, have the vehicle inspected by a MITSUBISHI MOTORS Authorized Service Point as soon as possible. It may become harder to turn the steering wheel.

Active stability control (ASC)

E00616700445

The Active Stability Control (ASC) takes overall control of the anti-lock brake system, traction control function and stability control function to help maintain the vehicle’s control and traction. Please read this section in conjunction with the page on the anti-lock brake system, traction control function and stability control function.

Anti-lock brake system (ABS) → p. 4-28

Traction control function → p. 4-31

Stability control function → p. 4-31

⚠ CAUTION

- Do not over-rely on the ASC. Even the ASC cannot prevent the natural laws of physics from acting on the vehicle. This system, like any other system, has limits and cannot help you to maintain traction and control of the vehicle in all circumstances. Reckless driving may lead to accidents. It is the driver’s responsibility to drive carefully. This means taking into account the traffic, road and environmental conditions.
- Be sure to use the same specified type and size of tyre on all 4 wheels. Otherwise, the ASC may not work properly.
- Do not install any aftermarket limited-slip differential (LSD) on your vehicle. The ASC may stop functioning properly.

NOTE

- An operation noise may be emitted from the engine compartment in the following situations. The sound is associated with checking the operations of the ASC. At this time, you may feel a shock from the brake pedal if you depress it. These do not indicate a malfunction.
 - When the ignition switch is turned to the “ON” position or the operation mode is put in ON.
 - When the vehicle is driven for a while after the engine is turned on.
- When the ASC is activated, you may feel a vibration in the vehicle body or hear a whining sound from the engine compartment. This indicates that the system is operating normally. It does not indicate a malfunction.
- When the anti-lock brake system warning lamp is illuminated, the ASC is not active.

Traction control function

E00619000133

On slippery surfaces, the traction control function prevents the drive wheels from excessive spinning, thus helping the vehicle to start moving from a stopped condition. It also provides sufficient driving force and steering performance as the vehicle turns while pressing the acceleration pedal.

 **CAUTION**

- **When driving a vehicle on a snowy or icy road, be sure to install snow tyres and drive the vehicle at moderate speeds.**

Stability control function

E00619100017

The stability control function is designed to help the driver maintain control of the vehicle on slippery roads or during rapid steering manoeuvres. It works by controlling the engine output and brake on each wheel.

NOTE

- The stability control function operates at speeds of about 15 km/h (9 mph) or higher.

ASC operation indicator

E00619300615





ASC indicator
The indicator will blink when the ASC is operating.

 **CAUTION**

- **When  indicator blinks, ASC is operating, which means that the road is slippery or that your vehicle's wheels are beginning to slip. If this happens, drive slower with less accelerator input.**

NOTE

- The  indicator may turn on when you start the engine. This means that the battery voltage momentarily dropped when the engine was started. It does not indicate a malfunction, provided that the display goes out immediately.

- When a compact spare tyre has been put on your vehicle, the gripping ability of the tyre will be lower, making it more likely that the  indicator will blink.

ASC warning indicator

E00619400632

If an abnormal condition occurs in the system, the indicators will turn on.



ASC indicator



ASC OFF indicator

 **CAUTION**

- **The system may be malfunctioning. Park your vehicle in a safe place and stop the engine. Restart the engine and check whether the indicator go out. If they go out, there is no abnormal condition. If they do not go out or appears frequently, it is not necessary to stop the vehicle immediately, but we recommend you to have your vehicle inspected.**

Towing

E00624400076

CAUTION

- When towing the vehicle with only the front wheels or only the rear wheels raised off the ground, do not place the ignition switch in the “ON” position or do not put the operation mode in ON. Placing the ignition switch in the “ON” position or putting the operation mode in ON could cause the ASC to operate, resulting in an accident.

Note that the correct towing method depends on the transmission type and the vehicle’s drive configuration.

For details, refer to “Towing” on page 6-17.

Rear-view camera*

E00618400576

The rear-view camera is a system that shows the view behind the vehicle on a screen of the MITSUBISHI Multi Entertainment System.

CAUTION

- The rear-view camera is an assistance system that enables the driver to check for obstacles behind the vehicle. Its range of view is limited, so you should not overly depend on it. Please drive just as carefully as you would if the vehicle did not have the rear-view camera.
- Be sure to visually confirm safety around the vehicle with your own eyes. Do not depend entirely on the rear-view camera.

Range of view of rear-view camera

The range of view of the rear-view camera is limited to the area shown in the illustrations. It cannot show both sides and the lower part of the rear bumper, etc.

When reversing, be sure to visually confirm safety around the vehicle.

Location of rear-view camera

The rear-view camera (A) is in the tailgate.

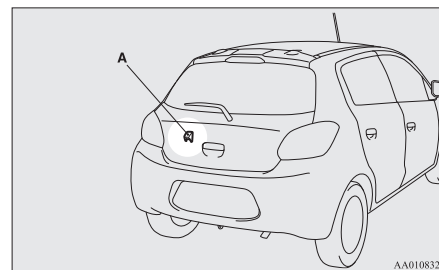

Range of view of rear-view camera

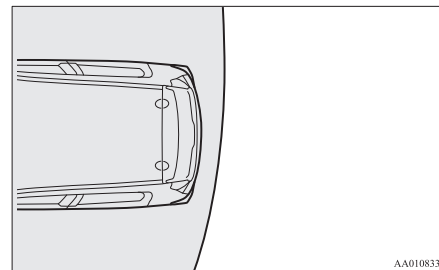

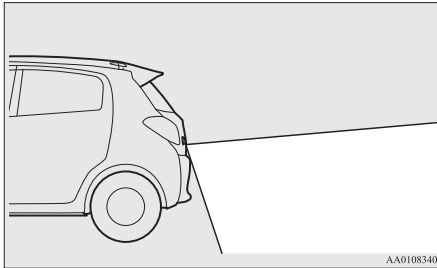

How to use the rear-view camera

When you place the gearshift lever or the selector lever in the “R” position with the ignition switch or the operation mode in ON, the view behind the vehicle will automatically appear on the screen of the MITSUBISHI Multi Entertainment System. When you move the gearshift lever or the selector lever to any other position, the screen will return to its original indication.

CAUTION

- The rear-view camera has a special lens that can make objects shown on the screen appear to be closer or further away than they actually are.

NOTE

- Because the rear-view camera has a special lens, the lines on the ground between parking spaces may not look parallel on the screen.
- In the following situations, the screen indication may be difficult to see. There is no abnormality.

- Low light (nighttime)
- When the light of the sun or the light from a vehicle’s headlamps shines directly into the lens
- If the camera is hot and is then cooled by rain or a car wash, the lens can mist up. This phenomenon does not indicate a malfunction.
- It is not possible to fully see obstacles when the lens is dirty. If the lens becomes contaminated by water droplets, snow, mud or oil, wipe off the contamination, taking care not to scratch the lens.
- Please observe the following cautions. Ignoring them could lead to a camera malfunction.
 - Do not subject the camera to physical shock.
 - Do not apply wax to the camera.
 - Do not splash the camera with boiling water.
 - Do not disassemble the camera.

Reference lines on the screen

Reference lines and upper surface of the rear bumper (A) are displayed on the screen.

- Red line (B) indicates approximately 50 cm behind the rear bumper.
- Two Green lines (C) indicate approximately 20 cm outside of the vehicle body.
- Short transverse lines (1 to 3) indicate distance from the rear bumper.

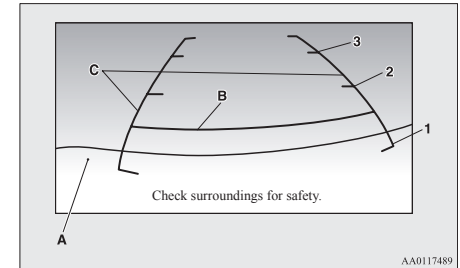

- 1- Approximately at the rear edge of the rear bumper
- 2- Approximately 100 cm
- 3- Approximately 200 cm

NOTE

- When the vehicle is tilting because of the number of people in the vehicle, the weight and positioning of luggage, and/or the condition of the road surface, the lines in the view from the rear-view camera may not be accurately positioned relative to the actual road. The reference lines for distance and vehicle width are based on a level, flat road surface. In the following cases, objects shown on the screen will appear to be farther off than they actually are.

Starting and driving

- When the rear of the vehicle is weighed down with the weight of passengers and luggage in the vehicle.

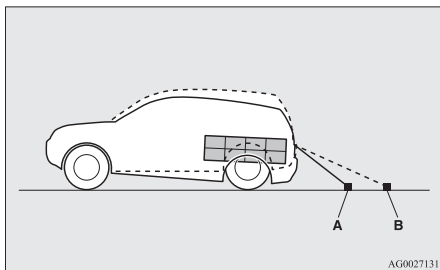

A- Actual objects
B- Objects shown on the screen

- When there is an upward slope at the back.

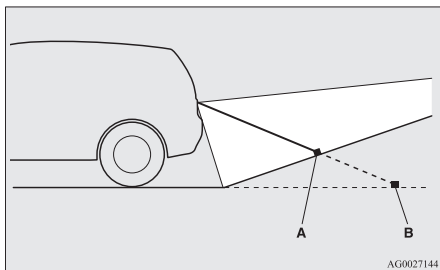

A- Actual objects
B- Objects shown on the screen

- The reference lines for distance and vehicle width are intended to indicate the distance to

a flat object such as a level, flat road surface. This may make the distance to a projecting object shown on the screen differ from the actual distance to the projecting object. Do not use them as a guide for distances to solid objects.

Example: On the screen the point B appears the nearest, then the point C and A in order of distance. The points A and B actually are the same distances from the vehicle, and the point C is farther off than the points A and B.

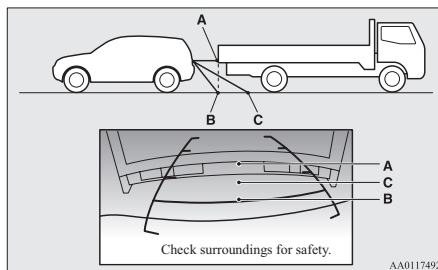

Cargo loads

E00609901484

Cargo load precautions

CAUTION

- Do not load cargo or luggage higher than the top of the seatback. Be sure that your cargo or luggage cannot move once your vehicle is moving.
- Having the driver's vision blocked, and your cargo being thrown inside the cabin if you suddenly have to brake can cause a serious accident or injury.
- Load heavy cargo or luggage in the front of the vehicle. If the load in the back of the vehicle is too heavy, steering may become unstable.

Loading a roof carrier

CAUTION

- Use a roof carrier that properly fits your vehicle.
- Do not load luggage directly onto the roof. For installation, refer to the instruction manual accompanying the roof carrier.
- When attaching/removing the roof carrier and loading/removing luggage, do not apply excessive pressure on a single point. Depending on how and where the force is applied, this may cause dents on the vehicle roof.

Roof carrier precaution

CAUTION

- **Make sure that the weight of the luggage does not exceed the allowable roof load. If the allowable roof load is exceeded, this may cause damage to the vehicle.**
The roof load is the total allowable load on the roof (the weight of the roof carrier plus the weight of luggage placed on the roof carrier).
- **When luggage is loaded onto the vehicle, please make sure to drive slowly and avoid excessive manoeuvres such as sudden braking or quick turning.**
In addition, place the luggage on the carrier so that its weight is distributed evenly with the heaviest items on the bottom. Do not load items that are wider than the roof carrier.
The additional weight on the roof could raise the vehicle's centre of gravity and affect vehicle handling characteristics.
As a result, driving errors or emergency manoeuvres could lead to a loss of control and result in an accident.
- **Before driving and after travelling a short distance, always check the load to make sure it is securely fastened to the roof carrier.**
Check periodically during your travel that the load remains secure.

NOTE

- To prevent wind noise or reduction in fuel economy, remove the roof carrier when not in use.
- Before using an automatic car wash, remove the roof carrier.
- Be sure that adequate clearance is maintained for raising the tailgate when installing a roof carrier.

Trailer towing (1200 models)

E0061000648

In order to tow a trailer with your vehicle, when having a trailer towing device mounted that meets all relevant regulations in your area, consult a MITSUBISHI MOTORS Authorized Service Point. The regulations concerning the towing of a trailer may differ from country to country. You are advised to obey the regulations in each area.

CAUTION

- **Danger of Accident!**
A towing bar should be fitted according to MITSUBISHI MOTORS guidelines.

Maximum towable weight with brake and maximum trailer-nose weight

Never exceed the maximum towable weight with brake and the maximum trailer-nose weight as listed in the specifications.

(Refer to page 9-06.)

If you tow a trailer at an altitude of more than 1,000 m above sea-level, reduce your weight by 10 % of the gross combination weight for every increase of 1,000 m above sea-level, as the engine output is lowered owing to decrease in atmospheric pressure.

Starting and driving

Towing bar mounting specifications

See the following table for fixing points (A) for the towing bar.

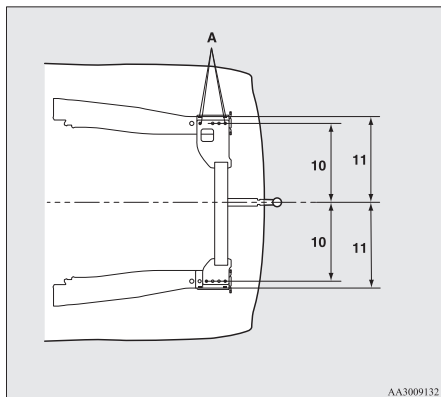
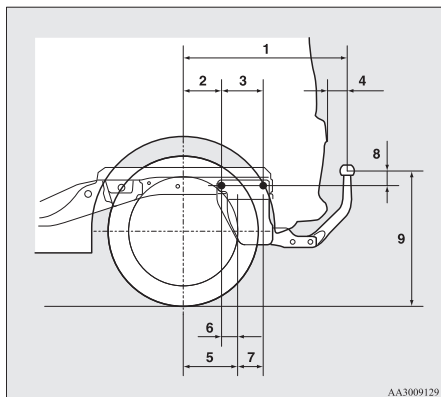

1	606.5 mm
2	140.5 mm
3	154.5 mm
4	76 mm
5	Left side: 183 mm, Right side: 140 mm
6	Left side: 42.5 mm, Right side: 0.5 mm
7	Left side: 112 mm, Right side: 155 mm
8	46.5 mm
9	494.5 mm 497 mm (at kerb weight condition)
	375 mm to 388 mm (at laden condition)
10	467 mm
11	505 mm

Operating hints

- To prevent the clutch from slipping (Vehicle with a M/T only), do not rev the engine more than is required when starting off.
- Be sure that the driving speed does not exceed 100 km/h (62 mph) for trailer operation. It is also recommended that you obey the local regulations in case driving speed with a trailer is limited to less than 100 km/h (62 mph).
- To prevent shocks from the overrun brake, depress the brake pedal lightly at first and then more strongly.

- To make full use of engine braking, change to a lower shift point before descending a slope.

Additional precautions for vehicles equipped with a CVT

It is recommended the “D” position on slopes or at low speed.

Use the sports mode in mountainous areas in order to make better use of engine braking and to assist the brake system. However, be sure that the speed does not exceed the maximum speed limit for the selected shift position.

Overheating

This will normally occur as a result of some mechanical failure. If your vehicle should overheat, stop and check for a loose or broken water pump/alternator drive belt, a blocked radiator air intake or a low coolant level. If these items are satisfactory the overheating could be caused by a number of mechanical causes that would have to be checked at a competent service centre.

CAUTION

- If the engine overheats, please refer to the “Engine overheating” section of “For emergencies” prior to taking any corrective action.
- On vehicles equipped with CVT, if the selector lever position indicator blinks, the temperature of the CVT fluid is high. Read the reference page and take the required measures. Refer to “When the selector lever position indicator blinks” on page 4-23.

For pleasant driving

Ventilators.....	5-02
Heater/Manual air conditioning*.....	5-03
Automatic air conditioning*.....	5-06
Important operation tips for the air conditioning.....	5-12
Air purifier*.....	5-13
LW/MW/FM electronic tuning radio with CD player*.....	5-13
To play tracks from USB device*.....	5-23
Error codes.....	5-27
Handling of compact discs.....	5-29
Antenna.....	5-30
Link System*.....	5-31
USB input terminal*.....	5-31
Sun visors.....	5-34
Accessory socket.....	5-35
Interior lamps.....	5-35
Storage spaces.....	5-36
Cup holder.....	5-37
Bottle holder.....	5-38
Rear shelf panel*.....	5-38
Convenient hook.....	5-39
Assist grip.....	5-39

Ventilators

E00700101006

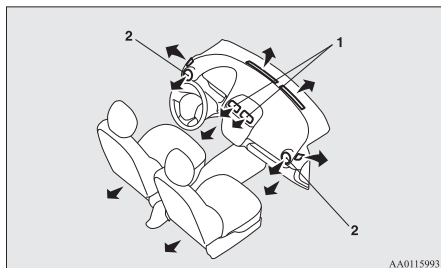

AA0115993

- *: Optional equipment
 1- Centre ventilators
 2- Side ventilators

NOTE

- Do not place beverages on top of the instrument panel. If they splash into the air conditioning ventilators, they could damage the system.

Air flow and direction adjustments

E00700201010

Centre ventilators

Move the knob (A) to make adjustments.

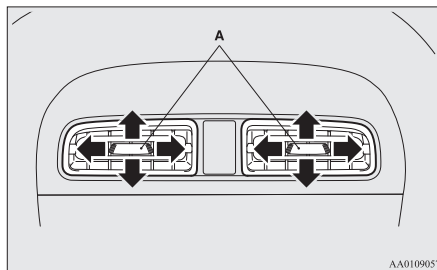

AA0109057

Side ventilators

When the dimple (A) is pressed, the ventilators open. To close the ventilators, press the dimple on the opposite side. Change the direction of the air flow by turning the ventilator itself.

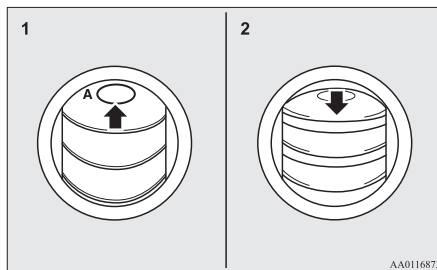

AA0116873

- 1- Open
 2- Close

NOTE

- On vehicles with air conditioning, the cool air from the ventilators may appear as a mist. This is due to moist air being suddenly cooled by the air conditioning. This will clear after a few moments.

Mode selection

E00726500421

To change the position and amount of air flowing from the ventilators, turn the mode selection dial. On vehicles with the automatic air conditioning, press the MODE switch or demister switch. (Refer to "MODE switch" on page 5-10, "Demister switch" on page 5-10.)

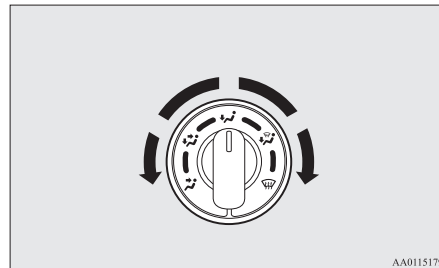

AA0115179

Face position

Air flows only to the upper part of the passenger compartment.

Foot/Face position

Air flows to the upper part of the passenger compartment, and flows to the leg area.

Foot position

Air flows mainly to the leg area.



Foot/Demister position

Air flows to the leg area, the windscreen and the door windows.









Demister position

Air flows mainly to the windscreen and the door windows.

CAUTION

- On vehicles with the manual air conditioning, when using the mode selection dial between the “” and “” positions, prevent fogging by moving the air selection lever to select outside air. (Refer to “Air selection lever” on page 5-04.)

NOTE

- With the mode selection dial between the “” and “” positions, the air flows mainly to the upper part of the passenger compartment. With the mode selection dial between the “” and “” positions, the air flows mainly to the leg area.
- With the mode selection dial in the “” position, a small amount of air flows to the windscreen and the door windows.
- With the mode selection dial between the “” and “” positions, the air flows mainly to the leg area. With the mode selection dial between the “” and “” positions, the air flows mainly to the windscreen and door windows.

Heater/Manual air conditioning*

E00700500537

The air conditioning can only be used while the engine is running.

Control panel

E00700600639

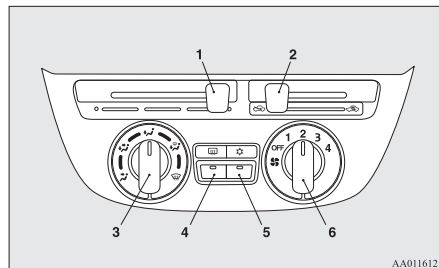

- 1- Temperature control lever
- 2- Air selection lever
- 3- Mode selection dial
- 4- Rear window demister switch → p. 3-23
- 5- Air conditioning switch*
- 6- Blower speed selection dial

Blower speed selection dial

E00700700311

Select the blower speed by turning the blower speed selection dial clockwise or anticlockwise.

For pleasant driving

The blower speed will gradually increase as the dial is turned to the right.

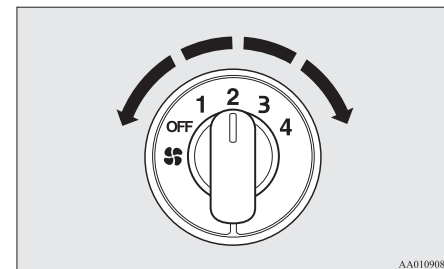

AA0109086

Temperature control lever

E00700900443

The temperature control lever is used to select the desired air temperature.

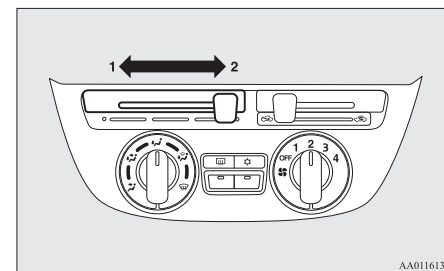

AA0116134

- 1- Cooler
- 2- Warmer

For pleasant driving



NOTE

- While the engine coolant temperature is low, the temperature of the air from the heater will be cool/cold until the engine warms up, even if you have selected warm air with the lever.

Air selection lever

E00701300776

To change the air selection, use the air selection lever.

- “” Outside air
Outside air is introduced into the passenger compartment.
- “” Recirculated air
Air is recirculated inside the passenger compartment.

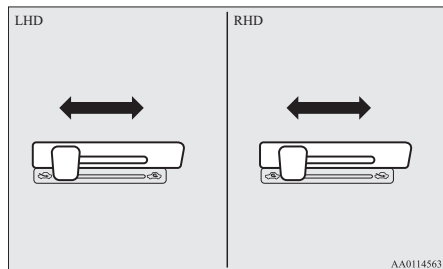

CAUTION

- Use of the recirculation position for extended time may cause the windows to fog up.

NOTE

- Normally, use the outside position to keep the windscreen and side windows clear and quickly remove fog or frost from the windscreen.
If high cooling performance is desired, or if the outside air is dusty or otherwise contaminated use the recirculation position. Switch to the outside position periodically to increase ventilation so that the windows do not become fogged up.

Air conditioning switch*

E00701501023

Push the switch to turn the air conditioning on, indication lamp (A) will come on.

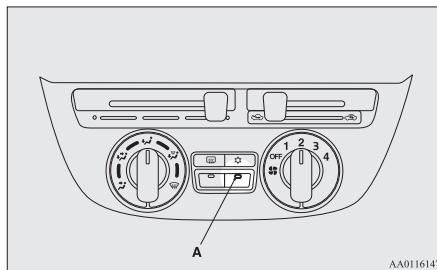

Push the switch again to switch it off.

CAUTION

- When using the air conditioning, the idling speed may slightly increase as the air conditioning compressor is switched on/off automatically. While the vehicle with a CVT is stationary, fully depress the brake pedal to prevent the vehicle from creeping.

Operating the air conditioning system

E00701800511

Select dials and levers as shown in the illustration according to your purpose.

Heating

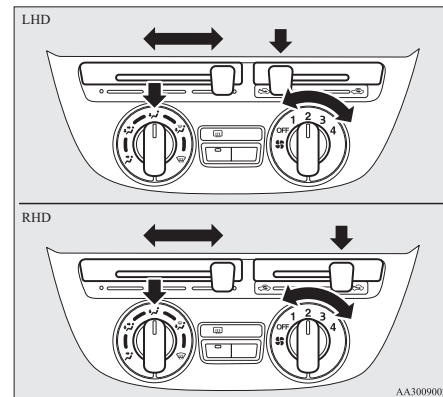

NOTE

- For maximum heat, set the blower speed at the 3rd position.

Cooling (manual air conditioning)

E00701900785

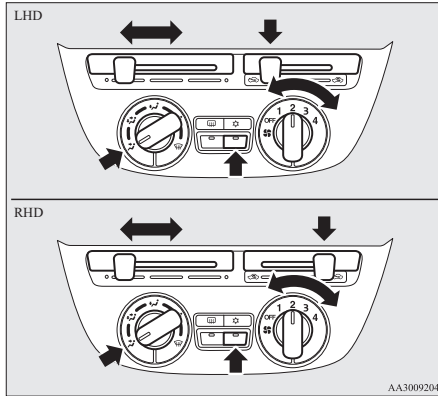

Combination of unheated air and heated air

E00702000552

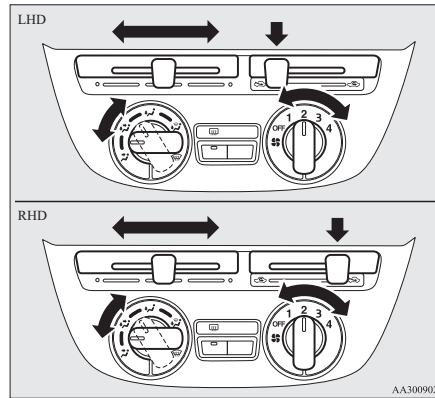

For ordinary demisting

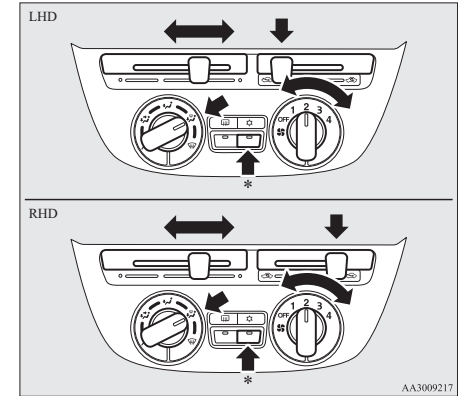

*: Optional equipment

Demisting of the windscreen and door windows

E00702100931

⚠ CAUTION

- If the outside air is dusty or otherwise contaminated, or if high cooling performance is desired, set air selection lever to the recirculation position and the temperature control lever all the way to the right. Switch to the outside position periodically to increase ventilation so that the windows do not become fogged up.

⚠ CAUTION

- For safety, make sure you have a clear view through all the windows.

For pleasant driving

For quick demisting

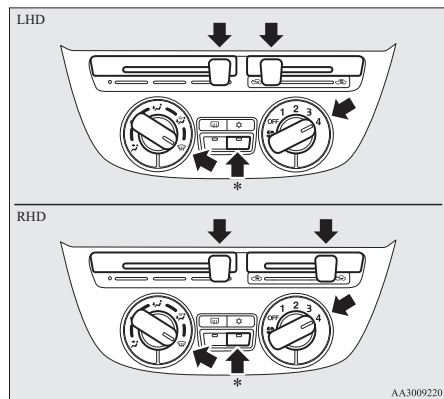

*: Optional equipment

5 NOTE

- To demist effectively, direct the air flow from the side ventilators towards the door windows.
- Do not set the temperature control lever to the max. cool position. Cool air will blow against the window glasses and prevent demisting.

Introduction of outside air

E00702200479

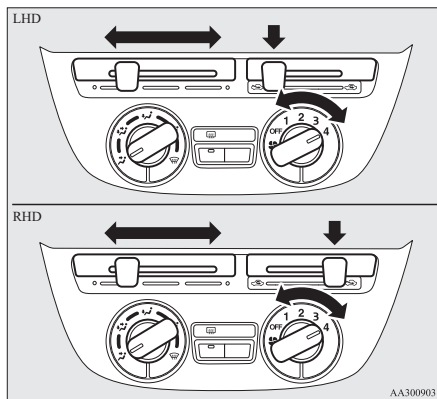

Automatic air conditioning*

E00702400413

The air conditioning can only be used while the engine is running.

Control panel

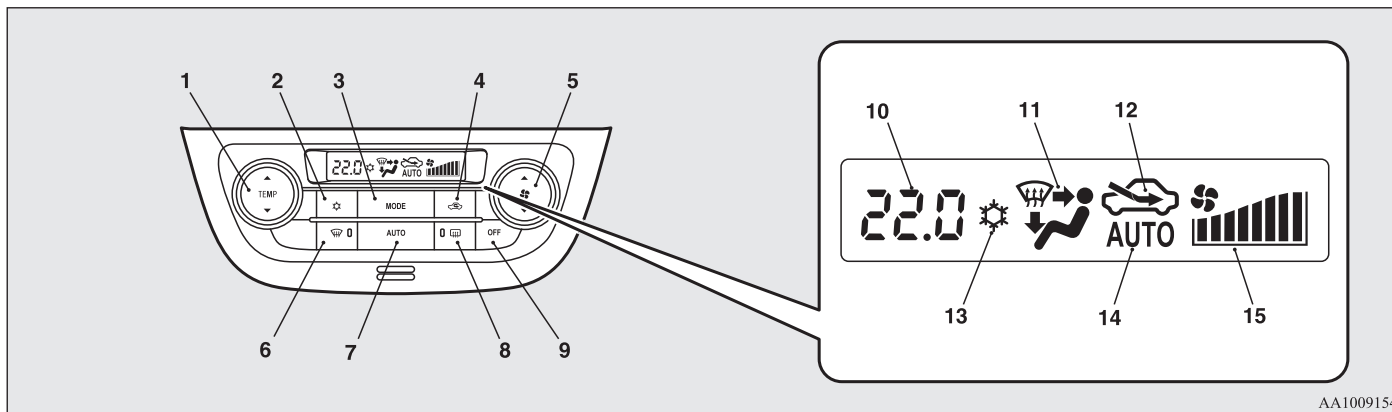

AA1009154

- 1- Temperature control switch
- 2- Air conditioning switch
- 3- MODE switch
- 4- Air selection switch
- 5- Blower speed selection switch
- 6- Demister switch
- 7- AUTO switch
- 8- Rear window demister switch → p. 3-23
- 9- OFF switch
- 10- Temperature display → p. 5-08
- 11- Mode selection display
- 12- Air selection indicator
- 13- Air conditioning indicator
- 14- AUTO indicator
- 15- Blower speed display

NOTE

- There is an interior air temperature sensor (A) in the illustrated position.

Never place anything on top of the sensor, since doing so will prevent it from functioning properly.

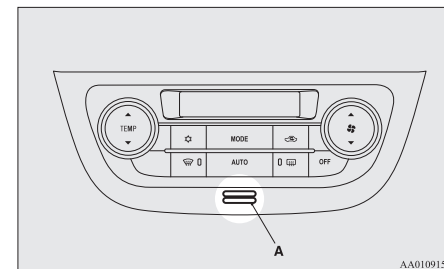

AA0109158

For pleasant driving

- A sound will be made every time you push all the switches.

Blower speed selection switch

E00702800358

Press ▲ of the blower speed selection switch to increase the blower speed.

Press ▼ of the blower speed selection switch to decrease the blower speed.

The selected blower speed will be shown in the display (A).

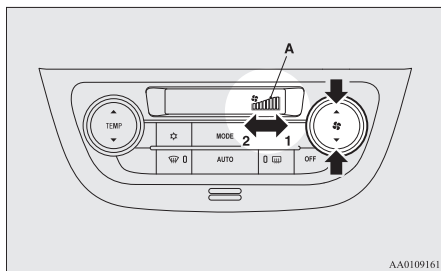

- 1- Increase
- 2- Decrease

Temperature control switch

E00703000676

Press ▲ or ▼ of the temperature control switch to the desired temperature.

The selected temperature will be shown in the display (A).

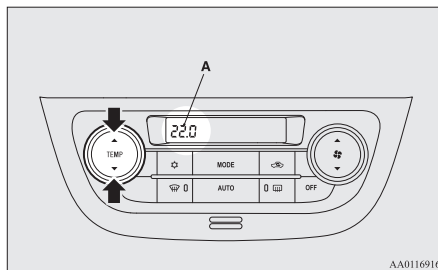

NOTE

- The temperature value of air conditioning is switched in conjunction with outside temperature display unit of the multi information display. Refer to “Changing the temperature unit” on page 3-09.
- While the engine coolant temperature is low, the temperature of the air from the heater will be cool/cold until the engine warms up, even if you have selected warm air with the switch. To prevent the windscreen and windows from fogging up, the ventilator mode will be changed to “” and the blower speed will be reduced.
- When the temperature is set to the highest or the lowest, the air selection and the air conditioning will be automatically changed as follows.

- Quick Heating (When the temperature is set to the highest setting)
Outside air will be introduced and the air conditioning will stop.
- Quick Cooling (When the temperature is set to the lowest setting)
Inside air will be recirculated and the air conditioning will operate.

The settings described above are the factory settings. The air selection and air conditioning switches can be customized (function setting changed), and the automatic switching of outside air and the air conditioning according to operating conditions can be changed as desired.

For further information, we recommend you to consult a MITSUBISHI MOTORS Authorized Service Point.

Refer to “Customizing the air conditioning switch” on page 5-09.

Refer to “Customizing the air selection” on page 5-08.

Air selection switch

E00703400801

To change the air selection, simply press the air selection switch.

The selected position will be shown in the display (A).

- Outside air: “” indicator is ON
Outside air is introduced into the passenger compartment.
- Recirculated air: “” indicator is ON

Air is recirculated inside the passenger compartment.

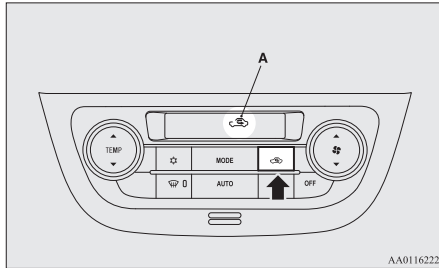

CAUTION

- Use of the recirculation position for extended time may cause the windows to fog up.

NOTE

- Normally, use the outside position to keep the windshield and side windows clear and quickly remove fog or frost from the windshield.
- If high cooling performance is desired, or if the outside air is dusty or otherwise contaminated use the recirculation position. Switch to the outside position periodically to increase ventilation so that the windows do not become fogged up.
- If you press the AUTO switch to select automatic control after manually switching between outside air and recirculated air, the air selection will also be automatically controlled.

Customizing the air selection

Functions can be changed as desired, as stated below.

- Enable automatic air control
When the AUTO switch pressed, the air selection switch is also controlled automatically.
- Disable automatic air control
Even when the AUTO switch is pressed, the air selection switch is not controlled automatically.
- Setting change method
Hold down the air selection switch for about 10 seconds or more.
 - When the setting is changed from enable to disable 3 sounds are emitted and the “” indicator flashes 3 times.
 - When the setting is changed from disable to enable 2 sounds are emitted and the “” indicator flashes 3 times.

NOTE

- The factory setting is “Enable automatic air control.”
- When the demister switch is pressed, in order to prevent misting of the windows the ventilator automatically switches to outside air even if “Disable automatic air control” is set.

AUTO switch

E00702600040

When the AUTO switch is pressed, the mode selection, blower speed adjustment, recirculated/outside air selection, temperature adjustment, and air conditioner ON/OFF status are all controlled automatically.

The “AUTO” indicator will be shown in the display (A).

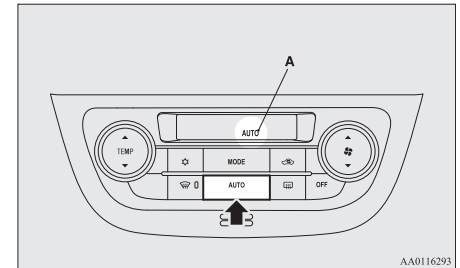

Air conditioning switch

E00703501320

Push the switch to turn the air conditioning on, the “” indicator will be shown in the display (A).

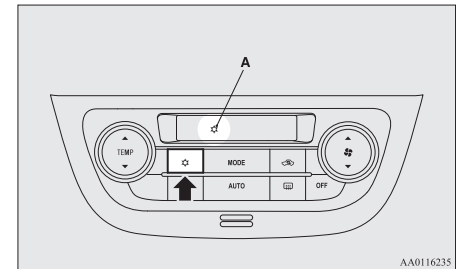

Push the switch again to switch it off.

For pleasant driving

CAUTION

- When using the air conditioning, the idling speed may slightly increase as the air conditioning compressor is switched on/off automatically. While the vehicle with a CVT is stationary, fully depress the brake pedal to prevent the vehicle from creeping.

Customizing the air conditioning switch

Functions can be changed as desired, as stated below.

- Enable automatic air conditioning control: When the AUTO switch is pressed, or the temperature control switch is set to the minimum temperature, the air conditioning switch is controlled automatically.
- Disable automatic air conditioning control: The air conditioning switch is not controlled automatically as long as the air conditioning switch is not operated.
- Setting change method
Hold down the air conditioning switch for about 10 seconds or more.
 - When the setting is changed from enable to disable 3 sounds are emitted and the “⚙️” indicator flashes 3 times.
 - When the setting is changed from disable to enable 2 sounds are emitted and the “⚙️” indicator flashes 3 times.

NOTE

- The factory setting is “Enable automatic air conditioning control”.

- When the demister switch is pressed, in order to prevent misting of the windows the air conditioning operates automatically even if “Disable automatic air conditioning control” is set.

OFF switch

E00702700041

Push the switch to turn off the air conditioning system.

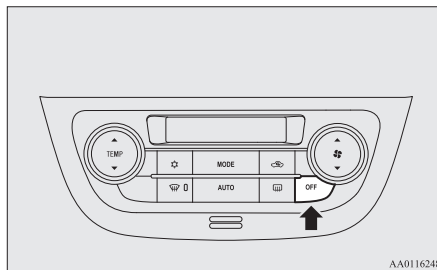

MODE switch

E00703300044

Each time the MODE switch is pressed, the mode changes to the next one in the following sequence: “🌀” → “🌀” → “🌀” → “🌀” → “🌀”. The selected mode is shown in the display (A). (Refer to “Mode selection” on page 5-02.)

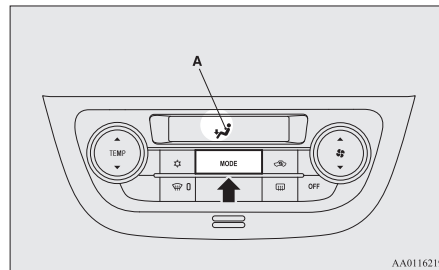

Demister switch

E00703900066

When this switch is pressed, the mode changes to the “🌀” mode. The indication lamp (A) will come on. The selected mode is shown in the display (B). (Refer to “Mode selection” on page 5-02.)

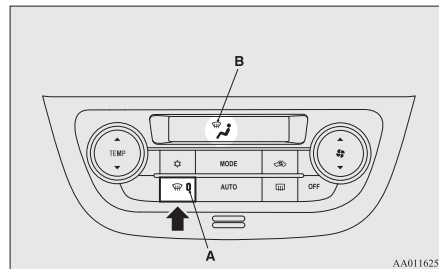

For ordinary demisting

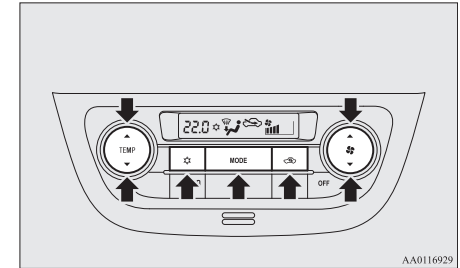

1. Set the air selection switch to the outside position.
2. Set the MODE switch to the “wind” position.
3. Select your desired blower speed by pressing the blower speed selection switch.
4. Select your desired temperature by pressing the temperature control switch.
5. Push the air conditioning switch.

NOTE

- When the demister switch is pressed, the air conditioning system automatically operates and outside air (as opposed to recirculated air) is selected. (Refer to “Demisting of the windscreen and door windows” on page 5-11.)

Operating the system in automatic mode

E00704101134

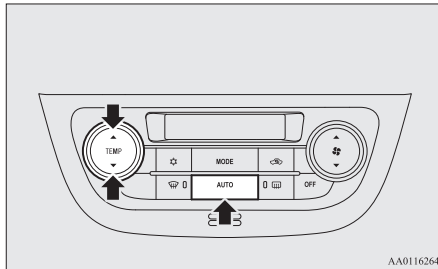

In normal conditions, use the system in the AUTO mode and follow these procedures:

1. Push the AUTO switch.
2. Set the temperature control switch to the desired temperature.

The mode selection, blower speed adjustment, recirculated/outside air selection, temperature adjustment, and air conditioner ON/OFF status are all controlled automatically

CAUTION

- When using the air conditioning, the idling speed may slightly increase as the air conditioning compressor is switched on/off automatically. While the vehicle with a CVT is stationary, fully depress the brake pedal to prevent the vehicle from creeping.

NOTE

- If the blower speed selection switch, air conditioning switch, Mode switch, or air selection switch is operated while the system is operating in the AUTO mode, the activated function overrides the corresponding function of automatic control. All other functions remain under automatic control.

Operating the system in manual mode

E00704200239

Blower speed and ventilator mode may be controlled manually by setting the blower speed selection switch and the MODE switch to the desired positions.

To return to automatic operation, press the AUTO switch.

Demisting of the windscreen and door windows

E00704300940

CAUTION

- For safety, make sure you have a clear view through all the windows.

For pleasant driving

For quick demisting

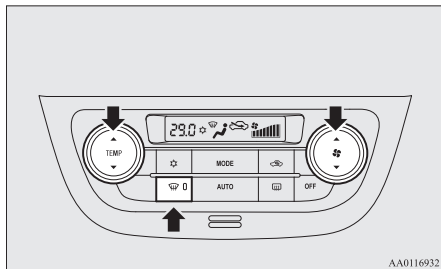

1. Push the demister switch to change to the  position.
2. Set the blower to the maximum speed.
3. Set the temperature to the highest position.

NOTE

- To demist effectively, direct the air flow from the side ventilators towards the door windows.
- Do not set the temperature to the max. cool position. Cool air will blow against the window glasses and prevent demisting.

Important operation tips for the air conditioning

E00708301091

- Park the vehicle in the shade.
Parking in the hot sun will make the vehicle inside extremely hot, and it will require more time to cool the interior.
If it is necessary to park in the sun, open the windows for the first few minutes of air conditioning operation to expel the hot air.
- Close the windows when the air conditioning is in use. The entry of outside air through open windows will reduce the cooling efficiency.
- Too much cooling is not good for the health. The inside air temperature should only be 5 to 6 °C below the outside air temperature.
- When operating the system, make sure the air intake, which is located in front of the windscreen, is free of obstructions such as leaves and snow. Leaves collected in the air-intake plenum may reduce air flow and plug the plenum water drains.

Air conditioning system refrigerant and lubricant recommendations

If the air conditioning seems less effective than usual, the cause might be a refrigerant leak. We recommend you to have the system inspected.

The air conditioning system in your vehicle must be charged with the refrigerant HFO-1234yf and the lubricant VC 200YF.

Use of any other refrigerant or lubricant will cause severe damage which will result in the need to replace your vehicle's entire air conditioning system. The release of refrigerant into the atmosphere should be prevented.

We recommend you to recover and recycle the refrigerant for reuse.

During a long period of disuse

The air conditioning should be operated for at least five minutes each week, even in cold weather. This is to prevent the compressor from seizing and to maintain the air conditioning in the best operating condition.

Air purifier*

E00708400675

An air filter has been incorporated into this air conditioning so that dirt and dust are cleaned from the air.

Replace the air filter periodically as its ability to clean the air will be reduced as it collects pollen and dirt. For the maintenance interval, refer to the "SERVICE BOOKLET".

NOTE

- Operation in certain conditions such as driving on a dusty road and frequent use of the air conditioning can lead to reduction of service life of the filter. When you feel that the air flow is lower than normal or when the windscreen or windows start to fog up easily, replace the air filter.
We recommend you to have it checked.

LW/MW/FM electronic tuning radio with CD player*

E00708502377

The audio system can only be used when the ignition switch or the operation mode is in ON or ACC.

NOTE

- To listen to the audio system while the engine is not running, turn the ignition switch to the "ACC" position or put the operation mode in ACC.
- If a cellular phone is used inside the vehicle, it may create noise from the audio equipment. This does not mean that anything is wrong with your audio equipment. In such a case, use the cellular phone at a place as far away as possible from the audio equipment.
- If foreign objects or water get into the audio equipment, or if smoke or a strange odour comes from it, immediately turn off the audio system. We recommend you to have it checked. Never try to repair it by yourself. Avoid continuous usage without inspection by a qualified person.

Volume and tone control panel

E00708601195

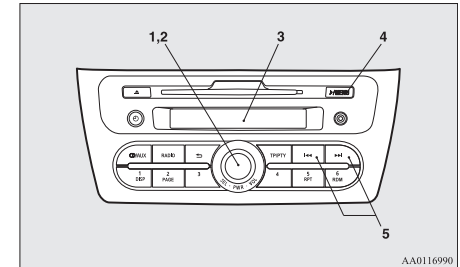

AA0116990

- 1- PWR (On-Off) switch
- 2- VOL (Volume control) knob
- 3- Display
- 4- > /MENU (Mode change) button
- 5- Sound control button

To adjust the volume

E00708700610

VOL (Volume control)

Turn the VOL knob clockwise to increase the volume; anticlockwise to decrease the volume.

To adjust the tone

E00708801328

Press the > /MENU button to select BASS → TREBLE → FADER → BALANCE → Sound control mode off.

BASS (Bass tone control)

Press the sound control button either <<< or >>> to select the desired bass level.

For pleasant driving

TREBLE (Treble tone control)

Press the sound control button either **◀** or **▶** to select the desired treble level.

FADER (Front/Rear balance control)

Press the sound control button either **◀** or **▶** to balance the volume of sound from the front and the rear speakers.

BALANCE (Left/Right balance control)

Press the sound control button either **◀** or **▶** to balance the volume of sound from the left and the right speakers.

NOTE

- The sound control mode will be cancelled when the another mode is selected or no adjustment is performed for more than 10 seconds.
- In a two-speakers vehicle, keep the FADER setting in the middle position. Since no rear speakers are connected, adjusting the FADER setting towards the “REAR” side will result in a loss of sound output.

Radio control panel and display

E00708901273

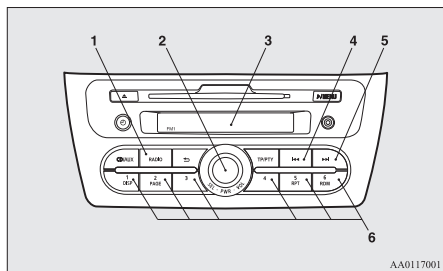

- 1- RADIO (FM/MW/LW selection) button
- 2- PWR (On-Off) switch
- 3- Display
- 4- Seek (Down-seek) button
- 5- Seek (Up-seek) button
- 6- Memory select buttons

To listen to the radio

E00709000926

1. Press the PWR switch or the RADIO button to turn ON the radio.
Press and hold the PWR switch for 2 seconds or longer to turn OFF the radio.
2. Press the RADIO button to select the desired band.
3. Press the seek button or memory select buttons to tune into a radio broadcasting station.

To tune the radio

E00709100679

Manual tuning

The frequency changes every time the seek button is pressed. Press the button to select the desired radio broadcasting station.

Automatic tuning

After keeping the seek button depressed until it beeps, release the button, and the selected station reception will start.

To enter frequencies into the memory

E00716101229

Manual setting

You can assign to the memory select buttons a maximum of 18 stations in the FM band (6 FM1, 6 FM2 and 6 FM3 stations) and 6 stations each in the MW and LW band. (Stations already assigned to the memory select buttons are replaced by any newly assigned stations.)

Follow the steps described below.

1. Press the seek to tune to the frequency you wish to keep in the memory.
2. Press one of the memory select buttons until it beeps.

The sound will be momentarily interrupted while the frequency is being entered into the memory. The number of the button matching the entry in the memory as well as the frequency is displayed.

3. The preset memory setting is retrieved by pressing the button and then releasing it within 1 second.

Automatic setting

With the method, all manually set stations in the band currently selected for reception are replaced with stations in the same band that are automatically selected in order of signal strength. The radio automatically selects 6 stations in the FM band (FM3 station only) and 6 stations each in the MW and LW band.

Follow the steps described below.

1. With the radio mode selected, hold down the RADIO button for 2 seconds or longer. The 6 stations with the best signal strength will automatically be assigned to the memory select buttons, with the lowest-frequency station being assigned to the lowest-number button.
2. When you subsequently press a memory select button to select a channel number, the radio will begin receiving the station assigned to that number.

NOTE

- If you press the RADIO button for 2 seconds or longer while tuning in the FM1 or FM2 band, the radio will automatically switch to the FM3 band, where the automatic seeking/ storing will be activated.

Radio data system (RDS)

E00709200481

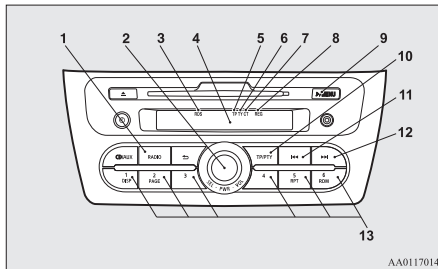

AA0117014

- 1- RADIO (FM/MW/LW selection) button
- 2- PWR (On-Off)/SEL (Select) switch
- 3- RDS (Radio data system) indicator
- 4- Display
- 5- TP (Traffic program identification) indicator

- 6- PTY (Program type) indicator
- 7- CT (Clock time) indicator
- 8- REG (Regional program) indicator
- 9- >/MENU button
- 10- TP (Traffic program)/PTY (Program type) button
- 11- SEEK (Down-seek) button
- 12- SEEK (Up-seek) button
- 13- Memory select buttons

RDS uses PI (program identification) signal and AF (alternative frequency) list transmitted in addition to the normal FM broadcasting programs, and picks up the FM stations that are transmitting the same program from the AF list and automatically tunes to the station with the strongest signal intensity.

Therefore, you can continue listening to one program in, for example, a long distance driving without retuning to the other station transmitting the same program when you are leaving the service area of the currently receiving station.

The RDS radio also features the limited reception of the program types, the break-in reception of the traffic announcement to the EON (enhanced other network) and emergency broadcast, and the limited/unlimited reception of the regional programs.

AF (Alternative Frequencies) function

E00720900162

The AF function finds a station broadcasting the same program and selects the station with the strongest signal of AF lists.

The AF function is turned on at all times unless you manually switch it off.

The AF function can be turned ON and OFF. Refer to “Function setup mode” on page 5-17.

CT (Clock Time) function

E00721000173

The clock can be set automatically by using the signal from the local RDS stations. Refer to “To adjust the clock” on page 5-21.

REG (Regional) function

E00721100116

REG function limits to receive the stations broadcasting regional programs.

Regional programming and regional networks are organized differently depending on the country or area (they may be changed according to the hour, state, or broadcast area), so if you don’t want to receive the regional programs automatically, you can set up REG ON not to receive regional programs.

The REG function can be turned ON and OFF. Refer to “Function setup mode” on page 5-17.

PI (Program Identification) search function

E00721200292

When travelling long distance and the recalled preset station is weak, the radio searches another frequency broadcasting the same programming with the same PI code in AF list.

If there are no frequencies broadcasting the same programming, the radio searches a frequency broadcasting the regional programming. The radio succeeds in searching the regional programming, then the display shows the REG indicator.

If the radio does not succeed in searching the regional programming, the radio returns to the recalled preset station.

The PI function can be turned ON and OFF. Refer to “Function setup mode” on page 5-17.

For pleasant driving

NOTE

- While searching, the audio system is muted. The display shows “PI-SEARCH”.

PTY (Program type)

E00721300365

RDS broadcasts are classified according to program type (PTY) as follows. Use the SEL switch to select your desired PTY.

1. NEWS
2. AFFAIRS (Current affairs)
3. INFO (Information)
4. SPORT
5. EDUCATE (Education)
6. DRAMA
7. CULTURE
8. SCIENCE
9. VARIED
10. POP M (Pop music)
11. ROCK M (Rock music)
12. EASY M (Easy music)
13. LIGHT M (Light classics)
14. CLASSICS
15. OTHER M (Other music)
16. WEATHER (Weather information)
17. FINANCE
18. CHILDREN
19. SOCIAL
20. RELIGION
21. PHONE IN
22. TRAVEL
23. LEISURE
24. JAZZ
25. COUNTRY
26. NATION M (National music)
27. OLDIES
28. FOLK M (Folk music)
29. DOCUMENT

To search for a broadcast of desired program type:

1. Press the PTY button.
2. Turn the SEL switch or press a memory select button to select your desired PTY.
3. Two seconds after a desired PTY has been selected, the radio will begin to search for a broadcast of your selected PTY. During search, the selected PTY on the display blinks.
4. When the radio picks up a station with your desired PTY, the display will show the name of the station.

NOTE

- If the SEEK button is pressed, the radio will try to find out another broadcast of the same program type as currently selected.
- If no station is found with your desired PTY, the display will show “EMPTY” for about 5 seconds and the radio will return to the previous station.

How to enter PTYs in the memory

E00721400177

As many as 6 PTYs can be entered in the memory. Follow the steps described below.

1. Turn the SEL switch to tune the PTY to be entered in the memory.
2. Press one of the memory select buttons for 2 seconds or longer. The sound will be momentarily interrupted while the PTY is being entered into the memory. The number of the button corresponding to the entry into the memory and the PTY are displayed.
3. The preset memory setting is retrieved by pressing the button and then releasing it within about 2 seconds.

To change the language of PTY display

E00721500253

You can select your favourite language among ENGLISH (English), FRANCAIS (French), DEUTSCH (German), SVENSK (Swedish), ESPANOL (Spanish) and ITALIANO (Italian).

1. Press the **▶**/MENU button for 2 seconds or longer to select the language of PTY display mode. Refer to “Function setup mode” on page 5-17.
2. Press the SEEK button to select a language.

NOTE

- After selecting a mode, you can leave the function setup mode by taking either of the following steps:
 - Press the **▶**/MENU button for at least 2 seconds.
 - Make no entry for 10 seconds.

Traffic information

E00721600270

The radio will automatically tune in to traffic information broadcasts while receiving FM broadcasts or playing compact discs.

To select this function, follow the instructions below.

1. Press the TP button. The display will show “TP”.

If the RDS data can be read, the display will show “RDS”. If not, the display will show “NO RDS” for about 5 seconds.

- If the radio detects traffic information on either the station currently selected or another station, the display will show "TRAF INF" for 5 seconds followed by a 2-second indication of the frequency. Then, it will show the name of the station broadcasting the traffic information to which you will listen. The volume level is set separately for listening to normal audio programs and for listening to traffic information. The volume level will therefore change automatically to that set when traffic information was last received. When the traffic information broadcast is over, the radio will return to the previously received program and to the corresponding volume level.
- Press the TP button to return to the previous condition.

NOTE

- While "TP" is illuminated, the radio stops only at TP stations, even if the SEEK button is pressed.

TP (Traffic information Program) search function

E00721800197

The traffic information program standby function is turned on (with the TP indicator shown on the display) and after about 45 seconds since the RDS indicator turns off due to weak signal or the tuning station is changed over from a TP station to a station which does not broadcast traffic information, the sound will beep 5 times and seeks out a TP station in all frequencies automatically.

The TP search function can be turned ON and OFF. Refer to "Function setup mode" on page 5-17.

Emergency broadcasts

E00721700268

If an emergency broadcast is caught while receiving a FM broadcast or playing back a compact disc with the ignition switch or the operation mode is in ON or ACC, the display will show "ALARM" and the emergency broadcast will interrupt the current program. The volume level is set separately for listening to normal audio programs and for listening to emergency broadcasts. The volume level will therefore change automatically to that set when an emergency broadcast or traffic information broadcast was last received. When the emergency broadcast is over, the radio will return to the previously received program and to the corresponding volume level.

Function setup mode

E00722500465

It is possible to change the following functions:

- AF
- REG*
- TP-S
- PI-S*
- Language of PTY display

- Press the **MENU** button for 2 seconds or longer to select the function setup mode.
- Press the **SEEK** button repeatedly to select the mode you wish to change.
The order is: AF → REG* → TP-S → PI-S* → Language of PTY display → Function setup mode OFF.
- Select the desired setting for each mode to be turned ON and OFF as shown below.

The setting will be shown on the display.

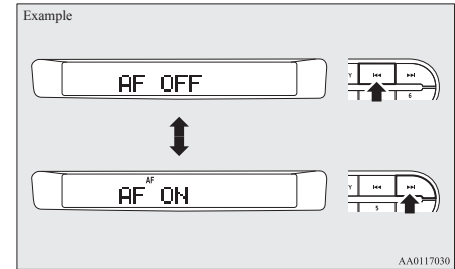

AA0117030

NOTE

- After selecting a mode, you can leave the function setup mode by taking either of the following steps:
 - Press the **MENU** button for at least 2 seconds.
 - Make no entry for 10 seconds.

CD control panel and display

E00709501263

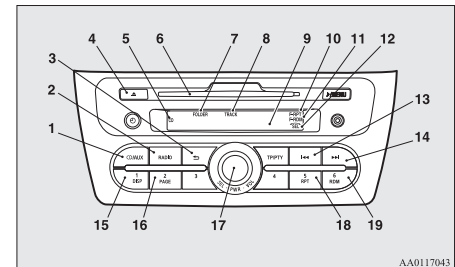

AA0117043

For pleasant driving

- 1- CD (CD mode changeover) button
- 2- RADIO button
- 3- ➔(Return) button
- 4- CD eject button
- 5- CD indicator
- 6- Disc-loading slot
- 7- FOLDER (Folder number) indicator
- 8- TRACK (Track number) indicator
- 9- Display
- 10- RPT (Repeat) button/F-RPT (Folder repeat mode) indicator
- 11- RDM (Random mode)/F-RDM (Folder random mode) indicator
- 12- SEL (Select) indicator
- 13- ◀◀ (Fast-reverse/Track down) button
- 14- ▶▶ (Fast-forward/Track up) button
- 15- DISP (Display) button
- 16- PAGE (Title scroll) button
- 17- PWR (On-Off)/SEL (Select) switch
- 18- RPT (Repeat) button
- 19- RDM (Random) button

To listen to a CD

E00709602362

To set a disc

1. Insert disc with label facing up.
When a disc is inserted, the CD indicator will come on and the CD player will begin playing even if the radio is being used. The CD player will also start playback when the CD button is pressed with a disc in the player or with a disc set in the Disc-loading slot, even if the radio is being used.
2. To stop the CD, turn off the power by pressing the PWR switch for 2 seconds or longer, or change over to the radio mode by pressing the RADIO button, or eject the disc by pressing the eject button.

NOTE

- For information on adjusting the volume and tone, refer to “To adjust the volume” on page 5-13 and “To adjust the tone” on page 5-13.
- An 8 cm compact disc cannot be played on this CD player.
- For information concerning the handling of compact discs, refer to “Handling of compact discs” on page 5-29.

To eject a disc

When the CD eject button is pressed, the disc automatically stops and is ejected.

NOTE

- If you do not remove the disc before 15 seconds have elapsed, the CD player will automatically reload the disc and stop.

To listen to a music CD

Press the CD button if a disc is already in the CD player. The CD player will enter CD mode and start playback. The track number and the playing time will appear on the display. The tracks in the disc will be played continuously.

To listen to an MP3 CD

This CD player allows you to play MP3 (MPEG Audio Layer-3) files recorded on CD-ROMs, CD-Rs (recordable CDs), and CD-RWs (rewritable CDs) in ISO9660 Level 1/Level 2, Joliet, and Romeo formats. Each disc can hold up to 255 files in up to 100 folders, up to a maximum of 16 levels. The ID3 tag information can be displayed during MP3 playback. For information concerning ID3 tags, refer to “CD text and MP3 title display” on page 5-20.

1. Insert a disc containing MP3 files into the slot.

2. Press the CD button if a disc is already in the CD player.

The display shows “READING”, then playback will begin.

NOTE

- While listening to a disc on which CD-DA (CD-Digital Audio) and MP3 files have both been recorded, you can switch between reading of the CD-DA, reading of the MP3 files, and the external audio input mode by pressing the CD button for 2 seconds or longer (until you hear a beep).
For information on the external audio input, refer to “To use the external audio input function” on page 5-22.
- With a disc that contains both CD-DA and MP3 files, the CD-DA files are automatically played first.
- The playback sound quality differs depending on the encoder software and the bit rate. For more information, refer to the owner’s manual for the encoder software.
- Depending on the layout of the files and folders on the disc, it may take some time until playback starts.
- MP3 conversion software and writing software are not supplied with this unit.
- You may encounter trouble in playing an MP3 or displaying the information of MP3 files recorded with certain writing software or CD recorders (CD-R/RW drivers).
- If you write many folders or files other than MP3 files, it may take some time before playback starts.
- This unit does not record MP3 files.

- For information on CD-Rs/RWs, refer to “Notes on CD-Rs/RWs” on page 5-29.

⚠ CAUTION

- Attempting to play a file not in the MP3 format which has a “.mp3” file name may produce noise from the speakers and speaker damage, and can significantly damage your hearing.

Folder selection order/MP3 file playback order (Example)

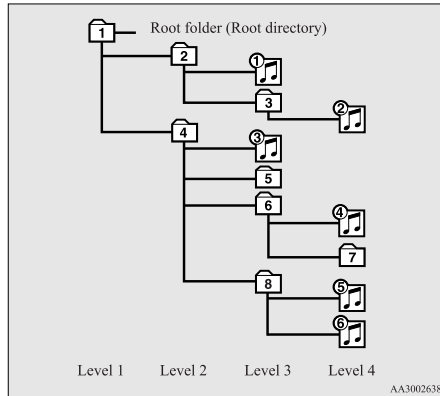

Folder selection

In the order

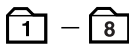

File selection

In the order

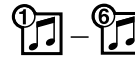

To fast-forward/reverse the disc

Fast-forward

The disc is fast-forwarded while the ►► button is held down. Playback will begin once the button is released.

Fast-reverse

The disc is fast-reversed while the ◀◀ button is held down. Playback will begin once the button is released.

To select a desired track

Track up

The disc will skip as many songs as the number of times the button ►►1 is pressed. The display window will display the track number of the track selected.

Track down

The disc will skip as many songs as the number of times the button ◀◀1 is pressed. The display window will display the track number of the track selected.

To find a file (MP3 CDs only)

Operate the SEL switch to select desired file. When this mode is activated by pressing the SEL switch, the SEL indicator will be displayed in the display.

Press the SEL : To start this mode or to select switch the folder or file.

Turn the SEL : To show the folder or file switch

NOTE

- To cancel the selection, press the ⇐ button to return to the previous step.
- If no operation is performed for 10 seconds or more or other button is operated after the SEL switch has been turned, searching of the desired file is cancelled.
- If no operation is performed for 5 seconds or more after the file is displayed, playback starts.
- When the SEL indicator is not shown on the display and the SEL switch is operated, the volume adjustment is effective.

To repeat tracks

To repeat a track

Press the RPT button to repeat the same track. If the RPT button is pressed, the RPT indicator will come on.

To exit this mode, press the button again.

To repeat songs in the same folder (MP3 CDs only)

While a song is playing, press the RPT button for 2 seconds or longer (until you hear a beep). The F-RPT indicator will come on and the disc will repeat all the songs in the folder that contains the song currently playing.

To exit this mode, press the button again.

For pleasant driving

NOTE

- With a disc that contains both CD-DA and MP3 files, the repeat mode causes only files of the same format (CD-DA only or MP3 files only) to be repeated.

To change track playback order

Random playback for a disc (music CDs only)

If the RDM button is pressed, the RDM indicator will come on and the tracks that are played will be selected at random.

To exit this mode, press the button again.

Random playback for a folder (MP3 CDs only)

If the RDM button is pressed, the F-RDM indicator will come on and the tracks that are played will be selected at random from the folder that is currently selected.

To exit this mode, press the button again.

Random playback for all folders on a disc (MP3 CDs only)

Press the RDM button for 2 seconds or longer (until you hear a beep). The RDM indicator will come on and the tracks that are played will be selected at random from all folders on the disc currently selected.

To exit this mode, press the button again.

NOTE

- With a disc that contains both CD-DA and MP3 files, the random mode causes only files of the same format (CD-DA only or MP3 files only) to be played in a random sequence.

CD text and MP3 title display

E00725000706

This CD player can display CD text and MP3 titles including ID3 tag information.

CD text

The CD player can display disc and track titles for discs with converted disc and track title information. Press the DISP button repeatedly to make selections in the following sequence: disc name → track name → normal display mode.

NOTE

- The display can show up to 11 characters. If a disc name or track name has more than 11 characters, press the PAGE button to view the next 11 characters.
- When there is no title information to be displayed, the display shows “NO TITLE”.
- Characters that the CD player cannot display are shown as “•”.

MP3 titles

The CD player can display folder and file titles for discs with converted folder and file information. Press the DISP button repeatedly to make selections in the following sequence: folder name → file name → normal display mode.

ID3 tag information

The CD player can display ID3 tag information for files that have been recorded with ID3 information.



1. Press the DISP button for 2 seconds or longer to switch to the ID3 tag information.
2. Press the DISP button repeatedly to make selections in the following sequence: album TAG → track TAG → artist TAG → normal display mode.

NOTE

- To return from ID3 tag information to the folder name, press the DISP button again for 2 seconds or longer.
- When there is no title information to be displayed, the display shows “NO TITLE”.
- The display can show up to 11 characters. If a folder name, track name, or item of ID3 tag information has more than 11 characters, press the PAGE button to view the next 11 characters.
- Characters that the CD player cannot display are shown as “•”.

To display the clock

E00766500029

Press the  button to switch the clock mode. To exit the clock mode, press the  button.

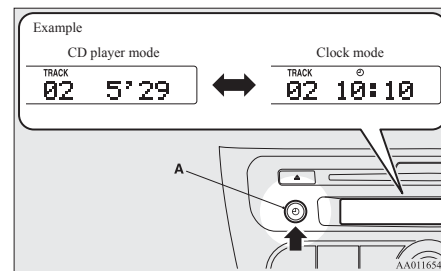

A-  (Clock) button

NOTE

- While the clock mode is selected, the display will switch to the applicable operation display whenever the CD player, external audio input mode or radio, etc. is operated. Then, if no entries are made for 7 seconds, the display will automatically return to the clock mode.

To adjust the clock

E00766200042

Automatic mode and manual mode is available for digital clock adjustment.

Select the automatic mode or the manual mode by performing the following operations:

1. Press the PWR switch to turn ON the audio system.
2. Enter the function setup mode by pressing the  button for 2 seconds or longer.

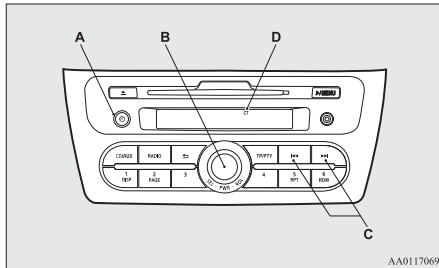

- A-  (Clock) button
- B- POWER (On-Off) button
- C- SEEK button
- D- CT indicator

3. Select the desired setting for each mode to be turned ON and OFF.

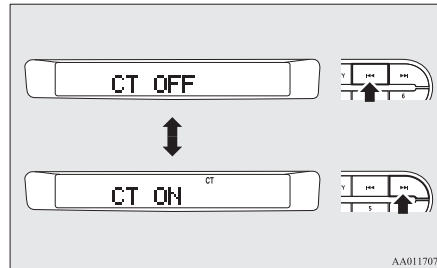

- CT ON- Automatic mode
- CT OFF- Manual mode

NOTE

- After selecting a mode, you can leave the function setup mode by taking either of the following steps:
 - Press the  button for at least 2 seconds.
 - Make no entry for 7 seconds.



Automatic mode





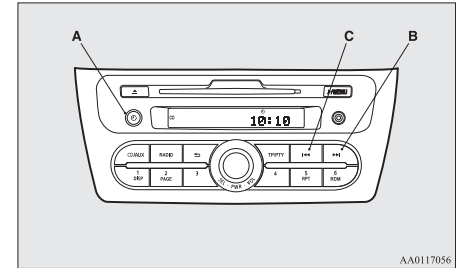

The automatic adjustment mode can set the local time automatically by using the signal from local RDS stations. In this mode, CT indicator is shown in the display. Refer to “Radio data system (RDS)” on page 5-15.

Manual mode

The manual mode is also available in case the automatic mode shows the incorrect time when the adjacent local RDS stations are located in a different time zone. Refer to “Radio data system (RDS)” on page 5-15.



- A-  (Clock) button
- B-  (clock adjustment up) button
- C-  (clock adjustment down) button

1. Press and hold the  button and the clock display flashes.
2. Press the  or  button to adjust the “hours” digit.
If you keep pressing the button, fast-forward begins.
3. When the “hours” digit is adjusted, press the  button to flash the “minutes” digit.
Press the  or  button to adjust the “minutes” digit.
If you keep pressing the button, fast-forward begins.
4. When the time is set, press the  button to stop the clock display from flashing.

For pleasant driving

NOTE

- When using the manual mode to adjust the clock, set the “CT” function to “OFF”. If the “CT” function is set to “ON”, the time will automatically be corrected using the signals from the local RDS stations even if it was set manually.
- Reset the time after the battery terminals are disconnected and reconnected.
- Seconds do not appear in the clock display, but after adjusting the “minutes” setting, the clock begins to operate from 0 seconds.

To use the external audio input function

E00766300043

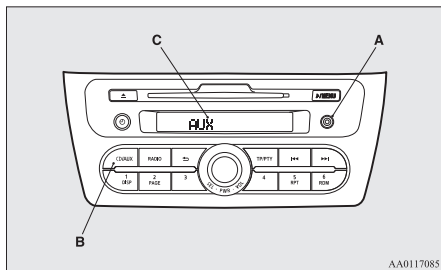

- A- Auxiliary Audio connector (mini-jack)
- B- AUX button
- C- Display

You can listen to commercially available audio equipment, such as a portable audio system, from your vehicle’s speakers, by connecting the audio equipment to the auxiliary audio connector.

NOTE

- Use a stereo mini-jack connector to connect the audio equipment to the auxiliary audio connector.

To activate the external audio input mode

E00766400044

1. Connect the headphone port of the portable audio system to the auxiliary audio connector using a commercially available connection cord.
2. Press the AUX button several times to switch to the AUX mode. The display will show “AUX” and then the external audio input mode will be activated.
3. To deactivate the external audio input mode, press the AUX button to switch to another mode.

⚠ CAUTION

- **Do not operate the connected audio equipment while driving. This could distract you and an accident might occur.**

NOTE

- The connected audio equipment cannot be operated with the vehicle’s audio system.
- Depending on the connected audio equipment, it may produce noise from the speakers.

- Use the connected audio equipment’s own power source, such as its battery. Noise may be produced from the speakers if the connected audio equipment is used while charging it using the accessory socket of the vehicle.
- Do not activate the external audio input mode when no audio equipment is connected. Otherwise, noise may be produced from the speakers.
- Connect audio equipment when the external audio input mode is deactivated or lower the vehicle’s speaker volume before connecting it. Noise may be produced from the speakers if audio equipment is connected after the external audio input mode is activated.
- Compared to the CD player mode and radio mode, the vehicle’s speaker volume will be lower in the external audio input mode. Therefore, be careful when switching from the external audio input mode to the CD player mode or radio mode since the speaker volume will be higher.
- Do not use excessive force on the connection cord. Otherwise, the cord and connectors may be damaged.
- If the connection cord alone is left connected to the auxiliary audio connector, noise may be produced from the speakers.
- For information on how to connect and operate the commercially available audio equipment, refer to the owner’s manual for the commercially available audio equipment.

To play tracks from USB device*

E00756100240

If your vehicle is equipped with the USB input terminal, you can connect your iPod or USB memory device to the USB input terminal and play music files stored in the iPod or USB memory device.

See the following section for the types of connectable devices and supported files.

Refer to “Types of connectable devices and supported file specifications” on page 5-33.

See the following sections for the connecting methods, “How to connect an iPod” on page 5-32 and “How to connect a USB memory device” on page 5-31.

NOTE

- A file protected by copyright may not be able to playback.
- It is recommended to adjust the equalizer of the connected device to 0 db or neutral.

iPod control panel and display

E00756200296

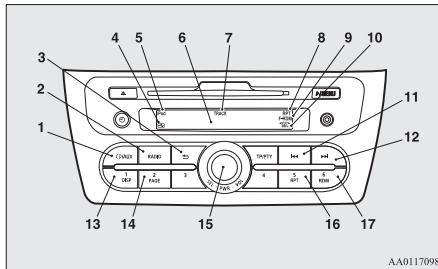

AA0117098

1- CD (Mode changeover) button

- 2- RADIO button
- 3- (Return) button
- 4- (USB device active) indicator
- 5- iPod indicator
- 6- Display
- 7- TRACK (Track number) indicator
- 8- RPT (Repeat mode) indicator
- 9- RDM (Random mode)/F-RDM (Folder random mode) indicator
- 10- SEL (Select) indicator
- 11- (Fast-reverse/Track down) button
- 12- (Fast-forward/Track up) button
- 13- DISP (Title display) button
- 14- PAGE (Title scroll) button
- 15- PWR (On-Off)/SEL (Select) switch
- 16- RPT (Repeat) button
- 17- RDM (Random) button

To play from an iPod

E00756300398

1. Press the PWR button to turn on the audio system. The system turns on in the last mode used.
2. Connect your iPod to the USB input terminal. Refer to “How to connect an iPod” on page 5-32.
3. Press the CD button several times to switch to the iPod mode. The input mode changes as follows every time the CD button is pressed: CD mode → iPod mode → AUX mode → CD mode.
The iPod indicator is illuminated and then the iPod mode will be activated.
4. Once the device is selected, playback starts and indicator appears on the display.

NOTE

- Depending on the condition of your iPod, it may take a longer time before the playback starts.
5. To stop the playback, press the RADIO button or CD button to switch to a different mode.

NOTE

- Buttons on the iPod are disabled while the iPod is connected to the audio system.
- To adjust the volume and tone, refer to “To adjust the volume” on page 5-13 and “To adjust the tone” on page 5-13.

To fast-forward/reverse the track

E00756400139

To fast-forward/reverse the current track, press the button or button.

Fast-forward

To fast-forward the current track, press the button. While the button is kept pressed, the track will be fast-forwarded.

Fast-reverse

To fast-reverse the current track, press the button. While the button is kept pressed, the track will be fast-reversed.

To select a desired track

E00756500130

Track up

Press the button repeatedly until the desired track number appears on the display.

Track down

Press the button repeatedly until the desired track number appears on the display.

For pleasant driving

NOTE

- Pressing the **⏮** button once during the song will cause the audio system to restart playback from the beginning of the song.

To find a track from the iPod menu

E00756600203

You can select desired tracks from the “Playlists”, “Artists”, “Albums” or “Songs” menus on your iPod.

Operate the SEL switch to select desired tracks.

The selected menu or category or track is shown in the display.

When this mode is activated by pressing the SEL switch, the SEL indicator will be displayed in the display.

Press the SEL switch :To start this mode or to select the menu or category or track.

Turn the SEL switch :To show the menu or category or track.

NOTE

- To cancel the selection, press the **⏪** button to return to the previous step.
- If no operation is performed for 10 seconds or more or other button is operated after the SEL switch has been pressed, searching of the desired tracks is cancelled.
- If no operation is performed for 5 seconds or more after the track is displayed, playback starts.
- When the SEL indicator is not shown on the display and the SEL switch is operated, the volume adjustment is effective.

To play the same track repeatedly

E00756700044

Press the RPT button during playback to show “RPT” in the display.

To exit this mode, press the button again.

To play tracks in random order

E00756900046

Press the RDM button to show “RDM” in the display.

The iPod randomly selects tracks from the current category and plays the selected tracks.

To exit this mode, press the button again.

To play tracks in each album in random order

E00757000103

Press and hold the RDM button until you hear a beep to show “F-RDM” in the display.

The iPod randomly selects tracks in the album from the current category and play the selected tracks.

To exit this mode, press the button again.

To switch the display

E00757100120

You can display the track titles, artist names and album titles recorded in the iPod.

The display changes as follows every time the DISP button is pressed during playback: Album title → Track name → Artist name → Normal display.

NOTE

- Up to 11 characters are shown in the display at once. If the title is cut off in the middle, press the PAGE button. The next characters are displayed every time this button is pressed.
- If no title is stored, “NO TITLE” is shown in the display.
- Characters that cannot be displayed are substituted by “•”.

USB control panel and display

E00758100299

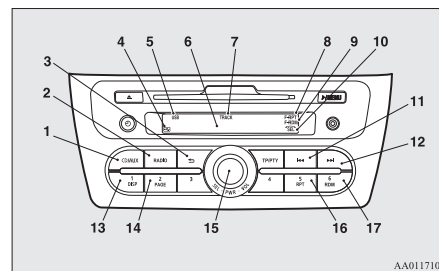

- 1- CD (Mode changeover) button
- 2- RADIO button
- 3- **⏪** (Return) button
- 4- **USB** (USB device active) indicator
- 5- USB indicator
- 6- Display
- 7- TRACK (Track number) indicator
- 8- RPT (Repeat mode)/F-RPT (Folder repeat mode) indicator
- 9- RDM (Random mode)/F-RDM (Folder random mode) indicator
- 10- SEL (Select) indicator
- 11- **⏮** (Fast-reverse/Track down) button
- 12- **⏭** (Fast-forward/Track up) button
- 13- DISP (Title display) button
- 14- PAGE (Title scroll) button
- 15- PWR (On-Off)/SEL (Select) switch
- 16- RPT (Repeat) button
- 17- RDM (Random) button

To play from a USB memory device

E00762500382

1. Press the PWR button to turn on the audio system. The system turns on in the last mode used.
2. Connect your USB memory device to the USB input terminal.
Refer to “How to connect a USB memory device” on page 5-31.
3. Press the CD button several times to switch to the USB mode. The input mode changes as follows every time the CD button is pressed: CD mode → USB mode → AUX mode → CD mode.
The USB indicator is illuminated and then the USB mode will be activated.
4. Once the device is selected, playback starts and  indicator appears on the display.

NOTE

- Depending on the condition of your USB device, it may take a longer time before the playback starts.
5. To stop the playback, press the RADIO button or CD button to switch to a different mode.

NOTE

- To adjust the volume and tone, refer to “To adjust the volume” on page 5-13 and “To adjust the tone” on page 5-13.

Supported compressed music files

E00758300389

This audio can play MP3, WMA and AAC files recorded in a USB memory device. This audio supports up to 65,535 files in 700 folders on 8 levels.

Folder selection order/file playback order (example)

The folder and file hierarchy in the USB memory device is shown below.

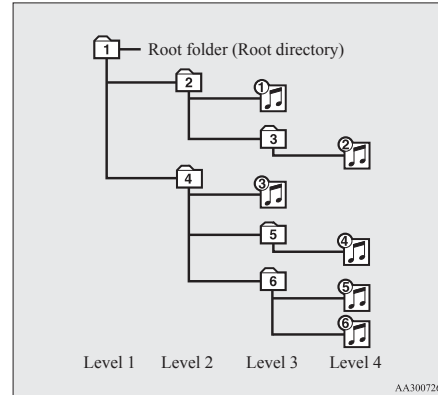

Folder selection

In the order



File selection

In the order





NOTE

- If a file protected by copyrights is played, the file will be skipped.

To fast-forward/reverse the track

E00758400117

To fast-forward/reverse the current track, press the  button or  button.

Fast-forward

To fast-forward the current track, press the  button. While the button is kept pressed, the track will be fast-forwarded.

Fast-reverse

To fast-reverse the current track, press the  button. While the button is kept pressed, the track will be fast-reversed.

To select a file

E00758500134

Track up

Press the  button repeatedly until the desired file number appears on the display.

Track down

Press the  button repeatedly until the desired file number appears on the display.

NOTE

- Pressing the  button once during the song will cause the audio system to restart playback from the beginning of the file.

To find a file

E00758600340

Operate the SEL switch to select desired file. When this mode is activated by pressing the SEL switch, the SEL indicator will be displayed in the display.

Press the SEL . To start this mode or to select the folder or file.

For pleasant driving

Turn the SEL : To show the folder or file.
switch

NOTE

- To cancel the selection, press the  button to return to the previous step.
- If no operation is performed for 10 seconds or more or other button is operated after the SEL switch has been turned, searching of the desired file is cancelled.
- If no operation is performed for 5 seconds or more after the file is displayed, playback starts.
- When the SEL indicator is not shown on the display and the SEL switch is operated, the volume adjustment is effective.

To play the same file repeatedly

E00758700048

Press the RPT button to show “RPT” in the display. To cancel this mode, press the button again.

To play the files in the same folder repeatedly

E00758800108

Press and hold the RPT button until you hear a beep to show “F-RPT” in the display. All tracks in the current folder are played repeatedly. To exit this mode, press the button again.

To play a folder in random order

E00758900109

Press the RDM button to show “F-RDM” in the display. The audio randomly selects tracks from the current folder and plays the selected tracks. To exit this mode, press the button again.

To play all folders in random order

E00759000107

Press and hold the RDM button until you hear a beep to show “RDM” in the display. The audio randomly selects tracks from all folders and plays the selected tracks. To exit this mode, press the button again.

To switch the display

E00759300214

You can displays titles with tag information.

Folder title

The display changes as follows every time the DISP button is pressed during playback: Folder name → File name → Normal display.

Tag information

1. Press and hold the DISP button until you hear a beep.
2. The display changes as follows every time the DISP button is pressed briefly: Album TAG → Track TAG → Artist TAG → Normal display.

NOTE

- Press and hold the DISP button again until you hear a beep, and the tag information display returns to the folder title display.
- Up to 11 characters are shown in the display at once. If the title is cut off in the middle, press the PAGE button. The next characters are displayed every time this button is pressed.
- If no title is stored, “NO TITLE” is shown in the display.
- Characters that cannot be displayed are substituted by “•”.

Error codes

If an error code appears in the display, take action in accordance with the table below.

Audio system

Error display	Item	Repair
CHECK DISC	Disc is not loaded correctly, or condensation on disc.	Insert disc with label facing up. Remove moisture from disc.
DISC ERROR	Disc is dirty, scratched, or deformed; or excessive vehicle vibration.	Clean or replace disc. Retry when vibrations stop.
INTERNAL E	Loading or eject error. Pick-up is out of position.	Eject disc and reload. If disc will not eject, have the equipment inspected.
HEAT ERROR	Internal protection against high temperatures.	Allow radio to cool by waiting about 30 minutes.
ERROR DC	Foreign material is inside the radio or amplifier.	Bring your vehicle to a MITSUBISHI MOTORS Authorized Service Point.

iPod*

Error display	Item	Repair
NO SONG	There are no playable music files.	Record music files in the iPod.
VER ERROR	The iPod or its software cannot be recognized.	Connect a supported iPod.

USB memory device*

Error display	Item	Repair
FILE ERROR	The file cannot be played.	The file is protected by copyrights, etc. An error is displayed for several seconds, and then the next playable file is played automatically.
UNSUPPORTED (first) → DEVICE (after)	The USB memory device cannot be recognized.	Remove the USB memory device.
UNSUPPORTED (first) → FORMAT (after)	The USB memory device format cannot be recognized.	Remove the USB memory device.
USB BUS PWR	An overcurrent or other power-supply error has occurred.	Remove the USB memory device. Have the vehicle inspected at a MITSUBISHI MOTORS Authorized Service Point.

For pleasant driving

Error display	Item	Repair
LSI ERROR	Internal device errors	Have the vehicle inspected at a MITSUBISHI MOTORS Authorized Service Point.

Handling of compact discs

E00723000454

- Use only the type of compact discs that have the mark shown in the illustration below. (Playback of CD-R or CD-RW discs may cause problems.)



- The use of special shaped, damaged compact discs (like cracked discs) or low-quality compact discs (like warped discs or burrs on the discs) such as those shown will damage the CD player.

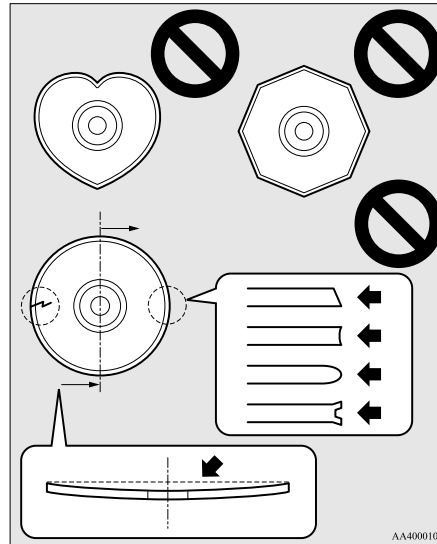

- In the following circumstances, moisture can form on discs and inside the audio system, preventing normal operation.
 - When there is high humidity (for example, when it is raining).
 - When the temperature suddenly rises, such as right after the heater is turned on in cold weather.

In this case, wait until the moisture has had time to dry out.

- When the CD player is subjected to violent vibrations, such as during off-road driving, the tracking may not work.

- When storing compact discs, always store them in their separate cases. Never place compact discs in direct sunlight, or in any place where the temperature or humidity is high.
- Never touch the flat surface of the disc without a label. This will damage the disc surface and could affect the sound quality. When handling a compact disc, always hold it by the outer edge and the centre hole.
- To clean a disc, use a soft, clean, dry cloth. Wipe directly from the centre hole towards the outer edge. Do not wipe in a circle. Never use any chemicals such as benzene, paint thinner, a disc spray cleaner, or an anti-static agent on the disc.
- Do not use a ball point pen, felt pen, pencil, etc. to write on the label surface of the disc.
- Do not put additional labels or stickers on compact discs. Also, do not use any compact disc on which a label or sticker has started to peel off or any compact disc that has stickiness or other contamination left by a peeled-off label or sticker. If you use such a compact disc, the CD player may stop working properly and you may not be able to eject the compact disc.

Notes on CD-Rs/RWs

E00725100055

- You may have trouble playing back some CD-R/RW discs recorded on CD recorders (CD-R/RW drives), either due to their recording characteristics or dirt, fingerprints, scratches, etc. on the disc surface.
- CD-R/RW discs are less resistant to high temperatures and high humidity than ordinary music CDs and can therefore be damaged and rendered unplayable if left inside your vehicle for a long time.

For pleasant driving

- Depending on the combination of the writing software, the CD recorder (CD-R/RW drive), and the disc used to create a CD-R/RW, the disc might not play successfully.
- This player cannot play the CD-R/RW discs if the session is not closed.
- This player cannot play CD-R/RW discs which contain other than CD-DA or MP3 data (Video CD, etc.).
- Be sure to observe the handling instructions for the CD-R/RW disc.

⚠ WARNING

- Operating the CD player in a manner other than specifically instructed herein may result in hazardous radiation exposure. Do not remove the cover and attempt to repair the CD player by yourself. There are no user serviceable parts inside. If the CD player is not working correctly, it is recommended that you have it inspected.

Antenna

E00710500022

Roof antenna

E00710900127

When listening to the radio, fully raise the antenna up.

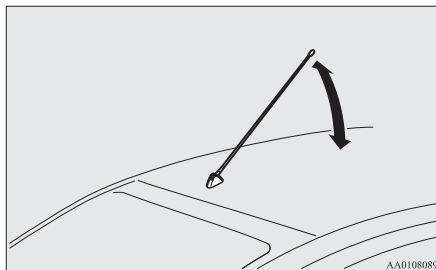

To remove

Turn the pole (A) anticlockwise.

To install

Screw the pole (A) clockwise into the base (B) until it is securely retained.

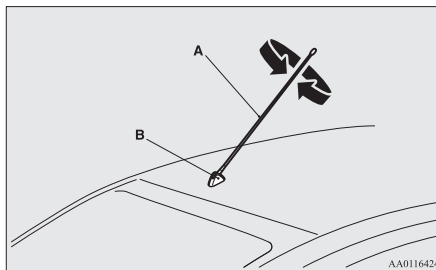

NOTE

- Be sure to remove the roof antenna in the following cases:
 - When using an automatic car wash.
 - When placing a car cover over the vehicle.
- Before driving into a structure that has a low ceiling, fold down the antenna to prevent it from hitting the ceiling.

Link System*

E00764500155

The Link System takes overall control of the devices connected via the USB input terminal allowing the connected devices to be operated by using the switches in the vehicle.

See the following section for details on how to operate.

Refer to “USB input terminal” on page 5-31.

Refer to “To play tracks from USB device” on page 5-23.

USB input terminal*

E00761900015

You can connect your USB memory device or iPod* to play music files stored in the USB memory device or iPod.

The following explains how to connect and remove a USB memory device or iPod.

Refer to the following sections for details on how to play music files:

Refer to “To play tracks from USB device” on page 5-23.

*: “iPod” is a registered trademark of Apple Inc. in the United States and other countries.

How to connect a USB memory device

E00762000404

To connect

1. Park your vehicle in a safe place and turn the ignition switch to the “LOCK” position or put the operation mode in OFF.
2. Open the glove box and remove the terminal part (A) of the connector cable (B) from clip (C).

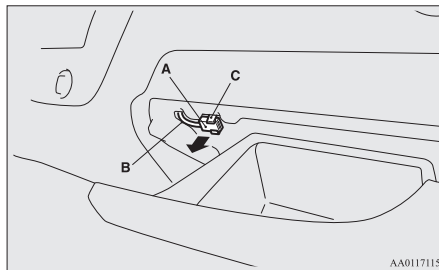

3. Connect a commercially available USB connector cable (D) to the USB memory device (E).

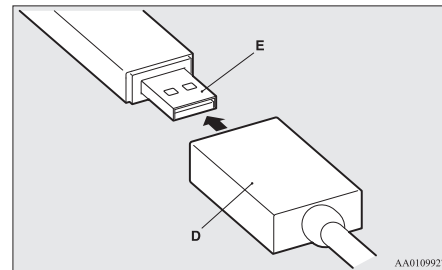

4. Connect the commercially available USB connector cable (D) to the vehicle's connector cable (B).
Be sure to hold the terminal part (A) of the connector cable as shown in the illustration.
5. Fix the terminal part (A) of the connector cable on the clip.

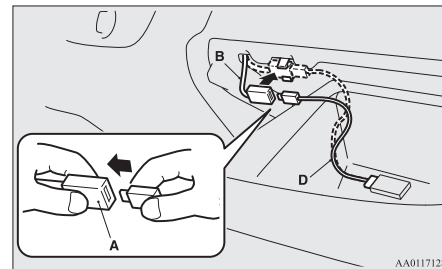

⚠ CAUTION

- Keep the lid of the glove box closed while driving the vehicle. A lid or the contents of the glove box could otherwise cause injuries.

NOTE

- Do not connect the USB memory device to the vehicle's connector cable directly. The USB memory device may be damaged.
- When closing the glove box, be careful not to trap the connector cable and USB memory device.

To remove

1. Turn the ignition switch to the "LOCK" position or put the operation mode in OFF.
2. Remove the commercially available USB connector cable (D).
Be sure to hold the terminal part (A) of the connector cable as shown in the illustration.

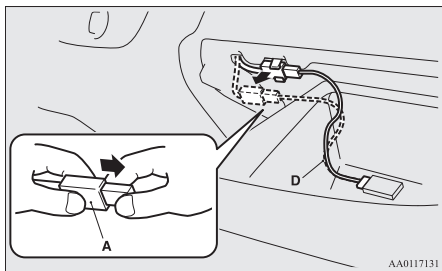

3. Fix the terminal part (A) of the connector cable on the clip and close the glove box.

How to connect an iPod

E00762100304

To connect

1. Park your vehicle in a safe place and turn the ignition switch to the "LOCK" position or put the operation mode in OFF.
2. Open the glove box and remove the terminal part (A) of the connector cable (B) from clip (C).

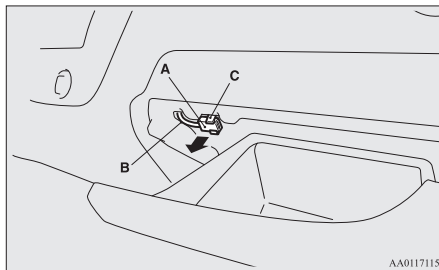

3. Connect the Dock connector (D) to the iPod (E).

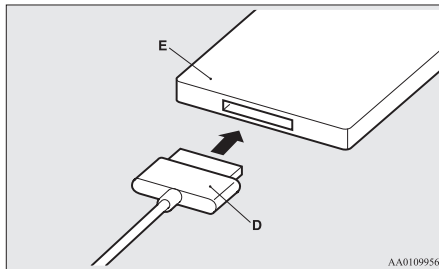

NOTE

- Use a genuine Dock connector from Apple Inc.
On vehicles equipped with MITSUBISHI Multi-Entertainment System (MMES), refer to the separate "MITSUBISHI Multi-Entertainment System owner's manual" for details of connection.
4. Connect the Dock connector (D) to the connector cable (B).
Be sure to hold the terminal part (A) of the connector cable as shown in the illustration.
 5. Fix the terminal part (A) of the connector cable on the clip.

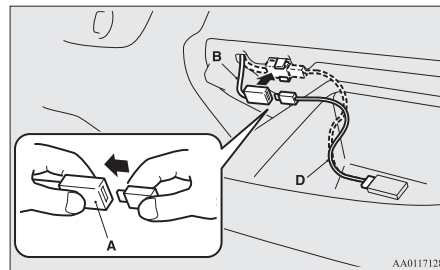

⚠ CAUTION

- Keep the lid of the glove box closed while driving the vehicle. A lid or the contents of the glove box could otherwise cause injuries.

NOTE

- When closing the glove box, be careful not to trap the connector cable and iPod.

To remove

1. Turn the ignition switch to the “LOCK” position or put the operation mode in OFF.
2. Remove the Dock connector (D). Be sure to hold the terminal part (A) of the connector cable as shown in the illustration.

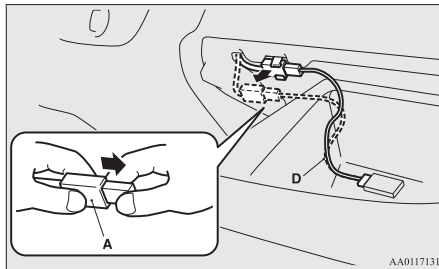

3. Fix the terminal part (A) of the connector cable on the clip and close the glove box.

Types of connectable devices and supported file specifications

E00762200015

Device types

E00762300263

Devices of the following types can be connected.

Model name		Condition
USB memory device		Storage capacity of 256 Mbytes or more
iPod*	fifth generation	F/W Ver.1.3 or later
iPod classic*	80GB/180GB	F/W Ver.1.1.2 or later
	120GB	F/W Ver.2.0.1 or later
	160GB (late 2009)	F/W Ver.2.0.4 or later
iPod nano*	first generation	F/W Ver.1.3.1 or later
	second generation	F/W Ver.1.1.3 or later
	third generation	F/W Ver.1.1.3 or later
	fourth generation	F/W Ver.1.0.4 or later
	fifth generation	F/W Ver.1.0.2 or later
	sixth generation	F/W Ver.1.0 or later
iPod touch*	first generation	F/W Ver.3.1.3 or later
	second generation	F/W Ver.4.2.1 or later
	third generation	F/W Ver.4.3.1 or later
	fourth generation	F/W Ver.4.3.1 or later

*: “iPod,” “iPod classic,” “iPod nano,” “iPod touch” and “iPhone” are registered trademarks of Apple Inc. in the United States and other countries.

Model name		Condition
iPhone*	iPhone	F/W Ver.3.1.3 or later
	iPhone 3G	F/W Ver.4.2.1 or later
	iPhone 3GS	F/W Ver.4.3.1 or later
	iPhone 4	F/W Ver.4.3.1 or later
	iPhone 4S	F/W Ver.5.0.1 or later
Models other than USB memory devices and iPods		Digital audio player supporting mass storage class

*: “iPod,” “iPod classic,” “iPod nano,” “iPod touch” and “iPhone” are registered trademarks of Apple Inc. in the United States and other countries.

NOTE

- Depending on the type of the USB memory device or other device connected, the connected device may not function properly or the available functions may be limited.
- Use the iPod whose firmware has been updated to the latest version.
- You can charge your iPod by connecting it to the USB input terminal when the ignition switch or the operation mode is in ON or ACC.
- Do not keep your USB memory device or iPod in your vehicle.
- It is recommended that you back up files in case of data damage.

For pleasant driving

- Do not connect to the USB input terminal any device (hard disk, card reader, memory reader, etc.) other than the connectable devices specified in the previous section. The device and/or data may be damaged. If any of these devices was connected by mistake, remove it after turning the ignition switch to the “LOCK” position or putting the operation mode in OFF.

File specifications

E00762400033

You can play music files of the following specifications that are saved in a USB memory device or other device supporting mass storage class. When you connect your iPod, playable file specifications depend on the connected iPod.

Item	Condition
File format	MP3, WMA, AAC
Maximum number of levels (including the root)	Level 8
Number of folders	700
Number of files	65,535

Sun visors

E00711201270

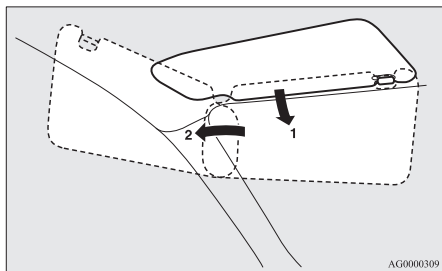

- 1- To eliminate front glare
- 2- To eliminate side glare

Card holder

Cards can be slipped into the holder (A) on the back of the sun visor on the driver side.

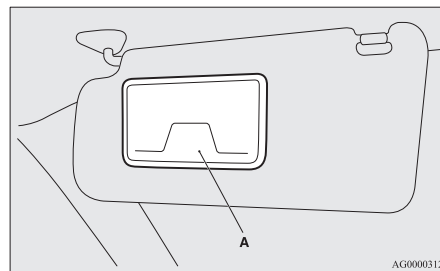

Vanity mirror

A vanity mirror is fitted to the back of the sun visor on the driver side.

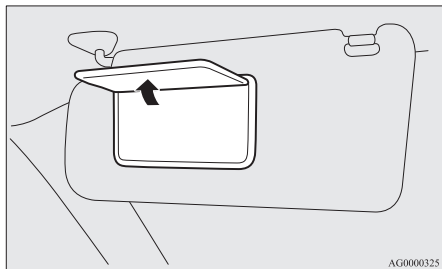

Accessory socket

E00711601519

The accessory socket can be used while the ignition switch or the operation mode is in ON or ACC. To use a plug-in type accessory, open the cap, and insert the plug in the accessory socket.

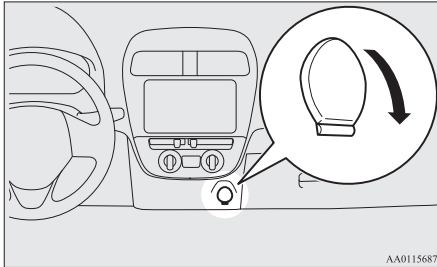

AA0115687

⚠ CAUTION

- Be sure to use a “plug-in” type accessory operating at 12 V and at 120 W or less.
- Long use of the electric appliance without running the engine may run down the battery.
- When the accessory socket is not in use, be sure to close the cap, because the socket might become clogged by foreign material and be short-circuited.

Interior lamps

E00712001318

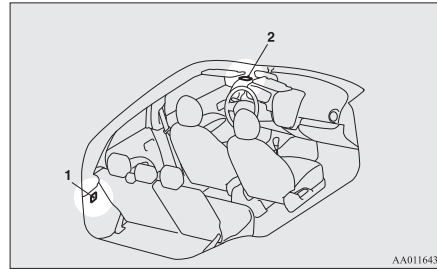

AA0116437

- 1- Luggage room lamp*
- 2- Room lamp

NOTE

- If you leave the lamp on without running the engine, you will run down the battery. Before you leave the vehicle, make sure that the lamp is off.

Room lamp

E00712600421

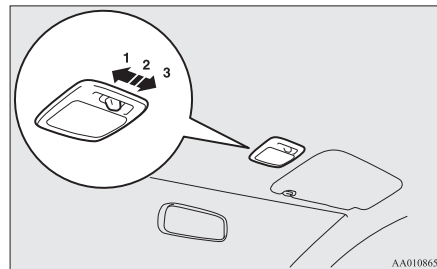

AA0108656

1- (☞)

The lamp illuminates regardless of whether a door or the tailgate is open or closed.

2- (●)

Delayed off function

[Vehicles without central door locks system]

The lamp illuminates when a door or the tailgate is opened. It goes off about 7 seconds after all doors and the tailgate are closed.

However, the lamp goes off immediately when the ignition switch is turned to the “ON” position with all doors and the tailgate closed.

[Vehicles with central door locks system]

The lamp illuminates when a door or the tailgate is opened. It goes off about 15 seconds after the door or tailgate is closed.

However, the lamp goes off immediately with all doors and the tailgate closed in the following cases:

- When the ignition switch is turned to the “ON” position or the operation mode is put in ON.
- When the central door lock function is used to lock the vehicle.
- When the keyless entry key or the keyless operation key is used to lock the vehicle.
- If the vehicle is equipped with the keyless operation system, when the keyless operation function is used to lock the vehicle.

Auto cut-out function

If the lamp is left switched on with the ignition switch is in the “LOCK” or “ACC” position or the operation mode is in OFF or ACC, and a door or the tailgate is opened, it goes off automatically after approximately 30 minutes.

The lamp will illuminate again after it automatically goes off in the following cases:

For pleasant driving

- When the ignition switch is turned to the “ON” position or the operation mode is put in ON.
- When the keyless entry system or the keyless operation system is operated.
- When all doors and the tailgate are closed.

NOTE

- When the key was used to start the engine, if the key is removed while the doors and tailgate are closed, the lamp is illuminated and after a few seconds it goes off.
- When the keyless operation function was used to start the engine, if the operation mode is put in OFF while the doors and tailgate are closed, the lamp illuminates and after about 15 seconds it goes off. (if so equipped)
- The time until the lamp goes off (delayed off) can be adjusted. For details, please consult a MITSUBISHI MOTORS Authorized Service Point
- The auto cut-out function cannot be operated when the room lamp switch is in the “” position. Also, this function can be deactivated. For details, please consult a MITSUBISHI MOTORS Authorized Service Point

3- (○)

The lamp goes off regardless of whether a door or the tailgate is open or closed.

Luggage room lamp*

E00712700725

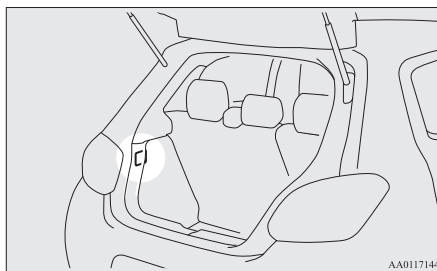

The lamp illuminates when the tailgate is opened, and goes out when the tailgate is closed.

Storage spaces

E00713101895

CAUTION

- Never leave lighters, cans of carbonated drink, and spectacles in the cabin when parking the vehicle in hot sunshine. The cabin will become extremely hot, so lighters and other flammable items may catch fire and unopened drink cans may rupture. Also, spectacles with plastic lenses or materials could deform or crack.
- Keep the lids of storage spaces closed while driving the vehicle. A lid or the contents of a storage space could otherwise cause injuries.

Glove box

E00717601595

To open, pull the lever (A).

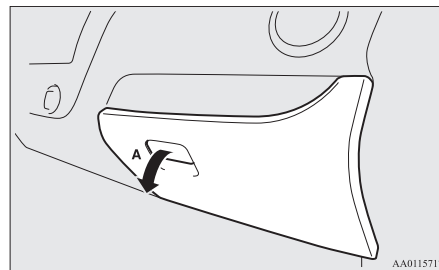

NOTE

- The USB input terminal (if so equipped) is located in the glove box. For details, refer to “USB input terminal” on page 5-31.

Cup holder

E00714501027

⚠ CAUTION

- Do not drink beverages while driving. This is distracting and could cause an accident.

For the front seat

The cup holder is located in front of the floor console.

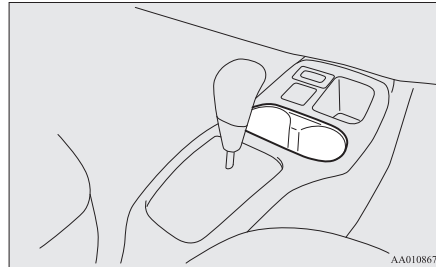

For the rear seat

E00718900152

The cup holder is located behind the parking brake lever.

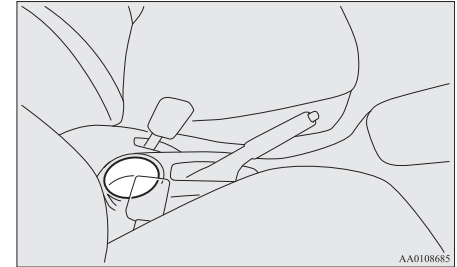

For pleasant driving

Bottle holder

E00718200357

CAUTION

- Do not drink beverages while driving. This is distracting and could cause an accident.
- Drinks could be spilled by the vibration and jolts while driving. If the spilt drink is very hot, you could be burnt.

There are bottle holders located on the front doors.

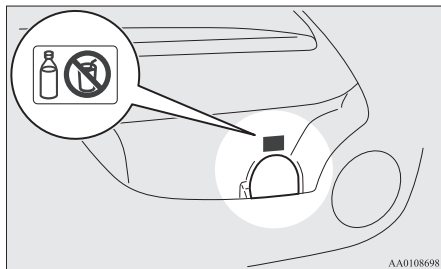

NOTE

- Do not store cup or drink can in the bottle holder.
- Tightly close the cap on drink bottles before storing them.
- Some bottles may be too big or the wrong shape to fit in the holder.

Rear shelf panel*

E00715400156

CAUTION

- Do not place luggage or other items on the rear shelf panel. Any items on the rear shelf panel would obstruct your rearward view, and they could fly forward and cause injuries or other mishap in the event of hard braking.

To install

1. Insert the concave portion (A) on the underside of the rear shelf panel into the inside protruding portion (B) of the rear pillar.

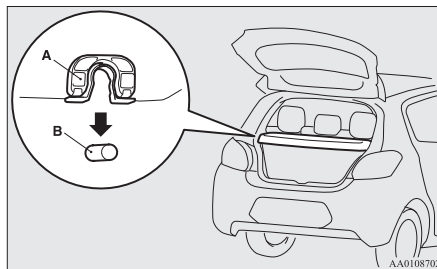

CAUTION

- Lightly push the rear shelf panel to make sure that the concave portion (A) is set firmly in the protruding portion (B) of the tailgate. If the rear shelf panel is not securely locked in place, it could unhook while driving and cause injuries.

2. Hang the strap (C) of the rear shelf panel on the hook (D).

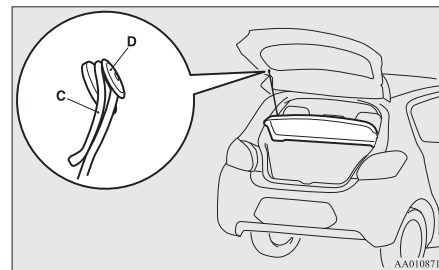

To remove

Follow this procedure in reverse to remove.

Convenient hook

E00732900169

Light items of luggage can be hung from the hook.

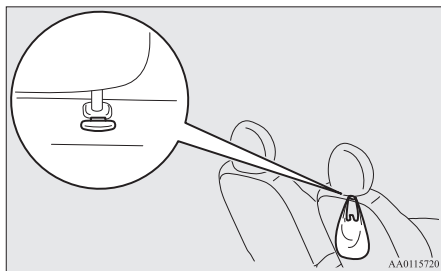

NOTE

- Do not hang heavy luggage (more than about 4 kg) on the hook. Doing so could cause damage to the hook.

Assist grip

E00732800302

The grip is to support the body by hand while seated in the vehicle.

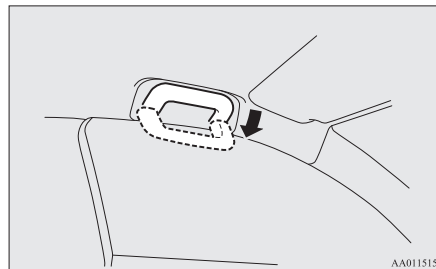

⚠ CAUTION

- Do not use the assist grip when getting in-to or out of the vehicle. The assist grip could detach causing you to fall.

A series of 15 horizontal dashed lines spanning the width of the page, providing a template for writing.

For emergencies

If the vehicle breaks down.....	6-02
Emergency starting.....	6-02
Engine overheating.....	6-04
Tool and jack.....	6-05
Tyre repair kit*.....	6-06
How to change a tyre (Vehicles equipped with spare tyre).....	6-11
Wheel covers*.....	6-16
Towing.....	6-17
Operation under adverse driving conditions.....	6-20

For emergencies

If the vehicle breaks down

E00800101137

If the vehicle breaks down on the road, move it to the shoulder and use the hazard warning flashers and/or the warning triangle etc.

Refer to “Hazard warning flasher switch” on page 3-18.

If the engine stops/fails

Vehicle operation and control are affected if the engine stops. Before moving the vehicle to a safe area, be aware of the following:

- The brake booster becomes inoperative and the pedal effort will increase. Press down the brake pedal harder than usual.
- Since the power steering system is no longer operative, the steering wheel feels heavy when turning it.

Emergency starting

E00800502910

If the engine cannot be started because the battery is weak or dead, the battery from another vehicle can be used with jumper cables to start the engine.

WARNING

- To start the engine using jumper cables connected to another vehicle, perform the correct procedures according to the instruction below. Incorrect procedures could result in a fire or explosion or damage to the vehicles.
- Keep sparks, cigarettes and flames away from the battery because the battery may produce an explosion.

CAUTION

- Do not attempt to start the engine by pulling or pushing the vehicle. It could damage your vehicle.
- Check the other vehicle. It must have a 12-volt battery.
If the other system isn't 12-volt, shorting can damage both vehicles.
- Use the proper cables suitable for the battery size to prevent overheating of the cables.
- Check the jumper cables for damage and corrosion before use.
- Always wear protective eye goggles when working near the battery.
- Keep the battery out of the reach of children.

1. Get the vehicles close enough so the jumper cables can reach, but be sure the vehicles aren't touching each other.
2. Turn off all lamps, heater and other electrical loads.
3. Set the parking brake firmly on each vehicle. Put an A/T or CVT in “P” (PARK) or a M/T in “N” (Neutral). Stop the engine.

WARNING

- Turn off the ignition on both vehicles beforehand. Make sure that the cables or your clothes cannot be caught by the fan or drive belt. Personal injury could result.

4. Make sure battery electrolyte is at the proper level.
Refer to “Battery” on page 8-08.

WARNING

- If electrolyte fluid is not visible, or appears to be frozen, Do Not Attempt Jump Starting!
A battery might rupture or explode if the temperature is below the freezing point or if it is not filled to the proper level.

⚠ WARNING

- Electrolyte is corrosive diluted sulphuric acid.

If electrolyte (battery acid) comes into contact with your hands, eyes, clothes and the painted surface of your vehicle, it should be thoroughly flushed with water. If electrolyte gets in your eyes, flush them with water immediately and thoroughly, and get prompt medical attention.

5. Connect one end of one jumper cable ① to the positive (+) terminal of the discharged battery (A), and the other end ② to the positive (+) terminal of the booster battery (B). Connect one end of the other jumper cable ③ to the negative (-) terminal of the booster battery, and the other end ④ to the designated ground location of the vehicle with the discharged battery at the point farthest from the battery.

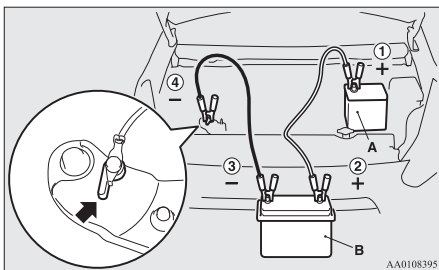
**⚠ WARNING**

- Make sure that the connection ④ is made to the appointed position (shown in the illustration). If the connection is made directly to the negative side of the battery, the inflammable gasses generated from the battery might catch fire and explode.
- When connecting the jumper cable, do not connect the positive (+) cable to the negative (-) terminal. Otherwise sparks might cause explosion of the battery.

⚠ CAUTION

- Take care not to get the jumper cable caught in the cooling fan or other rotating part in the engine compartment.

6. Start the engine in the vehicle which has the booster battery, let the engine idle a few minutes, then start the engine in the vehicle with the discharged battery.

⚠ CAUTION

- Keep the engine of the vehicle giving assistance running.

NOTE

- For vehicles equipped with the Auto Stop & Go (AS&G) system, press the “Auto Stop & Go (AS&G) OFF” switch to deactivate the Auto Stop & Go (AS&G) system and prevent the engine from automatically stopping before the battery is sufficiently charged. Refer to “To deactivate” on page 4-18.

7. After the engine is started, disconnect the cables in the reverse order and keep the engine running for several minutes.

NOTE

- If the vehicle is put in motion without fully charging the battery, it might cause the loss of smooth engine operation and the anti-lock brake warning lamp to illuminate. Refer to “Anti-lock brake system (ABS)” on page 4-28.

For emergencies

Engine overheating

E0800602722

If the high coolant temperature warning lamp illuminates during the engine is running, the engine may be overheating.

If this occurs, take the following corrective measures:

1. Stop the vehicle in a safe place.
2. Check whether steam is coming from the engine compartment.

[If steam does not come from the engine compartment]

With the engine still running, raise the bonnet to ventilate the engine compartment.

NOTE

- For vehicles equipped with the Auto Stop & Go (AS&G) system, press the “Auto Stop & Go (AS&G) OFF” switch to deactivate the Auto Stop & Go (AS&G) system before stopping the vehicle.
Refer to “To deactivate” on page 4-18.

[If steam is coming from the engine compartment]

Stop the engine, and when the steam stops, raise the bonnet to ventilate the engine compartment. Restart the engine.

⚠ WARNING

- Do not open the bonnet while steam is coming from the engine compartment. It could cause steam or hot water to spurt out, causing burns. Hot water could spurt out even when there is no steam coming out, and some parts will be very hot. Be very careful when opening the bonnet.
- Be careful of hot steam, which could be blowing off the reserve tank cap.
- Do not attempt to remove the radiator cap while the engine is hot.

3. Confirm that the cooling fan (A) is turning.
[If the cooling fan is turning]
After the high coolant temperature warning lamp has gone off, stop the engine.
[If the cooling fan is not turning]
Stop the engine immediately and contact a MITSUBISHI MOTORS Authorized Service Point for assistance.

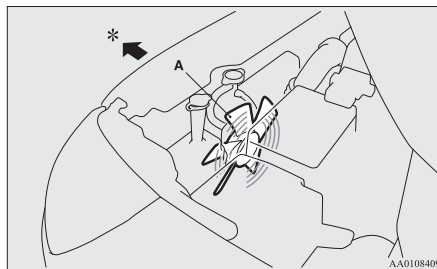

*: Front of the vehicle

⚠ WARNING

- Be careful not to get your hands or clothes caught in the cooling fan.

4. Check the coolant level in the reserve tank (B).

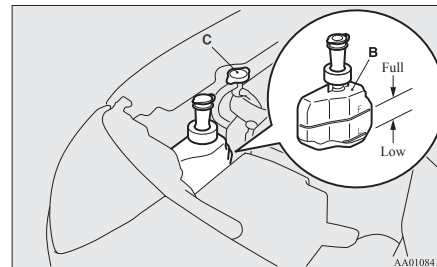

5. Add coolant to the radiator and/or reserve tank if necessary. (Refer to the “Maintenance” section.)

⚠ WARNING

- Make sure that the engine has cooled down before removing the radiator cap (C), because hot steam or boiling water otherwise will gush from the filler port and may scald you.

⚠ CAUTION

- Do not add coolant while the engine is hot. Suddenly adding cold coolant could damage the engine. Wait for the engine to cool down, then add coolant a little at a time.
6. Examine the radiator hoses for coolant leakage and the drive belt for looseness or damage. If there is anything wrong with the cooling system or drive belt, we recommend you to have it checked and repaired.

Tool and jack

E00800901496

Storage

The tools are stored beneath the luggage floor board of the luggage compartment. The jack (if so equipped) is stored under the front left side seat. The storage location of the tools and jack should be remembered in case of an emergency.

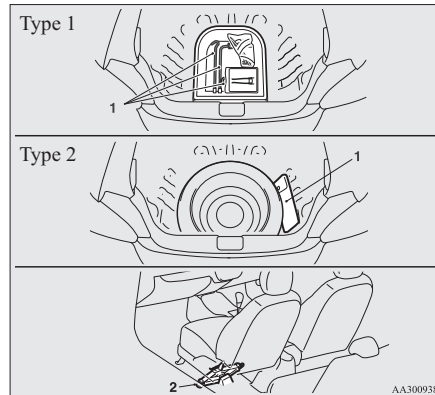

- 1- Tools
2- Jack*

Tools

E00801900627

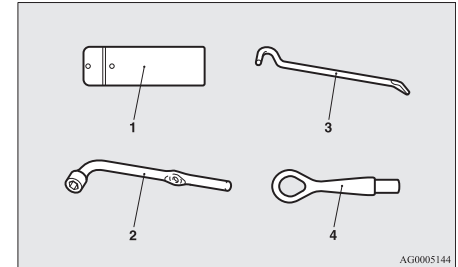

- 1- Tool case*
2- Wheel nut wrench
3- Jack bar
4- Towing hook

Jack*

E00802000595

Before removing or storing the jack, move the front left side seat fully forward to access the jack from the rear seat area. (Refer to "Front seat" on page 2-02.)

⚠ CAUTION

- Never access, remove or store the jack from the front of the seat. Doing so could damage electrical wires under the seat.

To remove

Turn the shaft end of the jack in the direction (1) until the jack fully retracts and remove the jack from the holder (A).

For emergencies

To store

Put the jack in the holder (A) and turn the shaft end of the jack in the direction (2) by hand until the jack is firmly secured.

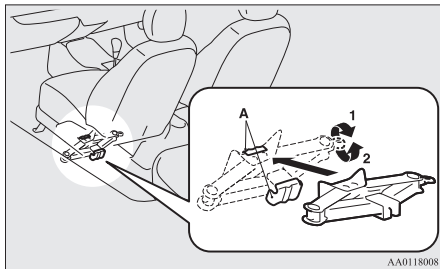

⚠ WARNING

- After storing the jack in place, make sure the jack is securely fixed in the holder. If the jack is not fixed securely, it may move and hit an occupant in an accident resulting in serious injury or death.

Tyre repair kit*

E00804500028

This kit enables emergency repair of a small puncture in the tread area of a tyre that has run over a nail, screw, or similar object.

Storage

The tyre repair kit is stored beneath the luggage floor board of the luggage compartment. The storage location of the tyre repair kit should be remembered in case of an emergency.

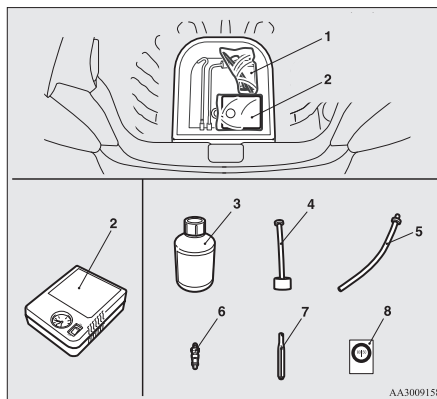

- 1- Tyre repair set
- 2- Tyre compressor
- 3- Tyre sealant bottle
- 4- Filler hose
- 5- Extension hose

(This hose is used for removal of sealant. It is not used in emergency puncture repair.)

- 6- Valve insert (spare)
- 7- Valve remover

- 8- Speed restriction sticker

How to use the tyre repair kit

E00804600016

⚠ CAUTION

- The tyre sealant can cause health damage if swallowed. If you accidentally swallow it, drink as much water as possible and immediately consult a doctor.
- If the tyre sealant gets in your eyes or on your skin, rinse with lots of water. If you still sense an abnormality, consult a doctor.
- Consult a doctor immediately if any allergic reactions occur.
- Do not allow children to touch the tyre sealant.
- Do not breathe in the vapours of tyre sealant.
- Be sure to use a MITSUBISHI MOTORS GENUINE tyre sealant.

NOTE

- The tyre sealant cannot be used in any of the situations listed below. If any of these situations occurs, please contact a MITSUBISHI MOTORS Authorized Service Point or another specialist.
 - The tyre sealant's expiry date has passed. (The expiry date is shown on the bottle label.)



AA0064525

- More than one tyre is punctured.
- The puncture hole has a length or width of 4 mm or more.
- The tyre is punctured in the side wall (A), not in the tread (B).

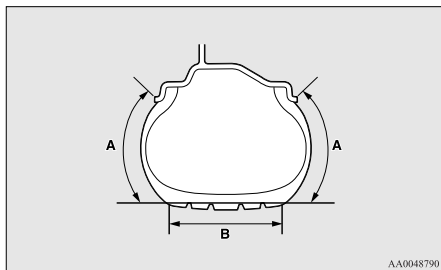

AA0048790

- The vehicle has been driven with the tyre almost completely flat.
- The tyre has completely slipped over the wheel rim and has come off the wheel.
- The wheel is damaged.

- Use the tyre sealant only at ambient temperatures of -30 °C to + 60 °C.
- Effect an emergency repair without pulling out the object (nail, screw, etc.) that is stuck in the tyre.
- Do not use the tyre sealant if the tyre has been damaged by being driven when insufficiently inflated (e.g. bumps, cuts, cracks etc. on the tyre).
- Wipe tyre sealant off the paintwork immediately with a damp cloth.
- Immediately wash clothes contaminated with tyre sealant.

Before repairing a tyre, first stop your vehicle in a safe, flat location.

1. Park the vehicle on level and stable ground.
2. Set the parking brake firmly.
3. On vehicles with M/T, stop the engine and move the gearshift lever to the “R” (Reverse) position.
On vehicles with CVT, move the selector lever to the “P” (PARK) position and stop the engine.
4. Turn on the hazard warning flashers and set up a warning triangle, flashing signal lamp, etc., at an adequate distance from the vehicle, and have all your passengers leave the vehicle.
5. Take out the tyre repair kit.
6. Shake the tyre sealant bottle well.

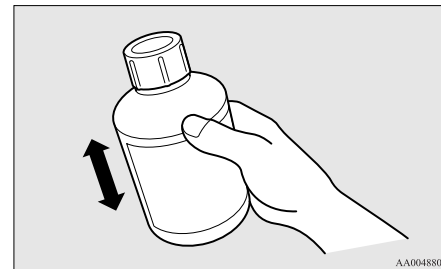

AA0048804

NOTE

- In cold conditions (when the ambient temperature is 0 °C or lower), thickening of the tyre sealant can make the tyre sealant hard to squeeze out of the bottle. Warm the bottle inside the vehicle.

7. Take the cap (C) off the tyre sealant bottle (D). Do not remove the seal (E). Screw the filler hose (F) onto the bottle (E). As you screw the filler hose onto the bottle, the seal will break, allowing the sealant to be used.

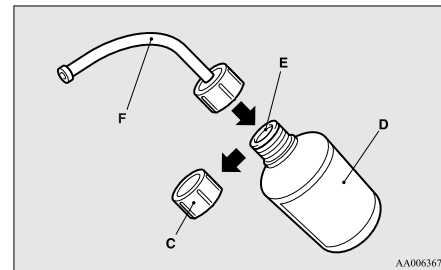

AA0063674

For emergencies

⚠ CAUTION

- If you shake the bottle after screwing on the hose, sealant may spray out of the hose.

8. Take the valve cap (G) off the tyre valve (H), then press the valve remover (I) onto the valve as illustrated. Allow all of the air in the tyre to escape.

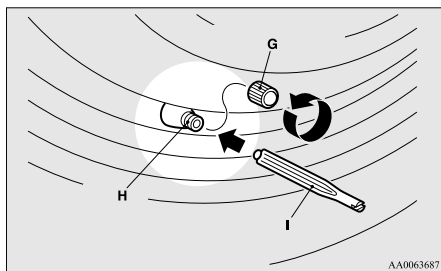

9. Remove the valve insert (J) by turning it anti-clockwise using the valve remover (I). Put the removed valve insert in a clean place so it does not get dirty.

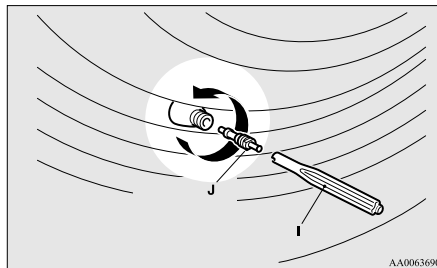

⚠ CAUTION

- If there is any air left in the tyre when you remove the valve insert, the valve insert may fly out and injure you. Make sure the tyre contains no air before removing the valve insert.

10. Remove the plug (K) from the free end of the hose (L). Press the hose onto the valve (H).

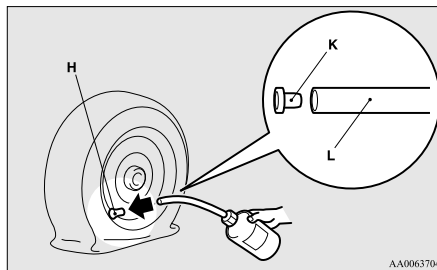

11. Holding the sealant bottle upside-down, squeeze it again and again to inject all of the sealant into the tyre.

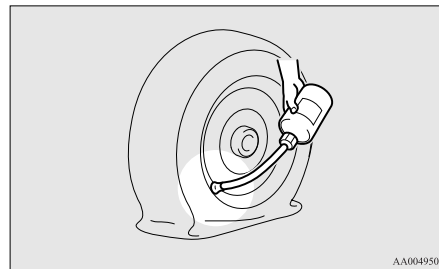

NOTE

- When injecting the sealant, position the valve away from the bottom, i.e., away from the point where the tyre touches the ground. If the valve is near the point where the tyre touches the ground, the sealant may not go into the tyre easily.

12. After injecting the sealant, pull the hose off the valve, remove any residual sealant from the valve, rim and/or tyre.

Fit the valve insert (J) into the valve (H), and screw the valve insert securely into place using the valve remover (I).

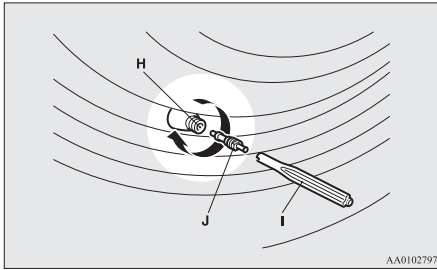

NOTE

- When removing and screwing in the valve insert using the valve remover, turn the valve remover by hand. Using a tool to turn the valve remover could damage it.

13. Pull out the compressor hose (M) from the side of the tyre compressor, and then securely attach the hose to the tyre valve (H).

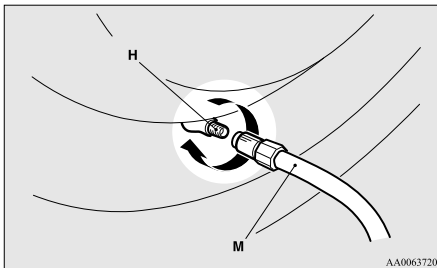

14. Place the compressor (N) with its air pressure gauge (O) on top.

Pull out the compressor's power cord (P), insert the plug on the cord into the accessory socket (Q), and then turn the ignition switch to the "ACC" position or put the operation mode in ACC. (Refer to "Accessory socket" on page 5-35.)

Turn ON the compressor switch (R) and inflate the tyre to the specified pressure. (Refer to "Tyre inflation pressures" on page 8-10.)

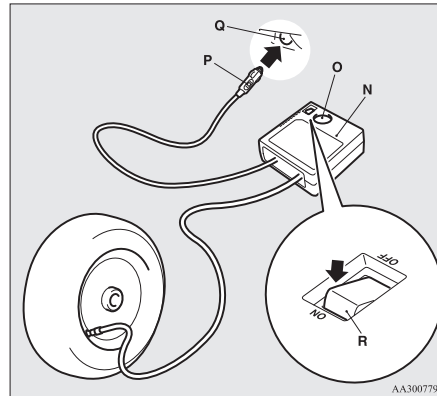

CAUTION

- The supplied compressor is designed only for inflation of your vehicle tyres.
- The compressor is designed to run on a vehicle's 12 V power supply. Do not connect it to any other power source.

CAUTION

- The compressor is not waterproof. If you use it in rain, make sure water does not get on it.
- Any sand or dust sucked into the compressor could make the compressor break down. Do not place the compressor directly on any sandy or dusty surface when using it.
- Do not disassemble or modify the compressor. Also, do not subject the air pressure gauge to shock. It could malfunction.

15. Check and adjust the tyre pressure with reference to the air pressure gauge on the compressor. If you overinflate the tyre, release air by loosening the hose's end fitting.

If there is a gap between the tyre and wheel because the tyre has moved inward from the wheel rim, press the periphery of the tyre towards the wheel to close the gap before running the compressor. (With no gaps, the tyre pressure will rise.)

CAUTION

- Be careful not to get your fingers trapped between the tyre and wheel as the tyre inflates.
- The surface of the compressor will get hot while the compressor is running. Do not keep the compressor running continuously for more than 10 minutes. After using the compressor, wait for the compressor to cool before using it again.

For emergencies

⚠ CAUTION

- If the compressor becomes sluggish or hot while operating, it is overheating. Immediately place the switch in the OFF position and let the compressor cool down for at least 30 minutes.

NOTE

- If the tyre pressure does not rise to the specified level within 10 minutes, the tyre may be so severely damaged that the tyre sealant cannot be used to effect an emergency repair. Please contact a MITSUBISHI MOTORS Authorized Service Point or another specialist in this event.

16. Turn OFF the compressor switch, then pull the power cord plug out of the socket.

NOTE

- Simply putting sealant and air into the tyre using the tyre repair kit does not seal the puncture hole. Air will leak through the puncture hole until the emergency repair procedure is completed (through step 19 or step 20 of these instructions).

17. Affix the speed restriction sticker (R) to the three-diamond mark on the steering wheel.

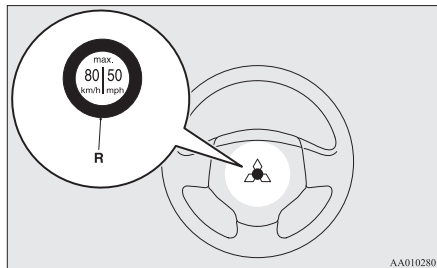

⚠ CAUTION

- Do not affix the sticker anywhere except the specified position on the pad of the steering wheel. Affixing the sticker in an incorrect position could prevent the SRS airbag from working normally.

18. When you have inflated the tyre to the specified pressure, stow the compressor, bottle, and other items in the vehicle and promptly start driving the vehicle so that the tyre sealant can spread evenly in the tyre. Drive with great care. Do not exceed a speed of 80 km/h (50 mph). Observe local speed limits.

⚠ CAUTION

- If you sense any abnormality while driving, stop the vehicle and contact a MITSUBISHI MOTORS Authorized Service Point or another specialist. Otherwise the tyre pressure may drop before the emergency repair procedure is completed, rendering the vehicle unsafe.

NOTE

- Driving faster than 80 km/h (50 mph) can make the vehicle vibrate.

19. After driving for 10 minutes or 5 km, check the tyre pressure using the air pressure gauge on the compressor. If the tyre pressure has apparently not dropped, the emergency repair procedure is complete. Continue the process from step 21.

If the tyre pressure is not sufficient, inflate the tyre to the specified pressure again and drive the vehicle carefully without exceeding a speed of 80 km/h (50 mph).

⚠ CAUTION

- If the tyre pressure is lower than the minimum permitted pressure (1.3 bar {130 kPa}), the tyre cannot successfully be repaired with the tyre sealant. Do not drive the vehicle any further. Contact a MITSUBISHI MOTORS Authorized Service Point or another specialist.

20. After driving for 10 minutes or 5 km, check the tyre pressure using the air pressure gauge

on the compressor. If the tyre pressure has apparently not dropped, the emergency repair procedure is complete. You must still not exceed a speed of 80 km/h (50 mph). Observe local speed limits.

NOTE

- If the tyre pressure has dropped below the specified level when you check it at the end of the repair procedure, do not drive the vehicle any further. Contact a MITSUBISHI MOTORS Authorized Service Point or another specialist.
 - In cold conditions (when the ambient temperature is 0 °C or lower), the time and driving distance necessary until completion of the repair can be longer than in warmer conditions, meaning that the tyre pressure can drop below the specified level even when you have inflated the tyre a second time and subsequently driven the vehicle. If this happens, inflate the tyre to the specified pressure once more, drive for about 10 minutes or 5 km, then check the tyre pressure again. If the tyre pressure has again dropped below the specified level, stop driving the vehicle and contact a MITSUBISHI MOTORS Authorized Service Point or another specialist.
21. Immediately drive with great care to a MITSUBISHI MOTORS Authorized Service Point or another specialist and have tyre repair/replacement performed.

CAUTION

- Be sure to check the tyre pressure for confirmation that the emergency repair procedure is complete.

NOTE

- Please give the empty sealant bottle to your MITSUBISHI MOTORS Authorized Service Point when you purchase new sealant or dispose of the sealant bottle according to national regulations for the disposal of chemical waste.
- A tyre in which puncture sealant has been used should ideally be replaced with a new one. If you wish to have such a tyre properly repaired for reuse, please contact a MITSUBISHI MOTORS Authorized Service Point or another specialist. Note that a proper repair is impossible following an emergency repair if the puncture hole cannot be located.
- The manufacturer is unable to guarantee that all tyre punctures can be repaired with the tyre repair kit, in particular cuts or perforations with a diameter of more than 4 mm or away from the tyre's tread. The manufacturer is not liable for damage sustained through improper use of the tyre repair kit.
- The manufacturer is not liable for damage sustained through re-use of any tyre in which tyre sealant has been used.

How to change a tyre (Vehicles equipped with spare tyre)

E00801202969

Before changing a tyre, first stop your vehicle in a safe, flat location.

1. Park the vehicle on level and stable ground, free of loose pebbles, etc.
2. Set the parking brake firmly.
3. On vehicles with M/T, stop the engine and move the gearshift lever to the "R" (Reverse) position.
On vehicles with CVT, move the selector lever to the "P" (PARK) position and stop the engine.
4. Turn on the hazard warning flashers and set up a warning triangle, flashing signal lamp, etc., at an adequate distance from the vehicle, and have all your passengers leave the vehicle.
5. To prevent the vehicle from rolling when jacking up the vehicle, place chocks or blocks (A) at the tyre that is diagonally opposite from the tyre (B) you are changing.

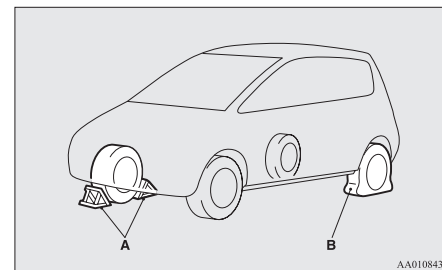

For emergencies

⚠️ WARNING

- Be sure to apply chocks or blocks to the correct tyre when jacking up the vehicle. If the vehicle moves while jacked up, the jack could slip out of position, leading to an accident.

NOTE

- The chocks shown in the illustration do not come with your vehicle. It is recommended that you keep some in the vehicle for use if needed.
 - If chocks are not available, use stones or any other objects that are large enough to hold the wheel in position.
6. Get the jack bar and wheel nut wrench ready. Refer to “Tool and jack” on page 6-05.

Spare wheel information

E00803600729

The spare wheel is stored beneath the luggage floor board of the luggage compartment.

Check the air pressure of the spare tyre frequently and make sure it is ready for emergency use at any time.

Maintaining the spare wheel at the highest specified air pressure will ensure that it can always be used under any conditions (city/high-speed driving, varying load weight, etc.).

⚠️ CAUTION

- The tyre pressure should be periodically checked and maintained at the specified pressure while the tyre is stowed. Driving with an insufficient tyre pressure can lead to an accident. If you have no choice but to drive with an insufficient tyre pressure, keep your speed down and inflate the tyre to the correct pressure as soon as possible. (Refer to “Tyre inflation pressures” on page 8-10.)

Compact spare wheel

The compact spare wheel is designed to save space in the luggage compartment and its lighter weight makes it easier to use if a flat tyre occurs.

⚠️ CAUTION

- The compact spare wheel is for temporary use only and should be removed as soon as the original wheel can be repaired or replaced.
- The vehicle must not be driven at speeds in excess of 80 km/h (50 mph) while using the compact spare wheel.
- The compact spare tyre is not as good as a standard tyre in controllability and stability. When the compact spare tyre is used, avoid quick starts, sudden braking and sharp steering.
- The compact spare wheel is specifically designed for your vehicle and it should not be used on any other vehicle.

⚠️ CAUTION

- Do not use snow traction device (tyre chains) with your compact spare wheel. Because of the smaller tyre size, a snow traction device (tyre chains) will not fit properly. This could cause damage to the wheel and result in loss of the chain. If a front tyre becomes flat when using snow traction device (tyre chains), first replace a rear wheel with the compact spare wheel and then use the removed rear wheel to replace the flat front wheel so that you can continue to use the snow traction device (tyre chains).

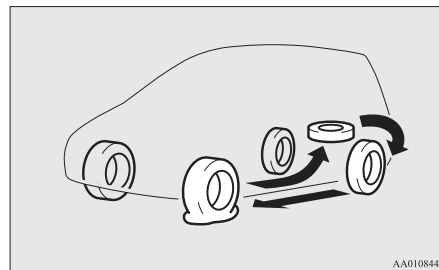

⚠️ CAUTION

- Upon installation of the compact spare wheel, the ground clearance is reduced as the tyre is smaller in diameter than the standard tyre. When passing over the projections on the road, take care not to damage the vehicle's undercarriage.

⚠ CAUTION

- Do not install more than one compact spare wheel at the same time.

To remove the spare tyre

E00803500467

1. Lift up the luggage floor board.
2. To remove the spare tyre, remove the installation clamp (A) by turning it anticlockwise.

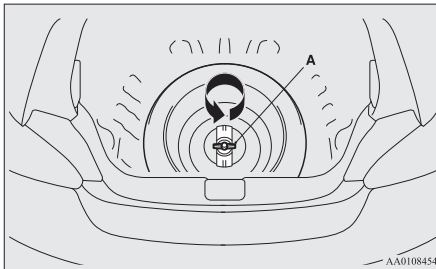

NOTE

- Put the spare wheel under the vehicle body near the jack. This makes it safer if the jack slips out of position.

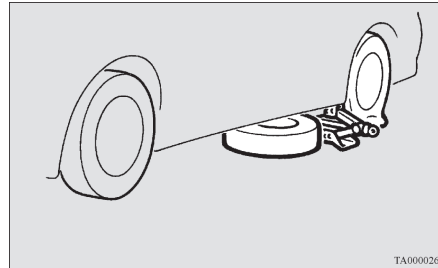

TA0000267

To change a tyre

E00803200914

1. On vehicles equipped with wheel covers, first remove the covers (refer to “Wheel covers” on page 6-16). Then loosen the wheel nuts a quarter turn with the wheel nut wrench. Do not remove the wheel nuts yet.

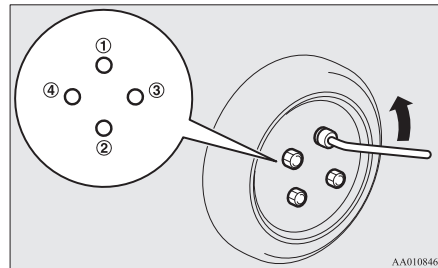

AA0108467

2. Place the jack under one of the jacking points (A) shown in the illustration. Use the jacking point closest to the tyre you wish to change.

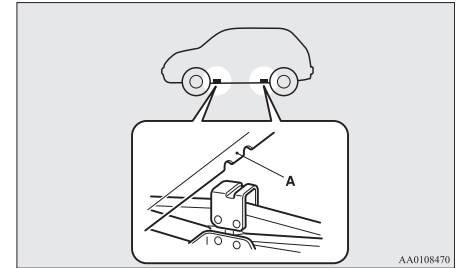

AA0108470

⚠ WARNING

- Set the jack only at the positions shown here. If the jack is set at a wrong position, it could dent your vehicle or the jack might fall over and cause personal injury.
- Do not use the jack on a tilted or soft surface. Otherwise, the jack might slip and cause personal injury. Always use the jack on a flat, hard surface. Before setting the jack, make sure there are no sand or pebbles under the jack base.

NOTE

- If you raise the vehicle with a garage jack, refer to “If your vehicle is raised with a garage jack” on page 8-03.

For emergencies

3. Rotate the jack by hand until the flange portion (B) fits in the groove (C) at the top of the jack.

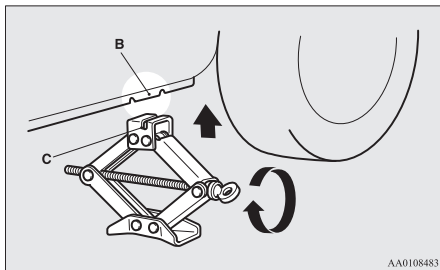

4. Insert the bar (D) into the wheel nut wrench (E). Then put the end of the bar into the shaft's jack end, as shown in the illustration. Slowly rotate the wheel nut wrench until the tyre is raised slightly off the ground surface.

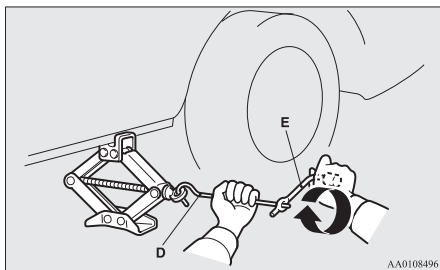

⚠ WARNING

- Stop jacking up the vehicle as soon as the tyre is raised off the ground. It is dangerous to raise the vehicle any higher.
- Do not get under your vehicle while using the jack.
- Do not bump the raised vehicle or leave it sitting on the jack for a long time. Both are very dangerous.
- Do not use a jack except the one that came with your vehicle.
- The jack should not be used for any purpose other than to change a tyre.
- No one should be in your vehicle when using the jack.
- Do not start or run the engine while your vehicle is on the jack.
- Do not turn the raised wheel. The tyres still on the ground could turn and make your vehicle fall off the jack.

5. Remove the wheel nuts with the wheel nut wrench, then take the wheel off.

⚠ CAUTION

- Handle the wheel carefully when changing the tyre, to avoid scratching the wheel surface.
6. Clean out any mud, etc. on the hub surface (F), hub bolts (G) or in the installation holes (H) in the wheel, and then mount the spare tyre.

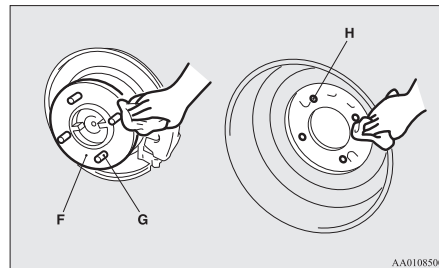

⚠ WARNING

- Mount the spare wheel with the valve stem (I) facing outboard. If you cannot see the valve stem (I), you have installed the wheel backwards. Operating the vehicle with the spare wheel installed backwards can cause vehicle damage and result in an accident.

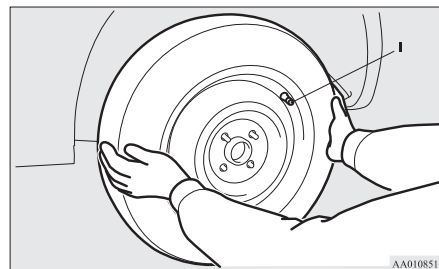

7. Temporarily tighten the wheel nuts by hand until the tapered parts of the wheel nuts

make light contact with the seats of the wheel holes and the wheel is not loose.

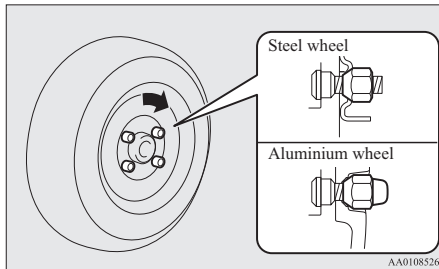

CAUTION

- Never apply oil to either the wheel bolts or the nuts, or they will tighten too much.

8. Lower the vehicle slowly by rotating the wheel nut wrench anticlockwise until the tyre touches the ground.

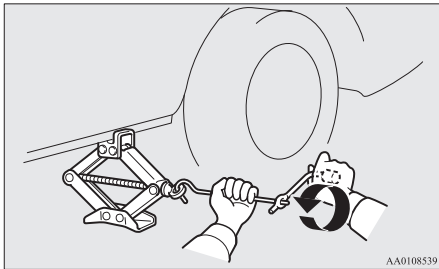

9. Tighten the nuts in the order shown in the illustration until each nut has been tightened to the torque listed here.

Tightening torque
88 to 108 Nm

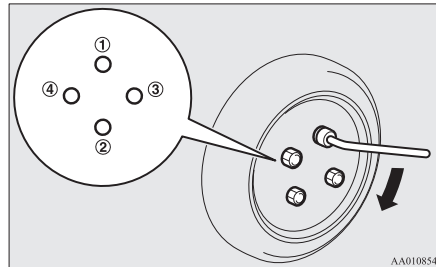

CAUTION

- Never use your foot or a pipe extension for extra force in the wheel nut wrench. If you do so, you will tighten the nut too much.

10. Lower the jack all the way and remove it.
11. Check your tyre inflation pressure at the next gasstation. The correct pressures are shown on the door label. See the illustration.

For emergencies

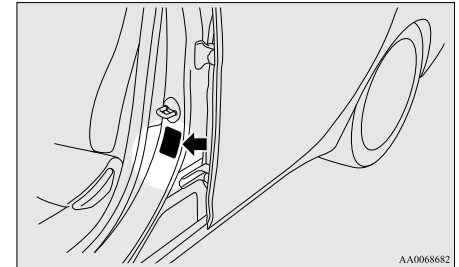

CAUTION

- After changing the tyre and driving the vehicle about 1,000 km (620 miles), retighten the wheel nuts to make sure that they have not come loose.
- If the steering wheel vibrates when driving after changing the tyre, we recommend you to have the tyres checked for balance.
- Do not mix one type of tyre with another or use a different size from the one listed. This would cause early wear and poor handling.

To store the flat tyre or spare wheel

E00803700485

1. To store the flat tyre or spare wheel, fit the installation clamp (A) by turning it clockwise.

For emergencies

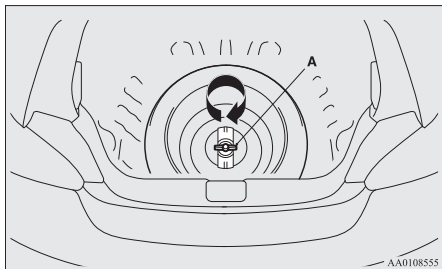

NOTE

- The flat tyre (normal wheel) cannot be stored beneath the luggage floor board. Store the flat tyre in the luggage compartment.
2. Have your damaged tyre repaired as soon as possible.

To store the tools and jack

E0080380053

Reverse the removing procedure when storing the jack, bar and wheel nut wrench. Refer to "Tool and jack" on page 6-05.

Wheel covers*

E00804700017

To remove

1. Wrap the tip of the jack bar with a cloth, insert it into the notch provided in the wheel cover, and use it to lever up the cover a little.

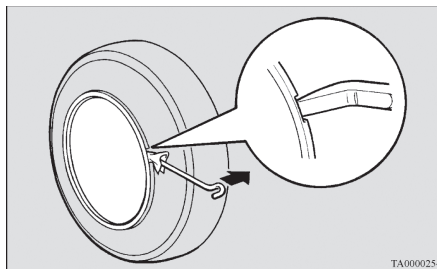

2. With the cover raised a little, pry it off completely using the jack bar. Insert the jack bar under the cover, and move it around the circumference, prying the cover away from the wheel little by little as you move the bar around.

⚠ CAUTION

- If you try to use your hands, they may get hurt by the edge of the wheel cover.

NOTE

- The wheel cover is made of plastic; take care when prying it off.

To install

1. Make sure the tabs (A) of the back of the wheel cover are not broken and correctly fitted on the rings (B). If in doubt, do not install the wheel cover and consult a MITSUBISHI MOTORS Authorized Service Point.

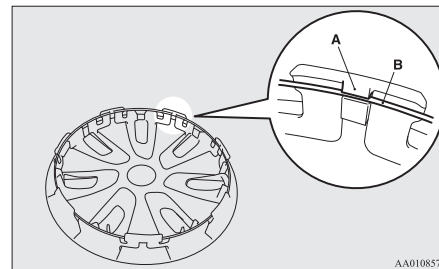

2. Align the air valve (C) of the tyre with the notch (D) in the wheel cover.

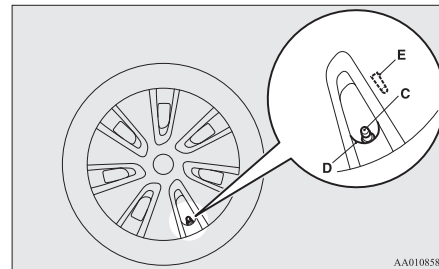

NOTE

- Full wheel covers have a symbol mark (E) provided on the reverse side to show the air valve location.

Before installing the wheel cover to the wheel, make sure that the opening with the symbol mark is correctly aligned with the air valve.

3. Push the bottom part (F) of the wheel cover into the wheel.
4. Gently push both sides (G) of the wheel cover and hold them in place with both knees.
5. Gently tap around the circumference of the wheel cover at the top (H), then push the wheel cover into place.

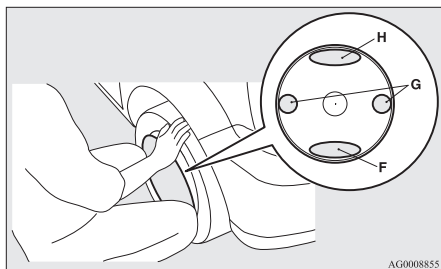

Towing

E00801503930

If your vehicle needs to be towed

If towing is necessary, we recommend you have it done by your MITSUBISHI MOTORS Authorized Service Point or a commercial tow truck service.

In the following cases, transport the vehicle using a tow truck.

- The engine runs but the vehicle does not move or abnormal noise is produced.
- Inspection of the vehicle's underside reveals that oil or some other fluid is leaking.

If a wheel gets stuck in a ditch, do not try to tow the vehicle. Please contact your MITSUBISHI MOTORS Authorized Service Point or a commercial tow truck service for assistance.

Only when you cannot receive a towing service from a MITSUBISHI MOTORS Authorized Service Point or commercial tow truck service, tow your vehicle carefully in accordance with the instructions given in "Emergency towing" in this part.

The regulations concerning towing may differ from country to country. It is recommended that you obey the regulations of the area where you are driving your vehicle.

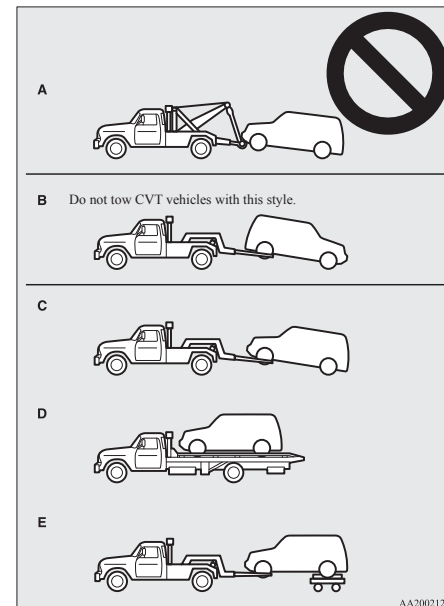

Towing the vehicle by a tow truck

⚠ CAUTION

- This vehicle must not be towed by a tow truck using sling lift type equipment (Type A) as illustrated. Using a sling lift will damage the bumper and front end.
- Do not tow CVT vehicles with the driving wheels on the ground (Type B) as illustrated. If the vehicle is towed like this, the automatic transmission (CVT) fluid may not reach all parts of the transmission, thus damaging it.
If you tow CVT vehicles, use Type C, D or E equipment.
- If the transmission is malfunctioning or damaged, transport the vehicle with the driving wheels on a carriage (Type C, D or E) as illustrated.

⚠ CAUTION

- If the vehicle is towed with the ignition switch in the “ON” position or the operation mode in ON and only the front wheels or only the rear wheels raised off the ground (Type B or C), the Active Stability Control (ASC) may operate, resulting in an accident. When towing the vehicle with the rear wheels raised, turn the ignition switch to the “ACC” position or put the operation mode in ACC. When towing the vehicle with the front wheels raised, keep the ignition switch or the operation mode as follows.
[Except vehicles equipped with keyless operation system]
The ignition switch is in the “LOCK” or “ACC” position.
[Vehicles equipped with keyless operation system]
The operation mode is in OFF or ACC.

Towing with rear wheels off the ground (Type B - M/T vehicles only)

Place the gearshift lever in the “Neutral” position. Turn the ignition switch to the “ACC” position or put the operation mode in ACC and secure the steering wheel in a straightahead position with a rope or tie-down strap. Never place the ignition switch in the “LOCK” position or put the operation mode in OFF when towing.

Towing with front wheels off the ground (Type C)

Release the parking brake. Place the gearshift lever in the “Neutral” position (M/T) or the selector lever in the “N” (NEUTRAL) position (CVT).

Emergency towing

If towing service is not available in an emergency, your vehicle may be temporarily towed by a rope secured to the towing hook.

In case of your vehicle is to be towed by another vehicle, pay careful attention to the following points.

If your vehicle is to be towed forward by another vehicle

1. Take out the towing hook, wheel nut wrench and jack bar.
(Refer to “Tools” on page 6-05.)
2. Cover the tip of the jack bar with a cloth, then use it to remove the cover (A) that is located on the front bumper.

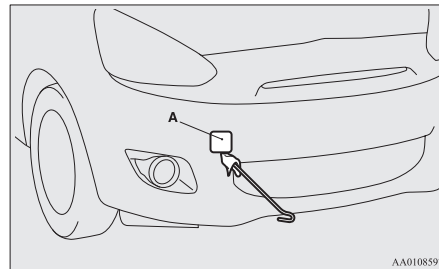

AA0108597

- Use the wheel nut wrench (B) to securely mount the towing hook (C).

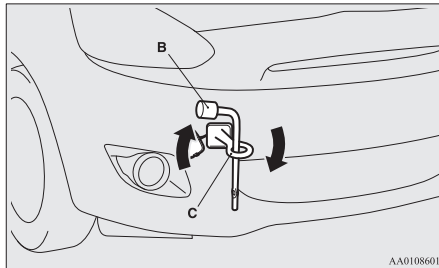

- Secure the tow rope to the front towing hook.

CAUTION

- Do not tow the vehicle with the rope at an excessive diagonal angle.

NOTE

- To avoid deforming or otherwise damaging the vehicle body when hooking the rope onto the towing hook, observe the following instructions:
 - Mount the towing hook securely.
 - Do not attach the rope to any part of the vehicle other than the towing hook.
 - Ensure that the tow rope is taut when the towing vehicle moves away.

- Keep the engine running.
If the engine is not running, perform the following operation to unlock the steering wheel.

[Except for vehicles equipped with keyless operation system]

On vehicles with M/T, turn the ignition key to the “ACC” or “ON” position.

On vehicles with CVT, turn the ignition key to the “ON” position.

[For vehicles with the keyless operation system]

On vehicles with M/T, put the operation mode in ACC or ON.

On vehicles with CVT, put the operation mode in ON.

NOTE

- For vehicles equipped with the Auto Stop & Go (AS&G) system, press the “Auto Stop & Go (AS&G) OFF” switch to deactivate the Auto Stop & Go (AS&G) system before stopping the vehicle.
Refer to “To deactivate” on page 4-18.

WARNING

- When the engine is not running, the brake booster and power steering system do not operate. This means higher brake depression force and higher steering effort are required. Therefore, vehicle operation is more difficult than usual.

CAUTION

- Do not leave the key in the “LOCK” position or the operation mode in OFF. The steering wheel will lock, causing loss of control.

- Place the gearshift lever in the “Neutral” position (M/T) or the selector lever in the “N” (NEUTRAL) position (CVT).
- Turn on the hazard warning lamps if required by law. (Follow the local driving laws and regulations.)
- During towing make sure that close contact is maintained between the drivers of both vehicles, and that the vehicles travel at low speed.

WARNING

- Avoid sudden braking, sudden acceleration and sharp turning; such operation could cause damage to the towing hooks or the tow rope.
People in the vicinity could be injured as a result.
- When towing or being towed down a long slope, the brakes may overheat reducing the effectiveness. In this situation, have your vehicle transported by a tow truck.

CAUTION

- The person in the vehicle being towed must pay attention to the brake lamps of the towing vehicle and make sure the rope never becomes slack.

For emergencies

⚠ CAUTION

- When the vehicle with CVT is to be towed by another vehicle with the all wheels on the ground, make sure that the towing speed and distance given below are never exceeded, causing damage to the transmission.

Towing speed: 40 km/h (25 mph)
Towing distance: 40 km (25 miles)

For the towing speed and the towing distance, follow the local driving laws and regulations.

9. When finished towing, remove the towing hook, and stow it in the specified location. Refer to “Tools” on page 6-05. When installing the cover, align the hook with the cut out area on the vehicle, and firmly insert.

If your vehicle is to be towed rearward by another vehicle

If your vehicle is stuck in sand, mud, snow, etc., use the rear towing hook (A) as shown in the illustration.

Secure the tow rope to the rear towing hook.

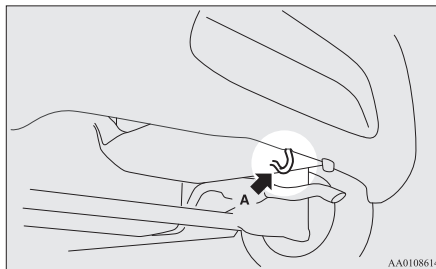

⚠ WARNING

- When towing your vehicle out of a stuck position, be sure that the area around the vehicle is clear of people and physical objects.

NOTE

- Using any part other than the designated towing hooks (A) could result in damage to the vehicle body.

Towing another vehicle

Your vehicle cannot be used to tow another vehicle.

Operation under adverse driving conditions

E00801702818

On a flooded road

- Avoid flooded roads. Water could enter the brake discs, resulting in temporarily ineffective brakes. In such cases, lightly depress the brake pedal to see if the brakes operate properly. If they do not, lightly depress the pedal several times while driving in order to dry the brake pads.
- When driving in rain or on a road with many puddles a layer of water may form between the tyres and the road surface. This reduces a tyre's frictional resistance on the road, resulting in loss of steering stability and braking capability.

To cope with this, observe the following items:

- (a) Drive your vehicle at slow speed.
- (b) Do not drive on worn tyres.
- (c) Always maintain the specified tyre inflation pressures.

On a snow-covered or frozen road

- When driving on a snow-covered or frozen road, it is recommended that you use snow tyres or snow traction device (tyre chains). Refer to the “Snow tyres” and “Snow traction device (tyre chains)” sections.
- Avoid high-speed operation, sudden acceleration, abrupt brake application and sharp cornering.

- Depressing the brake pedal during travel on snowy or icy roads may cause tyre slippage and skidding. When traction between the tyres and the road is reduced the wheels may skid and the vehicle cannot readily be brought to a stop by conventional braking techniques. Braking will differ, depending upon whether you have anti-lock brake system (ABS). As your vehicle is equipped with ABS, brake by pressing the brake pedal hard, and keeping it pressed.
- Allow extra distance between your vehicle and the vehicle in front of you, and avoid sudden braking.
- Accumulation of ice on the braking system can cause the wheels to lock. Pull away from a standstill slowly after confirming safety around the vehicle.

CAUTION

- Do not press the accelerator pedal rapidly. If the wheels break free of the ice, the vehicle could suddenly start moving and possibly cause an accident.

On a bumpy or rutted road

Drive as slow as possible when driving on bumpy or rutted roads.

CAUTION

- The impact on tyres and/or wheels when driving on a bumpy or rutted road can damage the tyre and/or wheel.

CAUTION

- The vehicle's body, bumper, muffler and other parts may be damaged if the vehicle is:
 - driven over a step (for example, at the entrance or exit of a parking lot);
 - parked too closely against a kerb or parking block, or by the side of a road with kerbstones;
 - driven on a steep slope;

A series of 15 horizontal dashed lines spanning the width of the page, providing a template for writing.

Vehicle care

Vehicle care precautions.....	7-02
Cleaning the interior of your vehicle.....	7-02
Cleaning the exterior of your vehicle.....	7-03

Vehicle care precautions

E00900100984

In order to maintain the value of your vehicle, it is necessary to perform regular maintenance using the proper procedures. Always maintain your vehicle in compliance with environmental pollution control regulations. Carefully select the materials used for washing, etc., to be sure that they do not contain corrosives. If in doubt, we recommend you to consult a specialist for selection of these materials.

CAUTION

- **Cleaning products can be dangerous. Always follow the instructions of the cleaning product supplier.**
- **To avoid damage, never use the following to clean your vehicle:**
 - Petrol
 - Paint Thinner
 - Benzine
 - Kerosene
 - Turpentine
 - Naphtha
 - Lacquer Thinner
 - Carbon Tetrachloride
 - Nail Polish Remover
 - Acetone

Cleaning the interior of your vehicle

E00900200611

After cleaning the interior of your vehicle with water, cleaner or similar, wipe and dry in a shady, well-ventilated area.

NOTE

- To clean the inside of the tailgate window, always use a soft cloth and wipe the window glass along the demister heater element so as not to cause damage.

CAUTION

- **Do not use organic substances (solvents, benzine, kerosene, alcohol, petrol, etc.) or alkaline or acidic solutions. These chemicals can cause discolouring, staining or cracking of the surface. If you use cleaners or polishing agents, make sure their ingredients do not include the substances mentioned above.**

Plastic, vinyl leather, fabric and flocked parts

E00900300436

1. Lightly wipe these off with a soft cloth soaked in a mild soap and water solution.
2. Dip cloth in fresh water and wring out well. Using this cloth, wipe off the detergent thoroughly.

NOTE

- Do not use cleaners, conditioners, and protectants containing silicones or wax. Such products, when applied to the instrument panels or other parts, may cause reflections on the windscreen and obscure vision. Also, if such products get on the switches of the electrical accessories, it may lead to failure of these accessories.
- The surface of gloss center panel may be scratched if it is rubbed hard by a brush, synthetic fiber or hard cloth.

Upholstery

E00900500193

1. To maintain the value of your new vehicle, handle the upholstery carefully and keep the interior clean. Use a vacuum cleaner and brush to clean the seats. If stained, vinyl and synthetic leather should be cleaned with an appropriate cleaner. Cloth fabrics can be cleaned with either upholstery cleaner or a mild soap and water solution.
2. Clean the carpeting with a vacuum cleaner and remove any stains with carpet cleaner. Oil and grease can be removed by lightly dabbing with a clean colourfast cloth and stain remover.

Genuine leather*

E00900600963

1. To clean, lightly wipe the leather with a soft cloth soaked in a mild soap and water solution.
2. Dip cloth in fresh water and wring it out well. Using this cloth, wipe off the detergent thoroughly.
3. Apply leather protecting agent to the genuine leather surface.

NOTE

- If genuine leather is wet with water or is washed in water, wipe off water as quickly as possible with a dry, soft cloth. If left damp, mildew may grow.
- Organic solvents such as benzine, kerosene, alcohol and petrol, acid or alkaline solvents may discolour the genuine leather surface. Be sure to use neutral detergents.
- Remove dirty patches or oil substances quickly as they can stain genuine leather.
- The genuine leather surface may harden and shrink if it is exposed to direct sun for long hours. When your vehicle is parked, place it in the shade as much as possible.

Cleaning the exterior of your vehicle

E00900700137

If the following is left on your vehicle, it may cause corrosion, discolouration and stains, wash the vehicle as soon as possible.

- Seawater, road deicing products.
- Soot and dust, iron powder from factories, chemical substance (acids, alkalis, coal-tar, etc.).
- Droppings from birds, carcasses of insects, tree sap, etc.

Washing

E00900902537

Chemicals contained in the dirt and dust picked up from the road surface can damage the paint coat and body of your vehicle if left in prolonged contact. Frequent washing and waxing is the best way to protect your vehicle from this damage. This will also be effective in protecting it from environmental elements such as rain, snow, salt air, etc.

Do not wash the vehicle in direct sunlight. Park the vehicle in the shade and spray it with water to remove dust. Next, using an ample amount of clean water and a car washing brush or sponge, wash the vehicle from top to bottom.

Use a mild car washing soap if necessary. Rinse thoroughly and wipe dry with a soft cloth. After washing the vehicle, carefully clean the joints and flanges of the doors, bonnet, etc., where dirt is likely to remain.

CAUTION

- When washing the under side of your vehicle or wheel, be careful not to injure your hands.
- If your vehicle has rain sensor wipers, place the wiper switch lever in the “OFF” position to deactivate the rain sensor before washing the vehicle. Otherwise, the wipers will operate in the presence of water spray on the windscreen and may get damaged as a result.
- Refrain from excessively using a car wash as its brushes may scratch the paint surface, causing it to lose its gloss. Scratches will be especially visible on darker coloured vehicles.
- Never spray or splash water on the electrical components in the engine compartment, as this may adversely affect engine starting. Exercise caution also when washing the underbody; be careful not to spray water into the engine compartment.
- Some types of hot water washing equipment apply high pressure and heat to the vehicle. They may cause heat distortion and damage to the vehicle resin parts and may result in flooding of the vehicle interior. Therefore;
 - Maintain a distance of approx. 70 cm or more between the vehicle body and the washing nozzle.
 - When washing around the door glass, hold the nozzle at a distance of more than 70 cm and at right angles to the glass surface.

CAUTION

- After washing the vehicle, drive the vehicle slowly while lightly depressing the brake pedal several times in order to dry out the brakes.
Leaving the brakes wet could result in reduced braking performance. Also, there is a possibility that they could freeze up or become inoperative due to rust, rendering the vehicle unable to move.
- When using an automatic car wash, pay attention to the following items, referring to the operation manual or consulting a car wash operator. If the following procedure is not followed, it could result in damage to your vehicle.
 - The outside mirrors are retracted.
 - The antenna is removed.
 - The wiper arm assembly is taped.
 - If your vehicle is equipped with a rear spoiler, consult a car wash operator before using the car wash.
 - If your vehicle has rain sensor wipers, place the wiper switch lever in the "OFF" position to deactivate the rain sensor.

During cold weather

Salt and other chemicals spread on the roads in some areas in winter can have a harmful effect on the vehicle body. You should therefore wash the vehicle as often as possible in accordance with our care-instructions. It is recommended to have a preservative applied and the underfloor protection checked before and after the cold weather season. After washing your vehicle, wipe off all water-drops from the rubber parts around the doors to prevent the doors from freezing.

NOTE

- To prevent freezing of the weatherstripping on the doors, bonnet, etc., they should be treated with silicone spray.

Waxing

E00901000906

Waxing the vehicle will help prevent the adherence of dust and road chemicals to the paintwork. Apply a wax solution after washing the vehicle, or at least once every three months to assist displacing of water. Do not wax your vehicle in direct sunlight. You should wax after the surfaces have cooled.

For information on how to use wax refer to the instruction manual of the wax.

CAUTION

- Waxes containing high abrasive compounds should not be used.

Polishing

E00901100082

The vehicle should only be polished if the paintwork has become stained or lost its lustre. Matt-finish parts and plastic bumpers must not be polished, polishing these parts will stain them or damage their finish.

Cleaning plastic parts

E00901300794

Use a sponge or chamois leather.

If a car wax adheres on a grey or black rough surface of the bumper, moulding or lamps, the surface becomes white. In such a case, wipe it off using lukewarm water and soft cloth or chamois leather.

CAUTION

- Do not use a scrubbing brush or other hard tools as they may damage the plastic part surface.
- Do not bring the plastic parts into contact with petrol, light oil, brake fluids, engine oils, greases, paint thinners, and sulphuric acid (battery electrolyte) which may crack, stain or discolour the plastic parts. If they touch the plastic parts wipe them off with soft cloth, chamois or the like and an aqueous solution of neutral detergent then immediately rinse the affected parts with water.

Chrome parts

E00901400128

In order to prevent spots and corrosion of chrome parts, wash with water, dry thoroughly, and apply a special protective coating. This should be done more frequently in winter.

Aluminium wheels*

E00901500565

1. Remove dirt using a sponge while sprinkling water on the wheel.
2. Use neutral detergent on any dirt that cannot be removed easily with water.
Rinse off the neutral detergent after washing the wheel.
3. Dry the vehicle thoroughly using a chamois leather or a soft cloth.

A CAUTION

- Do not use a brush or other hard implement on the wheels. Doing so could scratch the wheels.
- Do not use any cleaner that contains an abrasive substance or is acidic or alkaline. Doing so could cause the coating on the wheels to peel or become discoloured or stained.
- Do not directly apply hot water using a steam cleaner or by any other means.
- Contact with seawater and road deicer can cause corrosion. Rinse off such substances as soon as possible.

Window glass

E00901600120

The window glass can normally be cleaned using only a sponge and water.

Glass cleaner can be used to remove oil, grease, dead insects, etc. After washing the glass, wipe dry with a clean, dry, soft cloth. Never use the same cloth to wipe the window glass as would be used to wipe the paintwork; wax from the painted surfaces could adhere to the glass and reduce its transparency and visibility.

NOTE

- To clean the inside of the tailgate window, always use a soft cloth and wipe the window glass along the demister heater element so as not to cause damage.

Wiper blades

E00901700088

Use a soft cloth and glass cleaner to remove grease, dead insects, etc., from the wiper blades. Replace the wiper blades when they no longer wipe properly. (Refer to page 8-13.)

Engine compartment

E00902100379

Clean the engine compartment at the beginning and end of winter. Pay particular attention to flanges, crevices and peripheral parts where dust containing road chemicals and other corrosive materials might collect.

If salt and other chemicals are used on the roads in your area, clean the engine compartment at least every three months.

Never spray or splash water on the electrical components in the engine compartment, as this may cause damage.

Do not bring the nearby parts, the plastic parts and so on into contact with sulphuric acid (battery electrolyte) which may crack, stain or discolour them.

If they are in contact, wipe off with soft cloth, chamois or the like and an aqueous solution of neutral detergent then immediately rinse the affected parts with plenty of water.

A series of 15 horizontal dashed lines spanning the width of the page, providing a template for writing.

Maintenance

Service precautions.....	8-02
Catalytic converter.....	8-03
Bonnet.....	8-04
Engine oil.....	8-05
Engine coolant.....	8-06
Washer fluid.....	8-07
Brake fluid.....	8-07
Battery.....	8-08
Tyres.....	8-09
Wiper blade rubber replacement.....	8-13
General maintenance.....	8-14
Fusible links.....	8-15
Fuses.....	8-15
Replacement of lamp bulbs.....	8-19
Masking the headlamps.....	8-25

Service precautions

E01000101035

Adequate care of your vehicle at regular intervals serves to preserve the value and appearance as long as possible.

Maintenance items as described in this owner's manual can be performed by the owner.

We recommend you to have the periodic inspection and maintenance performed by a MITSUBISHI MOTORS Authorized Service Point or another specialist.

In the event a malfunction or a problem is discovered, we recommend you to have it checked and repaired. This section contains information on inspection maintenance procedures that you can do yourself. Follow the instructions and cautions for each of the various procedures.

A WARNING

- When checking or servicing the inside of the engine compartment, make sure the engine is switched off and has had a chance to cool down.
- If it is necessary to do work in the engine compartment with the engine running, be especially careful that your clothing, hair, etc., does not become caught by the fan, drive belts, or other moving parts.
- The fan may turn on automatically even if the engine is not running. Turn the ignition switch to the "LOCK" position or put the operation mode in OFF to be safe while you work in the engine compartment.

A WARNING

- Do not smoke, cause sparks or allow open flames around fuel or battery. The fumes are flammable.
- Be extremely cautious when working around the battery. It contains poisonous and corrosive sulphuric acid.
- Do not get under your vehicle with just the body jack supporting it. Always use automotive jack stands.
- Improper handling of components and materials used in the vehicle can endanger your personal safety. We recommend you to consult a specialist for necessary information.

Check items of engine compartment are located as shown in the figure below.

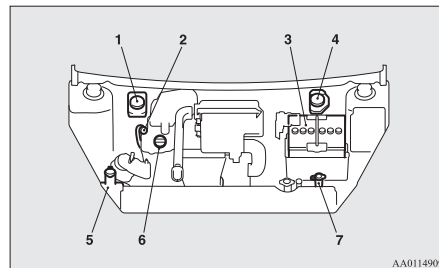

1. Brake fluid reservoir (RHD)
2. Engine oil level gauge
3. Battery
4. Brake fluid reservoir (LHD)
5. Washer fluid reservoir
6. Engine oil cap
7. Engine coolant reservoir

If your vehicle is raised with a garage jack

E01011500032

Only use the appointed position as shown in the illustration.

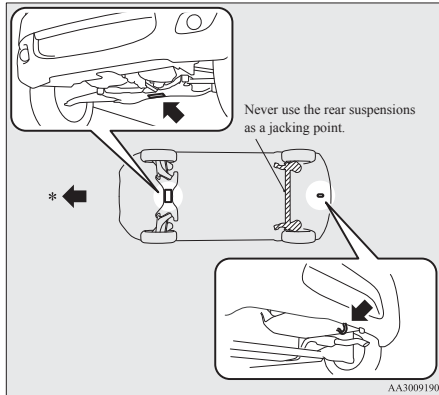

*: Front of the vehicle

⚠ WARNING

- Set the jack only at the positions shown here. If the jack is set at a wrong position, it could damage your vehicle or the jack might fall over and cause personal injury.

⚠ WARNING

- Do not use the jack on a tilted or soft surface. Otherwise, the jack might slip and cause personal injury. Always use the jack on a flat, hard surface. Before setting the jack, make sure there are no sand or pebbles under the jack base.

Catalytic converter

E01000200765

The exhaust gas scavenging devices used with the catalytic converter are extremely efficient for the reduction of noxious gases. The catalytic converter is installed in the exhaust system.

It is important to keep the engine properly tuned to ensure proper catalyst operation and prevent possible catalyst damage.

⚠ WARNING

- As with any vehicle, do not park or operate this vehicle in areas where combustible materials such as dry grass or leaves can come in contact with a hot exhaust since a fire could occur.
- Paint should not be applied to the catalytic converter.

NOTE

- Use fuel of the type recommended in “Fuel selection” on page 02.

Bonnet

E01000302858

To open

1. Pull the release lever towards you to unlock the bonnet.

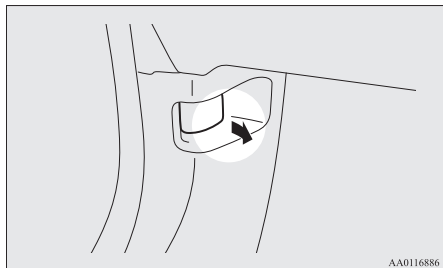

2. Raise the bonnet while pressing the safety lock.

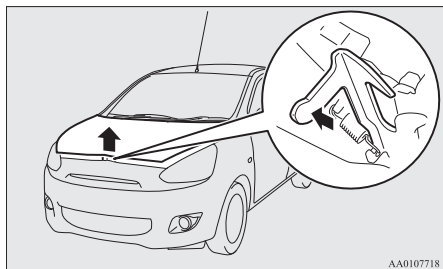

NOTE

- Only open the bonnet when the wipers are in the parked position. Failure to do so may cause damage to the bonnet, wiper arms or windscreen.
3. Support the bonnet by inserting the support bar in its slot.

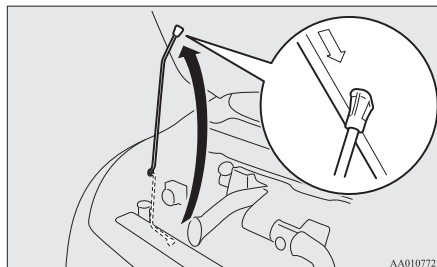

⚠ CAUTION

- Note that the support bar may disengage the bonnet if the open bonnet is lifted by a strong wind.
- After inserting the support bar into the slot, make sure the bar supports the bonnet securely from falling down on to your head or body.

To close

1. Unlatch the support bar and clip it in its holder.
2. Slowly lower the bonnet to a position about 20 cm above the closed position, then let it drop.

3. Make sure the bonnet is securely locked by softly lifting the centre of the bonnet.

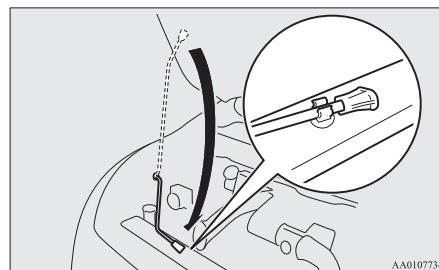

⚠ CAUTION

- Be careful that hands or fingers are not trapped when closing the bonnet.
- Before driving, make sure that the bonnet is securely locked. An incompletely locked bonnet can suddenly open while driving. This can be extremely dangerous.

NOTE

- If this does not close the bonnet, release it from a slightly higher position.
- Do not press down the bonnet hard with a hand as it may damage the bonnet.

Engine oil

E01000403058

To check and refill engine oil

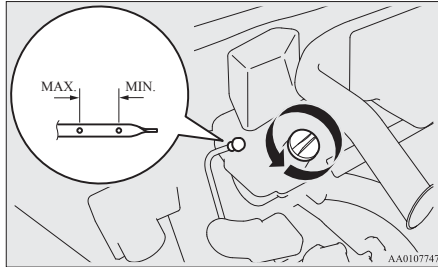

The engine oil used has a significant effect on the engine's performance, service life and startability. Be sure to use oil of the recommended quality and appropriate viscosity.

All engines consume a certain amount of oil during normal operation. Therefore, it is important to check the oil level at regular intervals or before starting a long trip.

1. Park the car on a horizontal surface.
2. Switch off the engine.
3. Wait a few minutes.
4. Remove the dipstick and wipe it with a clean cloth.
5. Reinsert the dipstick as far as it goes.
6. Remove the dipstick and read the oil level, which should always be within the range indicated.

7. If the oil level is below the specified limit, remove the cap located on the cylinder head cover and add enough oil to raise the level to within the specified range. Do not overfill to avoid engine damage. Be sure to use the specified engine oil and do not mix various types of oil.
8. After adding oil, close the cap securely.
9. Confirm the oil level by repeating step 4 to 6.

NOTE

- The engine oil will deteriorate rapidly if the vehicle is subjected to severe conditions, requiring earlier oil replacement. Please refer to the maintenance schedule.
- For handling of used engine oils, refer to page 05.

Selection of engine oil

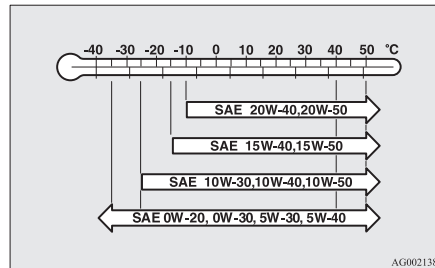

- Select engine oil of the proper SAE viscosity number according to the atmospheric temperature. SAE 0W-20, 0W-30, 5W-30 and 5W-40 engine oils can only be used if they meet ACEA A3/B3, A3/B4 or A5/B5 and API SM (or higher) specifications.
- Use engine oil conforming to the following classification:
 - API classification: "For service SM" or higher
 - ILSAC certificated oil
 - ACEA classification: "For service A1/B1, A3/B3, A3/B4 or A5/B5"

NOTE

- Use of additives is not recommended since they may reduce the effectiveness of additives already included in the engine oil. It may result in failure of the mechanical assembly.

Engine coolant

E01000502108

To check the coolant level

A translucent coolant reservoir (A) is located in the engine compartment.

The coolant level in this tank should be kept between the "L" (LOW) and "F" (FULL) marks when measured while the engine is cold.

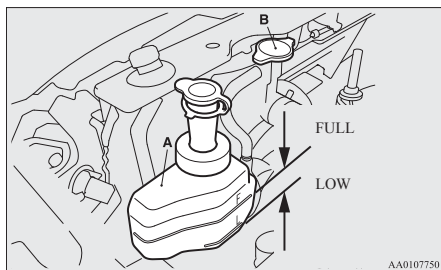

To add coolant

The cooling system is a closed system and normally the loss of coolant should be very slight. A noticeable drop in the coolant level could indicate leakage. If this occurs, we recommend you to have the system checked as soon as possible.

If the level should drop below the "L" (LOW) level on the reservoir, open the lid and add coolant.

Also, if the reservoir is completely empty, remove the radiator cap (B) and add coolant until the level reaches the filler neck.

⚠ WARNING

- Do not open the radiator cap while the engine is hot. The coolant system is under pressure and any hot coolant escaping could cause severe burns.

Anti-freeze

The engine coolant contains an ethylene glycol anti-corrosion agent. Some parts of the engine are cast aluminium alloy, and periodic changing of the engine coolant is necessary to prevent corrosion of these parts.

Use "MITSUBISHI MOTORS GENUINE SUPER LONG LIFE COOLANT PREMIUM" or equivalent*.

*: similar high quality ethylene glycol based non-silicate, non-amine, non-nitrate and non-borate coolant with long life hybrid organic acid technology MITSUBISHI MOTORS GENUINE Coolant has excellent protection against corrosion and rust formation of all metals including aluminium and can avoid blockages in the radiator, heater, cylinder head, engine block, etc.

Because of the necessity of this anti-corrosion agent, the coolant must not be replaced with plain water even in summer. The required concentration of anti-freeze differs depending on the expected ambient temperature.

Above -35 °C: 50 % concentration of anti-freeze

Below -35 °C: 60 % concentration of anti-freeze

⚠ CAUTION

- Do not use alcohol or methanol anti-freeze or any engine coolants mixed with alcohol or methanol anti-freeze. The use of an improper anti-freeze can cause corrosion of the aluminium components.
- Do not use water to adjust the concentration of coolant.
- Concentrations exceeding 60 % will result in a reduction of both the anti-freeze and cooling performance thus adversely affecting the engine.
- Do not top up with water only.

During cold weather

The concentration should be checked before the start of cold weather and anti-freeze added to the system if necessary to prevent damage to engine and radiator due to freezing.

Washer fluid

E01000700920

Open the washer fluid reservoir cap and check the level of washer fluid.

If the level is low, replenish the container with washer fluid.

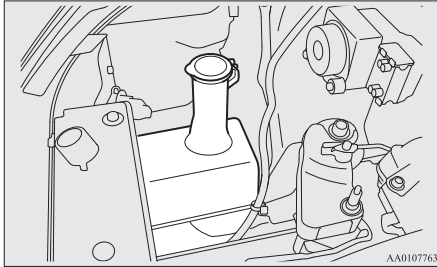

NOTE

- The washer fluid container serves the windshield and rear window.

During cold weather

To ensure proper operation of the washers at low temperatures, use a fluid containing an anti-freezing agent.

Brake fluid

E01000900922

To check the fluid level

The fluid level must be between the “MAX” and “MIN” marks on the reservoir.

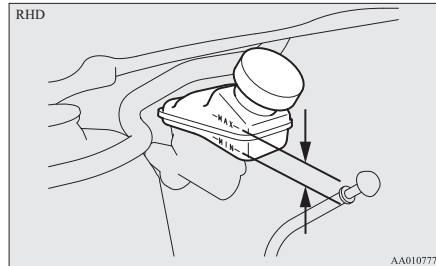
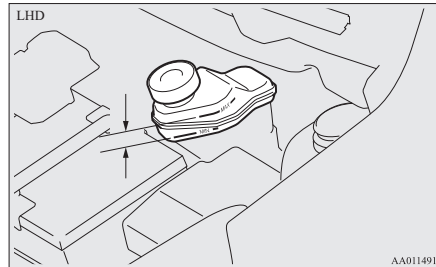

The fluid level is monitored by a float. When the fluid level falls below the “MIN” mark, the brake fluid warning lamp lights up.

The fluid level falls slightly with wear of the brake pads, but this does not indicate any abnormality.

If the fluid level falls markedly in a short length of time, it indicates leaks from the brake system.

If this occurs, we recommend you to have the vehicle checked.

Fluid type

Use brake fluid conforming to DOT3 or DOT4 from a sealed container. The brake fluid is hygroscopic. Too much moisture in the brake fluid will adversely affect the brake system, reducing the performance.

⚠ CAUTION

- Take care in handling brake fluid as it is harmful to the eyes, may irritate your skin and also damage painted surfaces.
- Use only the specified brake fluid. Do not mix or add different brands of brake fluid to prevent chemical reactions. Do not let any petroleum-based fluid touch, mix with, or get into the brake fluid. This will damage the seals.
- Keep the reservoir tank cap closed to prevent the brake fluid from deteriorating except maintenance.
- Clean the filler cap before removing and close the cap securely after maintenance.

Battery

E01001202274

The condition of the battery is very important for quick starting of the engine and proper functioning of the vehicle's electrical system. Regular inspection and care are especially important in cold weather.

Checking battery electrolyte level

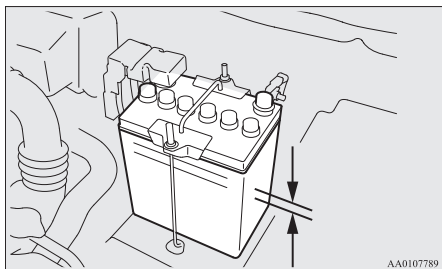

The electrolyte level must be between the specified limit on the outside of the battery. Replenish with distilled water as necessary.

The inside of the battery is divided into several compartments; remove the cap from each compartment and fill to the upper mark. Do not top up beyond the upper mark because spillage during driving could cause damage.

Check the electrolyte level at least once every 4 weeks, depending on the operating conditions.

If the battery is not used, it will discharge by itself with time. Check it once every 4 weeks and charge with low current as necessary.

During cold weather

E01010900084

The capacity of the battery is reduced at low temperatures. This is an inevitable result of its chemical and physical properties.

This is why a very cold battery, particularly one that is not fully charged, will only deliver a fraction of the starter current which is normally available.

We recommended you to have the battery checked before the start of cold weather and, if necessary, have it charged or replaced.

This does not only ensure reliable starting, but a battery which is kept fully charged also has a longer life.

Disconnection and connection

E01011000196

To disconnect the battery cable, stop the engine, first disconnect the negative (-) terminal and then the positive (+) terminal. When connecting the battery, first connect the positive (+) terminal and then the negative (-) terminal.

NOTE

- Open the terminal cover (A) before disconnecting or connecting the positive (+) terminal of the battery.
- Loosen the nut (B), and then disconnect the battery cable from the positive (+) terminal.

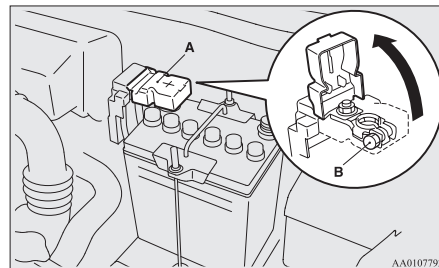

⚠ WARNING

- Keep sparks, cigarettes, and flames away from the battery because the battery could explode.
- The battery electrolyte is extremely caustic. Do not allow it to come in contact with your eyes, skin, clothing, or the painted surfaces of the vehicle. Spilt electrolyte should be flushed immediately with ample amounts of water. Irritation to eyes or skin from contact with electrolyte requires immediate medical attention.
- Ventilate when charging or using the battery in an enclosed space.

⚠ CAUTION

- Keep it out of reach of children.
- Never disconnect the battery when the ignition switch is in the "ON" position. Doing so could damage electric components.

⚠ CAUTION

- Never short-circuit the battery. This could cause it to overheat and be damaged.
- If the battery is to be quick-charged, first disconnect the battery cables.
- In order to prevent a short circuit, be sure to disconnect the negative (-) terminal first.
- Always wear protective eye goggles when working near the battery.
- Do not bring the nearby parts, the plastic parts and so on into contact with sulphuric acid (battery electrolyte) which may crack, stain or discolour them.
If they are in contact, wipe off with soft cloth, chamois or the like and an aqueous solution of neutral detergent then immediately rinse the affected parts with plenty of water.

NOTE

- Keep the terminals clean. After the battery is connected, apply terminal protection grease. To clean the terminals, use lukewarm water.
- Check to see if the battery is securely installed and cannot be moved during travel. Also check each terminal for tightness.
- When the vehicle is to be left unused for a long period of time, remove the battery and store it in a place where the battery fluid will not freeze. The battery should be stored only in a fully charged condition.

Tyres

E01001300301

⚠ WARNING

- Driving with tyres that are worn, damaged or improperly inflated can lead to a loss of control or blow out of the tyres which can result in a collision with serious or fatal injury.

Tyre inflation pressures

E01001402843

Item	Tyre size	Front	Rear
Normal tyre	165/65R14 79S	2.7 bar (39 psi) [270 kPa]	
	175/55R15 77V	2.2 bar (32 psi) [220 kPa], 2.4 bar (35 psi) [240 kPa]*	
Compact spare tyre	T115/70D14 88M	4.2 bar (60 psi) [420 kPa]	

*: Above 160 km/h (99 mph)

Check the tyre inflation pressure of all the tyres while they are cold: if insufficient or excessive, adjust to the specified value. After the tyre inflation pressure has been adjusted, check the tyres for damage and air leaks. Be sure to put caps on the valves.

Wheel condition

E01001800957

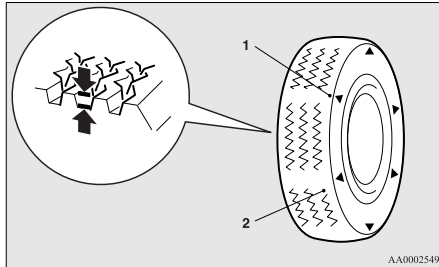

- 1- Location of the tread wear indicator
2- Tread wear indicator

Check the tyres for cuts, cracks and other damage. Replace the tyres if there are deep cuts or cracks. Also check each tyre for pieces of metal or pebbles. The use of worn tyres can be very dangerous because of the greater chance of skidding or hydroplaning. The tread depth of the tyres must exceed 1.6 mm in order for the tyres to meet the minimum requirement for use.

Tread wear indicators will appear on the surface of the tyre as the tyre wears, thereby indicating that the tyre no longer meets the minimum requirement for use. When these wear indicators appear, the tyres must be replaced with new ones.

Replacing tyres and wheels

E01007200490

⚠ CAUTION

- Avoid using different size tyres from the one listed and the combined use of different types of tyres, as this can affect driving safety. Refer to “Tyres and wheels” on page 9-10.
- Even if a wheel has the same rim size and offset as the specified type of wheel, its shape may prevent it from being fitted correctly. We recommend you to consult a specialist before using wheels that you have.

Tyre rotation

E01001901489

Tyre wear varies with vehicle conditions, road surface conditions and individual driver’s driving habits. To equalize the wear and help extend tyre life, it is recommended to rotate the tyres immediately after discovery of abnormal wear, or whenever the wear difference between the front and rear tyres is recognizable.

When rotating tyres, check for uneven wear and damage. Abnormal wear is usually caused by incorrect tyre pressure, improper wheel alignment, out of balance wheel, or severe braking. We recommend you to have it checked to determine the cause of irregular tread wear.

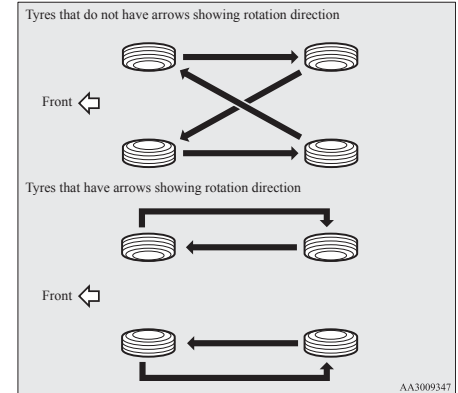

⚠ CAUTION

- A compact spare tyre can be fitted temporarily in place of a tyre that has been removed during the tyre rotation. However, it must not be included in the regular tyre rotation sequence.

⚠ CAUTION

- If the tyres have arrows (A) indicating the correct direction of rotation, swap the front and rear wheels on the left hand side of the vehicle and the front and rear wheels on the right hand side of the vehicle separately. Keep each tyre on its original side of the vehicle. When fitting the tyres, make sure the arrows point in the direction in which the wheels will turn when the vehicle moves forward. Any tyre whose arrow points in the wrong direction will not perform to its full potential.

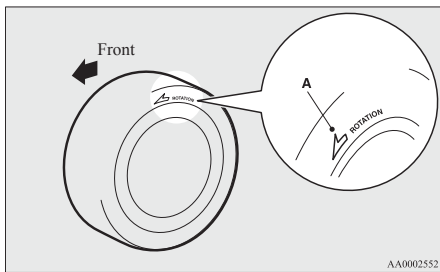

⚠ CAUTION

- Avoid the combined use of different types of tyres. Using different types of tyres can affect vehicle performance and safety.

Snow tyres

E01002000839

The use of snow tyres is recommended for driving on snow and ice. To preserve driving stability, mount snow tyres of the same size and tread pattern on all 4 wheels.

A snow tyre that is worn down more than 50 % is no longer appropriate to use.

Snow tyres which do not meet specifications must not be used.

⚠ CAUTION

- Observe permissible maximum speed for your snow tyres and the legal speed limit.

NOTE

- The laws and regulations concerning snow tyres (driving speed, required use, type, etc.) vary. Find out and follow the laws and regulations in the area you intend to drive.
- If flange nuts are used on your vehicle, change to tapered nuts when steel wheels are used.

Snow traction device (tyre chains)

E01002101941

If snow traction device (tyre chains) have to be used, ensure that they are fitted only on the drive wheels (front) in accordance with the manufacturer's instructions.

Use only snow traction device (tyre chains) which are designed for use with the tyres mounted on the vehicle: use of the incorrect size or type of snow traction device (tyre chains) could result in damage to the vehicle body.

Contact a MITSUBISHI MOTORS Authorized Service Point before putting on snow traction device (tyre chains). The max. snow traction device (tyre chains) height is as follows.

Tyre size	Wheel size	Max. snow traction device (tyre chains) height [mm]
165/65R14 79S	14 x 4 1/2 J	9 mm
175/55R15 77V	15 x 5 J	

When driving with snow traction device (tyre chains) on the tyres, do not drive faster than 50 km/h (30 mph). When you reach roads that are not covered in snow, immediately remove the snow traction device (tyre chains).

⚠ CAUTION

- Choose a clear straight stretch of road where you can pull off and still be seen while you are fitting the snow traction device (tyre chains).
- Do not fit snow traction device (tyre chains) before you need them. This will wear out your tyres and the road surface.
- After driving around 100-300 meters, stop and retighten the snow traction device (tyre chains).
- Drive carefully and do not exceed 50 km/h (30 mph). Remember that preventing accidents is not the purpose of snow traction device (tyre chains).

⚠ CAUTION

- When snow traction device (tyre chains) are installed, take care that they do not damage the disc wheel or body.
- Do not install a snow traction device (tyre chains) on an emergency wheel which is compact in size. If one of the front wheels has punctured, replace it with one of the rear wheels and install the compact spare wheel in that place before fitting a snow traction device (tyre chains).
- An aluminium wheel can be damaged by a snow traction device (tyre chains) while driving. When fitting a snow traction device (tyre chains) on an aluminium wheel, take care that any part of the snow traction device (tyre chains) and fitting cannot be brought into contact with the wheel.
- Remove the wheel covers before installing a snow traction device (tyre chains), otherwise they may be damaged by the snow traction device (tyre chains). (See page 6-16.)
- When installing or removing a snow traction device (tyre chains), take care that hands and other parts of your body are not injured by the sharp edges of the vehicle body.

NOTE

- The laws and regulations concerning the use of snow traction device (tyre chains) vary. Always follow local laws and regulations. In most countries, it is prohibited by the law to use of snow traction device (tyre chains) on roads without snow.

Wiper blade rubber replacement

E01008200338

Windscreen wiper blades (Driver's side)

1. Lift the wiper arm off the windscreen.
2. Pull the wiper blade until its stopper (A) disengages from the hook (B). Then, pull the wiper blade further to remove it.

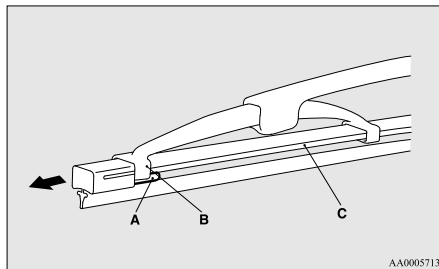

NOTE

- Do not allow the wiper arm to fall onto the windscreen; it could damage the glass.
3. Attach the retainers (C) to a new wiper blade.

Refer to the illustration to ensure that the retainers are correctly aligned as you attach them.

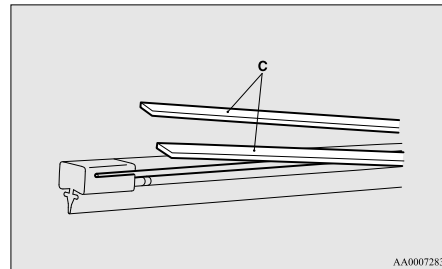

4. Insert the wiper blade into the arm, starting with the opposite end of the blade from the stopper. Make sure the hook (B) is fitted correctly in the grooves in the blade.

NOTE

- If retainers are not supplied with the new wiper blade, use the retainers from the old blade.

Maintenance

5. Push the wiper blade until the hook (B) engages securely with the stopper (A).

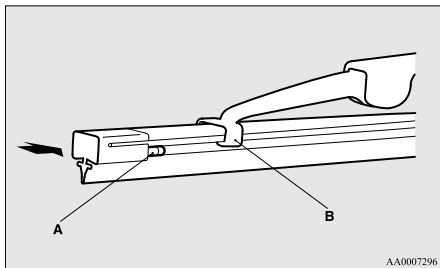

Windscreen wiper blades (Passenger's side)/Rear window wiper blades

1. Lift the wiper arm off the window glass.
2. Pull the wiper blade downward to disengage it from the stopper (A) at the end of the wiper arm. Pull the wiper blade further to remove it.
3. Slide a new wiper blade through the hook (B) on the wiper arm.

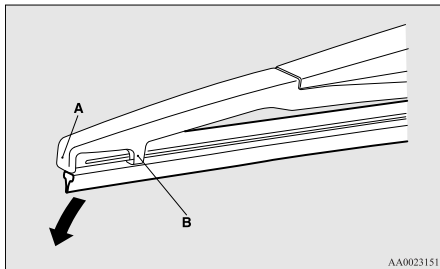

NOTE

- Do not allow the wiper arm to fall onto the window glass; it could damage the glass.

4. Firmly insert the retainer (C) into the groove (D) in the wiper blade. Refer to the illustration to ensure that the retainers are correctly aligned as you insert them into the groove.

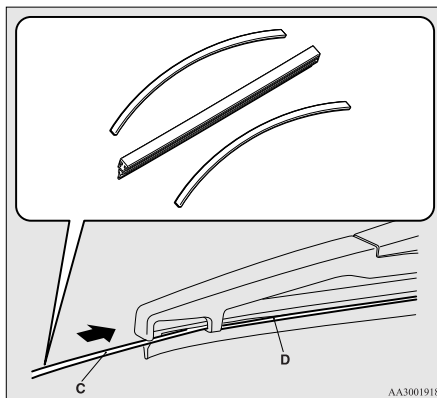

NOTE

- If a retainer is not supplied with the new wiper blade, use the retainer from the old blade.

General maintenance

E01002700559

Fuel, engine coolant, oil and exhaust gas leakage

Look under the body of your vehicle to check for fuel, engine coolant, oil and exhaust gas leaks.

⚠ WARNING

- If you see a suspicious fuel leak or if you smell fuel, do not operate the vehicle; call your MITSUBISHI MOTORS Authorized Service Point for assistance.

Exterior and interior lamp operation

Operate the combination lamp switch to check that all lamps are functioning properly.

If the lamps do not illuminate, the probable cause is a blown fuse or defective lamp bulb. Check the fuses first. If there is no blown fuses, check the lamp bulbs.

For information regarding the inspection and replacement of the fuses and the lamp bulbs, refer to "Fuses" on page 8-15 and "Replacement of lamp bulbs" on page 8-19.

If the fuses and bulbs are all OK, we recommend you to have your vehicle checked and repaired.

Meter, gauge and indicator/warning lamps operation

Run the engine to check the operation of all meters, gauges, and indicator/warning lamps.

If there is anything wrong, we recommend you to have your vehicle inspected.

Hinges and latches lubrication

Check all latches and hinges, and, if necessary, have them lubricated.

Fusible links

E01002900636

The fusible links will melt to prevent a fire if a large current attempts to flow through certain electrical systems.

In case of a melted fusible link, we recommend you to have your vehicle inspected.

For the fusible links, please refer to “Engine compartment fuse location table” on page 8-17.

WARNING

- **Fusible links must not be replaced by any other device. Failing to fit the correct fusible link may result in fire in the vehicle, property destruction and serious or fatal injuries at any time.**

Fuses

E01003002335

Fuse block location

To prevent damage to the electrical system due to shortcircuiting or overloading, each individual circuit is provided with a fuse.

There are fuse blocks in the passenger compartment and in the engine compartment.

Passenger compartment (LHD vehicles)

The fuse blocks in the passenger compartment are located behind the fuse lid in front of the driver's seat at the position shown in the illustration.

Pull the fuse lid to remove it.

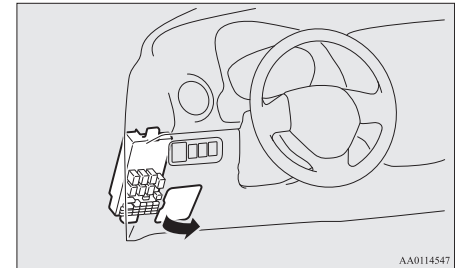

AA0114547

Maintenance

Passenger compartment (RHD vehicles)

The fuse boxes in the passenger compartment are located behind the glove box at the position shown in the illustration.

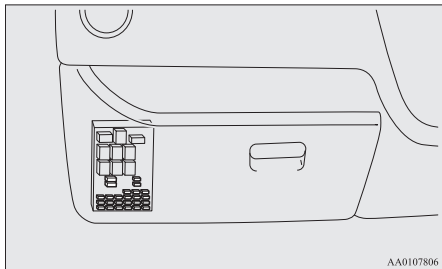

1. Open the glove box.
2. While pressing the side of the glove box, unhook the left and right hooks (A) and lower the glove box.

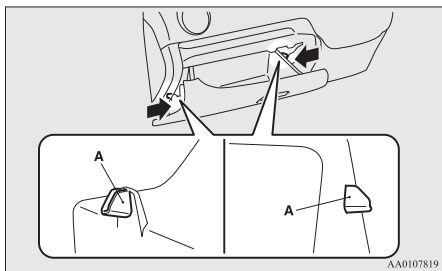

3. Remove the glove box fastener (B), and then remove the glove box.

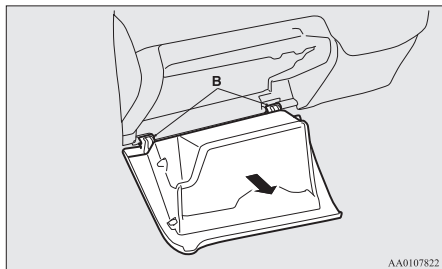

Engine compartment

In the engine compartment, the fuse block is located as shown in the illustration.

While pressing the tab (A or B), pull up the cover.

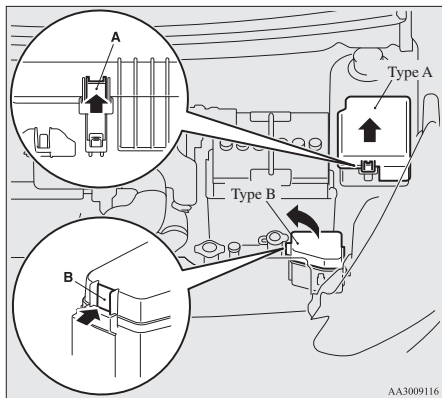

Fuse load capacity

E01007700727

The fuse capacity and the names of electrical systems protected by the fuses are indicated on the inside of the fuse lid (LHD vehicles), the back of the glove box (RHD vehicles) and inside of the fuse block cover (inside of the engine compartment).

NOTE

- Spare fuses are provided in the fuse block of the engine compartment. Always use a fuse of the same capacity for replacement.

Passenger compartment fuse location table

E01007900846

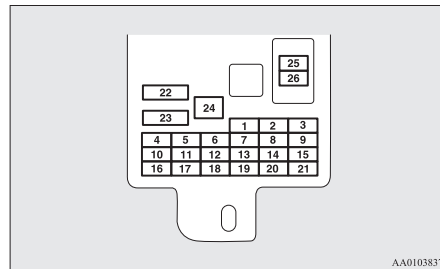

No.	Symbol	Electrical system	Capacity
1		Tail lamp (left)	7.5 A
2		Cigarette lighter	15 A
3		Ignition coil	10 A
4		Starter motor	7.5 A

No.	Symbol	Electrical system	Capacity
5	—	—	—
6	—	—	—
7	☹	Tail lamp (right)	7.5 A
8	☹	Outside rear-view mirrors	7.5 A
9	⚙	Engine control unit	7.5 A
10	⚙	Control unit	7.5 A
11	☹	Rear fog lamp	10 A
12	🚪	Central door lock	15 A
13	☀	Room lamp	15 A
14	🚪	Rear window wiper	15 A
15	🕒	Gauge	7.5 A
16	⚙	Relay	7.5 A
17	🖐	Heated seat	20 A
18	OPTION	Option	10 A
19	🚪	Heated door mirror	7.5 A
20	🚪	Windscreen wiper	20 A
21	☹	Reversing lamps	7.5 A
22	🚪	Demister	30 A
23	🔥	Heater	30 A
24	—	—	—

No.	Symbol	Electrical system	Capacity
25	🎵	Radio	10 A
26	⚙	Electronic controlled unit	15 A

- Some fuses may not be installed on your vehicle, depending on the vehicle model or specifications.
- The table above shows the main equipment corresponding to each fuse.

Engine compartment fuse location table



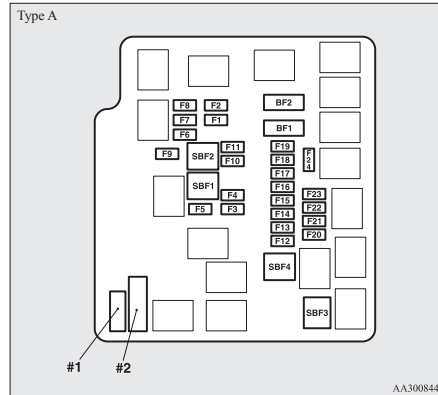





E01008000860



No.	Symbol	Electrical system	Capacity
SBF1	☹	Radiator fan motor	40 A*
SBF2	(ABS)	Anti-lock brake system	30 A*
SBF3	🔑	Ignition switch	40 A*
SBF4	🚪	Electric window control	40 A*
BF1	A/T	DC-DC (P/T)	30 A
BF2	🎵	DC-DC (AUDIO)	30 A
F1	☹	Headlamp low beam (left)	10 A
F2	☹	Headlamp low beam (right)	10 A
F3	☹	Headlamp high-beam (left)	10 A
F4	☹	Headlamp high-beam (right)	10 A
F5	🐂	Horn	10 A
F6	☹	Front fog lamps	15 A
F7	☹	Daytime running lamps	10 A
F8	—	—	—
F9	—	—	—
F10	🚪	Starter	7.5 A
F11	—	—	—
F12	STOP	Stop lamps (Brake lamps)	15 A

*: Fusible link

Maintenance



No.	Symbol	Electrical system	Capacity
F13		Ignition coil	7.5 A
F14		Engine control	7.5 A
F15		Alternator	7.5 A
F16		Hazard warning flasher	10 A
F17	A/T	Automatic transmission	15 A
F18		Air conditioning	10 A
F19		ETV	15 A
F20		Battery current sensor	7.5 A
F21	A/T	CVT oil/pump	15 A
F22		Fuel pump	15 A
F23		Engine	20 A
F24	A/T	Automatic transmission	7.5 A
#1	—	Spare fuse	20 A
#2	—	Spare fuse	30 A

*: Fusible link

- Some fuses may not be installed on your vehicle, depending on the vehicle model or specifications.

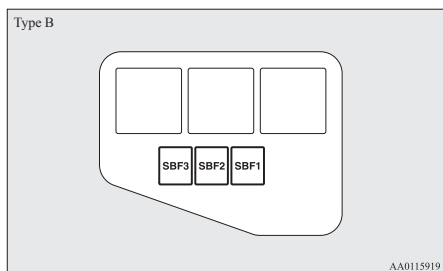
- The table above shows the main equipment corresponding to each fuse.



No.	Symbol	Electrical system	Capacity
SBF1		PTC heater	40 A*
SBF2		PTC heater	40 A*
SBF3		PTC heater	40 A*

*: Fusible link

- Some fuses may not be installed on your vehicle, depending on the vehicle model or specifications.
- The table above shows the main equipment corresponding to each fuse.

The fuse box does not contain spare 7.5 A, 10 A or 15 A fuses. If one of these fuses burns out, substitute with the following fuse.

7.5 A: Outside rear-view mirrors

10 A: Option

15 A: Cigarette lighter

When using a substitute fuse, replace with a fuse of the correct capacity as soon as possible.

Identification of fuse

E01008100366

Capacity	Colour
7.5 A	Brown
10 A	Red
15 A	Blue
20 A	Yellow
30 A	Green (fuse type) / Pink (fusible link type)
40 A	Green (fusible link type)

Fuse replacement

E01007800887

1. Before replacing a fuse, always turn off the electrical circuit concerned and place the ignition switch in the “LOCK” position or put the operation mode in OFF.
2. Remove the fuse puller (A) from the inside of the fuse box in the engine compartment.

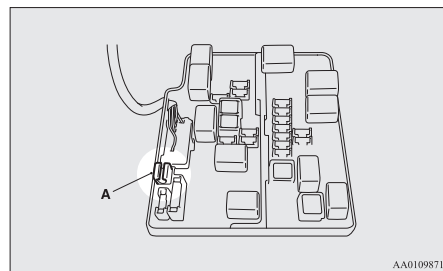

3. Referring to the fuse load capacity table, check the fuse pertaining to the problem.

Replacement of lamp bulbs

E01003100794

Before replacing a bulb, ensure the lamp is off. Do not touch the glass part of the new bulb with your bare fingers; the skin oil left on the glass will evaporate when the bulb gets hot and the vapour will condense on the reflector and dim the surface.

CAUTION

- Bulbs are extremely hot immediately after being turned off. When replacing a bulb, wait for it to cool sufficiently before touching it. You could otherwise be burnt.
- Handle halogen lamp bulbs with care. The gas inside halogen lamp bulbs is highly pressurized, so dropping, knocking, or scratching a halogen lamp bulb can cause it to shatter.
- Never hold the halogen lamp bulb with a bare hand, dirty glove, etc. The oil from your hand could cause the bulb to break the next time the headlamps are operated. If the glass surface is dirty, it must be cleaned with alcohol, paint thinner, etc., and refit it after drying it thoroughly.

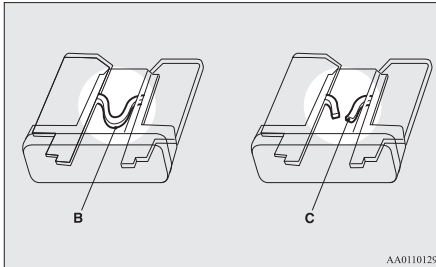

B- Fuse is OK
C- Blown fuse

NOTE

- If any system does not function but the fuse corresponding to that system is normal, there may be a fault in the system elsewhere. We recommend you to have your vehicle checked.
4. Insert a new fuse of the same capacity by using the fuse puller into the same place at the fuse block.

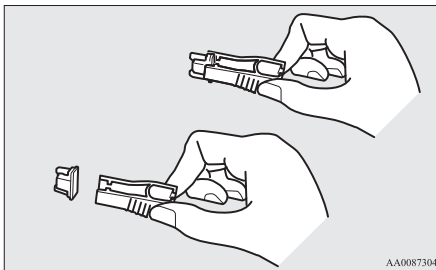

CAUTION

- If the newly inserted fuse blows again after a short time, we recommend you to have the electrical system checked to find the cause and rectify it.
- Never use a fuse with a capacity larger than that specified or any substitute, such as wire, foil, etc.; doing so will cause the circuit wiring to heat up and could cause a fire.

Maintenance

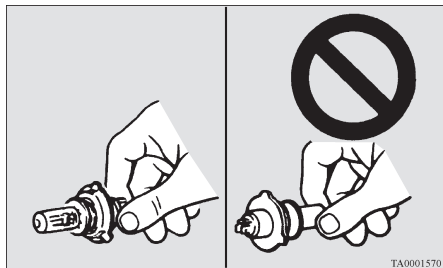

NOTE

- If you are unsure of how to carry out the work as required, we recommend you to consult a specialist.
- Be careful not to scratch the vehicle body when removing a lamp or lens.
- When it rains or when the vehicle has been washed, the inside of the lens sometimes becomes foggy. This is the same phenomenon as when window glass mists up on a humid day, and does not indicate a functional problem. When the lamp is switched on, the heat will remove the fog. However, if water gathers inside the lamp, we recommend you to have the lamp checked.

Bulb location and capacity

E01003200320

When replacing a bulb, use a new bulb with the same wattage and colour.

Outside

E01003303032

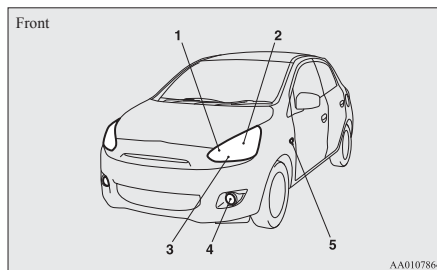

- 1- Front turn-signal lamps: 21 W (PY21W)
- 2- Headlamps: 60/55 W (H4)
- 3- Position lamps: 5 W (W5W)
- 4- Type 1
Daytime running lamps: 13 W (P13W)
Type 2
Front fog lamps: 35 W (H8)
Daytime running lamps: 13 W (P13W)
- 5- Side turn-signal lamps: 5 W

Codes in parentheses indicate bulb types.

NOTE

- For the side turn-signal lamp, it is not possible to repair or replace just the bulb. For repair and replacement, contact a MITSUBISHI MOTORS Authorized Service Point.

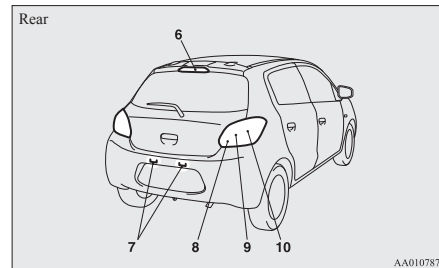

- 6- High-mounted stop lamp (bulb type)*: 5 W (W5W)
- 7- Licence plate lamps: 5 W (W5W)
- 8- Reversing lamps (passenger's side): 21 W (P21W)
Rear fog lamp (driver's side): 21 W (P21W)
- 9- Rear turn-signal lamps: 21 W (P21W)
- 10- Stop and tail lamps: 21/5 W (P21/5W)

Codes in parentheses indicate bulb types.

NOTE

- On a vehicle with a rear spoiler, the high-mounted stop lamp uses LEDs rather than bulbs. For repair and replacement, contact a MITSUBISHI MOTORS Authorized Service Point.

Inside

E01003402049

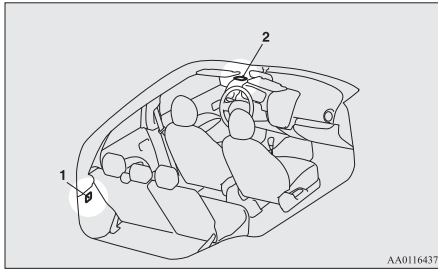

- 1- Luggage room lamp: 5 W
- 2- Room lamp: 8 W

AA0116437

Headlamps

E01009300336

- 1. Pull out the connector (A), and then remove the sealing cover (B).

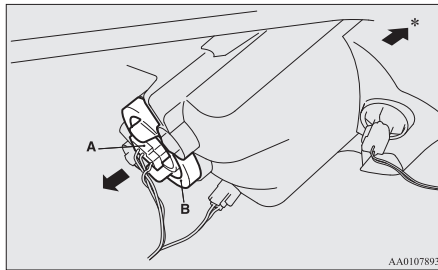

AA0107893

*: Front of the vehicle

- 2. Unhook the spring (C), which secures the bulb, and then remove the bulb (D).

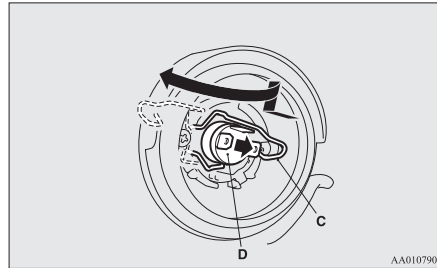

AA0107907

- 3. To install the bulb, perform the removal steps in reverse.

Position lamps

E01003701188

- 1. Turn the socket (A) anticlockwise to remove it.

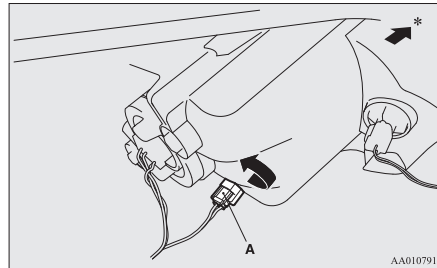

AA0107910

*: Front of the vehicle

- 2. Pull the bulb out of the socket.

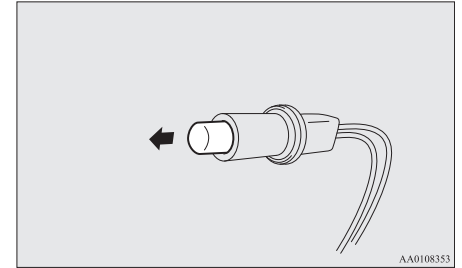

AA0108353

- 3. To install the bulb, perform the removal steps in reverse.

Front turn-signal lamps

E01003801091

- 1. Turn the socket (A) anticlockwise to remove it.

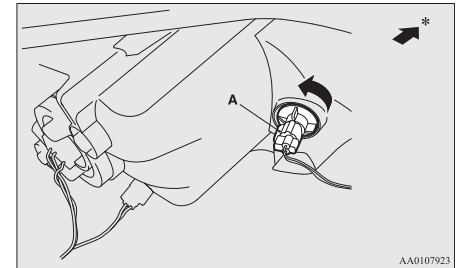

AA0107923

*: Front of the vehicle

Maintenance

2. Remove the bulb from the socket by turning it anticlockwise while pressing in.

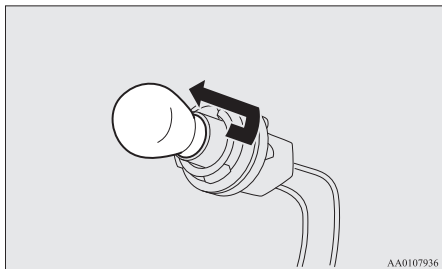

3. To install the bulb, perform the removal steps in reverse.

Front fog lamps* / Daytime running lamps*

E01004001797

1. To create enough work space, turn the steering wheel all the way in the direction opposite to the side you wish to replace.

2. Remove the clips/bolts (A) to turn up the cover (B).

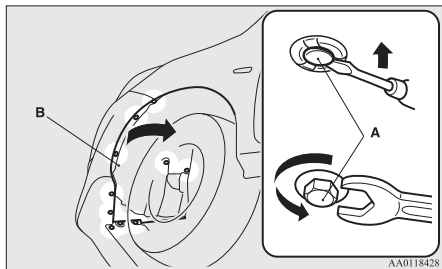

3. While pressing the tab (C or D), pull out the connector.

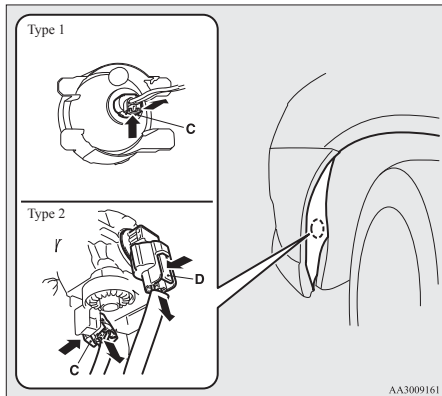

C- Daytime running lamp
D- Front fog lamp

4. Turn the bulb anticlockwise to remove it.

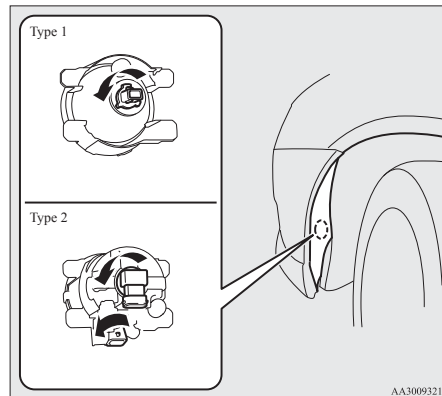

5. To install the bulb, perform the removal steps in reverse.

NOTE

- When refitting each of the clips, first insert part (E) of the clip into the hole and then press part (F) into it.

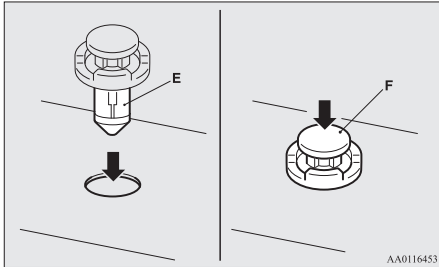

Rear combination lamps

E01004201539

1. Open the tailgate
(Refer to “Tailgate” on page 1-14.)
2. Remove the screws (A) that hold the lamp unit.

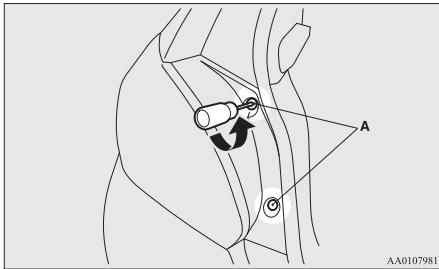

3. Move the lamp unit towards the rear of the vehicle to unfix the notch (B) and pin (C).

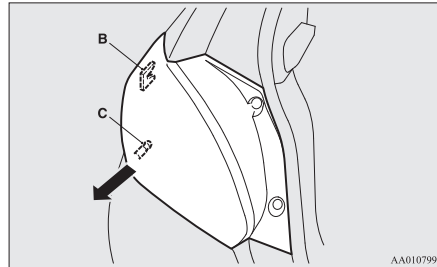

4. Turn the socket anticlockwise to remove it.

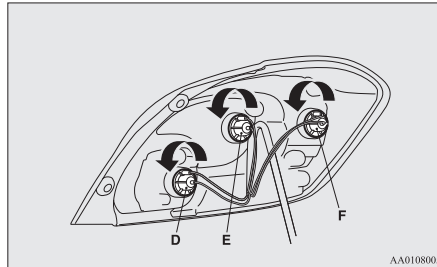

- D- Reversing lamp (passenger’s side)/Rear fog lamp (driver’s side)
- E- Rear turn-signal lamp
- F- Stop and tail lamp

5. Remove the bulb from the socket by turning it anticlockwise while pressing in.

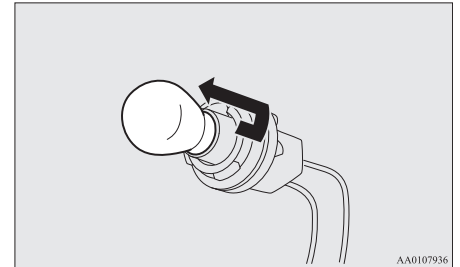

6. To install the bulb, perform the removal steps in reverse.

NOTE

- When mounting the lamp unit, align the notch (G) and pin (H) on the lamp unit with the clip (I) and hole (J) in the body.

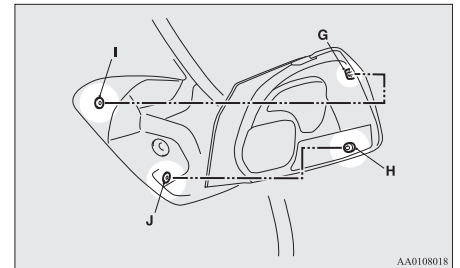

Maintenance

High-mounted stop lamp (bulb type)* E01004500665

1. Open the tailgate.
(Refer to "Tailgate" on page 1-14)
2. Insert a straight blade (or minus) screwdriver with a cloth over its tip at the edge of the cover and pry gently to remove the cover (A).

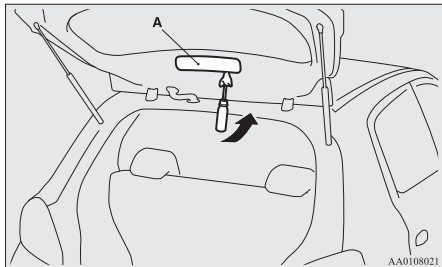

3. Push the 4 hooks (B) and remove the lamp unit. (Close the tailgate to cause the lamp unit to come out.)

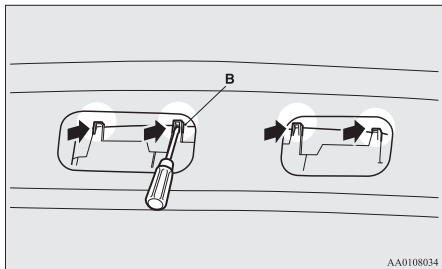

4. Gently close the tailgate, remove the lamp unit, and turn the socket anticlockwise to remove it.

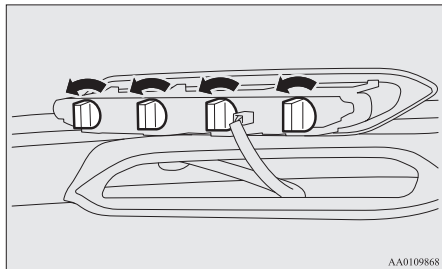

5. Pull the bulb out of the socket.

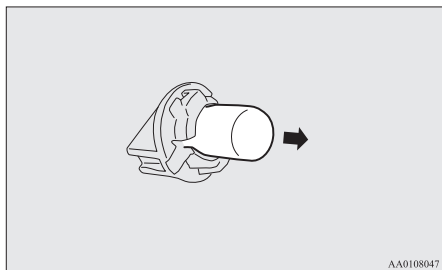

6. To install the bulb, perform the removal steps in reverse.

Licence plate lamps

E01004601012

1. Push the lens (A) towards the rear of the vehicle to remove it.

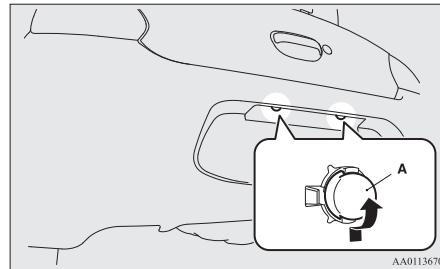

2. Pull the bulb out of the lamp unit.

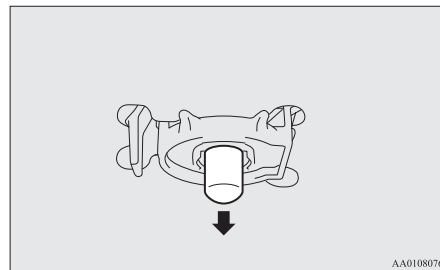

3. To install the bulb, perform the removal steps in reverse.

Masking the headlamps

E01011600059

When entering a country in which vehicles are driven on the opposite side of the road to the country in which your vehicles is supplied, necessary measures have to be taken to avoid dazzling oncoming traffic.

Mask the headlamps according to the next procedure.

1. Turn the headlamp off and wait until the headlamps got cold.
2. According to the illustrations, prepare the sticker (A) to stick the headlamp surface of right and left.

NOTE

- Use a sticker with a light blocking effect enough.
Using of a sticker without a light blocking effect will not acquire a blocking effect.
3. Seeing from the headlamp front, position (C) of the sticker and the central mark (B) of the headlamp and stick a sticker along the vertical dotted line.

NOTE

- Align the vertical dotted line with the line of the reflector in the headlamp.

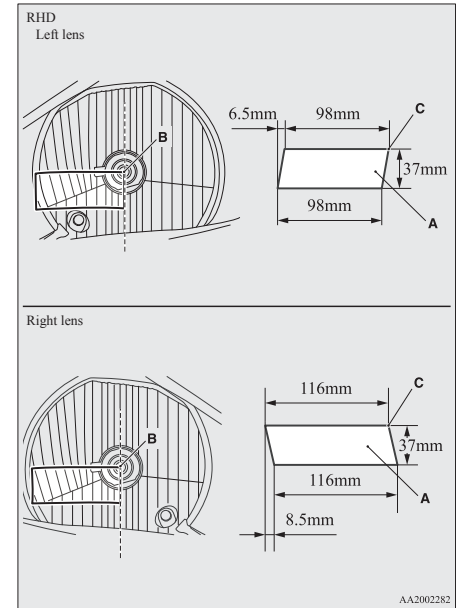
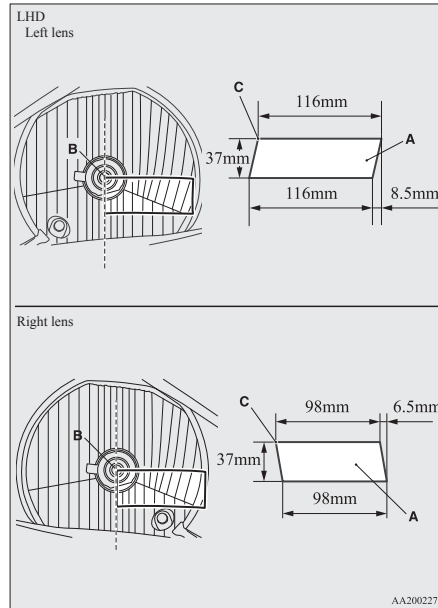

A series of 15 horizontal dashed lines spanning the width of the page, providing a template for writing.

Specifications

Vehicle labeling.....	9-02
Vehicle dimensions.....	9-03
Vehicle performance.....	9-05
Vehicle weight.....	9-06
Engine specifications.....	9-08
Electrical system.....	9-09
Tyres and wheels.....	9-10
Clutch pedal.....	9-11
Fuel consumption.....	9-12
Refill capacities.....	9-13

Specifications

Vehicle labeling

E01100103375

Vehicle identification number

The vehicle identification number is stamped on the bulkhead as shown in the illustration.

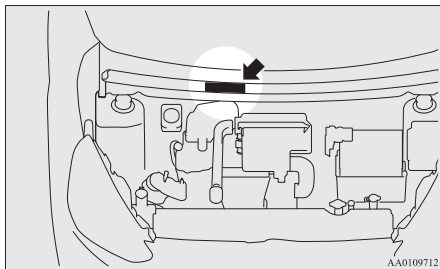

Vehicle information code plate

The vehicle information code plate is located as shown in the illustrations.

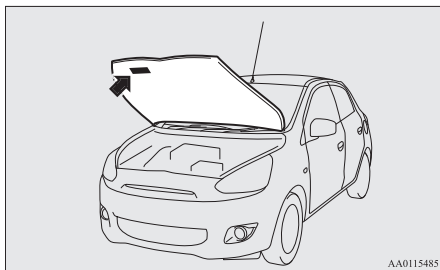

Please use this number when ordering replacement parts.

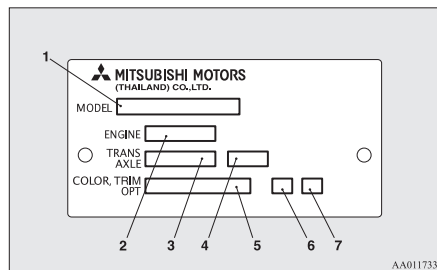

- 1- Model code
- 2- Engine model code
- 3- Transmission model code
- 4- Final gear ratio
- 5- Body colour code
- 6- Interior code
- 7- Option code

Vehicle identification number plate (RHD vehicles only)

The vehicle identification number is stamped on the plate riveted to the left front corner of the vehicle body. It is visible from outside of the vehicle through the windscreen.

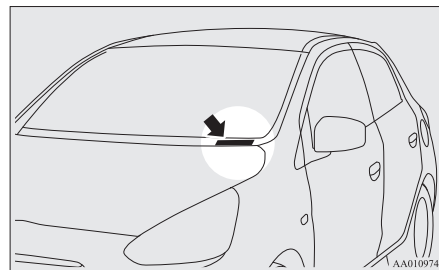

Engine number

The engine number is stamped on the engine cylinder block as shown in the illustration.

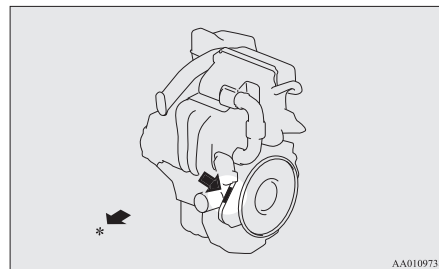

*: Front of the vehicle

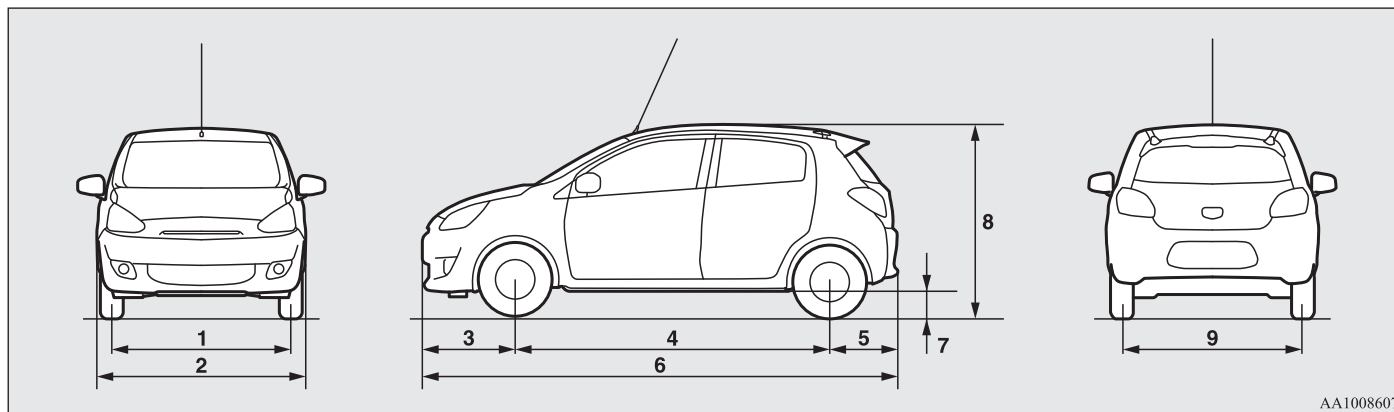
Vehicle dimensions

1	Front track	1,430 mm
2	Overall width	1,665 mm
3	Front overhang	730 mm
4	Wheel base	2,450 mm
5	Rear overhang	530 mm
6	Overall length	3,710 mm
7	Ground clearance (unladen)	150 mm
8	Overall height (unladen)	1,490 mm
9	Rear track	1,415 mm

Minimum turning radius

Body	4.9 m
------	-------

Specifications

Wheel	4.6 m
-------	-------

Vehicle performance

E01100302572

Maximum speed	1000 models		172 km/h
	1200 models	M/T	180 km/h
		CVT	173 km/h

Vehicle weight

E01100405721

1000 models

Kerb weight	Without optional parts	845 kg
	With full optional parts	897 kg
Maximum gross vehicle weight		1,290 kg
Maximum axle weight	Front	730 kg
	Rear	670 kg
Maximum roof load		50 kg
Seating capacity		5 persons

1200 models

Item		M/T	A/T
Kerb weight	Without optional parts	845 kg	865 kg
	With full optional parts	925 kg	955 kg
Maximum gross vehicle weight		1,340 kg, 1,370 kg*	1,370 kg, 1,400 kg*
Maximum axle weight	Front	730 kg	
	Rear	670 kg, 700 kg*	
Maximum towable weight	With brake	200 kg	
	Without brake	100 kg	
Maximum trailer-nose weight		25 kg	
Maximum roof load		50 kg	
Seating capacity		5 persons	

*: In case of trailer towing

NOTE

- Trailer specifications indicate the manufacturer's recommendation.

Engine specifications

E01100602937

Item	1000 models	1200 models
Engine model	3A90	3A92
No. of cylinders	3 in line	3 in line
Total displacement	999 cc	1,193 cc
Bore	75.0 mm	75.0 mm
Stroke	75.4 mm	90.0 mm
Camshaft	Double overhead	Double overhead
Mixture preparation	Electronic injection	Electronic injection
Maximum output (ECC net)	52 kW/6,000 r/min	59 kW/6,000 r/min
Maximum torque (ECC net)	88 Nm/5,000 r/min	106 Nm/4,000 r/min

Electrical system

E01100802740

Voltage		12 V
Battery	Type (JIS)	80D23L, Q-85*
	Capacity (5HR)	59 Ah, 55 Ah*
Alternator capacity		95 A
Spark plug type	NGK	DILFR6A11

*: Vehicles equipped with Auto Stop & Go (AS&G) system

NOTE

- For vehicles equipped with the Auto Stop & Go (AS&G) system, contact a MITSUBISHI MOTORS Authorized Service Point when replacing the battery.

Tyres and wheels

E01100903201

Tyre		165/65R14 79S	175/55R15 77V
Wheel	Size	14x4 1/2J	15x5 J
	Offset	46 mm	

NOTE

- Contact your MITSUBISHI MOTORS Authorized Service Point for details on the combination used on your vehicle.

Clutch pedal

E01102000029

Free play	11 to 16 mm
-----------	-------------

NOTE

- Have the clutch pedal adjusted at a MITSUBISHI MOTORS Authorized Service Point.

Fuel consumption

E01101100788

Item			Combined		Urban conditions	Extra-urban conditions
			CO ² (g/km)	Fuel consumption (L/100 km)	Fuel consumption (L/100 km)	Fuel consumption (L/100 km)
1000 models			96, 92*	4.2, 4.0*	5.0, 4.6*	3.6, 3.6*
1200 models	M/T	Vehicle with 14 inch tyres	100, 96*	4.3, 4.1*	5.2, 4.8*	3.8, 3.7*
		Vehicle with 15 inch tyres	104, 100*	4.5, 4.3*	5.3, 5.0*	4.0, 3.9*
	CVT	Vehicle with 14 inch tyres	100, 95*	4.3, 4.1*	5.1, 4.6*	3.8, 3.8*
		Vehicle with 15 inch tyres	107, 101*	4.6, 4.4*	5.5, 4.9*	4.1, 4.0*

*: Vehicles equipped with Auto Stop & Go (AS&G) system

NOTE

- The results given do not express or imply any guarantee of the fuel consumption of the particular vehicle. The vehicle itself has not been tested and there are inevitably differences between individual vehicles of the same model. In addition, this vehicle may incorporate particular modifications. Furthermore, the driver's style and road and traffic conditions, as well as the extent to which the vehicle has been driven and the standard of maintenance, will all affect its fuel consumption.

Refill capacities

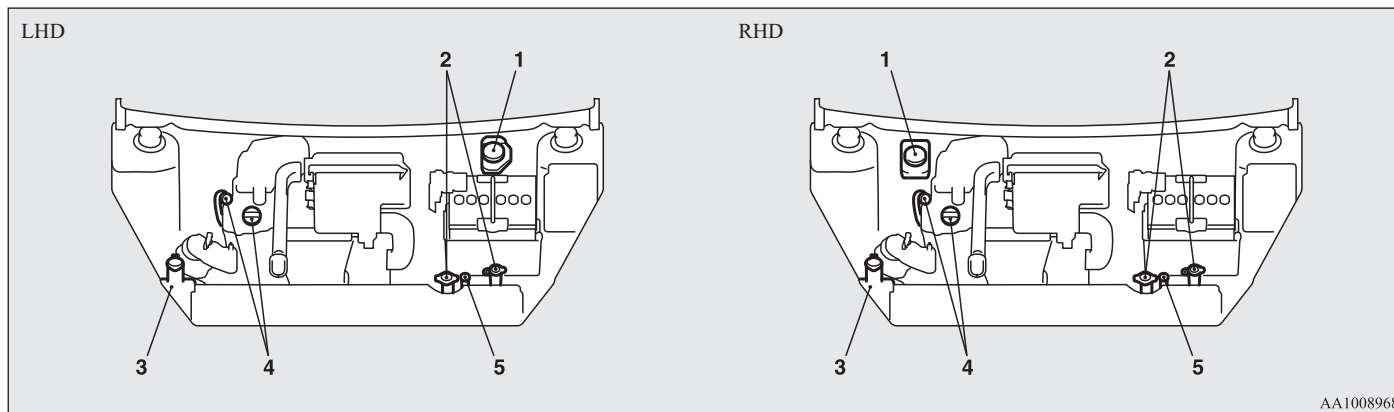

AA1008968

No.	Item		Quantity	Lubricants
1	Brake fluid		As required	Brake fluid DOT 3 or DOT 4
2	Engine coolant	M/T	4.0 litres* ¹	MITSUBISHI MOTORS GENUINE SUPER LONG LIFE COOLANT PREMIUM or equivalent* ²
		CVT	4.6 litres* ¹	
3	Washer fluid		2.5 litres	—
4	Engine oil	Oil pan	2.8 litres	Refer to page 8-05.
		Oil filter	0.2 litre	
5	CVT fluid		7.0 litres	MITSUBISHI MOTORS GENUINE CVTF-J4

*1: Includes 0.5 litre in the reservoir

*2: Similar high quality ethylene glycol based non-silicate, non-amine, non-nitrate and non-borate coolant with long life hybrid organic acid technology

*3: Optional equipment

Specifications

No.	Item	Quantity	Lubricants
6	Manual transmission oil	1.6 litres	MITSUBISHI MOTORS GENUINE NEW MULTI GEAR OIL ECO API classification GL-4, SAE 75W-80
7	Refrigerant (air conditioning ^{*3})	250-290 g	HFO-1234yf

*1: Includes 0.5 litre in the reservoir

*2: Similar high quality ethylene glycol based non-silicate, non-amine, non-nitrate and non-borate coolant with long life hybrid organic acid technology

*3: Optional equipment

A

- Accessory (Installation) 04
- Accessory socket 5-35
- Active stability control (ASC) 4-30
- Air conditioning
 - Automatic air conditioning 5-06
 - Heater 5-03
 - Important operation tips for the air conditioning 5-12
 - Manual air conditioning 5-03
- Air purifier 5-13
- Airbag 2-17
 - Caution for installing the child restraint on vehicles with a front passenger airbag 2-09,2-18
 - Front passenger's airbag OFF indication lamp 2-19
 - Front passenger's airbag ON-OFF switch 2-19
- Antenna 5-30
- Anti-lock brake system (ABS) 4-28
 - Warning lamp 4-29
- Assist grip 5-39
- Audio
 - Error codes 5-27
 - Handling of compact discs 5-29
 - LW/MW/FM electronic tuning radio with CD player 5-13
- Auto Stop & Go (AS&G) system 4-15
- Automatic air conditioning 5-06
- Automatic transmission
 - Selector lever operation 15,4-21
 - Selector lever positions 4-22

B

- Battery 8-08
 - Charge warning lamp 3-13
 - Discharged battery (Emergency starting) 6-02

- Disposal information for used batteries 05
- Specification 9-09
- Bonnet 8-04
- Bottle holder 5-38
- Brake assist system 4-27
- Brake
 - Anti-lock brake 4-28
 - Braking 4-25
 - Fluid 8-07,9-13
 - Parking brake 4-04
 - Warning lamp 3-12
- Bulb capacity 8-20

C

- Capacities 9-13
- Card holder 5-34
- Cargo loads 4-34
- Catalytic converter 8-03
- Central door locks 1-13
- Charge warning lamp 3-13
- Check engine warning lamp 3-12
- Child restraint 2-09
 - Caution for installing the child restraint on vehicles with a front passenger airbag 2-09,2-18
- Child-protection rear doors 1-14
- Cleaning
 - Exterior of your vehicle 7-03
 - Interior of your vehicle 7-02
- Combination headlamps and dipper switch 3-14
- Compact spare wheel 6-12
- Convenient hook 5-39
- Coolant 9-13
- Coolant (engine) 8-06
- Cup holder 5-37

D

- Daytime running lamps

- Bulb capacity 8-20
 - Replacement 8-22
- Demister (rear window) 3-23
- Dimensions 9-03
- Dipper (High/Low beam change) 3-16
- Door ajar warning lamp 3-14
- Doors
 - Central door locks 1-13
 - Child-protection 1-14
 - Lock and unlock 1-12
- Driving, alcohol and drugs 4-02

E

- Economical driving 4-02
- Electric power steering system (EPS) 4-30
- Electric window control 1-15
- Electrical system 9-09
- Electronic immobilizer (Anti-theft starting system) 1-03
- Emergency starting 6-02
- Emergency stop signal system 4-28
- Engine specifications 9-08
- Engine switch 4-09
- Engine
 - Coolant 8-06
 - Number 9-02
 - Oil 8-05
 - Oil and oil filter 9-13
 - Overheating 6-04
 - Specifications 9-08
 - Used engine oils safety instructions and disposal information 05
- Error codes 5-27
- Exterior and interior lamp operation 8-14

F

- Fluid capacities and lubricants 9-13

Alphabetical index

Fluid

- Automatic transmission fluid 9-13
- Brake fluid 8-07,9-13
- Engine coolant 8-06
- Washer fluid 8-07,9-13

Front fog lamps

- Bulb capacity 8-20
- Indication lamp 3-11
- Replacement 8-22
- Switch 3-18

Front passenger's airbag ON-OFF switch 2-19

Front seat 2-02

Front turn-signal lamps

- Bulb capacity 8-20
- Replacement 8-21

Frozen road warning 3-05

Fuel consumption 9-12

Fuel remaining warning display 3-06

Fuel

- Filling the fuel tank 02
- Fuel remaining display 3-06
- Fuel remaining warning display 3-06
- Fuel selection 02
- Modification/alterations to the electrical systems 04
- Tank capacity 03

Fuses 8-15

Fusible links 8-15

G

- Garage jack up position 8-03
- General maintenance 8-14
- General vehicle data 9-03
- Genuine parts 05
- Glove box 5-36

H

Hazard warning flasher switch 3-18

Hazard warning indication lamps 3-11

Head restraints 2-04

Headlamp levelling switch 3-16

Headlamps

- Bulb capacity 8-20
- Headlamp flasher 3-16
- Replacement 8-21
- Switch 3-14

Heated mirror 4-07

Heated seats 2-03

Heater 5-03

High coolant temperature warning lamp 3-13

High-beam indication lamp 3-11

High-mounted stop lamp

- Bulb capacity 8-20
- Replacement 8-24

Hill start assist 4-26

Hinges and latches lubrication 8-15

Horn switch 3-24

I

If the vehicle breaks down 6-02

Ignition switch 4-08

Indication and warning lamps 17,3-10

Indication lamps 3-11

Information display 3-03

Inside rear-view mirror 4-06

Instruments 3-02

Interior lamps 5-35

J

Jack 6-05

- Storage 6-05

Jump starting (Emergency starting) 6-02

K

Keyless entry system 1-03

Keyless operation system 1-04

Keys 1-02

L

Labeling 9-02

Lamp monitor buzzer 3-16

Leakage (Fuel, engine coolant, oil and exhaust gas) 8-14

Licence plate lamps

- Bulb capacity 8-20
- Replacement 8-24

Link System 5-31

Lock and unlock the doors and tailgate 11

Lubricants 9-13

Luggage room lamp 5-36

- Bulb capacity 8-21

LW/MW/FM electronic tuning radio with CD player 5-13

M

Manual air conditioning 5-03

Manual transmission 4-19

Manual window control 1-15

Masking the headlamps 8-25

Meter illumination control 3-04

Mirror

- Inside rear-view mirror 4-06
- Outside rear-view mirrors 4-07

Modification/alterations to the electrical systems 04

Multi-information display 3-02

O

- Oil pressure warning lamp 3-13
- Oil
 - Engine oil 8-05
 - High coolant temperature warning lamp 3-13
- Operation under adverse driving conditions 6-20
- Outside rear-view mirrors 4-07
- Overheating 6-04

P

- Parking 4-05
 - Parking brake 4-04
- Position lamps
 - Bulb capacity 8-20
 - Replacement 8-21
- Precautions to observe when using wipers and washers 3-22
- Pregnant women restraint 2-08
- Puncture (Tyre changing) 6-11
- Puncture
 - Tyre repair kit 6-06

R

- Radio
 - LW/MW/FM electronic tuning radio with CD player 5-13
- Rear fog lamp
 - Bulb capacity 8-20
 - Indication lamp 3-11
 - Switch 3-18
- Rear seat 2-03
- Rear shelf panel 5-38
- Rear turn-signal lamps
 - Bulb capacity 8-20
 - Replacement 8-21,8-23

- Rear window demister switch 3-23
- Rear-view camera 4-32
- Rear-view mirror
 - Inside 4-06
 - Outside 4-07
- Replacement of lamp bulbs 8-19
- Reversing lamps
 - Bulb capacity 8-20
 - Replacement 8-23
- Roof carrier precaution 4-35
- Room lamp 5-35
 - Bulb capacity 8-21
- Running-in recommendations 4-03

S

- Safe driving techniques 4-03
- Seat belt 2-05
 - Adjustable seat belt anchor 2-07
 - Child restraint 2-09
 - Force limiter 2-08
 - Inspection 2-17
 - Pregnant women restraint 2-08
 - Pre-tensioner 2-08
- Seat
 - Adjustment 2-02
 - Front seat 2-02
 - Heated seats 2-03
 - Rear seat 2-03
- Seats
 - Head restraints 2-04
- Service precaution 8-02
- Side turn-signal lamps
 - Bulb capacity 8-20
 - Replacement 8-23
- Snow traction device (Tyre chains) 8-12
- Snow tyres 8-12
- Spark plug 9-09
- Specifications 9-02

- Starting 4-12
- Steering
 - Steering wheel height adjustment 4-06
 - Steering wheel lock 4-11
- Stop and tail lamps
 - Bulb capacity 8-20
 - Replacement 8-23
- Storage spaces 5-36
- Sun visors 5-34
- Supplemental restraint system 2-17
 - Caution for installing the child restraint on vehicles with a front passenger airbag 2-09,2-18
 - How the Supplemental Restraint System works 2-17
 - Servicing 2-26
 - Warning lamp 2-25

T

- Tailgate 1-14
- Tank capacity 03
- Tools 6-05
 - Storage 6-05
- Towing 6-17
- Trailer towing 4-35
- Transmission
 - Automatic transmission 15,4-21
 - Fluid 9-13
 - Manual transmission 4-19
- Turn-signal indication lamps 3-11
- Turn-signal lever 3-17
- Tyre repair kit 6-06
- Tyres 8-09
 - How to change a tyre 6-11
 - Inflation pressures 8-10
 - Size (tyre and wheel) 9-10
 - Snow traction device (Tyre chains) 8-12
 - Snow tyres 8-12
 - Spare wheel information 6-12

Alphabetical index

Tyre repair kit 6-06
Tyre rotation 8-11
Wheel condition 8-11

U

USB input terminal 5-31
Used engine oils safety instructions and disposal information 05

V

Vanity mirror 5-34
Vehicle care precautions 7-02
Vehicle dimensions 9-03
Vehicle identification number 9-02
Vehicle information code plate 9-02
Vehicle labeling 9-02
Vehicle performance 9-05
Vehicle weight 9-06
Ventilators 5-02

W

Washer
 Fluid 8-07,9-13
 Switch 3-19,3-22
Washing 7-03
Waxing 7-04
Weight 9-06
Wheel condition 8-11
Wheel
 Covers 6-16
 Specification 9-10
Wiper
 Rear window 3-22
 Windscreen 3-19
 Wiper blades 8-13

OMRON

OMRON Automotive Electronics Co. Ltd.

6368 NENJO-ZAKA, OKUSA, KOMAKI-CITY,
AICHI, 485-0802, JAPAN
PHONE:+81-568-78-6150
FAX :+81-568-78-7659**DECLARATION of CONFORMITY**

We, **OMRON Automotive Electronics Co. Ltd.**, hereby declare, at our sole responsibility, that the following product conforms to the Essential Requirements of the Radio and Telecommunications Terminal Equipment Directive 1999/5/EC in accordance with the tests conducted to the appropriate requirements of the relevant standards, as listed herewith.

Product

Model/ Type Number

: Receiver and immobilizer / Transmitter / FOB / KOS
 : Receiver and immobilizer : G8C-930M, G8C-931M, G8C-932M
 : Transmitter : G8D-571M-A
 : FOB : G8D-644M-KEY-E
 : KOS : GGM-M002

Directive and Standards used : as appropriate :

Model	Standard used for comply
G8C-930M	EN 60065:2002 + Amd.1: 2006 + Amd.11:2008 + Amd.2:2010+Amd.12:2011
G8C-931M	EN 301 489-1 V1.8.1:2008-04
G8C-932M	EN 301 489-3 V1.4.1:2002-08 EN 300 220-1 V2.1.1:2007-04 EN 300 220-2 V2.1.2:2007-06 EN 300 330-1 V1.7.1:2010-02 EN 300 330-2 V1.5.1:2010-02
G8D-571M-A	EN 60065: 2002 + Amd.1: 2006 + Amd.11: 2008 + Amd.2:2010+Amd.12:2011
G8D-644M-KEY-E	EN 301 489-1 V1.8.1:2008-04 EN 301 489-3 V1.4.1:2002-08 EN 300 220-1 V2.1.1:2006-04 EN 300 220-2 V2.1.2:2007-06 EN 300 330-1 V1.7.1:2010-02 EN 300 330-2 V1.5.1:2010-02
GGM-M002	EN60065:2002+Amd.1:2006+Amd.11:2008+Amd.2:2010+Amd.12:2011 EN301 489-1 V1.8.1:2008 EN301 489-3 V1.4.1:2002 EN300 330-1 V1.7.1:2010 EN300 330-2 V1.5.1:2010 EN300 220-1 V2.1.1:2006 EN300 220-2 V2.1.2:2007 EN 60065: 2002 + Amd.1: 2006 + Amd.11: 2008 + Amd.2:2010 + Amd.12:2011 EN 301 489-1 V1.8.1:2008-04 EN 301 489-3 V1.4.1:2002-08 EN 300 220-1 V2.1.1:2007-04 EN 300 220-2 V2.1.2:2007-06 EN 300 330-1 V1.7.1:2010-02 EN 300 330-2 V1.5.1:2010-02

Receiver Category of this radio equipment is Category 3, which is referred to EN 300 220-1.

Signature

: *Shinya Takenouchi*

Name

: Shinya Takenouchi

Title and position

: Manager

Date

: October 25, 2012

Development & Design Division



[Czech]	OMRON Automotive Electronics Co. Ltd. limito prohlásuje, že tento [G8D-571M-A*, G8D-644M-KEY-E*, GGM-M002*, G8C-930M*, G8C-932M*] je ve shodě se zákadními požadavky a dalšími příslušnými ustanoveními směrnic 1989/5/ES.
[Danish]	Underleggende OMRON Automotive Electronics Co. Ltd. erklærer herved, at følgende udstyr [G8D-571M-A*, G8D-644M-KEY-E*, GGM-M002*, G8C-930M*, G8C-932M*] overholder de væsentligste krav og øvrige relevante krav i direktiv 1989/5/EF.
[German]	Hiermit erkläre OMRON Automotive Electronics Co. Ltd., dass sich das Gerät [G8D-571M-A*, G8D-644M-KEY-E*, GGM-M002*, G8C-930M*, G8C-932M*] in Übereinstimmung mit den grundlegenden Anforderungen und der übrigen einschlägigen Bestimmungen der Richtlinie 1989/5/EG befindet.
[Estonian]	Kaebeldavaga kinnitab OMRON Automotive Electronics Co. Ltd. seadme [G8D-571M-A*, G8D-644M-KEY-E*, GGM-M002*, G8C-930M*, G8C-932M*] vastavalt direktiivi 1989/5/EÜ põhinõuetele ja nimetatud direktiivi tulenevatele teistele asjakohastele sätetele.
[English]	Hereby, OMRON Automotive Electronics Co. Ltd. declares that this [G8D-571M-A*, G8D-644M-KEY-E*, GGM-M002*, G8C-930M*, G8C-932M*] is in compliance with the essential requirements and other relevant provisions of Directive 1989/5/EC.
[Spanish]	Por medio de la presente OMRON Automotive Electronics Co. Ltd. declara que el [G8D-571M-A*, G8D-644M-KEY-E*, GGM-M002*, G8C-930M*, G8C-932M*] cumple con los requisitos esenciales y cualesquiera otras disposiciones aplicadas o exigidas de la Directiva 1989/5/CE.
[Greek]	ΜΕ ΤΗΝ ΠΑΡΟΥΣΙΑ ΟΜΡΟΝ Automotive Electronics Co. Ltd. ΔΗΛΩΝΕΙ ΟΤΙ [G8D-571M-A*, G8D-644M-KEY-E*, GGM-M002*, G8C-930M*, G8C-932M*] ΣΥΜΠΟΝΟΥΝΕΙ ΤΙΣ ΤΙΣ ΟΥΣΙΩΔΕΙΣ ΑΠΑΙΤΗΣΕΙΣ ΚΑΙ ΤΙΣ ΑΝΙΣΤΕΙ ΣΥΝΕΤΕΡΕΣ ΔΙΑΤΑΞΕΙΣ ΤΗΣ ΟΔΗΓΙΑΣ 1989/5/ΕΚ.
[French]	Par la présente OMRON Automotive Electronics Co. Ltd. déclare que l'appareil [G8D-571M-A*, G8D-644M-KEY-E*, GGM-M002*, G8C-930M*, G8C-932M*] est conforme aux exigences essentielles et aux autres dispositions pertinentes de la directive 1989/5/CE.
[Italian]	Con la presente OMRON Automotive Electronics Co. Ltd. dichiara che questo [G8D-571M-A*, G8D-644M-KEY-E*, GGM-M002*, G8C-930M*, G8C-932M*] è conforme ai requisiti essenziali ed alle altre disposizioni pertinenti stabilite dalla direttiva 1989/5/CE.
[Latvian]	Ar šo OMRON Automotive Electronics Co. Ltd. deklarā, ka [G8D-571M-A*, G8D-644M-KEY-E*, GGM-M002*, G8C-930M*, G8C-932M*] atbilst Direktīvas 1989/5/EK būtiskajām prasībām un citiem ar to saistītajiem noteikumiem.
[Lithuanian]	Šiuo OMRON Automotive Electronics Co. Ltd. deklaruojama, kad šis [G8D-571M-A*, G8D-644M-KEY-E*, GGM-M002*, G8C-930M*, G8C-932M*] atitinka esminius reikalavimus ir kitas 1989/5/EB Direktyvos nuostatas.
[Dutch]	Hierbij verklaart OMRON Automotive Electronics Co. Ltd. dat het toestel [G8D-571M-A*, G8D-644M-KEY-E*, GGM-M002*, G8C-930M*, G8C-932M*] in overeenstemming is met de essentiële eisen en de andere relevante bepalingen van richtlijn 1989/5/EG.
[Maltese]	Hawnhekk, OMRON Automotive Electronics Co. Ltd., jidherli jara li dan [G8D-571M-A*, G8D-644M-KEY-E*, GGM-M002*, G8C-930M*, G8C-932M*], jikkonforma mal-hiġġiet essenzjali u ma provvedimmi oħrajn rilevanti li hemm fi-Direttiva 1989/5/EC.
[Hungarian]	Aulattal nyilatko OMRON Automotive Electronics Co. Ltd. nyilatkozom, hogy a [G8D-571M-A*, G8D-644M-KEY-E*, GGM-M002*, G8C-930M*, G8C-932M*] megfelel a vonatkozó alapvető követelményeknek és az 1989/5/EC irányelv egyéb előírásainak.
[Polish]	[OMRON Automotive Electronics Co. Ltd.] niniejszym oświadcza, że [G8D-571M-A*, G8D-644M-KEY-E*, GGM-M002*, G8C-930M*, G8C-932M*] spełnia zasadnicze wymogi oraz inne istotne postanowienia dyrektywy 1989/5/EC.
[Portuguese]	OMRON Automotive Electronics Co. Ltd. declara que este [G8D-571M-A*, G8D-644M-KEY-E*, GGM-M002*, G8C-930M*, G8C-932M*] está conforme com os requisitos essenciais e outras disposições da Directiva 1989/5/CE.
[Slovenian]	OMRON Automotive Electronics Co. Ltd. izjavlja, da je ta [G8D-571M-A*, G8D-644M-KEY-E*, GGM-M002*, G8C-930M*, G8C-932M*] v skladu z bistvenimi zahtevami in ostalimi relevantnimi določili direktive 1989/5/ES.
[Slovak]	OMRON Automotive Electronics Co. Ltd. týmto vyhlasuje, že [G8D-571M-A*, G8D-644M-KEY-E*, GGM-M002*, G8C-930M*, G8C-932M*] spĺňa základné požiadavky a všetky príslušné ustanovenia Smernice 1989/5/ES.
[Finnish]	OMRON Automotive Electronics Co. Ltd. vakuuttaa täten että [G8D-571M-A*, G8D-644M-KEY-E*, GGM-M002*, G8C-930M*, G8C-932M*] täyttää sen perusteella annetut olennaiset vaatimukset ja sillä koskevat direktiivin muuten ehtoin mukautet.
[Swedish]	Härmed intygar OMRON Automotive Electronics Co. Ltd. att denna [G8D-571M-A*, G8D-644M-KEY-E*, GGM-M002*, G8C-930M*, G8C-932M*] står i överensstämmelse med de väsentliga egenskapskrav och övriga relevanta bestämmelser som framgår av direktiv 1989/5/EG.
[Icelandic]	Hér með lýsir OMRON Automotive Electronics Co. Ltd. yfir því að [G8D-571M-A*, G8D-644M-KEY-E*, GGM-M002*, G8C-930M*, G8C-932M*] er í samræmi við grunnkröfur og aðrar kröfur, sem gerar eru í tilskipun 1989/5/EC.
[Norwegian]	OMRON Automotive Electronics Co. Ltd. erklærer herved at utstyret [G8D-571M-A*, G8D-644M-KEY-E*, GGM-M002*, G8C-930M*, G8C-932M*] er i samsvar med de grunnleggende krav og øvrige relevante krav i direktiv 1989/5/EF.
[Turkish]	İşbu belge ile OMRON Automotive Electronics Co. Ltd. bu [G8D-571M-A*, G8D-644M-KEY-E*, GGM-M002*, G8C-930M*, G8C-932M*] için 1989/5/EC Yönetmeliği esas gereksinimleri ve diğer şartlarına uygun olduğunu beyan eder.
[Romania]	.Noi OMRON Automotive Electronics Co. Ltd. declarăm că aparatul [G8D-571M-A*, G8D-644M-KEY-E*, GGM-M002*, G8C-930M*, G8C-932M*] este în conformitate cu cerințele esențiale și cu alte prevederi relevante ale Hotărârii Guvernului nr. 88/2003 și Directivei 1989/5/EC.

[Bulgarian]	С настоящия документ OMRON Automotive Electronics Co. Ltd. декларира, че[G8D-571M-A*, G8D-644M-KEY-E*, GGM-M002*, G8C-930M*, G8C-932M*] е в съгласие с основните изисквания и съответните постановления на Директивата 1989/5/ЕС.
[Croatian]	Ovime OMRON Automotive Electronics Co. Ltd. izjavljuje da je ovaj G8D-571M-A*, G8D-644M-KEY-E*, GGM-M002*, G8C-930M*, G8C-932M*] sukladan s bitnim zahtjevima i drugim relevantnim odredbama direktive 1989/5/EZ.
[Macedonian]	Со ова OMRON Automotive Electronics Co. Ltd. објавува дека овој [G8D-571M-A*, G8D-644M-KEY-E*, GGM-M002*, G8C-930M*, G8C-932M*] е во согласност со суштинските услови и други релевантни одредби од Директивата 1989/5/ЕЗ.
[Georgian]	ამიტ, OMRON Automotive Electronics Co. Ltd., აცხადებს, რომ არჩეული [G8D-571M-A*, G8D-644M-KEY-E*, GGM-M002*, G8C-930M*, G8C-932M*] შესაბამება 1989/5/ЕС დირექტივ გასაზრვნილ ზრითად მოთხოვნებსა და სხვა შესაბამის პრობებს.
[Albanian]	Nepërmet kësaj OMRON Automotive Electronics Co.Ltd., deklaron se kjo [G8D-571M-A*, G8D-644M-KEY-E*, GGM-M002*, G8C-930M*, G8C-932M*] është në përputhje me kërkesat themelore dhe dispozitat e tjera përkatëse të Direktivës 1989/5/EC.
[Montenegrin]	Ovim, OMRON Automotive Electronics Co.Ltd., izjavljuje da je ova [G8D-571M-A*, G8D-644M-KEY-E*, GGM-M002*, G8C-930M*, G8C-932M*] u skladu sa osnovnim zahtjevima i drugim relevantnim odredbama Direktive 1989/5/EZ.

A series of 15 horizontal dashed lines spanning the width of the page, providing a template for writing.

A series of 15 horizontal dashed lines spanning the width of the page, providing a template for handwriting practice.

A series of 15 horizontal dashed lines spanning the width of the page, providing a template for writing.

A series of 15 horizontal dashed lines spanning the width of the page, providing a template for writing.