



OUTLANDER - ENGLISH - OGXE11E1

OUTLANDER - ENGLISH - OGXE11E1

OWNER'S MANUAL



OUTLANDER

## Foreword

E09200102492

Thank you for selecting an OUTLANDER as your new vehicle. This owner's manual will add to your understanding and full enjoyment of the many fine features of this vehicle. It contains information prepared to acquaint you with the proper way to operate and maintain your vehicle for the utmost in driving pleasure.

MITSUBISHI MOTORS Europe B.V. reserves the right to make changes in design and specifications and/or to make additions to or improvements in this product without obligation to install them on products previously manufactured.

It is an absolute requirement for the driver to strictly observe all laws and regulations concerning vehicles.

This owner's manual has been written in compliance with such laws and regulations, but some of the contents may become contradictory with later amendment of the laws and regulations.

Please leave this owner's manual in this vehicle at time of resale. The next owner will appreciate having access to the information contained in this owner's manual.

Repairs to your vehicle:  
Vehicles in the warranty period:  
All warranty repairs must be carried out by a MITSUBISHI MOTORS Authorized Service Point.

Vehicles outside the warranty period:  
Where the vehicle is repaired is at the discretion of the owner.

Throughout this owner's manual the words **WARNING** and **CAUTION** appear. These serve as reminders to be especially careful. Failure to follow instructions could result in personal injury or damage to your vehicle.

### **WARNING**

**indicates a strong possibility of severe personal injury or death if instructions are not followed.**

### **CAUTION**

**means hazards or unsafe practices that could cause minor personal injury or damage to your vehicle.**

You will see another important symbol:

**NOTE: gives helpful information.**

**\*: indicates optional equipment.**

It may differ according to the sales classification; refer to the sales catalogue.

Abbreviations used in this owner's manual:

**LHD: Left-Hand Drive**

**RHD: Right-Hand Drive**

**M/T: Manual Transmission**

**A/T: Automatic Transmission**

**CVT: Continuously Variable Transmission**

## Information for station service

E09300102464

	Fuel tank capacity	2WD models	63 litres
		4WD models	60 litres
Fuel	Fuel requirements	<b>Petrol-powered vehicles</b> Unleaded petrol octane number (EN228) 2000 models, 2400 models (except for Clear Tec FFV), 3000 models 95 RON or higher 2400 models (Clear Tec FFV) 95 RON or higher, or Bio ethanol E 85 <b>Diesel-powered vehicles</b> Cetane number (EN590) 51 or higher Refer to the "General information" section for the fuel selection.	
Engine oil		Refer to the "Maintenance" section for the selection of engine oil.	
Tyre inflation pressure		Refer to the "Maintenance" section for the tyre inflation pressure.	

### **CAUTION**

- **Your vehicle is designed to use only diesel fuel that meets the EN590 standard. Use of any other type of diesel fuel can adversely affect the engine.**

**Mitsubishi Motors Europe B.V.**

© 2010 Mitsubishi Motors Corporation

**OGXE11E1**  
BLC10.002831

**11**

## *Table of contents*

<i>Overview</i>	
<i>General information</i>	
<i>Locking and unlocking</i>	1
<i>Seats and seat belts</i>	2
<i>Instruments and controls</i>	3
<i>Starting and driving</i>	4
<i>For pleasant driving</i>	5
<i>For emergencies</i>	6
<i>Vehicle care</i>	7
<i>Maintenance</i>	8
<i>Specifications</i>	9

## Instruments and controls

E00100105675

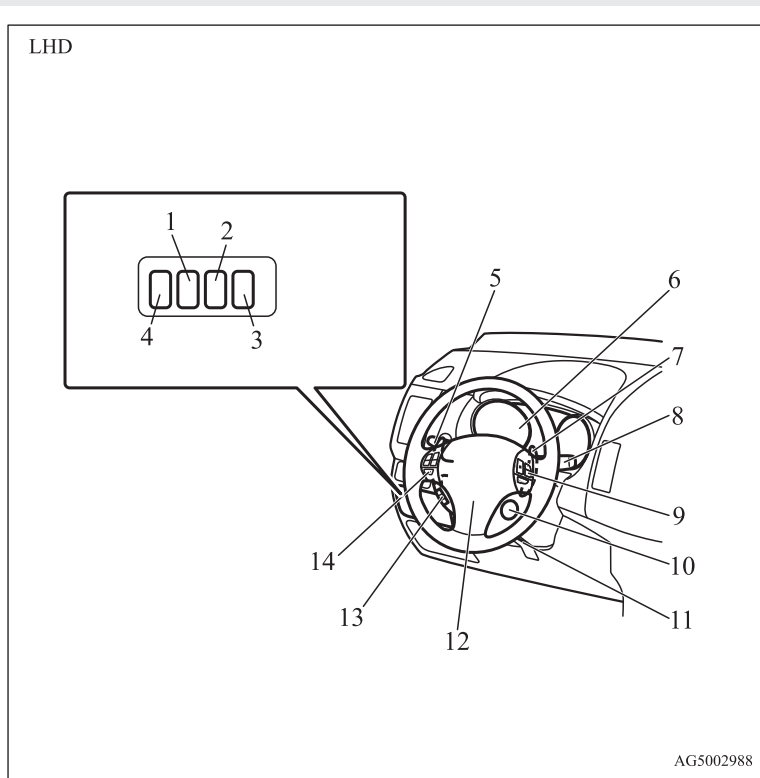

1. Active stability control (ASC) OFF switch\* p. 4-58
2. Sonar switch\* p. 4-66
3. Adaptive Front lighting System (AFS) OFF Switch\* p. 3-49
4. Headlamp levelling switch\* p. 3-46
5. Combination headlamps and dipper switch p. 3-42  
Turn-signal lever p. 3-48  
Front fog lamp switch\* p. 3-50  
Rear fog lamp switch p. 3-51  
Headlamp washer switch\* p. 3-56
6. Instruments p. 3-02
7. Shift paddles\* p. 4-27, 4-33, 4-42
8. Windscreen wiper and washer switch p. 3-51  
Rear window wiper and washer switch p. 3-55
9. Cruise control switch\* p. 4-60
10. Ignition switch p. 1-12, 1-19, 4-12
11. Steering wheel height adjustment lever p. 4-09
12. Supplemental restraint system - airbag (for driver's seat) p. 2-31, 2-35  
Horn switch p. 3-57
13. Bluetooth® 2.0 interface\* p. 5-65
14. Steering wheel audio remote control switches\* p. 5-53



RHD

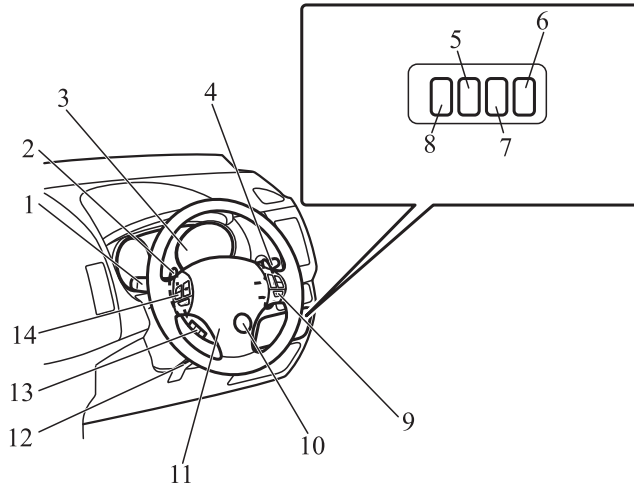

AG5002991

1. Combination headlamps and dipper switch p. 3-42  
Turn-signal lever p. 3-48  
Front fog lamp switch\* p. 3-50  
Rear fog lamp switch p. 3-51  
Headlamp washer switch\* p. 3-56
2. Shift paddles\* p. 4-27, 4-33, 4-42
3. Instruments p. 3-02
4. Windscreen wiper and washer switch p. 3-51  
Rear window wiper and washer switch p. 3-55
5. Sonar switch\* p. 4-66
6. Headlamp levelling switch\* p. 3-46
7. Active stability control (ASC) OFF switch\* p. 4-58
8. Adaptive Front lighting System (AFS) OFF Switch\* p. 3-49
9. Cruise control switch\* p. 4-60
10. Ignition switch p. 1-12, 1-19, 4-12
11. Supplemental restraint system - airbag (for driver's seat) p. 2-31, 2-35  
Horn switch p. 3-57
12. Steering wheel height adjustment lever p. 4-09
13. Bluetooth® 2.0 interface\* p. 5-65
14. Steering wheel audio remote control switches p. 5-53

LHD

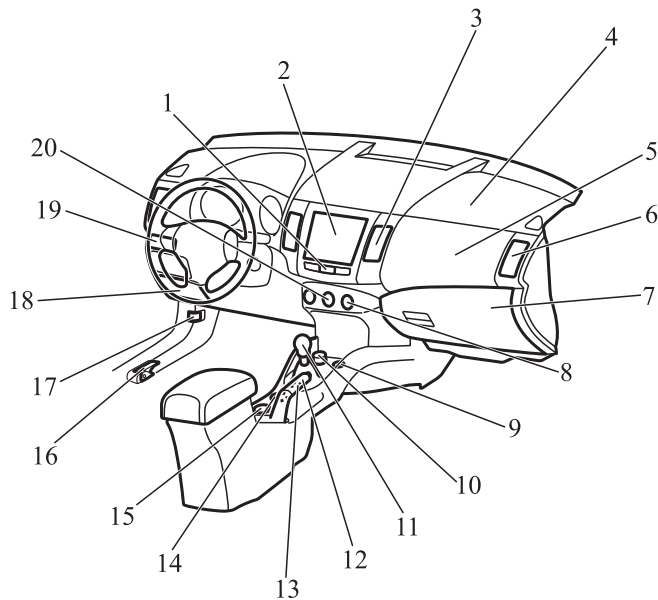

AG5003028

1. Hazard warning flasher switch p. 3-50
2. Digital clock\* p. 5-62  
Audio system\* p. 5-10, 5-24  
MITSUBISHI Multi-Communication System\*
3. Centre ventilators p. 5-02
4. Supplemental restraint system - airbag (for front passenger's seat) p. 2-31, 2-35
5. Upper glove box p. 5-88
6. Side ventilators p. 5-02
7. Lower glove box p. 5-88  
Front passenger's airbag ON-OFF switch p. 2-33
8. Rear window demister switch p. 3-57  
Wiper de-icer switch\* p. 3-56
9. Accessory socket\* p. 5-84  
Cigarette lighter\* p. 5-83
10. Ashtray\* p. 5-83
11. Gearshift or selector lever p. 4-22, 4-25, 4-30, 4-36
12. Parking brake lever p. 4-07
13. Twin Clutch SST control mode switch\* p. 4-40
14. Drive mode selector\* p. 4-46
15. Cup holder p. 5-91
16. Fuel tank filler door release lever p. 03
17. Bonnet release lever p. 8-03
18. Personal box p. 5-90  
Fuse box p. 8-18
19. Built-in cup holder p. 5-91
20. Air conditioning p. 5-04

RHD

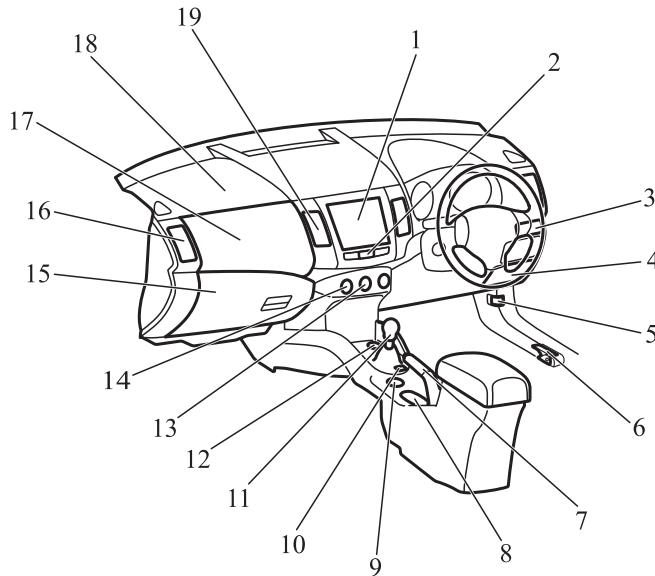

AG5003031

1. Digital clock\* p. 5-62  
Audio system\* p. 5-10, 5-24  
MITSUBISHI Multi-Communication System\*
2. Hazard warning flasher switch p. 3-50
3. Built-in cup holder p. 5-91
4. Personal box p. 5-90
5. Bonnet release lever p. 8-03
6. Fuel tank filler door release lever p. 03
7. Parking brake lever p. 4-07
8. Cup holder p. 5-91
9. Drive mode selector\* p. 4-46
10. Twin Clutch SST control mode switch\* p. 4-40
11. Gearshift or selector lever p. 4-22, 4-25, 4-30, 4-36
12. Accessory socket\* p. 5-84
13. Air conditioning p. 5-04
14. Rear window demister switch p. 3-57
15. Lower glove box p. 5-88  
Front passenger's airbag ON-OFF switch p. 2-33  
Fuse box p. 8-18
16. Side ventilators p. 5-02
17. Upper glove box p. 5-88
18. Supplemental restraint system - airbag (for front passenger's seat) p. 2-31, 2-35
19. Centre ventilators p. 5-02

LHD

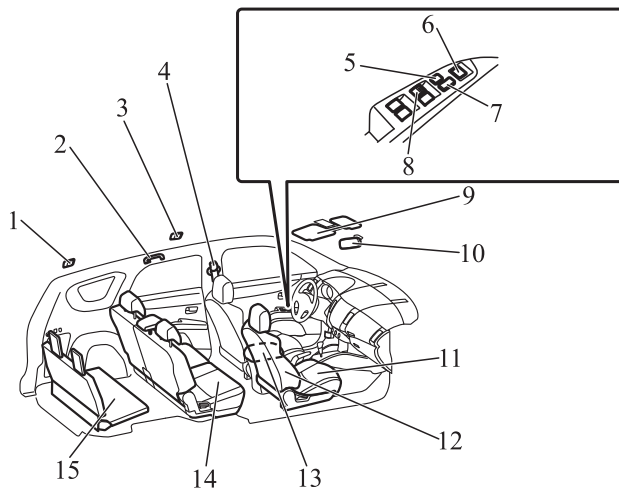

1. Luggage room lamp p. 5-87
2. Assist grip p. 5-94  
Coat hook p. 5-94
3. Room lamp (rear) p. 5-85
4. Adjustable seat belt anchor p. 2-21  
Seat belts p. 2-19
5. Lock switch p. 1-41
6. Electric remote-controlled outside rear-view mirrors switch p. 4-10
7. Central door lock switch p. 1-28
8. Electric window control switch p. 1-41
9. Sun visors p. 5-82  
Vanity mirror p. 5-82  
Card holder p. 5-82
10. Inside rear-view mirror p. 4-09
11. Front seat p. 2-05
12. Supplemental restraint system - side airbag (for front seat)\* p. 2-31
13. Armrest p. 2-07  
Accessory socket p. 5-84
14. Second seat p. 2-08
15. Underfloor-stowable third seat (7 persons) p. 2-10

LHD

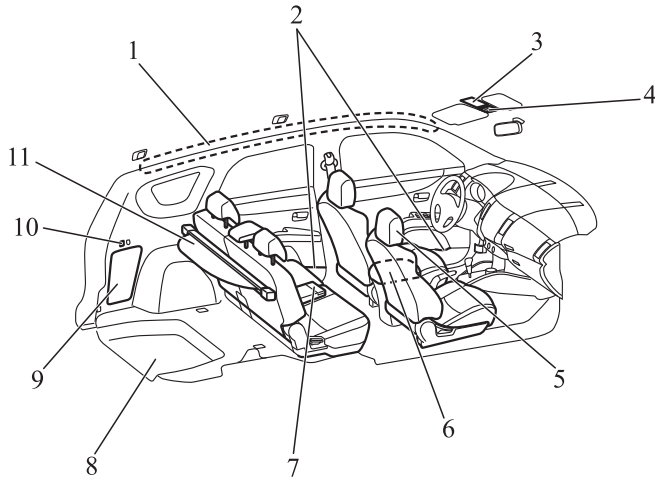

AG5003158

1. Supplemental restraint system - curtain airbag\* p. 2-31, 2-38
2. Bottle holder p. 5-92
3. Sunglasses holder\* p. 5-90
4. Sunroof switch\* p. 1-43  
Map lamp & room lamp (front) p. 5-85, 5-86
5. Head restraints p. 2-14
6. Auxiliary Audio connector (RCA)\* p. 5-52  
Auxiliary Video connector (RCA)\* p. 5-52  
USB input terminal\* p. 5-80
7. Armrest p. 2-09  
Cup holder p. 5-91
8. Luggage floor box (5 persons)\* p. 5-91
9. Quarter trim box\* p. 5-91
10. Luggage area switch\* p. 2-15
11. Cargo area cover\* p. 5-93

RHD

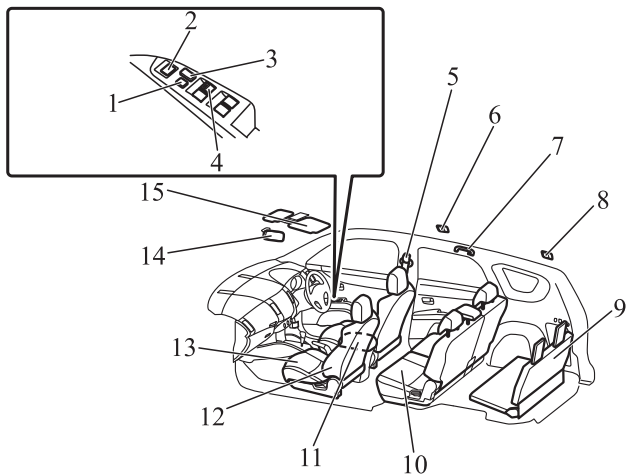

1. Lock switch p. 1-41
2. Electric remote-controlled outside rear-view mirrors switch p. 4-10
3. Central door lock switch p. 1-28
4. Electric window control switch p. 1-41
5. Adjustable seat belt anchor p. 2-21  
Seat belts p. 2-19
6. Room lamp (rear) p. 5-85
7. Assist grip p. 5-94  
Coat hook p. 5-94
8. Luggage room lamp p. 5-87
9. Underfloor-stowable third seat (7 persons) p. 2-10
10. Second seat p. 2-08
11. Armrest p. 2-07  
Accessory socket p. 5-84
12. Supplemental restraint system - side airbag (for front seat) p. 2-31
13. Front seat p. 2-05
14. Inside rear-view mirror p. 4-09
15. Sun visor p. 5-82  
Card holder p. 5-82  
Vanity mirror p. 5-82

RHD

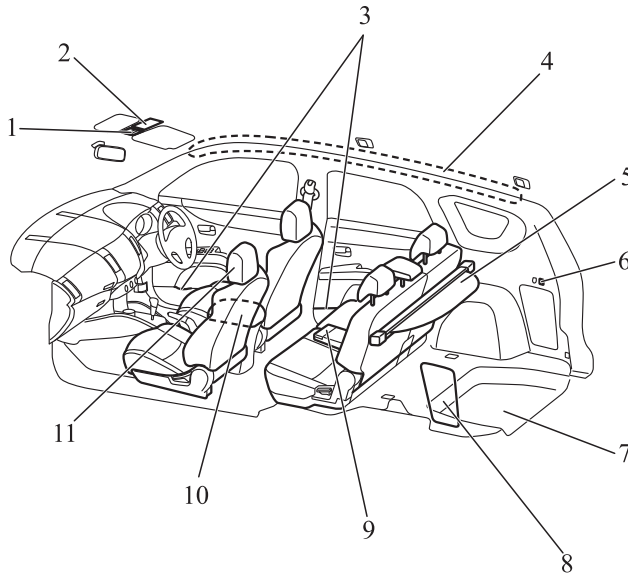

AG5003161

1. Sunroof switch\* p. 1-43  
Map lamp & room lamp (front) p. 5-85, 5-86
2. Sunglasses holder\* p. 5-90
3. Bottle holder p. 5-92
4. Supplemental restraint system - curtain airbag p. 2-31, 2-38
5. Cargo area cover p. 5-93
6. Luggage area switch\* p. 2-15
7. Luggage floor box (5 persons) p. 5-91
8. Quarter trim box\* p. 5-91
9. Armrest p. 2-09  
Cup holder p. 5-91
10. Auxiliary Audio connector (RCA)\* p. 5-52  
Auxiliary Video connector (RCA)\* p. 5-52  
USB input terminal\* p. 5-80
11. Head restraints p. 2-14

## Luggage area

E00100401478

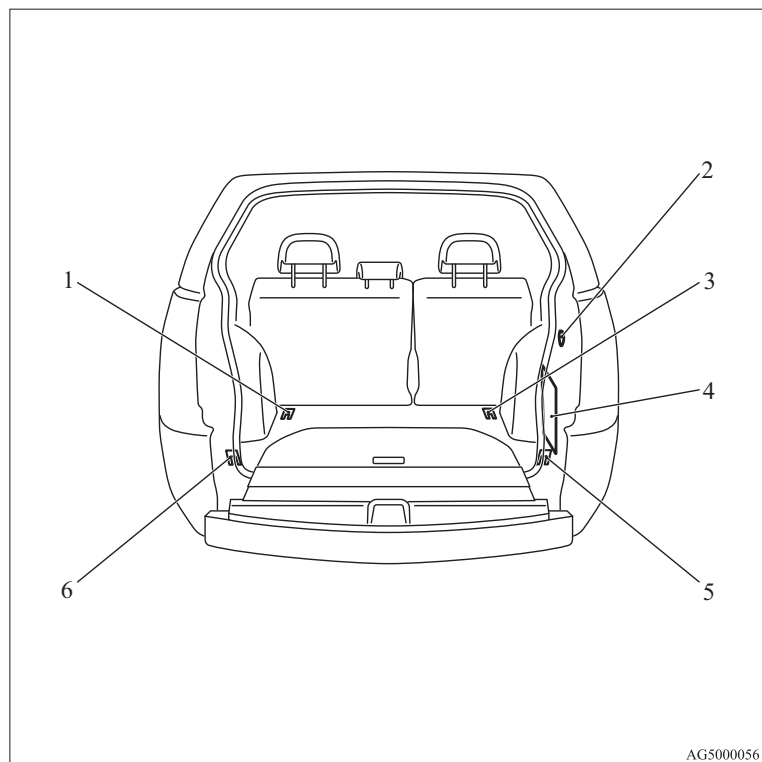

1. Luggage hook p. 5-94
2. Accessory socket p. 5-84
3. Luggage hook p. 5-94
4. Jack p. 6-08  
Tools p. 6-08
5. Luggage hook p. 5-94
6. Luggage hook p. 5-94

AG5000056



## Outside (Front)

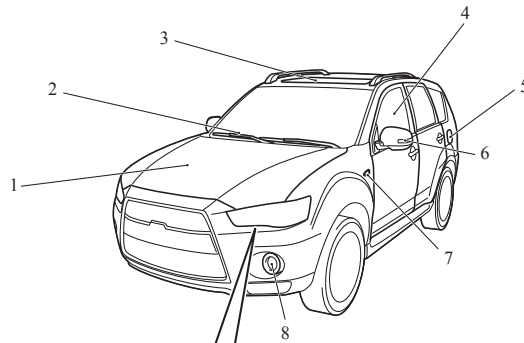

Except for high intensity discharge headlamp type

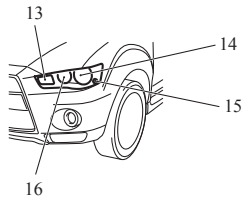

High intensity discharge headlamps type

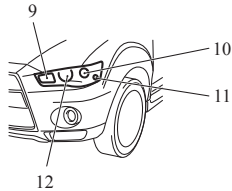

1. Bonnet p. 8-03
2. Windscreen wipers p. 3-51
3. Sunroof\* p. 1-43
4. Electric window control p. 1-41
5. Fuel tank filler p. 03
6. Outside rear-view mirror p. 4-10  
Side turn-signal lamps\* p. 3-48, 8-24, 8-29
7. Side turn-signal lamps\* p. 3-48, 8-24, 8-29
8. Front fog lamps\* p. 3-50, 8-24, 8-29
9. Front turn-signal lamps p. 3-48, 8-24, 8-29
10. Headlamps, high/low beam p. 3-42, 8-24, 8-27
11. Position lamps p. 3-42, 8-24, 8-28
12. Bending lamp (Adaptive Front light System (AFS)) p. 3-48, 8-24, 8-27
13. Front turn-signal lamps p. 3-48, 8-24, 8-29
14. Headlamps, low beam p. 3-42, 8-24, 8-25
15. Position lamps p. 3-42, 8-24, 8-28
16. Headlamps, high-beam p. 3-42, 8-24, 8-26

## Outside (Rear)

E00100504571

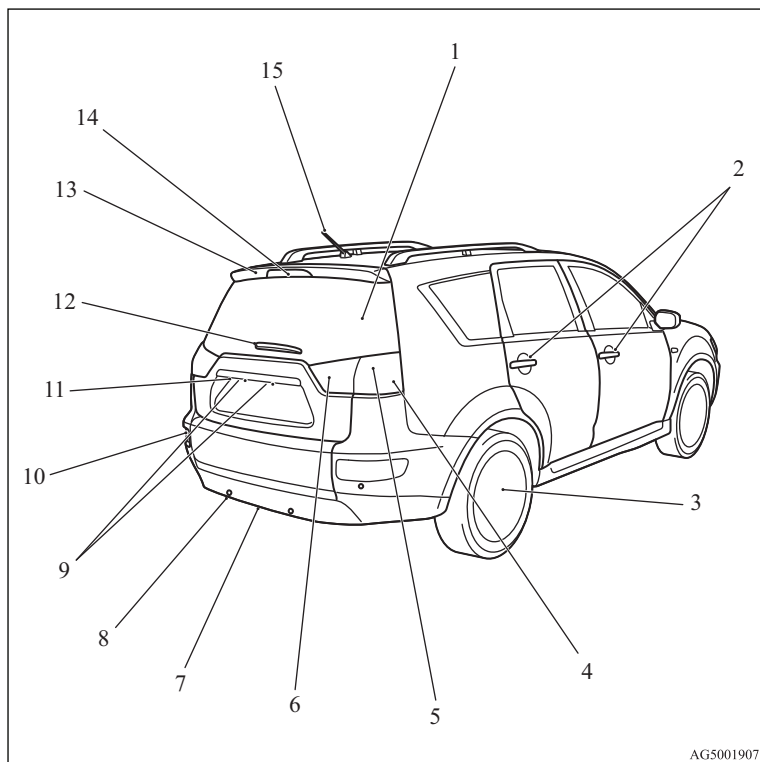

AG5001907

1. Split tailgate p. 1-31
2. Keyless entry system\* p. 1-04  
Keyless operation system\* p. 1-07  
Locking and unlocking the doors p. 1-26
3. Size of tyres and wheels p. 9-17  
Tyre inflation pressures p. 8-12  
Changing tyres p. 6-09  
Tyre rotation p. 8-13  
Tyre chains p. 8-14
4. Turn-signal lamps p. 3-48, 8-24, 8-32
5. Stop lamps/Tail lamps p. 3-42, 8-24, 8-32
6. Reversing lamps p. 3-42, 8-24, 8-32
7. Spare wheel p. 6-10
8. Back sensor\* p. 4-65
9. Licence plate lamps p. 3-42, 8-24, 8-33
10. Rear fog lamp p. 3-42, 8-24, 8-31
11. Rear-view camera\* p. 4-68
12. Rear window wiper p. 3-55
13. Rear spoiler
14. High-mounted stop lamp p. 8-24, 8-33
15. Antenna p. 5-61

## *General information*

Fuel selection.....	02
Filling the fuel tank.....	03
Installation of accessories.....	04
Modification/alterations to the electrical or fuel systems.....	05
Genuine parts.....	05
Safety and disposal information for used engine oil.....	06
Disposal information for used batteries.....	06
Auto Stop & Go (AS&G) system*.....	06

## General information

### Fuel selection

E00200102620

Recommended fuel	<b>Petrol-powered vehicles</b> Unleaded petrol octane number (EN228) 2000 models, 2400 models (except for Clear Tec FFV), 3000 models 95 RON or higher 2400 models (Clear Tec FFV) 95 RON or higher, or Bio ethanol E 85
	<b>Diesel-powered vehicles</b> Cetane number (EN590) 51 or higher

### WARNING

- For Clear Tec FFV models, do not modify the fuel system or any of its components. Flexible fuel vehicles have fuel system components that were designed specifically for use with Bio ethanol. When replacing any of the fuel system components, be sure to replace them with components designed for use with Bio ethanol. Otherwise, engine damage, a vehicle fire, or personal injury could result.
- For Clear Tec FFV models, do not use methanol instead of Bio ethanol E 85. Otherwise, engine damage, a vehicle fire, or personal injury could result.

### CAUTION

- For petrol-powered vehicles, the use of leaded fuel can result in serious damage to the engine and catalytic converter. Do not use leaded fuel.
- Diesel-powered vehicles are designed to use only diesel fuel that meets the EN590 standard.  
Use of any other type of diesel fuel (bio diesel, methylester, etc.) would adversely affect the engine's performance and durability.

#### NOTE

- Petrol-powered vehicles have the knock control system so that you can use unleaded petrol 90 RON as an emergent measure in case unleaded petrol 95 RON or higher is not available on journey, etc.  
In such a case, you don't need to adjust the engine specially. In case of using unleaded petrol 90 RON, the engine performance level is reduced.
- Due to the separation of paraffin, the fluidity of the fuel decreases considerably as the temperature falls.  
Because of this fact there are two kinds of fuel: "summer" and "winter". This must be considered in winter use. Select either of the two kinds of fuel in accordance with ambient temperature.  
Above -5 °C: "Summer" diesel  
Below -5 °C: "Winter" diesel  
When travelling abroad, find out in advance about the fuels served in local service stations.

- Repeatedly driving short distances at low speeds can cause deposits to form in the fuel system and engine, resulting in poor starting and poor acceleration. If these problems occur, you are advised to add a detergent additive to the gasoline when you refuel the vehicle. The additive will remove the deposits, thereby returning the engine to a normal condition. Be sure to use a genuine MITSUBISHI FUEL SYSTEM CLEANER. Using an unsuitable additive could make the engine malfunction. For details, please contact a MITSUBISHI MOTORS Authorized Service Point.
- Poor quality petrol can cause problems such as difficult starting, stalling, engine noise and hesitation. If you experience these problems, try another brand and/or grade of petrol. If the check engine warning lamp flashes, have the system checked as soon as possible at a MITSUBISHI MOTORS Authorized Service Point.
- For Clear Tec FFV models, fuel that contains a mixture of unleaded petrol 95 RON or higher, that meets the EN228 fuel standard, and Bio ethanol E 85 can be used.
- For Clear Tec FFV models, the appropriate fuel is indicated on a label on the inside of the fuel tank filler door.
- For Clear Tec FFV models, the engine performance level will be the same regardless of whether unleaded petrol 95 RON or higher or high-quality Bio ethanol E 85 is used.
- For Clear Tec FFV models, when the vehicle is to be left unused for a long period of time, it is recommended to switch the Bio ethanol E 85 in the fuel tank to unleaded petrol 95 RON or higher.

## Filling the fuel tank

E002000202360

### **WARNING**

- When handling fuel, comply with the safety regulations displayed by garages and filling stations.
- Before removing the fuel cap, be sure to get rid of your body's static electricity by touching a metal part of the car or the fuel pump. Any static electricity on your body could create a spark that ignites fuel vapour.
- Perform the whole refueling process (opening the fuel tank filler door, removing the fuel cap, etc.) by yourself. Do not let any other person come near the fuel tank filler. If you allowed a person to help you and that person was carrying static electricity, fuel vapour could be ignited.
- Do not move away from the fuel tank filler until refueling is finished. If you moved away and did something else (for example, cleaning your windscreen) part-way through the refueling process, you could pick up a fresh charge of static electricity.
- If the tank cap must be replaced, use only a MITSUBISHI MOTORS original part.

### Fuel tank capacity

2WD: 63 litres

4WD: 60 litres

### Refueling

1. Before filling with fuel, stop the engine.

2. The fuel tank filler is located on the rear left side of your vehicle.

Open the fuel tank filler door by pulling the release lever located on the side of the driver's seat.

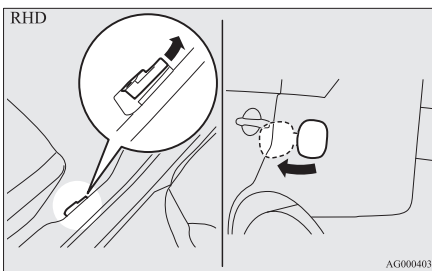
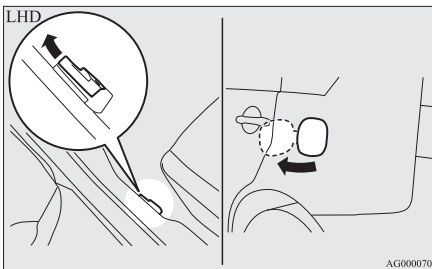

3. Remove the fuel cap.

### General information

Open the fuel tank filler tube by slowly turning the cap anticlockwise.

Except for vehicles equipped with Twin Clutch SST

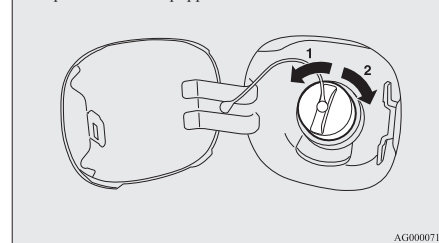

- 1- Remove
- 2- Close

For vehicles equipped with Twin Clutch SST

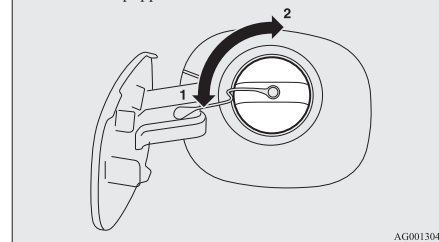

- 1- Remove
- 2- Close

## General information

### **CAUTION**

- For vehicles with Twin Clutch SST, the fuel cap does not turn more than 90 degrees. Turning forcibly could damage the fuel cap.
- Since the fuel system may be under pressure, remove the fuel cap slowly. This relieves any pressure or vacuum that might have built up in the fuel tank. If you hear a hissing sound from the cap, wait until it stops before removing the cap. Otherwise, fuel may spray out, injuring you or others.

#### NOTE

- Except for vehicles with Twin Clutch SST, while filling with fuel, store the cap in the cap holder located on the inside of the fuel tank filler door.
  - For vehicles with Twin Clutch SST, while filling with fuel, hang the fuel cap on the hook located on the inside of the fuel tank filler door.
4. Insert the gun in the tank port as far as it goes.

### **CAUTION**

- Do not tilt the gun.

5. When the gun stops automatically, do not fill with fuel any more.
6. Close the fuel cap.  
[Except for vehicles with Twin Clutch SST]

To close, turn the fuel cap slowly clockwise until you hear clicking sounds, then gently push the fuel tank filler door closed.  
[For vehicles with Twin Clutch SST]  
Fit the fuel cap with the cap handle sideways and turn it clockwise.

#### NOTE

- For Clear Tec FFV models, the fuel in the fuel tank is checked to determine the percentage of ethanol in the fuel in order to control the engine properly.  
To ensure the accuracy of the ethanol check, it is recommended to refuel the vehicle with 10 litres or more of fuel.
- For Clear Tec FFV models, acceleration performance may drop on rare occasions during the fuel check after refueling. However, this does not indicate a malfunction and the acceleration performance will return to normal if you continue to drive the vehicle.

## *Installation of accessories*

E00200300963

We recommend you to consult your MITSUBISHI MOTORS Authorized Service Point.

- The installation of accessories, optional components, etc., should only be carried out within the limits prescribed by law in your country, and in accordance with the guidelines and warnings contained within the documents accompanying this vehicle.
- Installing electric components incorrectly could lead to a fire. See to the “Modification/alteration to the electrical or fuel systems” section within this owner’s manual.
- Using a cellular phone or radio set inside the vehicle without an external antenna may cause electrical system interference, which could lead to unsafe vehicle operation.
- Tyres and wheels which do not meet specifications must not be used.  
Refer to the “Specifications” section for information regarding wheel and tyre sizes.

### **Important points!**

Due to large number of accessory and replacement parts of different manufactures available in the market, it is not possible, not only for MITSUBISHI MOTORS, but also for a MITSUBISHI MOTORS Authorized Service Point, to check whether the attachment or installation of such parts affects the overall safety of your MITSUBISHI-vehicle.

## Genuine parts

E00200500499

MITSUBISHI MOTORS has gone to great lengths to bring you a superbly crafted automobile offering the highest quality and dependability.

Use MITSUBISHI MOTORS Genuine Parts, designed and manufactured to maintain your MITSUBISHI MOTORS automobile at top performance. MITSUBISHI MOTORS Genuine Parts are identified by this mark and are available at all MITSUBISHI MOTORS Authorized Service Points.

**MITSUBISHI MOTORS  
GENUINE PARTS**

Even when such parts are officially authorized, for example by a “general operators permit” (an appraisal for the part) or through the execution of the part in an officially approved manner of construction, or when a single operation permit following the attachment or installation of such parts, it cannot be deduced from that alone, that the driving safety of your vehicle has not been affected.

Consider also that there basically exists no liability on the part of the appraiser or the official. Maximum safety can only be ensured with parts recommended, sold and fitted or installed by a MITSUBISHI MOTORS Authorized Service Point (MITSUBISHI MOTORS genuine replacement parts and MITSUBISHI MOTORS accessories). The same also pertains to modifications of MITSUBISHI vehicles with respect to the production specifications. For safety reasons, do not attempt any modifications other than those that follow the recommendations of a MITSUBISHI MOTORS Authorized Service Point.

## Modification/alterations to the electrical or fuel systems

E00200400368

MITSUBISHI MOTORS CORPORATION has always manufactured safe, high quality vehicles. In order to maintain this safety and quality, it is important that any accessory that is to be fitted, or any modifications carried out which involve the electrical or fuel systems, should be carried out in accordance with MITSUBISHI guidelines.

### CAUTION

- If the wires interfere with the vehicle body or improper installation methods are used (protective fuses not included, etc.), electronic devices may be adversely affected, resulting in a fire or other accident.

## General information

### *Safety and disposal information for used engine oil*

E00200600155

#### **⚠ WARNING**

- Prolonged and repeated contact may cause serious skin disorders, including dermatitis and cancer.
- Avoid contact with the skin as far as possible and wash thoroughly after any contact.
- Keep used engine oils out of reach of children.

#### **Protect the environment**

It is illegal to pollute drains, water courses and soil. Use authorized waste collection facilities, including civic amenity sites and garages providing facilities for disposal of used oil and used oil filters. If in doubt, contact your local authority for advice on disposal.

### *Disposal information for used batteries*

E00201300032



Your vehicle contains batteries and/or accumulators. Do not mix with general household waste.

For proper treatment, recovery and recycling of used batteries, please take them to applicable collection points, in accordance with your national legislation and the Directives 2006/66/EC. By disposing of these batteries correctly, you will help to save valuable resources and prevent any potential negative effects on human health and the environment which could otherwise arise from inappropriate waste handling.

### *Auto Stop & Go (AS&G) system\**

E00201500034

This paragraph summarizes the major items of the Auto Stop & Go (AS&G) system such as the characteristics, operating procedures, etc. For details, refer to “Auto Stop & Go (AS&G) system” on page 4-19.

The Auto Stop & Go (AS&G) system reduces the emission of exhaust gases and increases fuel efficiency.

The Auto Stop & Go (AS&G) system automatically stops and restarts the engine without the use of the ignition switch when the vehicle is stopped, such as at traffic lights or in a traffic jam.

#### **Activation**

E00201600035

The Auto Stop & Go (AS&G) system is automatically activated when the ignition switch is turned to the “ON” position.



## Deactivation

E00201700049

You can deactivate the system by pressing the “Auto Stop & Go (AS&G) OFF” switch. Then the “AS&G OFF” display/indicator will turn on.

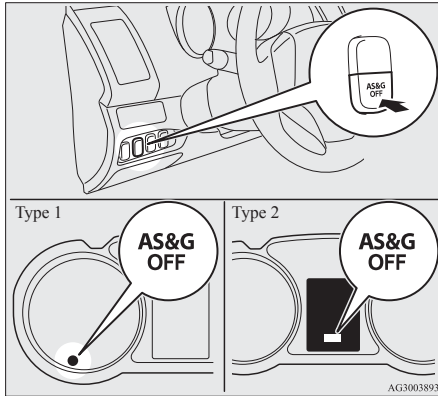

## Auto stop

E00201800037

1. Stop the vehicle.

2. Place the gearshift lever in the “N” (Neutral) position.

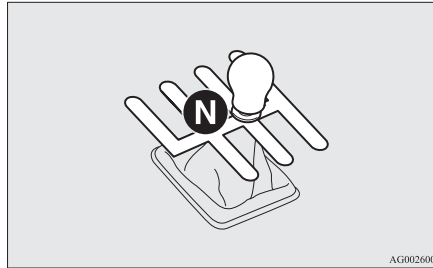

3. Release the clutch pedal.
4. The “AS&G” display/indicator will turn on and the engine will stop automatically.

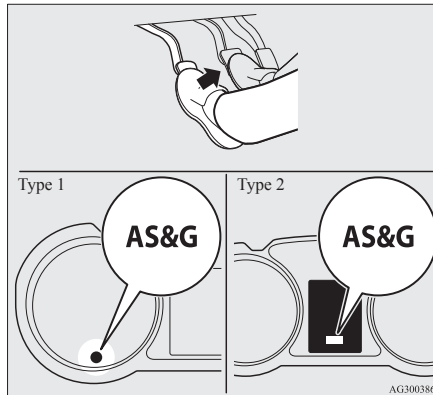

## Auto go

E00201900038

Depress the clutch pedal while the gearshift lever is in the “N” (Neutral) position. The “AS&G” display/indicator turns off and the engine restarts automatically.

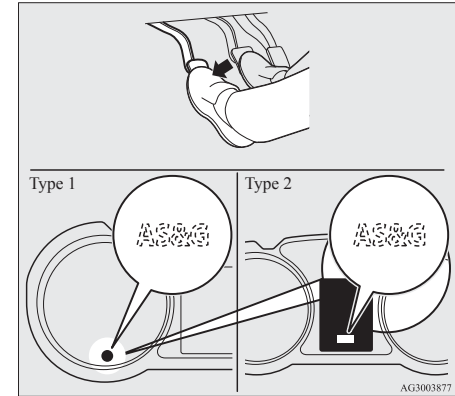

## System characteristics

E00202300039

The principle of the Auto Stop & Go (AS&G) system is that it adapts to the vehicle’s needs (i.e. energy supply). This means that in certain circumstances the engine will not stop and in other circumstances the engine will restart by itself.

### *Circumstances when the engine will restart by itself*

E00202400030

- The interior temperature rises and the air conditioning starts operating in order to lower the temperature.
- Electric power consumption is high.
- The brake pedal is depressed repeatedly.

## General information

- Vehicle speed is 3 km/h (2 mph) or higher when coasting on a slope.
- Mode selection dial is set to the demister position.
- When the air conditioning is operated by pressing the air conditioning switch.
- When the preset temperature of the air conditioning is changed significantly.
- When the air conditioning is operated in AUTO mode where the temperature control dial is set to the max. hot or the max. cool position (for vehicles with automatic air conditioning).

Other than the conditions mentioned above, the engine may restart automatically. For details, refer to “Auto Stop & Go (AS&G) system” on page 4-19.

### ***Circumstances when the engine will not stop***

E00202500031

- Ambient temperature is lower than approximately 3 °C.
- After the engine restarts automatically and the vehicle stops again within 10 seconds.
- After the engine restarts automatically and the vehicle remains stationary.
- Mode selection dial is set to the demister position (see illustration below).

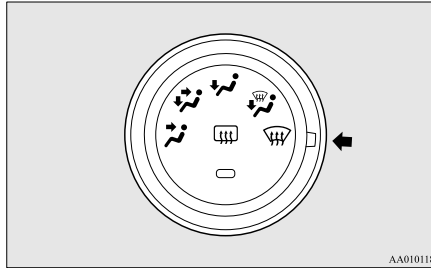

- When the air conditioning is operated in AUTO mode where the temperature control dial is set to the max. hot or the max. cool position (for vehicles with automatic air conditioning).

Other than the conditions mentioned above, the engine may not stop automatically. For details, refer to “Auto Stop & Go (AS&G) system” on page 4-19.

## *Locking and unlocking*

Keys.....	1-02
Electronic immobilizer (Anti-theft starting system).....	1-03
Keyless entry system*.....	1-04
Keyless operation system*.....	1-07
Doors.....	1-26
Central door locks.....	1-28
Dead Lock System*.....	1-29
“Child-protection” rear doors.....	1-31
Split tailgate.....	1-31
Inside tailgate release.....	1-34
Security alarm system*.....	1-35
Electric window control.....	1-41
Sunroof*.....	1-43

## Locking and unlocking

### Keys

E00300102373

#### Type 1

The key fits all locks.

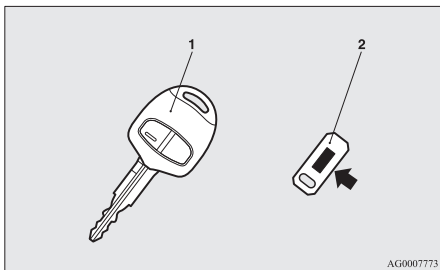

- 1- Keyless entry key  
(with electronic immobilizer)
- 2- Key number tag

#### Type 2

The emergency key fits all locks.

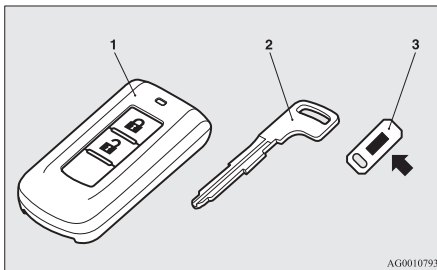

- 1- Keyless operation key  
(with electronic immobilizer and keyless entry system function)
- 2- Emergency key
- 3- Key number tag

### **⚠ WARNING**

- When taking a key on flights, do not press any switches on the key while on the plane. If a switch is pressed on the plane, the key emits electromagnetic waves, which could adversely affect the plane's flight operation. When carrying a key in a bag, be careful that no switches on the key can be easily pressed by mistake.

#### NOTE

- The key number is stamped on the tag as indicated in the illustration. Make a record of the key number and store the key and key number tag in separate places, so that you can order a key in the event the original keys are lost.
- The key is a precision electronic device with a built-in signal transmitter. Please observe the following in order to prevent a malfunction.
  - Do not leave in a place that is exposed to direct sunlight, for example on the dashboard.
  - Do not disassemble or modify.
  - Do not excessively bend the key or subject it to strong impacts.
  - Do not expose to water.
  - Keep away from magnetic key rings.
  - Keep away from audio systems, personal computers, TVs, and other equipment that generates a magnetic field.
  - Keep away from devices that emit strong electromagnetic waves, such as cellular phones, wireless devices and high frequency equipment (including medical devices).
  - Do not clean with ultrasonic cleaners or similar equipment.
  - Do not leave the key where it may be exposed to high temperature or high humidity.
- The engine is designed so that it will not start if the ID code registered in the immobilizer computer and the key's ID code do not match. Refer to the "Electronic immobilizer" section for details and key usage.
- [For vehicles equipped with the security alarm system]

Pay attention to the following if the security alarm is set to “Active”.

Refer to “Security alarm system” on page 1-35.

- If the security alarm is in the system armed mode, the alarm will sound if the doors are opened after being unlocked with the key, the inside lock knob or the central door lock switch.
- Even if the security alarm is set to “Active”, the system preparation mode is not entered if the keyless entry system or the keyless operation function was not used to lock the vehicle.

## Electronic immobilizer (Anti-theft starting system)

E0030021902

[For vehicles equipped with keyless operation system]

For information on operations for vehicles equipped with the keyless operation system, refer to “Keyless operation system: Electronic immobilizer (Anti-theft starting system)” on page 1-11.

[Except for vehicles equipped with keyless operation system]

The electronic immobilizer is designed to significantly reduce the possibility of vehicle theft. The purpose of the system is to immobilize the vehicle if an invalid start is attempted. A valid start attempt can only be achieved by using a key “registered” to the immobilizer system.

### NOTE

- In the following cases, the vehicle may not be able to receive the registered ID code from the registered key and the engine may not start.
  - When the key contacts a key ring or other metallic or magnetic object (Type A)
  - When the key grip contacts metal of another key (Type B)
  - When the key contacts or is close to other immobilizing keys (including keys of other vehicles) (Type C)

In cases like these, remove the object or additional key from the vehicle key. Then try again to start the engine. If the engine does not start, we recommend you to con-

tact your MITSUBISHI MOTORS Authorized Service Point.

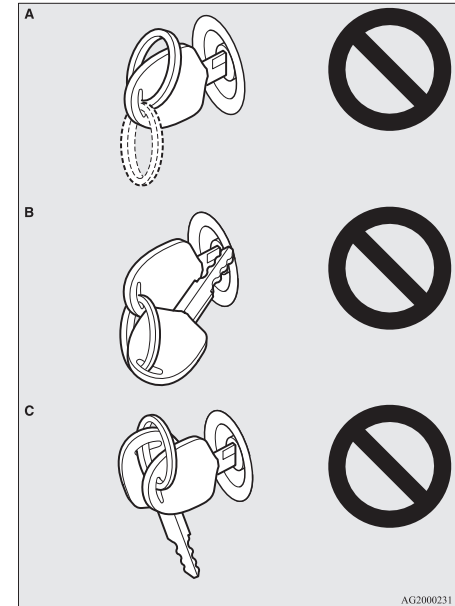

- If you lose one of them, contact a MITSUBISHI MOTORS Authorized Service Point as soon as possible. To obtain a replacement or extra spare key, take your vehicle and all remaining keys to your MITSUBISHI MOTORS Authorized Service Point. All the keys have to be re-registered in the immobilizer computer unit. The immobilizer can register up to 8 different keys.

## **⚠ CAUTION**

- Do not modify or add parts to the immobilizer system. Doing so could cause the immobilizer to malfunction.

1

## **Keyless entry system\***

E00300302418

Press the remote control switch, and all doors and the tailgate will be locked or unlocked as desired. It is also possible to operate the outside rear-view mirrors.

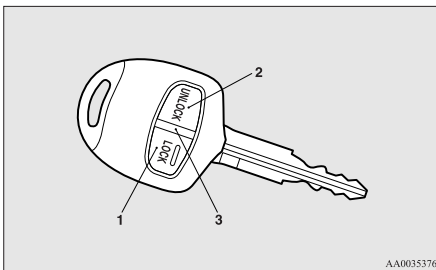

- 1- LOCK switch
- 2- UNLOCK switch
- 3- Indication lamp

### **To lock**

Press the LOCK switch (1). All the doors and the tailgate will be locked. The turn-signal lamps will blink once when the doors and the tailgate are locked.

### **NOTE**

- With a vehicle that has a Dead Lock System, pressing the LOCK switch (1) two times in succession causes the Dead Lock System to be set. (Refer to “Setting the system” on page 1-29.)

### **To unlock**

Press the UNLOCK switch (2). All the doors and the tailgate will be unlocked. If the doors and tailgate are unlocked when the front room lamp switch is in the “DOOR” position or the rear room lamp switch is in the middle (•) position, the room lamp will illuminate for approximately 15 seconds and the turn-signal lamps will blink twice.

The position and tail lamps can also be set to turn on for about 30 seconds. Refer to “Instruments and controls: Welcome light” on page 3-45.

### **NOTE**

- Except for vehicles equipped with a Dead Lock System, the door and tailgate unlock function can be set so that only the driver’s door unlocks when the UNLOCK switch (2) is pressed once. If the door and tailgate unlock function is set to work as described above, all the doors and the tailgate unlock when the UNLOCK switch is pressed two times in succession. Refer to “Setting of door and tailgate unlock function” on page 1-05.
- The indication lamp (3) comes on each time a switch is pressed.
- For vehicles equipped with the mirror retractor switch, the outside rear-view mirrors automatically retract or extend when all the doors and tailgate are locked or unlocked using the remote control switches of the keyless entry system. Refer to “Starting and driving: Outside rear-view mirrors” on page 4-10.

- If the UNLOCK switch (2) is pressed and no door or tailgate is opened within approximately 30 seconds, relocking will automatically occur.
- It is possible to modify functions as follows: For further information, please contact your MITSUBISHI MOTORS Authorized Service Point. On vehicles equipped with MITSUBISHI Multi-Communication System (MMCS), screen operations can be used to make the adjustment. Refer to the separate owner's manual for details.
  - The time for automatic relocking can be changed.
  - The confirmation function (flashing of the turn-signal lamps) can be set to operate only when the doors and backdoor are locked or only when the doors and backdoor are unlocked.
  - The confirmation function (this indicates locking or unlocking of the doors and tailgate with the flash of the turn-signal lamps) can be deactivated.
  - The number of times the turn-signal lamps are flashed by the confirmation function can be changed.

### Operation of the Dead Lock System

In a vehicle that has a Dead Lock System, it is possible to set the Dead Lock System using the remote controller.

(Refer to “Dead Lock System” on page 1-29.)

### Operation of the outside rear-view mirrors (Vehicles equipped with mirror retractor switch)

E00310800106

#### To fold

Within 30 seconds of locking the doors and tailgate using the LOCK switch (1), press the LOCK switch twice rapidly to fold the outside rear-view mirrors.

#### To extend

Within 30 seconds of unlocking the doors and tailgate using the UNLOCK switch (2), press the UNLOCK switch twice rapidly to return the outside rear-view mirrors to their extended positions.

The outside rear-view mirrors are not initially set to work as described above. If you want them to work as described above, you need to set them so that they do not retract/extend when the doors and tailgate are locked/unlocked using the keyless entry system or keyless operation system. Refer to “Starting and driving: Outside rear-view mirrors” on page 4-10. For details, please consult a MITSUBISHI MOTORS Authorized Service Point. In a vehicle equipped with the MITSUBISHI Multi-Communication System (MMCS), it is possible to change the setting by means of screen operations. Refer to the separate owner's manual for details.

#### NOTE

- The keyless entry system does not operate in the following conditions:
  - The key is left in the ignition switch.
  - The door or tailgate is open.

- The remote control switch will operate within approximately 4 m from the vehicle. However, the operating range of the remote control switch may change if the vehicle is located near a power station, or radio/TV broadcasting station.
- If either of the following problems occurs, the battery may be exhausted.
  - The remote control switch is operated at the correct distance from the vehicle, but the doors and tailgate are not locked/unlocked in response.
  - The indication lamp (3) is dim or does not come on.

For further information, please contact your MITSUBISHI MOTORS Authorized Service Point.

If you replace the battery yourself, refer to “Procedure for replacing the remote control switch battery” on page 1-06.

- If your remote control switch is lost or damaged, please contact your MITSUBISHI MOTORS Authorized Service Point for a replacement remote control switch.
- If you wish to add a remote control switch, we recommend you to contact a MITSUBISHI MOTORS Authorized Service Point. A maximum of 8 remote control switches are available for your vehicle.

### Setting of door and tailgate unlock function (Except for vehicles equipped with a Dead Lock System)

E00310300185

The door and tailgate unlock function can be set to the following two conditions.

## Locking and unlocking

Each time the door and tailgate unlock function is set, a chime will sound to tell you the condition of the door and tailgate unlock function.

Number of chimes	Condition
One chime	All doors and the tailgate unlock
Two chimes	Driver's door unlock only

1. Remove the key from the ignition switch.
2. Place the combination headlamps and dipper switch in the "OFF" position, and leave the driver's door open.
3. Press the LOCK switch (1) for 4 to 10 seconds and press the UNLOCK switch (2) during this time.
4. Release in sequence the LOCK and UNLOCK switches within 10 seconds of pressing the LOCK switch in step 3.

### NOTE

- On vehicles equipped with MITSUBISHI Multi-Communication System (MMCS), screen operations can be used to make the adjustment. Refer to the separate owner's manual for details.

## Procedure for replacing the remote control switch battery

E00309500073

1. Remove the screw (A) from the remote control switch.

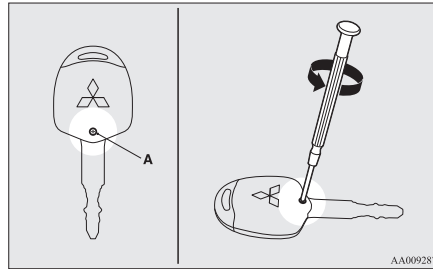

2. With the MITSUBISHI mark facing you, insert the cloth covered tip of a straight blade (or minus) screwdriver into the notch in the remote control switch case and use it to open the case.

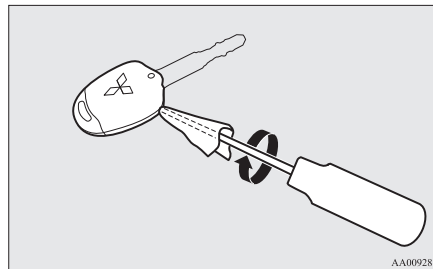

### NOTE

- Be sure to perform the procedure with the MITSUBISHI mark facing you. If the MITSUBISHI mark is not facing you when you open the remote control switch case, the switches may come out.
3. Remove the remote control transmitter from the remote control switch case. Then, open the remote control transmitter using the method described in step 2.

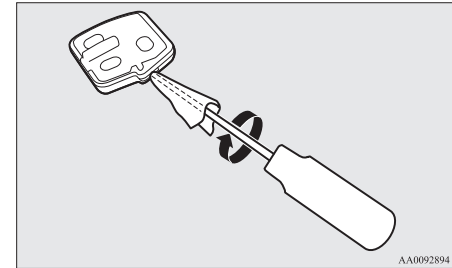

4. Remove the old battery.



5. Install a new battery with the + side (B) down.

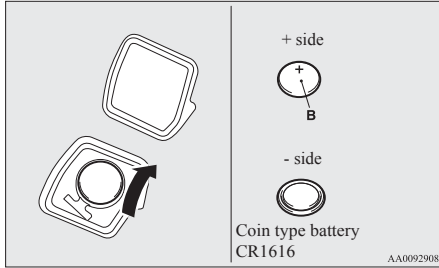

6. Close the remote control transmitter firmly.
7. Place the remote control transmitter in the remote control switch case, then securely close the remote control switch case.
8. Attach the screw (A) removed in step 1.
9. Check the keyless entry system to see that it works.

#### NOTE

- You may purchase a replacement battery at an electric appliance store.
- A MITSUBISHI MOTORS Authorized Service Point can replace the battery for you if you prefer.

### **⚠ CAUTION**

- **When the remote control switch case is opened, be careful to keep water, dust, etc. out. Also, do not touch the internal components.**

## Keyless operation system\*

E00305600539

The keyless operation system allows you to lock and unlock the doors and tailgate and start the engine simply by carrying the keyless operation key with you.

The keyless operation key can also be used as the keyless entry system remote control switch.

Refer to “Keyless operation system: Keyless entry system” on page 1-24.

The driver should always carry the keyless operation key. This key is necessary for locking and unlocking the doors and tailgate, starting the engine and otherwise operating the vehicle, so before locking and leaving the vehicle, be sure to check that you have the keyless operation key.

### **⚠ WARNING**

- **People with implantable cardiac pacemakers or implantable cardiovascular-defibrillators should not go near the exterior transmitters (A) or the interior transmitters (B). The radio waves used by the keyless operation system could adversely affect implantable cardiac pacemakers or implantable cardiovascular-defibrillators.**

## Locking and unlocking

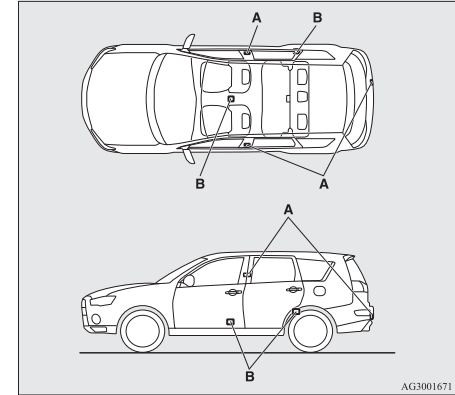

### **⚠ WARNING**

- **When using electro-medical devices other than implantable cardiac pacemakers or implantable cardiovascular-defibrillators, contact the electromedical device manufacturer ahead of time to determine the affects of radio waves on the devices. Electromedical device operations could be affected by radio waves.**

You can limit the possible operations of the keyless operation system in the following ways. (The keyless operation system can be used as a keyless entry system.) Consult a MITSUBISHI MOTORS Authorized Service Point.

- You can limit operations to locking and unlocking the doors and tailgate.

## Locking and unlocking

- You can limit operations to starting the engine.
- The keyless operation system can be disabled.

When keyless operation system operations are modified, the transmitters operate as follows.

- Only locking and unlocking doors or tailgate: exterior and interior transmitters
- Only starting the engine: interior transmitter

### NOTE

- The keyless operation key uses an ultra-weak electromagnetic wave. In the following cases, the keyless operation system may not operate properly or may be unstable.
  - When there is equipment nearby that emits strong radio waves, such as: a power station, a radio/TV broadcasting station or an airport.
  - The keyless operation system is carried together with a communications device such as a cellular phone or radio set, or with an electronic device such as a personal computer.
  - The keyless operation key is touching or covered by a metal object.
  - A keyless entry system is being used nearby.
  - When the keyless operation key battery is worn out.

- When the keyless operation key is placed in an area with strong radio waves or noise. In such cases, use the emergency key. Refer to “To operate without using the keyless operation function” on page 1-18.

- Because the keyless operation key receives signals in order to communicate with the transmitters in the vehicle, the battery continually wears down regardless of keyless operation key use. The battery life is 1 to 3 years, depending on usage conditions. When the battery wears out, have it replaced at a MITSUBISHI MOTORS Authorized Service Point.
- Because the keyless operation key continually receives signals, strong radio wave reception could affect battery wear. Do not leave the key near a TV, personal computer, or other electronic device.

## Operating range of the keyless operation system

E00305700471

If you are carrying the keyless operation key, enter the operating range of the keyless operation system, and press the driver's or front passenger's door lock/unlock switch, the tailgate LOCK switch or the tailgate OPEN switch, the ID code for your key is verified.

You can only lock and unlock the doors and tailgate and start the engine if the ID codes of your keyless operation key and the vehicle match.

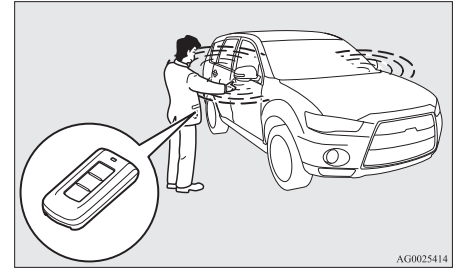

### NOTE

- If the keyless operation key battery is wearing out or there are strong electromagnetic waves or noise present, the operating range may become smaller and operation may become unstable.

**Operating range for locking and unlocking the doors and tailgate**

E00306200444

The operating range is about 70 cm from the driver's door handle, front passenger's door handle, and tailgate handle.

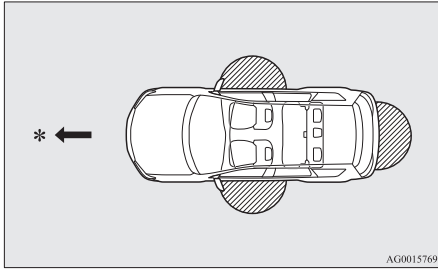

AG0015769

\*: Forward direction

Operating range

**NOTE**

- Locking and unlocking are only possible when the door or tailgate is operated while the keyless operation key is being detected.
- Operation may not be possible if you are too close to the front door, door window, or tailgate.
- Even if the keyless operation key is within 70 cm of the driver's door handle, front passenger's door handle, or tailgate handle, if the key is near to the ground or high up, the system may not operate.

- If the keyless operation key is within the operating range, even someone not carrying the key can lock and unlock the doors and tailgate by pressing the driver's or front passenger's door lock/unlock switch, the tailgate LOCK switch or the tailgate OPEN switch.

**Operating range for starting the engine**

E00306300184

The operating range is the interior of the vehicle.

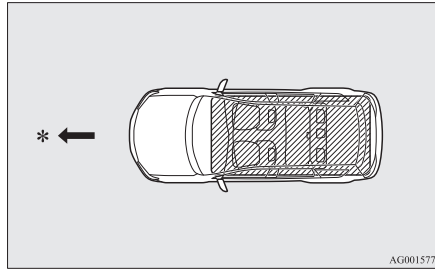

AG0015772

\*: Forward direction

Operating range

**NOTE**

- Even if it is within the operating range, if the keyless operation key is in a small item holder such as the glove box, on top of the instrument panel, door pocket or in the luggage area, it may be impossible to start the engine.
- If you are too close to the door or door window, the engine may start even though the keyless operation key is outside the vehicle.

**To operate using the keyless operation function**

E00305800616

**Locking the doors and tailgate**

When you are carrying the keyless operation key, if you press the driver's or front passenger's door lock/unlock switch (A), or the tailgate LOCK switch (B) within the operating range, the doors and the tailgate are locked.

The turn-signal lamps will blink once.

Also refer to "Locking and unlocking: Doors, Central door locks, Split tailgate" on pages 1-26, 1-28 and 1-31.

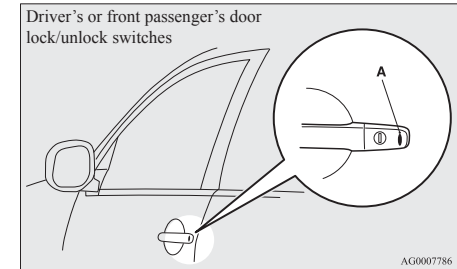

AG0007786

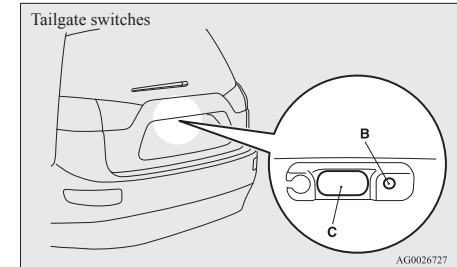

AG0026727

## Locking and unlocking

### NOTE

- For vehicles equipped with the mirror retractor switch, the outside rear-view mirrors automatically retract when all the doors and tailgate are locked using the keyless operation function.  
Refer to “Starting and driving: Outside rear-view mirrors” on page 4-10.
- With a vehicle that has a Dead Lock System, pressing the driver’s or front passenger’s door lock/unlock switch (A), or the tailgate LOCK switch (B) two times in succession causes the Dead Lock System to be set. (Refer to “Setting the system” on page 1-29.)
- The keyless operation function does not operate under the following conditions:
  - The keyless operation key is inside the vehicle.
  - A door or the tailgate is open or ajar.
  - The ignition switch is not in the “LOCK” position.
  - The emergency key is in the ignition switch.
- The tailgate OPEN switch (C) can be used to check that the vehicle is locked properly. Press the tailgate OPEN switch within approximately 3 seconds of locking the vehicle. If you wait longer than 3 seconds and press the tailgate OPEN switch, the doors and tailgate will be unlocked.

- The time allowed for checking that the vehicle is locked can be adjusted. For further information, please contact your MITSUBISHI MOTORS Authorized Service Point.

On vehicles equipped with MITSUBISHI Multi-Communication System (MMCS), screen operations can be used to make the adjustment. Refer to the separate owner’s manual for details.

### *Unlocking the doors and tailgate*

When you are carrying the keyless operation key, if you press the driver’s or front passenger’s door lock/unlock switch (A), or the tailgate OPEN switch (B) within the operating range, all the doors and the tailgate are unlocked.

If the front room lamp switch is in the “DOOR” position or the rear room lamp switch is in the middle (•) position at this time, the room lamp will turn on for 15 seconds. The turn-signal lamps will blink twice.

If the driver’s or front passenger’s door lock/unlock switch is pressed and any of the doors or tailgate is not opened within approximately 30 seconds, relocking will automatically occur.

Also refer to “Locking and unlocking: Doors, Central door locks, Split tailgate” on pages 1-26, 1-28 and 1-31.

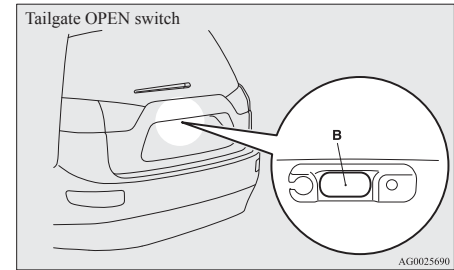
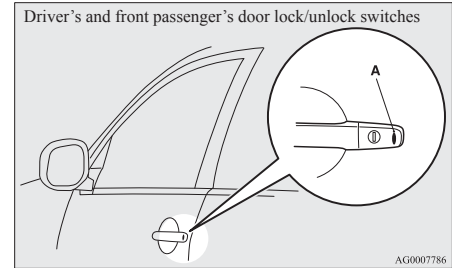

### NOTE

- For vehicles equipped with the mirror retractor switch, the outside rear-view mirrors automatically extend when all the doors and tailgate are unlocked using the keyless operation function.  
Refer to “Starting and driving: Outside rear-view mirrors” on page 4-10.

- Except for vehicles equipped with a Dead Lock System, the keyless operation function can be set so that only the driver's door unlocks when the driver's door lock/unlock switch is pressed.  
If the keyless operation function is set to work as described above, all the doors and the tailgate unlock when the driver's door lock/unlock switch is pressed two times in succession.  
Refer to "Setting of door and tailgate unlock function" on page 1-25.
- The keyless operation function does not operate under the following conditions:
  - A door or the tailgate is open or ajar.
  - The ignition switch is not in the "LOCK" position.
  - The emergency key is in the ignition switch.
- In order to make it possible to check that the doors and tailgate are locked, you cannot unlock them by using the tailgate OPEN switch for 3 seconds after locking them.
- The time allowed for checking that the vehicle is locked can be adjusted. For further information, please contact your MITSUBISHI MOTORS Authorized Service Point.  
On vehicles equipped with MITSUBISHI Multi-Communication System (MMCS), screen operations can be used to make the adjustment. Refer to the separate owner's manual for details.

- The time between unlocking and automatic locking can be adjusted. Consult a MITSUBISHI MOTORS Authorized Service Point.  
On vehicles equipped with MITSUBISHI Multi-Communication System (MMCS), screen operations can be used to make the adjustment. Refer to the separate owner's manual for details.

**Operation confirmation when locking and unlocking**

Operation can be confirmed as shown below. However, the room lamp will only illuminate if the front room lamp switch is in the "DOOR" position or the rear room lamp switch is in the middle (•) position.

When locking: The turn-signal lamps will blink once.

When unlocking: The room lamp will illuminate for approximately 15 seconds, the turn-signal lamps will blink twice.

**NOTE**

- Functions can be modified as stated below. For further information, please contact your MITSUBISHI MOTORS Authorized Service Point.  
On vehicles equipped with MITSUBISHI Multi-Communication System (MMCS), screen operations can be used to make the adjustment. Refer to the separate owner's manual for details.

- Set the confirmation function (blinking of the turn-signal lamps) to operate only when the vehicle is locked or only when the vehicle is unlocked.
- Disable the operation confirmation function (blinking of the turn-signal lamps).
- Change the number of blinks for the operation confirmation function (blinks of the turn-signal lamps).

**Operation of the Dead Lock System**

With a vehicle that has a Dead Lock System, it is possible to set the Dead Lock System using the driver's or front passenger's door lock/unlock switch, or the tailgate LOCK switch.  
(Refer to "Dead Lock System" on page 1-29.)

**Electronic immobilizer (Anti-theft starting system)**

E00306400488

The electronic immobilizer has been designed to significantly reduce the possibility of vehicle theft. The purpose of the system is to immobilize the vehicle if an invalid start is attempted. A valid start attempt can only be achieved (subject to certain conditions) using a keyless operation system "registered" to the immobilizer system.

All of the keys provided with your new vehicle have been programmed into the vehicle's electronics. Refer to "Keyless operation system: Ignition switch" on pages 1-12 and 1-19.

## Locking and unlocking

### NOTE

- If you lose one of the keyless operation keys, contact a MITSUBISHI MOTORS Authorized Service Point as soon as possible.

To obtain a replacement or extra spare key, take your vehicle and all remaining keys to your MITSUBISHI MOTORS Authorized Service Point. All the keys have to be re-registered in the immobilizer computer unit. The immobilizer can register up to 4 different keys.

### Ignition switch

E00306500434

In order to prevent theft, the engine will not start unless a preregistered keyless operation key is used. (Engine immobilizer function)

Provided you are carrying the keyless operation key, you can start the engine by turning the ignition switch.

Also refer to “Starting and driving: Starting the engine” on pages 4-15 and 4-15.

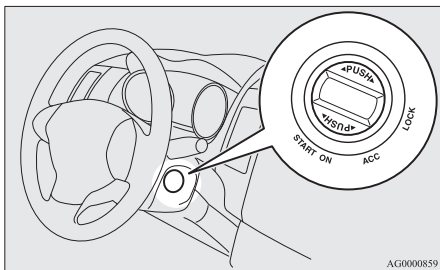

### LOCK (PUSH OFF)

The position in which the steering wheel is locked.

### LOCK (PUSH ON)

When the ID code verification inside the vehicle produces a match, the steering wheel lock is released and the ignition switch can be turned.

### ACC

The engine is stopped, but the audio system and other electric devices can be operated.

### ON

The engine is running, and all the vehicle's electrical devices can be operated.

### START

The starter motor operates. Once the engine starts, let go of the key. The key will automatically return to the “ON” position.

### NOTE

- Your vehicle is equipped with an electronic immobilizer. To start the engine, the ID code which the transponder inside the key sends must match the one registered in the immobilizer computer. (Refer to “Electronic immobilizer (Anti-theft starting system)” on page 1-11.)

### When turning from “LOCK” (PUSH OFF) to “ACC”

E00306600031

Push the ignition switch and turn it slowly.

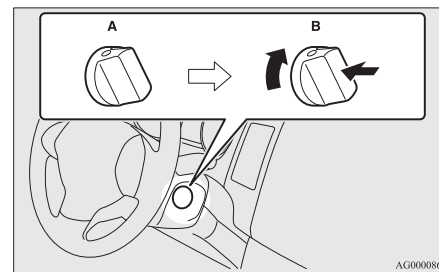

A - Steering wheel locked

B - Steering wheel released

### NOTE

- If the ignition switch does not turn from “LOCK” (PUSH OFF) to “ACC”, press the ignition switch again, slightly move the steering wheel left and right, and then turn the ignition switch.
- The ignition switch cannot be turned if the keyless operation key is not in the vehicle. Refer to “Operating range for starting the engine” on page 1-09.

### When turning from “ACC” to “LOCK”

E00306700061

[Vehicles with M/T]

Put the gearshift lever into the “N” (Neutral) position, and slowly turn the ignition switch to the “LOCK” position while pressing it.

[Vehicles with A/T, CVT or Twin Clutch SST]

First, set the selector lever (A/T or CVT) or the gearshift lever (Twin Clutch SST) to the “P” (PARK) position, and then slowly turn the ignition switch to the “LOCK” position while pressing it.

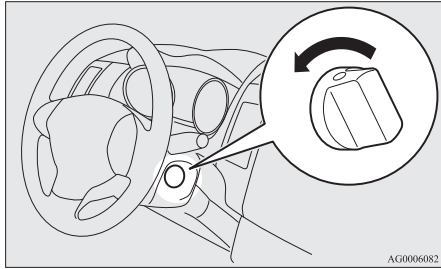

NOTE

- On vehicles with A/T, CVT or Twin Clutch SST, the ignition switch cannot be turned to the “LOCK” position unless the selector lever (A/T or CVT) or the gearshift lever (Twin Clutch SST) is in the “P” (PARK) position.

**⚠ CAUTION**

- Do not turn the ignition switch to the “LOCK” position while driving. The steering wheel will be locked, causing loss of control.
- If the engine is stopped while driving, the brake servo mechanism will cease to function and braking function will deteriorate. Also, the power steering system will not function and it will require greater manual effort to operate the steering.

**⚠ CAUTION**

- Do not leave the ignition switch in the “ON” or “ACC” position for a long time when the engine is not running, doing so will cause the battery to be discharged.
- Do not turn the ignition switch to the “START” position when the engine is running, doing so could damage the starter motor.

Warning activation

E00305900590

In order to prevent vehicle theft or the accidental operation of the keyless operation system, the buzzer and the display on the information screen in the multi-information display are used to alert the driver. If a warning is activated, always check the vehicle and the keyless operation key. The warning is also displayed if there is a fault in the keyless operation system.





If any of the following warnings are activated, please contact a MITSUBISHI MOTORS Authorized Service Point.

<p>Type 1</p> <p>SERVO REQUIRED</p> <p>Type 2</p> <p>KEYLESS OPERATION SYSTEM SERVICE REQUIRED</p>	<p>There is a fault in the keyless operation system.</p>
<p>Type 1</p> <p>KEY BATTERY LOW</p> <p>Type 2</p> <p>KEY BATTERY LOW</p>	<p>The battery in the keyless operation key has worn out.</p>







In the following cases, a warning is activated, but it can be cancelled if the correct actions are followed.

- The ID codes for the keyless operation key and vehicle do not match.

## Locking and unlocking

<p>Type 1</p>  <p>KEY MISSING</p>	<p>You could be carrying another keyless operation key with a different code, or the keyless operation key could be outside the operating range.</p>
<p>Type 2</p>  <p>KEY NOT DETECTED</p>	
<p>Type 1</p>  <p>CONFIRM KEY LOCATION</p>	<p>Refer to “Keyless operation key take-out monitoring system” on page 1-14.</p>
<p>Type 2</p>  <p>KEY NOT DETECTED</p>	

- Even though you press the driver’s or front passenger’s door lock/unlock switch, or the tailgate LOCK switch, the doors and tailgate are not locked.

<p>Type 1</p>  <p>CONFIRM KEY LOCATION</p>	<p>Refer to “Key lock-in prevention system” on page 1-15.</p>
<p>Type 2</p>  <p>KEY STILL IN VEHICLE</p>	
<p>Type 1</p>  <p>CHECK DOORS</p>	<p>Refer to “Door ajar prevention system” on page 1-15.</p>
<p>Type 2</p>  <p>CHECK DOORS</p>	
<p>Type 1</p>  <p>LOCK</p>	<p>Refer to “Ignition switch turn-off reminder system” on page 1-15.</p>
<p>Type 2</p>  <p>LOCK</p>	

## Keyless operation key take-out monitoring system

E00308000260

Type 1



Type 2

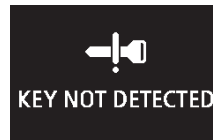

When the vehicle is parked with the ignition switch in any position other than “LOCK” (PUSH OFF), if you close the door after opening any of the doors and taking the keyless operation key out of the vehicle, a warning displays and the buzzer sounds 4 times.

### NOTE

- If you take the keyless operation key out of the vehicle through a window without opening a door, the keyless operation key take-out monitoring system does not operate.



### Locking and unlocking

- It is possible to change the setting to make the keyless operation key take-out monitoring system operate if you take the keyless operation key out from the vehicle through a window without opening a door. For further information, please contact your MITSUBISHI MOTORS Authorized Service Point.
- Even if you have the keyless operation key within the engine start operating range, if the keyless operation key and vehicle ID codes cannot be matched, for example due to the ambient environment or electromagnetic conditions, the warning may be activated.

#### Key lock-in prevention system

E00308100506

Type 1



Type 2



When the ignition switch is in the “LOCK” (PUSH OFF) position, if you close all the doors and the tailgate with the keyless operation key left in the vehicle and you try to lock the doors and tailgate by pressing the driver’s or front passenger’s door lock/unlock switch, or the tailgate LOCK switch, a warning is issued with the warning display and the buzzer buzzing for about 3 seconds and you cannot lock the doors and tailgate.

#### NOTE

- Make sure you have the keyless operation key with you before locking the doors. Even if you leave the keyless operation key inside the vehicle, it is possible that the doors will lock depending on the surrounding environment and wireless signal conditions.

#### Door ajar prevention system

E00308200451

Type 1



Type 2



When the ignition switch is in the “LOCK” (PUSH OFF) position, if you try to lock the doors and tailgate by pressing the driver’s or front passenger’s door lock/unlock switch, or the tailgate LOCK switch with one of the doors or the tailgate not completely closed, a warning is issued with the warning display and the buzzer buzzing for about 3 seconds and you cannot lock the doors and tailgate.

#### Ignition switch turn-off reminder system

E00308300452

Type 1



Type 2



When the ignition switch is in any position other than the “LOCK” (PUSH OFF) position, if you close all the doors and the tailgate then try to lock the doors and tailgate by pressing the driver’s or front passenger’s door lock/unlock switch, or the tailgate LOCK switch, a warning is issued with the warning display and the buzzer buzzing for about 3 seconds and you cannot lock the doors and tailgate.

## Locking and unlocking

### Steering wheel lock

E00306800192

#### To lock

Turn the steering wheel until it is locked.

#### To unlock

Turn the ignition switch to the “ACC” position while moving the steering wheel slightly right and left.

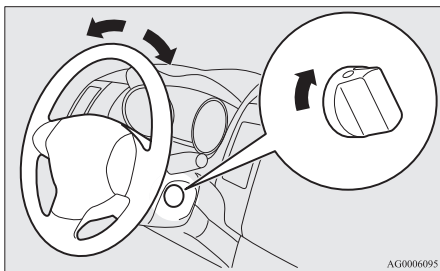

### **A CAUTION**

- Carry the key with you when leaving the vehicle.  
If your vehicle needs to be towed, turn the ignition switch to the “ACC” position to unlock the steering wheel.

## Starting

E00306900441

#### Tips for starting

- Do not operate the starter motor continuously longer than 10 seconds; doing so could run down the battery. If the engine does not start, turn the ignition switch back to “LOCK”, wait a few seconds, and then try again.  
Trying repeatedly with the starter motor still turning will damage the starter mechanism.
- On vehicles equipped with the Twin Clutch SST, the following may occur after the engine is started, but they do not indicate an abnormality.
  - You may hear operational sounds of the Twin Clutch SST and you may feel vibration in the vehicle body.
  - If you shift the gearshift lever into the “N” (NEUTRAL) position and depress the accelerator pedal, increases in the engine speed will be limited.
- [Diesel-powered vehicles with M/T]  
While the vehicle is stationary with the clutch pedal fully depressed, the engine revolutions do not rise to over 3,000 rpm in order to protect the engine even if the accelerator pedal is depressed.

### **A WARNING**

- Never run the engine in a closed or poorly ventilated area any longer than is needed to move your vehicle in or out of the area. Carbon monoxide gases are odourless and can be fatal.

### **A CAUTION**

- Never attempt to start the engine by pushing or pulling the vehicle.
- Do not run the engine at high rpm or drive the vehicle at high speed until the engine has had a chance to warm up.
- Release the ignition switch as soon as the engine starts to avoid damaging the starter motor.
- If your vehicle is equipped with a turbocharger, do not stop the engine immediately after high-speed or uphill driving. First allow the engine to idle to give the turbocharger a chance to cool down.

#### Starting the engine (petrol-powered vehicles)

E00307000612

The starting procedure is as follows:

1. Fasten the seat belt.
2. Make sure the parking brake is applied.
3. Depress and hold the brake pedal.
4. Fully depress the clutch pedal (M/T).
5. On vehicles equipped with M/T, place the gearshift lever in the “N” (Neutral) position.

## Locking and unlocking

On vehicles equipped with A/T or CVT, make sure the selector lever is in the “P” (PARK) position.

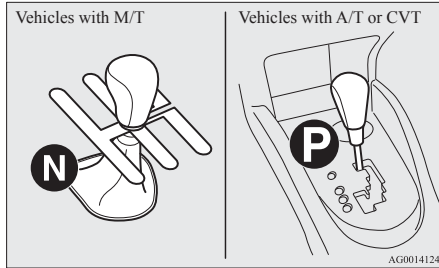

### NOTE

- On vehicles equipped with A/T or CVT, the starter will not operate unless the selector lever is in the “P” (PARK) or “N” (NEUTRAL) position. For safety reasons, start the engine in the “P” (PARK) position so that the wheels are locked.
6. After turning the ignition switch to the “ON” position, make certain that all warning lamps are functioning properly before starting the engine.
  7. Turn the ignition switch to the “START” position without depressing the accelerator pedal, and release it when the engine starts.

### NOTE

- Minor noises may be heard on engine start-up. These will disappear as the engine warms up.

### Using the MIVEC engine (3000 models)

The MIVEC engine automatically switches its intake-valve control between a low-speed mode and a high-speed mode in accordance with driving conditions for maximum engine performance.

### NOTE

- To protect the engine, the high-speed mode may not be selected while the engine coolant temperature is low. In such a case, the engine revolutions do not rise to over 5,000 rpm even if the accelerator pedal is depressed.

### Starting the engine (diesel-powered vehicles)

E00307000625

1. Fasten the seat belt.
2. Make sure the parking brake is applied.
3. Depress and hold the brake pedal.
4. Fully depress the clutch pedal (M/T).

### NOTE

- On vehicles with the Auto Stop & Go (AS&G) system, the starter will not operate unless the clutch pedal is fully depressed (Clutch interlock).
5. On vehicles equipped with M/T, place the gearshift lever in the “N” (Neutral) position.

On vehicles equipped with Twin Clutch SST, make sure the gearshift lever is in the “P” (PARK) position.

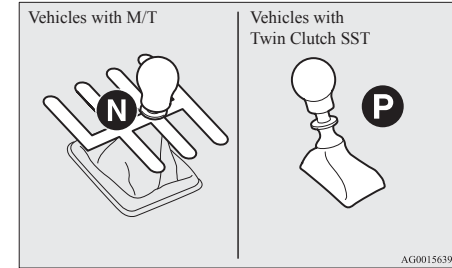

### NOTE

- On vehicles with Twin Clutch SST, the starter will not operate unless the gearshift lever is in the “P” (PARK) position or the gearshift lever is in the “N” (NEUTRAL) position with the brake pedal depressed. For safety reasons, start the engine in the “P” (PARK) position so that the wheels are locked.
6. Turn the ignition switch to the “ON” position. The diesel preheat indication lamp will first illuminate, and then after a short time go out, indicating that preheating is completed.

### NOTE

- If the engine is cold, the diesel preheat indication lamp is on for a longer time.

## Locking and unlocking

- On vehicles with Twin Clutch SST, when the engine has not been started within about 5 seconds after the diesel preheat indication lamp went out, return the ignition switch to the “LOCK” position. Then, turn the switch to the “ON” position to preheat the engine again.
  - When the engine is warm, the diesel preheat indication lamp does not come on even if the ignition switch is placed in the “ON” position. Start the engine by turning the ignition switch right to the “START” position.
7. Turn the ignition switch to the “START” position without depressing the accelerator pedal, and release it when the engine starts.

### NOTE

- Minor noises may be heard on engine start-up. These will disappear as the engine warms up.

### Using the MIVEC engine

The MIVEC engine automatically switches its intake-valve control between a low-speed mode and a high-speed mode in accordance with driving conditions for maximum engine performance.

### NOTE

- To protect the engine, the high-speed mode may not be selected while the engine coolant temperature is low.

## To operate without using the keyless operation function

E00306000019

### Emergency key

E00307200353

The emergency key is built into the keyless operation key. If the keyless operation key cannot be used, for example because the keyless operation key battery has worn out or the vehicle battery is flat, you can lock and unlock the driver’s door and start the engine with the emergency key. To use the emergency key (A), unlock the lock knob (B) and remove it from the keyless operation key (C).

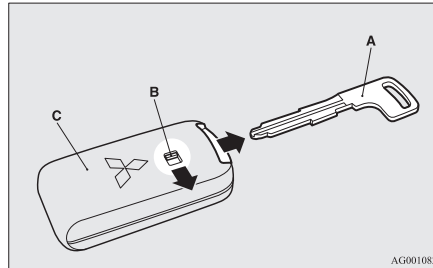

### NOTE

- Only use the emergency key for emergencies. If the keyless operation key battery wears out, replace it as quickly as possible so that you can use the keyless operation key.
- After using the emergency key, always return it into the keyless operation key.

- The glove box can only be locked or unlocked with the emergency key. When leaving your key at a hotel reception or lending your vehicle to someone else, take out the emergency key as necessary and hand over only the keyless operation key.

### Locking and unlocking the driver’s door

Turning the emergency key in the forward direction locks the door, and turning it in the rear direction unlocks the door. Also refer to “Locking and unlocking: Doors” on page 1-26.

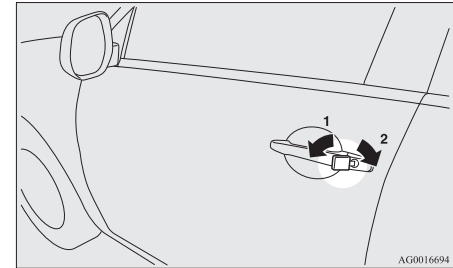

- 1- Lock  
2- Unlock

### Electronic immobilizer (Anti-theft starting system)

E00307300400

The electronic immobilizer has been designed to significantly reduce the possibility of vehicle theft. The purpose of the system is to immobilize the vehicle if an invalid start is attempted. A valid start attempt can only be achieved (subject to certain conditions) using a keyless operation system and emergency key “registered” to the immobilizer system.

All of the keys provided with your new vehicle have been programmed into the vehicle's electronics. Refer to "Keyless operation system: Ignition switch" on pages 1-12 and 1-19.

#### NOTE

- If you lose one of the keyless operation keys, contact a MITSUBISHI MOTORS Authorized Service Point as soon as possible. To obtain a replacement or extra spare key, take your vehicle and all remaining keys to your MITSUBISHI MOTORS Authorized Service Point. All the keys have to be re-registered in the immobilizer computer unit. The immobilizer can register up to 4 different keys.

#### Ignition switch

E00307400430

To prevent vehicle theft, only the emergency key with the preregistered keyless operation key inserted can start the engine. (Electronic immobilizer function)

Also refer to "Starting and driving: Starting the engine" on pages 4-15 and 4-15.

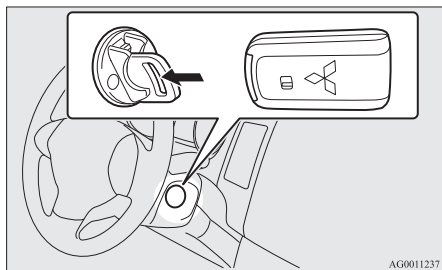

#### LOCK

The engine is stopped and the steering wheel locked. The emergency key can be inserted and removed in this position.

#### ACC

The engine is stopped, but the audio system and other electrical devices can be operated.

#### ON

The engine is running, and all the vehicle's electrical devices can be operated.

#### START

The starter motor operates. After the engine has started, release the emergency key and it will automatically return to the "ON" position.

#### NOTE

- The keyless operation key is equipped with an electronic immobilizer. To start the engine, the ID code which the transponder inside the key sends must match the one registered in the immobilizer computer. Refer to "Electronic immobilizer (Anti-theft starting system)" on page 1-18.

#### When turning from "LOCK" to "ACC"

1. Take the emergency key out of the keyless operation key. Refer to "Emergency key" on page 1-18.

#### Locking and unlocking

2. Remove the ignition switch cover while pressing the lock release button (A).

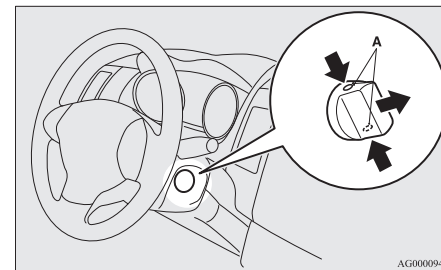

3. Insert the emergency key into the ignition switch, and turn while pushing.

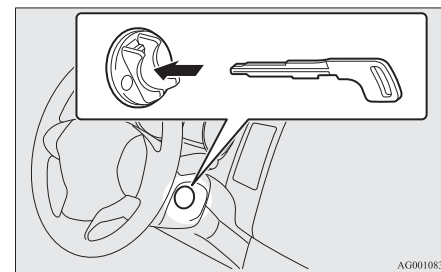

#### NOTE

- If the ignition switch will not turn from the "LOCK" to the "ACC" position, lightly turn the steering wheel right and left while turning the ignition switch.

## Locking and unlocking

### When turning from “ACC” to “LOCK”

1. [Vehicles with M/T]  
While pushing the ignition switch, turn to the “LOCK” position and pull out the key.  
[Vehicles with A/T, CVT or Twin Clutch SST]  
First, set the selector lever (A/T or CVT) or the gearshift lever (Twin Clutch SST) to the “P” (PARK) position, and then push the emergency key in at the “ACC” position and keep it depressed until it is turned to the “LOCK” position, and remove.
  2. Install the ignition switch cover.
  3. Return the emergency key into the keyless operation key.

### NOTE

- On vehicles with A/T, CVT or Twin Clutch SST, the emergency key with keyless operation key cannot be removed unless the selector lever (A/T or CVT) or the gearshift lever (Twin Clutch SST) is set to the “P” (PARK) position.
- When not using the emergency key, always install the ignition switch cover. Otherwise, there is a danger of dirt or dust getting into the keyhole of the ignition switch and causing a malfunction.

### **⚠ CAUTION**

- Do not remove the emergency key from the ignition switch while driving. The steering wheel will be locked, causing loss of control.

### **⚠ CAUTION**

- If the engine is stopped while driving, the brake servomechanism will cease to function and braking efficiency will deteriorate. Also, the power steering system will not function and it will require greater manual effort to operate the steering.
- Do not leave the emergency key in the “ON” or “ACC” position for a long time when the engine is not running, doing so will cause the battery to be discharged.
- Do not turn the emergency key to the “START” position when the engine is running, doing so could damage the starter motor.

### Steering wheel lock

E00307500095

### To lock

Turn the emergency key to the “LOCK” position.  
Turn the steering wheel until it is locked.

### To unlock

Turn the emergency key to the “ACC” position while moving the steering wheel slightly right and left.

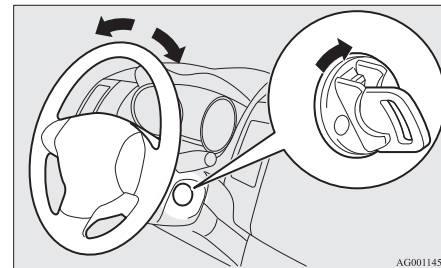

### **⚠ CAUTION**

- Remove the emergency key when leaving the vehicle.  
In some countries, it is prohibited to leave the key in the vehicle when parked.

### Starting

E00307600403

### Tips for starting

- Do not operate the starter motor continuously longer than 10 seconds; doing so could run down the battery. If the engine does not start, turn the ignition switch back to “LOCK”, wait a few seconds, and then try again.  
Trying repeatedly with the starter motor still turning will damage the starter mechanism.
- On vehicles equipped with the Twin Clutch SST, the following may occur after the en-

gine is started, but they do not indicate an abnormality.

- You may hear operational sounds of the Twin Clutch SST and you may feel vibration in the vehicle body.
  - If you shift the gearshift lever into the “N” (NEUTRAL) position and depress the accelerator pedal, increases in the engine speed will be limited.
- [Diesel-powered vehicles with M/T]

While the vehicle is stationary with the clutch pedal fully depressed, the engine revolutions do not rise to over 3,000 rpm in order to protect the engine even if the accelerator pedal is depressed.

## **⚠ WARNING**

- **Never run the engine in a closed or poorly ventilated area any longer than is needed to move your vehicle in or out of the area. Carbon monoxide gases are odourless and can be fatal.**

## **⚠ CAUTION**

- **Never attempt to start the engine by pushing or pulling the vehicle.**
- **Do not run the engine at high rpm or drive the vehicle at high speed until the engine has had a chance to warm up.**
- **Release the emergency key as soon as the engine starts to avoid damaging the starter motor.**

## **⚠ CAUTION**

- **If your vehicle is equipped with a turbocharger, do not stop the engine immediately after high-speed or uphill driving. First allow the engine to idle to give the turbocharger a chance to cool down.**

### *Starting the engine (petrol-powered vehicles)*

E00307800593

The starting procedure is as follows:

1. Fasten the seat belt.
2. Make sure the parking brake is applied.
3. Depress and hold the brake pedal.
4. Fully depress the clutch pedal (M/T).
5. On vehicles equipped with M/T, place the gearshift lever in the “N” (Neutral) position. On vehicles equipped with A/T or CVT, make sure the selector lever is in the “P” (PARK) position.

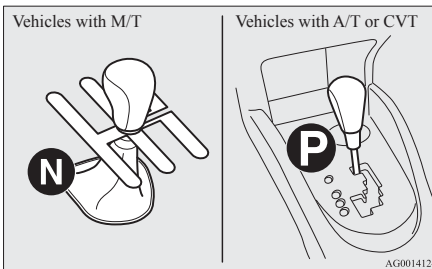

### **Locking and unlocking**

#### **NOTE**

- On vehicles equipped with A/T or CVT, the starter will not operate unless the selector lever is in the “P” (PARK) or “N” (NEUTRAL) position. For safety reasons, start the engine in the “P” (PARK) position so that the wheels are locked.
6. While pushing the lock release button (A), remove the cover of the ignition switch.

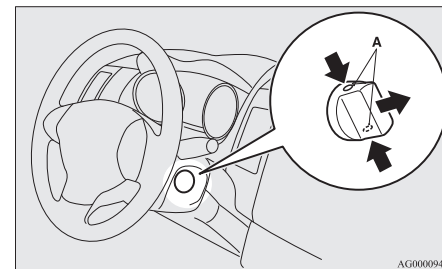

7. Insert the emergency key into the ignition switch.

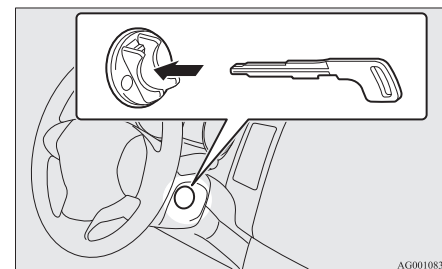

## Locking and unlocking

8. Insert the keyless operation key into the emergency key.

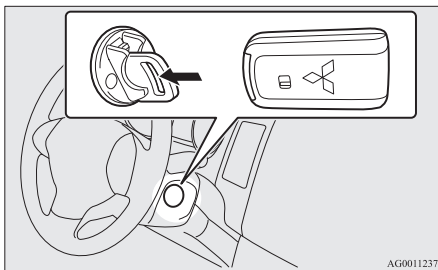

9. After turning the emergency key with the keyless operation key to the “ON” position, make sure that all warning lamps are functioning properly before starting the engine.
10. Turn the emergency key with the keyless operation key to the “START” position without depressing the accelerator pedal, and release it when the engine starts.

### NOTE

- Minor noises may be heard on engine start-up. These will disappear as the engine warms up.

11. Remove the keyless operation key from the emergency key.

## **⚠ WARNING**

- **Make sure to remove the keyless operation key from the emergency key after the engine is started. If not removed, the keyless operation key could fall to the floor, which could disturb the pedal operation.**

### NOTE

- If the emergency key is attached to a key holder, it may become impossible to insert the keyless operation key into the emergency key, and it may prevent the engine from being started. When using the emergency key to start the engine, first remove the key from the key ring.

### Using the MIVEC engine (3000 models)

The MIVEC engine automatically switches its intake-valve control between a low-speed mode and a high-speed mode in accordance with driving conditions for maximum engine performance.

### NOTE

- To protect the engine, the high-speed mode may not be selected while the engine coolant temperature is low. In such a case, the engine revolutions do not rise to over 5,000 rpm even if the accelerator pedal is depressed.

### Starting the engine (diesel-powered vehicles)

1. Fasten the seat belt.
2. Make sure the parking brake is applied.
3. Depress and hold the brake pedal.
4. Fully depress the clutch pedal (M/T).

### NOTE

- On vehicles with the Auto Stop & Go (AS&G) system, the starter will not operate unless the clutch pedal is fully depressed (Clutch interlock).
5. On vehicles equipped with M/T, place the gearshift lever in the “N” (Neutral) position. On vehicles equipped with Twin Clutch SST, make sure the gearshift lever is in the “P” (PARK) position.

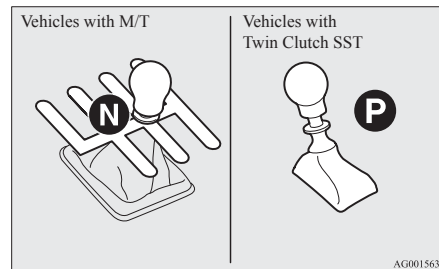

### NOTE

- On vehicles with Twin Clutch SST, the starter will not operate unless the gearshift lever is in the “P” (PARK) position or the gearshift lever is in the “N” (NEUTRAL) position with the brake pedal depressed. For safety reasons, start the engine in the “P” (PARK) position so that the wheels are locked.



6. While pushing the lock release button (A), remove the cover of the ignition switch.

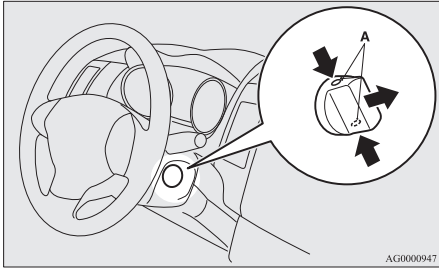

7. Insert the emergency key into the ignition switch.

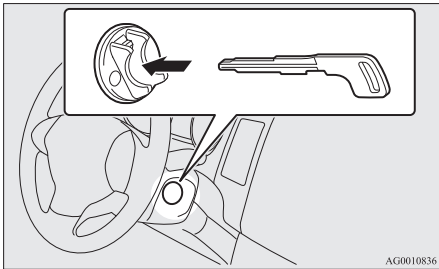

8. Insert the keyless operation key into the emergency key.

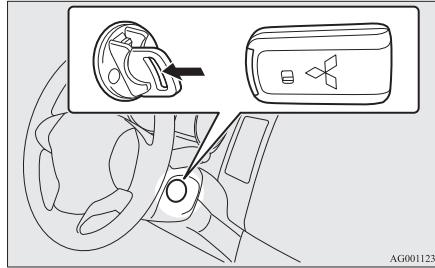

9. Turn the emergency key with keyless operation key to the “ON” position.  
The diesel preheat indication lamp will first illuminate, and then after a short time go out, indicating that preheating is completed.

#### NOTE

- If the engine is cold, the diesel preheat indication lamp is on for a longer time.
- On vehicles with Twin Clutch SST, when the engine has not been started within about 5 seconds after the diesel preheat indication lamp went out, return the ignition switch to the “LOCK” position. Then, turn the key to the “ON” position to preheat the engine again.
- When the engine is warm, the diesel preheat indication lamp does not come on even if the emergency key is placed in the “ON” position. Start the engine by turning the emergency key right to the “START” position.

10. Turn the emergency key with the keyless operation key to the “START” position without

## Locking and unlocking

depressing the accelerator pedal, and release it when the engine starts.

#### NOTE

- Minor noises may be heard on engine start-up. These will disappear as the engine warms up.

11. Remove the keyless operation key from the emergency key.

## **⚠ WARNING**

- **Make sure to remove the keyless operation key from the emergency key after the engine is started.  
If not removed, the keyless operation key could fall to the floor, which could disturb the pedal operation.**

#### NOTE

- If the emergency key is attached to a key holder, it may become impossible to insert the keyless operation key into the emergency key, and it may prevent the engine from being started. When using the emergency key to start the engine, first remove the key from the key ring.

#### Using the MIVEC engine

The MIVEC engine automatically switches its intake-valve control between a low-speed mode and a high-speed mode in accordance with driving conditions for maximum engine performance.

## Locking and unlocking

### NOTE

- To protect the engine, the high-speed mode may not be selected while the engine coolant temperature is low.

## Keyless entry system

E00307700710

1 Press the remote control switch, and all doors and the tailgate will be locked or unlocked as desired. It is also possible to operate the outside rear-view mirrors.

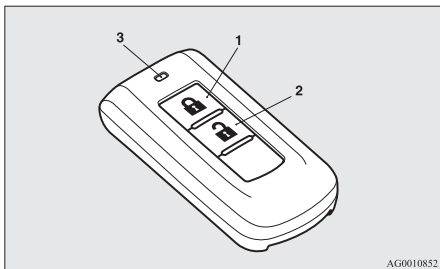

- 1- LOCK (🔒) switch
- 2- UNLOCK (🔓) switch
- 3- Indication lamp

### To lock

Press the LOCK switch (1). All the doors and the tailgate will be locked. The turn-signal lamps will blink once when the doors and the tailgate are locked.

### NOTE

- With a vehicle that has a Dead Lock System, pressing the LOCK switch (1) two times in succession causes the Dead Lock System to be set. (Refer to “Setting the system” on page 1-29.)

### To unlock

Press the UNLOCK switch (2). All the doors and the tailgate will be unlocked. If the front room lamp switch is in the “DOOR” position or the rear room lamp switch is in the middle (•) position at this time, the room lamp will come on for approximately 15 seconds and the turn-signal lamps will blink twice.

The position and tail lamps can also be set to turn on for about 30 seconds.

Refer to “Instruments and controls: Welcome light” on page 3-45.

### NOTE

- Except for vehicles equipped with a Dead Lock System, the door and tailgate unlock function can be set so that only the driver’s door unlocks when the UNLOCK switch (2) is pressed once. If the door and tailgate unlock function is set to work as described above, all the doors and the tailgate unlock when the UNLOCK switch is pressed two times in succession. Refer to “Setting of door and tailgate unlock function” on page 1-25.
- The indication lamp (3) comes on each time a switch is pressed.

- If the UNLOCK switch (2) is pressed and no door or tailgate is opened within approximately 30 seconds, relocking will automatically occur.
- It is possible to modify functions as follows: For further information, please contact your MITSUBISHI MOTORS Authorized Service Point.

On vehicles equipped with MITSUBISHI Multi-Communication System (MMCS), screen operations can be used to make the adjustment. Refer to the separate owner’s manual for details.

- The time from pressing the UNLOCK switch (2) to the moment of automatic locking can be changed.
- The confirmation function (flashing of the turn-signal lamps) can be set to operate only when the doors and backdoor are locked or only when the doors and backdoor are unlocked.
- The confirmation function (this indicates locking or unlocking of the doors and tailgate with the flash of the turn-signal lamps) can be deactivated.
- The number of times the turn-signal lamps are flashed by the confirmation function can be changed.

### Operation of the Dead Lock System

In a vehicle that has a Dead Lock System, it is possible to set the Dead Lock System using the remote controller.

(Refer to “Dead Lock System” on page 1-29.)

**Operation of the outside rear-view mirrors (Vehicles equipped with mirror retractor switch)**

E00311200178

**To fold**

Within 30 seconds of locking the doors and tailgate using the LOCK switch (1), press the LOCK switch twice rapidly to fold the outside rear-view mirrors.

**To extend**

Within 30 seconds of unlocking the doors and tailgate using the UNLOCK switch (2), press the UNLOCK switch twice rapidly to return the outside rear-view mirrors to their extended positions.

The outside rear-view mirrors are not initially set to work as described above. If you want them to work as described above, you need to set them so that they do not retract/extend when the doors and tailgate are locked/unlocked using the keyless entry system or keyless operation system.

Refer to “Starting and driving: Outside rear-view mirrors” on page 4-10.

For details, please consult a MITSUBISHI MOTORS Authorized Service Point.

In a vehicle equipped with the MITSUBISHI Multi-Communication System (MMCS), it is possible to change the setting by means of screen operations. Refer to the separate owner’s manual for details.

**NOTE**

- For vehicles equipped with the mirror retractor switch, the outside rear-view mirrors automatically retract or extend when all the doors and tailgate are locked or unlocked using the remote control switches of the keyless entry system. Refer to “Starting and driving: Outside rear-view mirrors” on page 4-10.
- The keyless entry system does not operate in the following conditions:
  - The key is left in the ignition switch.
  - The door or tailgate is open.
- The remote control switch will operate within approximately 4 m from the vehicle. However, the operating range of the remote control switch may change if the vehicle is located near a power station, or radio/TV broadcasting station.
- If either of the following problems occurs, the battery may be exhausted.
  - The remote control switch is operated at the correct distance from the vehicle, but the doors and tailgate are not locked/unlocked in response.
  - The indication lamp (3) is dim or does not come on.

For further information, please contact your MITSUBISHI MOTORS Authorized Service Point.

If you replace the battery yourself, refer to “Procedure for replacing the remote control switch battery” on page 1-26.
- If your remote control switch is lost or damaged, please contact your MITSUBISHI MOTORS Authorized Service Point for a replacement remote control switch.

- If you wish to add a remote control switch, please contact your MITSUBISHI MOTORS Authorized Service Point. A maximum of 4 remote control switches are available for your vehicle.

**Setting of door and tailgate unlock function (Except for vehicles equipped with a Dead Lock System)**

E00310400258

The door and tailgate unlock function can be set to the following two conditions.

Each time the door and tailgate unlock function is set, a chime will sound to tell you the condition of the door and tailgate unlock function.

Number of chimes	Condition
One chime	All doors and the tailgate unlock
Two chimes	Driver’s door unlock only

1. Turn the ignition switch to the “LOCK” position. If you started the engine with the key, remove the key from the ignition switch.
2. Place the combination headlamps and dipper switch in the “OFF” position, and leave the driver’s door open.
3. Press the LOCK switch (1) for 4 to 10 seconds and press the UNLOCK switch (2) during this time.
4. Release in sequence the LOCK and UNLOCK switches within 10 seconds of pressing the LOCK switch in step 3.

## Locking and unlocking

### NOTE

- On vehicles equipped with MITSUBISHI Multi-Communication System (MMCS), screen operations can be used to make the adjustment. Refer to the separate owner's manual for details.

### 1 Procedure for replacing the remote control switch battery

E00309600045

1. With the MITSUBISHI mark facing you, insert the cloth-covered tip of a straight blade (or minus) screwdriver into the notch in the case and use it to open the case.

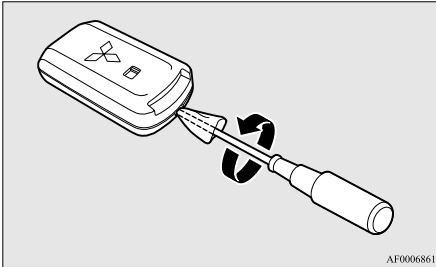

### NOTE

- Be sure to perform the procedure with the MITSUBISHI mark facing you. If the MITSUBISHI mark is not facing you when you open the case, the transmitter may come out.

2. Remove the old battery.

3. Install a new battery with the + side (A) up.

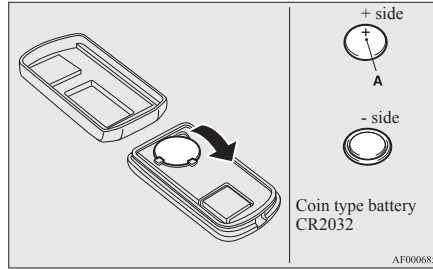

4. Close the case firmly.
5. Check the keyless operation function to see that it works.

### NOTE

- You may purchase a replacement battery at an electric appliance store.
- A MITSUBISHI MOTORS Authorized Service Point can replace the battery for you if you prefer.

### ⚠ CAUTION

- When the remote control switch case is opened, be careful to keep water, dust, etc. out. Also, do not touch the internal components.

## Doors

E00300402174

### ⚠ CAUTION

- Make sure the doors are closed: driving with doors not completely closed is dangerous.
- Never leave children in the vehicle unattended.
- Be careful not to lock the doors while the key is inside the vehicle.

### NOTE

- To prevent the key from being locked inside the vehicle, neither the lock knob on the driver's door nor the key can be used to lock the driver's door when it is open.

### To lock or unlock with the key

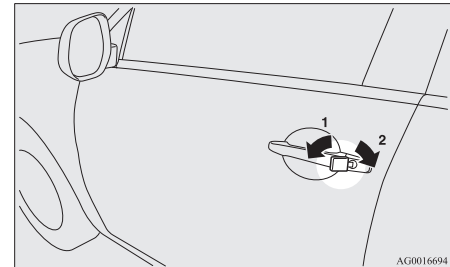

- 1- Lock
- 2- Unlock

**NOTE**

- When locking or unlocking with the key, only the driver's door will be locked or unlocked. To lock or unlock all doors and the tailgate, use the central door lock switch, the keyless entry system or the keyless operation function. Refer to "Central door locks" on pages 1-28, "Keyless entry system" on pages 1-04 and 1-24, and "To operate using the keyless operation function" on page 1-09.
- If the vehicle is equipped with the keyless operation system, the driver's door can be locked or unlocked with the emergency key. Refer to "Emergency key" on page 1-18.

**To lock or unlock from inside the vehicle**

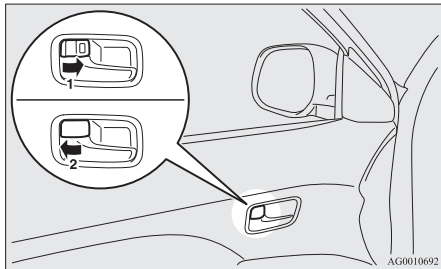

- 1- Lock
- 2- Unlock

Pull the inside door handle towards you to open the door.

**NOTE**

- The driver's door can be opened without using the lock knob by pulling on the inside door handle.
- In a vehicle that has a Dead Lock System, it is not possible to unlock the door by pushing the lock knob to the unlock side while the Dead Lock System is set. (Refer to "Dead Lock System" on page 1-29.)

**To lock without using the key**

*Front passenger's door, Rear door*

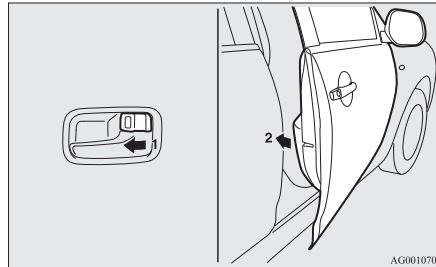

Set the inside lock knob (1) to the locked position, and close the door (2).

**NOTE**

- The driver's door cannot be locked using the inside lock knob while the driver's door is opened.

**Ignition switch on reminder system\***

E00310100372

*When the engine was started using the keyless operation function*

Type 1



Type 2



If the driver's door is opened with the ignition switch in any position other than "LOCK" (PUSH OFF) after turning off the engine, the ignition switch ON reminder buzzer sounds intermittently to remind you to turn off the ignition switch. In addition, the warning display will be displayed on the information screen in the multi-information display.

## Locking and unlocking

### Central door locks

E00300801849

#### NOTE

- Each of the doors can be locked or unlocked independently by using the inside lock knob.
- When locking or unlocking with the key on the driver's door, only the driver's door will lock or unlock.
- Repeated continuous operation between lock and unlock could activate the central door locking systems built-in protection circuit and prevent the system from operating. If this occurs, wait approximately 1 minute before operating the central door lock switch.
- When the driver's door is open, the central door lock switch cannot be used to lock it.

### To lock and unlock the doors and tailgate

#### Using the central door lock switch

Using the central door lock switch on the driver's door locks or unlocks all doors and the tailgate.

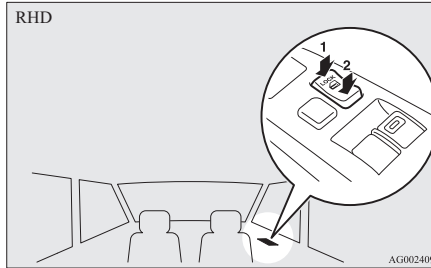
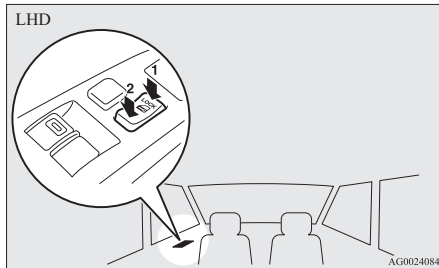

- 1- Lock
- 2- Unlock

### To unlock the doors and tailgate

E00311300182

You can select the functions to unlock the doors and tailgate either using the ignition switch position or using the selector lever (A/T or CVT) or the gearshift lever (Twin Clutch SST) position. These functions are not activated when the vehicle is shipped from the factory. To activate or deactivate these functions, please contact a MITSUBISHI MOTORS Authorized Service Point.

#### Using the ignition switch position

All doors and the tailgate will unlock whenever the ignition switch is turned to the "LOCK" position.

#### Using the selector lever (A/T or CVT) position or the gearshift lever (Twin Clutch SST) position

All doors and the tailgate will unlock whenever the selector lever (A/T or CVT) or the gearshift lever (Twin Clutch SST) is moved to the "P" (PARK) position with the ignition switch in the "ON" position.

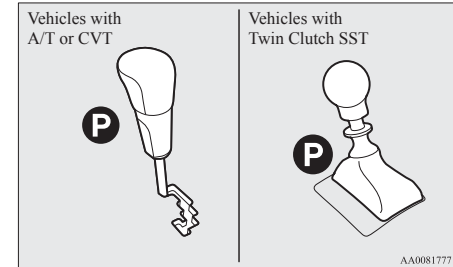

#### NOTE

- On vehicles equipped with MITSUBISHI Multi-Communication System (MMCS), screen operations can be used to make the adjustment. Refer to the separate owner's manual for details.

## Dead Lock System\*

E00305100185

The Dead Lock System helps to prevent theft. When the keyless entry system or the keyless operation system has been used to lock all of the doors and the tailgate, the Dead Lock System makes it impossible to unlock the doors using the inside lock knobs.

### **CAUTION**

- Do not set the Dead Lock System when someone is inside the vehicle. With the Dead Lock System set, it is not possible to unlock the doors using the inside lock knobs. If you erroneously set the Dead Lock System, unlock the doors using the UNLOCK switch on the remote control switch or using the keyless operation function.

### Setting the system

E00305200216

1. Turn the ignition switch to the “LOCK” position. Also, if a key was used to start the engine, remove the key from the ignition switch.
2. Get out of the vehicle. Close all of the doors and the tailgate.
3. Press the LOCK switch (A) on the remote control switch, the driver’s or front passenger’s door lock/unlock switch (B), or the tailgate LOCK switch (C) to lock all of the doors and the tailgate. The turn-signal lamps will blink once.

4. Press the switch again within 2 seconds. The turn-signal lamps will blink three times to show that the Dead Lock System has been set.

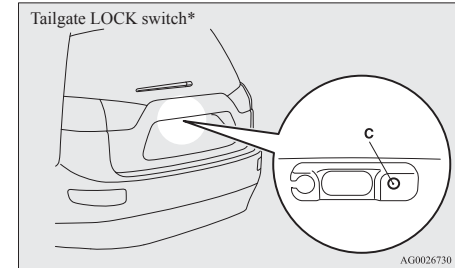
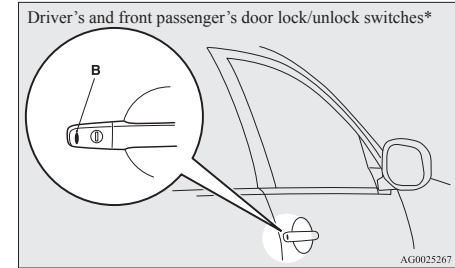
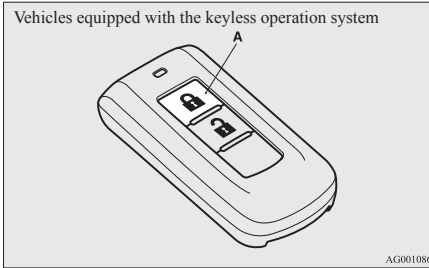
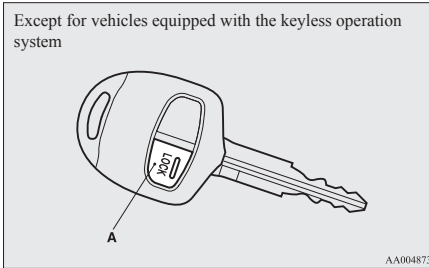

### NOTE

- Pressing the LOCK switch (A) on the remote control switch once while the Dead Lock System is set causes the turn-signal lamps to blink three times, so it is possible to confirm that the Dead Lock System is set.

### Cancelling the system

E00305300220

When the following operation is performed, the doors and tailgate will unlock and the Dead Lock System will be simultaneously cancelled.

## Locking and unlocking

- The UNLOCK switch (D) on the remote control switch is pressed.
- The driver's or front passenger's door lock/unlock switch (E) is pressed while you are carrying the keyless operation key.
- The tailgate OPEN switch (F) is pressed.

1

Except for vehicles equipped with the keyless operation system

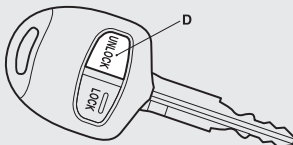

AG0024925

Vehicles equipped with the keyless operation system

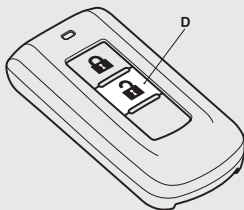

AG0024967

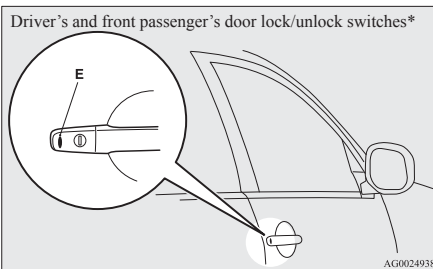

AG0024938

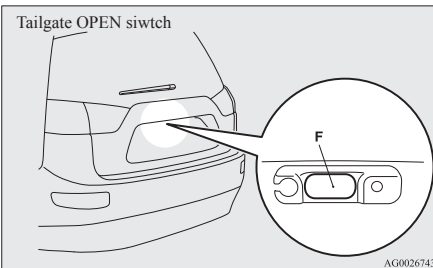

AG0026743

### NOTE

- If neither a door nor the tailgate is opened within 30 seconds of unlocking (except using the tailgate OPEN switch), the doors and tailgate are automatically relocked and the Dead Lock System is simultaneously set again.

- Even when it is not possible to use the keyless entry system or keyless operation function to unlock the doors, it is possible to use the key to unlock the driver's door. When the key is used to unlock the driver's door, the Dead Lock System is cancelled for only the driver's door. If you wish to subsequently unlock all other doors, turn the ignition switch to the "ON" or "ACC" position.

- It is possible to adjust the time between pressing the UNLOCK switch (D) on the remote control switch or the driver's or front passenger's door lock/unlock switch (E) and automatic locking. For details, please contact a MITSUBISHI MOTORS Authorized Service Point.

On vehicles equipped with MITSUBISHI Multi-Communication System (MMCS), screen operations can be used to make the adjustment. Refer to the separate owner's manual for details.

- It is possible to lock the doors and tailgate and set the Dead Lock System at the same time with a single push of the LOCK switch (A) on the remote control switch, the driver's or front passenger's door lock/unlock switch (B), or the tailgate LOCK switch (C). For details, please contact a MITSUBISHI MOTORS Authorized Service Point.

## Testing the system

E00305400074

Open all of the door windows, then set the Dead Lock System. (Refer to "Setting the system" on page 1-29.)

After setting the Dead Lock System, reach into the vehicle through a window and confirm that you cannot unlock the doors using the lock knobs.



## Split tailgate

E00301401158

### **⚠ WARNING**

- It is dangerous to drive with the tailgate (upper gate and lower gate) open, since carbon monoxide (CO) gas can enter the cabin.  
You cannot see or smell CO. It can cause unconsciousness and even death.
- When opening and closing the tailgate, make sure that there are no people nearby and be careful not to hit your head or pinch your hands, neck, etc.

### To lock

The tailgate can be locked or unlocked by using the central door lock switch (driver side).

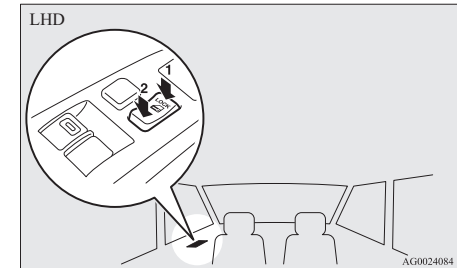

## “Child-protection” rear doors

E00300900768

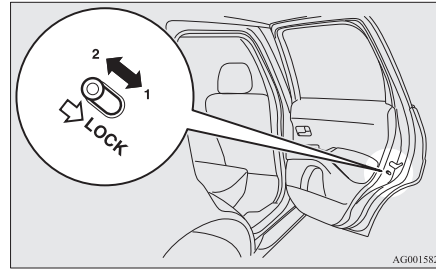

- 1- Lock
- 2- Unlock

Child protection helps prevent the rear doors from being opened accidentally from the inside. If the lever is set to the locked position, the rear door cannot be opened using the inside handle, but only with the outside handle. If the lever is set to the “Unlock” position, the child protection mechanism does not function.

### **⚠ CAUTION**

- When driving with a child in the rear seat, please use the child protection to prevent accidental door opening which may cause an accident.

### NOTE

- If you need advice on how to set the Dead Lock System, please contact a MITSUBISHI MOTORS Authorized Service Point.

## Locking and unlocking

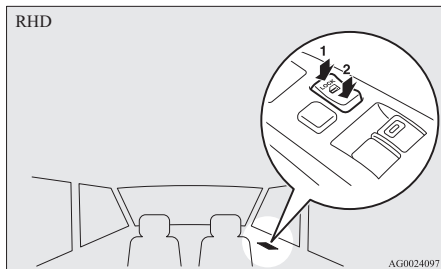

- 1- Lock
- 2- Unlock

### NOTE

- Repeated continuous operating between lock and unlock could cause the central door lock's built-in protection circuit to prevent the system from operating. If this occurs, wait approximately 1 minute before operating the central door lock switch.

### To open

1. After unlocking the tailgate, lift the upper gate.

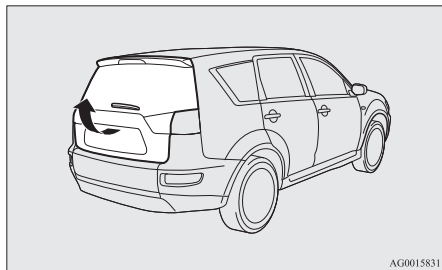

2. Move the lever (A) in the direction of the arrow and slowly fold down the lower gate.

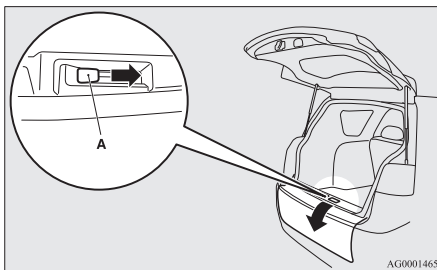

## CAUTION

- If a trailer hitch member (device for towing a trailer) is mounted, do not open the lower gate. Touching the trailer hitch could scratch the lower gate.

### NOTE

- Do not jump on to the lower gate or subject it to a strong impact. This could damage the lower gate.
- If the antenna is tipped towards the rear, place it in the upright position before opening the tailgate. Otherwise, the tailgate could hit it.
- If you do not open the tailgate immediately after pressing the tailgate OPEN switch, the tailgate can not be lifted. If this happens, press the tailgate OPEN switch again and lift the tailgate.

- The tailgate cannot be opened when the battery is flat or disconnected.

### To close

1. Raise the lower gate until it locks properly in position with a click.

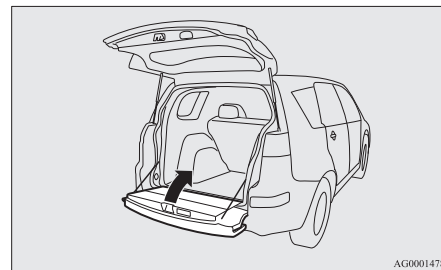

### NOTE

- Before closing the upper gate, push and pull the lower gate to make sure it is securely locked. You cannot close the upper gate unless the lower gate is properly closed.

2. Pull the upper gate grip (B) downward as illustrated. Gently shut the upper gate from the outside so that it is completely closed. Always ensure the tailgate is securely closed.

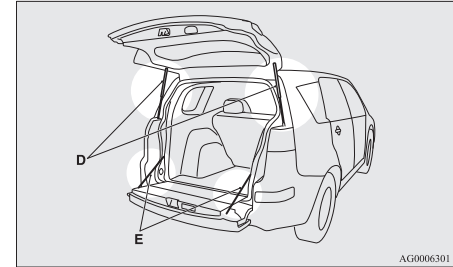
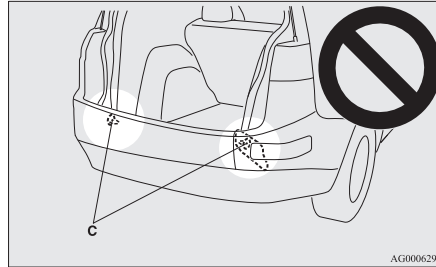
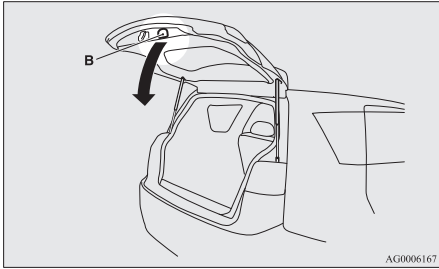

**CAUTION**

- When closing the upper gate, always ensure your or other person's fingers cannot be caught by the upper gate.
- When closing the lower gate, make sure there is no foreign matter around the striker (C). Otherwise, the bar could be damaged and it could become impossible to close the lower gate.

NOTE

- Always close the lower gate before closing the upper gate. If you try to close the gates in the reverse order, they could strike each other and be damaged.
- Gas struts (D) and wires (E) are installed to support the tailgate.

To prevent damage or faulty operation.

- Do not hold the gas struts and wires when closing the tailgate.
- Also, do not push or pull the gas struts and wires.
- Do not attach any plastic material, tape, etc., to the gas struts and wires.
- Do not tie string, etc., around the gas struts and wires.
- Do not hang any object on the gas struts and wires.

## Locking and unlocking

### *Inside tailgate release*

E00303400214

The inside tailgate release is designed to provide a way to open the tailgate in the case of a discharged battery.

The tailgate release lever (see illustration) is mounted on the tailgate.

1

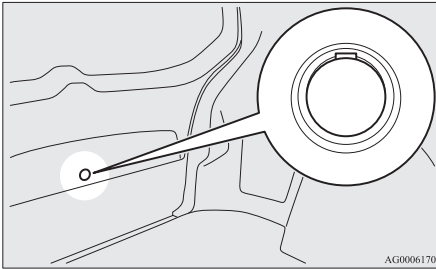

You and your family should familiarise yourselves with the location and operation of the tailgate release lever.

### To open

1. Open the lid (A) inside of the tailgate.

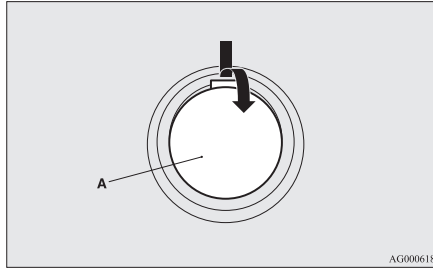

2. Move the lever (B) to open the tailgate.

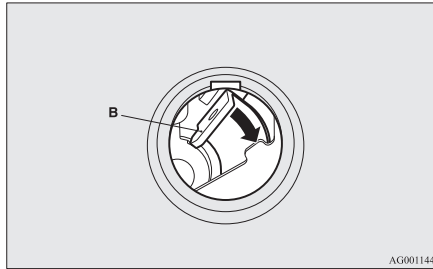

3. Push out on the upper gate to open it.
4. Slowly lower the lower gate.

### **⚠ CAUTION**

- Always keep the release lever lid on tailgate closed when driving so that your luggage cannot accidentally bump the lever and open the tailgate.

## Security alarm system\*

E00301500686

The security alarm system is for alerting the surrounding area of suspicious behaviour to prevent unlawful entry into the vehicle by operating an alarm if a door, the tailgate or the bonnet is opened when the vehicle has not been unlocked using the keyless entry system or the keyless operation function.

Also, the alarm will be activated if any of the following occur.

- Attempt an unlawful moving of the vehicle. (the impact detection function)
- Detect a motion in the vehicle. (the interior intrusion detection function)
- Disconnect the battery terminal.

The security alarm system is set to “active”.

When making changes to the settings, please follow the procedure listed in the section titled “Changing the security alarm settings” on page 1-36.

On vehicles equipped with MITSUBISHI Multi-Communication System (MMCS), screen operations can be used to make the adjustment. Refer to the separate owner’s manual for details.

### CAUTION

- Do not modify or add parts to the security alarm system. Doing so could cause the security alarm to malfunction.

### NOTE

- The alarm system will not be activated if the doors and the tailgate have been locked using a key, the inside lock knob or the central door lock switch (instead of the keyless entry system or the keyless operation function).
- If the turn-signal lamps do not blink after the locking and unlocking operation using the keyless entry system or the keyless operation function, the security alarm system may be malfunctioning.

Have the vehicle inspected at a MITSUBISHI MOTORS Authorized Service Point.

If the confirmation function (blinking of the turn-signal lamps by locking and unlocking the doors and the tailgate) is deactivated, the turn-signal lamps do not blink after the locking and unlocking operation.

For information on the confirmation function, refer to “Keyless entry system” on pages 1-04 and 1-24 and “To operate using the keyless operation function” on page 1-09.

- The security alarm system could be activated in the following situations.
  - Using a car wash
  - Taking the vehicle on a ferry
  - Parking in an automated car park
  - Leaving someone or a pet in the vehicle
  - Leaving a window or the sunroof open
  - Leaving an unstable object such as a stuffed toy or accessory in the vehicle

- Suffering a continuous impact or vibration by hail, thunder, etc.

According to the situations, deactivate the vehicle inclination detection function and the interior intrusion detection function.

Refer to “To deactivate the vehicle inclination detection function and the interior intrusion detection function” on page 1-39.

- The sensitivity of the interior intrusion detection function can be adjusted. For details, please contact a MITSUBISHI MOTORS Authorized Service Point.

### The security alarm has four modes:

#### *System preparation mode (approx. 20 seconds)*

(The buzzer sounds intermittently and the security indicator (A) blinks.)

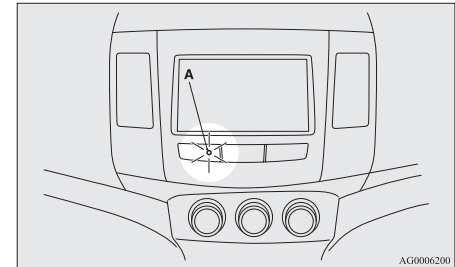

## Locking and unlocking

The system preparation time extends from the point at which all of the doors and the tailgate are locked by pressing the LOCK switch on the remote control switch or the keyless operation function to the point at which the system armed mode goes in to effect.

During this time, it is possible to temporarily open a door or the tailgate without using the keyless entry system or the keyless operation function and without causing the alarm to sound (for example, when you forget something inside the vehicle or realize that a window is open).

### System armed mode

(The buzzer stops and the security indicator continues to blink with the indicator's reduced lit-up duration time.)

Once the system preparation mode has ended, the system armed mode starts.

If an unlawful opening of any of the doors, tailgate or bonnet is detected during the system armed mode, the alarm will be activated to warn people around the vehicle of an abnormal condition.

Also, if unlawful moving of the vehicle is attempted or a vehicle intrusion is detected, the alarm will be activated.

### Alarm activation

The turn-signal lamps blink and the siren sounds for approximately 30 seconds.

Refer to "Alarm activation" on page 1-40.

#### NOTE

- The alarm will resume if unlawful actions are taken again, even if the alarm has stopped.

### System cancellation

It is possible to cancel the system activation during the system preparation mode or the system armed mode.

In addition, it is possible to cancel the alarm once it has been activated.

Refer to "Cancelling the system" on page 1-39, "Cancelling the alarm" on page 1-40.

#### NOTE

- When lending the vehicle to another person or allowing the vehicle to be driven by someone who is unfamiliar with the security alarm system, be sure to give the person a proper explanation of the security alarm system.

If a person who is unfamiliar with the security alarm system accidentally unlocked the vehicle, causing the alarm to sound, the alarm would be a nuisance to people nearby.

## Changing the security alarm settings

E00301600296

It is possible to set the security alarm to the "active" mode or "inactive" mode.

Follow the procedure below.

1. Turn the ignition switch to the "LOCK" position. If you started the engine with the key, remove the key from the ignition switch.
2. Place the lamp switch in the "OFF" position, and leave the driver's door open.

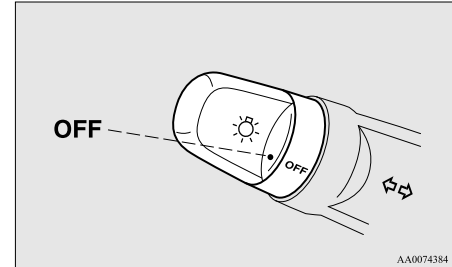

AA0074384

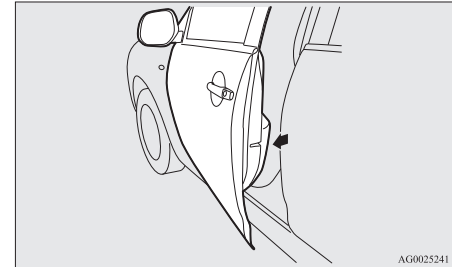

AG0025241

**Locking and unlocking**

3. Pull the windscreen wiper and washer switch towards you and hold it there. (Since the ignition switch is in the “LOCK” position, washer fluid will not be sprayed.)

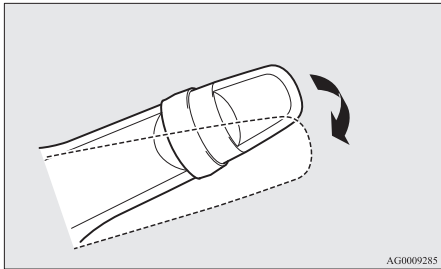

4. After approximately 10 seconds, the buzzer will make a sound. Keep the windscreen wiper and washer switch pulled towards you. (If the windscreen wiper and washer switch was released, the setting change mode would be cancelled. To start over, perform the procedure again from step 3.)

5. When the buzzer stops, with the windscreen wiper and washer switch still pulled towards you, press the UNLOCK switch (A) on the remote control switch to select the security alarm settings mode.

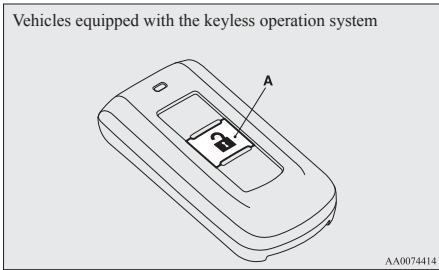
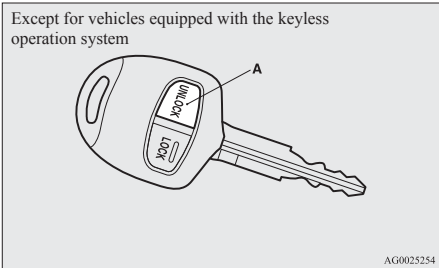

The settings mode can be toggled by pressing the UNLOCK switch. The mode can be confirmed from the number of times the buzzer sounds.

Number of times the buzzer sounds	Security alarm settings mode
1	Alarm inactive
2	Alarm active

6. Any of the following operations can be used to terminate the system settings change mode.

- Releasing the windscreen wiper and washer switch.
- Closing the driver’s door.
- Inserting the key into the ignition switch.
- The ignition switch is put into the “LOCK”(PUSH OFF) position. (vehicles equipped with the keyless operation system)
- Placing the lamp switch in any position other than “OFF”.
- Allowing 30 seconds to pass without making any changes to the settings.

**NOTE**

- If anything with regard to making changes to the security alarm system settings is hard to understand, please consult your MITSUBISHI MOTORS Authorized Service Point.
- Avoid leaving valuable items inside the vehicle even when the security alarm system has been set to the “active” mode.

**Setting the system**

E00301700734

Follow the procedure below to set the system to the system armed mode.

1. Turn the ignition switch to the “LOCK” position. If you started the engine with the key, remove the key from the ignition switch.
2. Exit the vehicle and close all of the doors, tailgate and bonnet.
3. Press the LOCK switch (A) on the remote control switch of the keyless entry system or the keyless operation system, the driver’s or front passenger’s door lock/unlock switch (B), or the tailgate LOCK switch (C) in order to lock all the doors and the tailgate.

## Locking and unlocking

1

Except for vehicles equipped with the keyless operation system

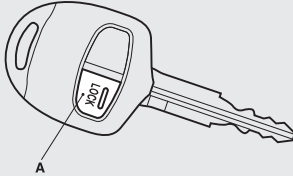

AA0048732

Vehicles equipped with the keyless operation system

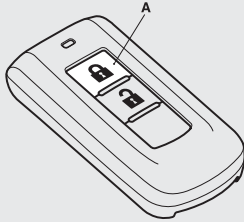

AG0010865

Driver's and front passenger's door lock/unlock switches\*

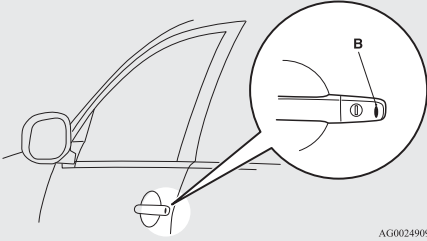

AG0024909

Tailgate LOCK switch\*

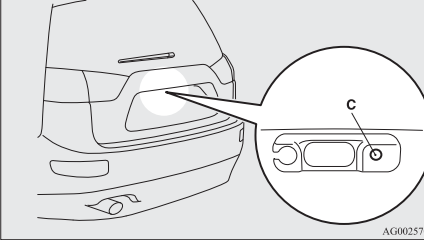

AG0025704

By locking the vehicle using the keyless entry system or the keyless operation function, the system preparation mode is activated. The buzzer makes an intermittent beeping sound and the security indicator (D) in the audio panel flashes for confirmation.

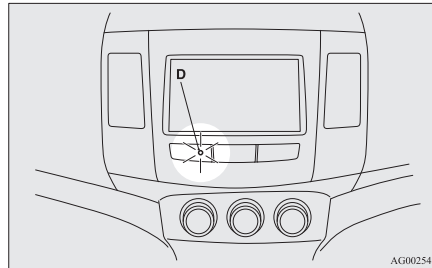

AG0025456

### NOTE

- The system preparation mode is not activated when the doors and the tailgate have been locked using a method other than the keyless entry system or the keyless operation function (namely a key, the inside lock knob or the central door lock switch).
- If the bonnet is open, the security indicator illuminates, and the system does not enter the system preparation mode. When the bonnet is closed, the system enters the system preparation mode, and after approximately 20 seconds the system enters the system armed mode.

4. After approximately 20 seconds, the buzzer stops, and when the blinking of the security indicator starts to slow down, the system armed mode goes into effect. The security indicator continues to blink during the system armed mode.

### NOTE

- The security alarm system can be activated when people are riding inside the vehicle or when the windows are open. To prevent accidental activation of the alarm, do not set the system to the system armed mode while people are riding in the vehicle.
- Avoid leaving valuable items inside the vehicle even when the security alarm system has been set to the “active” mode.



**To deactivate the vehicle inclination detection function and the interior intrusion detection function**

E00312100220

The vehicle inclination detection function and the interior intrusion detection function can be deactivated when parking in automated car parks, when leaving pets in the vehicle or when leaving the vehicle with the windows slightly open.

1. Turn the ignition switch to the “LOCK” position.

Also, if a key was used to start the engine, remove the key from the ignition switch.

2. Raise and hold the wiper and washer switch to the “MIST” position for approximately 3 seconds. The buzzer will sound once and the function will be deactivated.

To activate the function again, raise and hold the wiper and washer switch to the “MIST” position for approximately 3 seconds.

The buzzer will sound twice and the function will be activated.

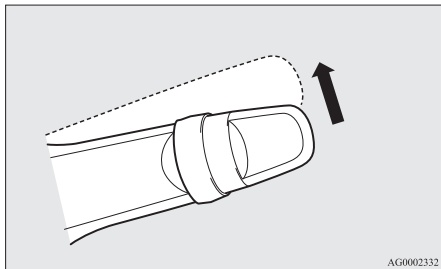

AG0002332

**NOTE**

- The function will be activated again if the following operation is performed.
  - If the doors and the tailgate are unlocked using the keyless entry system or the keyless operation function.
  - If the ignition switch is turned to the “ON” or “ACC” position.

**Cancelling the system**

E00301800605

The following methods can be used to cancel the system when it is in the system preparation mode or the system armed mode.

- Pressing the UNLOCK switch on the remote control switch.
- Turning the ignition switch to the “ON” position.
- Opening any one of the doors or the tailgate, or inserting the key into the ignition switch when the system is in the system preparation mode.
- Holding the keyless operation key and pressing the driver’s or front passenger’s door lock/unlock switch, or the tailgate OPEN switch to unlock the doors and the tailgate (vehicles equipped with the keyless operation system).

**NOTE**

- If the bonnet is opened during the system preparation mode, the system preparation mode is suspended. The system returns to the system preparation mode when the bonnet is closed.
- If the battery terminals are disconnected while the system is in the system preparation mode, the memory will be erased.

- It is possible to register up to 8 remote control switches for the keyless entry system and 4 remote control switches for the keyless operation system.

As long as they are registered, any of the remote control switches, other than the one used to activate the system, can be used to cancel the system.

If you want to register additional remote control switches, please contact a MITSUBISHI MOTORS Authorized Service Point.

- The activation distance for the keyless entry system is approximately 4 m.

If it is not possible to lock or unlock the vehicle by pressing the switch at the correct distance or the security alarm system cannot be set or cancelled using the switch, the battery may need to be replaced.

Replace the battery at a MITSUBISHI MOTORS Authorized Service Point.

- If the UNLOCK switch on the remote control switch, or the driver’s or front passenger’s door lock/unlock switch is pressed and no door or the tailgate is opened within 30 seconds, the doors and the tailgate will automatically relock. In this case as well, the system preparation mode will go into effect.

- The time between pressing the UNLOCK switch on the remote control switch, or the driver’s or front passenger’s door lock/unlock switch and automatic locking can be adjusted. Consult a MITSUBISHI MOTORS Authorized Service Point.

On vehicles equipped with MITSUBISHI Multi-Communication System (MMCS), screen operations can be used to make the adjustment. Refer to the separate owner’s manual for details.

## Locking and unlocking

### Alarm activation

E00301900749

When the system is in the system armed mode, the alarm will be activated as follows if the vehicle is unlocked or if any of the doors, tailgate or bonnet is opened using a method other than the keyless entry system or the keyless operation function.

1. The alarm will be activated for approximately 30 seconds. The turn-signal lamps will flash, and the siren will sound intermittently.

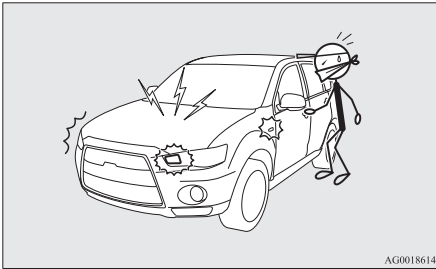

2. The alarm will resume if unlawful actions are taken again, even if the alarm has stopped.

### NOTE

- During an alarm operation, the alarm is displayed on the information screen in the multi-information display.

#### Type 1



#### Type 2



### Cancelling the alarm

E00302000545

It is possible to halt the activation of an alarm using the following methods:

- Pressing the LOCK or UNLOCK switch on the remote control switch.  
(After pressing the LOCK switch, the vehicle will lock if all the doors and the tailgate are closed, after which the system preparation mode will once again go into effect.)
- Turning the ignition switch to the “ON” position.
- Holding the keyless operation key and locking or unlocking the doors and the tailgate using the keyless operation function (vehicles equipped with the keyless operation system).

### NOTE

- When the ignition switch is turned to the “ON” position, the buzzer sounds 4 times. This operation indicates that the alarm was activated while the vehicle was parked. Please check the inside of the vehicle to confirm that nothing was stolen.
- Even if the battery is disconnected, the alarm activation memory will not be erased.

## Electric window control

E00302200446

The electric windows can only be operated with the ignition switch in the “ON” position.

### **⚠ WARNING**

- Before operating the electric window control, make sure that nothing can get trapped (head, hand, finger, etc.).
- Never leave the vehicle without removing the key.
- Never leave a child (or other person who might not be capable of safe operation of the electric window control) in the vehicle alone.
- The child may tamper with the switch at the risk of its hands or head being trapped in the window.

## Electric window control switch

E00302301675

Each door window opens or closes while the corresponding switch is operated.

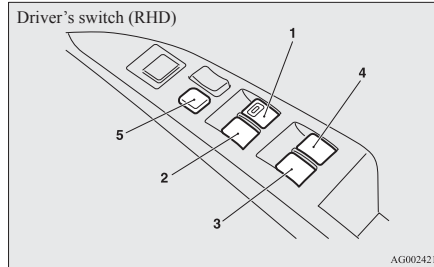
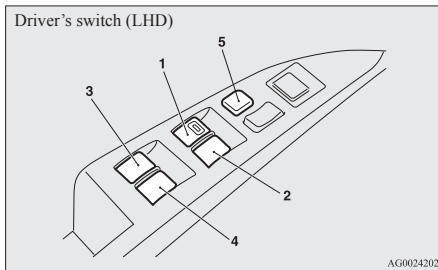

- 1- Driver's door window
- 2- Front passenger's door window
- 3- Rear left door window
- 4- Rear right door window
- 5- Lock switch

### *Driver's switches*

The switches can be used to operate all door windows. A window can be opened or closed by operating the corresponding switch.

Press the switch down to open the window, and pull up the switch to close it.

If the switch for the driver's window is fully pressed down/pulled up, the door window automatically opens/closes completely.

If you want to stop the window movement, operate the switch lightly in the reverse direction.

### *Passenger's switches*

The passenger's switches can be used to operate the corresponding passenger's door windows.

## Locking and unlocking

Press the switch down for opening the window, and pull up the switch for closing it.

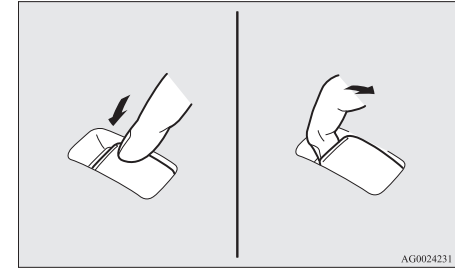

### NOTE

- Repeated operation with the engine stopped will run down the battery. Operate the window switches only while the engine is running.
- The rear door windows only open halfway.

### *Lock switch*

E00303101133

When this switch is operated, the passenger's switches cannot be used to open or close the door windows and the driver's switch cannot open or close any door windows other than the driver's door window.

## Locking and unlocking

To unlock, press it once again.

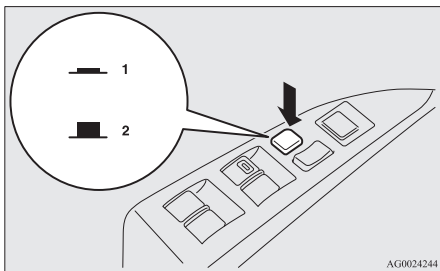

- 1- Lock
- 2- Unlock

### **⚠ WARNING**

- A child may tamper with the switch at the risk of its hands or head being trapped in the window. When driving with a child in the vehicle, please press the window lock switch to disable the passenger's switches.

## Timer function

E00302400901

The door windows can be opened or closed for 30 seconds after the ignition switch is turned from the "ON" position to the "ACC" or "LOCK" position. However, once the driver's door or the front passenger's door is opened, the windows cannot be operated.

## Safety mechanism (driver's door window only)

E00302500726

If a hand or head is trapped in the closing window, it will lower automatically.

Nonetheless, make sure that nobody puts their head or hand out of the window when closing the driver's door window.

The lowered window will become operational after a few seconds.

### **⚠ WARNING**

- If the safety mechanism is activated three or more times successively, the safety mechanism will be temporarily cancelled. If a hand or head got trapped, a serious injury could result.

### **⚠ CAUTION**

- The safety mechanism is cancelled just before the window is fully closed. This allows the window to close completely. Therefore be especially careful that no fingers are trapped in the window.
- The safety mechanism is deactivated while the switch is pulled up. Therefore be especially careful that fingers are not trapped in the door window opening.

## NOTE

- The safety mechanism can be activated if the driving conditions or other circumstances cause the driver's door window to be subjected to a physical shock similar to that caused by a trapped hand or head.
- If the safety mechanism is activated three or more times in a row, the safety mechanism will be cancelled and the door window will not close correctly.

In such a case, the following procedure should be implemented to rectify this situation. If the window is open, repeatedly raise the driver's door window switch until the window has been fully closed. Following this, release the switch, raise the switch once again and hold it in this condition for at least 1 second, then release it. You should now be able to operate the driver's door window in the normal fashion.

## Sunroof\*

E00302800282

### Sunroof

The sunroof can only be operated with the ignition switch in the "ON" position.

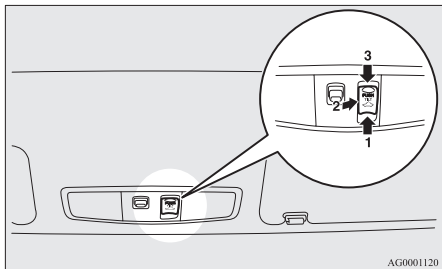

- 1- Open
- 2- Tilt up
- 3- Close, Tilt down

To open, press the switch (1).

To stop the moving sunroof, press switch (2) or (3).

#### NOTE

- The sunroof automatically stops just before reaching the fully open position. Press the switch again to fully open it.

To close, press the switch (3).

To stop the moving sunroof, press the switch (1) or (2).

To tilt up, press the switch (2).

The rear sunroof will rise to ventilate the car interior.

To tilt down, press the switch (3).

### **WARNING**

- Do not put head, hands or anything else out of the sunroof opening while driving the vehicle.
- Never leave a child (or other person who might not be capable of safe operation of the sunroof switch) in the vehicle alone.
- Before operating the sunroof, make sure that nothing is capable of being trapped (head, hand, finger, etc.).

#### Safety mechanism

If a hand or head is trapped in the closing sunroof, it will reopen automatically.

Nonetheless, make sure that nobody puts their head or hand out of the sunroof when opening or closing. The opened sunroof will become operational after a few seconds.

If the safety mechanism should be activated 5 or more times consecutively, normal closing of the sunroof will be aborted. In such an event, the following steps should be taken:

1. Tilt up the sunroof by pressing the switch (2) repeatedly.
2. Hold down the tilt up switch (2) for about 3 seconds or more.
3. Press the switch (3) to fully close the sunroof.
4. After pressing the switch (1) to open the sunroof completely, press the switch (3) to close the sunroof completely.

## Locking and unlocking

#### NOTE

- The safety mechanism can be activated if the driving conditions or other circumstances cause the sunroof to be subjected to a physical shock similar to that caused by a trapped hand or head.
- Avoid stopping the sunroof before it reaches the opening or closing end during operations. If this should accidentally happen, repeat the process from step 1.

### **CAUTION**

- The safety mechanism is cancelled just before the sunroof is fully closed. This allows the sunroof to close completely. Therefore be especially careful that no fingers are trapped in the sunroof.

5. Following this action, it should be possible to operate the sunroof in the normal manner.

### Sunshade

Slide the sunshade manually to open and close it.

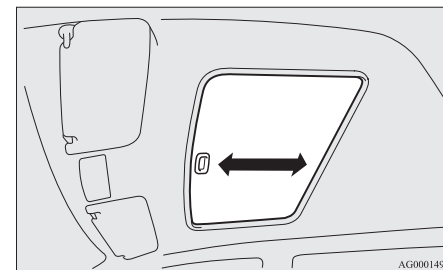

## Locking and unlocking

### **CAUTION**

- Be careful that hands are not trapped when closing the sunshade.

#### NOTE

- Be sure to tilt down the sunroof before closing the sunshade.
- The sunshade cannot be closed with the sunroof opened.
- The sunroof stops just before reaching the fully open position.  
If the vehicle is driven with the sunroof in this position, wind throb is lower than with the sunroof fully open.
- If you are going to leave the vehicle unattended, always close the sunroof and take the ignition key with you.
- Do not try to operate the sunroof if it is frozen closed (after snow fall or during extreme cold).
- Do not sit or place heavy luggage on the sunroof or roof opening edge.
- Release the switch as soon as the sunroof reaches the fully open or fully closed position.
- If the sunroof does not operate when the sunroof switch is operated, release the switch and check whether something is trapped by the sunroof. If nothing is trapped, we recommend you to have the sunroof checked.
- Depending on the model of ski carriers or roof carriers, the sunroof may make contact with the carrier when the sunroof is tilted up. Be careful when tilting up the sunroof if such a ski carrier or a roof carrier is installed.

- Be sure to close the sunroof completely when washing the vehicle or when leaving the vehicle.
- Be careful, not to put any wax on the weatherstrip (black rubber) around the sunroof opening. If stained with wax, the weatherstrip cannot maintain a weatherproof seal with the sunroof.
- After washing the vehicle or after it has rained, wipe off any water that is on the sunroof before operating it.
- Operating the sunroof repeatedly with the engine stationary will run down the battery. Operate the sunroof while the engine is running.

## *Seats and seat belts*

Seat.....	2-02
Arrangement of seats.....	2-03
Seat adjustment.....	2-05
Front seat.....	2-05
Second seat.....	2-08
Third seat (7 persons).....	2-10
Head restraints.....	2-14
Making a luggage room.....	2-15
Making a flat seat.....	2-17
Seat belts.....	2-19
Pregnant women restraint.....	2-22
Seat belt pretensioner system and force limiter system.....	2-22
Child restraint.....	2-23
Seat belt inspection.....	2-31
Supplemental restraint system (SRS) - airbag.....	2-31

## Seat

E00400101827

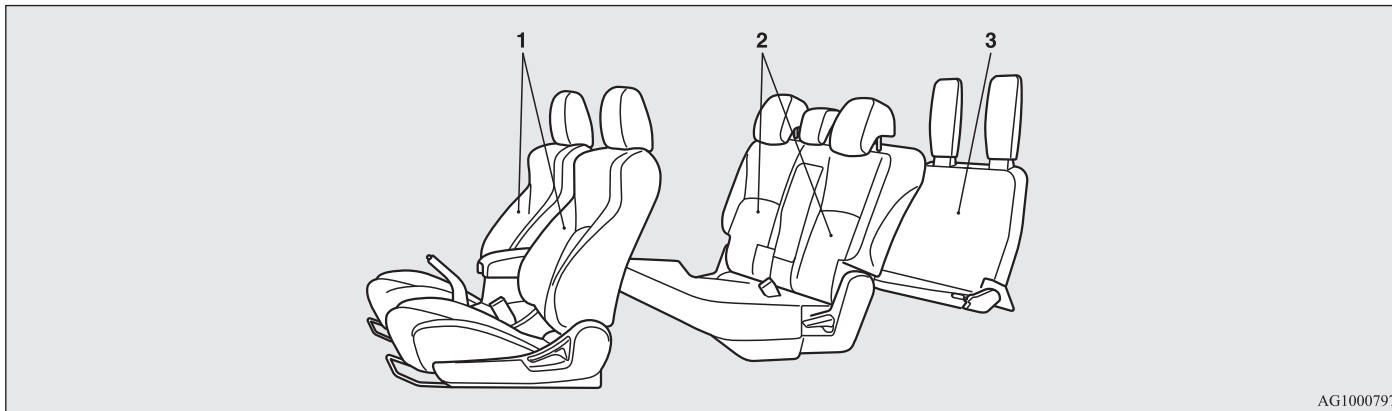

AG1000797

### 1- Front seat

- To adjust forward or backward → p. 2-05
- To recline the seatback → p. 2-06
- To adjust seat height (driver's seat only) → p. 2-07
- Armrest\* → p. 2-07
- Heated seats\* → p. 2-08

### 2- Second seat

- To adjust forward or backward (vehicles with second seat slide function) → p. 2-08
- To recline the seatback → p. 2-08
- Armrest → p. 2-09
- Accessing the underfloor-stowable third seat (7 persons) → p. 2-10

### 3- Third seat (7 persons)

- To fold out the underfloor-stowable third seat → p. 2-10





## Arrangement of seats

E00400200342

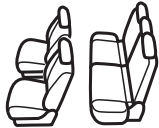
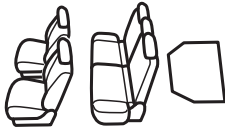
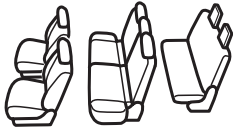
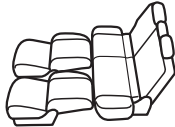
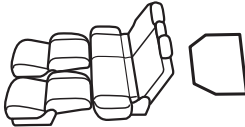
The seats can be arranged as desired to the patterns shown below.

	5 persons	7 persons
Normal usage	 <p>AGM000168</p>	 <p>AGM000230</p>
7 persons → p. 2-10	—	 <p>AGM000201</p>
Flat seat → p. 2-17	 <p>AGM000285</p>	 <p>AGM000171</p>

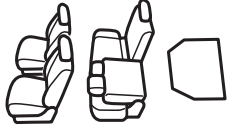
## Seats and seat belts

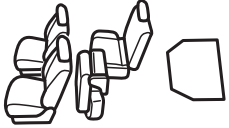
		5 persons	7 persons
Making a luggage area	To fold down the second seat → p. 2-15	 <p>AGM000184</p>	 <p>AGM000272</p>
	To fold down the second seat → p. 2-15	 <p>AGM000197</p>	 <p>AGM000214</p>

2

## Seat adjustment

E00400300271

Adjust the driver's seat so that you are comfortable and that you can reach the pedals, steering wheel, switches etc. while retaining a clear field of vision.

### **⚠ WARNING**

- Do not attempt to adjust the seat while driving. This can cause loss of vehicle control and result in an accident. After adjustments are made, ensure the seating is locked in position by attempting to move the seat forward and rearward without using the adjusting mechanism.
- Do not let children or adults ride in areas of the vehicle that are not equipped with seats or seat belts. Also, make sure that all occupants are sitting in their seats and wearing their seat belts, and that children are sitting in child restraints.
- To minimize the risk of personal injury in the event of a collision or sudden braking, the seatbacks should always be in the almost upright position while the vehicle is in motion. The protection provided by the seat belts may be reduced significantly when the seatback is reclined. There is greater risk that the passenger will slide under the seat belt, resulting in serious injury, when the seatback is reclined.

### **⚠ CAUTION**

- Make sure the seat is adjusted by an adult or with adult supervision for correct and safe operation.
- Do not place a cushion or the like between your back and the seatback while driving. The effectiveness of the head restraints will be reduced in the event of an accident.
- When sliding the seat rearward, be careful not to catch your hand or foot.

## Front seat

E00400400142

### To adjust forward or backward

E00400500462

#### Manual type

Pull the seat adjusting lever and adjust the seat forward or backward to the desired position, and release the adjusting lever.

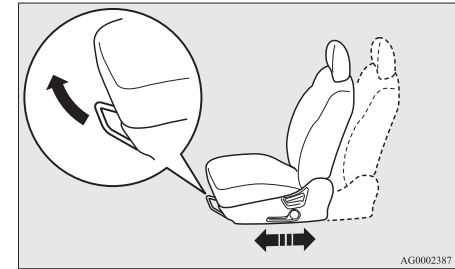

AG0002387

### **⚠ WARNING**

- To ensure the seat is locked securely, try to move the seat forward or backward without using the adjusting lever.

## Seats and seat belts

### Power type

Adjust the seat by operating the switch as indicated by the arrows.

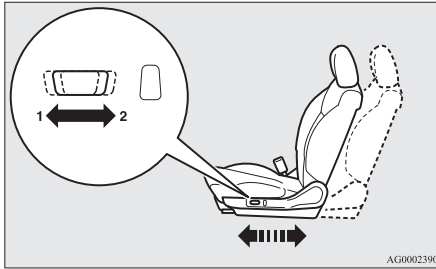

- 1- Adjustment forward
- 2- Adjustment backward

### NOTE

- To prevent the battery from discharging, use the power seat while the engine is on.

### To recline the seatback

E00400600580

#### Manual type

In order to recline the seatback, lean forward slightly, pull the seatback lock lever up, and then lean backward to the desired position and release the lever. The seatback will lock in that position.

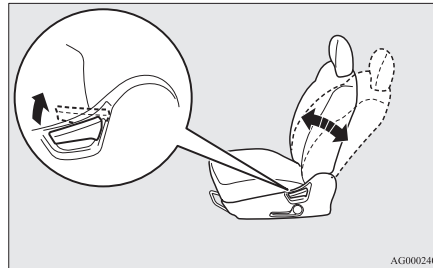

### Power type

Adjust the seatback angle by operating the switch as indicated by the arrows.

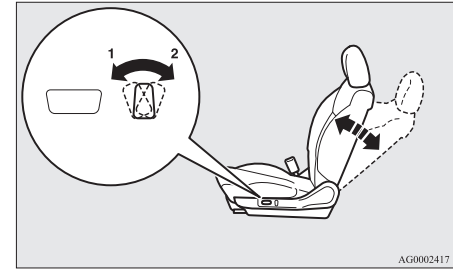

- 1- To move to forward direction
- 2- To recline rearward

### NOTE

- To prevent the battery from discharging, use the power seat while the engine is on.

## **⚠ CAUTION**

- The reclining mechanism of the seatback is spring loaded, causing it to return to the vertical position when the lock lever is operated. When using the lever, sit close to the seatback or hold it with your hand to control its return motion.

## To adjust seat height (driver's seat only)

E00400700549

### Manual type

To adjust the seat height, operate the lever repeatedly to adjust.

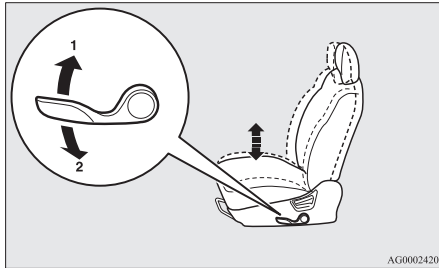

- 1- Raise
- 2- Lower

### Power type

To adjust the seat height, operate the switch as indicated by arrows.

## NOTE

- To prevent the battery from discharging, use the power seat while the engine is on.

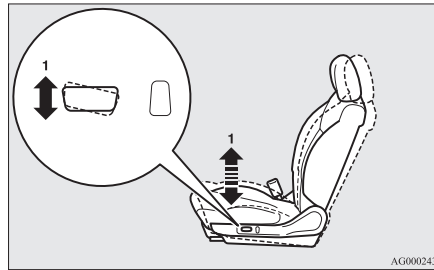

- 1- To move the front of the seat up and down

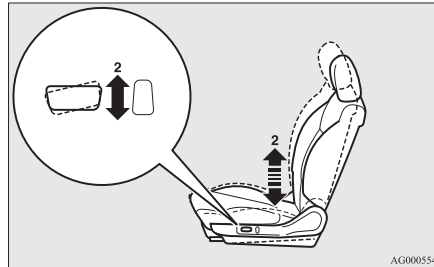

- 2- To move the rear of the seat up and down

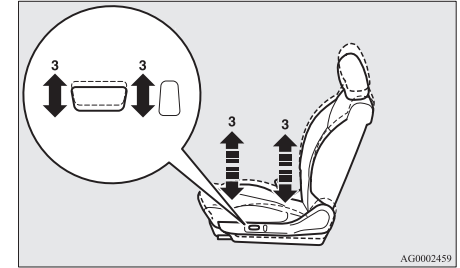

- 3- To move the whole seat up and down

## Armrest\*

E00400900378

The lid of the floor console box can be moved forward and backward, and used as an armrest.

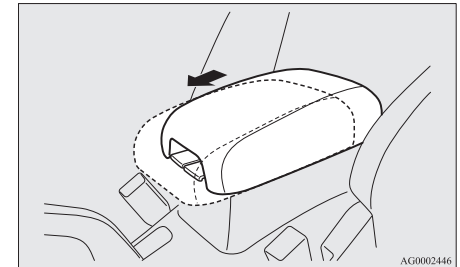

## Seats and seat belts

### Heated seats\*

E00401100742

The heated seats can be operated with the ignition switch in the “ON” position. The indication lamp (A) will illuminate while the heater is on.

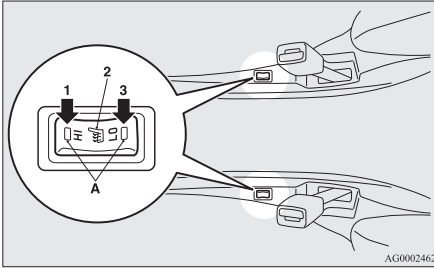

- 1 (HI)- Heater high (for quick heating).
- 2- Heater off.
- 3 (LO)- Heater low (to keep the seat warm).

### **⚠ CAUTION**

- Switch off seat heaters when not in use.
- Operate in the high position for quick heating. Once the seat is warm, set the heater to low to keep it warm. Slight variations in seat temperature may be felt while using the heated seats. This is caused by the operation of the heater’s internal thermostat and does not indicate a malfunction.
- If the following types of persons use the heated seats, they might become too hot

### **⚠ CAUTION**

or receive minor burns (red skin, heat blisters, etc.):

- Children, elderly or ill people
- People with sensitive skin
- Excessively tired people
- People under the influence of alcohol or sleep inducing medication (cold medicine, etc.)
- Do not place heavy objects on the seat or stick pins, needles, or other pointed objects into it.
- Do not use a blanket, cushion, or other material with high heat insulation properties on the seat while using the heater; this might cause the heater element to overheat
- Do not use benzine, kerosene, petrol, alcohol or other organic solvents when cleaning the seats. Doing so could damage not only the seat cover, but also the heater element.
- If water or any other liquid is spilled on the seat, allow it to dry thoroughly before attempting to use the heater.
- Turn the heater off immediately if it appears to be malfunctioning during use.

## Second seat

E00402000399

### **⚠ WARNING**

- When a person sits in the second seat, pull up the head restraint to a height at which it locks in position. Be sure to make this adjustment before starting to drive. Serious injuries could otherwise be suffered as the result of an impact. Refer to “Head restraints” on page 2-14.

### NOTE

- It is possible to adjust each side of the second seats forward and backward independently of the other side (vehicles with second seat slide function), and to adjust the seat-back angle independently on each side.

**To adjust forward or backward (vehicles with second seat slide function)**

Pull the seat adjustment lever and lightly push the seat forward or backward to the desired position. Release the adjustment lever. The seat will lock in place.

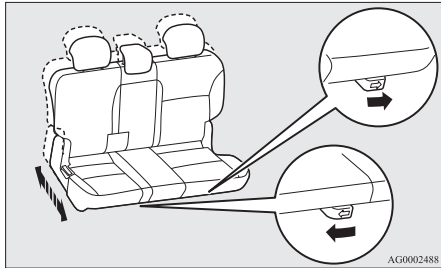

AG0002488

**⚠ WARNING**

- To make sure that the seat is securely locked in place after adjustment, try to move it forward and backward without using the adjustment lever.

**To recline the seatback**

To adjust the seatback, lean forward slightly, slowly pull up the lever, then lean backward to the desired position and release the lever. The seatback will lock in place.

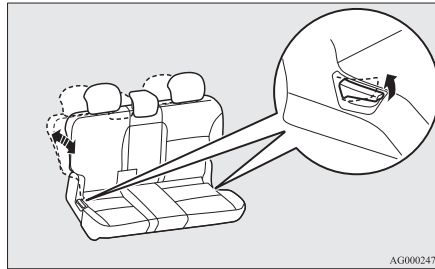

AG0002475

**⚠ WARNING**

- To reduce the risk of serious or life-threatening injuries in an accident or sudden stop, make sure that not only the driver's seat seatback but also all the other seatbacks are in an upright position while driving.
- When a person is sitting in the middle seating position of the second seat, the two sides of the second seat must have the same forward/backward position (vehicles with second seat slide function) and the same seatback angle. Otherwise, the seat belt for the middle seating position may not be adequately effective in the event of hard braking or a collision.

**⚠ CAUTION**

- A spring is loaded in the reclining mechanism of the seatback, so when operating the lock lever sit in a position close to the seatback or support the seatback with your hand.

**Armrest**

E00402400247

To use the armrest, fold it down. To return to the original position, push it backward level with the seat.

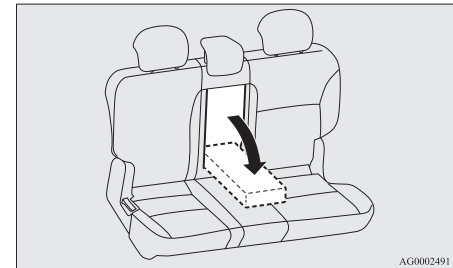

AG0002491

**NOTE**

- Do not climb or sit on the armrest. Doing so could damage the armrest.

## Seats and seat belts

### Accessing the underfloor-stowable third seat (7 persons)

E00412600040

The passenger gets on or off the third seat after folding down the second seat. Refer to “To fold down the second seat” on page 2-15.

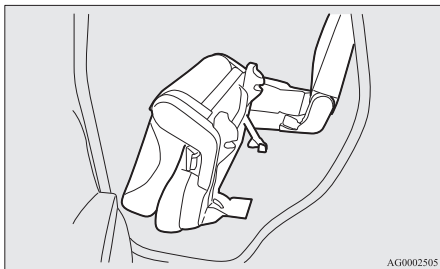

### Third seat (7 persons)

E00402700383

#### To fold out the underfloor-stowable third seat

The third seat is stowed under the floor. Use the seat when extra people ride in your vehicle. When not in use, stow the seat under the floor and use as a luggage area.

#### **⚠ WARNING**

- Make sure that you arrange the third seat before starting to drive. Arranging the seats while driving could cause them to move more than required, resulting in a serious or life-threatening injury.
- After arranging the third seat, check that the seat is securely locked in place. If the third seat is not securely locked in place, it could move and cause a serious or life-threatening injury.
- While driving, do not use the third seat with the second seat still collapsed. The second seat could fall back during sudden braking or a collision and result in a serious or life-threatening injury.
- Always make sure that the head restraints of the second seat are raised when sitting in the third seat. If the head restraints of the second seat remain lowered, it could cause a serious or life-threatening head injury during sudden braking or a collision.

#### **⚠ WARNING**

- For reasons of safety, whenever passengers sit in the third seat, be sure to raise all the head restraints of the second seats.

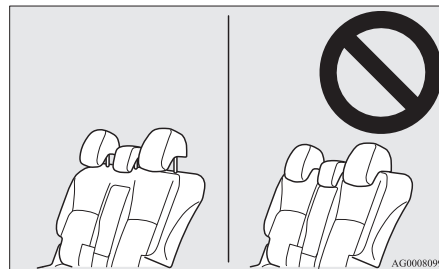

#### **⚠ CAUTION**

- Make sure that the third seat is arranged by an adult. If arranged by a child, it could result in an accident.
- When arranging the third seat, keep hands and feet away from beneath the seat and any moving parts.
- The exhaust pipe remains hot for a while after stopping the engine, so be sure not to touch it.

#### To fold out

1. Open the tailgate. Refer to “Split tailgate” on page 1-31.
2. Pull up the cover from the rear direction.



Fasten the pulled up cover to the seatback with the band (A).

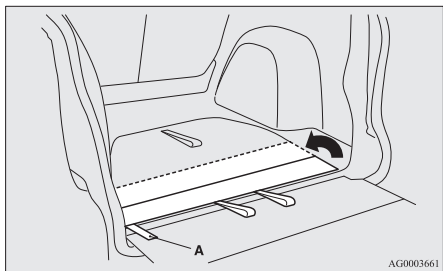

3. Pull the belt (B) located in the centre of the seatback and raise the seatback.

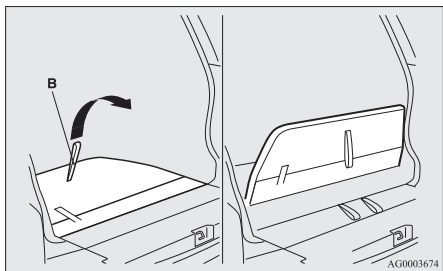

4. Pull the belt (C- black) to release the lock.

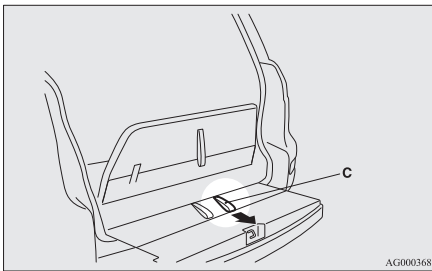

5. Tilt the whole of the third seat to the rear.

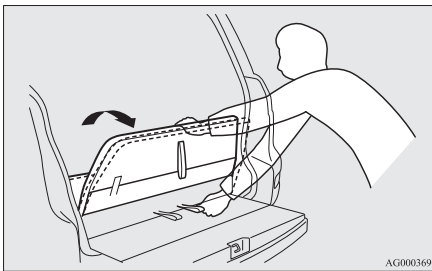

**NOTE**

- If the third seat is locked to the floor after tilting the whole of the third seat to the rear, pull the belt (C-black) again to release the lock.

6. Raise the head restraints.

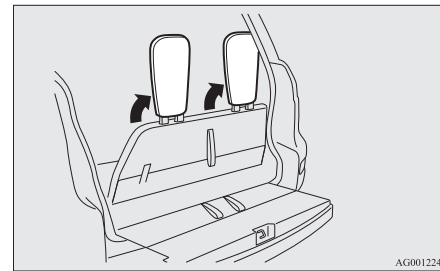

7. Lift up the whole of the third seat from the floor and fasten it to the front.

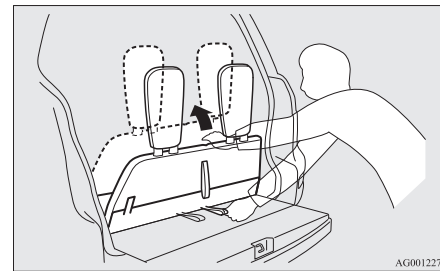

**NOTE**

- Push up the third seat to the front to make sure it is securely locked in place.

## Seats and seat belts

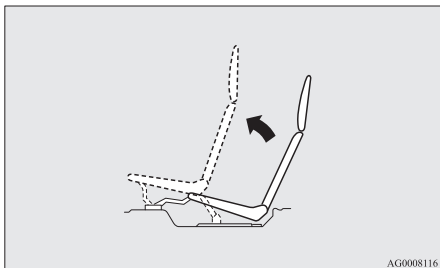

2

### **⚠ WARNING**

- When lifting up the third seat, do not put your hands in the areas indicated by the red labels (D). You could trap your fingers in the seat hinge and be injured.

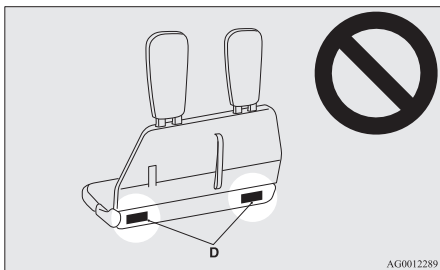

8. Return the cover to its position. Lightly push the seat and seatback to make sure they are set firmly in place.

### To retract

1. Open the tailgate. Refer to “Split tailgate” on page 1-31.
2. Pull up the cover (A) from the rear direction. Fasten the pulled up cover to the seatback with the band (B).

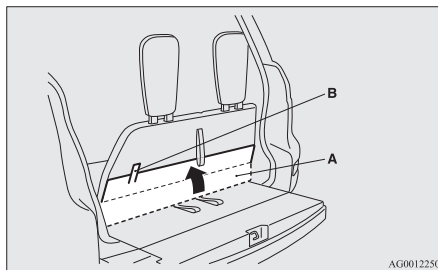

3. Slide the knob (C) while folding the head restraint to the rear, and stow to the front one side at a time.

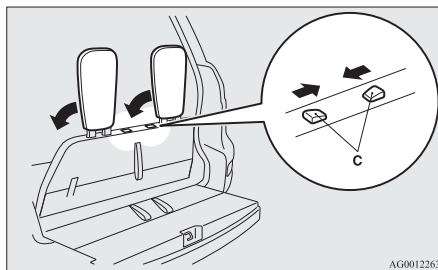

4. Stow the whole of the third seat under the floor while pulling the belt (D- grey).

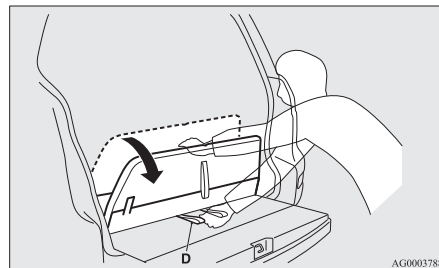

### **⚠ CAUTION**

- Do not put your hands on the end trim (E) when stowing the third seat under the floor. Doing so could trap and injure your hand.

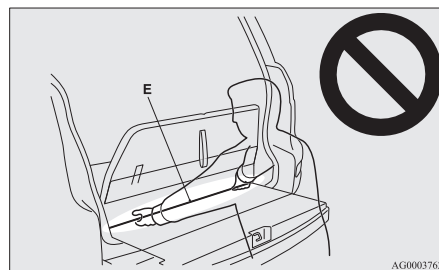

### NOTE

- Push down on the rear of the third seat until it is securely locked to the floor.

- If the third seat is difficult to lock, return it to its original position. Then push it down while pulling strongly on the belt until the rear of the third seat makes contact with the floor and locks in place.

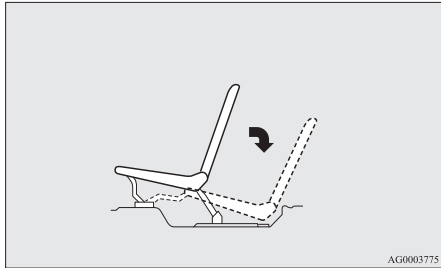

5. Tilt the whole of the seat to the front.

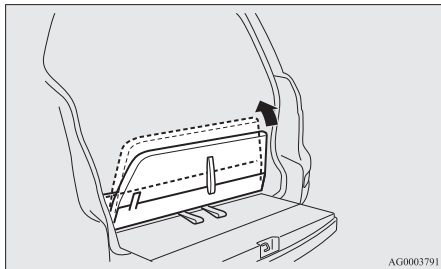

NOTE

- Before folding the seatback, make sure that the front of the third seat is securely locked to the floor.

- If the third seat is difficult to lock, make sure that the rear of the third seat is securely locked to the floor, and then strongly tilt the whole of the seat to the front to lock in place.

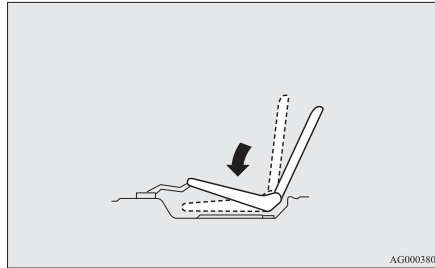

6. Fold the seatback while pulling the belt (F) located in the centre of the seatback.

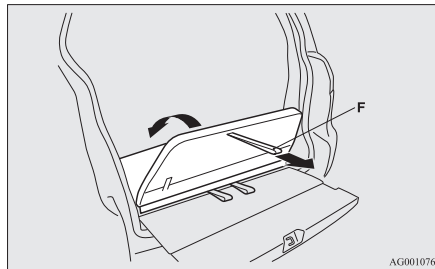

NOTE

- When stowing the third seat, make sure there is no luggage in the stowing area. If the seat is stowed while there is luggage in the stowing area, it could damage the seat.

7. Return the cover to its position.

## Head restraints

E00403301338

### **⚠ WARNING**

- Driving without the head restraints in place can cause you and your passengers serious injury or death in an accident. To reduce the risk of injury in an accident, always make sure the head restraints are installed and properly positioned when the seat is occupied.
- Never place a cushion or similar device on the seatback. This can adversely affect head restraint performance by increasing the distance between your head and the restraint.

### To adjust height

Adjust the head restraint height so that the centre of the head restraint is as close as possible to eye level to reduce the chances of injury in the event of collision. Any person too tall for the head restraint to reach their seated eye level, should adjust the restraint as high as possible.

To raise the head restraint, move it upward. To lower the restraint, move it downward while pushing the height adjusting knob (A) in the direction of the arrow. After adjustment, push the head restraint downward and make sure that it is locked.

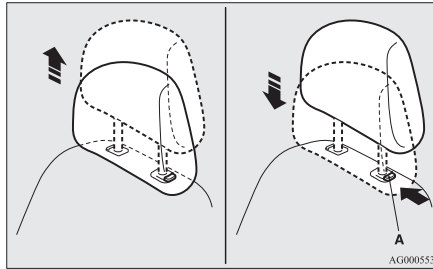

### To remove

To remove the head restraints, lift the head restraint with the height adjusting knob (A) pushed in.

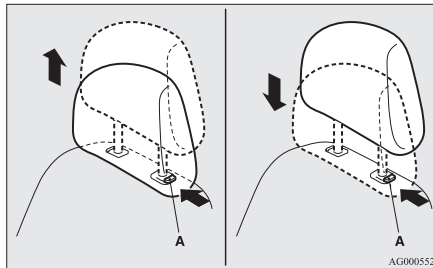

### Installation

To install the head restraints, first confirm that they are facing the correct direction, and then insert them into the seatback while pressing the height adjusting knob (A) in the direction indicated by the arrow.

### **⚠ CAUTION**

- Confirm that the height adjusting knob (A) is correctly adjusted as shown in the illustration, and also lift the head restraints to ensure that they do not come out of the seatback.

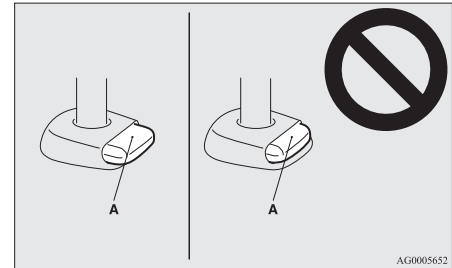

### **⚠ CAUTION**

- The head restraints for the seats differ in shape and size. When installing head restraints, make sure the head restraints are fitted in their respective seats and do not install the head restraints in the wrong direction.

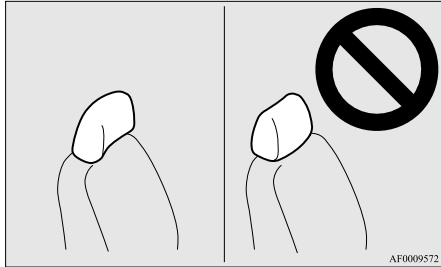

### Making a luggage room

E00403400299

#### **⚠ WARNING**

- When making a luggage area, never arrange the seats while the vehicle is being driven or is on an incline. The seats could move unexpectedly or more than required and cause a serious accident.

#### **⚠ CAUTION**

- Do not stack luggage in the vehicle higher than the seatback height. Also, firmly secure the luggage. Serious accidents could result due to unrestrained objects entering the passenger compartment during sudden braking.
- Be careful not to catch your hands or feet when arranging the seat. Personal injury could result.

### To fold down the second seat

E00403500551

The second seat can be folded down automatically with the second seat lever or the luggage area switch (if so equipped). On vehicles with a third seat, the same operation can be performed with the second seat lock release belt.

#### NOTE

- On vehicles with a third seat, fold down the second seat to get on or off the third seat. Refer to “Accessing the underfloor-stowable third seat (7 persons)” on page 2-10.
- The seatbacks can be moved one side at a time.

#### To fold down

1. Lower the head restraints of the second seat to the lowest position. Refer to “Head restraints: To adjust height” on page 2-14.
2. Use the second seat lever (A), the luggage area switch (B) (if so equipped) or the second seat lock release belt (C).

#### Second seat lever operation

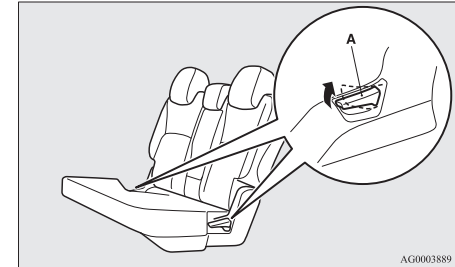

AG0003889

## Seats and seat belts

### Luggage area switch operation\*

While the tailgate or a rear door is open, pull the switch (B) for about 1 second or more.

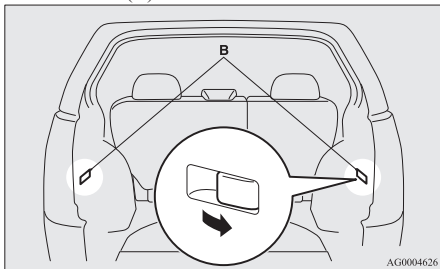

### Second seat lock release belt operation

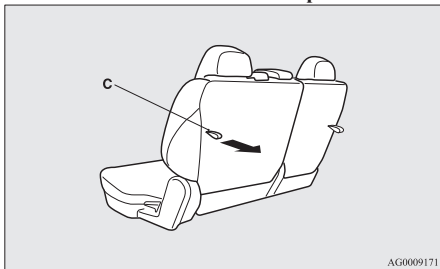

3. On vehicles with second seat slide function, the seatbacks fold forward, and then the entire seat unit rises up while moving forward.

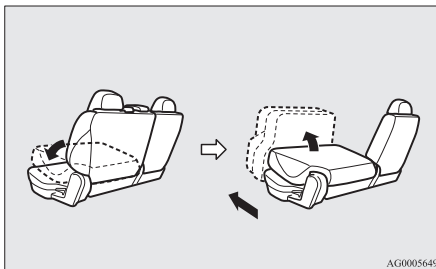

On vehicles without second seat slide function, the seatbacks fold forward. Lift the entire seat unit until you hear a “click”.

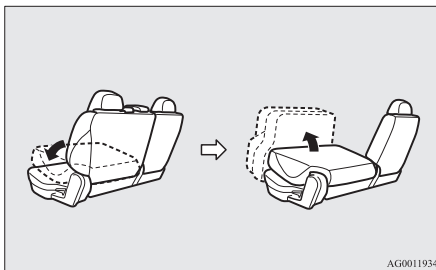

4. After these operations, lightly push the seat and seatback to make sure they are set firmly in place.

## **⚠** WARNING

- When folding the seatbacks forward from behind, an adult should perform the operation, making sure there is no one in the second seat. The seatback could fall forward suddenly and trap the person between it and the seat cushion, causing a serious injury.

It is difficult to see the second seat from behind, so be especially careful of small children.

## **⚠** CAUTION

- The exhaust pipe remains hot for a while after stopping the engine, so be sure not to touch it.
- Do not let people sit on the folded seats, and do not place luggage on them. The installation fitting of the seat could be deformed, making it impossible to secure the seat to the vehicle.

### NOTE

- Always store the buckles in the second seat cushion slits before folding the seatbacks forward. If the seatback is folded forward while the buckles are not stored, it could damage the seat. (Refer to “Second and third seat belt storage” on page 2-21.)

### To replace

1. While supporting the seat with your hand, lower the seat while pulling the lock release belt (A) on the rear of the seat cushion.

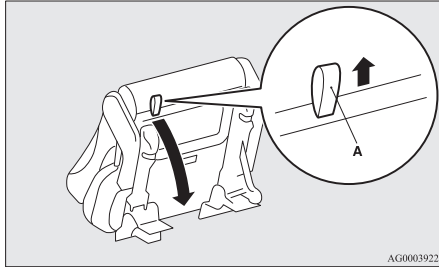

AG0003922

**CAUTION**

- On vehicles with a third seat, when returning the second seat while there are occupants in the third seat, be careful not to trap the feet of the third seat occupants with the second seat.

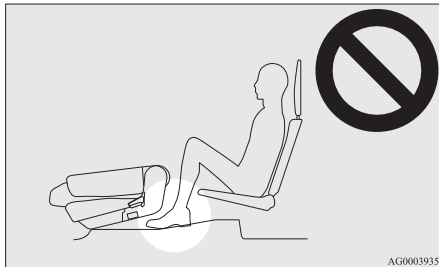

AG0003935

2. Push down the seats until they click to firmly lock in place.

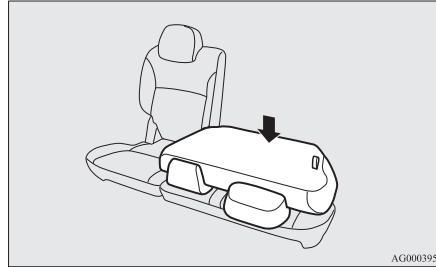

AG0003951

NOTE

- Luggage can be loaded while the seatbacks are folded forward.

3. Fold up the seatback while pulling the lock release belt on the rear of the seatback.

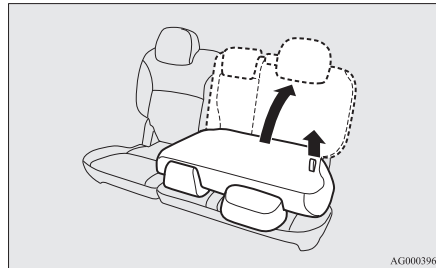

AG0003964

4. After returning the seatback, lightly push the seat and seatback to make sure they are set firmly in place.

**Making a flat seat**

E00404300471

By removing the head restraints and fully reclining the seatbacks of the seats, one large flat seat is achieved.

**WARNING**

- Never drive while there are occupants sitting on the flat seat. This can be extremely dangerous.

**CAUTION**

- To make a flat seat, stop the vehicle in a safe place.
- Make sure the seat is adjusted by an adult or with adult supervision for correct and safe operation.
- When sliding the seat, be sure not to catch your hand or leg.
- Do not walk around on top of the seats after they have been laid flat.
- To ensure the seats are locked securely, attempt to move them back and forth.
- Do not jump on, or impact the seatbacks heavily.
- To raise the seatback, raise it slowly while supporting it with your hand. Never let a child perform this operation. Doing so could result in an accident.

1. Remove the head restraints from the front seats, raise the armrest and remove the cargo area cover (if so equipped).

## Seats and seat belts

(Refer to “Head restraints” on page 2-14 and “Cargo area cover” on page 5-93)

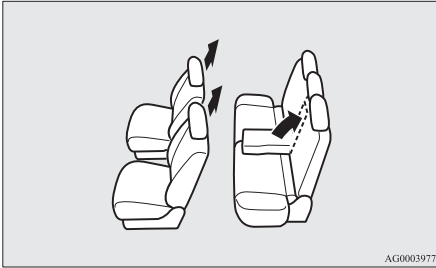

2. Move the second seat fully to the rear (vehicles with second seat slide function). (Refer to “To adjust forward or backward” on page 2-05)

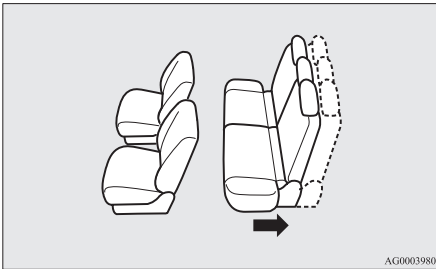

3. Slide the front seats fully forward, then recline the seatbacks backwards to achieve a flat surface.

(Refer to “To adjust forward or backward” on page 2-05 and “To recline the seatback” on page 2-06)

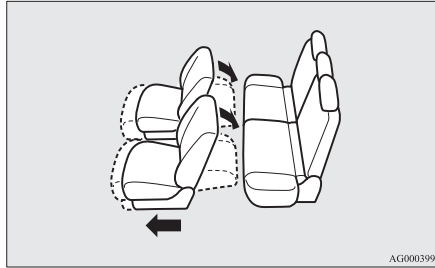

4. Recline the seatbacks of the second seat backwards. (Refer to “To recline the seatback” on page 2-06)

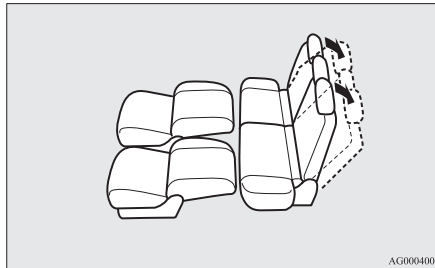

5. The flat seat configuration is now complete. To return the seats to the normal position, reverse the procedure above.

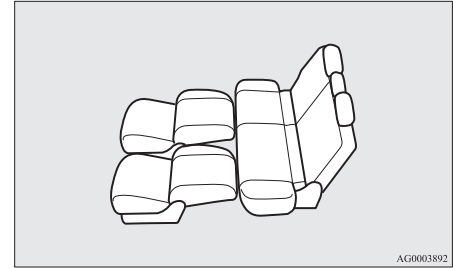



## Seat belts

E00404800636

To protect you and your passengers in the event of an accident, it is most important that the seat belts be worn correctly while driving.

The front seat belts have a pretensioner system. These belts are used the same way as a conventional seat belt.

Refer to “Seat belt pretensioner system and force limiter system” on page 2-22.

### **⚠ WARNING**

- Always place the shoulder belt over your shoulder and across your chest. Never put it behind you or under your arm.
- One seat belt should be used by only one person. Doing otherwise can be dangerous.
- The seat belt will provide its wearer with maximum protection if the recliner seatback is placed in fully upright position. When the seatback is reclined, there is greater risk that the passenger will slide under the belt, especially in a forward impact accident, and may be injured by the belt or by striking the instrument panel or seatbacks.
- Seat belts should always be worn by every adult who drives or rides in this vehicle, and by all children who are tall enough to wear seat belts properly. Other children should always use proper child restraint systems.
- Remove any twists when using the belt.

### **⚠ WARNING**

- No modifications or additions should be made by the user which will either prevent the seat belt adjusting devices from operating to remove slack, or prevent the seat belt assembly from being adjusted to remove slack.
- Never hold a child in your arms or on your lap when riding in this vehicle, even if you are wearing your seat belt. To do so risks severe or fatal injury to the child in a collision or sudden stop.
- Always adjust the belt to a snug fit.
- Always wear the lap portion of the belt over your hips.



AA0002174

### 3-point type seat belt (with emergency locking mechanism)

E00404901344

This type of belt requires no length adjustment. Once worn, the belt adjusts itself to the movement of the wearer, but in the event of a sudden or strong shock, the belt automatically locks to hold the wearer's body.

### NOTE

- You can check if the belt locks by pulling it forward quickly.

### To fasten

1. Pull the seat belt out slowly while holding the latch plate.

### NOTE

- When the seat belts cannot be pulled out in a locked condition, pull the belts once forcefully and then return them. After that, pull the belts out slowly once again.
2. Insert the latch plate into the buckle until a “click” is heard.

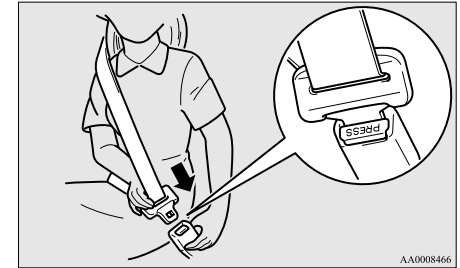

AA0008466

### **⚠ WARNING**

- Never wear the lap portion of the belt across your abdomen. During accidents it can press sharply against the abdomen and increase the risk of injury.

## Seats and seat belts

### **⚠ WARNING**

- The seat belts must not be twisted when worn.

3. Pull the belt slightly to adjust slackness as desired.

#### *To unfasten*

Hold the latch plate and push the button on the buckle.

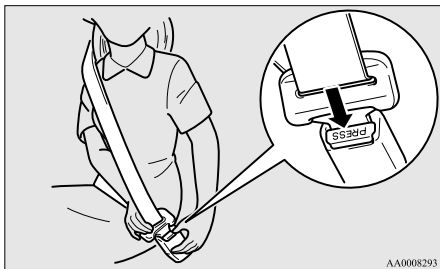

#### NOTE

- As the belt retracts automatically, keep holding the latch plate while retracting so that the belt stows slowly. Failure to do this could damage the vehicle.

### Driver's seat belt warning lamp and display

E00409800758

Warning lamp



Warning display type 1



Warning display type 2



A tone and warning lamp are used to remind the driver to fasten the seat belt.

If the ignition switch is turned to the "ON" position while a seat belt is not fastened, the warning lamp comes on and the tone sounds for about 6 seconds to remind the driver to fasten the seat belt.

If the vehicle is driven without fastening the seat belt, approximately 1 minute after the ignition switch is turned to the "ON" position, the warning lamp comes on and flashes repeatedly, and the tone sounds continuously. At the same time, the warning display is displayed on the information screen in the multi-information display.

The warning lamp goes off and the tone stops after approximately 90 seconds.

Subsequently, if the seat belt is still not fastened, the warning lamp and tone will be activated to remind the driver to fasten the seat belt whenever the vehicle is stopped and started off again. The warning will operate in the same way if the seat belt is removed while driving the vehicle. The warning will stop when the seat belt is fastened.

### Front passenger seat belt warning lamp

E00411600203

The front passenger seat belt warning lamp is located on the instrument panel.

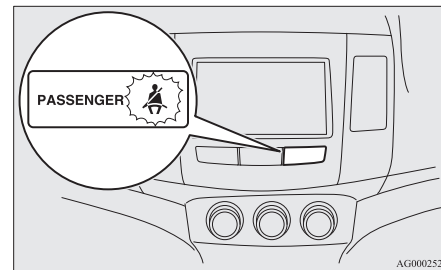

The lamp comes on when a person sits on the front passenger seat but does not fasten the seat belt. It goes off when the seat belt is subsequently fastened.

### **⚠ WARNING**

- Do not install any accessory or sticker that makes the lamp difficult to see.

### Adjustable seat belt anchor (front seats)

E00405000329

The seat belt anchor height can be adjusted. Raise or lower the seat belt anchor (A) while pressing the lock knob (B).

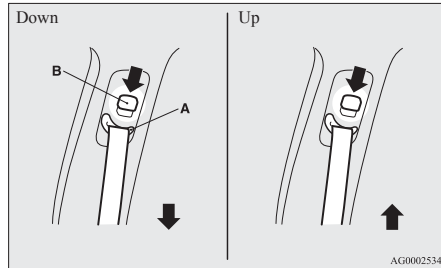

### **⚠ WARNING**

- When adjusting the seat belt anchor, set it at a position that is sufficiently high so that the belt will make full contact with your shoulder but will not touch your neck.

### Second and third seat belt storage

E00405300205

Store the second seat belts (excluding the centre seat belt) and third seat belts as shown in the illustration.

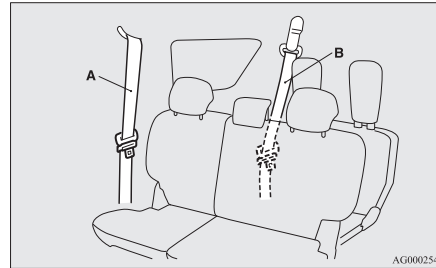

- A- Second seat belt
- B- Third seat belt (Seating 7 passengers)

### Seat belt plate storage

After passing the belt through the rear notch (C), insert the plate into the front notch (D).

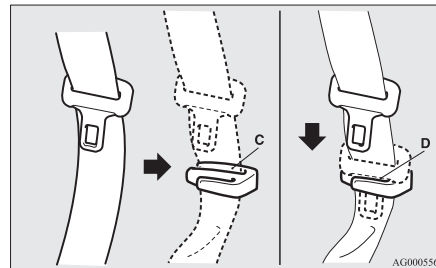

### To store the second seat belt buckles

E00412100016

When the second seat belts are not in use, insert the buckles into the seat cushion slits.

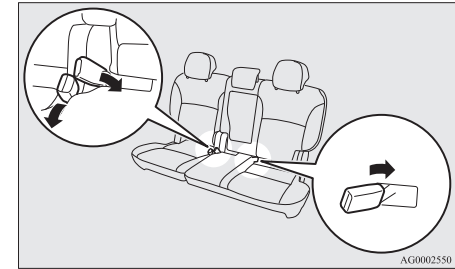

## Pregnant women restraint

E00405600077

### **WARNING**

- Seat belts work for everyone, including pregnant women. Pregnant women should use the available seat belts. This will reduce the likelihood of injury to both the woman and the unborn child. The lap belt should be worn across the thighs and as snug against the hips as possible, but not across the waist. Consult your doctor if you have any additional questions or concerns.

## Seat belt pretensioner system and force limiter system

E00405700166

The driver's seat and front passenger's seat each have a seat belt equipped with a pretensioner system.

### Pretensioner system

E00405800662

The pretensioner system will retract their respective seat belts instantaneously, thus maximizing the seat belt's effectiveness, if there is a frontal impact severe enough to injure the driver and/or front passenger and the ignition switch is in the "ON" or "START" position.

### **WARNING**

- To obtain the best results from your pretensioner seat belt, make sure you have adjusted your seat correctly and wear your seat belt properly.

### **CAUTION**

- Installation of audio equipment or repairs in the vicinity of the pretensioner seat belts or floor console must be performed in line with MITSUBISHI MOTORS guidelines. It is important to do so because the work could affect the pretensioner systems.

### **CAUTION**

- If you need to scrap the vehicle, please consult a MITSUBISHI MOTORS Authorized Service Point. It is important to do so because unexpected activation of the pretensioner seat belts could cause injuries.

### NOTE

- The pretensioner seat belts will be activated if the vehicle suffers a severe frontal impact, even if the seat belts are not worn.
- The pretensioner seat belts are designed to work only once. After the pretensioner seat belts have been activated, we recommend you have it replaced by a MITSUBISHI MOTORS Authorized Service Point.

### SRS warning

E00405900243

The same warning lamp/display is shared by the SRS airbags and the pretensioner seat belts. Refer to "SRS warning lamp/display" on page 2-40.

### Force limiter system

E00406000209

In the event of a collision, each force limiter system will effectively absorb the load applied to the seat belt to minimize the impact to the passenger.

## Child restraint

E00406401587

When transporting children in your vehicle, some type of child restraint system should always be used according to the size of the child. This is required by law in most countries.

The regulations concerning driving with children in the front seat may differ from country to country. You are advised to comply with the relevant regulations.

### **⚠ WARNING**

- When possible, put children in the rear seat. Accident statistics indicate that children of all sizes and ages are safer when properly restrained in the rear seat rather than in the front seat.
- Holding a child in your arms is no substitute for a restraint system. Failure to use a proper restraint system can result in severe or fatal injury to your child.
- Each child restraint device or fixing is to be used only by one child.
- When attaching a child restraint to the rear seat, place the front seatbacks in the upright position. Otherwise, the child could be seriously injured in the event of hard braking or a collision.

## Caution for installing the child restraint on vehicles with a front passenger airbag

The label shown here is attached on vehicles with a front passenger airbag.

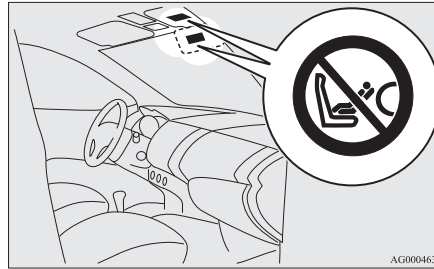

### **⚠ WARNING**

- **Extreme Hazard!**  
Do not use a rearward facing child restraint on a seat protected by an airbag in front of it!

Use rearward facing child restraints in the rear seat or turn off the front passenger's airbag ON-OFF switch. (Refer to "To turn an airbag off" on page 2-34).

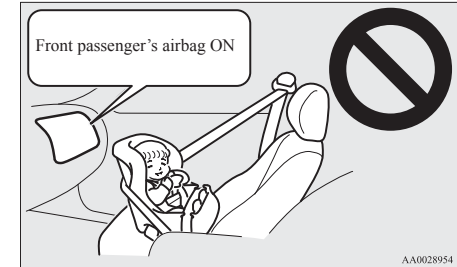

### **⚠ WARNING**

- A REARWARD FACING CHILD RESTRAINT must NOT be used in the front passenger seat if the front passenger's airbag has not been deactivated. The force of an inflating airbag could kill or cause serious injuries to the child. A rearward facing child restraint should be used in the rear seat.
- A FORWARD FACING CHILD RESTRAINT should be used in the rear seat whenever possible; if used in the front seat, adjust the seat to the most rearward position.

## Seats and seat belts



### Infants and small children

E00406600609

When transporting infants and small children in your vehicle, follow the instruction given below.

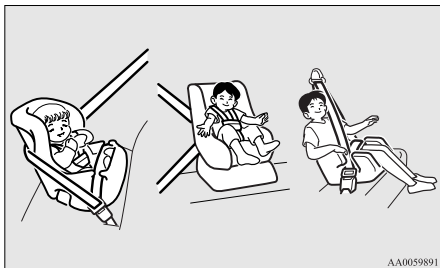

#### Instruction:

- For small infants, an infant carrier should be used. For small children whose height when seated allows the shoulder belt to lie in contact with the face or the throat, a child seat should be used.

- The child restraint system should be appropriate for the child's weight and height and properly fit in the vehicle. For a higher degree of safety: **THE CHILD RESTRAINT SYSTEM SHOULD BE INSTALLED IN THE REAR SEAT.**

#### NOTE

- Before purchasing a child restraint system, try installing it in the rear seat to make sure there is a good fit. Because of the location of the seat belt buckles and the shape of the seat cushion, it may be difficult to securely install some manufacturer's child restraint systems. If the child restraint system can be pulled forward or to either side easily on the seat cushion after the seat belt has been tightened, choose another manufacturer's child restraint system.

### **⚠ WARNING**

- **When installing a child restraint system, refer to the instructions provided by the manufacturer of the restraint system. Failure to do so can result in severe or fatal injury to the child.**
- **After installation, push and pull the child restraint system back and forth, and side to side, to see that it is properly secured. If the child restraint system is not installed securely, it may cause injury to the child or other occupants in the case of accident or sudden stops.**

### **⚠ WARNING**

- **When the child restraint system is not in use, keep your child restraint system secured with the seat belt or remove it from the vehicle in order to prevent it from being thrown around inside the vehicle during an accident.**

Depending on the seating position in the vehicle and the child restraint system that you have, the child restraint can be attached using one of the following two locations:

- To the lower anchorage in the rear seat **ONLY** if the child restraint has ISOFIX mountings (See page 2-25).
- To the seat belt (See page 2-19, 2-30).

### Older children

E00406700105

Children who have outgrown the child restraint system should be seated in the rear seat and wear combination lap shoulder belt.

The lap portion of the belt should be snug and positioned low on the abdomen so that it is below the top of the hip-bone. Otherwise, the belt could intrude into the child's abdomen during an accident and cause injury.

## Suitability for various ISOFIX positions

Mass group	Size class	Fixture	Vehicle ISOFIX positions
			Second outboard
Carrycot	F	ISO/L1	X
	G	ISO/L2	X
0 - Up to 10 kg (0-9 months)	E	ISO/R1	X
0+ - Up to 13 kg (0-2 years)	E	ISO/R1	IL* <sup>1</sup>
	D	ISO/R2	X
	C	ISO/R3	X
I - 9 to 18 kg (9 months-4 years)	D	ISO/R2	X
	C	ISO/R3	X
	B	ISO/F2	IUF
	B1	ISO/F2X	IUF, IL* <sup>2</sup>
	A	ISO/F3	IUF
II & III - 15 to 36 kg (4-12 years)			X

**Key of characters to be inserted in the table above:**

- IUF- Suitable for ISOFIX forward child restraint systems of universal category approved for use in the mass group.
- IL- Suitable for particular ISOFIX child restraint systems given in the following list (MITSUBISHI MOTORS genuine parts).
- X- ISOFIX position not suitable for ISOFIX child restraint systems in this mass group.

**IL (Genuine part information)**

	Genuine part No.	ECE No.
*1	MZ314393 (Child restraint system), MZ314394 (ISOFIX base)	E1-04301146
*2	MZ313045	E1-04301133

## Seats and seat belts

### NOTE

- MITSUBISHI MOTORS Europe B.V. reserves the right to changes without any prior announcement.  
For further information, please contact a MITSUBISHI MOTORS Authorized Service Point.



## Suitability for various seating positions

Mass group	Seating position				
	Front passenger		Second outboard	Second centre	Third
	Activated airbag	Deactivated Airbag* <sup>1</sup>			
0 - Up to 10 kg (0-9 months)	X	X	U	X	X
0+ - Up to 13 kg (0-2 years)	X	L* <sup>2</sup> , L* <sup>3</sup>	U, L* <sup>2</sup> , L* <sup>3</sup>	X	X
I -9 to 18 kg (9 months-4 years)	L* <sup>4</sup> , L* <sup>5</sup>	L* <sup>4</sup> , L* <sup>5</sup>	U, L* <sup>4</sup> , L* <sup>5</sup>	L* <sup>5</sup>	X
II & III -15 to 36 kg (4-12 years)	L* <sup>6</sup>	L* <sup>6</sup>	U, L* <sup>6</sup>	X	X

\*1: With front passenger's airbag deactivated by means of front passenger's airbag ON-OFF switch

**Key of characters to be inserted in the table above:**

- U- Suitable for "universal" category restraints approved for use in this mass group.
- L- Suitable for particular child restraint systems given in the following list (MITSUBISHI MOTORS genuine parts.).
- X- Seat position not suitable for children in this mass group.

**L (Genuine part information)**

	Genuine parts No.	ECE No.
*2	MZ312807	E1-04301146
*3	MZ314393	E1-04301146
*4	MZ314451	E1-04301203
*5	MZ313045	E1-04301133
*6	MZ314250	E1-04301169

## Seats and seat belts

### NOTE

- There is no applicable MITSUBISHI MOTORS Genuine Parts to the Mass Group “0-Up to 10 kg”.

MITSUBISHI MOTORS Europe B.V. reserves the right to changes without any prior announcement.  
For further information, please contact a MITSUBISHI MOTORS Authorized Service Point.

## Installing a child restraint system to the lower anchorage (ISOFIX child restraint mountings) and tether anchorage

E00406900615

### Lower anchorage location

Your vehicle's second seat is fitted with lower anchorages for attaching a child restraint system with ISOFIX mountings.

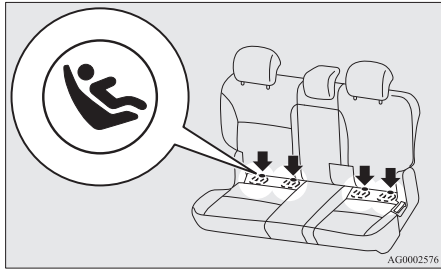

### Tether anchorage locations

There are 3 child restraint anchorage points located on the back of the second seatbacks. These are for fastening the child restraint tether straps to the 3 second seat seating positions.

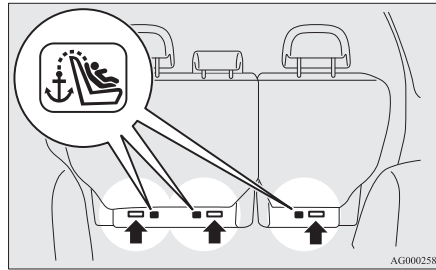

## **⚠ WARNING**

- Child restraint anchorages are designed to withstand only those loads imposed by correctly fitted child restraints. Under no circumstances are they to be used for adult seat belts, harnesses, or for attaching other items or equipment to the vehicle.

### NOTE

- Do not use the second seat centre tether anchorage with ISOFIX mountings.

### Child restraint system with ISOFIX mountings

The child restraint system is designed only for seats that incorporate lower anchorages. Retain the child restraint system using the lower anchorages.

It is not necessary to retain the child restraint system using the vehicle's seat belts.

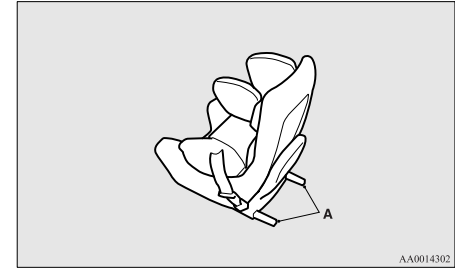

A- Child restraint system connectors

### To install

1. Remove any foreign material in or around the connectors and ensure the vehicle seat belt is in its normal storage position.

## Seats and seat belts

2. Push the child restraint system's connectors (A) into the slit (B) in accordance with the instructions provided by the child restraint system's manufacturer.

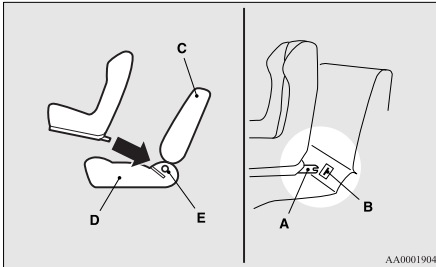

- A- Connector
- B- Slit
- C- Vehicle seatback
- D- Vehicle seat cushion
- E- Lower anchorage

3. Remove the head restraint from the location in which you wish to install a child restraint.

4. Latch the tether strap hook (F) of the child seat to the tether anchorage bar (G) and tighten the top tether strap hook so it is securely fastened.

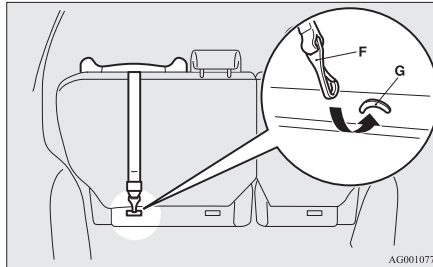

5. Push and pull the child restraint in all directions to be sure it is secure.

### To remove

Remove the child restraint in accordance with the instructions provided by the child restraint system's manufacturer.

## Installing a child restraint system to a 3-point type seat belt (with emergency locking mechanism)

E00408700196

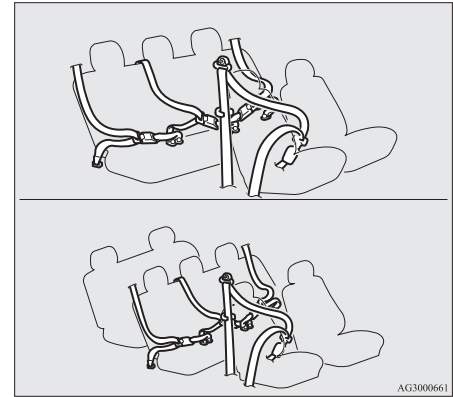

### Installation:

1. Fasten the seat belt to secure the child restraint system. Make sure you hear a "click" when you insert the latch plate in the buckle.
2. Use the locking clip to completely eliminate any slackness.
3. Push and pull the child restraint in all directions to be sure it is secure.

## **⚠ WARNING**

- For some types of child restraint, the locking clip (A) should be used to help avoid personal injury during a collision or sudden manoeuvre. It must be fitted and used in accordance with the child restraint manufacturer's instructions. The locking clip must be removed when the child restraint is removed.

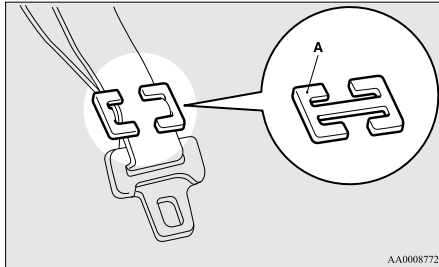

## *Seat belt inspection*

E00406300475

- Check the belts for cuts, worn or frayed webbing and for cracked or deformed metal parts. Replace the belt assembly if it is defective.
- A dirty belt should be cleaned with neutral detergent in warm water. After rinsing in water, let it dry in the shade. Do not attempt to bleach or re-dye the belts because this will affect their characteristics.

## **⚠ WARNING**

- We recommend you have all seat belt assemblies including retractors and attaching hardware inspected after any collision. We recommend that seat belt assemblies in use during a collision be replaced unless the collision was minor and the belts show no damage and continue to operate properly.
- Do not attempt to repair or replace any part of the seat belt assemblies; we recommend you have this work done by a MITSUBISHI MOTORS Authorized Service Point. Incorrect repair or replacement could reduce the effectiveness of the belts and could result in serious injury in the event of a collision.
- Once the pretensioner has been activated, it cannot be re-used. It must be replaced together with the retractor.

## *Supplemental restraint system (SRS) - airbag*

E00407201410

The information for SRS airbags includes important information concerning the driver's and front passenger's airbags, the side airbags and the curtain airbags.

The SRS airbags are designed to supplement the primary protection of the driver and front passenger side seat belt systems by providing those occupants with protection against head and chest injuries in certain moderate-to-severe frontal collisions.

A dual-stage airbag system is used where the SRS airbags for the driver's and front passenger's seats are controlled with impact sensors (on the front of the vehicle and in the centre of the vehicle floor).

The SRS side airbags (if so equipped) are designed to supplement properly worn seat belts and provide the driver and front passenger with protection against chest and abdomen injuries in certain moderate-to-severe side impact collisions.

The SRS curtain airbags (if so equipped) are designed to supplement properly worn seat belts and provide the driver and passenger with protection against head injuries in certain moderate-to-severe side impact collisions.

The SRS is NOT a substitute for the seat belts. To ensure the maximum protection during all types of collisions and accidents, all occupants, including the passengers as well as the driver, must wear their seat belts.

## Seats and seat belts

### How the Supplemental Restraint System works

E00407301381

The SRS includes the following components:

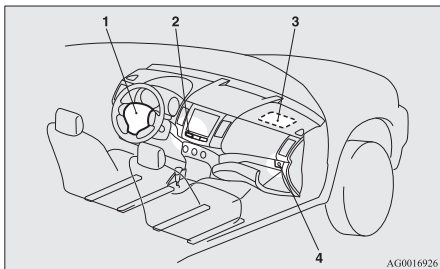

- 1- Airbag module (Driver)
- 2- Front passenger's airbag OFF indication lamp
- 3- Airbag module (Passenger)
- 4- Front passenger's airbag ON-OFF switch

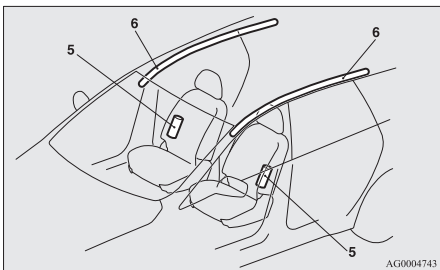

- 5- Side airbag modules\*
- 6- Curtain airbag modules\*

The airbags will operate only when the ignition switch is in the "ON" or "START" position.

The airbags deployment produces a sudden, loud noise, and releases some smoke and powder, but these conditions are not injurious, and do not indicate a fire in the vehicle. People with respiratory problems may feel some temporary irritation from chemicals used to produce the deployment; open the windows after airbag deployment, if safe to do so.

The airbags deflate very rapidly after deployment, so there is little danger of obscured vision.

### **⚠ CAUTION**

- Airbags inflate at an extremely rapid speed. In certain situations, contact with inflating airbags can result in abrasions, bruises, and the like.

### **⚠ WARNING**

- **IT IS VERY IMPORTANT TO BE PROPERLY SEATED.**

A driver or front passenger too close to the steering wheel or instrument panel during airbag deployment can be killed or seriously injured.

Airbags inflate very fast, and with great force.

If the driver and front passenger are not properly seated and restrained, the airbags may not protect you properly, and could cause serious or fatal injuries when it inflates.

- Do not sit on the edge of the seat, or lean head or chest close to the steering wheel or instrument panel. Do not put feet or legs on or against the instrument panel.

### **⚠ WARNING**

- Place all infants and small children in the rear seat and properly restrained using an appropriate child restraint system. The rear seat is the safest for infants and children.

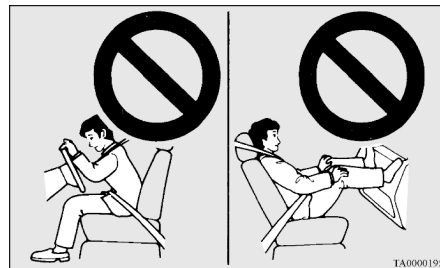

TA0000195

### **⚠ WARNING**

- Infants and small children should never be unrestrained, stand up against the instrument panel or held in your arms or on your lap. They could be seriously injured or killed in a collision, including when the airbag inflates. They should be properly seated in the rear seat in an appropriate child restraint system. See the "Child restraint" section of this owner's manual.

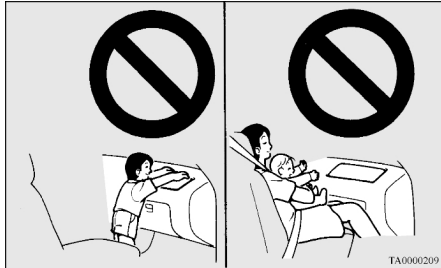

Use rearward facing child restraints in the rear seat or turn off the front passenger's airbag ON-OFF switch. (Refer to "To turn an airbag off" on page 2-34).

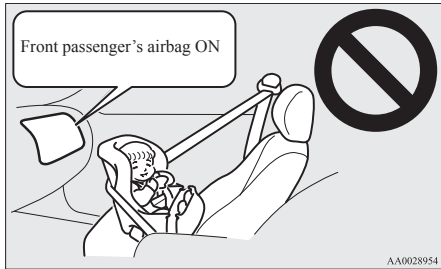

**⚠ WARNING**

- A REARWARD FACING CHILD RESTRAINT must NOT be used in the front passenger seat if the front passenger's airbag has not been deactivated. The force of an inflating airbag could kill or cause serious injuries to the child. A rearward facing child restraint should be used in the rear seat.
- A FORWARD FACING CHILD RESTRAINT should be used in the rear seat whenever possible; if it must be used in the front passenger seat, adjust the seat to the most rearward position. Failure to do so could kill or cause serious injuries to the child.



**⚠ WARNING**

- Older children should be seated in the rear seat, properly wearing the seat belt, with an appropriate booster seat if needed.

**Caution for installing the child restraint on vehicles with a front passenger airbag**

E00408800038

The label shown here is attached on vehicles with a front passenger airbag.

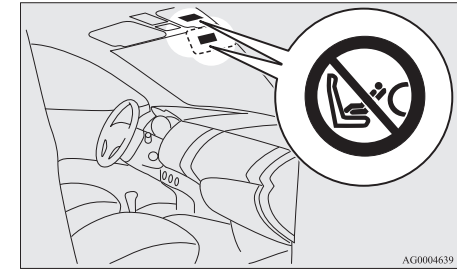

2

**⚠ WARNING**

- Extreme Hazard!  
Do not use a rearward facing child restraint on a seat protected by an airbag in front of it!

**Front passenger's airbag ON-OFF switch**

E00410100230

The front passenger's airbag ON-OFF switch can be used to disable the front passenger's airbag. If you have a rearward facing child restraint system that cannot be fitted to any seat other than the front passenger seat, be sure to turn OFF the front passenger's airbag ON-OFF switch before using it. (Refer to "To turn an airbag off" on page 2-34)

## Seats and seat belts

The front passenger's airbag ON-OFF switch is located in the glove box.

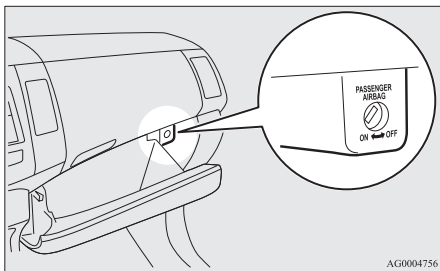

## Front passenger's airbag OFF indication lamp

E00410200130

The front passenger's airbag OFF indication lamp is located in the instrument panel.

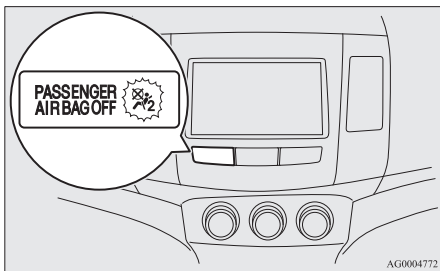

The indication lamp normally comes on when the ignition switch is turned to the "ON" position, and goes off a few seconds later.

When the front passenger's airbag ON-OFF switch is turned OFF, the indication lamp will stay on to show that the front passenger's airbag is not operational. When the front passenger's airbag ON-OFF switch is turned ON, the indication lamp goes off to show that the front passenger's airbag is operational.

## ⚠ WARNING

- Do not fit any accessory that makes the indication lamp impossible to see, and do not cover the indication lamp with a sticker. You would not be able to verify the status of the passenger airbag system.

### To turn an airbag off

E00412300050

## ⚠ WARNING

- To reduce risk of serious or fatal injury:
  - Always remove the key from the ignition switch before operating the front passenger's airbag ON-OFF switch. Failure to do so could adversely affect the airbag performance.
  - Wait at least 60 seconds to operate the front passenger's airbag ON-OFF switch after turning the ignition switch from "ON" position to "LOCK" position. The SRS airbag system is designed to retain enough voltage to deploy the airbag.

## ⚠ WARNING

- Always remove the key from the front passenger's airbag ON-OFF switch after operating that switch. Failure to do so could lead to improper position of the front passenger's airbag ON-OFF switch.
- Do not turn OFF the front passenger's airbag ON-OFF switch except when a rearward facing child restraint system is fitted to the front passenger seat.
- If the indication lamp does not come on when the front passenger's airbag ON-OFF switch is turned OFF, do not fit a rearward facing child restraint system to the front passenger seat. We recommend you to have the system inspected by a MITSUBISHI MOTORS Authorized Service Point.
- If the indication lamp remains on when the front passenger's airbag ON-OFF switch is turned ON, do not allow anyone to sit on the front passenger seat. We recommend you to have the system inspected by a MITSUBISHI MOTORS Authorized Service Point.

To turn an airbag off, follow these steps:

1. Insert the key into the front passenger's airbag ON-OFF switch, and turn it to the "OFF" position.
2. Remove the key from the key opening of the front passenger's airbag ON-OFF switch.



3. Insert the key into the ignition switch, and turn the ignition to the "ON" position. The front passenger's airbag OFF indication lamp will stay on.

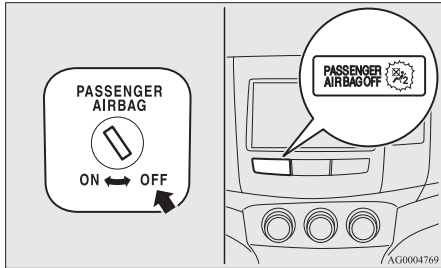

The front passenger's airbag is now deactivated and will not deploy until switched on again.

### Driver's and front passenger's airbag system

E00407400691

The driver's airbag is located under the padded cover in the middle of the steering wheel. The front passenger's airbag is contained in the instrument panel above the upper glove box.

The driver's airbag and the front passenger's airbag are designed to inflate at the same time even if the passenger seat is not occupied.

The driver's airbag inflates at two different rates according to the severity of the impact.

The front passenger's airbag deploys at the same time as the driver's airbag, even if the passenger seat is not occupied, and inflates at two different rates according to the severity of the impact.

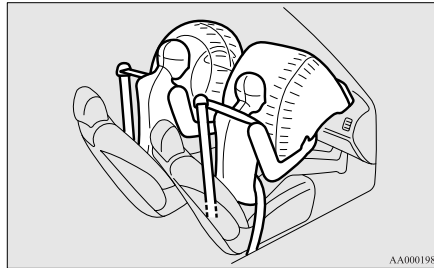

### Deployment of front airbags

E00407501530

**The front airbags ARE DESIGNED TO DEPLOY when...**

The front airbags are designed to deploy when the vehicle suffers a moderate to severe frontal impact. Examples of some typical conditions are shown in the illustration.

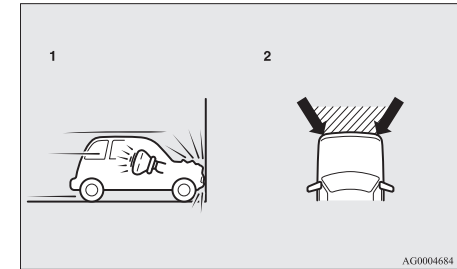

- 1- Head-on collision with a solid wall at speed of approximately 25 km/h (15 mph) or higher
- 2- Moderate to severe frontal impact within the shaded area between the arrows

The front airbags will deploy if the severity of impact is above the designed threshold level, comparable to an approximately 25 km/h (15 mph) collision when impacting straight into a solid wall that does not move or deform. If the severity of the impact is below the above threshold level, the front airbags may not deploy. However, this threshold speed will be considerably higher if the vehicle strikes an object that absorbs the impact by either deforming or moving (for example, another stationary vehicle, pole or a guard rail).

## Seats and seat belts

Because frontal collisions can easily move you out of position, it is important to always properly wear your seat belts. Your seat belts will help keep you a safe distance from the steering wheel and instrument panel during the initial stages of airbag deployment. The initial stage of airbag inflation is the most forceful, and can possibly cause serious or fatal injuries. Moreover, the seat belts in your vehicle are your primary means of protection in a collision. The SRS (Supplemental Restraint System) airbags are designed to provide additional protection. Therefore, for your safety and the safety of all occupants, be sure to always properly wear your seat belts.

### ***The front airbags MAY NOT DEPLOY when...***

With certain types of frontal collisions, the vehicle's body structure is designed to absorb the shock to help protect the occupants from harm. (The vehicle body's front area may deform significantly as it absorbs the impact.) Under such circumstances, the front airbags may not deploy irrespective of the deformation and damage to the vehicle body.

Examples of some typical conditions are shown in the illustration.

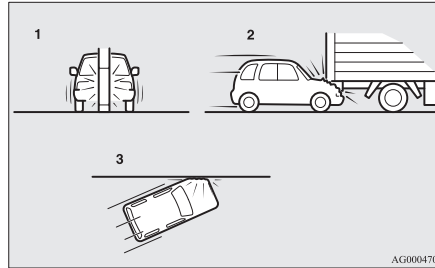

- 1- When colliding with a utility pole, tree or other narrow object.
- 2- Vehicle slides under the rear body of a truck
- 3- Oblique frontal impacts

Because the front airbags do not protect the occupant in all types of frontal collisions, be sure to always properly wear your seat belts.

### ***The front airbags ARE NOT DESIGNED TO DEPLOY when...***

The front airbags are not designed to deploy in conditions where they cannot typically provide protection to the occupant. Such conditions are shown in the illustration.

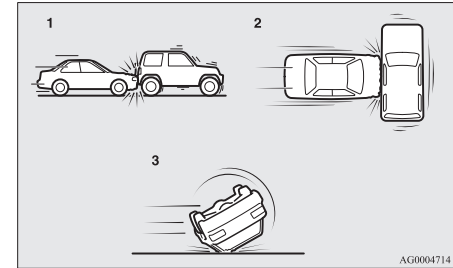

- 1- Rear end collisions
- 2- Side collisions
- 3- Vehicle rolls onto its side or roof

Because the front airbags do not protect the occupant in all types of collisions, be sure to always properly wear your seat belts.

### ***The front airbags MAY DEPLOY when...***

The front airbags may deploy if the bottom of the vehicle suffers a moderate to severe impact (undercarriage damage).

Examples of some typical conditions are shown in the illustration.

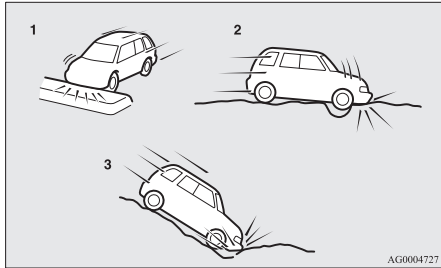

- 1- Collision with an elevated median/island or curb
- 2- Vehicle travels over a deep hole/pothole
- 3- Vehicle drives down a steep slope and hits the ground

Because the front airbags may deploy in certain types of unexpected impacts as shown in the illustration that can easily move you out of position, it is important to always properly wear your seat belts. Your seat belts will help keep you a safe distance from the steering wheel and instrument panel during the initial stages of airbag deployment. The initial stage of airbag inflation is the most forceful and can possibly cause serious or fatal injuries if you contact it at this stage.

**⚠ WARNING**

- Do not attach anything to the steering wheel's padded cover, such as badges or accessories. It might strike and injure an occupant if the airbag inflates.

**⚠ WARNING**

- Do not set anything on, or attach anything to, the instrument panel above the glove box. It might strike and injure an occupant if the airbag inflates.

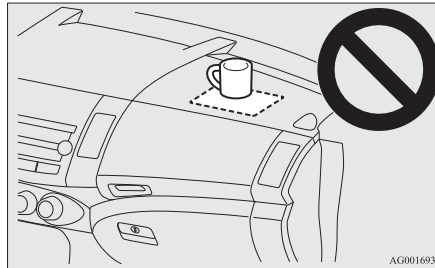

**⚠ WARNING**

- Do not attach accessories to, or put them in front of, the windshield. These objects could restrict the airbag inflation, or strike and injure an occupant if the airbags inflate.
- Do not put packages, pets or other objects between the airbags and the driver or front passenger. It could affect airbag performance, or could cause injury when the airbag inflates.
- Right after the airbag inflation, several airbag system components will be hot. Do not touch these components. There is a danger of being burnt.

**⚠ WARNING**

- The airbag system is designed to work only once. Once the airbags have deployed, they will not work again. They must promptly be replaced, and we recommend you to have the entire airbag system inspected by a MITSUBISHI MOTORS Authorized Service Point.

**Side airbag system\***

E00407600303

The side airbags (A) are contained in the driver and front passenger seatbacks.

The side airbag is designed to inflate only on the side of the vehicle that is impacted, even with no passenger in the front seat.

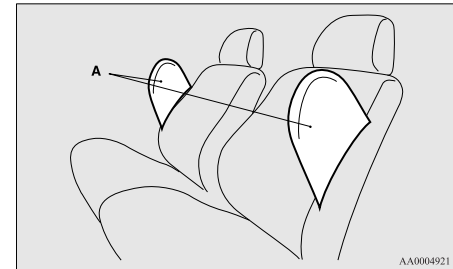

## Seats and seat belts

The label shown here is attached to the seatbacks with a side airbag.

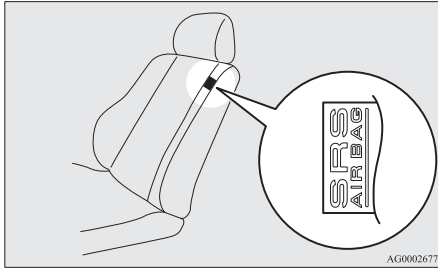

## Curtain airbag system\*

E00409100113

The curtain airbags are contained in the front pillars and roof side rail. The curtain airbag is designed to inflate only on the side of the vehicle that is impacted, even with no passenger in the front seat or second seat.

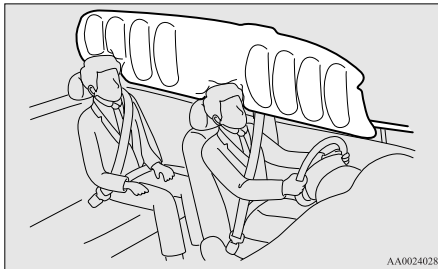

## Deployment of side airbags and curtain airbags

E00407701444

**The side airbags and curtain airbags ARE DESIGNED TO DEPLOY when...**

The side airbags and curtain airbags are designed to deploy when the vehicle suffers a moderate-to-severe side impact to the middle of the passenger compartment.

The typical condition is shown in the illustration.

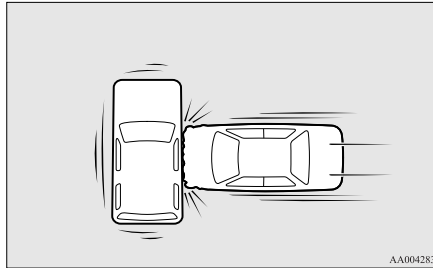

The seat belts in your vehicle are your primary means of protection in a collision. The SRS side airbags and curtain airbags are designed to provide additional protection. Therefore, for your safety and the safety of all occupants, be sure to always properly wear your seat belts.

**The side airbags and curtain airbags MAY NOT DEPLOY when...**

With certain types of side collisions, the vehicle's body structure is designed to absorb the shock to help protect the occupants from harm. (The vehicle body's side area may deform significantly as it absorbs the impact.) Under such circumstances, the side airbags and curtain airbags may not deploy irrespective of the deformation and damage to the vehicle body. Also, depending on the location of the impact, the side airbags and curtain airbags may not deploy simultaneously. Examples of some typical conditions are shown in the illustration.

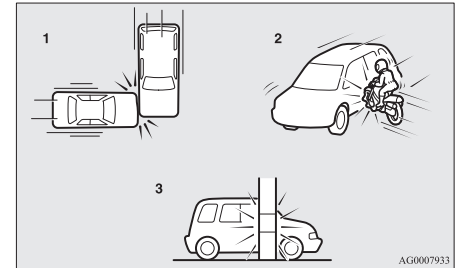

- 1- Side impacts in an area away from the passenger compartment
- 2- Motorcycle or other similar small vehicle collides with the side of vehicle

- 3- Collision with a utility pole, tree or other narrow object

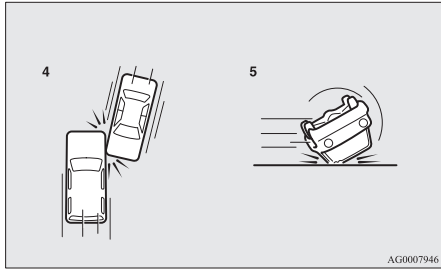

- 4- Oblique side impacts  
5- Vehicle rolls onto its side or roof

Because the side airbags and curtain airbags do not protect the occupant in all types of side collisions, be sure to always properly wear your seat belts.

**The side airbags and curtain airbags ARE NOT DESIGNED TO DEPLOY when...**

The side airbags and curtain airbags are not designed to deploy in conditions where they cannot usually provide protection to the occupant. Typical conditions are shown in the illustration.

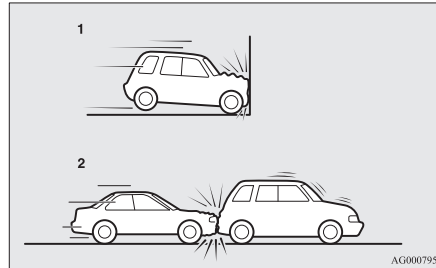

- 1- Head-on collisions  
2- Rear end collisions

Because the side airbags and curtain airbags do not protect the occupant in all types of collisions, be sure to always properly wear your seat belts.

**WARNING**

- The side airbags and curtain airbags are designed to supplement the driver and passenger seat belts in certain side impacts. Seat belts should always be worn properly, and the driver and passenger should sit well back and upright without leaning against the window or door.

**WARNING**

- The side airbags and curtain airbags inflate with great force. The driver and passenger should not put their arms out the window, and should not lean against the door, in order to reduce risk of serious or possible fatal injury from the deploying side airbags and curtain airbags.



**WARNING**

- Do not allow any second seat occupant to hold onto the seatback of either front seat, in order to reduce risk of injury from the deploying side airbags. Special care should be taken with children.
- Do not place any objects near or in front of the seatback of either front seat. They could interfere with proper side airbag inflation, and also could cause injury if thrown free by side airbag deployment.

## **⚠ WARNING**

- Do not place stickers, labels or additional trim on the seatback of either front seat. They could interfere with proper side airbag inflation.
- Do not install seat covers on seats with side airbags. Do not re-cover seats that have side airbags. This could interfere with proper side airbag inflation.
- Do not attach a microphone (A) or any other device or object around the part where the curtain airbags (B) activate such as on the windscreen, side door glass, front and rear pillars and roof side or assist grips. When the curtain airbags inflate, the microphone or other device or object will be hurled with great force or the curtain airbags may not activate correctly, resulting in death or serious injury.

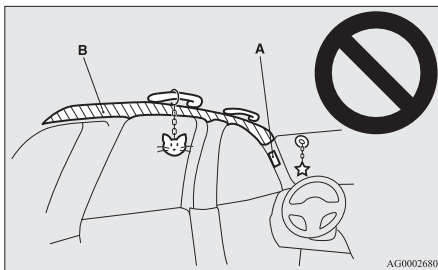

## **⚠ WARNING**

- Do not put a hanger or any heavy or pointed object on the coat hook. If the curtain airbag was activated, any such item could be propelled away with great force and could prevent the curtain airbag from inflating correctly. Hang clothes directly on the coat hook (without using a hanger). Make sure there are no heavy or sharp objects in the pockets of clothes that you hang on the coat hook.
- Never install a rearward facing child restraint in the front passenger seat. A forward facing child restraint should be used in the rear seat whenever possible. If a forward facing child restraint must be used in the front passenger seat, adjust the seat to the most rearward position, and ensure that the child stays in the child restraint and away from the door.
- Do not allow a child to lean against or close to the front door even if the child is seated in a child restraint system. The child's head should also not be leaned against or be close to the area where the side airbags and curtain airbags are located. It is dangerous if the side airbags and curtain airbags inflate. Failure to follow all of these instructions could lead to serious or fatal injury to the child.
- We recommend work around and on the side airbags and curtain airbags system to be done by a MITSUBISHI MOTORS Authorized Service Point.

## SRS warning lamp/display

E00407801588

Warning lamp



Warning display type 1



Warning display type 2



The warning lamp/display illuminates when there is a fault with the system. In addition, the warning display will be displayed on the information screen in the multi-information display.

Normally, when the ignition switch is turned to the "ON" position, the warning lamp should illuminate for several seconds and then should go out.

In addition, if an SRS airbag and the pretensioner system operate, the warning lamp illuminates and stays on.

The SRS warning lamp is shared by the Supplemental Restraint System (SRS) and the seat belt pretensioner system.

**⚠ WARNING**

- When the warning lamp/display behaves as follows, the system could be faulty. The SRS airbag or pretensioner seat belt might not operate normally during a collision, etc., resulting in injury, so have them inspected by a MITSUBISHI MOTORS Authorized Service Point.
  - The warning lamp does not illuminate or stays illuminated when the ignition switch is turned “ON”.
  - The warning lamp illuminates while driving.
  - The warning display operates while driving.

## SRS servicing

E00407901547

**⚠ WARNING**

- We recommend any maintenance performed on or near the components of the SRS to be performed by a MITSUBISHI MOTORS Authorized Service Point. Improper work on the SRS components or wiring could result in inadvertent deployment of the airbags, or could render the SRS inoperative; either situation could result in serious injury.

**⚠ WARNING**

- Do not modify your steering wheel, seat belt retractor or any other SRS components. For example, replacement of the steering wheel, or modifications to the front bumper or body structure can adversely affect SRS performance and lead to possible injury.
- If your vehicle has sustained any damage, we recommend you to have the SRS inspected to ensure it is in proper working order.
- On vehicles with the side airbags, do not modify your front seats, centre pillar and centre console. It can adversely affect SRS performance and lead to possible injury. If you found any tear, scratch, crack or damage to the seat fabric near the side airbag, the portion of the front and rear pillars and roof side rail, you should have the SRS inspected by a MITSUBISHI MOTORS Authorized Service Point.

## NOTE

- When you transfer ownership of the vehicle to some other person, we urge you to alert the new owner that it is equipped with the SRS and refer the new owner to the applicable section in this owner’s manual.
- If your vehicle has to be scrapped, do this in line with local legislation and contact a MITSUBISHI MOTORS Authorized Service Point to safely dismantle the airbag system.

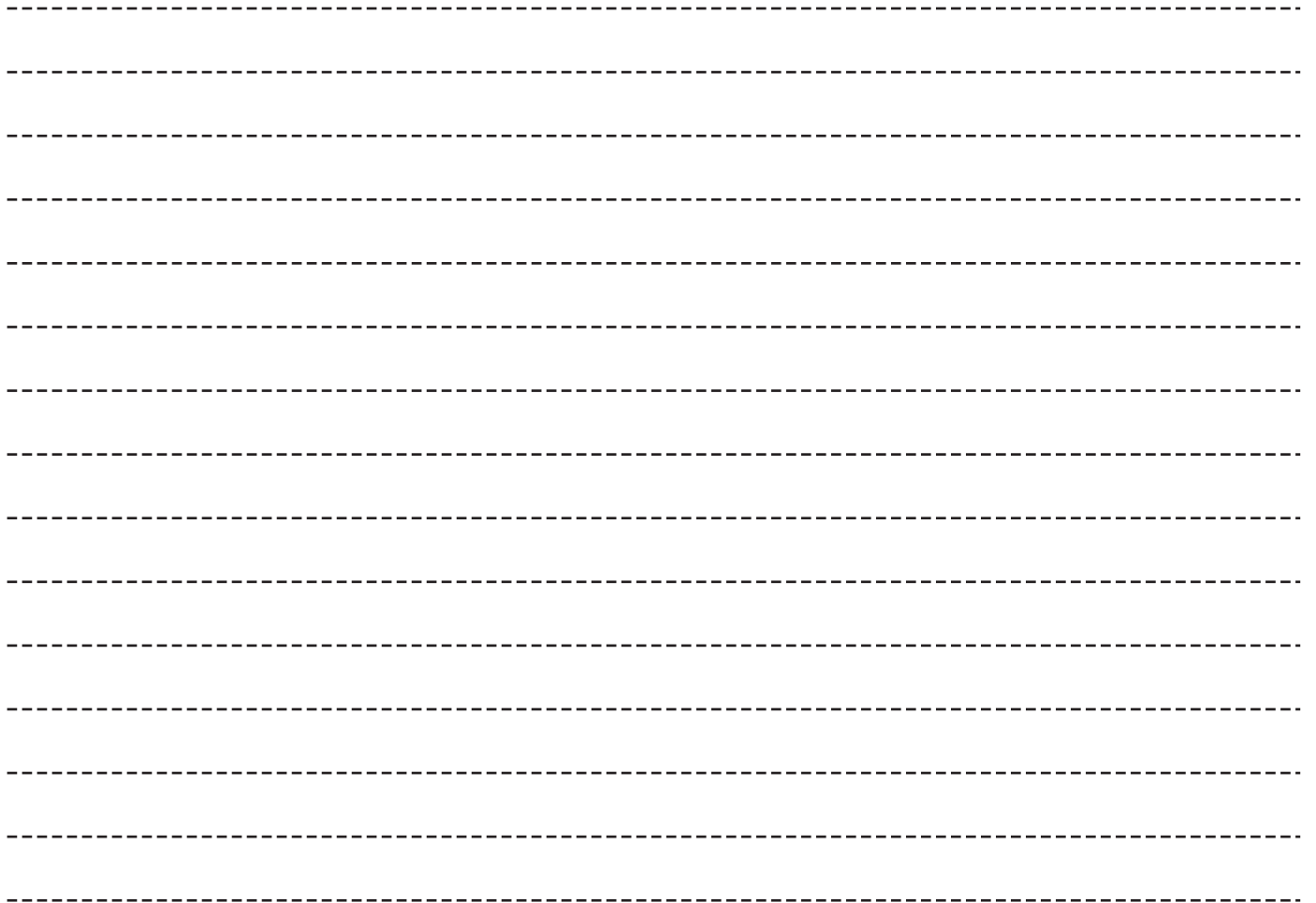



## *Instruments and controls*

Instruments.....	3-02
Multi-information display.....	3-03
Indication lamp, warning lamp, and information screen display list.....	3-25
Indication lamps.....	3-37
Warning lamps.....	3-38
Information screen display.....	3-39
Combination headlamps and dipper switch.....	3-42
Headlamp levelling.....	3-46
Turn-signal lever.....	3-48
Adaptive Front lighting System (AFS)*.....	3-48
Hazard warning flasher switch.....	3-50
Fog lamp switch.....	3-50
Wiper and washer switch.....	3-51
Headlamp washer switch*.....	3-56
Wiper de-icer switch*.....	3-56
Rear window demister switch.....	3-57
Horn switch.....	3-57

## Instruments

E00500101222

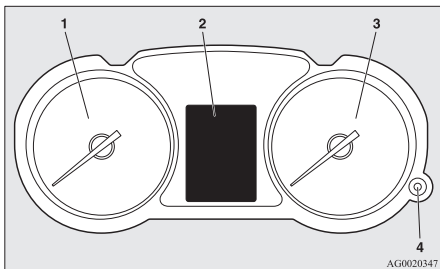

AG0020347

- 1- Tachometer → p. 3-02
- 2- Multi-information display → p. 3-03  
Information screen display list → p. 3-26
- 3- Speedometer (km or mph + km/h)
- 4- “Daytime dipper button (meter illumination control)” on page 3-02

## Tachometer

E00500301064

The tachometer indicates the engine speed (r/min). The tachometer helps you to obtain more economical driving and also warns you of excessive engine speeds (Red zone).

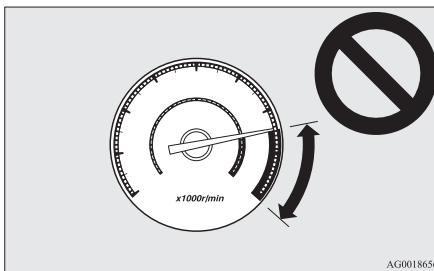

AG0018656

### **CAUTION**

- When driving, watch the tachometer to make sure that the engine speed indication does not rise into the red zone (excessive engine rpm).

## Daytime dipper button (meter illumination control)

E00519800244

Each time you press this button, there is a sound and the brightness of the instruments changes.

## NOTE

- You can adjust to 8 different levels for when the position lamps are illuminated and 8 for when they are not.
- When the lamp switch is in a position other than the “OFF” position, the meter illumination switches automatically to the adjusted brightness, depending on the brightness outside the vehicle.
- The brightness level of the instruments is stored when the ignition switch is turned off.
- If you press and hold the button for longer than about 1 second when the position lamps are illuminated, the brightness level changes to the maximum level. Pressing and holding the button for longer than about 1 second again returns the brightness level to the previous level.

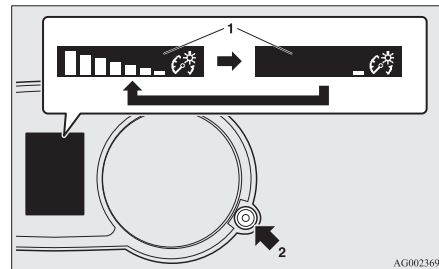

AG0023696

- 1- Brightness display
- 2- Rheostat illumination button

## Multi-information display

### [Except for vehicles equipped with Twin Clutch SST]

Always stop the vehicle in a safe place before operating.

The following information is included on the multi-information display: warnings, odometer, tripmeter, service reminder, engine coolant temperature, fuel remaining, outside temperature, selector lever position, 4WD operation status, average and momentary fuel consumption, driving range, average speed and meter illumination. It is also possible to change elements such as the language and units used on the multi-information display.

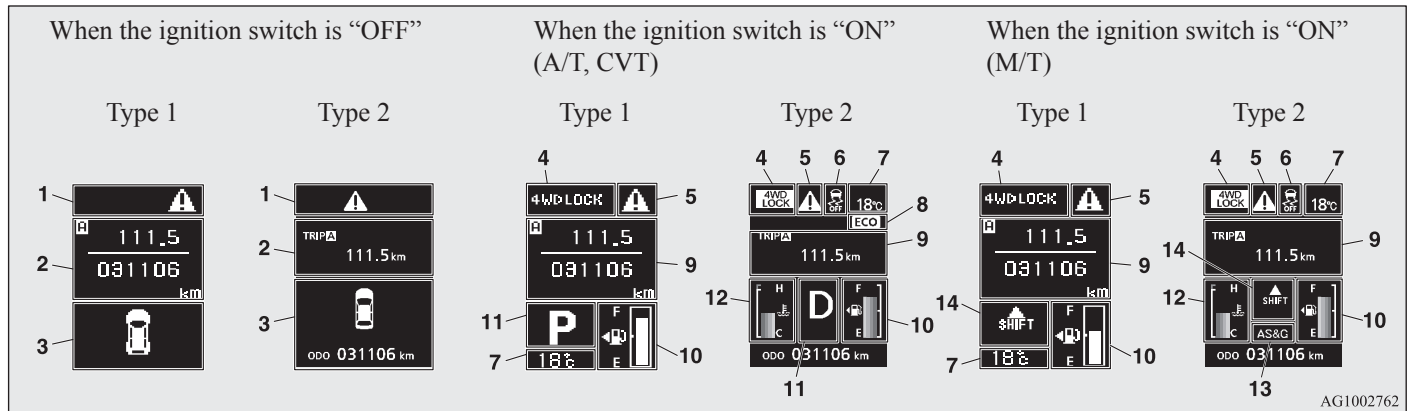

- 1- mark display screen (when the ignition switch is "OFF") → p. 3-06
- 2- Information screen (when the ignition switch is "OFF") → p. 3-06
- Interrupt display screen (when the ignition switch is "OFF") → p. 3-07
- 3- Door ajar warning display screen (when the ignition switch is "OFF") → p. 3-08
- 4- Drive mode indicator display screen\* → p. 3-09
- 5- mark display screen (when the ignition switch is "ON") → p. 3-09
- 6- Active Stability Control (ASC) OFF display screen\* → p. 3-10
- 7- Outside temperature display screen → p. 3-14
- 8- ECO mode indicator\* → p. 3-15
- 9- Information screen (when the ignition switch is "ON") → p. 3-10
- Interrupt display screen (when the ignition switch is "ON") → p. 3-14
- 10- Fuel remaining display screen → p. 3-15
- 11- Selector lever position display screen\* → p. 3-14
- 12- Engine coolant temperature display → p. 3-11
- 13- Auto Stop & Go (AS&G) display screen\* → p. 4-19
- Auto Stop & Go (AS&G) OFF display screen\* → p. 4-21
- 14- Gearshift indicator display screen\* → p. 4-23

**[For vehicles equipped with Twin Clutch SST]**

Always stop the vehicle in a safe place before operating.

The following information is included on the multi-information display: warnings, odometer, tripmeter, service reminder, engine coolant temperature, fuel remaining, outside temperature, Twin Clutch SST control mode, 4WD operation status, gearshift lever position, average and momentary fuel consumption, driving range, average speed, and meter illumination.

It is also possible to change elements such as the language and units used on the multi-information display.

When the ignition switch is “OFF”

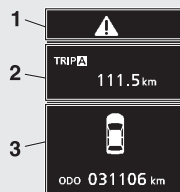

When the ignition switch is “ON”

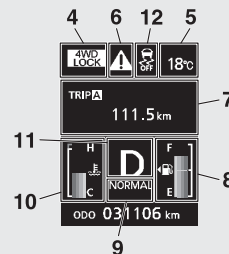

AG1002775

- 1- mark display screen (when the ignition switch is “OFF”) → p. 3-06
- 2- Information screen (when the ignition switch is “OFF”) → p. 3-06  
Interrupt display screen (when the ignition switch is “OFF”) → p. 3-07
- 3- Door ajar warning display screen (when the ignition switch is “OFF”) → p. 3-08
- 4- Drive mode indicator display screen → p. 3-09
- 5- Outside temperature display screen → p. 3-14
- 6- mark display screen (when the ignition switch is “ON”) → p. 3-09

- 7- Information screen (when the ignition switch is “ON”) → p. 3-10  
Interrupt display screen (when the ignition switch is “ON”) → p. 3-14
- 8- Fuel remaining display screen → p. 3-15
- 9- Twin Clutch SST control mode display screen → p. 3-15
- 10- Engine coolant temperature display → p. 3-11
- 11- Gearshift lever position display screen → p. 3-14
- 12- Active Stability Control (ASC) OFF display screen\* → p. 3-10

## NOTE

- The fuel units, temperature units, display language, and other settings can be changed.  
Refer to “Changing the function settings (when the ignition switch is “ON”)” on page 3-17.
- The display screen is different depending on whether the ignition switch is “OFF” or “ON”.  
Refer to “Information screen (when the ignition switch is “OFF”)” on page 3-06.  
Refer to “Warning display list (when the ignition switch is “OFF”)” on page 3-27.  
Refer to “Information screen (when the ignition switch is turned from “OFF” to “ON”)” on page 3-09.  
Refer to “Information screen (when the ignition switch is “ON”)” on page 3-10.  
Refer to “Warning display list (when the ignition switch is “ON”)” on page 3-29.

### Multi-information meter switch

E0052000679

Each time the multi-information meter switch is operated, a sound is emitted and the multi-information display changes between information such as warnings, odometer (Type 1), tripmeter, service reminder, engine coolant temperature (Type 1), average and momentary fuel consumption, driving range, and average speed.

It is also possible to change elements such as the language and units used on the multi-information display by operating the multi-information meter switch.

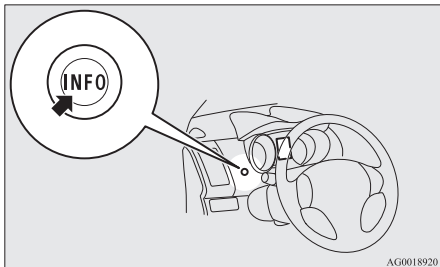

### ⚠ mark display screen (when the ignition switch is “OFF”)

E00520100579

If you press the multi-information meter switch and return from the warning display screen to the previous screen, the ⚠ mark is displayed.

Refer to “To return to the screen displayed before the warning display” on page 3-07.

This mark is also displayed if there is another warning other than the one displayed. When the cause of the warning display is eliminated, the ⚠ mark goes out automatically.

### NOTE

- When the ⚠ mark is displayed, the warning display screen can be redisplayed on the information screen. Refer to “Information screen (when the ignition switch is “OFF”)” on page 3-06. Refer to “Information screen (when the ignition switch is “ON”)” on page 3-10.

### Information screen (when the ignition switch is “OFF”)

E00520200684

Each time you lightly press the multi-information meter switch, the display screen switches in the following order.

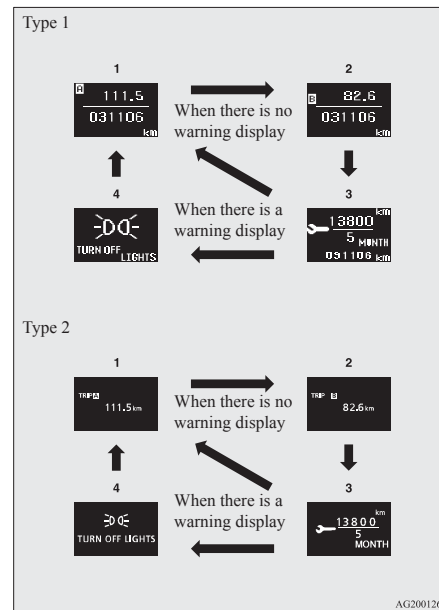

- 1- Odometer (Type 1)/Tripmeter **A**
- 2- Odometer (Type 1)/Tripmeter **B**
- 3- Service reminder
- 4- Redisplay of a warning display screen

## Odometer/Tripmeter

E00521201620

Each time you lightly press the multi-information meter switch, the display screen switches.

Odometer/Tripmeter **[A]** → Odometer/Tripmeter **[B]** → Service reminder → Redisplay of a warning display screen → Odometer/Tripmeter **[A]**

### Odometer

The odometer indicates the distance travelled.

### Tripmeter

The tripmeter indicates the distance travelled between two points.

Example usage of tripmeter **[A]** and tripmeter **[B]**  
 It is possible to measure two currently travelled distances, from home using tripmeter **[A]** and from a particular point on the way using tripmeter **[B]**.

### To reset the tripmeter

To return the display to 0, hold down the multi-information meter switch for about 2 seconds or more. Only the currently displayed value will be reset.

Example

If tripmeter **[A]** is displayed, only tripmeter **[A]** will be reset.

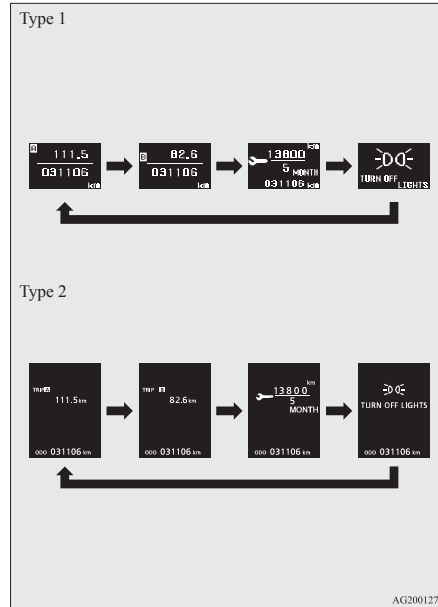

### NOTE

- If there is no warning display, the switching sequence is: Odometer/Tripmeter **[A]** → Odometer/Tripmeter **[B]** → Service reminder → Odometer/Tripmeter **[A]**.

- Both tripmeters **[A]** and **[B]** can count up to 9999.9 km (9999.9 miles).  
 When a tripmeter goes past 9999.9 km (9999.9 miles), it returns to 0.0 km (0.0 miles).
- When disconnecting the battery terminal, the memories of tripmeter display **[A]** and display **[B]** are erased, and their displays return to 0.0 km (0.0 miles).

Type 1



Type 2



### Service reminder

E00521300871

This displays the distance and number of months until the next periodic inspection. Refer to “Service reminder” on page 3-16.

### Interrupt display screen (when the ignition switch is “OFF”)

E00520500687

When there is information to be announced, such as lamp reminders, the buzzer sounds and the multi-information display switches to the warning display screen. Refer to the appropriate page and take the necessary measures.

When the cause of the warning display is eliminated, the warning display goes out automatically.

## Instruments and controls

Refer to “Warning display list (when the ignition switch is “OFF”)” on page 3-27.

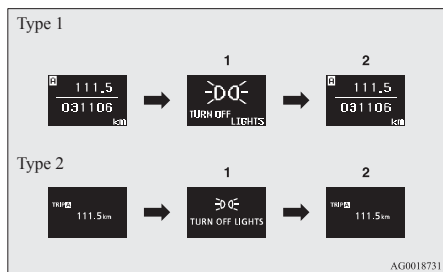

- 1- Information generated
- 2- Cause eliminated

### To return to the screen displayed before the warning display

Even if the cause of the warning display is not eliminated, you can return to the screen that was displayed before the warning display.

If you press the multi-information meter switch, the display screen switches to the screen that was displayed before the warning display and the **A** mark (A) is displayed.

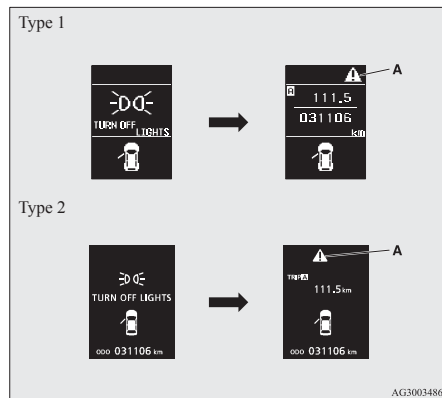

### NOTE

- Warning display screens with a **A** or **A** mark displayed in the upper right of the screen can be switched. If you want to switch the display, press the multi-information meter switch as follows.
  - “**A**”: Press lightly.
  - “**A**”: Press for about 2 seconds or more.

### Redisplay of a warning display screen

When the **A** mark is displayed, if you lightly press the multi-information meter switch a few times, the warning display screen you switched from is displayed again.

Refer to “Information screen (when the ignition switch is “OFF”)” on page 3-06.

### Door ajar warning display screen (when the ignition switch is “OFF”)

E00520600356

If any of the doors or the tailgate is not completely closed, this displays the open door or tailgate.

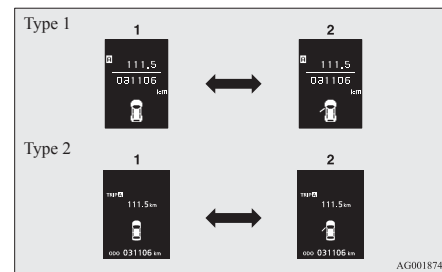

- 1- Doors and tailgate are closed
- 2- Doors or tailgate is open



### Information screen (when the ignition switch is turned from “OFF” to “ON”)

E00520700735

When the ignition switch is turned to the “ON” position, the display screen switches in the following order.

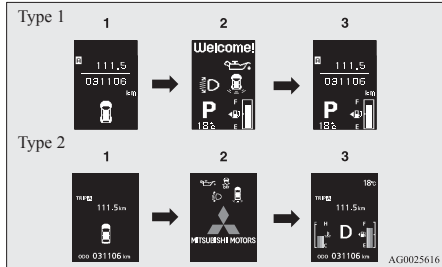

- 1- Screen when the ignition switch is “OFF”
- 2- System check screen
- 3- Screen when the ignition switch is “ON”

### System check screen

When the ignition switch is turned to the “ON” position, the system check screen is displayed for about 4 seconds. If there is no fault, information screen (when the ignition switch is “ON”) is displayed.

If there is a fault, the screen changes to warning display.

Refer to “Warning display list (when the ignition switch is “ON”)” on page 3-29.

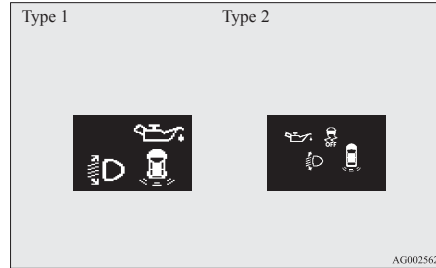

### NOTE

- The system check screen display varies depending on the customer’s equipment.

### Service reminder

When the time for periodic inspection arrives, the warning display is displayed for a few seconds after the ignition switch “ON” screen. Refer to “Service reminder” on page 3-16.

Type 1



Type 2



Type 1



### Drive mode indicator display screen\*

E00520800387

Type 2



This displays the 4WD status. If you select “4WD LOCK” mode with the drive mode selector, “4WD LOCK” is displayed; if you select “4WD AUTO” mode, “4WD” is displayed. Nothing is displayed when 2WD mode is selected. Refer to “Drive mode selector” on page 4-46.



### ! mark display screen (when the ignition switch is “ON”)

E00520900362

This is displayed when you press the multi-information meter switch and switch the warning display screen. This mark is also displayed if there is another warning other than the one displayed.

## Instruments and controls

When the cause of the warning display is eliminated, the **A** mark goes out automatically.

### NOTE

- When the **A** mark is displayed, the warning display screen can be redisplayed on the information screen. Refer to “Information screen (when the ignition switch is “OFF”)” on page 3-06. Refer to “Information screen (when the ignition switch is “ON”)” on page 3-10.

## Active Stability Control (ASC) OFF display screen\*

E00521000487

This is displayed when the Active Stability Control (ASC) is turned off with the ASC OFF switch. If there is a fault with the ASC, the ASC OFF display is shown. Refer to ““ASC OFF” switch” on page 4-58.



## Information screen (when the ignition switch is “ON”)

E00521100651

Each time you lightly press the multi-information meter switch, the display screen switches in the following order.

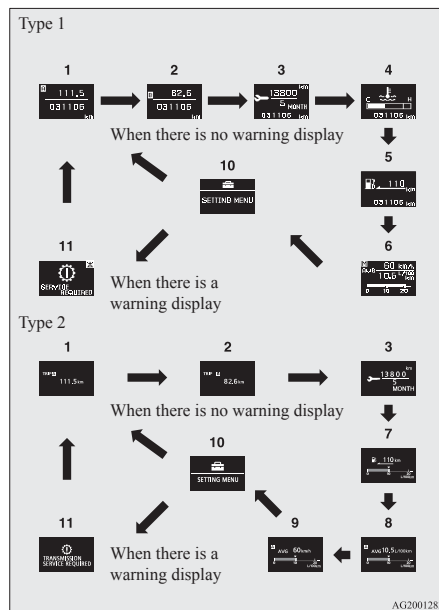

- 1- Odometer (Type 1)/Tripmeter **A**
- 2- Odometer (Type 1)/Tripmeter **B**
- 3- Service reminder
- 4- Engine coolant temperature display (Type 1)
- 5- Driving range display (Type 1)
- 6- Average speed display, average fuel consumption display, momentary fuel consumption display (Type 1)
- 7- Driving range display, momentary fuel consumption display (Type 2)
- 8- Average fuel consumption display, momentary fuel consumption display (Type 2)
9. Average speed display, momentary fuel consumption display (Type 2)
10. Function setting screen
11. Redisplay of a warning display screen

### NOTE

- While driving, even if you operate the multi-information meter switch, the function setting screen is not displayed. Always stop the vehicle in a safe place before operating. Refer to “Changing the function settings (when the ignition switch is “ON”)” on page 3-17.
- When there is information to be announced, such as a system fault, the buzzer sounds and the screen display is switched. Refer to “Interrupt display screen (when the ignition switch is “ON”)” on page 3-14.

## Odometer/Tripmeter

E00521201095

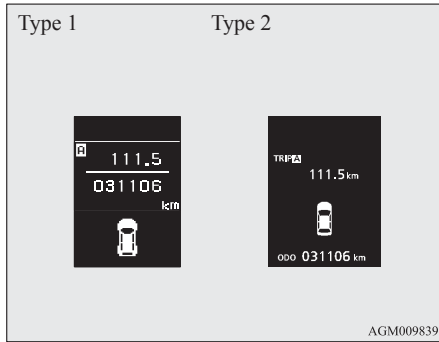

The operation method is the same as when the ignition switch is “OFF”. Refer to “Odometer/Tripmeter” on page 3-07.

Type 1

### Service reminder

E00521300884

This displays the distance and number of months until the next periodic inspection. Refer to “Service reminder” on page 3-16.

Type 2



Type 1



Type 2



## Engine coolant temperature display

E00521400625

This indicates the engine coolant temperature.

If the coolant becomes hot, “” will blink.

Pay careful attention to the engine coolant temperature display while you are driving.

## CAUTION

- If the engine is overheating, “” will blink. In this case, the bar graph is on the red zone. Immediately park the vehicle in a safe place and take the required measures. Refer to “Engine overheating” on page 6-04.

## Driving range display

E00521500701

This displays the approximate driving range (how many more kilometres or miles you can drive). When the driving range falls below approximately 50 km (30 miles), “---” is displayed.

Refuel as soon as possible.

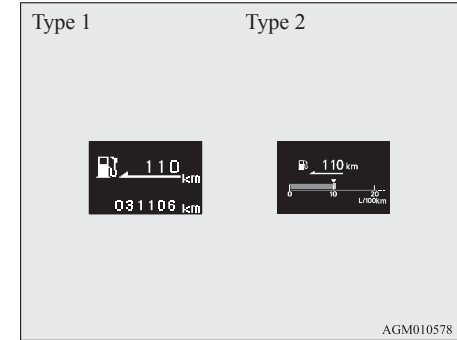

AGM010578

### NOTE

- The driving range is determined based on the fuel consumption data. This may vary depending on the driving conditions and habits. Treat the distance displayed as just a rough guideline.
- When you refuel, the driving range display is updated. However, if you only add a small amount of fuel, the correct value will not be displayed. Fill with a full tank whenever possible.
- On rare occasions, the value displayed for the driving range may change if you are parked on an extremely steep incline. This is due to the movement of fuel in the tank and does not indicate a malfunction.

## Instruments and controls

- The display setting can be changed to the preferred units (km or miles). Refer to “Changing the function settings (when the ignition switch is “ON”)” on page 3-17.

### Average speed display

E00521600773

This displays the average speed from the last reset to the present time.

There are the following 2 mode settings.

For the method for changing the average speed display setting, refer to “Changing the function settings (when the ignition switch is “ON”)” on page 3-17.

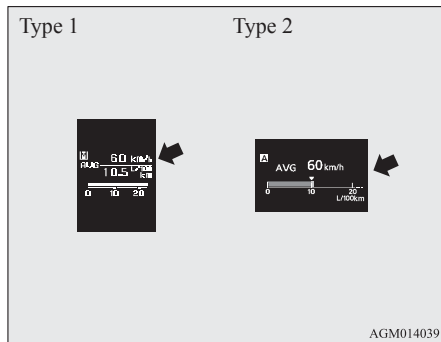

### Manual reset mode

- When the average speed is being displayed, if you hold down the multi-information meter switch, the average speed displayed at that time is reset.

- When the ignition switch is switched from “ACC” or “LOCK” to “ON”, the mode setting is automatically switched from manual to auto. Although the mode setting is automatically switched to the auto reset mode, if you switch the mode setting to the manual reset mode, the average speed from the last time the display is reset will be displayed.

### Auto reset mode

- When the average speed is being displayed, if you hold down the multi-information meter switch, the average speed displayed at that time is reset.
- If the ignition switch is at “ACC” or “LOCK” for about 4 hours or longer, the average speed display is automatically reset.

### NOTE

- The average speed display and the average fuel consumption display can be reset individually for the auto reset mode and manual reset mode.
- “---” is displayed when the average speed cannot be measured.
- The initial (default) setting is “Auto reset mode”.
- The display setting can be changed to the preferred units (km/h or mph). Refer to “Changing the function settings (when the ignition switch is “ON”)” on page 3-17.
- The memory of the auto reset mode or manual reset mode for the average speed display is erased if the battery is disconnected.

### Average fuel consumption display

E00521700758

This displays the average fuel consumption from the last reset to the present time.

There are the following 2 mode settings.

For information on how to change the average fuel consumption display setting, refer to “Changing the function settings (when the ignition switch is “ON”)” on page 3-17.

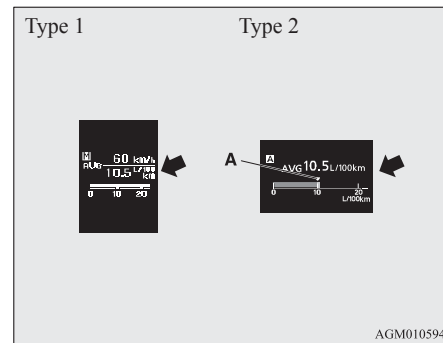

The “A” mark in the momentary fuel gauge shows the average fuel consumption.

### Manual reset mode

- When the average fuel consumption is being displayed, if you hold down the multi-information meter switch, the average fuel consumption displayed at that time is reset.

- When the ignition switch is switched from “ACC” or “LOCK” to “ON”, the mode setting is automatically switched from manual to auto. Although the mode setting is automatically switched to the auto reset mode, if you switch the mode setting to the manual reset mode, the average fuel consumption from the last time the display is reset will be displayed.

**Auto reset mode**

- When the average fuel consumption is being displayed, if you hold down the multi-information meter switch, the average fuel consumption displayed at that time is reset.
- If the ignition switch is at “ACC” or “LOCK” for about 4 hours or longer, the average fuel consumption display is automatically reset.

**NOTE**

- The average speed display and the average fuel consumption display can be reset individually for the auto reset mode and manual reset mode.
- “---” is displayed when the average fuel consumption cannot be measured.
- The initial (default) setting is “Auto reset mode”.
- The average fuel consumption depends on the driving condition (road condition, driving behavior, etc.). The displayed fuel consumption may vary from the actual fuel consumption. Treat the fuel consumption displayed as just a rough guideline.

- The memory of the auto reset mode or manual reset mode for the average fuel consumption display is erased if the battery is disconnected.
- The display setting can be changed to the preferred units {km/L, mpg (US), mpg (UK) or L/100 km}. Refer to “Changing the function settings (when the ignition switch is “ON”)” on page 3-17.

**Momentary fuel consumption display**

E00521800560

While driving, this displays the momentary fuel consumption, using a bar graph.

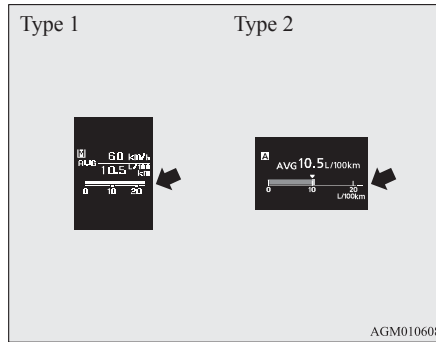

When the momentary fuel consumption surpasses the average fuel consumption, the momentary fuel consumption is displayed with a green bar graph. (Type 2)

Be conscious that when maintaining the momentary fuel consumption above the average fuel consumption, driving with better fuel consumption can be possible.

**NOTE**

- When the momentary fuel consumption cannot be measured, the bar graph is not displayed.
- The display setting can be changed to the preferred units {km/L, mpg (US), mpg (UK) or L/100 km}. Refer to “Changing the function settings (when the ignition switch is “ON”)” on page 3-17.
- It is possible to cancel the green bar graph. Refer to “Changing the function settings (when the ignition switch is “ON”)” on page 3-17.



**Function setting screen**

E00521900138

The “Display language”, “Temperature unit”, “Fuel consumption unit”, and “Average fuel consumption and speed reset method” etc. settings can be modified as desired. Refer to “Changing the function settings (when the ignition switch is “ON”)” on page 3-17.

## Instruments and controls

### Interrupt display screen (when the ignition switch is “ON”)

E00522000790

#### Warning display

When there is information to be announced, such as a system fault, a sound is emitted and the information screen switches to the warning display screen.

Refer to the warning list and take the necessary measures.

Refer to “Warning display list (when the ignition switch is “ON”)” on page 3-29.

When the cause of the warning display is eliminated, the warning display goes out automatically.

#### To return to the screen displayed before the warning display

Even if the cause of the warning display is not eliminated, you can return to the screen that was displayed before the warning display.

If you press the multi-information meter switch, the display screen switches to the screen that was displayed before the warning display and the **A** mark (A) is displayed.

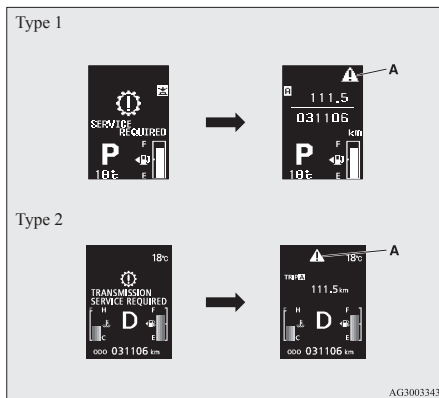

#### NOTE

- Warning display screens with a **A** or **B** mark displayed in the upper right of the screen can be switched. If you want to switch the display, press the multi-information meter switch as follows.
  - “**A**”: Press lightly.
  - “**B**”: Press for about 2 seconds or more.

#### Redisplay of a warning display screen

When the **A** mark is displayed, if you lightly press the multi-information meter switch a few times, the warning display screen you switched from is displayed again.

#### Other interrupt displays

The operation status of each system is displayed on the information screen.

Refer to the appropriate page in the warning display list for further details.

Refer to “Other interrupt displays (when the ignition switch is “ON”)” on page 3-35.



#### Selector lever position display screen\*/Gearshift lever position display screen\*

E00532500264

Shows the position of the selector lever or gearshift lever.

Refer to “Selector lever operation” on pages 4-25, 4-30.

Refer to “Gearshift lever operation” on page 4-36.



#### Outside temperature display screen

E00522100427

This shows the temperature outside the vehicle.

#### NOTE

- The display setting can be changed to the preferred units (°C or °F). Refer to “Changing the function settings (when the ignition switch is “ON”)” on page 3-17.
- Depending on factors such as the driving conditions, the displayed temperature may vary from the actual outside temperature.

**NORMAL**

### Twin Clutch SST control mode display screen\*

E00526500025

The operation status of the Twin Clutch SST control mode is displayed. Refer to “Twin Clutch SST control mode” on page 4-39.

### Fuel remaining display screen

E00522200271

This displays the amount of fuel remaining.

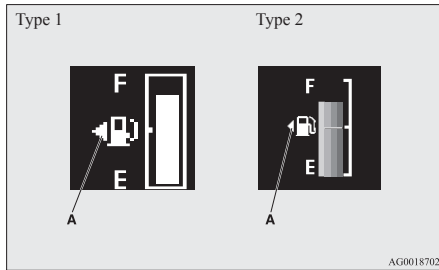

### **CAUTION**

- Do not run out of fuel, or the catalytic converter may be adversely affected. If the warning display appears, refuel as soon as possible.

#### NOTE

- It may take several seconds to stabilise the display after refilling the tank.

- If fuel is added with the ignition switch in the “ON” position, the fuel gauge may incorrectly indicate the fuel level.

#### Fuel lid mark

E00522300197

The arrow (A) indicates that the fuel tank filler is located on the left side of the body. (Refer to “Filling the fuel tank” on page 03)

#### Fuel remaining warning display

E00522400563

When the fuel is reduced to about 10 litres, the information screen switches to the interrupt display of the fuel remaining warning display, and the “” mark (B) on the fuel remaining display flashes slowly (about once per second). After a few seconds, the information screen returns from the fuel remaining warning display to the previous screen.

When the fuel is reduced further to about 5 litres, the information screen switches to the fuel remaining warning display and the “” mark (B) on the fuel remaining display flashes quickly (about twice per second).

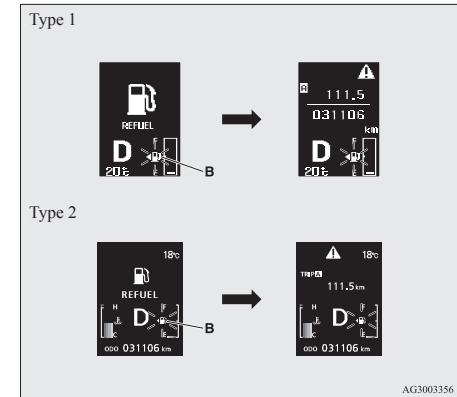

#### NOTE

- On inclines or curves, the display may be incorrect due to the movement of fuel in the tank.



#### ECO mode indicator\*

E00529300053

Except for vehicles for Russia, Kazakhstan and Ukraine, this indicator will be displayed when fuel-efficient driving is achieved.

### Service reminder

E00522500838

Displays the approximate time until the next periodic inspection recommended by MITSUBISHI MOTORS. “---” is displayed when the inspection time has arrived.

#### NOTE

- Depending on the vehicle specifications, the displayed time may differ from the next periodic inspection time recommended by MITSUBISHI MOTORS.

In addition, the display settings for the next periodic inspection time can be modified.

To modify the display settings, have it adjusted at a MITSUBISHI MOTORS Authorized Service Point.

For more details, consult a MITSUBISHI MOTORS Authorized Service Point.

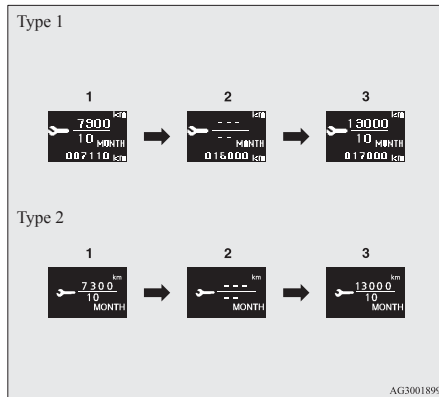

1. Displays the time until the next periodic inspection.

#### NOTE

- The distance is shown in units of 100 km (100 miles). The time is shown in units of months.
2. This informs you that a periodic inspection is due. We recommend you to consult a MITSUBISHI MOTORS Authorized Service Point.

At that time, when the ignition switch is switched from “OFF” to “ON”, the warning display is displayed for a few seconds on the information screen.

#### Type 1



#### Type 2



3. After your vehicle is inspected at a MITSUBISHI MOTORS Authorized Service Point, it displays the time until the next periodic inspection.

### To reset

The “---” display can be reset while the ignition switch is “OFF”. When the display is reset, the time until the next periodic inspection is displayed and the warning display is no longer displayed when the ignition switch is switched from “OFF” to “ON”.

1. When you lightly press the multi-information meter switch a few times, the information screen switches to the service reminder display screen.

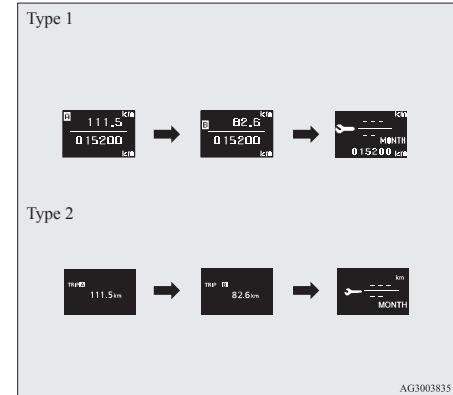

2. Press and hold the multi-information meter switch for about 2 seconds or more to display “” and make it flash. (If there is no operation for about 10 seconds with flashing, the display returns to the previous screen.)



- Lightly press the multi-information meter switch while the icon is flashing to change the display from “---” to “CLEAR”. After this, the time until the next periodic inspection will be displayed.

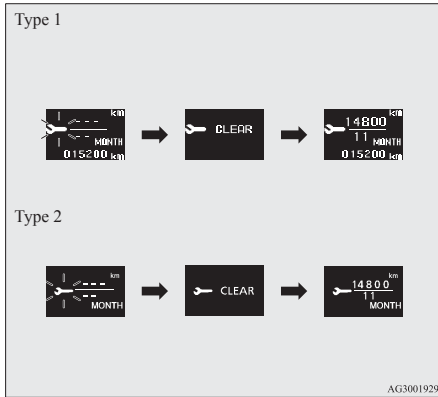

### **CAUTION**

- The customer is responsible for making sure that periodic inspection and maintenance are performed. Inspections and maintenance must be performed to prevent accidents and malfunctions.

#### NOTE

- “---” display cannot be reset when the ignition switch is “ON”.

- When “---” is displayed, after a certain distance and a certain period of time, the display is reset and the time until the next periodic inspection is displayed.
- If you accidentally reset the display, we recommend you to consult a MITSUBISHI MOTORS Authorized Service Point.

### Door ajar warning display screen (when the ignition switch is “ON”)

E00522600451

Type 1



Type 2



If any of the doors or the tailgate is not completely closed, this displays the open door or tailgate. If the vehicle speed exceeds approximately 8 km/h (5 mph) while a door is ajar, a buzzer sounds 4 times. This notifies the driver that a door is ajar.

### **CAUTION**

- Before moving your vehicle, check that the warning lamp is OFF.

### Changing the function settings (when the ignition switch is “ON”)

E00522700436

- Stop the vehicle in a safe place. Firmly apply the parking brake and put the gearshift lever into the “N” (Neutral) position (M/T), gearshift lever into the “P” (Park) position (Twin Clutch SST) or the selector lever into the “P” (PARK) position (A/T or CVT).
- Lightly press the multi-information meter switch a few times to switch the information screen to the function setting screen. Refer to “Information screen (when the ignition switch is “ON”)” on page 3-10.

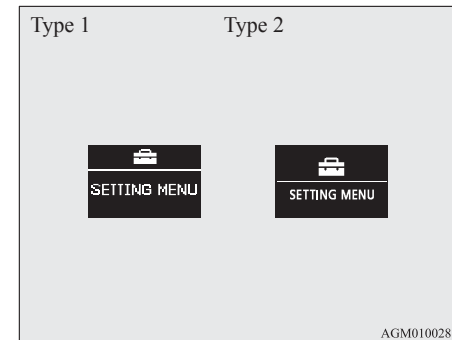

## **CAUTION**

- For safety, stop the vehicle before operating. While driving, even if you operate the multi-information meter switch, the function setting screen is not displayed.

3. Press and hold the multi-information meter switch for about 2 seconds or more to switch from the setting mode screen to the menu screen.

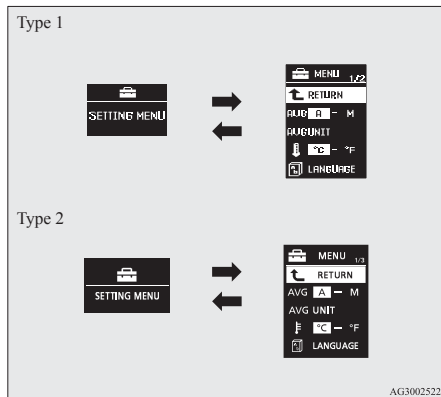

### NOTE

- To return the menu screen to the function setting screen, press and hold the multi-information meter switch for about 2 seconds or more.
- If no operations are made within about 15 seconds of the menu screen being displayed, the display returns to the function setting screen.

4. Select the item to change on the menu screen and change to the desired setting. Refer to the following items for further details on the operation methods.

Refer to “Changing the reset mode for average fuel consumption and average speed” on page 3-18.

Refer to “Changing the fuel consumption display unit” on page 3-19.

Refer to “Changing the temperature unit” on page 3-20.

Refer to “Changing the display language” on page 3-20.

Refer to “Changing the language cooperative control” on page 3-21.

Refer to “Operation sound setting” on page 3-22.

Refer to “Changing the time until “REST REMINDER” is displayed” on page 3-22.

Refer to “Changing the turn-signal sound” on page 3-23.

Refer to “Changing the momentary fuel consumption display (Type 2)” on page 3-23.

Refer to “Returning to the factory settings” on page 3-23.

### *Changing the reset mode for average fuel consumption and average speed*

E00522900728

The mode conditions for the average fuel consumption and average speed display can be switched between “Auto reset” and “Manual reset”.

1. Press and hold the multi-information meter switch for about 2 seconds or more to switch from the setting mode screen to the menu screen.

Refer to “Changing the function settings (when the ignition switch is “ON”)” on page 3-17.

2. Lightly press the multi-information meter switch to select “AVG (average fuel consumption and average speed setting)”.

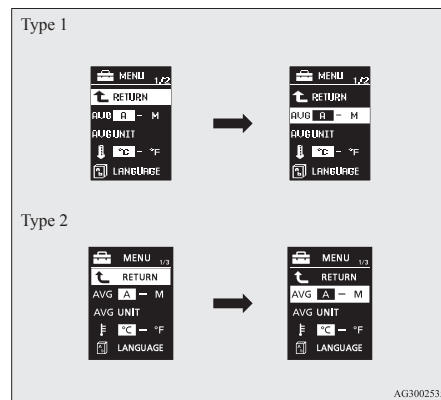

3. Press and hold the multi-information meter switch for about 2 seconds or more to switch in sequence from A (Auto reset mode) → M (Manual reset mode) → A (Auto reset mode). The setting is changed to the selected mode condition.

**Manual reset mode**

- When the average fuel consumption and average speed are being displayed, if you hold down the multi-information meter switch, the average fuel consumption and average speed displayed at that time are reset.
  - When the ignition switch is switched from “ACC” or “LOCK” to “ON”, the mode setting is automatically switched from manual to auto.
- Although the mode setting is automatically switched to the auto reset mode, if you switch the mode setting to the manual reset mode, the average fuel consumption and average speed from the last time the display is reset will be displayed.

**Auto reset mode**

- When the average fuel consumption and average speed are being displayed, if you hold down the multi-information meter switch, the average fuel consumption and average speed displayed at that time are reset.
- If the ignition switch is at “ACC” or “LOCK” for about 4 hours or longer, the average fuel consumption display and average speed display are automatically reset.

**NOTE**

- The average fuel consumption display and average speed display can be reset individually for the auto reset mode and manual reset mode.
- The memory of the auto reset mode or manual reset mode for the average fuel consumption display and average speed display is erased if the battery is disconnected.

- The initial (default) setting is “Auto reset mode”.

**Changing the fuel consumption display unit**

E00523000449

The display unit for fuel consumption can be switched. The distance, speed, and amount units are also switched to match the selected fuel consumption unit.

1. Press and hold the multi-information meter switch for about 2 seconds or more to switch from the setting mode screen to the menu screen. Refer to “Changing the function settings (when the ignition switch is “ON”)” on page 3-17.
2. Lightly press the multi-information meter switch to select “AVG UNIT (fuel consumption display setting)”.

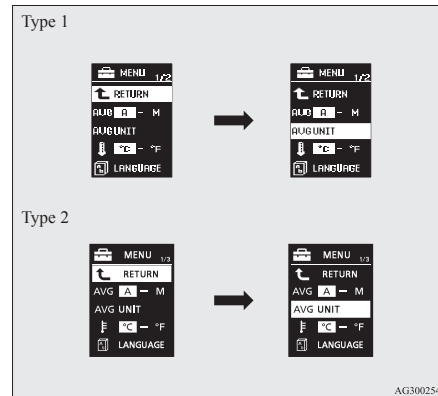

3. Press and hold the multi-information meter switch for about 2 seconds or more to display “AVG UNIT” (fuel consumption display unit setting).
4. Lightly press the multi-information meter switch to switch in sequence from km/L → L/100 km → mpg (US) → mpg (UK) → RETURN → km/L.

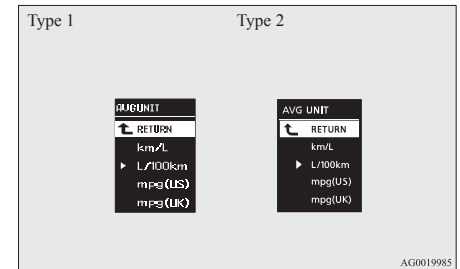

5. Press and hold the multi-information meter switch for about 2 seconds or more to change the setting to the selected unit.

**NOTE**

- The display units for the driving range, the average fuel consumption, the average speed and the momentary fuel consumption are switched, but the units for the indicating needle (speedometer), the odometer and the trip-meter will remain unchanged.
- The memory of the unit setting is erased if the battery is disconnected, and it returns automatically to L/100 km.

## Instruments and controls

The distance and speed units are also switched in the following combinations to match the selected fuel consumption unit.

Fuel consumption	Distance (driving range)	Speed (average speed)
L/100 km	km	km/h
mpg (US)	mile(s)	mph
mpg (UK)	mile(s)	mph
km/L	km	km/h

### Changing the temperature unit

E00523100570

The display unit for temperature can be switched.

1. Press and hold the multi-information meter switch for about 2 seconds or more to switch from the setting mode screen to the menu screen.

Refer to “Changing the function settings (when the ignition switch is “ON”)” on page 3-17.

2. Lightly press the multi-information meter switch to select “**1**” (temperature unit setting).

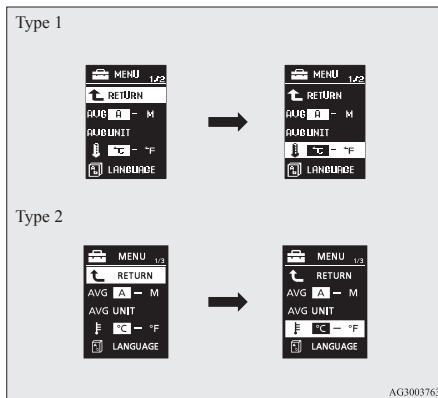

3. Press and hold the multi-information meter switch for about 2 seconds or more to switch in sequence from °C → °F → °C. The setting is changed to the selected temperature unit.

### NOTE

- If the battery is disconnected, the unit setting is erased from memory and is automatically set to °C.

### Changing the display language

E00523200308

The language of the multi-information display can be switched.

1. Press and hold the multi-information meter switch for about 2 seconds or more to switch from the setting mode screen to the menu screen.

Refer to “Changing the function settings (when the ignition switch is “ON”)” on page 3-17.

2. Lightly press the multi-information meter switch to select “LANGUAGE” (language setting).

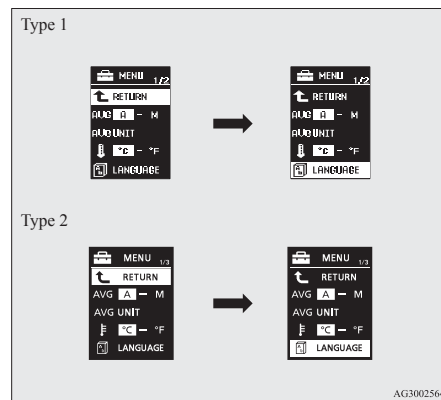

3. Press and hold the multi-information meter switch for about 2 seconds or more to display “LANGUAGE” (language setting).

- Lightly press the multi-information meter switch to switch in sequence from JAPANESE → ENGLISH → GERMAN → FRENCH → SPANISH → ITALIAN → “---” (do not display warning message) → RETURN → JAPANESE.

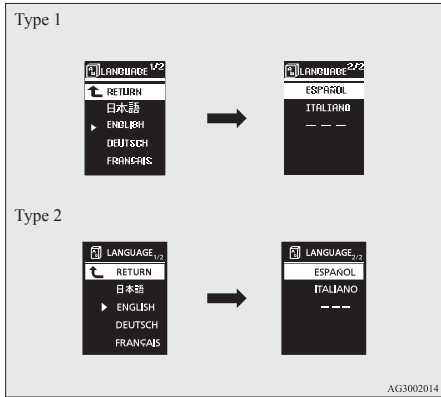

- If you hold down the multi-information meter switch for about 2 seconds or more, the setting is changed to the selected language.

**NOTE**

- The memory of the language setting is erased if the battery is disconnected, and it returns automatically to ENGLISH.
- If “---” is selected in the language setting, a warning message is not displayed when there is a warning display or interrupt display.

**Changing the language cooperative control\***

E00523300442

The language used in MITSUBISHI Multi-Communication System (MMCS) (if so equipped) or the Hands-free Bluetooth® cellular phone interface system with voice recognition (if so equipped) can be changed automatically to the same language as that shown in the multi-information display.

- Press and hold the multi-information meter switch for about 2 seconds or more to switch from the setting mode screen to the menu screen. Refer to “Changing the function settings (when the ignition switch is “ON”)” on page 3-17.
- Lightly press the multi-information meter switch to select “” (language cooperative control).

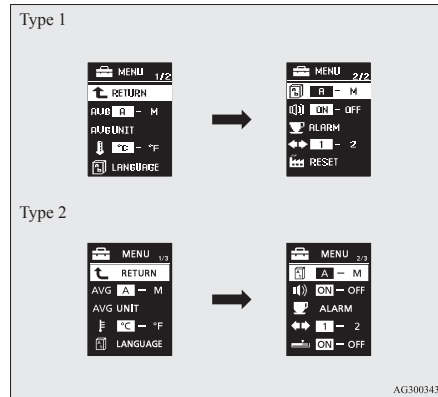

- Press and hold the multi-information meter switch to switch in sequence from A (language cooperation disabled) → M (language cooperation enabled) → A (language cooperation enabled). The setting is changed to the selected condition.

**NOTE**

- The memory of the language cooperative control is erased if the battery is disconnected, and it returns automatically to A (language cooperation enabled).
- The language display modified with the language setting can be switched in the following manner.
  - When A (language cooperation enabled) has been selected with the language cooperative control, the language for MITSUBISHI Multi-Communication System (MMCS) (if so equipped) or the Hands-free Bluetooth® cellular phone interface system with voice recognition (if so equipped) is automatically changed to the language selected for the multi-information display.
  - When M (language cooperation disabled) has been selected with the language cooperative control, the language for MITSUBISHI Multi-Communication System (MMCS) (if so equipped) or the Hands-free Bluetooth® cellular phone interface system with voice recognition (if so equipped) is not automatically changed to the language selected for the multi-information display.

## Instruments and controls

### Operation sound setting

E00523400573

You can turn off the operation sounds of the multi-information meter switch and daytime dipper button.

1. Press and hold the multi-information meter switch for about 2 seconds or more to switch from the setting mode screen to the menu screen.

Refer to “Changing the function settings (when the ignition switch is “ON”)” on page 3-17.

2. Lightly press the multi-information meter switch to select “**ALARM**” (operation sound setting).

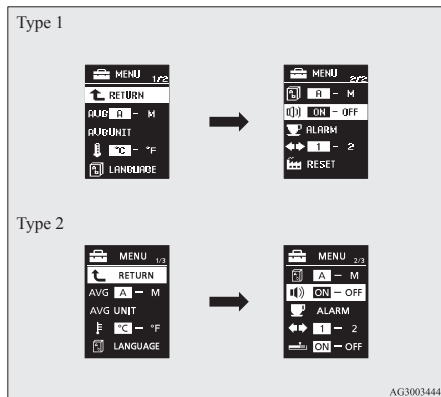

3. Press and hold the multi-information meter switch for about 2 seconds or more to switch in sequence from ON (operation sound on) → OFF (operation sound off) → ON (operation sound on).

The setting is changed to the selected condition.

### NOTE

- The memory of the operation sound setting is erased if the battery is disconnected, and it returns automatically to ON (operation sound on).
- The operation sound setting only deactivates the operation sound of the multi-information meter switch and daytime dipper button. The warning display and other sounds cannot be deactivated.

### Changing the time until “REST REMINDER” is displayed

E00523500574

The time until the display appears can be changed.

1. Press and hold the multi-information meter switch for about 2 seconds or more to switch from the setting mode screen to the menu screen.  
Refer to “Changing the function settings (when the ignition switch is “ON”)” on page 3-17.

2. Lightly press the multi-information meter switch to select “**ALARM**” (rest time setting).

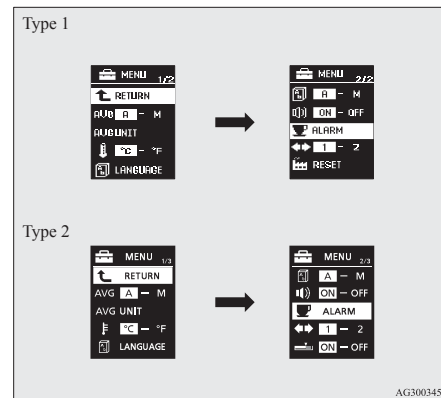

3. Press and hold the multi-information meter switch for about 2 seconds or more to display “**ALARM**” (rest time setting).

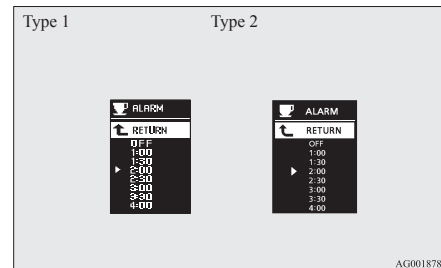

- Lightly press the multi-information meter switch to select the time until the display.
- Press and hold the multi-information meter switch for about 2 seconds or more, the setting is changed to the selected time.

#### NOTE

- If the battery is disconnected, the unit setting is erased from memory and is automatically set to OFF.
- The drive time is reset when the ignition switch is turned off.

#### Changing the turn-signal sound

E00529100282

It is possible to change the turn-signal sound.

- Press and hold the multi-information meter switch for about 2 seconds or more to switch from the setting mode screen to the menu screen.

Refer to “Changing the function settings (when the ignition switch is “ON”)” on page 3-17.

- Lightly press the multi-information meter switch to select  (changing the turn-signal sound).

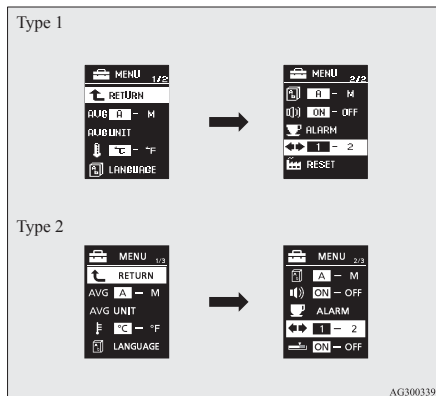

- Press and hold the multi-information meter switch for about 2 seconds or more to switch in sequence from 1 (turn-signal sound 1) → 2 (turn-signal sound 2) → 1 (turn-signal sound 1).

The setting changes to the selected turn-signal sound.

#### Changing the momentary fuel consumption display (Type 2)

E00529200010

It is possible to change the bar graph setting of the momentary fuel consumption display.

#### Instruments and controls

- Press and hold the multi-information meter switch for about 2 seconds or more to switch from the setting mode screen to the menu screen. Refer to “Changing the function settings (when the ignition switch is “ON”)” on page 3-17.
- Lightly press the multi-information meter switch to select  (changing the momentary fuel consumption display)

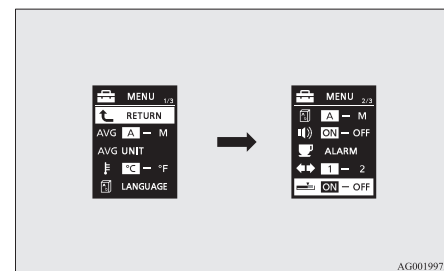

- Press and hold the multi-information meter switch for about 2 seconds or more to switch in sequence from ON (with the green bar graph) → OFF (without the green bar graph) → ON (with the green bar graph). The setting changes to the selected bar graph setting.

#### Returning to the factory settings

E00523600650

All of the function settings can be returned to their factory settings.

## Instruments and controls

1. Press and hold the multi-information meter switch for about 2 seconds or more to switch from the setting mode screen to the menu screen.  
Refer to “Changing the function settings (when the ignition switch is “ON”)” on page 3-17.
2. Lightly press the multi-information meter switch to select “RESET” (returning to the factory settings).

- Average fuel consumption and average speed reset mode: A (Auto reset)
- Fuel consumption display unit: L/100 km
- Temperature unit: °C (Celsius)
- Display language: ENGLISH
- Cooperative language setting: A
- Operation sounds: ON (Operation sounds on)
- “REST REMINDER” display: OFF
- Turn-signal sound: Turn-signal sound 1
- Momentary fuel consumption with the green bar graph (Type 2): ON

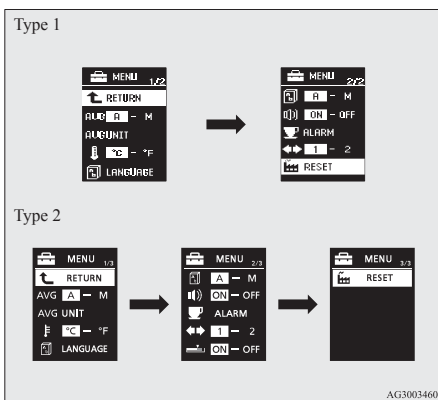

3. When you press and hold the multi-information meter switch for about 5 seconds or more, the buzzer sounds and all of the function settings are returned to the factory settings.

## NOTE

- The factory settings are as follows.



## Indication lamp, warning lamp, and information screen display list

E00523700013

### Indication and warning lamp list

E00523800694

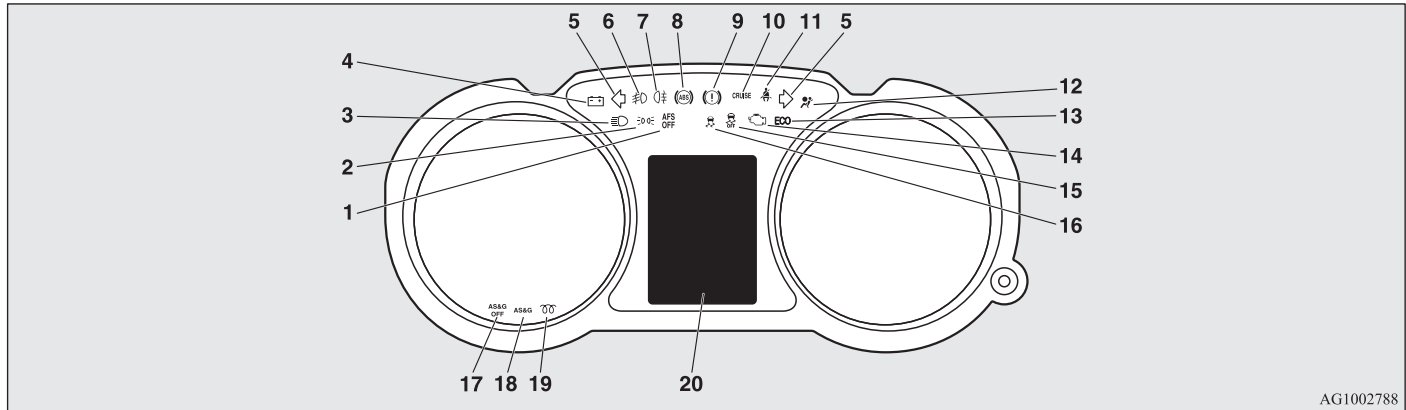

AG1002788

- |  |  |
|--|--|
| 1- Adaptive Front lighting System (AFS) OFF indication lamp* → p. 3-37, 3-49 | 11- Seat belt warning lamp → p. 2-20                                   |
| 2- Position lamp indication lamp → p. 3-37                                   | 12- Supplement Restraint System (SRS) warning lamp → p. 2-40           |
| 3- High-beam indication lamp → p. 3-37                                       | 13- ECO mode indicator* → p. 3-37                                      |
| 4- Charge warning lamp → p. 3-39   | 14- Check engine warning lamp → p. 3-38                                |
| 5- Turn-signal indication lamps/Hazard warning indication lamps → p. 3-37    | 15- Active Stability Control (ASC) OFF indicator* → p. 4-59            |
| 6- Front fog lamp indication lamp* → p. 3-37                                 | 16- Active Stability Control (ASC) indicator* → p. 4-59                |
| 7- Rear fog lamp indication lamp → p. 3-37                                   | 17- Auto Stop & Go (AS&G) OFF indication lamp* → p. 4-21               |
| 8- Anti-lock brake system (ABS) warning lamp → p. 4-56                       | 18- Auto Stop & Go (AS&G) indication lamp* → p. 4-19                   |
| 9- Brake warning lamp → p. 3-38  | 19- Diesel preheat indication lamp (diesel-powered vehicles) → p. 3-37 |
| 10- Cruise control indication lamp* → p. 4-61                                | 20- Information screen display list → p. 3-26                          |

## Information screen display list

E00523900015

When there is information to be announced, such as lamp reminders, a sound is emitted and the screen switches to the displays shown below. Refer to the appropriate page and take the necessary measures.

When the cause of the warning display is eliminated, the warning display goes out automatically.

Refer to “Warning display list (when the ignition switch is “OFF”)” on page 3-27.







Refer to “Warning display list (when the ignition switch is “ON”)” on page 3-29.

Refer to “Other interrupt displays” on page 3-35.











### NOTE

- A warning may be displayed on the information screen and the buzzer may sound in the following rare cases.  
This is caused by the system picking up interference such as noise or strong electromagnetic waves, and is not a functional problem.
    - An extremely strong electromagnetic wave is received from a source such as an illegal radio set, a spark from a wire, or a radar station.
    - Abnormal voltage or a static electricity discharge is generated by the operation of installed electrical equipment (including after-market parts).
- If the warning display appears many times, we recommend you to consult a MITSUBISHI MOTORS Authorized Service Point.

*Warning display list (when the ignition switch is “OFF”)*











Screen type 1	Screen type 2	Cause	Solution (Reference)
		<ul style="list-style-type: none"> <li>You have forgotten to turn off the lamps.</li> </ul>	Refer to “Lamps (headlamps, fog lamp, etc.) auto-cut-out function” on page 3-43.
		<ul style="list-style-type: none"> <li>The security alarm system is operating.</li> </ul>	Refer to “Security alarm system” on page 1-35.
		<ul style="list-style-type: none"> <li>After turning off the engine, an attempt was made to open the driver’s door with the ignition switch in any position other than “LOCK” (PUSH OFF).</li> </ul>	<ul style="list-style-type: none"> <li>Turn the ignition switch to the “LOCK” (PUSH OFF) position. Refer to “Ignition switch on reminder system” on page 1-27.</li> </ul>
		<ul style="list-style-type: none"> <li>An attempt was made to lock all the doors and the tailgate with the ignition switch in any position other than “LOCK” (PUSH OFF).</li> </ul>	<ul style="list-style-type: none"> <li>Turn the ignition switch to the “LOCK” (PUSH OFF) position. Refer to “Ignition switch turn-off reminder system” on page 1-15.</li> </ul>

### Instruments and controls











Screen type 1	Screen type 2	Cause	Solution (Reference)
 <p>KEY BATTERY LOW</p>	 <p>KEY BATTERY LOW</p>	<ul style="list-style-type: none"> <li>● There is a fault in the keyless operation system.</li> </ul>	Refer to “Keyless operation system” on page 1-07.
 <p>KEY MISSING</p>	 <p>KEY NOT DETECTED</p>		
 <p>CONFIRM KEY LOCATION</p>	 <p>KEY STILL IN VEHICLE</p>		
 <p>CHECK DOORS</p>	 <p>CHECK DOORS</p>		
 <p>SERVICE REQUIRED</p>	 <p>KEYLESS OPERATION SYSTEM SERVICE REQUIRED</p>		











Warning display list (when the ignition switch is “ON”)

E00524100795











Screen type 1	Screen type 2	Cause	Solution (Reference)
 <p>KEY BATTERY LOW</p>	 <p>KEY BATTERY LOW</p>	<ul style="list-style-type: none"> <li>● There is a fault in the keyless operation system.</li> </ul>	<p>Refer to “Keyless operation system” on page 1-07.</p>
 <p>KEY MISSING</p>	 <p>KEY NOT DETECTED</p>		
 <p>CONFIRM KEY LOCATION</p>	 <p>KEY STILL IN VEHICLE</p>		
 <p>CHECK DOORS</p>	 <p>CHECK DOORS</p>		
 <p>SERVICE REQUIRED</p>	 <p>KEYLESS OPERATION SYSTEM SERVICE REQUIRED</p>		

## Instruments and controls











Screen type 1	Screen type 2	Cause	Solution (Reference)
 CHECK	 BRAKE SYSTEM SERVICE REQUIRED	<ul style="list-style-type: none"> <li>● The brake fluid level in the reservoir has fallen to a low level.</li> <li>● There is a fault in the brake system.</li> </ul>	<ul style="list-style-type: none"> <li>● Immediately stop the vehicle in a safe place. We recommend you to consult a MITSUBISHI MOTORS Authorized Service Point. Refer to “Brake warning display” on page 3-38.</li> </ul>
 SERVICE REQUIRED	 ABS SERVICE REQUIRED	<ul style="list-style-type: none"> <li>● There is a fault in the ABS.</li> </ul>	<ul style="list-style-type: none"> <li>● Avoid sudden braking and high-speed driving, stop the vehicle in a safe place, and take corrective measures. Refer to “ABS warning” on page 4-56.</li> </ul>
		<ul style="list-style-type: none"> <li>● One of the doors or the tailgate is not completely closed. The open door is displayed.</li> </ul>	<ul style="list-style-type: none"> <li>● Close the door or tailgate. Refer to “Door ajar warning display screen (when the ignition switch is “ON”)” on page 3-17.</li> </ul>
 CLOSE HOOD	 CLOSE HOOD	<ul style="list-style-type: none"> <li>● The bonnet is open.</li> </ul>	<ul style="list-style-type: none"> <li>● Close the bonnet. Refer to “Bonnet” on page 8-03.</li> </ul>
 CHECK	 ENGINE OVERHEATING STOP SAFELY	<ul style="list-style-type: none"> <li>● The engine is overheated.</li> </ul>	<ul style="list-style-type: none"> <li>● Stop the vehicle in a safe place and take corrective measures. Refer to “Engine overheating” on page 6-04.</li> </ul>

Screen type 1	Screen type 2	Cause	Solution (Reference)
 SLOW DOWN	 TRANSMISSION OVERHEATING SLOW DOWN	<ul style="list-style-type: none"> <li>The automatic transmission (A/T or CVT) fluid temperature is too high.</li> </ul>	<p>Refer to “Automatic transmission INVECS-II Sports Mode 6A/T (Intelligent &amp; Innovative Vehicle Electronic Control System II)” on page 4-25.</p> <p>Refer to “Automatic transmission INVECS-III Sports Mode 6CVT (Intelligent &amp; Innovative Vehicle Electronic Control System III)” on page 4-30.</p>
 FASTEN SEAT BELT	 FASTEN SEAT BELT	<ul style="list-style-type: none"> <li>You turned the ignition switch to the “ON” position without fastening your seat belt.</li> </ul>	<ul style="list-style-type: none"> <li>Fasten your seat belt properly. Refer to “Seat belt warning” on page 2-20.</li> </ul>
 SERVICE REQUIRED	 FUEL SYSTEM SERVICE REQUIRED	<ul style="list-style-type: none"> <li>There is a fault in the fuel system.</li> </ul>	<ul style="list-style-type: none"> <li>We recommend you to consult a MITSUBISHI MOTORS Authorized Service Point.</li> </ul>
 RELEASE PARKING BRAKE	 RELEASE PARKING BRAKE	<ul style="list-style-type: none"> <li>You are driving with the parking brake still applied.</li> </ul>	<ul style="list-style-type: none"> <li>Release the parking brake. Refer to “Brake warning display” on page 3-38.</li> </ul>
 CHECK	 LOW OIL PRESSURE	<ul style="list-style-type: none"> <li>There is a fault in the engine oil circulation system.</li> </ul>	<ul style="list-style-type: none"> <li>Immediately stop the vehicle in a safe place. We recommend you to have it checked. Refer to “Oil pressure warning display” on page 3-41.</li> </ul>











## Instruments and controls

Screen type 1	Screen type 2	Cause	Solution (Reference)
 <b>SERVICE REQUIRED</b>	 <b>CHARGING SYSTEM SERVICE REQUIRED</b>	<ul style="list-style-type: none"> <li>● There is a fault in the charging system.</li> </ul>	<ul style="list-style-type: none"> <li>● Immediately stop the vehicle in a safe place. We recommend you to consult a MITSUBISHI MOTORS Authorized Service Point. Refer to “Charge warning display” on page 3-39.</li> </ul>
 <b>SERVICE REQUIRED</b>	 <b>AIRBAG SYSTEM SERVICE REQUIRED</b>	<ul style="list-style-type: none"> <li>● There is a fault in the SRS airbag or the pretensioner system.</li> </ul>	<ul style="list-style-type: none"> <li>● We recommend you to have it checked. Refer to “Supplemental restraint System (SRS) warning lamp” on page 2-40.</li> </ul>
 <b>SERVICE REQUIRED</b>	 <b>HEADLAMP LEVELLING SERVICE REQUIRED</b>	<ul style="list-style-type: none"> <li>● There is an automatic headlamp levelling fault.</li> </ul>	<ul style="list-style-type: none"> <li>● We recommend you to have it checked. Refer to “Automatic headlamp levelling” on page 3-47.</li> </ul>
 <b>SERVICE REQUIRED</b>	 <b>ASC SYSTEM SERVICE REQUIRED</b>	<ul style="list-style-type: none"> <li>● There is a fault in the Active Stability Control (ASC).</li> <li>● There is a fault in the hill start assist.</li> </ul>	<ul style="list-style-type: none"> <li>● We recommend you to have it checked. Refer to “Active stability control (ASC)” on page 4-58.</li> <li>● Have the vehicle checked at a MITSUBISHI MOTORS Authorized Service Point. Refer to “Hill start assist” on page 4-52.</li> </ul>
 <b>SERVICE REQUIRED</b>	 <b>4WD SYSTEM SERVICE REQUIRED</b>	<ul style="list-style-type: none"> <li>● There is a fault in the electronically controlled 4WD system.</li> </ul>	<ul style="list-style-type: none"> <li>● We recommend you to have it checked. Refer to “Electronically controlled 4WD system” on page 4-46.</li> </ul>



Screen type 1	Screen type 2	Cause	Solution (Reference)
 <p>SERVICE REQUIRED</p>	 <p>TRANSMISSION SERVICE REQUIRED</p>	<ul style="list-style-type: none"> <li>● There is a fault in the A/T or CVT.</li> <li>● A safety device in the Twin Clutch SST has been activated due to a possible malfunction in the Twin Clutch SST or in the engine electronic control module.</li> </ul>	<ul style="list-style-type: none"> <li>● We recommend you to have it checked. Refer to “Automatic transmission INVECS-II Sports Mode 6A/T (Intelligent &amp; Innovative Vehicle Electronic Control System II)” on page 4-25. Refer to “Automatic transmission INVECS-III Sports Mode 6CVT (Intelligent &amp; Innovative Vehicle Electronic Control System III)” on page 4-30. Refer to “Twin Clutch SST (Sport Shift Transmission)” on page 4-36.</li> </ul>
 <p>SLOW DOWN</p>	 <p>4WD SYSTEM OVERHEATING SLOW DOWN</p>	<ul style="list-style-type: none"> <li>● The electronically controlled 4WD system is hot.</li> </ul>	<p>Refer to “Electronically controlled 4WD system” on page 4-46.</p>
 <p>CHECK</p>	 <p>ENGINE SYSTEM SERVICE REQUIRED</p>	<ul style="list-style-type: none"> <li>● Problem with one of the systems without a specific message.</li> </ul>	<p>We recommend you to consult a MITSUBISHI MOTORS Authorized Service Point.</p>
 <p>SERVICE REQUIRED</p>	 <p>DPF SYSTEM SERVICE REQUIRED</p>	<ul style="list-style-type: none"> <li>● The fuel additives are running low.</li> </ul>	<ul style="list-style-type: none"> <li>● Refill the fuel additives at a MITSUBISHI MOTORS Authorized Service Point.</li> </ul>
 <p>REFUEL</p>	 <p>REFUEL</p>	<ul style="list-style-type: none"> <li>● The fuel is running low.</li> </ul>	<ul style="list-style-type: none"> <li>● Refuel as soon as possible. Refer to “Fuel remaining warning display” on page 3-15.</li> </ul>









## Instruments and controls

Screen type 1	Screen type 2	Cause	Solution (Reference)
 CHECK	 CHECK DPF SYSTEM	<ul style="list-style-type: none"> <li>● An excessive amount of particulate matter (PM) accumulates inside the diesel particulate filter (DPF).</li> </ul>	<ul style="list-style-type: none"> <li>● Refer to “Diesel particulate filter (DPF)” on page 4-17.</li> </ul>
 CHECK ENGINE OIL LEVEL	 CHECK ENGINE OIL LEVEL	<ul style="list-style-type: none"> <li>● On vehicles equipped with 4HK engine, when engine oil is running low.</li> <li>● On vehicles equipped with 4N14 engine, it is suspected that the engine oil level has increased excessively.</li> </ul>	<ul style="list-style-type: none"> <li>● On vehicles equipped with 4HK engine, stop the vehicle in a safe place, turn off the engine, and check the engine oil level. On vehicles equipped with 4N14 engine, immediately have your vehicle checked by a MITSUBISHI MOTORS Authorized Service Point. Refer to “Engine oil level warning display” on page 3-41.</li> </ul>
 REMOVE WATER IN SEPARATOR	 REMOVE WATER IN SEPARATOR	<ul style="list-style-type: none"> <li>● More than specified limit water has accumulated in the fuel filter.</li> </ul>	<ul style="list-style-type: none"> <li>● On vehicles equipped with 4HK engine, stop the vehicle in a safe place, turn off the engine, and remove the water from the fuel filter. On vehicles equipped with 4N14 engine, we recommend you to have it checked. Refer to “Fuel filter indicator display” on page 3-39 .</li> </ul>
 POSSIBLE ICY ROADS	 POSSIBLE ICY ROADS	<ul style="list-style-type: none"> <li>● The outside temperature is 3 °C (37 °F) or less.</li> </ul>	<ul style="list-style-type: none"> <li>● Be careful of ice on the road.</li> <li>● The road can be icy even when this warning is not displayed, so drive carefully.</li> </ul>
 AFS! SERVICE REQUIRED	 AFS! ADAPTIVE FRONT LIGHTING SERVICE REQUIRED	<ul style="list-style-type: none"> <li>● There is a fault in the Adaptive Front lighting System (AFS).</li> </ul>	<ul style="list-style-type: none"> <li>● We recommend you to have it checked. Refer to “Adaptive Front lighting System (AFS)” on page 3-48.</li> </ul>

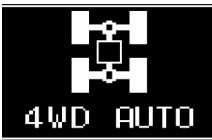
*Other interrupt displays (when the ignition switch is “ON”)*



E00524200611

The operation status of each system is displayed on the information screen. Refer to the appropriate page for the system for further details.



Screen type 1	Screen type 2	System operation status	Reference
 2WD	 2WD	<ul style="list-style-type: none"> <li>● When “2WD” mode is selected with the drive mode selector</li> </ul>	Refer to “Electronically controlled 4WD system” on page 4-46.
 4WD AUTO	 4WD AUTO	<ul style="list-style-type: none"> <li>● When “4WD AUTO” mode is selected with the drive mode selector</li> </ul>	
 4WD LOCK	 4WD LOCK	<ul style="list-style-type: none"> <li>● When “4WD LOCK” mode is selected with the drive mode selector</li> </ul>	
		<ul style="list-style-type: none"> <li>● When the Active Stability Control (ASC) is operating</li> </ul>	Refer to “Active stability control (ASC)” on page 4-58.
		<ul style="list-style-type: none"> <li>● When the reversing sensor system detects an obstruction</li> </ul>	Refer to “Reversing sensor system” on page 4-65.

This informs you that a periodic inspection is due.

## Instruments and controls

Screen type 1	Screen type 2	Solution
		We recommend you to have it checked. Refer to “Service reminder” on page 3-16.

The setting for rest interval can be changed.

Screen type 1	Screen type 2	Solution
		<p>Stop the vehicle in a safe place, turn off the engine, and take a rest.            Use this display as rough guide for taking rests during a long drive.            The interval from the start of your trip until this message is displayed can be set.            Refer to “Changing the function settings (when the ignition switch is “ON”)” on page 3-17.            The display and buzzer alert the driver when the set time is reached. If you continue to drive without having a rest, the buzzer sounds about every 5 minutes to encourage you to take a rest.</p> <ul style="list-style-type: none"> <li>● In the following cases, the time driven is reset and the display returns to the previous display screen.              After this, when the set time is reached again, the buzzer and display encourage you to take a rest.             <ul style="list-style-type: none"> <li>• The buzzer sounds 3 times.</li> <li>• The ignition switch is turned to the “OFF” position.</li> <li>• The multi-information meter switch is held for about 2 seconds or more.</li> </ul> </li> </ul>

## Indication lamps

E00501600100



### Turn-signal indication lamps/ Hazard warning indication lamps

E00501700358

These indication lamps blink in the following situations.

- When the turn-signal lever is moved to activate a turn-signal lamp.  
Refer to “Turn-signal lever” on page 3-48.
- When the hazard warning flasher switch is pressed to activate the hazard warning lamps.  
Refer to “Hazard warning flasher switch” on page 3-50.
- When the hazard warning lamps automatically activate due to sudden braking while driving.  
Refer to “Emergency stop signal system” on page 4-54.

#### NOTE

- If these indication lamps blink too fast due to any operation other than sudden braking, the cause may be a blown lamp bulb or a faulty turn-signal connection.



### High-beam indication lamp

E00501800173

This indication lamp illuminates when the high-beam is used.



### Front fog lamp indication lamp\*

E00501900350

This lamp illuminates while the front fog lamps are on.



### Rear fog lamp indication lamp

E00502000185

This lamp illuminates while the rear fog lamp is on.



### Position lamp indication lamp

E00508900173

This indication lamp illuminates while the position lamps are on.



### Adaptive Front lighting System (AFS) OFF indication lamp\*

E00525000010

This indication lamp illuminates when the AFS is OFF.



### ECO mode indicator\*

E00529800032

Except for vehicles for Russia, Kazakhstan and Ukraine, this indicator will be displayed when fuel-efficient driving is achieved.



### Diesel preheat indication lamp (diesel-powered vehicles)

E00502300289

This indication lamp illuminates when the ignition switch is placed in the “ON” position. As the glow plug becomes hot, the lamp goes out and the engine can be started.

#### NOTE

- If the engine is cold, the diesel preheat indication lamp is on for a longer time.
- On vehicles equipped with 4HK engine, when the engine has not been started within about 5 seconds after the diesel preheat indication lamp went out, return the ignition switch to the “LOCK” position. Then, turn the switch to the “ON” position to preheat the engine again.
- When the engine is warm, the diesel preheat indication lamp does not come on even if the ignition switch is placed in the “ON” position.

## Warning lamps

E00502400147



### Brake warning lamp

E00502502067

This lamp illuminates when the ignition switch is turned to the “ON” position, and goes off after a few seconds.

Always make sure that the lamp goes off before driving.

With the ignition switch in the “ON” position, the brake warning lamp illuminates under the following conditions:

- When the parking brake lever has been engaged.
- When the brake fluid level in the reservoir falls to a low level.
- When the brake force distribution function is not operating correctly.

### CAUTION

- In the situations listed below, brake performance may be compromised or the vehicle may become unstable if brakes are applied suddenly; consequently, avoid driving at high speeds or applying the brakes suddenly. Furthermore, the vehicle should be brought to a stop in a safe location and to have it checked.

### CAUTION

- The brake warning lamp does not illuminate when the parking brake is applied or does not turn off when the parking brake is released.
- The ABS warning lamp and brake warning lamp illuminate at the same time  
For details, refer to “ABS warning lamp” on page 4-56.
- The brake warning lamp remains illuminated during driving.
- The vehicle should be brought to a halt in the following manner when brake performance has deteriorated.
  - Depress the brake pedal harder than usual.  
Even if the brake pedal moves down to the very end of its possible stroke, keep it pressed down hard.
  - Should the brakes fail, use engine braking to reduce your speed and pull the parking brake lever.  
Depress the brake pedal to operate the stop lamp to alert the vehicles behind you.



### Check engine warning lamp

E00502601553

This lamp is a part of an onboard diagnostic system which monitors the emissions, engine control system or A/T control system/CVT control system/Twin Clutch SST control system.

If a problem is detected in one of these systems, this lamp illuminates or flashes. Although your vehicle will usually be drivable and not need towing, we recommend you to have the system checked as soon as possible.

This lamp will also illuminate when the ignition switch is turned “ON”, and goes off after the engine has started. If it does not go off after the engine has started, we recommend you to have the vehicle checked.

### CAUTION

- Prolonged driving with this lamp on may cause further damage to the emission control system. It could also affect fuel economy and drivability.
- If the lamp does not illuminate when the ignition switch is turned to the “ON” position, we recommend you to have the system checked.

**⚠ CAUTION**

- If the lamp illuminates while the engine is running, avoid driving at high speeds and have the system inspected by a MITSUBISHI MOTORS Authorized Service Point as soon as possible. Accelerator pedal and brake pedal response may be negatively influenced under these conditions.

## NOTE

- The engine electronic control module accommodating the onboard diagnostic system has various fault data (especially about the exhaust emission) stored. This data will be erased if a battery cable is disconnected which will make a rapid diagnosis difficult. Do not disconnect a battery cable when the check engine warning lamp is ON.

**Charge warning lamp**

E00502700456

This lamp illuminates when the ignition switch is turned to the “ON” position, and goes off after the engine has started. A warning is also displayed on the multi-information display.

**⚠ CAUTION**

- If it illuminates while the engine is running, there is a problem in the charging system. Immediately park your vehicle in a safe place and we recommend you to have it checked.

**Information screen display**

E00524600080

**Fuel filter indicator display\***

E00529400054

Type 1



Type 2



When the ignition switch is “ON”, if more than specified limit water has accumulated in the fuel filter, a warning display is displayed on the information screen in the multi-information display.

## **A CAUTION**

- On vehicles equipped with 4HK engine, if this indicator is displayed while driving, stop the vehicle in a safe place, turn off the engine, and remove the water from the fuel filter.

On vehicles equipped with 4N14 engine, if this warning display is displayed we recommend you to have it checked. Prolonged driving with the warning display shown may damage the engine.

### NOTE

- If “REMOVE WATER IN SEPARATOR” does not go out or appears frequently after removing the water, we recommend you to consult a MITSUBISHI MOTORS Authorized Service Point.

## Brake warning display

E00524700326

### Type 1



### Type 2



This warning is displayed if you drive with the parking brake still applied. The warning lamp in the instrument cluster only illuminates when the parking brake is applied.

## **A CAUTION**

- If a vehicle is driven without releasing the parking brake, the brake will be overheated, resulting in ineffective braking and possible brake failure. If this warning is displayed, release the parking brake.

### Type 1



### Type 2



When the ignition switch is turned to the “ON” position, if the brake fluid is low, this warning is displayed.

The warning lamp in the instrument cluster also illuminates.

## **A CAUTION**

- If this warning stays illuminated and does not go out while driving, there is a danger of ineffective braking. In this case, immediately park your vehicle in a safe place and we recommend you to have it checked.
- If the brake warning display is displayed and the brake warning lamp and the ABS warning lamp are illuminated at the same time, the braking force distribution function will not operate, so the vehicle may be destabilised during sudden braking. Avoid sudden braking and high-speed driving, stop the vehicle in a safe place, and we recommend you to have it checked.
- The vehicle should be brought to a halt in the following manner when brake performance has deteriorated.
  - Depress the brake pedal harder than usual. Even if the brake pedal moves down to the very end of its possible stroke, keep it pressed down hard.
  - Should the brakes fail, use engine braking to reduce your speed and pull the parking brake lever. Depress the brake pedal to operate the stop lamp to alert the vehicles behind you.



## Charge warning display

E00524800242

Type 1



Type 2



If there is a fault with the charging system, the warning display is displayed on the information screen in the multi-information display. The warning lamp in the instrument cluster also illuminates.

### **⚠ CAUTION**

- If the warning is displayed while the engine is running, immediately park your vehicle in a safe place and we recommend you to have it checked.

## Oil pressure warning display

E00524900256

Type 1



Type 2



If the engine oil pressure drops while the engine is running, the warning display is displayed on the information screen in the multi-information display.

### **⚠ CAUTION**

- If the vehicle is driven while the engine oil is low, or the oil level is normal but the warning is displayed, the engine may burn out and be damaged.
- If the warning is displayed while the engine is running, immediately park your vehicle in a safe place and check the engine oil level.
- If the warning is displayed while the engine oil level is normal, have it inspected.

## Engine oil level warning display\*

E00526700102

Type 1



Type 2



On vehicles equipped with 4HK engine, when the ignition switch is "ON", if the engine oil level is below the specified limit, the warning display is displayed on the information screen in the multi-information display.

On vehicles equipped with 4N14 engine, when the ignition switch is in ON, if it is suspected that the engine oil level has increased excessively, the warning display is displayed on the information screen in the multi-information display.

### **⚠ CAUTION**

- If this warning is displayed while driving, stop the vehicle in a safe place, turn off the engine, and check the engine oil level. Refer to "Engine oil" on page 8-04.

NOTE

- On vehicles equipped with 4HK engine, the warning remains displayed for a short while after refilling the oil to the proper amount.
- On vehicles equipped with 4N14 engine, immediately have your vehicle checked by a MITSUBISHI MOTORS Authorized Service Point.

## Combination headlamps and dipper switch

E00506001715

### Headlamps

NOTE

- Do not leave the lights on for a long time while the engine is stationary (not running). A rundown battery could result.
- When it rains, or when the vehicle has been washed, the inside of the lens sometimes becomes foggy, but this does not indicate a functional problem. When the lamp is switched on, the heat will remove the fog. However, if water gathers inside the lamp, we recommend you to have it checked.

*Type 1*

Rotate the switch to turn on the lamps.

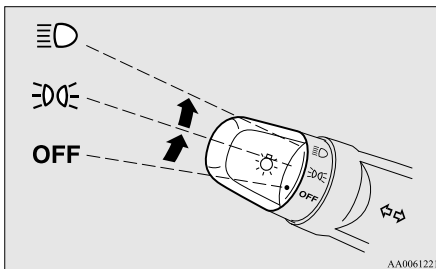

OFF	All lamps off
☾☽☾	Position, tail, licence plate and instrument panel lamps on
☾☽☾☾	Headlamps and other lamps go on

*Type 2*

Rotate the switch to turn on the lamps.

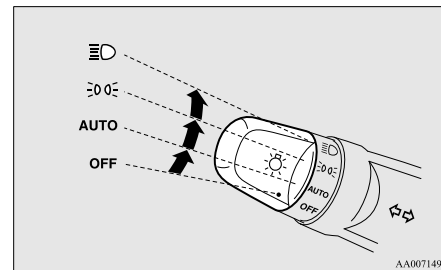

OFF	All lamps off
AUTO	With the ignition switch in the "ON" position, headlamps, position, tail, licence plate, and instrument panel lamps turn on and off automatically in accordance with outside light level. All lamps turn off automatically when the ignition switch is turned to the "OFF" position.
☾☽☾	Position, tail, licence plate and instrument panel lamps on
☾☽☾☾	Headlamps and other lamps go on

## NOTE

- On vehicles with the rain sensor, the sensitivity of the automatic on/off control can be adjusted. For further information, please contact your MITSUBISHI MOTORS Authorized Service Point.  
On vehicles equipped with MITSUBISHI Multi-Communication System (MMCS), screen operations can be used to make the adjustment.  
Refer to the separate owner's manual for details.
- When the headlamps are turned off by the automatic on/off control with the ignition switch in the "ON" position, the front fog lamps (if so equipped) and rear fog lamps also go off. When the headlamps are subsequently turned back on by the automatic on/off control, the front fog lamps also come on but the rear fog lamp stays off. If you wish to turn the rear fog lamp back on, operate the switch again.
- Do not place anything on the automatic light sensor (A), and do not clean with a glass cleaner.

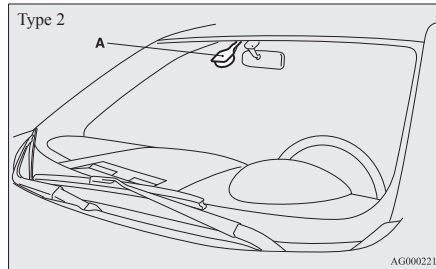
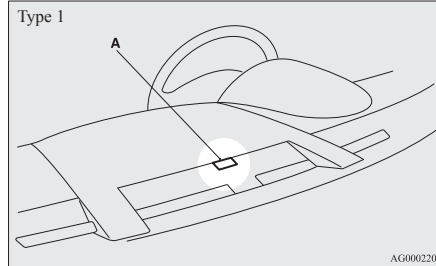

- If the lamps do not turn on or off with the switch in the "AUTO" position, manually operate the switch and we recommend you to have your vehicle checked.

**Vehicles with Daytime Running Lamp\***

When the engine is running and the lamp switch is set to the "AUTO" or "OFF" position, the low beam of the headlamps, tail lamp etc., will illuminate.

## NOTE

- The daytime running lamp can be deactivated. For further information, we recommend you to consult a MITSUBISHI MOTORS Authorized Service Point.  
The regulations concerning daytime running lamp may differ from country to country. Find out and follow the laws and regulations of the area you're driving in.

**Lamps (headlamps, fog lamp, etc.) auto-cutout function**

- If, while the lamp switch is in the "E" position, the ignition switch is turned to the "LOCK" position or "ACC" position, or the key is removed from the ignition switch, the lamps automatically go out when the driver's door is opened.

[When the engine was started using the key]

- If the key is removed and the driver's door is opened, a buzzer sounds at a high pitch intermittently to remind the driver to turn off the lamps.

[When the engine was started using the key-less operation function]

- If the ignition switch is turned to the "LOCK" (PUSH OFF) position and the driver's door is opened, a buzzer sounds at a high pitch intermittently to remind the driver to turn off the lamps.

## Instruments and controls

- If the ignition switch is turned to the “LOCK” position or “ACC” position, or the key is removed from the ignition switch, while the lamp switch is in the “D” position, the lamps will remain on for about 3 minutes while the driver’s door is shut and will then automatically go out.



### NOTE

- The lamp auto-cutout will not function when the lamp switch is in the “D” position.
- The lamp auto-cutout function can also be disabled.

For further information, we recommend you to consult a MITSUBISHI MOTORS Authorized Service Point.

On vehicles equipped with MITSUBISHI Multi-Communication System (MMCS), screen operations can be used to make the adjustment. Refer to the separate owner’s manual for details.

### When you want to keep the lamps on:

1. Turn the lamp switch in the “OFF” position while the ignition switch is in the “LOCK” or “ACC” position.
2. Turn on the lamps with the switch in the “D” or “D” position again, then the lamps will remain on.

### NOTE

- When the engine was started using the key, if the driver’s door is opened and the key is removed, the lamp monitor buzzer sounds at a high pitch intermittently.

The buzzer stops when the driver’s door is closed. (The warning is also displayed on the multi-information display.)

The buzzer stops in the following manner.

- Turn the lamp switch to the “OFF” position.
- Close the driver’s door.
- When the engine was started using the keyless operation function, if the driver’s door is opened and the ignition switch is in the “LOCK” position, the lamp monitor buzzer sounds at a high pitch intermittently. The buzzer stops when the driver’s door is closed. (The warning is also displayed on the multi-information display.) The buzzer stops in the following manner.
  - Turn the lamp switch to the “OFF” position.
  - Close the driver’s door.

## Lamp monitor buzzer

E00506100344

[When the engine was started using the key]

If the driver’s door is opened when the key is in the “LOCK” or “ACC” position or removed from the ignition switch while the lamps are on, a buzzer will sound to remind the driver to turn off the lamps.

[When the engine was started using the keyless operation function]

If, while the lamps are illuminated, the ignition switch is set to the “LOCK” or “ACC” position, or the driver’s door is opened with the ignition switch set to the “LOCK” position, a buzzer will sound to remind the driver to turn off the lamps.

In both cases, the buzzer will automatically stop if the auto-cutoff function is activated, the lamp switch is turned off, or the door is closed.

## Dipper (High/Low beam change)

E00506200329

When the lamp switch is in the “D” position, the beam changes from high to low (or low to high) each time the lever is pulled fully (1). While the high-beam is on, the high-beam indication lamp in the instrument cluster will also illuminate.

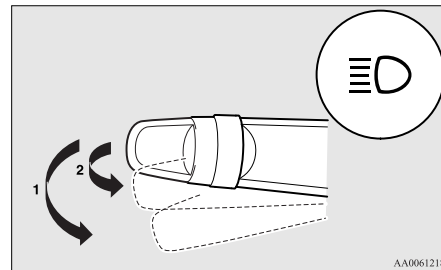

## Headlamp flasher

E00506300199

The high-beams flash when the lever is pulled slightly (2), and will go off when it is released. When the high-beam is on, the high-beam indication lamp in the instrument cluster will illuminate.

### NOTE

- The high-beams can also flash when the lamp switch is OFF.
- If you turn the lamps off with the headlamps set to high-beam, the headlamps are automatically returned to their low-beam setting when the lamp switch is next turned to the “D” position.

## Welcome light

E00528900368

This function turns on the position and tail lamps for about 30 seconds after the UNLOCK switch (A) on the remote control transmitter is pressed when the combination headlamps and dipper switch is in the “OFF” or “AUTO” position (for vehicles equipped with the automatic lamp control). On vehicles equipped with automatic lamp control, the welcome light function will operate only when it is dark outside the vehicle.

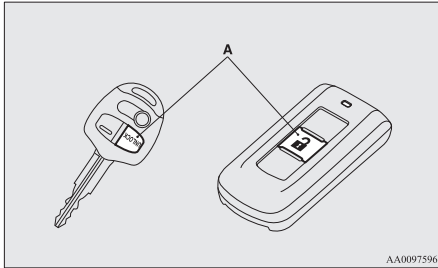

### NOTE

- While the welcome light function is operating, perform one of the following operations to cancel the function.
  - Push the LOCK switch (B) on the remote control transmitter.

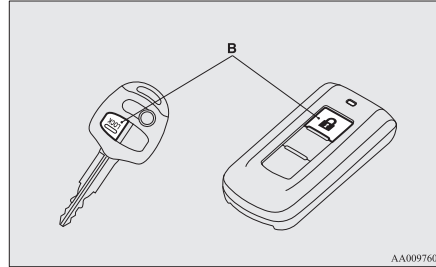

- Turn the combination headlamps and dipper switch to the “OFF” or “AUTO” position.
- Turn the ignition switch to the “ON” position.
- It is possible to modify functions as follows:
  - The headlamps can be set to come on in the low beam setting.
  - The welcome light function can be deactivated.

For further information, please contact your MITSUBISHI MOTORS Authorized Service Point.

On vehicles equipped with MITSUBISHI Multi-Communication System (MMCS), screen operations can be used to make the adjustment. Refer to the separate owner’s manual for details.

## Coming home light

E00529000340

This function turns on the headlamps in the low beam setting for about 30 seconds after the ignition switch is turned to the “LOCK” position.

1. Turn the combination headlamps and dipper switch to the “OFF” or “AUTO” position (for vehicles equipped with the automatic lamp control).
2. Turn the ignition switch to the “LOCK” position. Also, if a key was used to start the engine, remove the key from the ignition switch.
3. Within 60 seconds of turning the ignition switch to the “LOCK” position, pull the turn signal lever towards you.

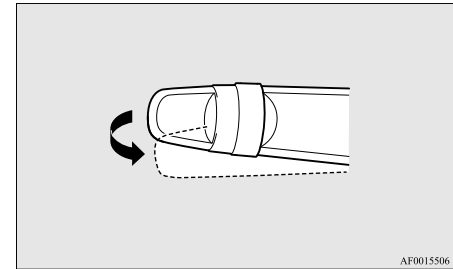

4. The headlamps will come on in the low-beam setting for about 30 seconds. After the headlamps go off, the headlamps can be turned on again in the low beam setting for about 30 seconds by pulling the turn signal lever towards you within 60 seconds of turning the ignition switch to the “LOCK” position. To turn on the headlamps again after 60 seconds of turning the ignition switch to the “LOCK” position, repeat the process from step 1.

NOTE

- While the coming home light function is operating, perform one of the following operations to cancel the function.
  - Pull the lever towards you.
  - Turn the combination headlamps and dipper switch to the “000” or “00” position.
  - Turn the ignition switch to the “ON” position.
- It is possible to modify functions as follows:
  - The time that the headlamps remain on can be changed.
  - The coming home light function can be deactivated.

For further information, please contact your MITSUBISHI MOTORS Authorized Service Point.

On vehicles equipped with MITSUBISHI Multi-Communication System (MMCS), screen operations can be used to make the adjustment. Refer to the separate owner’s manual for details.

## Headlamp levelling

E00517400031

### Headlamp levelling switch (except for vehicles with discharge headlamps)

E00517500511

The angle of the headlamp beam varies depending on the load carried by the vehicle.

The headlamp levelling switch can be used to adjust the headlamp illumination distance (when the lower beam is illuminated) so that the headlamps’ glare does not distract other drivers.

Set the switch according to the following table.

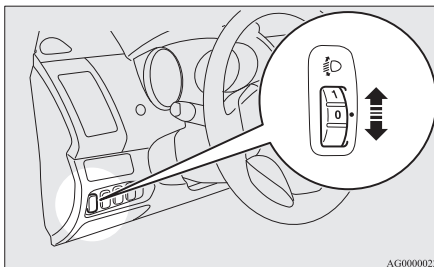

AG0000022

## ⚠ CAUTION

- Always perform adjustments before driving. Do not attempt to adjust while driving, as it could cause an accident.

### 5 - person seat

Vehi- cle con- di- tion					
Switch posi- tion	“0”	“0”	“1”	“2” or “3”	“2” or “3” or “4”

●: 1 person

: Full luggage loading

- Switch position 0- Driver only/Driver + 1 front passenger
- Switch position 1- 5 passengers (including driver)
- Switch position 2- 5 passengers (including driver) + Full luggage loading {Vehicles without heavy duty suspension}  
/Driver + full luggage loading {Vehicles without heavy duty suspension (4WD)}
- Switch position 3- 5 passengers (including driver) + Full luggage loading {Vehicles with heavy duty suspension}  
/Driver + full luggage loading {Vehicles without heavy duty suspension (2WD)}  
/Driver + full luggage loading {Vehicles with heavy duty suspension}
- Switch position 4- Driver + full luggage loading {Vehicles with heavy duty suspension and high ground clearance suspension}

 Full luggage loading







- Switch position 0- Driver only/Driver + 1 front passenger
- Switch position 1- Driver + 1 front passenger + 2 passengers on third seat
- Switch position 2- 7 passengers (including driver)
- Switch position 3- 7 passengers (including driver) + Full luggage loading  
/Driver + full luggage loading {Vehicles without high ground clearance suspension}
- Switch position 4- Driver + full luggage loading {Vehicles with high ground clearance suspension}

### Automatic headlamp levelling (vehicles with discharge headlamps)

E00517600336

This mechanism automatically adjusts the direction of the headlamps (beam position) depending on changes in the condition of the vehicle, such as the number of occupants or luggage weight. When the headlamps are illuminated with the ignition switch in the “ON” position, the beam position of the headlamps is automatically adjusted when the vehicle is stopped.

#### 7 - person seat

Vehi- cle con- dition						
Switch h po- sition	“0”	“0”	“1”	“2”	“3”	“3” or “4”

●: 1 person

### Headlamp automatic levelling system warning display

Type 1



Type 2



If there is a fault in the automatic headlamp levelling system, the warning display is displayed on the information screen in the multi-information display.

### CAUTION

- If a warning is displayed, the system may be malfunctioning, so we recommend you to have your vehicle inspected.

## Turn-signal lever

E00506501387

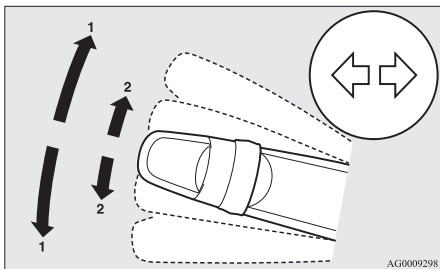

### 1- Turn-signals

When making a normal turn, use position (1). The lever will return automatically when cornering is completed.

### 2- Lane-change signals

When moving the lever to (2) slightly to change a lane, the turn-signal lamps and indication lamp in the instrument cluster will only flash while the lever is operated.

Also, when you move the lever to (2) slightly then release it, the turn-signal lamps and indication lamp in the instrument cluster will flash 3 times.

## NOTE

- If the lamp flashes unusually quickly, the bulb in a turn-signal lamp may have burned out. We recommend you to have the vehicle inspected.
- It is possible to activate the following functions.

- Flashing of the turn-signal lamps when the lever is operated with the ignition switch or the operation mode is in ACC.
- Deactivate the turn-signal lamp 3-flash function for lane changes
- The time required to operate the lever for the 3-flash function can be adjusted. For further information, we recommend you to consult a MITSUBISHI MOTORS Authorized Service Point. On vehicles equipped with MITSUBISHI Multi-Communication System (MMCS), screen operations can be used to make the adjustment. Refer to the separate owner's manual for details.

## Adaptive Front lighting System (AFS)\*

E00525100196

The AFS makes it easier for the driver to see ahead at night. While the lamp switch is in the “ $\equiv$ ” or “AUTO” position (with the headlamps on), turning the steering wheel causes a bending lamp to automatically come on and illuminate the road in the direction in which the vehicle is being turned, thereby expanding the illuminated area of the road.

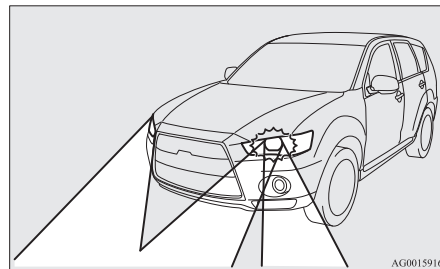



When the steering wheel is turned (on a curve, for example), the road ahead in the direction in which the vehicle is being turned is illuminated. (The left bending lamp comes on when the vehicle is turned leftward, and the right bending lamp comes on when the vehicle is turned rightward.)

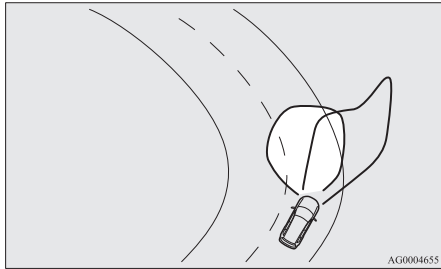

### **CAUTION**

- If either bending lamp is kept on for about 15 minutes, it automatically goes off. If you wish to make it come on again, first turn the steering wheel back from its turned position to the straight-ahead position.
- The amount of steering wheel operation necessary to illuminate the bending lamps changes according to the vehicle speed. (The lower the vehicle speed, the more steering wheel operation is necessary.) However, the lamps can be set before driving to illuminate with just a small amount of steering wheel operation.

### NOTE

- The AFS does not work in any of the following circumstances:
  - The gearshift lever or selector lever is in the “R” position.
  - The lamp switch is in the “OFF” or “OFF” position.
  - The vehicle speed is 100 km/h (62 mph) or higher.
  - The “AFS OFF” switch has been pushed to stop the AFS from working.

### Adaptive Front lighting System (AFS) OFF switch

E00525200214

To turn off the AFS, push the “AFS OFF” switch. The AFS OFF indication lamp in the meter cluster will come on. Push the switch again to turn the AFS back on.

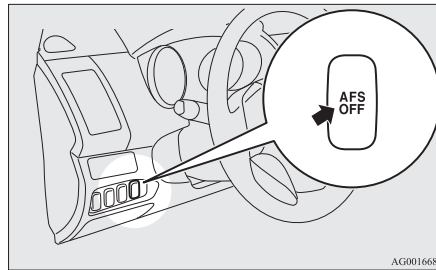

### NOTE

- When the ignition switch is turned off, the status of the “AFS OFF” switch is held in memory.

### Adaptive Front lighting System (AFS) indications

E00525300172

Indicator



Warning display type 1



Warning display type 2



In the event of an abnormality in the AFS, a warning display message appears in the information window of the multi-information display and the “AFS OFF” indication lamp in the meter cluster blinks.

### **CAUTION**

- If the warning is displayed, the system may be malfunctioning. We recommend you to consult a MITSUBISHI MOTORS Authorized Service Point.

NOTE

- If the “AFS OFF” indication lamp flashes while you are driving, stop the vehicle in a safe place, turn the ignition switch to the “ACC” or “OFF” position, then restart the engine.  
If the “AFS OFF” indication lamp stays off, the AFS is normal.
- When the emergency spare wheel is fitted on the vehicle, the AFS may not work normally. Push the “AFS OFF” switch to turn the AFS off. Also, fit a standard wheel on the vehicle instead of the emergency spare wheel as soon as possible.
- If the headlamps cause reflections that make driving difficult (on snowy slopes, for example), push the “AFS OFF” switch to turn the AFS off.

### Hazard warning flasher switch

E00506600772

Use the hazard warning flasher switch when the vehicle has to be parked on the road for any emergency. The hazard warning flashers can always be operated, regardless of the position of the ignition switch.

Push the switch to turn on the hazard warning flashers, all turn-signal lamps flash continuously. To turn them off, push the switch again.

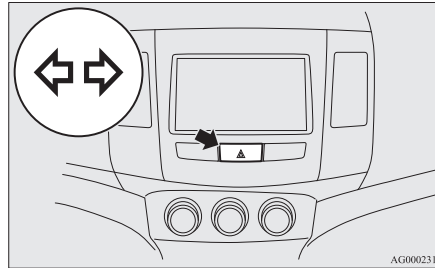

NOTE

- While the hazard warning lamps are blinking due to having manually pushed the switch, the emergency stop signal system does not operate. Refer to “Emergency stop signal system” on page 4-54.

### Fog lamp switch

E00506700034

#### Front fog lamp switch\*

E00508300542

The front fog lamps can be operated while the headlamps or tail lamps are on. Turn the knob in the “ON” direction to turn on the front fog lamps. An indication lamp in the instrument cluster will also come on. Turn the knob in the “OFF” direction to turn off the front fog lamps. The knob will automatically return to its original position when you release it.

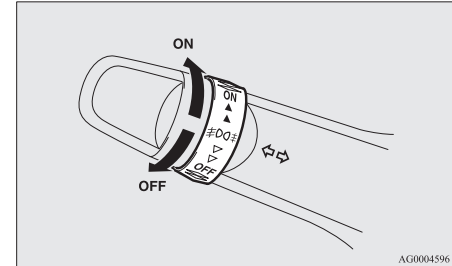

NOTE

- The front fog lamps are automatically turned off when the headlamps or tail lamps are turned off. To turn the front fog lamps on again, turn the knob in the “ON” direction after turning on the headlamps or tail lamps.
- Do not use fog lamps except in conditions of fog, otherwise excessive lamp glare may temporarily blind oncoming vehicle drivers.

- In case of vehicles with Daytime Running Lamp, the front fog lamps can be operated even if the lamp switch is set to the “OFF” position.

## Rear fog lamp switch

E00508400383

The rear fog lamp can be operated when the headlamps or front fog lamps (if so equipped) turn on. An indication lamp in the instrument cluster comes on when the rear fog lamp is turned on.

[Vehicle without front fog lamps]

Turn the knob once in the “ON” direction to turn on the rear fog lamp. To turn the rear fog lamp off, turn the knob once in the “OFF” direction. The knob will automatically return to its original position when you release it.

[Vehicle with front fog lamps]

Turn the knob once in the “ON” direction to turn on the front fog lamps. Turn the knob once more in the “ON” direction to turn on the rear fog lamp. To turn the rear fog lamp off, turn the knob once in the “OFF” direction. Turn the knob once more in the “OFF” direction to turn off the front fog lamps. The knob will automatically return to its original position when you release it.

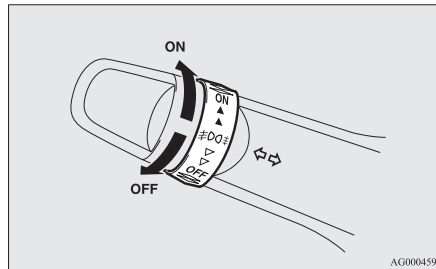

### NOTE

- The rear fog lamp is automatically turned off when the headlamps or front fog lamps (if so equipped) are turned off.
- To turn the rear fog lamp on again, turn the knob once in the “ON” direction after turning on the headlamps. (Vehicle without front fog lamps)
- To turn the rear fog lamp on again, turn the knob twice in the “ON” direction after turning on the headlamps. (Vehicle with front fog lamps)
- In case of vehicles with Daytime Running Lamp, the rear fog lamp can be operated even if the lamp switch is set to the “OFF” position.

## Wiper and washer switch

E00507101218

### ⚠ CAUTION

- If the washer is used in cold weather, the washer fluid sprayed against the glass may freeze, which may hinder visibility. Warm the glass with the defroster or rear window demister before using the washer.

## Windscreen wipers

E00516900299

### NOTE

- To ensure a clear rearward view, the rear window wiper will automatically perform several continuous operations if the gearshift lever or the selector lever is put in the “R” position while the windscreen wipers are operating. Refer to “Rear window wiper and washer” on page 3-55.

### *Except for vehicles equipped with rain sensor*

The windscreen wipers can be operated with the ignition switch in the “ON” or “ACC” position.

## Instruments and controls

If the blades are frozen to the windscreen or rear window, do not operate the wipers until the ice has melted and the blades are freed, otherwise the wiper motor may be damaged.

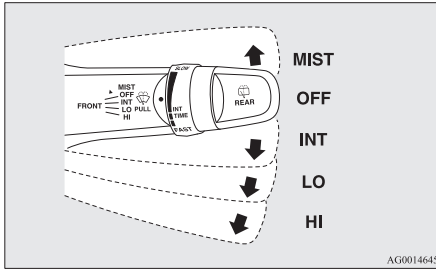

- 3
- MIST- Misting function  
The wipers will operate once.
  - OFF- Off
  - INT- Intermittent (Speed sensitive)
  - LO- Slow
  - HI- Fast

### To adjust intermittent intervals

With the lever in the “INT” (speed-sensitive) position, the intermittent intervals can be adjusted by turning the knob (A).

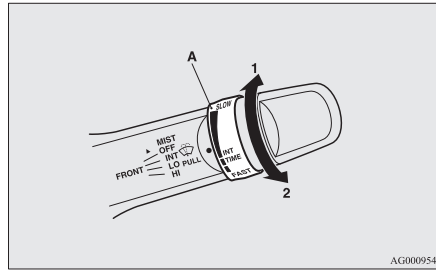

- 1- Fast
- 2- Slow

### NOTE

- The speed-sensitive-operation function of the windscreen wipers can be deactivated. For further information, we recommend you to consult a MITSUBISHI MOTORS Authorized Service Point. On vehicles equipped with MITSUBISHI Multi-Communication System (MMCS), screen operations can be used to make the adjustment. Refer to the separate owner's manual for details.

### Misting function

The misting function can be used when the ignition switch is in the “ON” or “ACC” position.

The wipers will operate once if the wiper lever is raised to the “MIST” position and released. This operation is useful when it is drizzling, etc. The wipers will continue to operate while the lever is held in the “MIST” position.

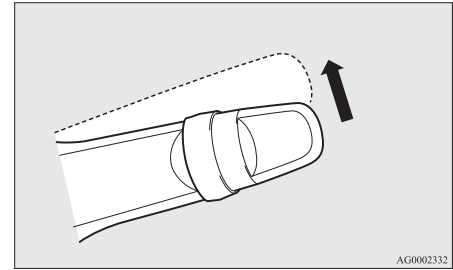

### Vehicles with rain sensor

E00517000268

The windscreen wipers can be operated with the ignition switch in the “ON” or “ACC” position. If the blades are frozen to the windscreen or rear window, do not operate the wipers until the ice has melted and the blades are freed, otherwise the wiper motor may be damaged.

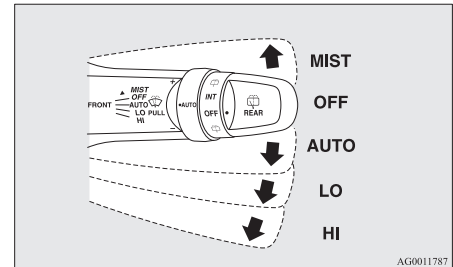

- MIST- Misting function  
The wipers will operate once.
- OFF- Off
- AUTO- Auto-wiper control  
Rain sensor  
The wipers will automatically operate depending on the degree of wetness on the windscreen.
- LO- Slow
- HI- Fast

**Rain sensor**

Can only be used when the ignition switch is in the “ON” position.

If the lever is put in the “AUTO” position, the rain sensor (A) will detect the extent of rain (or snow, other moisture, dust, etc.) and the wipers will operate automatically.

Keep the lever in the “OFF” position if the windscreen is dirty and the weather is dry.

Wiper operation under these conditions can scratch the windscreen and damage the wipers.

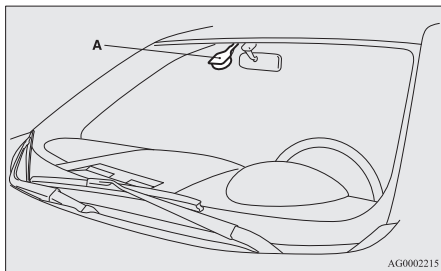

**CAUTION**

- With the ignition switch in the “ON” position and the lever in the “AUTO” position, the wipers may automatically operate in the situations described below. If your hands get trapped, you could suffer injuries or the wipers could malfunction. Be sure to turn the ignition switch to the “OFF” position or move the lever to the “OFF” position to deactivate the rain sensor.
  - When cleaning the outside surface of the windscreen, if you touch on top of the rain sensor.
  - When cleaning the outside surface of the windscreen, if you wipe with a cloth on top of the rain sensor.
  - When using an automatic car wash.
  - A physical shock is applied to the windscreen.
  - A physical shock is applied to the rain sensor.

**NOTE**

- To protect the rubber parts of the wipers, this operation of the wipers does not take place when the vehicle is stationary and the ambient temperature is about 0 °C or lower.
- Do not cover the sensor by affixing a sticker or label to the windscreen. Also, do not put any water-repellent coating on the windscreen. The rain sensor would not be able to detect the extent of rain, and the wipers might stop working normally.
- In the following cases, the rain sensor may be malfunctioning.

Have the vehicle checked at a MITSUBISHI MOTORS Authorized Service Point.

- When the wipers operate at a constant interval despite changes in the extent of rain.
- When the wipers do not operate even though it is raining.
- The wipers may automatically operate when things such as insects or foreign objects are affixed to the windscreen on top of the rain sensor or when the windscreen is frozen. Objects affixed to the windscreen will stop the wipers when the wipers cannot remove them. To operate the wipers again, move the lever in the “LO” or “HI” position. Also, the wipers may operate automatically due to strong direct sunlight or electromagnetic wave. To stop the wipers, place the lever in the “OFF” position.
- Contact a MITSUBISHI MOTORS Authorized Service Point when replacing the windscreen or reinforcing the glass around the sensor.

**To adjust the sensitivity of the rain sensor**

With the lever in the “AUTO” (rain sensor) position, it is possible to adjust the sensitivity of the rain sensor by turning the knob (B).

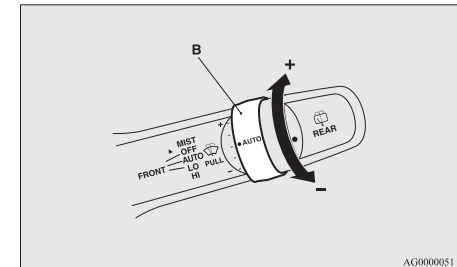

## Instruments and controls

- “+”- Higher sensitivity to rain
- “-”- Lower sensitivity to rain

### NOTE

- It is possible to activate the following functions. For further information, we recommend you to consult a MITSUBISHI MOTORS Authorized Service Point. On vehicles equipped with MITSUBISHI Multi-Communication System (MMCS), screen operations can be used to make the adjustment. Refer to the separate owner's manual for details.
  - Automatic operation (rain droplet sensitive) can be changed to intermittent operation (vehicle-speed sensitive).
  - Automatic operation (rain droplet sensitive) can be changed to intermittent operation (except vehicle-speed sensitive).

### Misting function

Move the lever in the direction of the arrow and release, to operate the wipers once. Use this function when you are driving in mist or drizzle.

The wipers will operate once if the lever is raised to the “MIST” position and released when the ignition switch is in the “ON” or “ACC” position. The wipers will continue to operate while the lever is held in the “MIST” position.

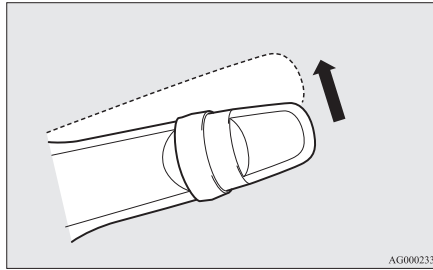

The wipers will operate once if the lever is moved to the “AUTO” position and the knob (C) is turned in the “+” direction when the ignition switch is in the “ON” position.

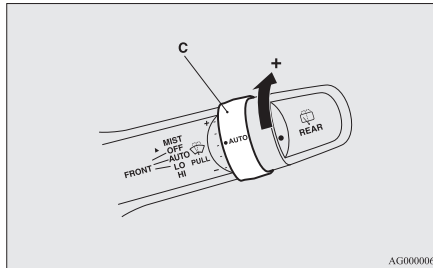

## Windscreen washer

E00507201118

The windscreen washer can be operated with the ignition switch in the “ON” or “ACC” position. The washer fluid will be sprayed onto the windscreen by pulling the lever towards you. When the wipers are not in operation or in intermittent operation, by pulling the lever towards you, the wipers will operate several times while the washer fluid is being sprayed.

Except for vehicles for Russia, Kazakhstan and Ukraine, then about 6 seconds later, wipers operate once more.

On vehicles equipped with a headlamp washer, while the headlamps are on, the headlamp washer will operate once together with the windscreen washer.

Also, except for vehicles for Russia, Kazakhstan and Ukraine, by releasing the lever soon after pulling it towards you, the washer fluids will be sprayed several times while the wipers are operating several times. (Comfort washer) Then about 6 seconds later, wipers operate once more. Comfort washer will stop operating with any operation of the lever.

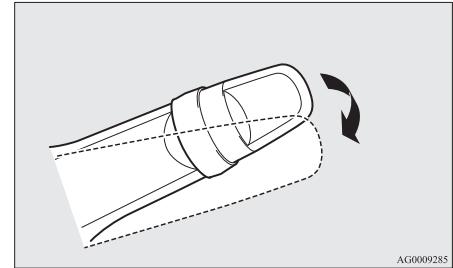

## CAUTION

- If the washer is used in cold weather, the washer fluid sprayed against the glass may freeze resulting in poor visibility. Heat the glass with the defroster or demister before using the washer.

### NOTE

- It is possible to modify functions as follows:
  - Causing the wiper never to operate when washer fluid is sprayed.
  - Except for vehicles for Russia, Kazakhstan and Ukraine, deactivating the comfort washer.
  - Except for vehicles for Russia, Kazakhstan and Ukraine, deactivating the function that operates the wipers once more about 6 seconds later.
  - Vehicles for Russia, Kazakhstan and Ukraine, activating the comfort washer.
  - Vehicles for Russia, Kazakhstan and Ukraine, the wipers can be set to operate again after about 6 seconds.

For further information, we recommend you to consult a MITSUBISHI MOTORS Authorized Service Point.

On vehicles equipped with MITSUBISHI Multi-Communication System (MMCS), screen operations can be used to make the adjustment. Refer to the separate owner's manual for details.

## Rear window wiper and washer

E00507301005

The rear window wiper and washer switch can be operated with the ignition switch in the "ON" or "ACC" position.

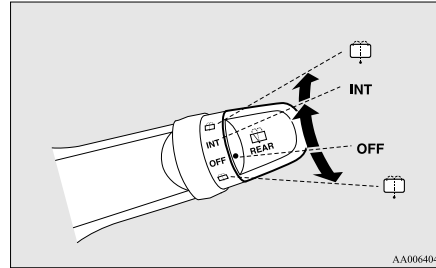

- INT - The wiper operates continuously for several seconds then operates intermittently at intervals of about every 8 seconds
- OFF - Off
-  - The washer fluid will be sprayed onto the rear window when the knob is turned fully in either direction. The wipers operate automatically several times while the washer fluid is being sprayed.

### NOTE

- The rear window wiper will automatically perform several continuous operations if the gearshift lever or the selector lever is put in the "R" position while the windscreen wipers or the rear window wiper is operating. (automatic operation mode)

After the automatic operation, the rear window wiper will stop operating if the knob is in the "OFF" position. If the knob is in the "INT" position, the rear window wiper will return to the intermittent operation.

It is possible to set the rear window wiper to perform the automatic operation only if the gearshift lever or the selector lever is put in the "R" position while the rear window wiper is operating with the knob in the "INT" position.

For further information, we recommend you to consult a MITSUBISHI MOTORS Authorized Service Point.

- If the knob is in the "OFF" position, turn the knob to the "INT" position twice quickly to operate the rear window wiper continuously. (continuous operation mode)
- Turn the knob to the "OFF" position to stop the rear window wiper continuous operation.
- The interval for intermittent operation can be adjusted.

For further information, we recommend you to consult a MITSUBISHI MOTORS Authorized Service Point.

On vehicles equipped with MITSUBISHI Multi-Communication System (MMCS), screen operations can be used to make the adjustment. Refer to the separate owner's manual for details.

## Instruments and controls

### Headlamp washer switch\*

E00507800247

The headlamp washer can be operated with the ignition switch in the “ON” or “ACC” position and the lamp switch at the “ ” position.

Push the button once and the washer fluid will be sprayed on to the headlamps.

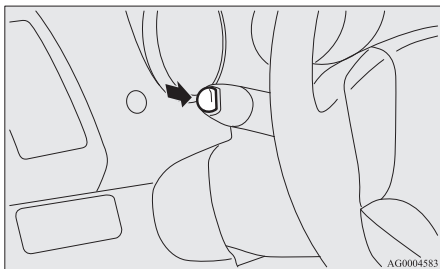

#### NOTE

- If the ignition switch is in the “ON” or “ACC” position and the headlamps are on, the headlamp washer operates together with the windscreen washer the first time the windscreen washer lever is pulled.

### Precautions to observe when using wipers and washers

E00510000025

- If the moving wipers become blocked by ice or other deposits on the glass, the motor may burn out even if the wiper switch is turned to OFF. If obstruction occurs, park your vehicle in a safe place, turn off the ignition, and clean the deposits from the glass so that the wipers operate smoothly.
- Do not use the wipers when the glass is dry. They may scratch the glass surface and the blades wear out prematurely.
- Before using the wipers in cold weather, check that the wiper blades are not frozen onto the glass. The motor may burn out if the wipers are used with the blades frozen onto the glass.
- Avoid using the washer continuously for more than 20 seconds. Do not operate the washer when the fluid reservoir is empty. Otherwise, the motor may burn out.
- Periodically check the level of washer fluid in the reservoir and refill if required. During cold weather, add a recommended washer solution that will not freeze in the washer reservoir. Failure to do so could result in loss of washer function and frost damage to the system components.

### Wiper de-icer switch\*

E00507700129

The rear window demister switch can be operated when the engine is running.

When the front wipers have frozen to the windscreen at the parked positions, turning on this switch will heat the windscreen to make the wipers operable. Press the switch and the deicer will operate and turn on the indication lamp (A).

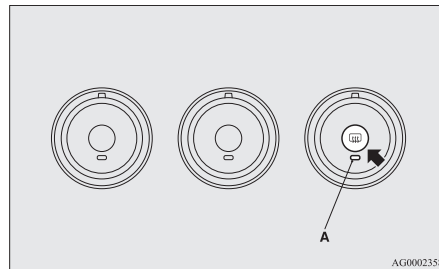

#### NOTE

- The switch is automatically turned off after operating for approximately 20 minutes. To turn off the switch while it is operating, press the switch again.



## Rear window demister switch

E00507901072

The rear window demister switch can be operated when the engine is running.

Push the switch to turn on the rear window demister. It will be turned off automatically in about 20 minutes. To turn off the demister within about 20 minutes, push the switch again.

The indication lamp (A) will illuminate while the demister is on.

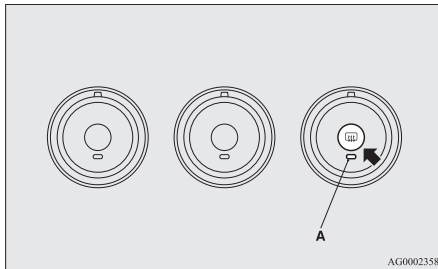

### NOTE

- When the rear window demister switch is pressed, the outside rear-view mirrors are pressed, the outside rear-view mirrors are defogged or defrosted. Refer to “Heated mirror” on page 4-12.
- When the rear window demister switch is pushed, the window glass becomes warm and the wipers become operable. Refer to “Wiper de-icer switch” on page 3-56.
- The demister switch is not to melt snow but to clear mist. Remove snow before use of the demister switch.

- When cleaning the inside of the rear window, use a soft cloth and wipe gently along the heater wires, being careful not to damage the wires.
- Do not allow objects to touch the inside of the rear window glass, damaged or broken heater wires may result.

## Horn switch

E00508000318

Press the steering wheel on or around the “” mark.

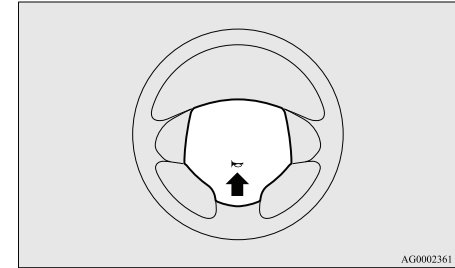

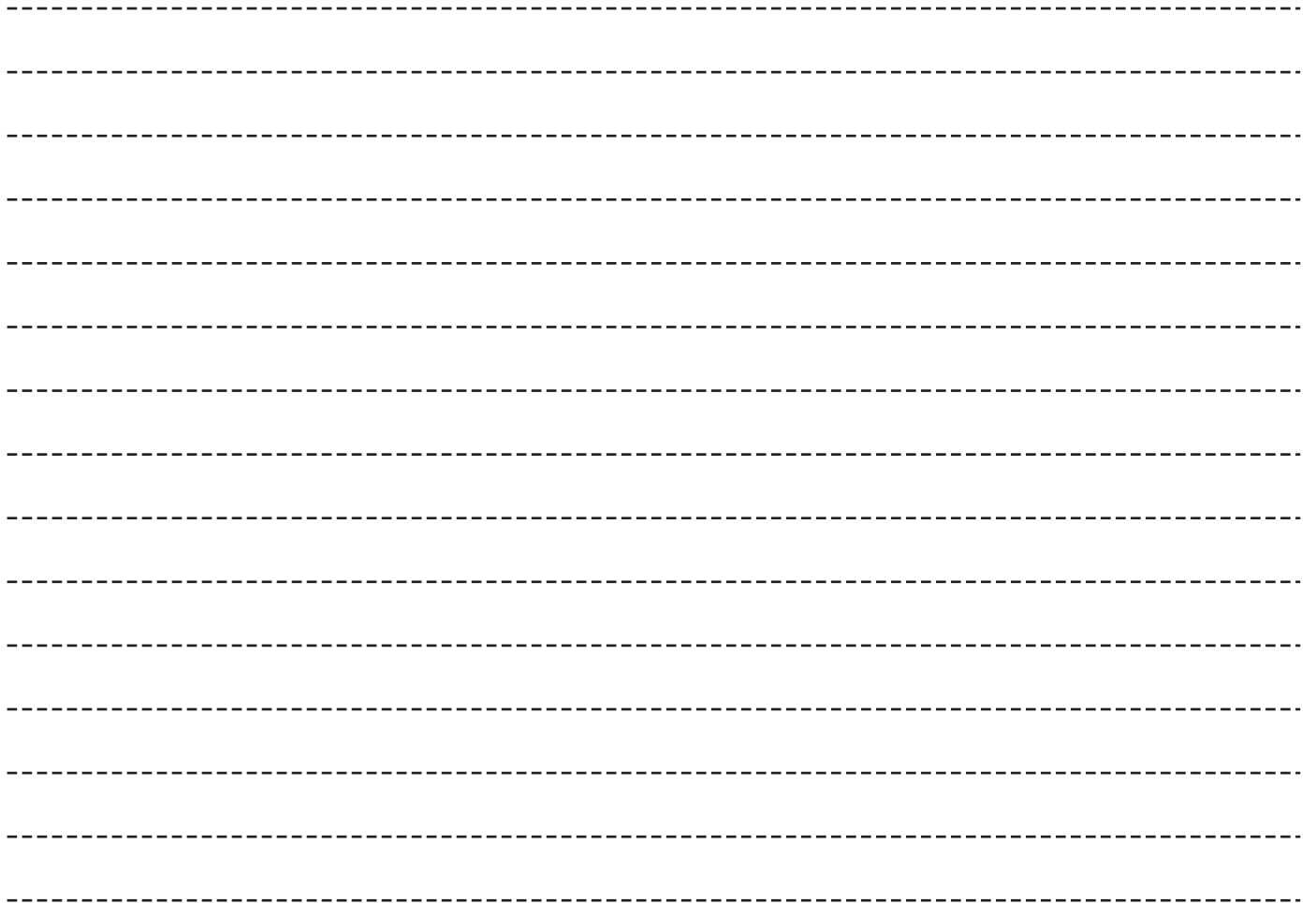

## *Starting and driving*

Economical driving.....	4-02	Brake assist system.....	4-54
Driving, alcohol and drugs.....	4-02	Emergency stop signal system.....	4-54
Safe driving techniques.....	4-03	Anti-lock brake system (ABS).....	4-55
Running-in recommendations.....	4-04	Power steering system.....	4-57
Parking brake.....	4-07	Active stability control (ASC)*.....	4-58
Parking.....	4-08	Cruise control*.....	4-60
Steering wheel height adjustment.....	4-09	Reversing sensor system*.....	4-65
Inside rear-view mirror.....	4-09	Rear-view camera*.....	4-68
Outside rear-view mirrors.....	4-10	Cargo loads.....	4-70
Ignition switch.....	4-12	Trailer towing.....	4-72
Steering wheel lock.....	4-14		
Starting and stopping the engine.....	4-14		
Diesel particulate filter (DPF)*.....	4-17		
Turbocharger operation*.....	4-18		
Auto Stop & Go (AS&G) system*.....	4-19		
Manual transmission*.....	4-22		
Automatic transmission INVECS-II Sports Mode 6A/T (Intelligent & Innovative Vehicle Electronic Control System II)*.....	4-25		
Automatic transmission INVECS-III Sports Mode 6CVT (Intelligent & Innovative Vehicle Electronic Control System III)*.....	4-30		
Twin Clutch SST (Sport Shift Transmission)*.....	4-36		
Electronically controlled 4WD system*.....	4-46		
4-wheel drive operation.....	4-48		
Inspection and maintenance following rough road oper- ation.....	4-50		
Cautions on handling of 4-wheel drive vehicles.....	4-50		
Braking.....	4-51		
Hill start assist*.....	4-52		

## Starting and driving

### *Economical driving*

E00600100789

For economical driving, there are some technical requirements that have to be met. The prerequisite for low fuel consumption is a properly adjusted engine. In order to achieve longer life of the vehicle and the most economical operation, we recommend you to have the vehicle checked at regular intervals in accordance with the service standards.

Fuel economy and generation of exhaust gas and noise are highly influenced by personal driving habits as well as the particular operating conditions. The following points should be observed in order to minimize wear of brakes, tyres and engine as well as to reduce environmental pollution.

### **Starting the engine**

Avoid sudden acceleration and sudden starts, as they will increase fuel consumption.

### **Shifting**

Shift only at an appropriate speed and engine speed. Always use the highest shift position possible. The drive mode-selector should be set to “2WD” when driving 4WD vehicles on normal roads and express ways to obtain best possible fuel economy.

### **City traffic**

Frequent starting and stopping increases the average fuel consumption. Use roads with smooth traffic flow whenever possible. When driving on congested roads, avoid use of a low shift position at high engine speeds.

### **Idling**

The vehicle consumes fuel even during idling. Avoid extended idling whenever possible.

### **Speed**

At higher vehicle speed, more fuel is consumed. Avoid driving at full speed. Even a slight release of the accelerator pedal will save a significant amount of fuel.

### **Tyre inflation pressure**

Check the tyre inflation pressures at regular intervals. Low tyre inflation pressure increases road resistance and fuel consumption. In addition, low tyre pressures adversely affect tyre wear and driving stability.

### **Cargo loads**

Do not drive with unnecessary articles in the luggage compartment. Especially during city driving where frequent starting and stopping is necessary, the increased weight of the vehicle will greatly affect fuel consumption. Also avoid driving with unnecessary luggage or carriers, etc., on the roof; the increased air resistance will increase fuel consumption.

### **Cold engine starting**

Starting of a cold engine consumes more fuel. Unnecessary fuel consumption is also caused by keeping a hot engine running. After the engine is started, commence driving as soon as possible.

### **Air conditioning**

The use of the air conditioning will increase the fuel consumption.

### *Driving, alcohol and drugs*

E00600200070

Drunk driving is one of the most frequent causes of accidents.

Your driving ability can be seriously impaired even with blood alcohol levels far below the legal minimum. If you have been drinking, don't drive. Ride with a designated non-drinking driver, call a cab or a friend, or use public transportation.

Drinking coffee or taking a cold shower will not make you sober.

Similarly, prescription and nonprescription drugs affect your alertness, perception and reaction time. Consult with your doctor or pharmacist before driving while under the influence of any of these medications.

## **WARNING**

### ● **NEVER DRINK AND DRIVE.**

**Your perceptions are less accurate, your reflexes are slower and your judgment is impaired.**

## Safe driving techniques

E00600300446

Driving safety and protection against injury cannot be fully ensured. However, we recommend that you pay extra attention to the following:

### Seat belts

Before starting the vehicle, make sure that you and your passengers have fastened your seat belts.

### Floor mats

#### **⚠ WARNING**

- **Keep floor mats clear of the pedals by correctly laying floor mats that are suitable for the vehicle.**

**To prevent the floor mats from slipping out of position, securely retain them using the hook etc.**

**Note that laying a floor mat over a pedal or laying one floor mat on top of another can obstruct pedal operation and lead to a serious accident.**

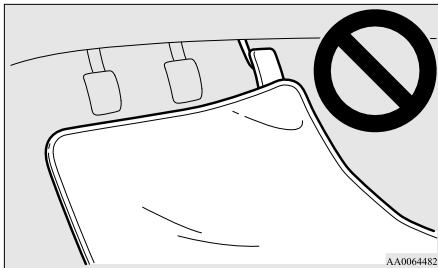

AA0064482

## Carrying children in the vehicle

- Never leave your vehicle unattended with the key and children inside the vehicle. Children may play with the driving controls and this could lead to an accident.
- Make sure that infants and small children are properly restrained in accordance with the laws and regulations, and for maximum protection in case of an accident.
- Prevent children from playing in the luggage compartment. It is quite dangerous to allow them to play there while the vehicle is moving.

## Loading luggage

When loading luggage, be careful not to load above the height of seats. This is dangerous not only because rearward vision will be obstructed, but also the luggage may be projected into the passenger compartment under hard braking.

## Running-in recommendations

E00600402193

During the running-in period for the first 1,000 km (620 miles), it is advisable to drive your new vehicle using the following precautions as a guideline to aid long life as well as future economy and performance.

- Do not race the engine at high speeds.
- Avoid rapid starting, accelerating, braking and prolonged high-speed running.
- Keep to the running-in speed limit shown below.  
Please note that the legal speed limits must be adhered to.
- Do not exceed loading limits.
- Refrain from towing a trailer.

### Vehicles with M/T

Shift point	Speed limit	
	Petrol-powered vehicles	Diesel-powered vehicles
1 <sup>st</sup> gear	30 km/h (19 mph)	20 km/h (12 mph)
2 <sup>nd</sup> gear	60 km/h (37 mph)	45 km/h (28 mph)
3 <sup>rd</sup> gear	90 km/h (56 mph)	70 km/h (43 mph)
4 <sup>th</sup> gear	115 km/h (71 mph)	90 km/h (56 mph)
5 <sup>th</sup> gear	145 km/h (90 mph)	120 km/h (74 mph)
6 <sup>th</sup> gear	-	145 km/h (90 mph)

**Vehicles with A/T**

Shift point	Speed limit
1 <sup>st</sup> gear	15 km/h (9 mph)
2 <sup>nd</sup> gear	50 km/h (30 mph)
3 <sup>rd</sup> gear	85 km/h (53 mph)
4 <sup>th</sup> gear	120 km/h (74 mph)
5 <sup>th</sup> gear	130 km/h (81 mph)
6 <sup>th</sup> gear	130 km/h (81 mph)

**Vehicles with CVT**

Shift point		Speed limit
“D” (DRIVE)		130 km/h (81 mph)
In sports mode	1 <sup>st</sup> position	50 km/h (30 mph)
	2 <sup>nd</sup> position	60 km/h (37 mph)
	3 <sup>rd</sup> position	70 km/h (43 mph)
	4 <sup>th</sup> position	90 km/h (56 mph)
	5 <sup>th</sup> position	120 km/h (74 mph)
	6 <sup>th</sup> position	130 km/h (81 mph)

**Vehicles with Twin Clutch SST**

Shift point		Speed limit
In sports mode	“D” drive operation	
1 <sup>st</sup> position	D1	20 km/h (12 mph)
2 <sup>nd</sup> position	D2	45 km/h (28 mph)
3 <sup>rd</sup> position	D3	70 km/h (43 mph)
4 <sup>th</sup> position	D4	95 km/h (59 mph)
5 <sup>th</sup> position	D5	110 km/h (68 mph)
6 <sup>th</sup> position	D6	130 km/h (81 mph)



## Parking brake

E00600501634

To park the vehicle, first bring it to a complete stop, fully engage the parking brake.

### To apply

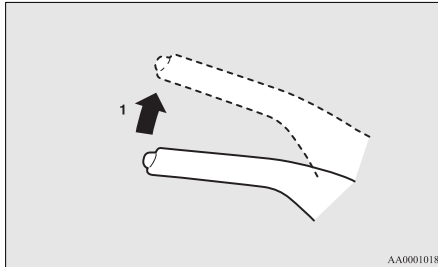

- 1- Firmly depress and hold the brake pedal, then pull the lever up without pushing the button at the end of hand grip.

## **CAUTION**

- When you intend to apply the parking brake, firmly press the brake pedal to bring the vehicle to a complete stop before pulling the parking brake lever. Pulling the parking brake lever with the vehicle moving could make the rear wheels lock up, thereby making the vehicle unstable. It could also make the parking brake malfunction.

### NOTE

- Apply sufficient force to the parking brake lever to hold the vehicle stationary after the foot brake is released.
- If the parking brake does not hold the vehicle stationary after the foot brake is released, have your vehicle checked immediately.

### To release

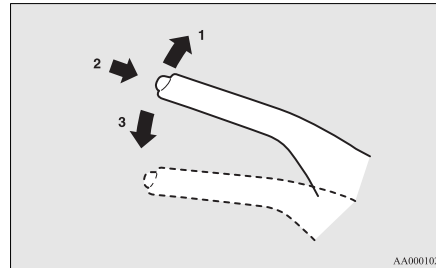

- 1- Firmly depress and hold the brake pedal, then pull the lever up slightly.
- 2- Push the button at the end of hand grip.
- 3- Lower the lever fully.

## **CAUTION**

- Before driving, be sure that the parking brake is fully released and brake warning lamp is off. If you drive without the parking brake fully released, the warning display will appear on the information screen in the multi-information display. If a vehicle is driven without releasing the parking brake, the brake will be overheated, resulting in ineffective braking and possible brake failure.

### Warning lamp



### Warning display type 1



### Warning display type 2



## CAUTION

- If the brake warning lamp does not extinguish when the parking brake is fully released, the brake system may be abnormal. Have your vehicle checked immediately. For details, refer to “Brake warning lamp” on page 3-38.

## Parking

E00600601358

To park the vehicle, fully engage the parking brake, and then move the gearshift lever to 1<sup>st</sup> or “R” (Reverse) position for vehicles equipped with M/T, or set the selector lever (A/T or CVT) or gearshift lever (Twin Clutch SST) to “P” (PARK) position for vehicles equipped with A/T, CVT or Twin Clutch SST.

### Parking on a hill

To prevent the vehicle from rolling, follow these procedures:

#### *Parking on a downhill slope*

Turn the front wheels towards the kerb and move the vehicle forward until the kerb side wheel gently touches the kerb.

On vehicles equipped with M/T, apply the parking brake and place the gearshift lever into the “R” (Reverse) position.

On vehicles equipped with A/T, CVT or Twin Clutch SST, apply the parking brake and place the selector lever (A/T or CVT) or gearshift lever (Twin Clutch SST) into the “P” (PARK) position. If necessary, apply chocks to wheels.

#### *Parking on an uphill slope*

Turn the front wheels away from the kerb and move the vehicle back until the kerb side wheel gently touches the kerb.

On vehicles equipped with M/T, apply the parking brake and place the gearshift lever into the 1<sup>st</sup> position.

On vehicles equipped with A/T, CVT or Twin Clutch SST, apply the parking brake and place the selector lever (A/T or CVT) or gearshift lever (Twin Clutch SST) into the “P” (PARK) position. If necessary, apply chocks to wheels.

## NOTE

- If your vehicle is equipped with A/T, CVT or Twin Clutch SST, be sure to apply the parking brake before moving selector lever (A/T or CVT) or gearshift lever (Twin Clutch SST) to the “P” (PARK) position. If you move selector lever (A/T or CVT) or gearshift lever (Twin Clutch SST) to the “P” (PARK) position before applying the parking brake, it may be difficult to disengage selector lever (A/T or CVT) or gearshift lever (Twin Clutch SST) from the “P” (PARK) position when next you drive the vehicle, requiring application of a strong force the selector lever (A/T or CVT) or gearshift lever (Twin Clutch SST) to move from the “P” (PARK) position.

### Parking with the engine running

Never leave the engine running while you take a short sleep/rest. Also, never leave the engine running in a closed or poorly ventilated place.

## WARNING

- Leaving the engine running risks injury or death from accidentally moving the gearshift lever (with M/T or Twin Clutch SST) or the selector lever (with A/T or CVT) or the accumulation of toxic exhaust fumes in the passenger compartment.

## Where you park

### **⚠️ WARNING**

- Do not park your vehicle in areas where combustible materials such as dry grass or leaves can come in contact with a hot exhaust, since a fire could occur.

## When leaving the vehicle

Always carry the key and lock all doors and the tailgate when leaving the vehicle unattended. Always try to park your vehicle in a well lit area.

## Steering wheel height adjustment

E00600700352

1. Release the tilt lock lever while holding the steering wheel up.
2. Adjust the steering wheel to the desired height.
3. Securely lock the steering wheel by pulling the tilt lock lever fully upward.

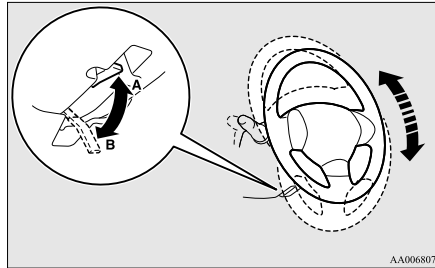

AA0068073

A- Locked  
B- Release

### **⚠️ WARNING**

- Do not attempt to adjust the steering wheel while you are driving the vehicle.

## Inside rear-view mirror

E00600800366

Adjust the rear-view mirror only after making any seat adjustments so you have a clear view to the rear of the vehicle.

### **⚠️ WARNING**

- Do not attempt to adjust the rear-view mirror while driving. This can be dangerous. Always adjust the mirror before driving.

Adjust the rear-view mirror to maximize the view through the rear window.

## To adjust the vertical mirror position

It is possible to move the mirror up and down to adjust its position.

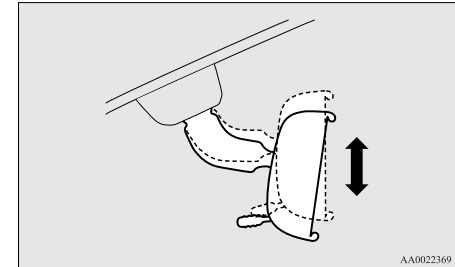

AA0022369

## Starting and driving

### To reduce the glare

The lever (A) at the bottom of the mirror can be used to adjust the mirror to reduce the glare from the headlamps of vehicles behind you during night driving.

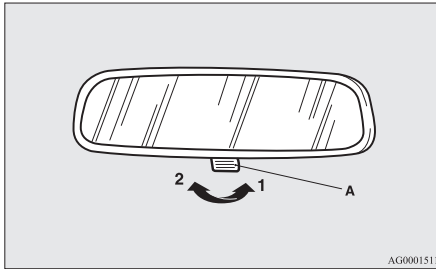

- 1- Normal
- 2- Anti-glare

### Outside rear-view mirrors

E00600900628

### To adjust the mirror position

E00601000479

The outside rear-view mirrors can be operated when the ignition switch is in the "ON" or "ACC" position.

## **⚠ WARNING**

- Do not attempt to adjust the rear-view mirrors while driving. This can be dangerous. Always adjust the mirrors before driving.
- Your vehicle is equipped with convex type mirrors. Please take into consideration, that objects you see in the mirror will look smaller and farther away compared to a normal flat mirror. Do not use this mirror to estimate distance of following vehicles when changing lanes.

1. Place the lever (A) to the same side as the mirror whose adjustment is desired.

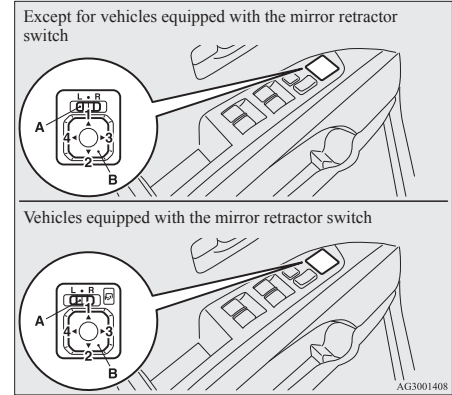

- L- Left outside mirror adjustment
- R- Right outside mirror adjustment

2. Press the switch (B) to the left, right, up or down to adjust the mirror position.
  - 1- Up
  - 2- Down
  - 3- Right
  - 4- Left
3. Return the lever (A) back to the middle position (•).

### Retracting and extending the outside mirrors

E00601100584

The outside mirror can be folded in towards the side window to prevent damage when parking in narrow areas.

## **CAUTION**

- Do not drive the vehicle with the mirror folded in. The lack of rearward visibility normally provided by the mirror could lead to an accident.

### [Except for vehicles equipped with the mirror retractor switch]

Push the mirror towards the back of the vehicle with your hand to retract it. When extending the mirror, pull it out towards the front of the vehicle until it clicks to lock in place.

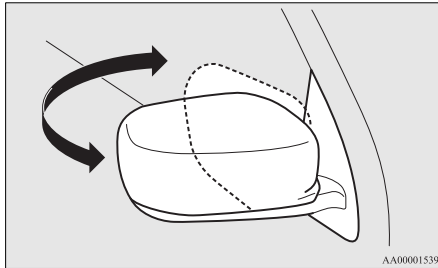

### [For vehicles equipped with the mirror retractor switch]

#### *Retracting and extending the mirrors using the mirror retractor switch*

With the ignition switch in the “ON” or “ACC” position, push the mirror retractor switch to retract the mirrors. Push it again to extend the mirrors to their original positions.

After placing the ignition switch in the “LOCK” position, it is possible to retract and extend the mirrors using the mirror retractor switch for about 30 seconds.

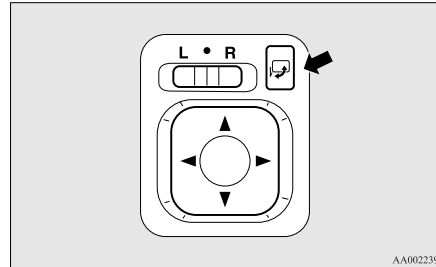

## **CAUTION**

- It is possible to retract and extend the mirrors by hand. After retracting a mirror using the mirror retractor switch, however, you should extend it by using the switch again, not by hand. If you extended the mirror by hand after retracting it using the switch, it would not properly lock in position. As a result, it could move because of the wind or vibration while you are driving, taking away your rearward visibility.

### NOTE

- Be careful not to get your hands trapped while a mirror is moving.

- If you move a mirror by hand or it moves after hitting a person or object, you may not be able to return it to its original position using the mirror retractor switch. If this happens, push the mirror retractor switch to place the mirror in its retracted position and then push the switch again to return the mirror to its original position.
- When freezing has occurred and mirrors fail to operate as intended, please refrain from repeated pushing of the retractor switch as this action can result in burn-out of the mirror motor circuits.

### **Retracting and extending the mirrors without using the mirror retractor switch**

[Vehicles with keyless entry system]

The mirrors automatically retract or extend when the doors are locked or unlocked using the remote control switches of the keyless entry system. Refer to “Keyless entry system” on page 1-04.

[Vehicles with keyless operation system]

The mirrors automatically retract or extend when the doors are locked or unlocked using the remote control switches or the keyless operation function of the keyless operation system.

Refer to “Keyless operation system: To operate using the keyless operation function, Keyless entry system” on pages 1-09 and 1-24.

## Starting and driving

### NOTE

- Functions can be modified as stated below. Consult a MITSUBISHI MOTORS Authorized Service Point.  
On vehicles equipped with MITSUBISHI Multi-Communication System (MMCS), screen operations can be used to make the adjustment. Refer to the separate owner's manual for details.
  - Automatically extend when the ignition switch is turned to the "ON" position, and automatically retract when the driver's door is opened after the ignition switch is turned to the "OFF" position.
  - Automatically extend when the vehicle speed reaches 30 km/h (19 mph).
  - Deactivate the automatic extension function.

The heater will be turned off automatically in about 20 minutes.

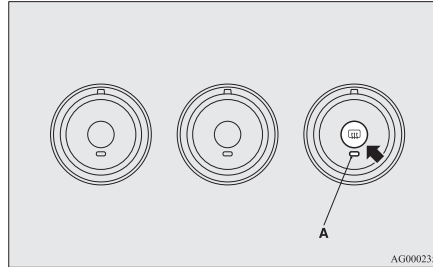

## 4 Heated mirror

E00601200282

To demist or defrost the outside rear-view mirrors, press the rear window demister switch. The indication lamp (A) will illuminate while the demister is on.

## Ignition switch

E00601401630

**[For vehicles equipped with keyless operation system]**

For information on operations for vehicles equipped with the keyless operation system, refer to "Keyless operation system: Ignition switch" on pages 1-12 and 1-19.

**[Except for vehicles equipped with keyless operation system]**

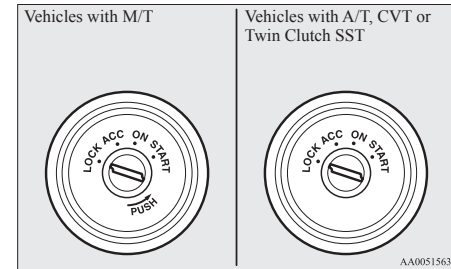

### LOCK

The engine is stopped and the steering wheel locked. The key can only be inserted and removed in this position.

### ACC

The engine is stopped, but the audio system and other electric devices can be operated.

### ON

The engine is running, and all the vehicle's electrical devices can be operated.

**START**

The starter motor operates. After the engine has started, release the key and it will automatically return to the “ON” position.

**NOTE**

- Your vehicle is equipped with an electronic immobilizer.

To start the engine, the ID code transmitted by the transponder inside the key must match the code registered in the immobilizer computer.

Refer to “Electronic immobilizer (Anti-theft starting system)” on page 1-03.

**ACC power auto-cutout function**

E00620300107

After about 30 minutes has elapsed with the ignition switch in the “ACC” position, the function automatically cuts out the power for the audio system and other electric devices that can be operated with that position.

When the ignition switch is turned from the “ACC” position, the power is supplied again to those devices.

**NOTE**

- It is possible to modify functions as follows:
  - The time until the power cuts out can be changed to approximately 60 minutes.

- The ACC power auto-cutout function can be deactivated.

For details, we recommend you to consult a MITSUBISHI MOTORS Authorized Service Point.

On vehicles equipped with MITSUBISHI Multi-Communication System (MMCS), screen operations can be used to make the adjustment.

Refer to the separate owner’s manual for details.

**To remove the key**

E00620400270

For vehicles equipped with a M/T, when removing the key, push the key in at the “ACC” position and keep it depressed until it is turned to the “LOCK” position and remove it.

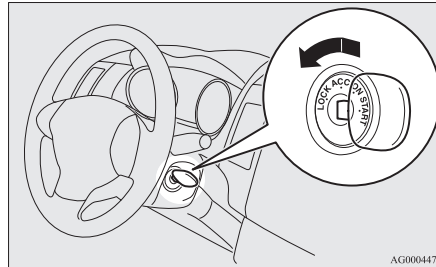

For vehicles equipped with an A/T, CVT or Twin Clutch SST, when removing the key, first set the selector lever (A/T or CVT) or gearshift lever (Twin Clutch SST) to the “P” (PARK) position, and then turn the key to the “LOCK” position, and remove it.

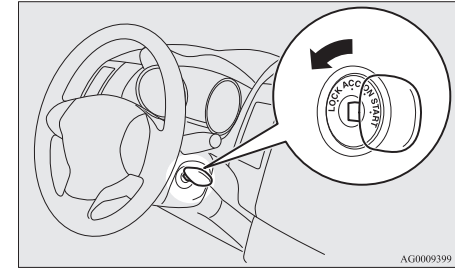
**⚠ CAUTION**

- Do not remove the ignition key from the ignition switch while driving. The steering wheel will be locked, causing loss of control.
- If the engine is stopped while driving, the brake servomechanism will cease to function and braking efficiency will deteriorate. Also, the power steering system will not function and it will require greater manual effort to operate the steering.
- Do not leave the key in the “ON” position for a long time when the engine is not running, doing so will cause the battery to be discharged.

## **⚠ CAUTION**

- Do not turn the key to the “START” position while the engine is running. Doing so could damage the starter motor.

## *Steering wheel lock*

E00601500429

[For vehicles equipped with keyless operation system]

For information on operations for vehicles equipped with the keyless operation system, refer to “Keyless operation system: Steering wheel lock” on pages 1-16, 1-20.

[Except for vehicles equipped with keyless operation system]

### **To lock**

Remove the key at the “LOCK” position. Turn the steering wheel until it is locked.

### **To unlock**

Turn the key to the “ACC” position while moving the steering wheel slightly right and left.

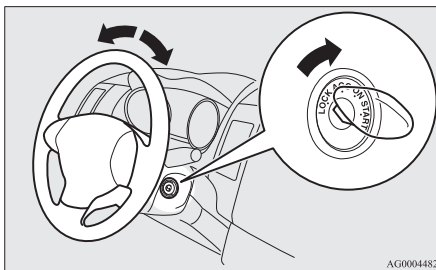

## **⚠ CAUTION**

- Remove the key when leaving the vehicle. In some countries, it is prohibited to leave the key in the vehicle when parked.

## *Starting and stopping the engine*

E00620600256

### **Tips for starting**

- Do not operate the starter motor continuously longer than 10 seconds; doing so could run down the battery. If the engine does not start, turn the ignition switch back to “LOCK”, wait a few seconds, and then try again. Trying repeatedly with the starter motor still turning will damage the starter mechanism.
- [For vehicles equipped with Twin Clutch SST] The following may occur after the engine is started, but they do not indicate an abnormality.
  - You may hear operational sounds of the Twin Clutch SST and you may feel vibration in the vehicle body.
  - If you shift the gearshift lever into the “N” (NEUTRAL) position and depress the accelerator pedal, increases in the engine speed will be limited.
- [Diesel-powered vehicles with M/T] While the vehicle is stationary with the clutch pedal fully depressed, the engine revolutions do not rise to over 3,000 rpm in order to protect the engine even if the accelerator pedal is depressed.

## **⚠ WARNING**

- Never run the engine in a closed or poorly ventilated area any longer than is needed to move your vehicle in or out of the area. Carbon monoxide gases are odourless and can be fatal.



## **CAUTION**

- Never attempt to start the engine by pushing or pulling the vehicle.
- Do not run the engine at high rpm or drive the vehicle at high speed until the engine has had a chance to warm up.

### NOTE

- For Clear Tec FFV models, if the fuel tank is filled with Bio ethanol E 85 and the ambient temperature is approximately -15 °C or lower, the engine may be difficult to start. If this occurs, add unleaded petrol 95 RON or higher to the fuel tank to increase the percentage of petrol.

## **CAUTION**

- Release the ignition key as soon as the engine starts to avoid damaging the starter motor.
- If your vehicle is equipped with a turbocharger, do not stop the engine immediately after high-speed or uphill driving. First allow the engine to idle to give the turbocharger a chance to cool down.

### Starting the engine (petrol-powered vehicles)

E00620700273

#### [For vehicles equipped with keyless operation system]

For information on operations for vehicles equipped with the keyless operation system, refer to “Keyless operation system: Starting” on pages 1-16 and 1-20.

#### [Except for vehicles equipped with keyless operation system]

The starting procedure is as follows:

1. Insert the ignition key and fasten the seat belt.
2. Make sure the parking brake is applied.
3. Depress and hold the brake pedal.
4. Fully depress the clutch pedal (M/T).
5. On vehicles equipped with M/T, place the gearshift lever in the “N” (Neutral) position. On vehicles equipped with A/T or CVT, make sure the selector lever is in the “P” (PARK) position.

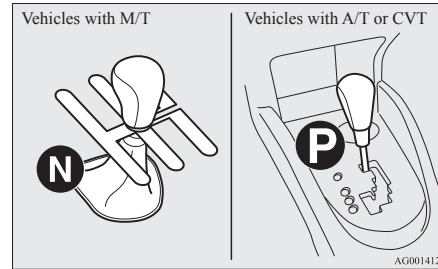

### NOTE

- On vehicles equipped with A/T or CVT, the starter will not operate unless the selector lever is in the “P” (PARK) or “N” (NEUTRAL) position. For safety reasons, start the engine in the “P” (PARK) position so that the wheels are locked.
6. After turning the ignition key to the “ON” position, make certain that all warning lamps are functioning properly before starting the engine.

7. Turn the ignition key to the “START” position without depressing the accelerator pedal, and release it when the engine starts.

### NOTE

- Minor noises may be heard on engine start-up. These will disappear as the engine warms up.

#### *Using the MIVEC engine (3000 models)*

The MIVEC engine automatically switches its intake-valve control between a low-speed mode and a high-speed mode in accordance with driving conditions for maximum engine performance.

### NOTE

- To protect the engine, the high-speed mode may not be selected while the engine coolant temperature is low. In such a case, the engine revolutions do not rise to over 5,000 rpm even if the accelerator pedal is depressed.

### Starting the engine (diesel-powered vehicles)

E00625500120

#### [For vehicles equipped with keyless operation system]

For information on operations for vehicles equipped with the keyless operation system, refer to “Keyless operation system: Starting” on pages 1-13 and 1-18.

#### [Except for vehicles equipped with keyless operation system]

1. Insert the ignition key and fasten the seat belt.
2. Make sure the parking brake is applied.
3. Depress and hold the brake pedal.
4. Fully depress the clutch pedal (M/T).

## Starting and driving

- On vehicles equipped with M/T, place the gearshift lever in the “N” (Neutral) position. On vehicles equipped with Twin Clutch SST, make sure the gearshift lever is in the “P” (PARK) position.

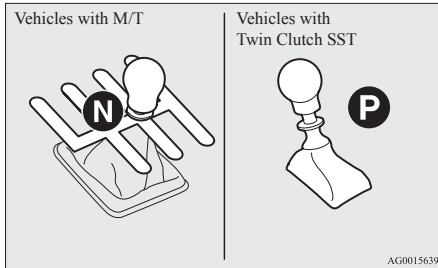

- Turn the ignition key to the “ON” position. The diesel preheat indication lamp will first illuminate, and then after a short time go out, indicating that preheating is completed.

### NOTE

- If the engine is cold, the diesel preheat indication lamp is on for a longer time.
- When the engine has not been started within about 5 seconds after the diesel preheat indication lamp went out, return the ignition key to the “LOCK” position. Then, turn the key to the “ON” position to preheat the engine again.
- When the engine is warm, the diesel preheat indication lamp does not come on even if the ignition key is placed in the “ON” position. Start the engine by turning the ignition key right to the “START” position.

- Turn the ignition key to the “START” position without depressing the accelerator pedal, and release it when the engine starts.

### NOTE

- Minor noises may be heard on engine start-up. These will disappear as the engine warms up.

### Using the MIVEC engine

The MIVEC engine automatically switches its intake-valve control between a low-speed mode and a high-speed mode in accordance with driving conditions for maximum engine performance.

### NOTE

- To protect the engine, the high-speed mode may not be selected while the engine coolant temperature is low.

## Stopping the engine

E00620800229

- Bring the vehicle to a complete stop.
- Fully engage the parking brake while depressing the brake pedal.
- For vehicles equipped with M/T, turn the ignition switch to the “LOCK” position to stop the engine, and then move the gearshift lever to the 1<sup>st</sup> (on a uphill) or “R” (Reverse) (on a downhill) position. For vehicles equipped with A/T, CVT or Twin Clutch SST, place the selector lever (A/T or CVT) or gearshift lever (Twin Clutch SST) in the “P” (PARK) position, and then turn the ignition switch to the “LOCK” position to stop the engine.

### NOTE

- For diesel-powered vehicles, if the temperature inside the engine compartment is high, the cooling fans (A) will continue to operate for some time even if the engine is stopped. Therefore, the operation sound of the cooling fans may be heard even after the engine is stopped. This sound is normal and does not indicate a malfunction. After operating for a period of time, the cooling fans will stop automatically.

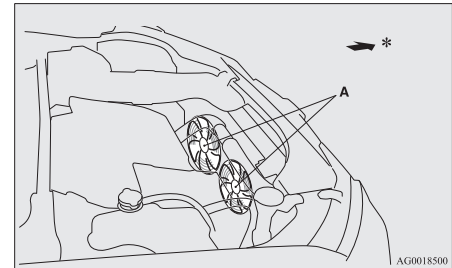

\*: Front of the vehicle

## Fuel injection amount learning process (diesel-powered vehicles)

E00627900027

To keep exhaust emissions and engine noise low, the engine very occasionally performs a learning process for the fuel injection amount. The engine sounds slightly different from usual while the learning process is taking place. The change in the engine sound does not indicate a fault.

### Diesel particulate filter (DPF)\*

E00619800216

The diesel particulate filter (DPF) is a device that captures most of the particulate matter (PM) in the exhaust emissions of the diesel engine. The DPF automatically burns away trapped PM during vehicle operation. Under certain driving conditions, however, the DPF is not able to burn away all of the trapped PM and, as a result, an excessive amount of PM accumulates inside it.

#### **⚠ WARNING**

- The DPF reaches very high temperatures. Do not park your vehicle in areas where combustible materials such as dry grass or leaves can come in contact with a hot exhaust system since a fire could occur.

#### **⚠ CAUTION**

- Do not use any type of fuel or engine oil that is not specified for your vehicle. Also, do not use any moisture-removing agent or other fuel additive. Such substances could have a detrimental effect on the DPF. Refer to “Fuel selection” on page 02 and “Engine oil” on page 8-04.

#### NOTE

- To minimize the likelihood of excessive accumulation of PM, try to avoid driving for long periods at low speeds and repeatedly driving short distances.

- [Diesel-powered vehicles with M/T]  
The engine sounds slightly different than usual while the DPF automatically burns away trapped PM. The change in the engine sound does not indicate a fault.

### DPF warning display

Type 1



Type 2



The DPF warning display illuminates in the event of an abnormality in the DPF system.

### If the DPF warning display illuminates during vehicle operation

Steady illumination of the DPF warning display shows that the DPF has not been able to burn away all of the trapped PM and that, as a result, an excessive amount of PM has accumulated inside it. To enable the DPF to burn away the PM, try to drive the vehicle as follows:

- [Diesel-powered vehicles with Twin Clutch SST]  
Drive at a speed of over 60 km/h (37 mph) until the warning display goes out.

- [Diesel-powered vehicles with M/T]  
With the bar graph of engine coolant temperature display stabilized in roughly the middle of the scale, drive for about 20 minutes at a speed of at least 40 km/h (25 mph).

If the DPF warning display subsequently stays on, contact a MITSUBISHI MOTORS Authorized Service Point.

#### **⚠ CAUTION**

- You do not have to continuously drive exactly as indicated above. Always strive to drive safely in accordance with road conditions.

## Starting and driving

### If the DPF warning display and check engine warning lamp illuminate at the same time during vehicle operation

Warning lamp



Warning display type 1



Warning display type 2



If an abnormal condition occurs in the DPF system, the DPF warning display and check engine warning lamp illuminate. Have the system inspected at a MITSUBISHI MOTORS Authorized Service Point.

### **CAUTION**

- Continuing to drive with the DPF warning display and check engine warning lamp illuminating could result in engine trouble and DPF damage.

### *Turbocharger operation\**

E00611200083

### **CAUTION**

- Do not run the engine at high speeds (for example, by revving it or by accelerating rapidly) immediately after starting it.
- Do not stop the engine immediately after high-speed or uphill driving. First allow the engine to idle to give the turbocharger a chance to cool down.

### **Turbocharger**

The turbocharger increases engine power by pushing large amounts of air into the engine's cylinders. The finned parts inside the turbocharger turn at extremely high speeds and are subjected to extremely high temperatures. They are lubricated and cooled by engine oil. If the engine oil is not replaced at the specified intervals, the bearings may seize or emit abnormal noise.

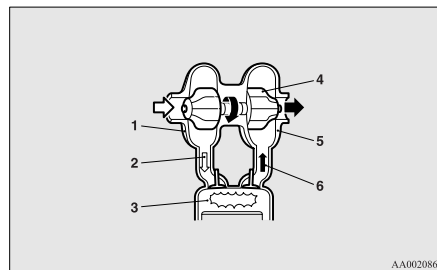

- 1- Air compressor
- 2- Compressed air
- 3- Cylinder
- 4- Turbo fin
- 5- Turbine
- 6- Exhaust gas

## Auto Stop & Go (AS&G) system\*

E00627400064

The Auto Stop & Go (AS&G) system automatically stops and restarts the engine without operating the ignition switch when the vehicle is stopped, such as at a traffic light or in a traffic jam, to reduce exhaust gases, increase fuel efficiency.

### **CAUTION**

- If the vehicle will be stopped for a long time or if you will leave the vehicle unattended, turn the ignition switch to the "LOCK" position to stop the engine.

### Automatically stopping the engine

E00627500065

The Auto Stop & Go (AS&G) system is automatically activated when the ignition switch is turned to the "ON" position.

You can deactivate the system by pressing the "Auto Stop & Go (AS&G) OFF" switch. Refer to "To deactivate" on page 4-21.

1. Stop the vehicle.

While depressing the brake pedal, fully depress the clutch pedal and place the gearshift lever in the "N" (Neutral) position.

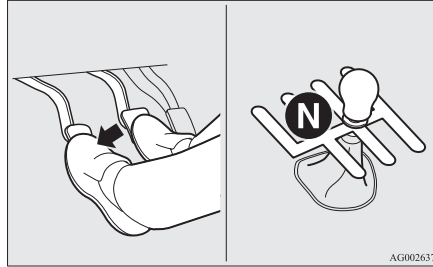

2. Release the clutch pedal. The "AS&G" display/indicator will turn on and the engine will stop automatically.

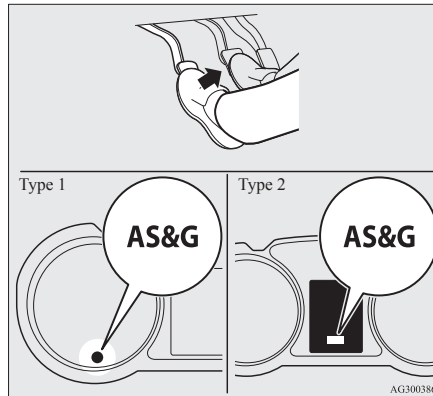

### NOTE

- The brake booster becomes inoperative and the pedal effort will increase when the engine is stopped automatically. If the vehicle is moving, press down the brake pedal harder than usual.

### **CAUTION**

- Observe the following precautions when the engine is stopped automatically. Otherwise, an unexpected accident might occur when the engine restarts automatically.
  - Do not depress the accelerator pedal to race the engine while the vehicle is stopped (regardless of whether the engine is running or stopped). Otherwise, an unexpected accident might occur when the engine restarts automatically.

**⚠ CAUTION**

- Do not leave the driver's seat or open the bonnet.

If the driver's seat belt is unfastened or if the bonnet is opened, the "AS&G" display/indicator will blink to notify the driver. If this occurs, the engine will not restart automatically even if the clutch pedal is depressed, the seat belt is refastened, and the bonnet is closed. While depressing the brake pedal, fully depress the clutch pedal and turn the ignition switch to the "START" position to start the engine. For details, refer to "Keyless operation system: Starting" on pages 1-16, 1-20 or "Starting and stopping the engine" on page 4-14.

- Do not move the gearshift lever to a position other than the "N" (Neutral) position.

If the gearshift lever is moved to a position other than the "N" (Neutral) position, the "AS&G" display/indicator blinks and the buzzer sounds.

If the gearshift lever is returned to the "N" (Neutral) position, the display/indicator stops blinking and the buzzer stops sounding. The engine will not restart if the gearshift lever is in a position other than the "N" (Neutral) position.

NOTE

- In the following cases, the Auto Stop & Go (AS&G) system will not operate and the en-

gine will not stop automatically even if the vehicle is stopped.

- Driver's seat belt is not fastened
- Bonnet is open
- After the engine restarts automatically, the vehicle speed has not exceeded approximately 5 km/h (3 mph)
- Brake booster vacuum pressure is low because the brake pedal is depressed repeatedly or depressed harder than usual
- After the ignition switch is turned from the "ON" position to the "START" position, approximately 30 seconds or more have not elapsed.
- After the engine restarts automatically and the vehicle stops again within 10 seconds.
- Engine coolant temperature is low
- Ambient temperature is lower than approximately 3 °C
- Air conditioning is operating and passenger compartment has not sufficiently cooled
- Mode selection dial is set to the demister position.  
Refer to "Demisting of the windscreen and door windows: For quick demisting" on pages 5-07, 5-07.
- When the air conditioning is operated in AUTO mode where the temperature control dial is set to the max. hot or the max. cool position
  - Electric power consumption is high, such as when the rear window demister or other electrical components are operating or the blower speed is set to a high setting.
  - Battery voltage or battery performance is low

- Check engine warning lamp is illuminated or the "AS&G" display/indicator is blinking
- If the Auto Stop & Go (AS&G) system operates while the air conditioning is operating, both the engine and the air conditioning compressor will stop. Therefore, only the blower will operate.
- If the demisting function and the Auto Stop & Go (AS&G) system are needed at the same time, it is recommended to set the mode selection dial to the Foot/demister position.  
Refer to "Changing the mode selection" on page 5-03.
- If the air conditioning is operating, set the temperature control dial higher to lengthen the time that the engine is stopped automatically.

## Automatically restarting the engine

E00627600079

Depress the clutch pedal while the gearshift lever is in the “N” (Neutral) position. The “AS&G” display/indicator turns off and the engine restarts automatically.

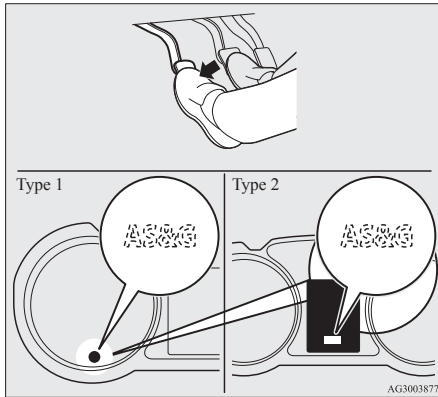

### NOTE

- If the engine does not restart automatically or if the engine stalls, the oil pressure warning lamp, charge warning lamp, and check engine warning lamp will illuminate. If this occurs, the engine will not restart even if the clutch pedal is depressed again. While depressing the brake pedal, fully depress the clutch pedal and turn the ignition switch to the “START” position to start the engine. For details, refer to “Keyless operation system: Starting” on pages 1-16, 1-20 or “Starting and stopping the engine” on page 4-14.

## CAUTION

- In the following cases, the engine will restart automatically even if the engine was stopped by the Auto Stop & Go (AS&G) system. Pay attention, otherwise an unexpected accident might occur when the engine restarts.
  - Vehicle speed is 3 km/h (2 mph) or higher when coasting down a slope
  - Brake booster vacuum pressure is low because the brake pedal is depressed repeatedly or depressed harder than usual
  - Engine coolant temperature is low
  - When the air conditioning is operated by pressing the air conditioning switch.
  - When the preset temperature of the air conditioning is changed significantly.
  - When the air conditioning is operated in AUTO mode where the temperature control dial is set to the max. hot or the max. cool position
  - When the air conditioning is ON, the passenger compartment temperature rises and the air conditioning compressor operates to lower the temperature.
  - Mode selection dial is set to the demister position. Refer to “For quick demisting” on page 5-07.
  - Electric power consumption is high, such as when the rear window demister or other electrical components are operating or the blower speed is set to a high setting.

### NOTE

- If the “Auto Stop & Go (AS&G) OFF” switch is pressed to deactivate the Auto Stop & Go (AS&G) system while the engine is stopped automatically, the engine will not restart automatically even if the clutch pedal is depressed.
- When the engine restarts automatically, the audio volume may temporarily decrease. This does not indicate a malfunction.
- While the engine is stopped automatically, the air conditioning may temporarily change the air volume. This does not indicate a malfunction.

### To deactivate

E00627700067

The Auto Stop & Go (AS&G) system is automatically activated when the ignition switch is turned to the “ON” position. You can deactivate the system by pressing the “Auto Stop & Go (AS&G) OFF” switch.

When the Auto Stop & Go (AS&G) system is deactivated, the “AS&G OFF” display/indicator will turn on.

## Starting and driving

To reactivate the Auto Stop & Go (AS&G) system, press the “Auto Stop & Go (AS&G) OFF” switch; the display/indicator will turn off.

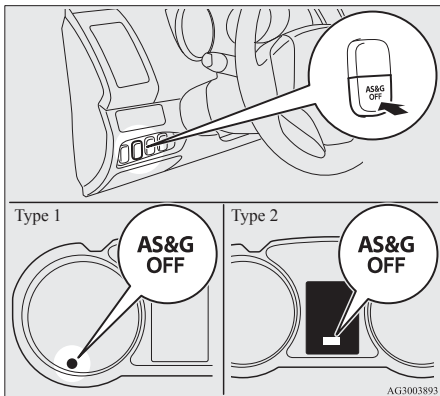

4

### NOTE

- This display/indicator will also turn on for a few seconds when the ignition switch is turned to the “ON” position.

### If the AS&G OFF display/indicator blinks while driving

E00627800068

If the AS&G OFF display/indicator blinks, the Auto Stop & Go (AS&G) system is malfunctioning and will not operate.

We recommend you to consult a MITSUBISHI MOTORS Authorized Service Point.

## Manual transmission\*

E00602000317

The shift pattern is shown on the gearshift lever knob. Be sure to always fully depress the clutch pedal before attempting to shift the lever.

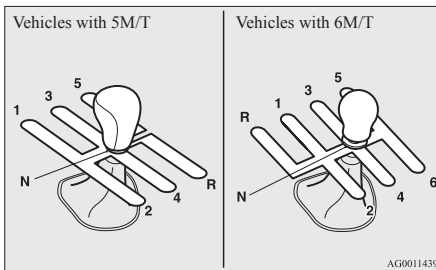

### CAUTION

- Do not put the gearshift lever into the reverse position while the vehicle is moving forward. Doing so could damage the transmission.
- Do not rest your foot on the clutch pedal while driving. Doing so could cause rapid wear to the clutch.

### NOTE

- If it is hard to shift into 1<sup>st</sup>, depress the clutch pedal again; the shift will then be easier to make.

## Moving the gearshift lever to the “R” (Reverse) position

E00615400054

### CAUTION

- Do not move the gearshift lever to the “R” (Reverse) position while the vehicle is moving forward; doing so will damage the transmission.

### Vehicles equipped with 5M/T

To shift into the “R” (Reverse) position from 5<sup>th</sup> gear, move the gearshift lever to the “N” (Neutral) position, and then move it to the “R” (Reverse) position.

### Vehicles equipped with 6M/T

Pull up the pull-ring (A), then move the gearshift lever to the “R” (Reverse) position with the pull-ring still pulled.

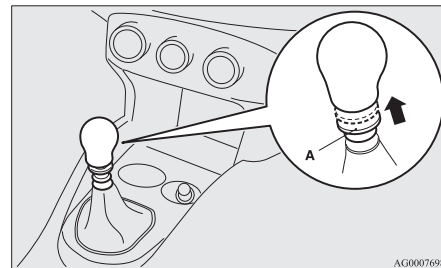



## **▲ CAUTION**

- Do not pull up the pull-ring (A) when moving the gearshift lever to any position other than the “R” (Reverse) position. If you always pulled up the pull-ring (A) when moving the gearshift lever, you could unintentionally move the gearshift lever to the “R” (Reverse) position and cause an accident and/or a transmission fault.

The pull-ring will return to its original position when you return the gearshift lever to the “N” (Neutral) position.

## **▲ CAUTION**

- If the pull-ring will not return from the pulled-up position, we recommend you to have the vehicle inspected.

### Changing gears while the vehicle is moving

E00610600266

Always take care to change the gear with the vehicle speed matched to the engine speed. Proper shifting will improve fuel economy and prolong engine life.

Avoid shifting down at high speed, as this may cause excessive engine speed (the tachometer needle into the red zone) and damage the engine.

### NOTE

- Except for vehicles for Russia, Kazakhstan and Ukraine, the gearshift indicator shows recommended gearshift points for fuel-efficient driving. It shows a “▲” when an upshift is recommended.

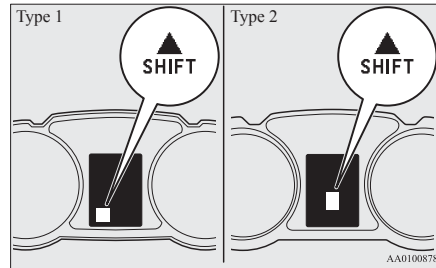

## Starting and driving

### Possible driving speed

E00610801337

Avoid shifting down at high speed, as this may cause excessive engine speed (the tachometer needle into the red zone) and damage the engine.

#### *Petrol-powered vehicles*

Shift point	Speed limit
1 <sup>st</sup> gear	50 km/h (30 mph)
2 <sup>nd</sup> gear	90 km/h (56 mph)
3 <sup>rd</sup> gear	135 km/h (84 mph)
4 <sup>th</sup> gear	175 km/h (109 mph)

Use 5<sup>th</sup> gear whenever vehicle speed allows, for maximum fuel economy.

#### *Diesel-powered vehicles*

Shift point	Speed limit
1 <sup>st</sup> gear	30 km/h (19 mph)
2 <sup>nd</sup> gear	65 km/h (40 mph)
3 <sup>rd</sup> gear	105 km/h (65 mph)
4 <sup>th</sup> gear	140 km/h (87 mph)
5 <sup>th</sup> gear	180 km/h (112 mph)

Use 6<sup>th</sup> gear whenever vehicle speed allows, for maximum fuel economy.

## Automatic transmission INVECS-II Sports Mode 6A/T (Intelligent & Innovative Vehicle Electronic Control System II)\*

E00603200345

Designed for optimum control and equipped with adaptive control capabilities, the electronically controlled transmission optimally matches gear shifts to almost all driving and road conditions.

### CAUTION

- This system is strictly intended to provide supplementary functions. When traveling downhill under certain conditions or immediately after starting off when the automatic transmission is cold, no automatic shiftdown may be made. The driver should shiftdown to a lower gear to use engine braking. Try to drive safely at all time.

### NOTE

- During running-in period or immediately after reconnection of the battery cable, there may be a case where gear shifts are not made smoothly. This does not indicate a faulty transmission. Gear shifts will become smooth after the transmission has been shifted several times by the electronic control system.

### Selector lever operation

E00603300883

The transmission has 6 forward gears and 1 reverse gear.

The individual gears are selected automatically, depending on the speed of the vehicle and the position of the accelerator pedal.

The selector lever (A) has 2 gates; the main gate (B) and the manual gate (C).

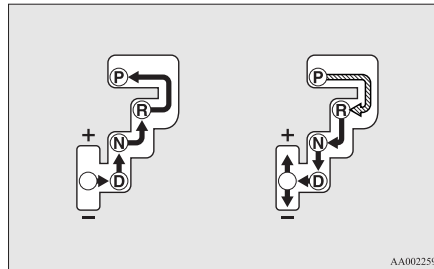
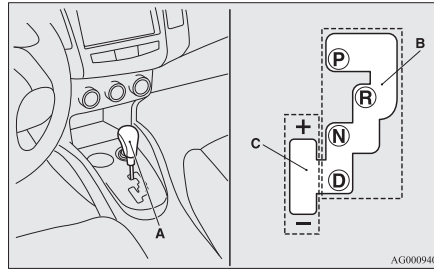

	While depressing the brake pedal, move the selector lever through the gate.
	Move the selector lever through the gate.

### WARNING

- Always depress the brake pedal when shifting the selector lever into a gear from the “P” (PARK) or “N” (NEUTRAL) position.  
Never put your foot on the accelerator pedal while shifting the selector lever from the “P” (PARK) or “N” (NEUTRAL) position.

### NOTE

- To avoid erroneous operation, move the selector lever firmly into each position and briefly hold it there. Always check the position shown by the selector lever position display after moving the selector lever.
- If the brake pedal is not depressed and held, the shift-lock device activates to prevent the selector lever from being moved from the “P” (PARK) position.

### When the selector lever cannot be shifted from the “P” (PARK) position

E00629100049

When the selector lever cannot be shifted from the “P” (PARK) position to another position while the brake pedal is pressed and held down with the ignition switch at the “ON” position, the battery may be flat or the shift-lock mechanism may be malfunctioning. Immediately have your vehicle checked by a MITSUBISHI MOTORS Authorized Service Point.

If you need to move the vehicle, shift the selector lever as follows.

1. Make sure the parking brake is fully applied.
2. Stop the engine if it is running.

## Starting and driving

3. Insert a straight blade (or minus) screwdriver with a cloth over its tip into notch (A) or the cover. Pry gently as shown to remove the cover.

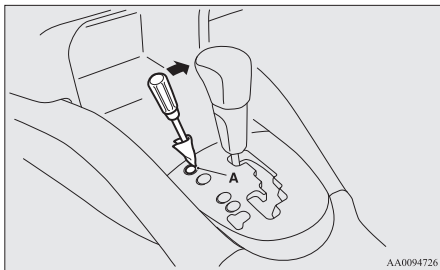

4. Depress the brake pedal with the right foot.
5. Turn the ignition switch to the “ACC” position.

### NOTE

- For vehicles with the keyless operation system, turn the ignition switch to the “ACC” position with the emergency key if the vehicle battery is flat.

6. Insert a straight blade (or minus) screwdriver in the shiftlock release hole (B). Shift the selector lever to the “N” (NEUTRAL) position while pressing the straight blade (or minus) screwdriver down.

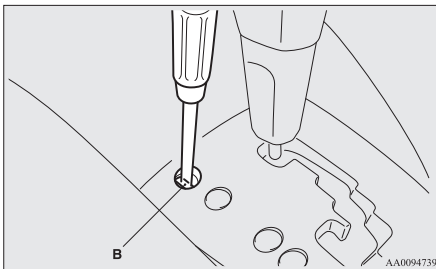

### Selector lever position display

E00603500856

When the ignition switch is turned to the “ON” position, the position of the selector lever is indicated in the multi-information display.

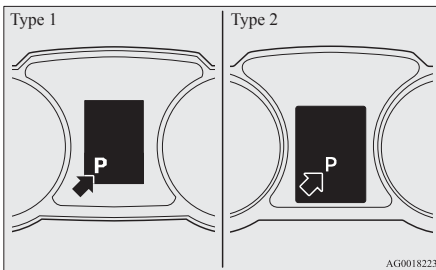

## Selector lever positions (Main gate)

E00603800569

### “P” PARK

This position locks the transmission to prevent the vehicle from moving. The engine can be started in this position.

### “R” REVERSE

This position is to back up.

## **⚠ CAUTION**

- Never shift into the “P” (PARK) or “R” (REVERSE) position while the vehicle is in motion to avoid a transmission damage.

### “N” NEUTRAL

At this position the transmission is disengaged. It is the same as the neutral position on a manual transmission, and should only be used when the vehicle is stationary for an extended length of time during driving, such as in a traffic jam.

## **⚠ WARNING**

- Never move the selector lever to the “N” (NEUTRAL) position while driving. A serious accident could occur since you could accidentally move the lever into the “P” (PARK) or “R” (REVERSE) position or you will lose engine braking.
- On a gradient the engine should be started in the “P” (PARK) position, not in the “N” (NEUTRAL) position.

## **⚠️ WARNING**

- Always keep your right foot on the brake pedal when shifting into or out of “N” (NEUTRAL), to minimize the risk of loss of control.

### **“D” DRIVE**

This position is for normal driving. The transmission automatically selects a suitable gear for your speed and acceleration.

Engine braking is automatically applied when necessary, depending on road conditions.

## **⚠️ CAUTION**

- Never shift into the “D” (DRIVE) position from the “R” (REVERSE) position while the vehicle is in motion to avoid transmission damage.

### **Sports mode**

E0603901075

Whether the vehicle is stationary or in motion, sports mode is selected by gently pushing the selector lever from the “D” (DRIVE) position into the manual gate (A). To return to “D” range operation, gently push the selector lever back into the main gate (B).

In sports mode, gear shifts can be made rapidly simply by moving the selector lever backwards and forwards. For vehicles equipped with shift paddles, shift paddles at the steering wheel can also be used to perform gear shifts. In contrast to a manual transmission, the sports mode allows gear shifts with the accelerator pedal depressed.

### **NOTE**

- If your vehicle is equipped with shift paddles, you can shift into sports mode with shift paddles when the selector lever is in the main gate as well. Also, you can return to the “D” range operation in any of following ways. When returning to “D” range operation, the selector lever position display will change to “D” (DRIVE) position.
  - Pull the + (SHIFT UP) side shift paddle forward (towards the driver) for over 2 seconds.
  - Stop the vehicle.
  - Push the selector lever from the “D” (DRIVE) position into the manual gate (A) and push the selector lever back into the main gate (B).

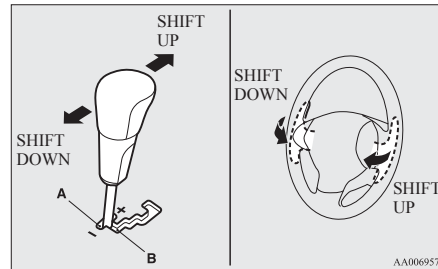

#### **+ (SHIFT UP)**

The transmission shifts up by one gear with each operation.

#### **- (SHIFT DOWN)**

The transmission shifts down by one gear with each operation.

## **⚠️ CAUTION**

- Upward shifts do not take place automatically in sports mode. The driver must execute upward shifts in accordance with prevailing road conditions, taking care to keep the engine speed below the red zone.
- Repeated continuous operation of the selector lever or the shift paddles will continuously switch shift position.
- For vehicles equipped with shift paddles, do not use the left- and right-hand shift paddles at the same time. Doing so could cause a gearshift that you do not expect.

### **NOTE**

- In sports mode, only the 6 forward gears can be selected. To reverse or park the vehicle, move the selector lever to the “R” (REVERSE) or “P” (PARK) position as required.
- To maintain good running performance, the transmission may refuse to perform an upshift when the selector lever is moved to the “+ (SHIFT UP)” position at certain vehicle speeds. Also, to prevent over-revving of the engine, the transmission may refuse to perform a downshift when the lever is moved to the “- (SHIFT DOWN)” position at certain vehicle speeds. When this happens, a buzzer sounds to indicate that a downshift is not going to take place.
- In sports mode, downward shifts are made automatically when the vehicle slows down. When the vehicle stops, 1<sup>st</sup> gear is automatically selected.

## Starting and driving

- When driving away on a slippery road, push the selector lever forward into the “+ (SHIFT UP)” position. This causes the transmission to shift into the 2<sup>nd</sup> gear which is better for smooth driving away on a slippery road. Push the selector lever to the “- (SHIFT DOWN)” side to shift back to the 1<sup>st</sup> gear.

## Sports mode display

E00612300472

In sports mode, the currently selected position is displayed on the multi-information display.

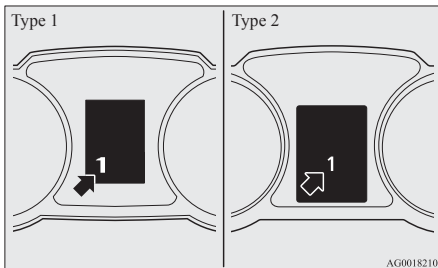

## NOTE

- While driving in sports mode, the sports mode display may change to show “D” and shifting in sports mode may no longer be possible. This indicates that controls to drive in the “D” position are operating normally in order to lower the temperature of the A/T fluid; it does not indicate a malfunction. Once the temperature of the A/T fluid drops, shifting in the sports mode will be possible again.

## When a malfunction occurs in the A/T

E00615100208

Type 1



or



Type 2



or



There could be a system malfunction if the ⚠ warning display or the ⚠ warning display is displayed on the information screen in the multi-information display.

## ⚠ CAUTION

- If malfunction occurs in the A/T while driving, the ⚠ warning display or the ⚠ warning display appears on the information screen in the multi-information display. In this case, immediately park your vehicle in a safe place and follow these procedures:

When ⚠ warning display is showing

The automatic transmission fluid is overheating.

Stop your vehicle in a safe place, put the selector lever in the “P” (PARK) position, and open the bonnet with the engine running to allow the engine to cool down.

After a while, confirm that the ⚠ warning display is no longer showing. It is safe to continue driving if the display is no longer showing. If the warning display remains or appears frequently, we recommend you to have your vehicle inspected.

When ⚠ warning display is showing

It may be that there is something unusual happening in the A/T, causing a safety device to activate. We recommend you to have your vehicle inspected as soon as possible.

## Operation of the A/T

E00604200586

**⚠ CAUTION**

- Before selecting a gear with the engine running and the vehicle stationary, fully depress the brake pedal to prevent the vehicle from creeping. The vehicle will begin to move as soon as the gear is engaged, especially when the engine speed is high, at fast idle or with the air conditioning operating, the brakes should only be released when you are ready to drive away.
- Depress the brake pedal with the right foot at all times. Using the left foot could cause driver movement delay in case of an emergency.
- To prevent sudden acceleration, never race the engine when shifting from the “P” (PARK) or “N” (NEUTRAL) position.
- Operating the accelerator pedal while the other foot is resting on the brake pedal will affect braking efficiency and may cause premature wear of brake pads.
- Use the selector lever in the correct shift position in accordance with driving conditions. Never coast downhill backward with the selector lever in the “D” (DRIVE) or sports mode position or coast forward with the selector lever in the “R” (REVERSE) position. The engine may stop and the unexpected increase in brake pedal effort and steering wheel weight could lead to an accident.

**⚠ CAUTION**

- Do not race the engine with brake pedal pressed when the vehicle is stationary. This can damage the A/T. Also, when you depress the accelerator pedal while holding down the brake pedal with the selector lever in the “D” (DRIVE) position, the engine revolutions may not rise as high as when performing the same operation with the selector lever in the “N” (NEUTRAL) position.

*Passing acceleration*

E00604500185

To gain extra acceleration in “D” (DRIVE) position, push the accelerator to the floor. The A/T will automatically downshift.

## NOTE

- In sports mode, downshifts do not take place when the accelerator is depressed all the way to the floor.

*Uphill/downhill driving*

E00610500106

**DRIVING UPHILL**

The transmission may not upshift to a higher gear if the computer determines the current speed cannot be maintained once a higher gear is engaged. For smoother vehicle performance, if you release the throttle while climbing a steep grade, the transmission may not upshift.

This is normal, as the computer is temporarily preventing shifting. After reaching the top of the hill, normal gear shift function will resume.

**DRIVING DOWNHILL**

When travelling down steep grades, the computer may automatically select a lower gear. This function assists engine braking efforts, reducing the need for using the service brakes.

*Waiting*

E00604600258

For short waiting periods, such as at traffic signals, the vehicle can be left in gear and held stationary with the service brake.

For longer waiting periods with the engine running, place the selector lever in the “N” (NEUTRAL) position and apply the parking brake, while holding the vehicle stationary with the service brake.

**⚠ CAUTION**

- Never hold the vehicle stationary while in gear on a hill with the accelerator, always apply the parking brake and/or service brake.

4

*Parking*

E00604700187

To park the vehicle, first bring it to a complete stop, fully engage the parking brake, and then move the selector lever to the “P” (PARK) position. If you are going to leave the vehicle unattended, always switch off the engine and carry the key.

## Starting and driving

### NOTE

- On a slope, be sure to apply the parking brake before moving the selector lever to the “P” (PARK) position. If you move the selector lever to the “P” (PARK) position before applying the parking brake, it may be difficult to disengage the selector lever from the “P” (PARK) position when next you drive the vehicle, requiring application of a strong force to the selector lever to move from the “P” (PARK) position.

### When the A/T makes no speed change

E00604800654

If the transmission does not change speeds while driving, or your vehicle does not pick up enough speed when starting on an uphill slope, it may be that there is something unusual happening in the transmission, causing a safety device to activate. We recommend you to have your vehicle checked as soon as possible.

4

## Automatic transmission INVECS-III Sports Mode 6CVT (Intelligent & Innovative Vehicle Electronic Control System III)\*

E00602100031

The INVECS-III uses optimization and adaptation functions to optimally match the gear ratio to driving and road conditions.

The CVT is capable of changing the gear ratio automatically and steplessly to suit driving conditions in all phases of vehicle operation. It therefore realizes smooth, shock-free operation and excellent fuel efficiency.

### ⚠ CAUTION

- Automatic downshifts may not take place while the CVT fluid is still cool immediately after you start driving. To cause a downshift, depress the brake pedal, manually shift down when necessary. Always strive to drive safely in accordance with road conditions.

### Selector lever operation

E00602200175

The CVT selects an optimum gear ratio automatically, depending on the speed of the vehicle and the position of the accelerator pedal.

The selector lever (A) has 2 gates; the main gate (B) and the manual gate (C).

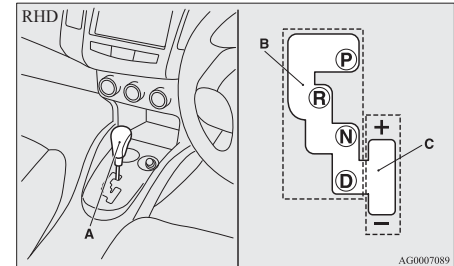
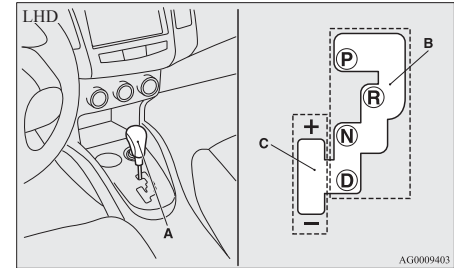



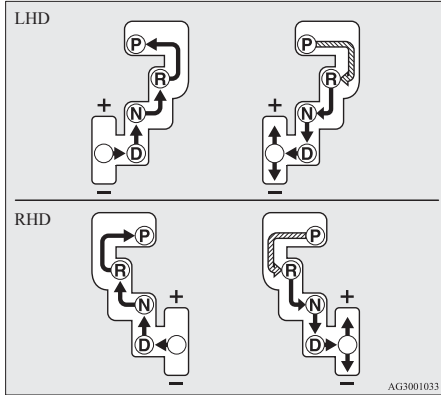

**NOTE**

- To avoid erroneous operation, move the selector lever firmly into each position and briefly hold it there. Always check the position shown by the selector lever position display after moving the selector lever.
- If the brake pedal is not depressed and held, the shift-lock device activates to prevent the selector lever from being moved from the “P” (PARK) position.

**When the selector lever cannot be shifted from the “P” (PARK) position**

E00629000064

When the selector lever cannot be shifted from the “P” (PARK) position to another position while the brake pedal is pressed and held down with the ignition switch at the “ON” position, the battery may be flat or the shift-lock mechanism may be malfunctioning. Immediately have your vehicle checked by a MITSUBISHI MOTORS Authorized Service Point.

If you need to move the vehicle, shift the selector lever as follows.

**For LHD vehicles**

1. Make sure the parking brake is applied.
2. Stop the engine if it is running.

3. Insert a straight blade (or minus) screwdriver with a cloth over its tip into notch (A) or the cover. Pry gently as shown to remove the cover.

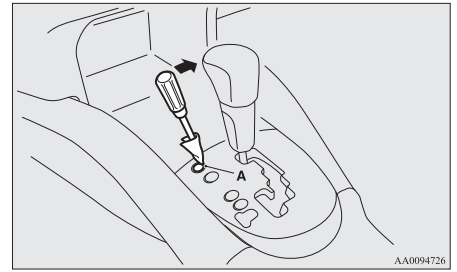

4. Depress the brake pedal with the right foot.
5. Turn the ignition switch to the “ACC” position.

**NOTE**

- For vehicles with the keyless operation system, turn the ignition switch to the “ACC” position with the emergency key if the vehicle battery is flat.

	While depressing the brake pedal, move the selector lever through the gate.
	Move the selector lever through the gate.

**⚠ WARNING**

- Always depress the brake pedal when shifting the selector lever into the other position from the “P” (PARK) or “N” (NEUTRAL) position.  
Never put your foot on the accelerator pedal while shifting the selector lever from the “P” (PARK) or “N” (NEUTRAL) position.

## Starting and driving

6. Insert a straight blade (or minus) screwdriver in the shiftlock release hole (B). Shift the selector lever to the “N” (NEUTRAL) position while pressing the straight blade (or minus) screwdriver down.

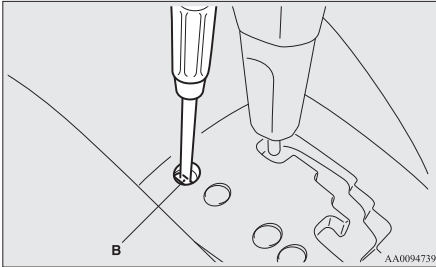

5. Shift the selector lever to the “N” (NEUTRAL) position while pressing the shift-lock release button (A).

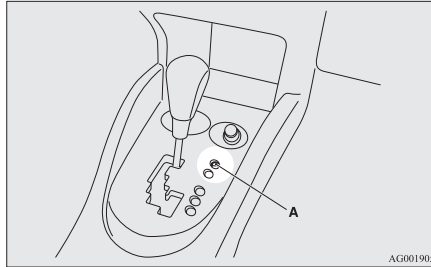

## Selector lever position display

E00602300352

When the ignition switch is turned to the “ON” position, the position of the selector lever is indicated in the multi-information display.

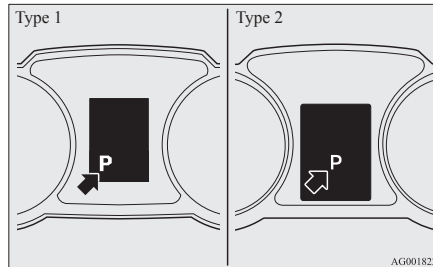

## Selector lever positions (Main gate)

E00602400210

### “P” PARK

This position locks the transmission to prevent the vehicle from moving. The engine can be started in this position.

### “R” REVERSE

This position is to back up.

## **⚠ CAUTION**

- Never shift into the “P” (PARK) or “R” (REVERSE) position while the vehicle is in motion to avoid transmission damage.

### “N” NEUTRAL

At this position the transmission is disengaged. It is the same as the neutral position on a manual transmission, and should only be used when the vehicle is stationary for an extended length of time during driving, such as in a traffic jam.

## **⚠ WARNING**

- Never move the selector lever to the “N” (NEUTRAL) position while driving. A serious accident could occur since you could accidentally move the lever into the “P” (PARK) or “R” (REVERSE) position or you will lose engine braking.
- On a gradient the engine should be started in the “P” (PARK) position, not in the “N” (NEUTRAL) position.

4

## For RHD vehicles

1. Make sure the parking brake is applied.
2. Stop the engine if it is running.
3. Depress the brake pedal with the right foot.
4. Turn the ignition switch to the “ACC” position.

## NOTE

- For vehicles with the keyless operation system, turn the ignition switch to the “ACC” position with the emergency key if the vehicle battery is flat.

**⚠ WARNING**

- Always keep your right foot on the brake pedal when shifting into or out of “N” (NEUTRAL), to minimize the risk of loss of control.

**“D” DRIVE**

This position is for normal driving. The transmission automatically selects a suitable gear ratio for your speed and acceleration. Engine braking is automatically applied when necessary, depending on road conditions.

**⚠ CAUTION**

- Never shift into the “D” (DRIVE) position from the “R” (REVERSE) position while the vehicle is in motion to avoid transmission damage.

**Sports mode**

E00602500152

Whether the vehicle is stationary or in motion, sports mode is selected by gently pushing the selector lever from the “D” (DRIVE) position into the manual gate (A). To return to “D” range operation, gently push the selector lever back into the main gate (B).

In sports mode, gear ratio shifts can be made rapidly simply by moving the selector lever backward and forward. For vehicles equipped with shift paddles, shift paddles at the steering wheel can also be used to shift the gear ratio. In contrast to a manual transmission, the sports mode allows gear ratio shifts with the accelerator pedal depressed.

**NOTE**

- If your vehicle is equipped with shift paddles, you can shift into sports mode with shift paddles when the selector lever is in the main gate as well. Also, you can return to the “D” range operation in any of following ways. When returning to “D” range operation, the selector lever position display will change to “D” (DRIVE) position.
  - Pull the “+ (SHIFT UP)” side shift paddle forward (towards the driver) for over 2 seconds.
  - Stop the vehicle.
  - Push the selector lever from the “D” (DRIVE) position into the manual gate (A) and push the selector lever back into the main gate (B).

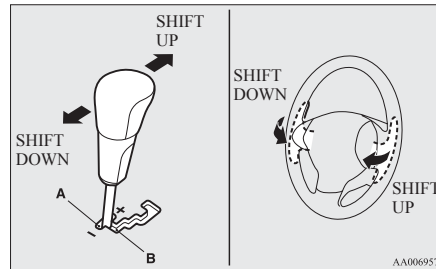
**+ (SHIFT UP)**

The transmission shifts up once by each operation.

**- (SHIFT DOWN)**

The transmission shifts down once by each operation.

**⚠ CAUTION**

- Upward shifts do not take place automatically in sports mode. The driver must execute upward shifts in accordance with prevailing road conditions, taking care to keep the engine speed below the red zone.
- Repeated continuous operation of the selector lever or the shift paddles will continuously switch shift position.
- For vehicles equipped with shift paddles, do not use the left- and right-hand shift paddles at the same time. Doing so could cause a shift of gear ratio that you do not expect.

**NOTE**

- In sports mode, only the 6 forward gear ratios can be selected. To reverse or park the vehicle, move the selector lever to the “R” (REVERSE) or “P” (PARK) position as required.
- To maintain good running performance, the transmission may refuse to perform an upshift when the selector lever is moved to the “+ (SHIFT UP)” position at certain vehicle speeds. Also, to prevent over-revving of the engine, the transmission may refuse to perform a downshift when the lever is moved to the “- (SHIFT DOWN)” position at certain vehicle speeds. When this happens, a buzzer sounds to indicate that a downshift is not going to take place.
- In sports mode, downward shifts are made automatically when the vehicle slows down. When the vehicle stops, 1<sup>st</sup> position is automatically selected.

## Starting and driving

### Sports mode display

E00612200282

In sports mode, the currently selected position is displayed on the multi-information display.

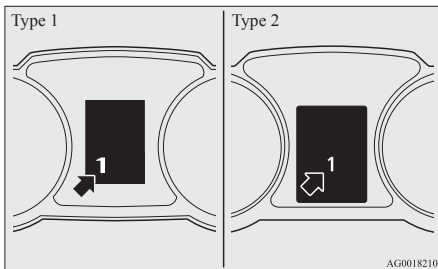

### Type 2



or



### When the warning display appears

There could be a system malfunction if the warning display or the warning display is displayed on the information screen in the multi-information display.

## 4 When a malfunction occurs in the CVT

E00602300248

### Type 1



or



## CAUTION

this case, take one of the following procedures.

- Slow down your vehicle.
- Stop your vehicle in a safe place, put the selector lever in the “P” (PARK) position, and open the bonnet with the engine running to allow the engine to cool down.

After a while, confirm that the warning display is no longer showing. It is safe to continue driving if the display is no longer showing. If the warning display remains or appears frequently, we recommend you to have your vehicle inspected.

[When warning display is showing]

It may be that there is something unusual happening in the CVT, causing a safety device to activate. We recommend you to have your vehicle inspected as soon as possible.

## CAUTION

- If malfunction occurs in the CVT while driving, the warning display or the warning display will appear on the information screen in the multi-information display.

In this case, follow these procedures:

[When warning display is showing]

The CVT fluid is overheating. The engine control may activate to lower the CVT fluid temperature, causing the engine revolutions and vehicle speed to decrease. In

## Operation of the CVT

E00602600267

### CAUTION

- Before selecting a position with the engine running and the vehicle stationary, fully depress the brake pedal to prevent the vehicle from creeping.  
The vehicle will begin to move as soon as the CVT is engaged, especially when the engine speed is high, at fast idle or with the air conditioning operating, the brakes should only be released when you are ready to drive away.
- Depress the brake pedal with the right foot at all times.  
Using the left foot could cause driver movement delay in case of an emergency.
- To prevent sudden acceleration, never race the engine when shifting from the “P” (PARK) or “N” (NEUTRAL) position.
- Operating the accelerator pedal while the other foot is resting on the brake pedal will affect braking efficiency and may cause premature wear of brake pads.
- Use the selector lever in the correct shift position in accordance with driving conditions.  
Never coast downhill backward with the selector lever in the “D” (DRIVE) or sports mode position or coast forward with the selector lever in the “R” (REVERSE) position.  
The engine may stop and the unexpected increase in brake pedal effort and steering wheel weight could lead to an accident.

### CAUTION

- Do not race the engine with brake pedal pressed when the vehicle is stationary. This can damage the CVT.  
Also, when you depress the accelerator pedal while holding down the brake pedal with the selector lever in the “D” (DRIVE) position, the engine revolutions may not rise as high as when performing the same operation with the selector lever in the “N” (NEUTRAL) position.

#### Passing acceleration

E00602700037

To gain extra acceleration in “D” (DRIVE) position, push the accelerator to the floor. The CVT will automatically downshift.

#### NOTE

- In “Sports mode”, downshifts do not take place when the accelerator is depressed all the way to the floor.

#### Uphill/downhill driving

E00603000037

#### DRIVING UPHILL

The transmission may not upshift to a higher shift position if the computer determines the current speed cannot be maintained once a higher shift position is engaged.

For smoother vehicle performance, if you release the throttle while climbing a steep grade, the transmission may not upshift. This is normal, as the computer is temporarily preventing shifting. After reaching the top of the hill, normal shift function will resume.

#### DRIVING DOWNHILL

When travelling down steep grades, the computer may automatically select a lower shift position. This function assists engine braking efforts, reducing the need for using the service brakes.

#### Waiting

E00602800067

For short waiting periods, such as at traffic signals the vehicle can be left in selector lever position and held stationary with the service brake.

For longer waiting periods with the engine running, place the selector lever in the “N” (NEUTRAL) position and apply the parking brake, while holding the vehicle stationary with the service brake.

### CAUTION

- Never hold the vehicle stationary while in CVT on a hill with the accelerator, always apply the parking brake and/or service brake.

#### Parking

E00602900039

To park the vehicle, first bring it to a complete stop, fully engage the parking brake, and then move the selector lever to the “P” (PARK) position. If you are going to leave the vehicle unattended, always switch off the engine and carry the key.

## Starting and driving

### NOTE

- On a slope, be sure to apply the parking brake before moving the selector lever to the “P” (PARK) position. If you move the selector lever to the “P” (PARK) position before applying the parking brake, it may be difficult to disengage the selector lever from the “P” (PARK) position when next you drive the vehicle, requiring application of a strong force to the selector lever to move from the “P” (PARK) position.

### When the CVT makes no speed change

E00603100139

If the transmission does not change speeds while driving, or your vehicle does not pick up enough speed when starting on an uphill slope, it may be that there is something unusual happening in the transmission, causing a safety device to activate. We recommend you to have your vehicle checked as soon as possible.

4

## Twin Clutch SST (Sport Shift Transmission)\*

E00620900057

The Twin Clutch SST is a transmission that, through integrated control of the engine and transmission, is able to achieve both the smooth shifting of an automatic transmission and the acceleration and fuel economy close to a manual transmission. In addition, the control mode can be selected from two types to suit the driving conditions. Together with manual shifting, the transmission is capable of responding to a variety of driving circumstances.

Twin Clutch SST control mode → p. 4-39

Manual shift → p. 4-40

### Gearshift lever operation

E00621000169

The Twin Clutch SST has 6 forward gears and 1 reverse gear.

The individual gears are selected automatically, depending on the position of the gearshift lever, the speed of the vehicle and the position of the accelerator pedal.

The gearshift lever (A) has 2 gates; the main shift gate (B) and the manual shift gate (C).

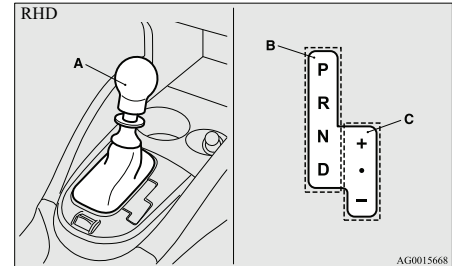
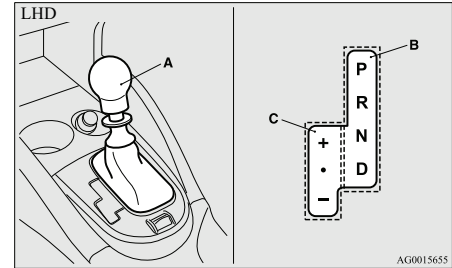

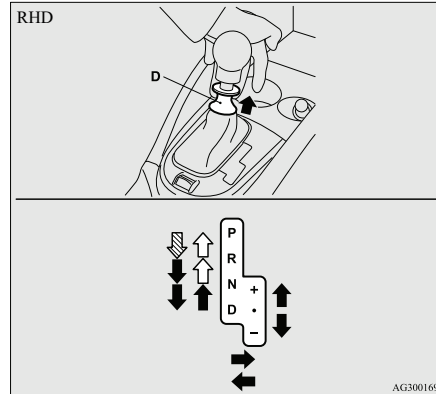
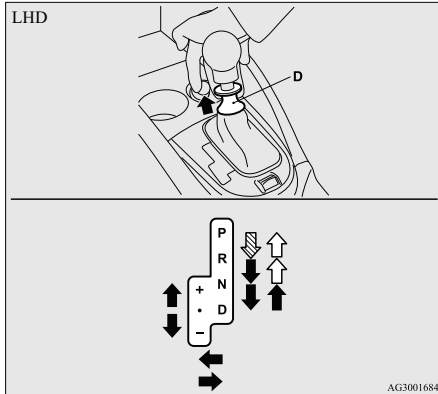

	The pull-ring (D) must be pulled up while the brake pedal is depressed to move the gearshift lever.
	The pull-ring (D) must be pulled up to move the gearshift lever.
	The pull-ring (D) need not be pulled up to move the gearshift lever.

### **WARNING**

- If the pull-ring is always pulled up to operate the gearshift lever, the lever may be accidentally shifted into the “P” (PARK) or “R” (REVERSE) position. Be sure not to pull up the pull-ring when performing the operations indicated by in the illustration.

### **WARNING**

- Always depress the brake pedal when shifting the gearshift lever into the other position from the “P” (PARK) or “N” (NEUTRAL) position.  
Never put your foot on the accelerator pedal while shifting the gearshift lever from the “P” (PARK) or “N” (NEUTRAL) position.

#### NOTE

- If the brake pedal is not depressed and held, the shift-lock device activates to prevent the gearshift lever from being moved from the “P” (PARK) position.
- Do not accelerate immediately after moving the gearshift lever. It may take some time for the transmission to shift to the selected gear.
- When the gearshift lever is operated while the Twin Clutch SST fluid temperature is low, the time required to shift to the selected gear may be longer than usual.

## Starting and driving

### Gearshift lever position display

E00621100287

When the ignition switch is turned to the “ON” position, the position of the gearshift lever is indicated in the multi-information display.

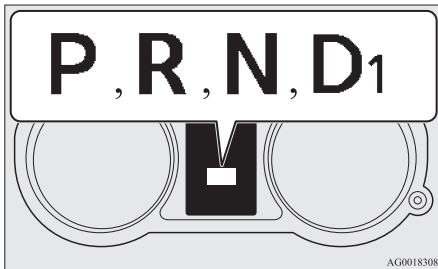

4

In addition, when the vehicle is driven with the gearshift lever in the “D” (DRIVE) position, the forward gear number is shown.

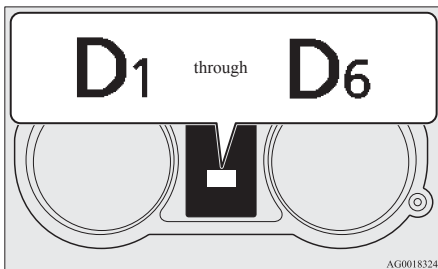

*If the gearshift lever position display **R** blinks and the buzzer beeps*

E00627100162

With the gearshift lever in the “R” (REVERSE) position, if the gearshift lever position display **R** blinks and the buzzer beeps, the transmission gears have not properly engaged. To correct this situation, the following procedure must be performed.

1. Depress the brake pedal with your right foot and place the gearshift lever in the “N” (NEUTRAL) position.
2. Again place the gearshift lever in the “R” (REVERSE) position and confirm that the gearshift lever position display has stopped blinking and that the buzzer has stopped beeping.
3. Repeat 1 and 2 above if the gearshift lever position display continues to blink and the buzzer beeps.

### **⚠ WARNING**

- To avoid unintended vehicle movement when the gearshift lever position display **R** blinks and the buzzer beeps, keep brake pedal applied with your right foot and do not depress the accelerator pedal.

*If the gearshift lever position display is not showing*

E00627200017

There may be a problem in the Twin Clutch SST. If this occurs, the safety device operates and prevents the vehicle from moving. Therefore, perform the following procedure.

1. Park your vehicle in a safe place and stop the engine.
2. Restart the engine.

If the gearshift lever position display is shown and the vehicle can move after this procedure is performed, there is no malfunction.

If the gearshift lever position display is not shown and the vehicle cannot move, or if this problem occurs repeatedly, have the vehicle checked by a MITSUBISHI MOTORS Authorized Service Point as soon as possible.

### Gearshift lever positions (Manual shift gate)

E00621200060

#### “P” PARK

This position locks the transmission to prevent the vehicle from moving. The engine can be started in this position.

#### “R” REVERSE

This position is to back up.

### **⚠ CAUTION**

- Never shift into the “P” (PARK) or “R” (REVERSE) position while the vehicle is in motion to avoid transmission damage.

#### “N” NEUTRAL

At this position the transmission is disengaged. It is the same as the neutral position on a M/T, and should only be used when the vehicle is stationary for an extended length of time during driving, such as in a traffic jam.



## **WARNING**

- Never move the gearshift lever to the “N” (NEUTRAL) position while driving. A serious accident could occur since you could accidentally move the lever into the “P” (PARK) or “R” (REVERSE) position or you will lose engine braking.
- On a gradient the engine should be started in the “P” (PARK) position. Although the engine can be started when the vehicle is in the “N” (NEUTRAL) position if the brake pedal is depressed, for safety reasons, do not start the engine in the “N” (NEUTRAL) position.
- Always keep your right foot on the brake pedal when shifting into or out of “N” (NEUTRAL), to minimize the risk of loss of control.

### **“D” DRIVE**

This position is for normal driving. The transmission automatically selects a suitable gear ratio for your speed and acceleration. Engine braking is automatically applied when necessary, depending on road conditions.

## **CAUTION**

- Never shift into the “D” (DRIVE) position from the “R” (REVERSE) position while the vehicle is in motion to avoid transmission damage.

### NOTE

- When the engine is cold, upshifts occur at a higher vehicle speed than when the engine is warm. This control is performed to quickly warm up the engine. It does not indicate a malfunction. After the vehicle has been driven for a while, upshifts will occur at the regular engine speeds.



### Twin Clutch SST control mode

E00621300175

Select the control mode from the following two types to suit the driving conditions.

Twin Clutch SST control mode	Characteristic
NORMAL (Control mode when engine is started)	Control mode for normal driving on local roads, expressways, and the like. Smooth shifting is performed at low engine speeds for economical driving with good ride quality.
SPORT	Control mode for driving on mountain roads, roads with uphill and downhill slopes, and expressways with long downhill slopes where engine braking is necessary. Compared to “NORMAL” mode, shifting occurs at higher engine speeds and is quicker. In addition, quick downshifting is possible when the accelerator pedal is depressed for quick acceleration or when the brakes are applied.

### NOTE

- When continuously driving on closed circuit tracks or at other locations where the engine is operated at high speeds and under a heavy load, the Twin Clutch SST fluid temperature will have a tendency to rise. In this case, if the temperature rises too high, the  warning display will appear on the information screen in the multi-information display to alert the driver. If the  warning display appears, be sure to refer to “Warning display” on page 4-43 and follow the appropriate measures.
- The Twin Clutch SST control mode can be selected both when “D” range operation is selected and when manual shifting is selected.
- If you select “SPORT” mode while the engine is cold, the transmission may shift up at different speeds compared to that when the engine is warm. This is simply the operation of the control system to warm the engine quickly. It does not indicate a malfunction.
- For slippery road surfaces, such as roads with accumulated snow, “NORMAL” mode is recommended for smooth shifting at low engine speeds.

## Starting and driving

### Twin Clutch SST control mode switch

E00621400176

When the ignition switch is set to the “ON” position, operate the Twin Clutch SST control mode switch (A) to change the control mode.

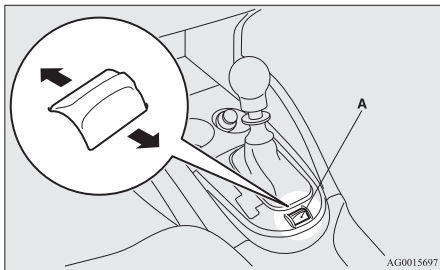

4

When the engine is started, the control mode is automatically set to the “NORMAL” mode. Use the following procedures to change the control mode.

#### To shift from “NORMAL” mode to “SPORT” mode

While the vehicle is stopped or being driven, push the Twin Clutch SST control mode switch forward.

#### To shift from “SPORT” mode to “NORMAL” mode

While the vehicle is stopped or being driven, push the Twin Clutch SST control mode switch rearward.

## NOTE

- If the Twin Clutch SST control mode switch is continuously pushed after a control mode has been selected, an erroneous operation prevention function operates and the control mode is automatically set to the “NORMAL” mode.

If you would like to select a control mode again, return the ignition switch to the “ACC” or “LOCK” position and restart the engine. Then, push the Twin Clutch SST control mode switch.

### Twin Clutch SST control mode display

E00621500193

When the ignition switch is turned to the “ON” position, the currently selected control mode is displayed on the multi-information display.

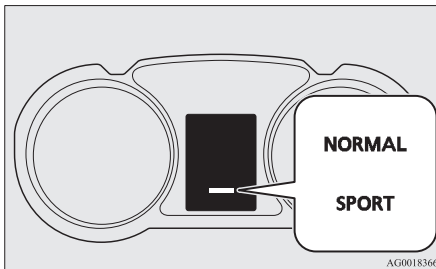

## Manual shift

E00621600178

Using the gearshift lever (A) or the shift paddles (B), shifting can be performed manually.

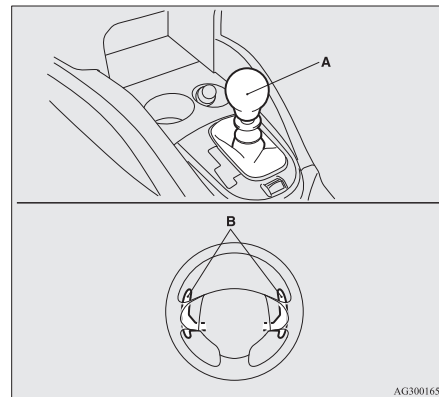

Shifting can be performed even while the accelerator pedal is depressed.

This allows the driver to enjoy sporty driving, such as quick cornering, by nimbly downshifting to reduce vehicle speed just before entering a curve.

## **⚠ CAUTION**

- When manually shifting while the vehicle is being driven, select the correct shift position to control the engine speed so that the tachometer indicator does not enter the red zone.

## CAUTION

- Sudden engine braking and rapid acceleration can cause the vehicle to skid. Shift down according to road conditions and vehicle speed.
- If both the left and right shift paddles are operated at the same time, the transmission may not change gears.

### NOTE

- Only the forward gears 1 to 6 can be selected. To reverse or park, place the gearshift lever in the “R” (REVERSE) or “P” (PARK) position.
- During manual shifting, downshifting will be performed automatically when the vehicle slows down and the transmission will downshift to 1<sup>st</sup> gear before the vehicle stops.
- If the gearshift lever or shift paddles are operated repeatedly, the transmission will also shift repeatedly.
- In order to ensure driving performance, upshifting may not occur depending on the vehicle speed even if the gearshift lever or shift paddles are operated. In addition, in order to prevent excessive engine speed, the buzzer sounds and downshifting may not occur depending on the vehicle speed even if the gearshift lever or shift paddles are operated.
- When driving in an aggressive manner involving high engine rpm, sudden acceleration and/or deceleration, the Twin Clutch SST could take longer to shift due to higher oil temperatures.

### Shifting using the gearshift lever

E00621700052

#### Selecting manual shifting

While the vehicle is stopped or being driven, move the gearshift lever from the “D” (DRIVE) position in the main shift gate towards the driver’s seat to select manual shifting.

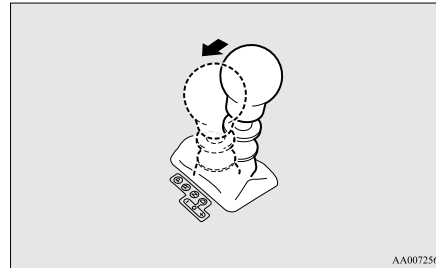

#### Shifting up and shifting down

Each time the gearshift lever is pushed forward, the transmission shifts up 1 gear. In addition, each time the gearshift lever is pulled rearward, the transmission shifts down 1 gear.

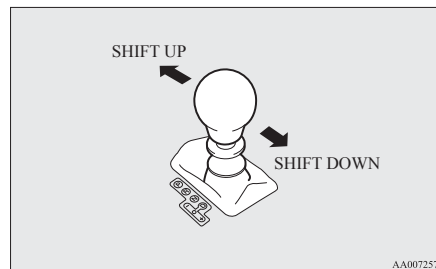

### NOTE

- After manual shifting is selected using the gearshift lever, shifting up and down can also be performed using the shift paddles.

#### Returning to “D” range operation

Move the gearshift lever towards the front passenger’s seat to return to “D” range operation.

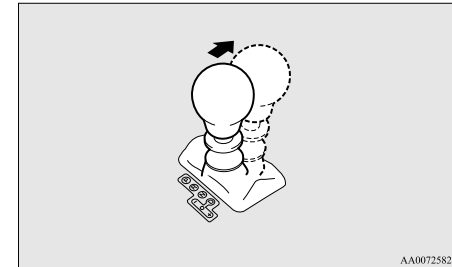

### NOTE

- When the gearshift lever is moved to the “D” (DRIVE) position from the manual shift gate, it may automatically select a gear different from the gear selected during manual shifting depending on vehicle speed or driving conditions.

## Starting and driving

### Shifting using the shift paddles

E00621800109

#### Selecting manual shifting

While the vehicle is stopped or being driven with the gearshift lever in the “D” (DRIVE) position, manual shifting can be selected by pulling one of the shift paddles towards you.

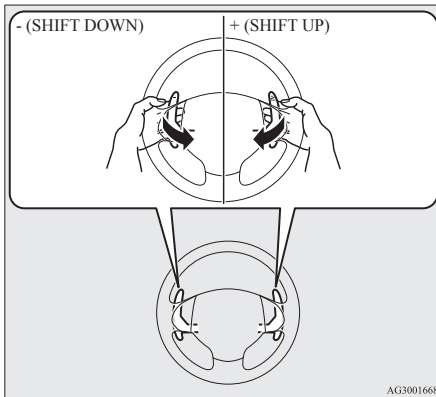

#### Shifting up

Each time the + (SHIFT UP) shift paddle is pulled, the transmission shifts up 1 gear.

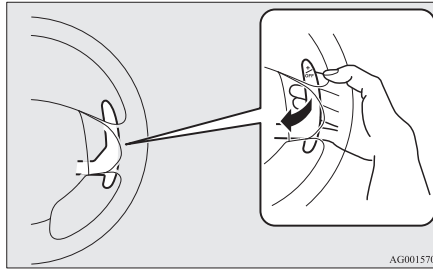

#### Shifting down

Each time the - (SHIFT DOWN) shift paddle is pulled, the transmission shifts down 1 gear.

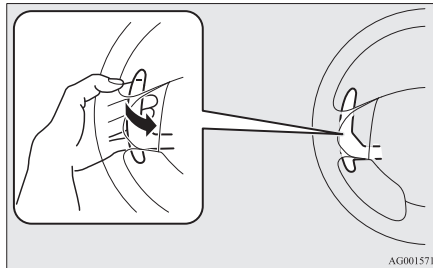

#### NOTE

- After manual shifting is selected using the shift paddles, shifting up and down can also be performed using the gearshift lever.

#### Returning to “D” range operation

When the gearshift lever is in the “D” (DRIVE) position, pull the + (SHIFT UP) shift paddle towards you for 2 seconds or more to return to “D” range operation.

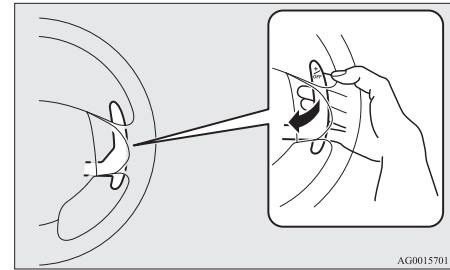

#### NOTE

- If manual shifting is selected using the shift paddles when the gearshift lever is in the “D” (DRIVE) position, the transmission will automatically return to “D” range operation before the vehicle stops.
- When the transmission returns to “D” range operation from manual shifting, it may automatically shift up or down from the gear selected using manual shifting depending on the vehicle speed or driving conditions.
- If manual shifting is selected using the shift paddles, “D” range operation will again be selected by moving the gearshift lever from the “D” (DRIVE) position towards the driver’s seat, then return it towards the front passenger’s seat.

### Manual shift display

E00623500184

In manual shift, the currently selected gear is displayed on the multi-information display.

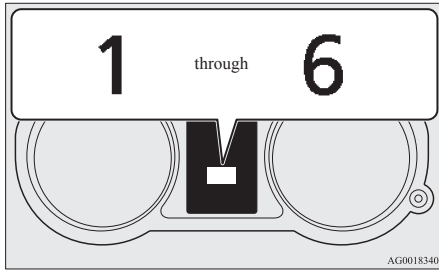

### Warning display

E00626700204



or



When the warning display or the warning display appear on the information screen in the multi-information display while you are driving, take the following measures.

#### When warning display is showing

E00626800117

The temperature of the Twin Clutch SST fluid is high.

If this occurs, take one of the following measures.

- Reduce the vehicle speed.
- Stop the vehicle in a safe place, place the gearshift lever in the “P” (PARK) position, and then open the bonnet with the engine running to cool the engine.

After a while, check that the warning display has gone out. If the display goes out, the vehicle can be driven normally. If the warning display remains on or comes on frequently, have the vehicle checked by a MITSUBISHI MOTORS Authorized Service Point.

### CAUTION

- If the warning display is shown, such as when the vehicle does not accelerate while traveling even if the accelerator pedal is depressed, the vehicle may not be able to be driven normally. For safety, pay attention to your surroundings when driving the vehicle.

### NOTE

- If the vehicle is continuously driven on hilly roads or in an aggressive manner involving high engine rpm, sudden acceleration and/or deceleration, the vehicle transmission may vibrate. This vibration is to alert the driver that the Twin Clutch SST fluid temperature has risen. It does not indicate a malfunction. If this occurs, perform the same measures for when the warning appears. If the vibration stops, the vehicle can be driven normally.

#### If vehicle is driven with warning displayed

If the vehicle continues to be driven after the warning display appears, and the temperature of the Twin Clutch SST fluid continues to rise, the transmission protection control may operate and cause the transmission to function as if the gearshift lever was in the “N” (NEUTRAL) position.

(At this time, the vehicle can temporarily not be driven.)

If this occurs, take the following corrective measures:

1. Depress the brake pedal and stop the vehicle in a safe place.
2. Place the gearshift lever in the “P” (PARK) position, and then open the bonnet with the engine running to cool the engine.
3. After a while, check that the warning display has gone out, and then stop the engine if the warning display has gone out.
4. If the engine can be restarted, the vehicle can be driven normally.

If the warning display remains on or comes on frequently, have the vehicle checked by a MITSUBISHI MOTORS Authorized Service Point.

#### When warning display is showing

E00626900091

A safety device in the Twin Clutch SST has been activated due to a possible malfunction in the Twin Clutch SST or in the engine electronic control module.

If this occurs, perform the following procedure.

1. Park your vehicle in a safe place and stop the engine.
2. Restart the engine.

If the warning display goes out, there is no abnormal condition.

However, if the warning display remains on or comes on frequently, have the vehicle checked by a MITSUBISHI MOTORS Authorized Service Point as soon as possible.

## CAUTION

- If the  warning display is shown, such as when the vehicle does not accelerate while traveling even if the accelerator pedal is depressed, the vehicle may not be able to be driven normally.  
For safety, pay attention to your surroundings when driving the vehicle.

## Operation of the Twin Clutch SST

E0062200094

## CAUTION

- Before selecting a position with the engine running and the vehicle stationary, fully depress the brake pedal to prevent the vehicle from creeping.  
The vehicle will begin to move as soon as the Twin Clutch SST is engaged, the brakes should only be released when you are ready to drive away.
- Depress the brake pedal with the right foot at all times.  
Using the left foot could cause driver movement delay in case of an emergency.
- To prevent sudden acceleration, never race the engine when shifting from the “P” (PARK) or “N” (NEUTRAL) position.
- Operating the accelerator pedal while the other foot is resting on the brake pedal will affect braking efficiency and may cause premature wear of brake pads.

## CAUTION

- Use the gearshift lever in the correct shift position in accordance with driving conditions.  
Never coast downhill backward with the gearshift lever in the “D” (DRIVE) or manual shifting position or coast forward with the gearshift lever in the “R” (REVERSE) position.  
The engine may stop and the unexpected increase in brake pedal effort and steering wheel weight could lead to an accident.
- Do not race the engine with brake pedal pressed when the vehicle is stationary.  
This can cause sudden acceleration and damage the Twin Clutch SST.  
Also, when you depress the accelerator pedal while holding down the brake pedal with the gearshift lever in the “D” (DRIVE) position, the engine revolutions may not rise as high as when performing the same operation with the gearshift lever in the “N” (NEUTRAL) position.

### *Passing acceleration*

E00622100011

To gain extra acceleration in “D” (DRIVE) position, push the accelerator to the floor. The Twin Clutch SST will automatically downshift.

### NOTE

- In manual shift, downshifts do not take place when the accelerator is depressed all the way to the floor.

### *Uphill/downhill driving*

E00622200139

### DRIVING UPHILL



The Twin Clutch SST may not upshift to a higher shift position if the computer determines the current speed cannot be maintained once a higher shift position is engaged.

For smoother vehicle performance, if you release the throttle while climbing a steep grade, the Twin Clutch SST may not upshift. This is normal, as the computer is temporarily preventing shifting. After reaching the top of the hill, normal shift function will resume.

## CAUTION

- Do not use the tendency of the vehicle to creep forward in order to drive at low speeds up hills.  
The transmission may be damaged and an accident may occur due to the following conditions.
  - The Twin Clutch SST fluid temperature will rise and can cause transmission damage.

## CAUTION

- If the vehicle is continuously driven at low speeds using the tendency of the vehicle to creep forward, the vehicle will vibrate or the  warning display will appear on the information screen in the multi-information display to alert the driver that the Twin Clutch SST fluid temperature has risen. After that, if the Twin Clutch SST fluid temperature rises even higher, the transmission protection control will operate. If this occurs, the vehicle may suddenly reverse as if the gearshift lever was in the “N” (NEUTRAL) position and cause an accident. If the  warning display appears or the transmission protection control operates, refer to “When warning display is showing” on page 4-43.

### DRIVING DOWNHILL

When travelling down steep grades, the computer may automatically select a lower shift position. This function assists engine braking efforts, reducing the need for using the service brakes.

### Waiting

E00622300127

For short waiting periods, such as at traffic signals, the gearshift lever can be left in position and the vehicle held stationary with the service brake.

For longer waiting periods with the engine running, place the gearshift lever in the “N” (NEUTRAL) position and apply the parking brake, while holding the vehicle stationary with the service brake.

## CAUTION

- Do not keep the vehicle in a stopped position on an uphill slope by depressing the accelerator pedal instead of the brake pedal.

The transmission may be damaged and an accident may occur due to the following conditions.

- The Twin Clutch SST fluid temperature will rise and can cause transmission damage.
- If the vehicle is kept in a stopped position by depressing the accelerator pedal instead of the brake pedal, the vehicle will vibrate or “SLOW DOWN” and the  warning display will appear on the information screen in the multi-information display to alert the driver that the Twin Clutch SST fluid temperature has risen.

After that, if the Twin Clutch SST fluid temperature rises even higher, the transmission protection control will operate.

If this occurs, the vehicle may suddenly reverse as if the gearshift lever was in the “N” (NEUTRAL) position and cause an accident.

If the  warning display appears or the transmission protection control operates, refer to “When warning display is showing” on page 4-43.

### Parking

E00622400014

To park the vehicle, first bring it to a complete stop, fully engage the parking brake, and then move the gearshift lever to the “P” (PARK) position. If you are going to leave the vehicle unattended, always switch off the engine and carry the key.

### NOTE

- On a slope, be sure to apply the parking brake before moving the gearshift lever to the “P” (PARK) position. If you move the gearshift lever to the “P” (PARK) position before applying the parking brake, it may be difficult to disengage the gearshift lever from the “P” (PARK) position when you next drive the vehicle, requiring application of a strong force to the gearshift lever to move from the “P” (PARK) position.

### What to do if the following occur with the Twin Clutch SST

E00622500220

If there is a malfunction in the Twin Clutch SST or engine electronic control module, the following may occur.

- Twin Clutch SST does not shift.
- Vehicle cannot move.
- Twin Clutch SST acceleration is slow.
- Vehicle does not creep.
- “Shift shock” is large.
- Shifting occurs at higher engine speed.
- Response is slow.

If either of these occurs, perform the following procedure.

## Starting and driving

### When warning display is showing

The temperature of the Twin Clutch SST fluid is high.

Refer to “Warning display” on page 4-43 and follow the appropriate measures.

### When the check engine warning lamp comes on or blinking

There could be a malfunction in the engine electronic control module.

Refer to “Check engine warning lamp” on page 3-38 and follow the appropriate measures.

### When the gearshift lever position display is not showing

A safety device in the Twin Clutch SST has been activated due to a possible malfunction in the Twin Clutch SST.

Refer to “If the gearshift lever position display is not showing” on page 4-38 and follow the appropriate measures.

### When warning display is showing or when no warning is showing in the multi-information display

A safety device in the Twin Clutch SST has been activated due to a possible malfunction in the Twin Clutch SST or in the engine electronic control module.

Perform the following procedure.

1. Park your vehicle in a safe place and stop the engine.
2. Restart the engine.

If the vehicle moves and accelerates normally after this procedure is performed, there is no malfunction.

However, if the vehicle does not move or accelerate normally, or if this problem occurs repeatedly, have the vehicle checked by a MITSUBISHI MOTORS Authorized Service Point as soon as possible.

## CAUTION

- When the Twin Clutch SST fluid temperature is high, the engine idle speed when the vehicle is stopped may increase or the vehicle will have a weak tendency to creep.
- After that, if the Twin Clutch SST fluid temperature rises even higher, the  warning display will appear.

## Electronically controlled 4WD system\*

E00604900293

The electronically controlled 4WD system is a 4-wheel drive system that allows one of three drive modes to be selected with a dial, in accordance with the driving conditions.

The following drive modes are available.

Drive mode	Function
2WD	This mode is for economical driving on normal dry roads and motorway. Driving in front-wheel drive.
4WD AUTO	The default mode. This mode is for automatically controlling the distribution of driving torque to all four wheels according to the driving conditions.
4WD LOCK	This mode is for driving in slippery conditions such as on snow-covered roads or sand. The large amount of driving torque that is applied to the rear tyres enables getting out of slippery areas and powerful driving is possible across all ranges.

4-wheel drive operation requires special driving skills.

Carefully read the “4-wheel drive operation” on page 4-48 and take care to drive safely.



### Drive mode-selector

The drive mode can be switched by turning the dial while the ignition switch is in the “ON” position.

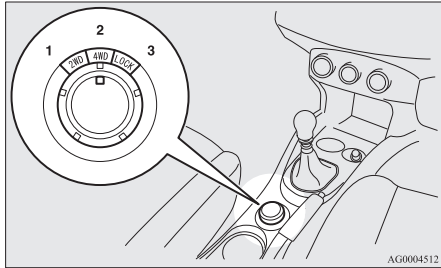

- 1- 2WD
- 2- 4WD AUTO
- 3- 4WD LOCK

The drive mode is displayed as an interrupt display on the information screen in the multi-information display when the drive mode is switched.

After a few seconds, the information screen returns from the drive mode display to the previous screen.

Drive mode	Display	
	Type 1	Type 2
2WD		
4WD AUTO		
4WD LOCK		

### **⚠ CAUTION**

- Do not operate the drive mode-selector with the front wheels spinning on a snowy road or in similar conditions. The vehicle could lunge in an unexpected direction.
- Driving on dry, paved roads in “4WD LOCK” mode causes increased fuel consumption and noise.
- Do not drive with the tyres spinning in “2WD” mode. Doing so could generate heat in the drive-system components.

#### NOTE

- The drive mode can be switched while driving or stopped.

### Drive mode indicator

Type 1



Type 2



Normally the indicator illuminates when the ignition switch is turned to the “ON” position, and then the drive mode is displayed a few seconds after the engine is started.

The status of each drive mode display is as follows.

Drive mode	Drive mode indicator	
	“4WD” indicator	“LOCK” indicator
2WD	OFF	OFF
4WD AUTO	ON	OFF
4WD LOCK	ON	ON

### **⚠ CAUTION**

- If the selected drive mode indicator is blinking, the vehicle switches automatically to front-wheel drive in order to protect the drive-system components, and drive mode selection is no longer possible with the drive mode-selector.

The warning display is also displayed in the information screen in the multi-information display.

Reduce speed, and if the indicator goes out after driving a while, resume driving as before. If the indicator continues blinking for more than about 5 minutes, have the vehicle inspected at a MITSUBISHI MOTORS Authorized Service Point.

Type 1



Type 2



## CAUTION

- If the warning display on the information screen in the multi-information display, a problem has occurred with the electronically controlled 4WD system and the safety device has activated. Have an inspection made by a MITSUBISHI MOTORS Authorized Service Point.

Type 1



Type 2



## CAUTION

- Always use tyres of the same size, same type, and same brand, and which have no wear differences. Using tyres that differ in size, type, brand, or wear amount may activate the protection of the drive-system components, causing the drive mode in “4WD AUTO” mode to lock or the “4WD” and “LOCK” indicators to blink alternately.

## 4-wheel drive operation

E0060600832

Your vehicle has been designed primarily for use on paved roads. But its unique 4-wheel drive system allows you to occasionally travel on unpaved roads, to campgrounds, picnic sites, and similar locations.

Not only does this ensure better handling on dry, paved roads but also permits better traction when driving on slippery, wet or snow-covered roads and when moving out of mud.

But it is not suitable for heavy off road use or towing in rough conditions.

It is particularly important to note that 4-wheel drive may not give sufficient hill climbing ability and engine braking on steep slopes. You should try to avoid driving on steep slopes.

Also, you must exercise caution when driving on sand and mud and when driving through water because sufficient traction may not be available in certain circumstances.

Please avoid driving the vehicle through areas where the tyres may get stuck in deep sand or mud.

## WARNING

- Do not over-rely on the 4-wheel drive vehicles. Even 4-wheel drive vehicles have limits to the system and ability to maintain control and traction. Reckless driving may lead to accidents. Always drive carefully, taking account of the road conditions.
- Improperly operating this vehicle on or off-paved roads can cause an accident or rollover in which you and your passengers could be seriously injured or killed.

## WARNING

- Follow all instructions and guidelines in the owner’s manual.
- Keep your speed low and do not drive faster than conditions allow you to.

### NOTE

- Driving on rough roads can be hard on a vehicle. Before you leave paved roads, be sure all scheduled maintenance and service has been done, and that you have inspected your vehicle. Pay special attention to the condition of the tyres, and check the tyre pressures.
- MITSUBISHI MOTORS is not responsible to the operator for any damage or injury caused or liability incurred by improper and negligent operation of a vehicle. All techniques of vehicle operation depend on the skill and experience of the operator and other participating parties. Any deviation from the recommended operating instructions above is at their own risk.
- Note that the stopping distance required of a 4-wheel drive vehicle differs very little from that of a 2-wheel drive vehicle. When driving on a snow-covered road or a slippery, muddy surface, make sure that you keep a sufficient distance between your vehicle and the one ahead of you.
- The driving posture should be more upright; adjust the seat to a good position for easy steering and pedal operation. Be sure to wear the seat belt.

- After driving on rough roads, check each part of the vehicle and wash it thoroughly with water. Refer to the “Inspection and maintenance following rough road operation” section and “Maintenance” section.

### CAUTION

- **Setting the drive mode-selector to “4WD LOCK” to drive on dry paved road will increase fuel consumption, with possible noise generation.**

### Turning sharp corners

When turning a sharp corner in “4WD LOCK” position at low speed, a slight difference in steering may be experienced similar to as if the brakes were applied. This is called tight corner braking and results from each of the 4 tyres being at a different distance from the corner. The phenomenon is typical of 4-wheel drive vehicles. If this occurs, either straighten out the steering wheel, or change to “2WD” or “4WD AUTO” mode.

### On snowy or icy roads

Set the drive mode-selector to “4WD AUTO” or “4WD LOCK” in accordance with the road conditions, and then gradually depress the accelerator pedal for a smooth start.

#### NOTE

- The use of snow tyres is recommended.
- Maintain a safe distance between vehicles, avoid sudden braking, and use engine braking (downshifting).

### CAUTION

- **Avoid sudden braking, sudden acceleration and sharp turning. Skidding occurs and control of the vehicle could be lost.**

### Driving on sandy or muddy roads

Set the drive mode-selector to “4WD LOCK” and then gradually depress the accelerator pedal for a smooth start. Keep the pressure on the accelerator pedal as constant as possible, and drive at low speed.

### CAUTION

- **Do not force the vehicle or drive recklessly on sandy surfaces. In comparison with normal road surfaces, the engine and other drive-system components are put under excessive strain when driving on such a surface. This could lead to accidents.**
- **If the engine coolant temperature display  flashes on the information screen in the multi-information display or the engine power drops suddenly while the vehicle is being driven, park your vehicle immediately in a safe place. Refer to “Engine overheating” on page 6-04 for details and take the required measures.**

### WARNING

- **When attempting to rock your vehicle out of a stuck position, be sure that the area around the vehicle is clear of people and physical objects. The rocking motion may cause the vehicle to suddenly launch forward or backward, causing injury or damage to nearby people or objects.**

#### NOTE

- Avoid sudden braking, sudden acceleration and sharp turning; such operations could result in the vehicle becoming stuck.
- If the vehicle becomes stuck in sandy or muddy roads, it can often be moved with a rocking motion. Move the gearshift lever or selector lever alternately between the 1<sup>st</sup> and “R” (Reverse) positions (with M/T), the “D” (DRIVE) and “R” (REVERSE) positions (with A/T, CVT or Twin Clutch SST), while pressing lightly on the accelerator pedal.
- Driving on rough roads can cause rust on the vehicle; wash the vehicle thoroughly as soon as possible after such use.

### Climbing/descending sharp grades

Your vehicle may not provide sufficient hill climbing ability and engine braking on steep slopes. Avoid driving on steep slopes even though the vehicle is a 4-wheel drive vehicle.

## Starting and driving

### Driving through water

E00618900050

If the electrical circuits become wet, further operation of the vehicle will be impossible; therefore, avoid driving through water unless absolutely necessary. If driving through water is unavoidable, use the following procedure:

Check the depth of the water and the terrain before attempting to drive through it. Drive slowly to avoid creating excessive water splashing.

#### CAUTION

- Never drive through water that is deep enough to cover wheel hubs, axles or exhaust pipe. Do not change the gearshift lever position (M/T or Twin Clutch SST) or the selector lever position (A/T or CVT) while driving through water. Frequent driving through water can adversely affect the life span of the vehicle; we recommend you to take the necessary measures to prepare, inspect, and repair the vehicle.
- After driving through water, apply the brakes to be sure they are functioning properly. If the brakes are wet and not functioning properly, dry them out by driving slowly while lightly depressing the brake pedal. Inspect each part of the vehicle carefully.

### Inspection and maintenance following rough road operation

E00606700338

After operating the vehicle in rough road conditions, be sure to perform the following inspection and maintenance procedures:

- Check that the vehicle has not been damaged by rocks, gravel, etc.
- Carefully wash the vehicle with water. Drive the vehicle slowly while lightly depressing the brake pedal in order to dry out the brakes. If the brakes still do not function properly, we recommend you to have the brakes checked as soon as possible.
- Remove the insects, dried grass, etc. clogging the radiator core.
- After driving through water, check the engine, transmission and differential oil. If the oil or grease is milky or cloudy because of water contamination, it must be replaced with new oil or grease.
- Check the inside of the vehicle. If water entry is found, dry the carpet etc.
- Inspect the headlamps, If the headlamp bulb is flooded with water, we recommend you to have it drained.

### Cautions on handling of 4-wheel drive vehicles

E00606800397

#### Tyres and wheels

Since the driving torque can be applied to the 4 wheels, the driving performance of the vehicle when operating in 4-wheel drive is greatly affected by the condition of the tyres.

Pay close attention to the tyres.

- Install only the specified tyres on all wheels. Refer to “Tyres and wheels” on page 9-17.
- Be sure all 4 tyres and wheels are the same size and type. When it is necessary to replace any of the tyres or wheels, replace all 4 tyres.
- All tyres should be rotated before the wear difference between the front and rear tyres is recognizable.

Good vehicle performance cannot be expected if there is a difference in wear between tyres. Refer to “Tyre rotation” on page 8-13.

- Check the tyre inflation pressure regularly.

**CAUTION**

- Always use tyres of the same size, same type, and same brand, and which have no wear differences. Using tyres of different size, type, brands or degree of wear, will increase the differential oil temperature, resulting in possible damage to the driving system. Further, the drive train will be subjected to excessive loading possibly leading to oil leakage, component seizure, or other serious faults.

## Towing

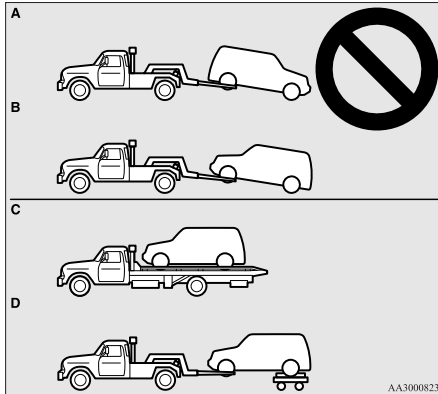
**CAUTION**

- Do not tow 4-wheel drive vehicles with the front or rear wheels on the ground (Type A or Type B) as illustrated. This could result in damage to the drivetrain, or unstable towing. If you tow 4-wheel drive vehicles, use Type C or Type D equipment.
- Even in “2WD” drive mode, the vehicle cannot be towed with the front or the rear wheels on the ground.

## Jacking up a 4-wheel drive vehicle

**WARNING**

- Do not crank the engine while jacking up the vehicle. The tyre on the ground may turn and the vehicle may roll off the jack.

## Clutch operation

Quick or slight clutch engagement made while the engine is running at high speed will cause damage to the clutch and transmission because the tractive force is very great. Operate the pedal slowly and positively.

**Braking**

E00607001380

All the parts of the brake system are critical to safety. We recommend you to have the vehicle checked at regular intervals according to the service booklet.

**CAUTION**

- Avoid driving habits that cause heavy braking and never “ride” the brakes by resting your foot on the brake pedal while driving. It causes brake overheating and fade.

## Brake system

The service brake is divided into two brake circuits. And your vehicle is equipped with power brakes. If one brake circuit fails, the other is available to stop the vehicle. If you should lose the power assist for some reason, the brakes will still work. In these situations, even if the brake pedal moves down to the very end of its possible stroke or resists being depressed, keep depressing the brake pedal down harder and further than usual; stop driving as soon as possible and have the brake system repaired.

**WARNING**

- Do not turn off the engine while your vehicle is in motion. If you turn off the engine while driving, the power assistance for the braking system will stop working and your brakes will not work effectively.

## **WARNING**

- If the power assist is lost or if either brake hydraulic system stops working properly, have your vehicle checked immediately.

### Warning display

The brake warning lamp illuminates to indicate a fault in the braking system. A warning is also displayed on the multi-information display. Refer to “Brake warning lamp” on pages 3-38 and 3-40.

### When brakes are wet

Check the brake system while driving at a low speed immediately after starting, especially when the brakes are wet, to confirm they work normally. A film of water can be formed on the brake discs and prevent normal braking after driving in heavy rain or through large puddles, or after the vehicle is washed. If this occurs, dry the brakes out by driving slowly while lightly depressing the brake pedal.

### When driving downhill

It is important to take advantage of the engine braking by shifting to a lower shift position while driving on steep downhill roads in order to prevent the brakes from overheating.

## **WARNING**

- Do not leave any objects near the brake pedal or let a floor mat slide under it; doing so could prevent the full pedal stroke that would be necessary in an emergency. Make sure that the pedal can be operated freely at all times. Make sure the floor mat is securely held in place.

### Brake pads

- Avoid hard braking situations. New brakes need to be broken-in by moderate use for the first 200 km (124 miles).
- The disc brakes are provided with a warning device which emits a shrieking metallic sound while braking if the brake pads have reached their wear limit. If you hear this sound, have the brake pads replaced immediately.

## **WARNING**

- Driving with worn brake pads will make it harder to stop, and can cause an accident.

### Hill start assist\*

E0062800096

The hill start assist makes it easy to start off on a steep uphill slope by preventing the vehicle from moving backwards. It keeps the braking force for about 2 seconds when you move your foot from the brake pedal to the accelerator pedal.

## **CAUTION**

- Do not overly rely on the hill start assist to prevent backwards movement of the vehicle. Under certain circumstances, even when hill start assist is activated, the vehicle may move backwards if the brake pedal is not sufficiently depressed, if the vehicle is heavily loaded, or if the road is very steep or slippery.
- The hill start assist is not designed to keep the vehicle stopped in place on uphill slopes for more than 2 seconds.
- When facing uphill, do not rely on using the hill start assist to maintain a stopped position as an alternative to depressing the brake pedal. Doing so could result in an accident.
- Do not turn the ignition switch to the “LOCK” or “ACC” position while the hill start assist is operating. The hill start assist could stop operating, which could result in an accident.

### To operate

E00628100273

1. Stop the vehicle completely using the brake pedal.
2. On vehicles equipped with M/T, place the gearshift lever into the 1<sup>st</sup> position.

On vehicles equipped with A/T, CVT or Twin Clutch SST, place the selector lever (A/T or CVT) or gearshift lever (Twin Clutch SST) into the “D” position.

## NOTE

- When reversing on an uphill slope, place the selector lever or gearshift lever into the “R” position.
3. Release the brake pedal and the hill start assist will maintain the braking force applied while stopping for approximately 2 seconds.
  4. Depress the accelerator pedal and the hill start assist gradually will decrease the braking force as the vehicle starts moving.

## NOTE

- The hill start assist is activated when all of the following conditions are met.
  - The engine is running.  
(The hill start assist will not be activated while the engine is starting or immediately after the engine is started.)
  - On vehicles equipped with M/T, the gearshift lever is in the following position.  
[When starting an uphill slope forwards.]  
The gearshift lever is in any position other than “R”.  
(The hill start assist will operate, even if the gearshift lever is in the “N” position.)  
[When starting an uphill slope backwards.]  
The gearshift lever is in the “R” position.  
(The hill start assist will not operate when the gearshift lever is in the “N” position.)

- On vehicles equipped with A/T, CVT or Twin Clutch SST, the selector lever (A/T or CVT) or gearshift lever (Twin Clutch SST) is in any position other than “P” or “N”.
  - The vehicle is completely stationary, with the brake pedal depressed.
  - The parking brake is released.
- The hill start assist will not operate if the accelerator pedal is depressed before the brake pedal is released.
  - The hill start assist also operates when reversing on an uphill slope.

## Warning display

E00628200287

If an abnormal condition occurs in the system, the following display/indicator will turn on.



ASC indicator

Warning display type 1



Warning display type 2



## CAUTION

- If the warning is displayed, the hill start assist will not operate. Start off carefully.
- Park your vehicle in a safe place and stop the engine. Restart the engine and check whether the display/indicator goes out, in which case the hill start assist is again working normally.  
If they remain displayed or reappear frequently, it is not necessary to stop the vehicle immediately, but the vehicle should be inspected by a MITSUBISHI MOTORS Authorized Service Point as soon as possible.

## Starting and driving

### **Brake assist system**

E00627000291

The brake assist system is a device assisting drivers who cannot depress the brake pedal firmly when it is necessary to do so (such as in emergency stop situations) and provides greater braking force.

If the brake pedal is depressed suddenly, the brakes will be applied with more force than usual.

#### **⚠ CAUTION**

- **The brake assist system is not a device designed to exercise braking force greater than its capacity. Make sure to always keep a sufficient distance between vehicles in front of you without relying too much on the brake assist system.**

4

#### NOTE

- Once the brake assist system is operational, it maintains great braking force even if the brake pedal is lightly released. To stop its operation, completely remove your foot from the brake pedal.
- The brake assist system may become operational when the brake pedal is fully depressed even if it has not been depressed suddenly.

- When the brake assist system is in use, you may feel as if the depressed brake pedal is soft, the pedal moves in small motions in conjunction with the sound of the ABS operation, or the vehicle body and the steering wheel vibrate. This occurs when the brake assist system is operating normally and does not indicate faulty operation. Continue to firmly depress the brake pedal.
- You may hear an operation noise when the brake pedal is depressed suddenly while stationary. This does not indicate a malfunction and the brake assist system is operating normally.

### **Emergency stop signal system**

E00626000018

This is a device that reduces the possibility of rear end collisions by the rapid and automatic blinking of the hazard warning lamps to alert vehicles approaching from behind during sudden braking. When the emergency stop signal system operates, the hazard warning indication lamp in the instrument cluster blinks rapidly at the same time.

#### **⚠ CAUTION**

- **If the ABS warning or ASC warning is displayed, the emergency stop signal system may not operate. Refer to “ABS warning lamp/display” on page 4-56. Refer to “ASC warning display” on page 4-60.**

#### NOTE

- [Activating condition for the emergency stop signal system]  
It activates when all of the following conditions are met.
    - The vehicle speed is approximately 55 km/h (34 mph) or higher.
    - The brake pedal has been depressed, and the system judges that it was sudden braking from the vehicle deceleration and the operating condition of the anti-lock brake system (ABS).
- [Deactivating condition for the emergency stop signal system]  
It deactivates when one of the following conditions is met.



- The brake pedal is released.
- The hazard warning flasher switch is pressed.
- The system judges that it was not sudden braking from the vehicle deceleration and the operating condition of the anti-lock brake system (ABS).

## Anti-lock brake system (ABS)

E00607100834

Environmental conditions can have an effect on braking. During sudden braking when there is snow, ice, oil, water etc. on the road surface, a skid may occur. In this situation, steering control and braking effectiveness is reduced and the stopping distance is increased. The vehicle may also go into an uncontrolled spin.

The ABS helps prevent the wheels from locking during braking, thus maintaining directional stability, ensuring controllability and providing optimum braking force.

### Operating hints

- Always maintain the same distance from the vehicle in front of you as you would for a vehicle not equipped with ABS. Compared with vehicles not fitted with ABS, your vehicle may require a longer stopping distance in the following cases:
  - Driving on gravel or snow-covered roads.
  - Driving with tyre chains installed.
  - Driving on roads where the road surface is pitted or has other differences in surface height.
  - Driving on bumpy roads or other poor driving surfaces.
- Operation of ABS is not restricted to situations where brakes are applied suddenly. This system may also operate to prevent wheel lock when you are driving over manholes, steel road-work plates, or the vehicle is driven over steps or level differences in the road, road markings, or other surfaces which are difficult for the wheels to grip.

- When the ABS is activated, you may feel the brake pedal pulsation and the vibrations of the vehicle body and steering wheel. You may also hear a characteristic noise. At this time, you may feel as if the pedal attempts to resist being depressed.

This is a normal result of the ABS operation, and does not indicate a problem.

**If this situation occurs, depress the brake pedal more firmly in order to operate the ABS. Do not pump the brake. This will result in reduced braking performance.**

- You will hear the operation sound of the motor coming from the engine compartment immediately after starting the engine. If the brake pedal is depressed at that moment, you can feel the brake pedal pulsating. This pulsation is due to the self-diagnosis operation of the ABS and does not indicate a malfunction.
- The ABS will operate after the vehicle has accelerated to a speed in excess of approximately 10 km/h (6 mph). It stops operating when the vehicle decelerates to a speed below about 5 km/h (3 mph).

### CAUTION

- **Even the ABS cannot prevent the natural laws of physics from acting on the vehicle. It cannot for instance avoid accidents that may result from excessive speed on bends or following another vehicle too closely or aquaplaning. It should remain the driver's task to observe safety precautions to judge speeds and brake applications correctly in such conditions.**

**⚠ CAUTION**

- Be sure to use tyres of the same type and size on 4 wheels.  
If tyre types or sizes are mixed, ABS may not function normally.
- Never install a limited-slip differential, which is not MITSUBISHI genuine parts, as the ABS may not function normally. We recommend you to consult a MITSUBISHI MOTORS Authorized Service Point.

**ABS warning lamp/display**

E00607201018

Warning lamp



Warning display type 1



Warning display type 2



If there is a malfunction in the system, the ABS warning lamp will come on and the warning display will appear on the information screen in the multi-information display.

Under normal conditions, the ABS warning lamp only comes on when the ignition switch is turned to the “ON” position and goes off a few seconds later.

**⚠ CAUTION**

- Any of the following warning lamp/display behavior indicates that the ABS is not functioning and only the standard brake system is working. (The standard brake system is functioning normally.) If this happens, take your vehicle to a MITSUBISHI MOTORS Authorized Service Point.
  - When the ignition switch is in the “ON” position, the warning lamp does not come on or it remains on and does not go off
  - The warning lamp comes on while driving
  - The warning display appears while driving

**If the warning lamp/display illuminate while driving**

E00607301181

*If only the ABS warning lamp/display illuminate*  
Avoid hard braking and high-speed driving. Stop the vehicle in a safe place. Restart the engine and check to see whether the lamp goes out after a few minutes driving; if it then remains off during driving, there is no problem.

However, if the lamp does not go out, or if it lights up again when the vehicle is driven, we recommend you to have the vehicle checked as soon as possible.

*If the ABS warning lamp/display and brake warning lamp/display illuminate at the same time*

Warning lamp



Warning display type 1



Warning display type 2



The ABS and brake force distribution function may not work, so hard braking could make the vehicle unstable. Avoid hard braking and high-speed driving. Stop the vehicle in a safe place and we recommend you to have the vehicle checked.

**NOTE**

- The ABS warning lamp and brake warning lamp illuminate at the same time and the warning displays appear alternately on the information screen in the multi-information display.

**After driving on icy roads**

E00618800020

After driving on snowy roads, remove any snow and ice which may have become adhered to the wheel areas.

When doing this, be careful not to damage the wheel speed sensors (A) and cables located at each wheel on vehicles equipped with an ABS.

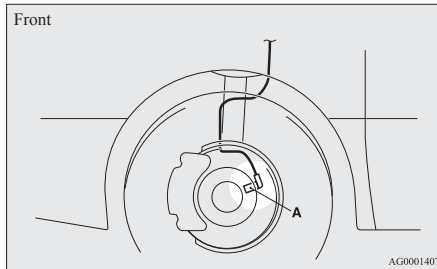
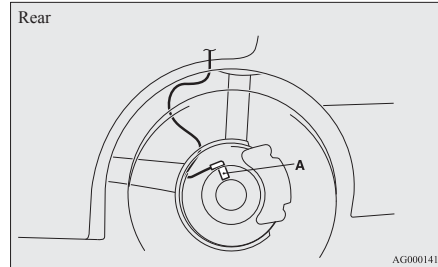
**Power steering system**

E00607400156

When the engine is stopped, the power steering system will not function and it will require greater manual effort to operate the steering wheel. Keep this in mind in particular when towing the vehicle. Never turn off the engine while driving.

Periodically check the power steering fluid level.

**CAUTION**

- Do not hold the steering wheel in the fully turned position (either left or right), for longer than 10 seconds. This can cause damage to the power steering system.

## Starting and driving

### *Active stability control (ASC)\**

E00616700155

The Active Stability Control (ASC) takes overall control of the anti-lock brake system, traction control function and stability control function to help maintain the vehicle's control and traction. Please read this section in conjunction with the page on the anti-lock brake system, traction control function and stability control function.

Anti-lock brake system (ABS) → p. 4-55

Traction control function → p. 4-58

Stability control function → p. 4-58

### **CAUTION**

- **Do not over-rely on the ASC. Even the ASC cannot prevent the natural laws of physics from acting on the vehicle.**

This system, like any other system, has limits and cannot help you to maintain traction and control of the vehicle in all circumstances. Reckless driving may lead to accidents. It is the driver's responsibility to drive carefully. This means taking into account the traffic, road and environmental conditions.

- **Be sure to use the same specified type and size of tyre on all 4 wheels. Otherwise, the ASC may not work properly.**
- **Do not install any aftermarket limited-slip differential (LSD) on your vehicle. The ASC may stop functioning properly.**

### NOTE

- An operation noise may be emitted from the engine compartment in the following situations. The sound is associated with checking the operations of the ASC. At this time, you may feel a shock from the brake pedal if you depress it. These do not indicate a malfunction.
  - When the ignition switch is set to the "ON" position.
  - When the vehicle is driven for a while after the engine is turned on.
- When the ASC is activated, you may feel a vibration in the vehicle body or hear a whining sound from the engine compartment. This indicates that the system is operating normally. It does not indicate a malfunction.
- When the anti-lock brake system warning lamp is illuminated, the ASC is not active.

### Traction control function

E00619000087

On slippery surfaces, the traction control function prevents the drive wheels from excessive spinning, thus helping the vehicle to start moving from a stopped condition. It also provides sufficient driving force and steering performance as the vehicle turns while pressing the acceleration pedal.

### **CAUTION**

- **When driving a vehicle on a snowy or icy road, be sure to install snow tyres and drive the vehicle at moderate speeds.**

### Stability control function

E00619100017

The stability control function is designed to help the driver maintain control of the vehicle on slippery roads or during rapid steering manoeuvres. It works by controlling the engine output and brake on each wheel.



### NOTE

- The stability control function operates at speeds of about 15 km/h (9 mph) or higher.

### "ASC OFF" switch

E00619200467

The ASC is automatically activated when the ignition switch is turned to the "ON" position. You can deactivate the system by pressing down the "ASC OFF" switch for 3 seconds or longer.

When the ASC is deactivated, the  display/indicator will turn on. To reactivate the ASC, momentarily press the “ASC OFF” switch; the  display/indicator is turned off.

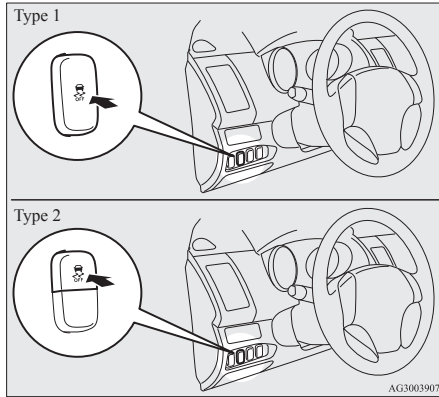

## CAUTION

- For safety reasons, the “ASC OFF” switch should be operated when your vehicle is stopped.
- Be sure to keep the ASC on while driving in normal circumstances.

## NOTE

- When moving out of mud, sand or fresh snow, pressing the accelerator pedal may not allow the engine speed to increase. In such situations, temporarily turning off the ASC with the “ASC OFF” switch will make it easier to move out your vehicle.
- Using the “ASC OFF” switch turns off both the stability control function and the traction control function.
- If you continue to press the “ASC OFF” switch after the ASC is turned off, the “mistaken operation protection function” will activate and the ASC will turn back on.

## ASC operation display or ASC OFF display

E00619300527



- ASC operation display/ASC indicator  
The display/indicator will blink when the ASC is operating.





- ASC OFF display/ASC OFF indicator  
This display/indicator will turn on when the ASC is turned off with the “ASC OFF” switch.



## NOTE

- The combination of items shown on the display varies depending on the vehicle model.

## CAUTION

- When  display/indicator blinks, ASC is operating, which means that the road is slippery or that your vehicle’s wheels are beginning to slip. If this happens, drive slower with less accelerator input.
- If the temperature in the braking system continues to increase due to continuous brake control on a slippery road surface, the  display/indicator will blink. To prevent the brake system from overheating, the brake control of the traction control function will be temporarily suspended. The engine control of the traction control function and normal brake operation will not be affected. Park your vehicle in a safe place. When the temperature in the braking system has come down, the  display/indicator will be turned off and the traction control function will start operating again.

## NOTE

- The  display/indicator may turn on when you start the engine. This means that the battery voltage momentarily dropped when the engine was started. It does not indicate a malfunction, provided that the display goes out immediately.
- When a compact spare tyre has been put on your vehicle, the gripping ability of the tyre will be lower, making it more likely that the  display/indicator will blink.

## Starting and driving

### ASC warning display

E00619400544

If an abnormal condition occurs in the system, the following display/indicator will turn on.



- ASC indicator



- ASC OFF display/ASC OFF indicator

Warning display type 1



Warning display type 2



#### NOTE

- The combination of items shown on the display varies depending on the vehicle model.

### CAUTION

- **The system may be malfunctioning.** Park your vehicle in a safe place and stop the engine. Restart the engine and check whether the display/indicator goes out. If they go out, there is no abnormal condition. If they do not go out or appear frequently, it is not necessary to stop the vehicle immediately, but we recommend you to have your vehicle inspected.
- If the 2WD vehicle is towed with the ignition switch in the “ON” position and only the front wheels or only the rear wheels raised off the ground, the ASC may operate, resulting in an accident. When towing the 2WD vehicle with the front wheels raised, keep the ignition switch in the “LOCK” or “ACC” position. When towing the vehicle with the rear wheels raised, keep the ignition switch in the “ACC” position. Refer to “Towing” on page 6-19.

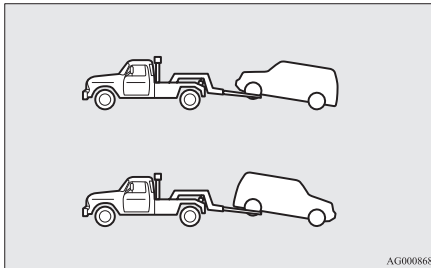

### Cruise control\*

E00609100623

Cruise control is an automatic speed control system that keeps a set speed. It can be activated at about 40 km/h (25 mph) or more.

### CAUTION

- When you do not wish to drive at a set speed, turn off the cruise control for safety.
- Do not use cruise control when driving conditions will not allow you to stay at the same speed, such as in heavy traffic or on roads that are winding, icy, snow-covered, wet, slippery, on a steep downhill slope.
- On vehicles with M/T, do not move the gearshift lever to the “N” (Neutral) position while driving at a set speed without depressing the clutch pedal. The engine will run too fast and might be damaged.

#### NOTE

- Cruise control may not be able to keep your speed on uphill or downhill.
- Your speed may decrease on a steep uphill. You may use the accelerator pedal if you want to stay at your set speed.
- Your speed may increase to more than the set speed on a steep downhill. You must use the brake to control your speed. As a result, the set speed driving is deactivated.

## Cruise control switches

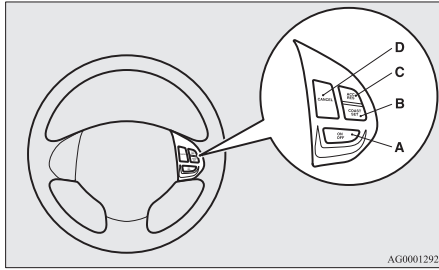

### A- “ON OFF” switch

Used to turn on and off the cruise control.

### B- “COAST SET” switch

Used to reduce the set speed and to set the desired speed.

### C- “ACC RES” switch

Used to increase the set speed and to return to the original set speed.

### D- “CANCEL” switch

Used to deactivate the set speed driving.

## NOTE

- When operating the cruise control switches, press the cruise control switches correctly. The set speed driving may be deactivated automatically if two or more switches of the cruise control are pressed at the same time.

## To activate

E00609301039

1. With the ignition switch in the “ON” position, press the “ON OFF” switch (A) to turn on the cruise control. The “CRUISE” indication lamp in the meter cluster will come on.

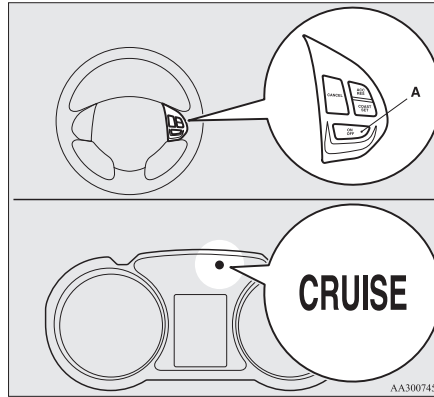

## NOTE

- If the cruise control is on when the ignition switch is turned to the “LOCK” or “ACC” position, cruise control will be on automatically the next time you start the engine. The “CRUISE” indication lamp will also be on.
- If the battery voltage is insufficient, the memory data for the cruise control may be erased. As a result, the “CRUISE” indication lamp may not come on when you restart the engine. If this happens, press the “ON OFF” switch once again to turn on the cruise control.

2. Accelerate or decelerate to your desired speed, then press and release the “COAST SET” switch (B) when the “CRUISE” indication lamp is illuminated. The vehicle will then maintain the desired speed.

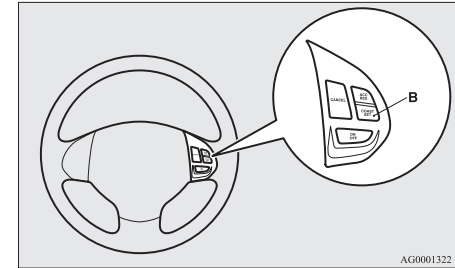

## NOTE

- When you release the “COAST SET” switch, the vehicle speed will be set.
- On vehicles equipped with Twin Clutch SST, it is not possible to set the vehicle speed while driving in 1<sup>st</sup> or 2<sup>nd</sup> gear.

## To increase the set speed

E00609400479

There are 2 ways to increase the set speed.

### “ACC RES” switch

Press and hold the “ACC RES” switch (C) while driving at the set speed, and your speed will then gradually increase.

## Starting and driving

When you reach your desired speed, release the switch. Your new cruising speed is now set.

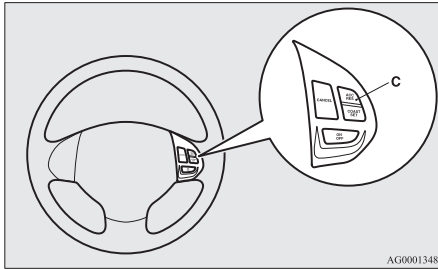

To increase your speed in small amounts, press the “ACC RES” switch for less than about 1 second and release it.

Each time you press the “ACC RES” switch, your vehicle will go about 1.6 km/h (1 mph) faster.

### *Accelerator pedal*

While driving at the set speed, use the accelerator pedal to reach your desired speed and then press the “COAST SET” switch (B) and release the switch momentarily to set a new desired cruising speed.

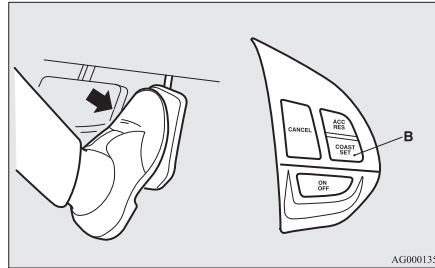

### **To decrease the set speed**

E00609500409

There are 2 ways to decrease the set speed.

#### *“COAST SET” switch*

Press and hold the “COAST SET” switch (B) while driving at the set speed, and your speed will slow down gradually.

When you reach your desired speed, release the switch. Your new cruising speed is now set.

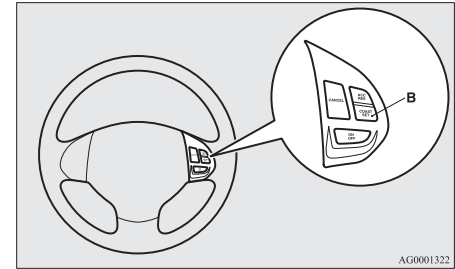

To slow down your speed in small amounts, press the “COAST SET” switch for less than about 1 second and release it.

Each time you press the “COAST SET” switch, your vehicle will slow down by about 1.6 km/h (1 mph).



**Brake pedal**

While driving at the set speed, use the brake pedal, which disengages the cruise control, then press the “COAST SET” switch (B) and release the switch momentarily to set a new desired cruising speed.

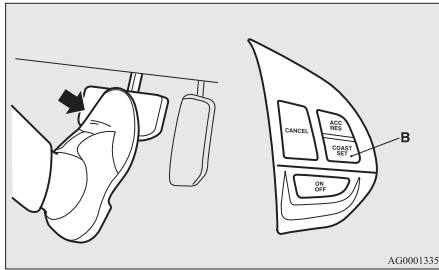
**To temporarily increase or decrease the speed**

E00609600149

**To temporarily increase the speed**

Depress the accelerator pedal as you would normally. When you release the pedal, you will return to your set speed.

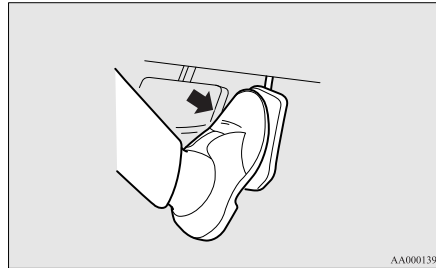
**NOTE**

- In some driving conditions, the set speed driving may be deactivated. If this happens, refer to “To activate” on page 4-61 and repeat the speed setting procedure.

**To temporarily decrease the speed**

Depress the brake pedal to decrease the speed. To return to the previously set speed, press the “ACC RES” switch (C).

Refer to “To resume the set speed” on page 4-64.

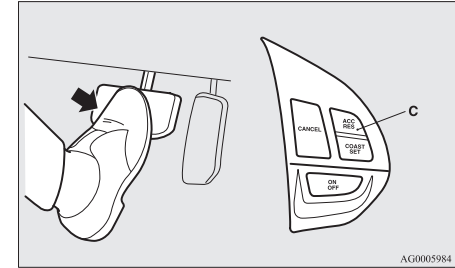
**To deactivate**

E00609701046

The set speed driving can be deactivated as follows:

- Press the “ON OFF” switch (A) (Cruise control will be turned off)
- Press the “CANCEL” switch (D).
- Depress the brake pedal.

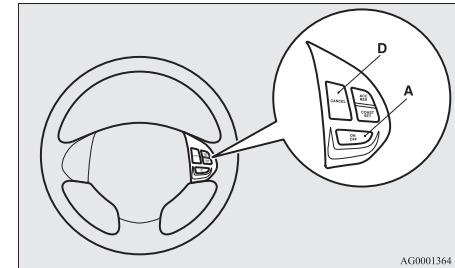

The set speed driving is deactivated automatically in any of the following ways.

## Starting and driving

- When you depress the clutch pedal (on vehicles with M/T).
- When your speed slows to about 15 km/h (9 mph) or more below the set speed because of a hill, etc. (except 2000 models)
- When your speed slows to about 40 km/h (25 mph) or less.
- When the Active Stability Control (ASC) starts operating. (if so equipped)  
Refer to “Active stability control (ASC)” on page 4-58.
- When you shift the 2<sup>nd</sup> gear in manual shifting (on vehicles equipped with Twin clutch SST).

## **⚠ WARNING**

- **On vehicles equipped with A/T, CVT or Twin Clutch SST, although the set speed driving will be deactivated when shifting to the “N” (NEUTRAL) position, never move the selector lever (A/T or CVT) or the gearshift lever (Twin Clutch SST) to the “N” (NEUTRAL) position while driving. You would have no engine braking and could cause a serious accident.**

Also, the set speed driving may be deactivated as follows:

- When the engine speed rises and approaches the tachometer's red zone (the red-coloured part of the tachometer dial).

## **⚠ CAUTION**

- **When the set speed driving is deactivated automatically in any situation other than those listed above, there may be a system malfunction. Press the “ON-OFF” switch to turn off the cruise control and have your vehicle inspected by a MITSUBISHI MOTORS Authorized Service Point.**

## To resume the set speed

E00609800457

If the set speed driving is deactivated by the condition described in “To deactivate” on page 4-63, you can resume the previously set speed by pressing the “ACC RES” switch (C) while driving at a speed of about 40 km/h (25 mph) or higher.

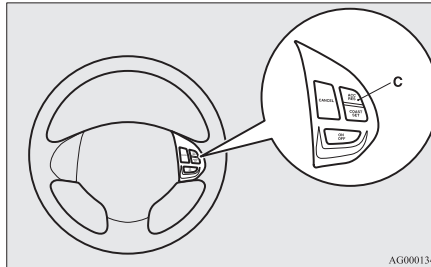

Under either of the following conditions, however, using the switch does not allow you to resume the previously set speed.

In these situations, repeat the speed setting procedure:

- The “ON OFF” switch is pressed.

- The ignition switch is turned OFF.
- “CRUISE” indication lamp is turned OFF.

## Reversing sensor system\*

E00615500303

This system operates when you are backing the vehicle. It uses corner and back sensors to detect an obstacle and the information screen in the multi-information display and the buzzer to inform you of the approximate distance to the obstacle.

### **A** CAUTION

- The reversing sensor system assists you in determining the approximate distance between the vehicle and an obstacle located behind the vehicle. It has limitations in terms of detectable areas and objects, and may not properly detect some objects. Therefore, do not place excessive confidence in the reversing sensor system and operate the vehicle as carefully as you would do with a vehicle not equipped with this system.
- Make sure to check the surroundings with your own eyes to ensure safety. Do not operate the vehicle by relying on the reversing sensor system alone.

## Obstacle detection areas

E00615600375

The detection areas of the corner and back sensors are limited to those shown in the illustration. Moreover, the sensors are unable to detect low or thin objects or objects near the rear bumper. Thus, make sure to check the surroundings as you operate the vehicle in a safe manner.

### Corner and back sensor locations

There are two corner sensors (A) at the corners of the rear bumper, and two back sensors (B) in the centre of the rear bumper.

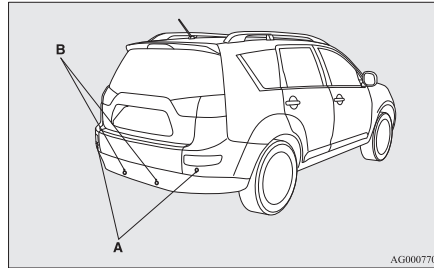

### Reversing sensor system detection areas

Depending on whether the vehicle is equipped with a towing bar, you can change the reversing sensor system between the standard mode and the towing bar mode. The towing bar mode changes the system to exclude the area in which the towing bar is mounted from the detection areas.

### Vehicles without a towing bar

The detection areas are within approximately 60 cm (A) from the corner sensors, 150 cm (B) from the back sensors, and 60 cm (C) or less from the ground surface, excluding the area approximately 10 cm (D) from the ground surface.

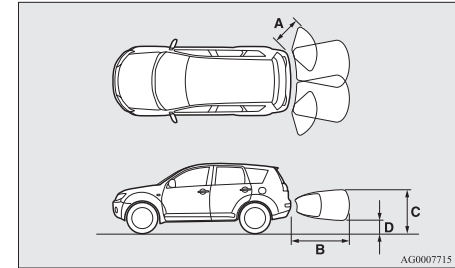

## Starting and driving

### Vehicles with a towing bar

The detection areas are within approximately 60 cm (A) from the corner sensors, 150 cm (B) from the back sensors, and 60 cm (C) or less from the ground surface, excluding the area approximately 10 cm (D) from the ground surface. The non-detection areas (E) are within approximately 20 cm (F) from the bumper.

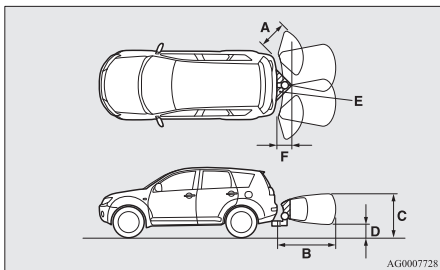

4

### NOTE

- If the rear bumper has been exposed to an impact, the corner or back sensors may fail and prevent the system from functioning properly. Have the vehicle inspected at a MITSUBISHI MOTORS Authorized Service Point.
- The sensors do not detect objects located in the area directly below or near the bumper. If the height of an object is lower than the mounted position of the corner or back sensors, the sensors may not continue detecting it even if they detected it initially.

For information on how to change the detection areas, please refer to “Changing the detection areas” on page 4-67.

## **⚠ CAUTION**

- **The reversing sensor system may not operate properly under the following conditions:**
  - The sensors or surroundings are covered with ice, snow, or mud.
  - The sensors are frozen.
  - The system receives ultrasonic noise from other sources (the horns of other vehicles, motorcycle engines, brakes, radios, pouring rain, splashing water, tyre chains, etc.).
  - The sensors are extremely hot or cold (while the vehicle is parked for a long period of time under a blazing sun or in cold weather).
  - The vehicle tilts significantly.
  - The vehicle is driven on a rough road (with a bumpy, gravel, hilly, or grassy surface).
  - The vehicle is too close to an obstacle.
  - The sensors or surroundings have been wiped by hand, or stickers or accessories have been attached.
- **The reversing sensor system may not properly detect the following:**
  - Objects that are thin, such as wire nets or ropes.
  - Objects that absorb sound waves, such as snow.
  - Objects that are shaped with a sharp angle.
  - Objects with a smooth surface, such as glass.
  - Objects that are low, such as kerbstones.

### NOTE

- The buzzer may sound lower than the normal warning sound when the reversing sensor system is receiving ultrasonic noise from other sources, but this is not a malfunction. The buzzer will stop sounding and the system will return to normal operation after the noise is no longer received.

## To operate

E00615700608

To operate the system, move the gearshift lever or selector lever to the “R” position while the ignition switch is in the “ON” position. When the reversing sensor system is operated, the reversing sensor system operation indication lamp (A) will turn on. To stop the operation, push the “SONAR” switch; the reversing sensor system operation indication lamp (A) is turned off.

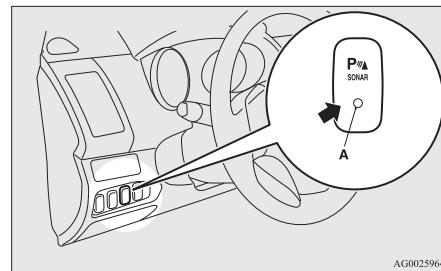

## NOTE

- Only when the gearshift lever or selector lever is in the “R” position, the reversing sensor system can be operated or be stopped by using the “SONAR” switch.

**Warning for obstacles**

If there is an obstacle behind the vehicle, a warning will be issued with the information screen in the multi-information display and a warning buzzer.

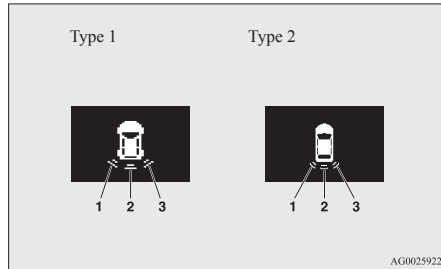

- 1- Corner sensor (left)
- 2- Back sensor
- 3- Corner sensor (right)

**Corner sensor**

Vehicle to obstacle distance	Warning display/sound cycle
Approx. 60 to 40 cm	Intermittent
Approx. 40 to 20 cm	Fast intermittent
Within approx. 20 cm	Continuous

**Back sensor (vehicles without a towing bar)**

Vehicle to obstacle distance	Warning display/sound cycle
Approx. 150 to 80 cm	Intermittent
Approx. 80 to 40 cm	Fast intermittent
Within approx. 40 cm	Continuous

**Back sensor (vehicles with a towing bar)**

Vehicle to obstacle distance	Warning display/sound cycle
Approx. 150 to 100 cm	Intermittent
Approx. 100 to 60 cm	Fast intermittent
Within approx. 60 cm	Continuous

**CAUTION**

- The distances given are to be used for reference only, as errors may be caused by various factors, such as temperature, humidity, or the shape of the obstacles.

## NOTE

- When the sensors detect different obstacles at the same time, the information screen in the multi-information display indicates the directions of the obstacles each sensor is detecting. However, closer obstacles are given priority over other detected obstacles and the warning buzzer sounds to inform you of closer obstacles.

**Changing the detection areas**

E00615800159

The detection areas can be changed as follows:

**Vehicles with a towing bar**

While the operation of the system is stopped at the “SONAR” switch, push the “SONAR” switch approximately 3 seconds or more, and release it. The buzzer sounds twice to indicate that the detection area has been changed.

**Vehicles without a towing bar**

While the operation of the system is stopped at the “SONAR” switch, push the “SONAR” switch approximately 3 seconds or more, and release it. The buzzer sounds once to indicate that the detection area has been changed.

## NOTE

- The detection area will not change if you keep the “SONAR” switch pushed for 10 seconds or more.
- After pushing the “SONAR” switch, reversing sensor system operation differs according to the detection area setting.
  - Setting when towing bar is not equipped  
When the gearshift lever or selector lever is moved to the “R” position, the reversing sensor system will operate even if corner sensor operation was stopped by pushing the “SONAR” switch.

## Starting and driving

- Setting when towing bar is equipped  
When reversing sensor system operation was stopped by pushing the “SONAR” switch, the reversing sensor system will not operate until the engine has been stopped even if the gearshift lever or selector lever is moved to the “R” position.  
To resume reversing sensor system operation, push the “SONAR” switch or stop and restart the engine, and then move the gearshift lever or selector lever to the “R” position.

## Reversing sensor system warning display

E00615900277

In case there is a malfunction in the reversing sensor system, the display for the malfunctioning sensor will blink and the warning buzzer will sound for approximately 5 seconds. Even after the buzzer has stopped sounding, the display will continue blinking until the system reverts to the normal state. Have the vehicle inspected at a MITSUBISHI MOTORS Authorized Service Point.

Example: Corner sensor (left) malfunctioning

Type 1

Type 2



AG0025935

## Rear-view camera\*

E00618400127

The rear-view camera is a system that shows the view behind the vehicle on a screen in the centre panel.

### **⚠ CAUTION**

- The rear-view camera is an assistance system that enables the driver to check for obstacles behind the vehicle. Its range of view is limited, so you should not overly depend on it. Please drive just as carefully as you would if the vehicle did not have the rear-view camera.
- Be sure to visually confirm safety around the vehicle with your own eyes. Do not depend entirely on the rear-view camera.

## Range of view of rear-view camera

The range of view of the rear-view camera is limited to the area shown in the illustrations. It cannot show both sides and the lower part of the rear bumper, etc.

When reversing, be sure to visually confirm safety around the vehicle.

## Location of rear-view camera

The rear-view camera (A) is integrated into the part near the tailgate handle.

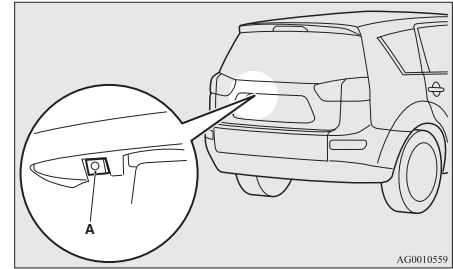

AG0010559

## Range of view of rear-view camera

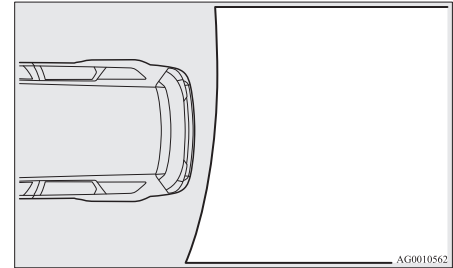

AG0010562

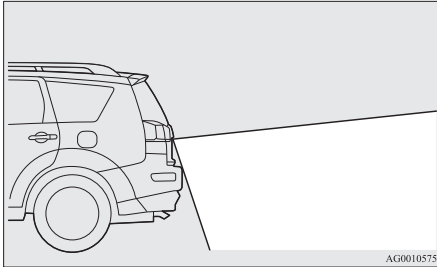

### How to use the rear-view camera

When you place the gearshift lever or selector lever to the “R” position with the ignition switch in the “ON” position, the view behind the vehicle will automatically appear on the screen of the MITSUBISHI Multi Communication System (MMCS). When you move the gearshift lever or the selector lever to any other position, the screen will return to its original indication.

#### Example of rear-view camera screen indication

The lines (E and F) in the view from the rear-view camera have the meanings shown below. Please use them as guides.

- Red: The point approximately 50 cm behind the vehicle
- Green: The point approximately 20 cm beyond the width of the vehicle on either side

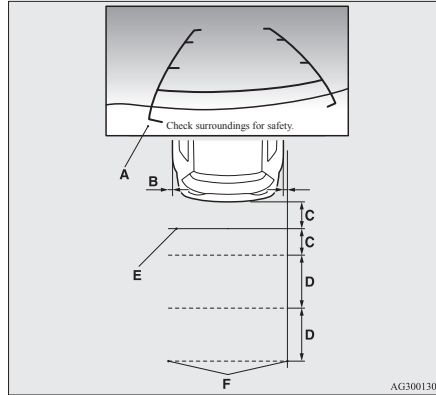

- A: Upper part of the rear bumper
- B: Approx. 20 cm
- C: Approx. 50 cm
- D: Approx. 1 m
- E: Line (red)
- F: Line (green)

### CAUTION

- The rear-view camera has a special lens that can make objects shown on the screen appear to be closer or further away than they actually are.

### NOTE

- It is possible to set the display language of the screen to English, Spanish, French, German, Italian, Swedish, Dutch, Danish or Portuguese. For details, please refer to the separate owner's manual for “MITSUBISHI Multi Communication System (MMCS)”.
- When the vehicle is tilting because of the number of people in the vehicle, the weight and positioning of luggage, and/or the condition of the road surface, the lines in the view from the rear-view camera may not be accurately positioned relative to the actual road.
- The lines in the view from the rear-view camera are based on a level, flat road surface. Do not use them as a guide for distances to solid objects.
- Because the rear-view camera has a special lens, the lines on the ground between parking spaces may not look parallel on the screen.
- In the following situations, the screen indication may be difficult to see. There is no abnormality.
  - Low light (nighttime)
  - When the light of the sun or the light from a vehicle's headlamps shines directly into the lens
    - When an extremely bright spot is shown on the screen, colour smearing\* (a characteristic of CCD cameras) can occur.
- Colour smearing: When an extremely bright spot (for example, sunlight that has reflected off the bumper) is shown on the screen, it appears to leave a vertical trail.
- If the camera is hot and is then cooled by rain or a car wash, the lens can mist up. This phenomenon does not indicate a malfunction.

## Starting and driving

- It is not possible to fully see obstacles when the lens is dirty. If the lens becomes contaminated by water droplets, snow, mud or oil, wipe off the contamination, taking care not to scratch the lens.
- Please observe the following cautions. Ignoring them could lead to a camera malfunction.
  - Do not subject the camera to physical shock.
  - Do not apply wax to the camera.
  - Do not splash the camera with boiling water.
  - Do not disassemble the camera.

## Cargo loads

E00609901325

### Cargo loads precautions

#### **⚠ CAUTION**

- **Do not load cargo or luggage higher than the top of the seatback. Be sure that your cargo or luggage cannot move once your vehicle is moving. Having the driver's vision blocked, and your cargo being thrown inside the cabin if you suddenly have to brake can cause a serious accident or injury.**
- **Load heavy cargo or luggage in the front of the vehicle.**  
**If the load in the back of the vehicle is too heavy, steering may become unstable.**

### Loading a roof carrier

#### **⚠ CAUTION**

- **Use a roof carrier that properly fits your vehicle. Do not load luggage directly onto the roof.**  
**For installation, refer to the instruction manual accompanying the roof carrier.**

### NOTE

- We recommend you to use a genuine MITSUBISHI roof carrier, since the brackets to be used have a special shape. For details, we recommend you to consult a MITSUBISHI MOTORS Authorized Service Point.

### Roof carrier mounting brackets\*

When installing the roof carrier, use the brackets (A). The brackets (A) are located under each cover (B).

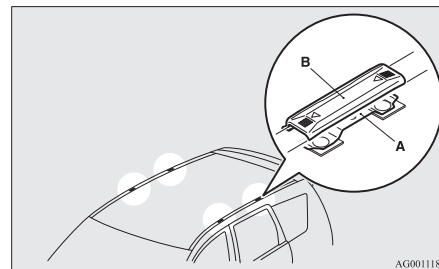

AG0011181



**Attaching the roof carrier**

Slide each cover (B) towards the front of the vehicle to remove it.

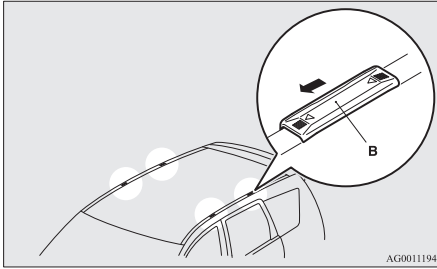
**Refitting the covers**

1. With each cover, put the tabs (C) on the cover in the holes (D) in the roof.
2. Slide the cover (B) towards the rear of the vehicle to install it.

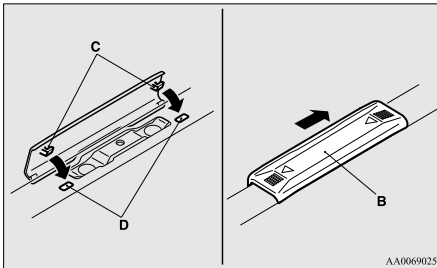
**Roof carrier precaution**

### CAUTION

- **Make sure that the weight of the luggage does not exceed the allowable roof load. If the allowable roof load is exceeded, this may cause damage to the vehicle.**  
The roof load is the total allowable load on the roof (the weight of the roof carrier plus the weight of luggage placed on the roof carrier).  
For the specific value, refer to “Maximum roof load” on page 9-08.
- **When luggage is loaded onto the vehicle, please make sure to drive slowly and avoid excessive manoeuvres such as sudden braking or quick turning.**  
In addition, place the luggage on the carrier so that its weight is distributed evenly with the heaviest items on the bottom. Do not load items that are wider than the roof carrier.  
The additional weight on the roof could raise the vehicle’s centre of gravity and affect vehicle handling characteristics. As a result, driving errors or emergency manoeuvres could lead to a loss of control and result in an accident.
- **Before driving and after travelling a short distance, always check the load to make sure it is securely fastened to the roof carrier.**  
Check periodically during your travel that the load remains secure.

**NOTE**

- To prevent wind noise or reduction in fuel economy, remove the roof carrier when not in use.
- Remove the roof carrier before using an automatic car wash.
- Be sure that adequate clearance is maintained for raising the sunroof (if so equipped) and/or the tailgate when installing a roof carrier.

## Starting and driving

### Trailer towing

E00610000518

In order to tow a trailer with your vehicle, when having a trailer towing device mounted that meets all relevant regulations in your area, consult a MITSUBISHI MOTORS Authorized Service Point. The regulations concerning the towing of a trailer may differ from country to country. You are advised to obey the regulations in each area.

#### **CAUTION**

- **Danger of Accident!**  
A towing bar should be fitted according to MITSUBISHI MOTORS guidelines.

### Maximum towable weight with brake and maximum trailer-nose weight

Never exceed the maximum towable weight with brake and the maximum trailer-nose weight as listed in the specifications.

(Refer to page 9-08.)

If you tow a trailer at an altitude of more than 1,000 m above sea-level, reduce your weight by 10 % of the gross combination weight for every increase of 1,000 m above sea-level, as the engine output is lowered owing to decrease in atmospheric pressure.

### Towing bar mounting specifications

See the following table for fixing points (A) for the towing bar.

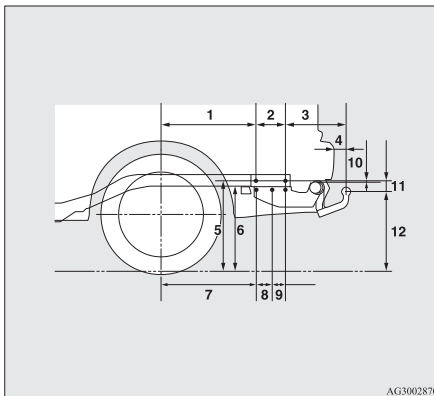

AG3002870

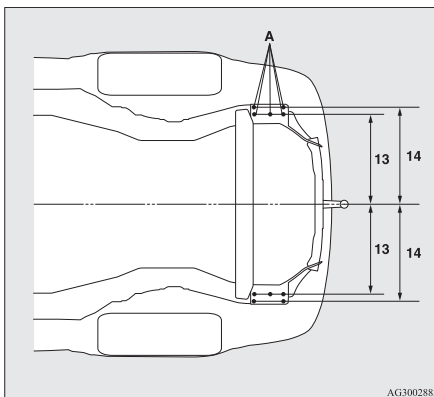

AG3002883

1	553 mm
2	171 mm
3	356 mm
4	68 mm <sup>*1, *2</sup> , 70 mm <sup>*3</sup> (at laden condition)
5	540 mm <sup>*3, *1</sup> , 562 mm <sup>*2</sup> (at kerb weight condition)
6	504 mm <sup>*3, *1</sup> , 525 mm <sup>*2</sup> (at kerb weight condition)
7	555 mm
8	92 mm
9	77 mm
10	2 mm
11	62 mm
12	482 mm <sup>*3, *1</sup> , 507 mm <sup>*2</sup> (at kerb weight condition)
	387 mm to 405 mm <sup>*3</sup> , 361 mm to 389 mm <sup>*1</sup> , 363 mm to 382 mm <sup>*2</sup> (at laden condition)
13	528 mm
14	560 mm

\*1: Vehicles equipped with heavy duty suspension

\*2: Vehicles equipped with high ground suspension

\*3: Vehicles equipped with normal suspension

## NOTE

- The values under item 12 can be varied depending on the loading condition of cargo or luggage.

## Operating hints

- To prevent the clutch from slipping (Vehicle with a M/T only), do not rev the engine more than is required when starting off.
- Be sure that the driving speed does not exceed 100 km/h (62 mph) for trailer operation. It is also recommended that you obey the local regulations in case driving speed with a trailer is limited to less than 100 km/h (62 mph).
- To prevent shocks from the overrun brake, depress the brake pedal lightly at first and then more strongly.
- To make full use of engine braking, change to a lower shift point before descending a slope.

*Additional precautions for vehicles equipped with an A/T, CVT or Twin Clutch SST*

It is recommended the “D” position on slopes or at low speed.

Use the sports mode (A/T or CVT) or manual shifting (Twin Clutch SST) in mountainous areas in order to make better use of engine braking and to assist the brake system. However, be sure that the speed does not exceed the maximum speed limit for the selected shift position.

*Overheating*

This will normally occur as a result of some mechanical failure. If your vehicle should overheat, stop and check for a loose or broken water pump/alternator drive belt, a blocked radiator air intake or a low coolant level. If these items are satisfactory the overheating could be caused by a number of mechanical causes that would have to be checked at a competent service centre.

 **CAUTION**

- If the engine overheats, please refer to the “Engine overheating” section of “For emergencies” prior to taking any corrective action.
- On vehicles equipped with A/T, CVT or Twin Clutch SST, if the  warning display is showing, the temperature of the automatic transmission fluid, CVT fluid or Twin Clutch SST fluid is high. Read the reference page and take the required measures. Refer to “When a malfunction occurs in the A/T” on page 4-28, “When a malfunction occurs in the CVT” on page 4-34 or “Warning display” on page 4-43.

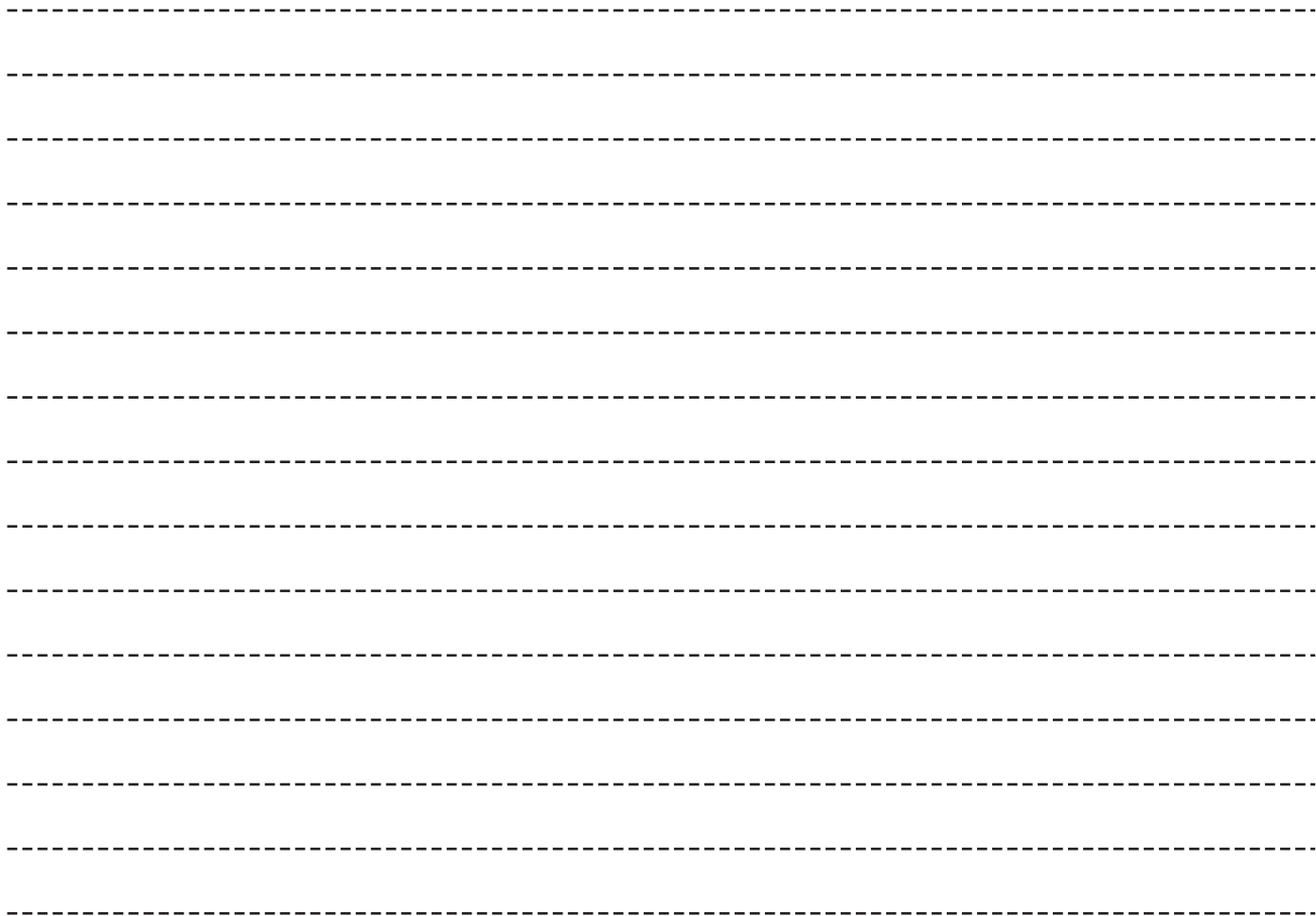

## *For pleasant driving*

Ventilators.....	5-02
Automatic air conditioning.....	5-04
Important operation tips for the air conditioning.....	5-09
Air purifier.....	5-09
LW/MW/FM digital tuning radio with CD player*.....	5-10
LW/MW/FM digital tuning radio with CD changer*.....	5-24
To play tracks from USB device*.....	5-39
To play tracks from a Bluetooth® device (vehicles with Bluetooth® 2.0 interface).....	5-49
To use the external audio input function*.....	5-52
To listen to a disc in the rear-seat display (vehicles with rear-seat display).....	5-53
Steering wheel audio remote control switches*.....	5-53
Error codes.....	5-55
Error codes (iPod).....	5-57
Error codes (USB memory device).....	5-58
Handling of compact discs.....	5-60
Antenna.....	5-61
Digital clock*.....	5-62
Link System*.....	5-64
Bluetooth® 2.0 interface*.....	5-64
USB input terminal*.....	5-80
Sun visors.....	5-82
Ashtray*.....	5-83
Cigarette lighter*.....	5-83
Accessory socket.....	5-84
Interior lamps.....	5-85
Storage spaces.....	5-87
Cup holder.....	5-91
Bottle holder.....	5-92

Cargo area cover*.....	5-93
Assist grips.....	5-94
Coat hook.....	5-94
Luggage hooks.....	5-94

## For pleasant driving

### Ventilators

E00700100908

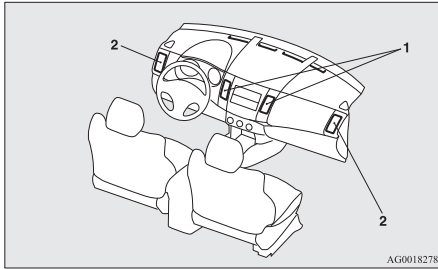

- 1- Centre ventilators
- 2- Side ventilators

#### NOTE

- Do not place beverages on top of the instrument panel. If they splash into the air conditioning ventilators, they could damage the system.

### Air flow and direction adjustments

E00700200534

#### Centre ventilators

Move the knob (A) to adjust the air flow direction.

To close the ventilator, fully move the knob (A) to the inner side.

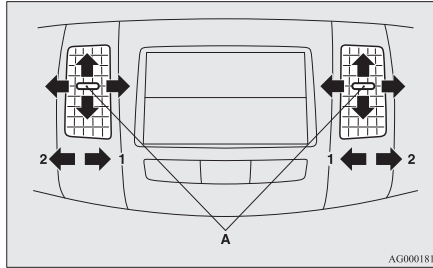

- 1- Close
- 2- Open

#### Side ventilators

Move the knob (A) to adjust the air flow direction. To close the ventilator, fully move the knob (A) to the outer side.

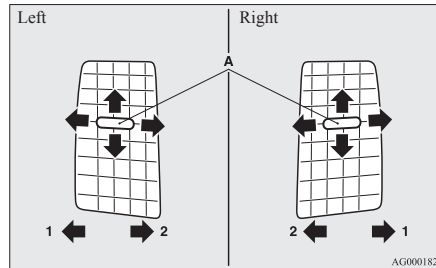

- 1- Close
- 2- Open

#### NOTE

- The cool air from the ventilators may appear as a mist. This is due to moist air being suddenly cooled by the air conditioning. This will clear after a few moments.
- Be careful not to spill drinks, etc., into the ventilators. Doing so might cause the air conditioning not to function normally.

#### Mode selection dial

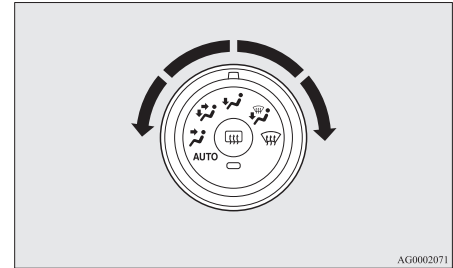

E00726500333

To change the amount of air flowing from the ventilators, turn the mode selection dial.



AG0002071

### CAUTION

- When using the mode selection dial between the “” and “” positions, prevent fogging by pressing the air selection switch to select outside air. (Refer to “Air selection switch” on page 5-05.)

### Changing the mode selection

E00700301301

To change the position and amount of air flowing from the ventilators, turn the mode selection dial. (Refer to “Mode selection dial” on page 5-02.) These symbols are used in the next several illustrations to demonstrate the quantity of air coming from the ventilators.

- : Small amount of air from the ventilators
- ➔: Medium amount of air from the ventilators
- : Large amount of air from the ventilators

#### Face position

Air flows only to the upper part of the passenger compartment.

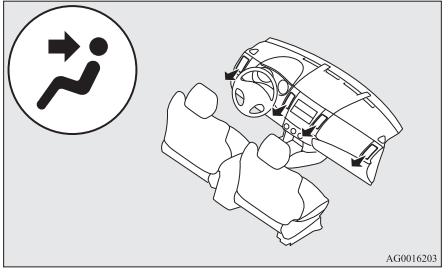

#### Foot/Face position

Air flows to the upper part of the passenger compartment, and flows to the leg area.

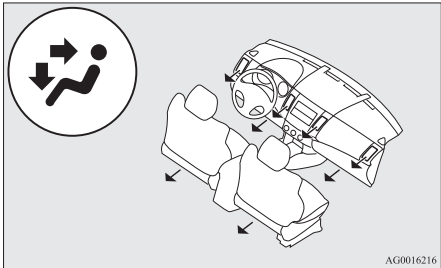

#### NOTE

- With the mode selection dial between the “” and “” positions, air flows mainly to the upper part of the passenger compartment. With the mode selection dial between the “” and “” positions, air flows mainly to the leg area.

#### Foot position

Air flows mainly to the leg area.

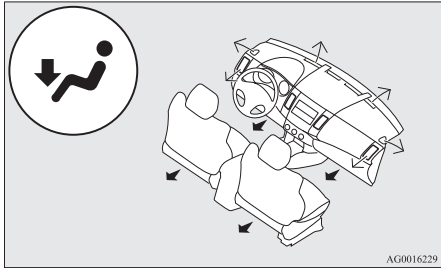

#### Foot/Demister position

Air flows to the leg area, the windscreen and the door windows.

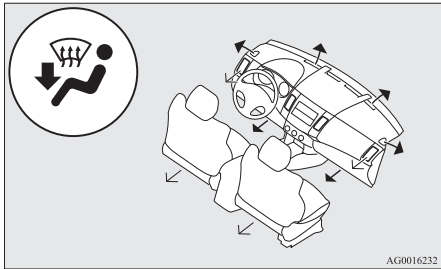

## For pleasant driving

### NOTE

- With the mode selection dial between the “” and “” positions, air flows mainly to the leg area. With the mode selection dial between the “” and “” positions, air flows mainly to the windscreen and door windows.

### Demister position

Air flows mainly to the windscreen and the door windows.

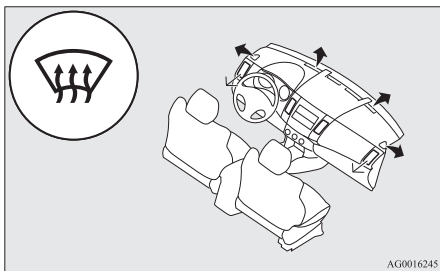

## Automatic air conditioning

E00702400383

The air conditioning can only be used while the engine is running.

### Control panel

E00702500674

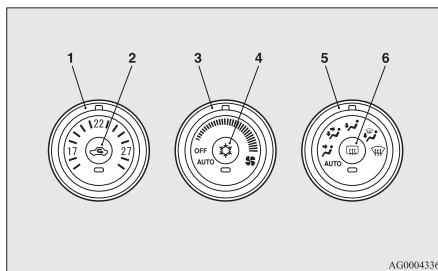

- 1- Temperature control dial
- 2- Air selection switch
- 3- Blower speed selection dial
- 4- Air conditioning switch
- 5- Mode selection dial
- 6- Rear window demister switch → p. 3-57

### NOTE

- There is an interior air temperature sensor (A) in the illustrated position. Never place anything on top of the sensor, since doing so will prevent it from functioning properly.

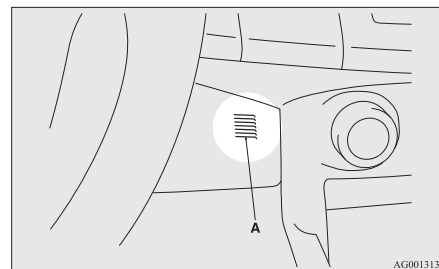

### Blower speed selection dial

E00702800172

Select the blower speed by turning the blower speed selection dial clockwise or anticlockwise. Turn the dial clockwise to increase the air flow and anticlockwise to decrease the air flow.

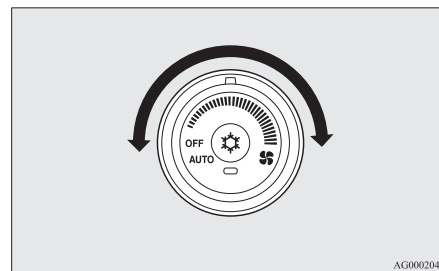



**Temperature control dial**

E00703000227

Turn the temperature control dial clockwise or anti-clockwise.



AG0004349

**NOTE**

- While the engine coolant temperature is low, the temperature of the air from the heater will be cool/cold until the engine warms up, even if you have selected warm air with the dial.
- When the temperature is set to the highest or the lowest setting under the AUTO operation, the air selection and the air conditioning will be automatically changed as follows.
  - Quick Heating (When the temperature is set to the highest setting)  
Outside air will be introduced and the air conditioning will stop.
  - Quick Cooling (When the temperature is set to the lowest setting)  
Inside air will be recirculated and the air conditioning will operate.

The settings described above are the factory settings. The air selection and air conditioning switches can be customized (function setting changed), and the automatic switching of outside air and the air conditioning according to operating conditions can be changed as desired.

For further information, we recommend you to consult a MITSUBISHI MOTORS Authorized Service Point.

Refer to “Customizing the air conditioning switch (Changing function settings)” on page 5-06.

Refer to “Customizing the air selection (Changing function settings)” on page 5-05.

**Air selection switch**

E00703400755

To change the air selection, simply press the air selection switch. There is a sound each time the switch is pressed.

- Outside air: Indication lamp (A) is OFF  
Outside air is introduced into the passenger compartment.
- Recirculated air: Indication lamp (A) is ON  
Air is recirculated inside the passenger compartment.

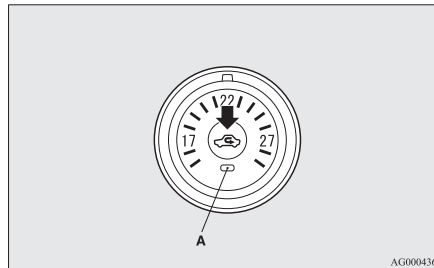

AG0004365

**CAUTION**

- Normally, use the outside position to keep the windscreen and side windows clear and quickly remove fog or frost from the windscreen.  
If high cooling performance is desired, or if the outside air is dusty or otherwise contaminated use the recirculation position. Switch to the outside position periodically to increase ventilation so that the windows do not become fogged up.
- Use of the recirculation position for extended time may cause the windows to fog up.

**NOTE**

- When the mode selection dial or the blower speed selection dial is set to the “AUTO” position again after manual operation, the air selection switch will also be automatically controlled.
- When the engine coolant temperature rises to a certain level, the air selection is automatically switched to the recirculation position and the indication lamp (A) comes on. At this time, the system will not switch to the outside position even if the air selection switch is pushed.

**Customizing the air selection (Changing function settings)**

E00725800111

Functions can be changed as desired, as stated below.

## For pleasant driving

- Enable automatic air control:  
If the mode selection dial or blower speed selection dial is turned to the “AUTO” position, the air selection switch is also controlled automatically.
- Disable automatic air control:  
Even if the mode selection dial or blower speed selection dial is turned to the “AUTO” position, the air selection switch is not controlled automatically.
- Setting change method  
Hold down the air selection switch for about 10 seconds or more.  
When the setting is changed, a sound is emitted and the indication lamp flashes.
  - When the setting is changed from enable to disable 3 sounds are emitted and the indication lamp flashes 3 times.
  - When the setting is changed from disable to enable 2 sounds are emitted and the indication lamp flashes 3 times.

### NOTE

- The factory setting is “Enable automatic air control.”
- When the mode selection dial is turned to “”, in order to prevent misting of the windows the ventilator automatically switches to outside air even if “Disable automatic air control” is set.

### Air conditioning switch

E00703501229

Push the switch to turn the air conditioning on, indicator lamp (A) will come on.

There is a sound each time the switch is pressed.

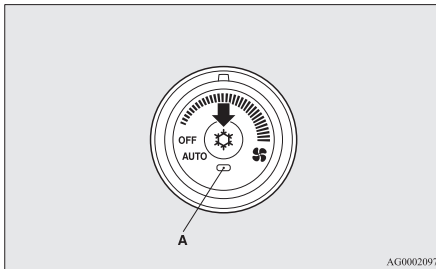

Push the switch again to switch it off.

### CAUTION

- When using the air conditioning, the idling speed may slightly increase as the air conditioning compressor is switched on/off automatically. While the vehicle with an A/T, CVT or Twin Clutch SST is stationary, fully depress the brake pedal to prevent the vehicle from creeping.

### NOTE

- If a problem is detected in the air conditioning system, the air conditioning operation indication lamp (A) blinks. Press the air conditioning switch once to turn it off, then once more to turn it back on. If the air conditioning operation indication lamp does not blink for a while, there is nothing wrong. If it starts to blink again, we recommend you to have it checked.
- Sometimes, for example after using a high-pressure car wash, the condenser can get wet with water, and the operation indication lamp (A) blinks temporarily. In this case there is nothing wrong. Wait for a while, press the air conditioning switch once to turn the system off, then once more to turn it back on. Once the water evaporates, the blinking will stop.

### Customizing the air conditioning switch (Changing function settings)

E00725900011

Functions can be changed as desired, as stated below.

- Enable automatic air conditioning control:  
If the mode selection dial or blower speed selection dial is turned to the “AUTO” position, or the temperature control dial is set to the minimum temperature, the air conditioning switch is controlled automatically.
- Disable automatic air conditioning control:  
The air conditioning switch is not controlled automatically as long as the air conditioning switch is not operated.
- Setting change method  
Hold down the air conditioning switch for about 10 seconds or more.

When the setting is changed, a sound is emitted and the indication lamp flashes.

- When the setting is changed from enable to disable 3 sounds are emitted and the indication lamp flashes 3 times.
- When the setting is changed from disable to enable 2 sounds are emitted and the indication lamp flashes 3 times.

**NOTE**

- The factory setting is “Enable automatic air conditioning control”.
- When you turn the mode selection dial to “”, in order to prevent misting of the windows the air conditioning operates automatically even if “Disable automatic air conditioning control” is set.

**Operating the system in automatic mode**

E00704101020

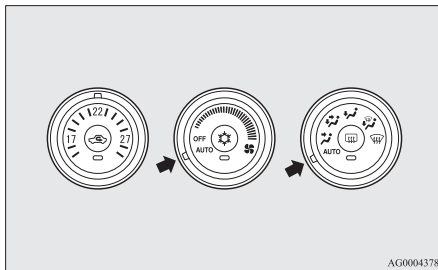

AG0004378

In normal conditions, use the system in the AUTO mode and follow these procedures:

1. Set the blower speed selection dial to the “AUTO” position.
2. Set the temperature control dial to the desired temperature.
3. Set the mode selection dial to the “AUTO” position.

The outlet position (except “”), recirculation/outside air select and blower speed, and ON/OFF of air conditioning will be controlled automatically.

To stop the system, turn the blower speed selection dial to the “OFF” position.

**CAUTION**

- When using the air conditioning, the idling speed may slightly increase as the air conditioning compressor is switched on/off automatically. While the vehicle with an A/T, CVT or Twin Clutch SST is stationary, fully depress the brake pedal to prevent the vehicle from creeping.

**NOTE**

- While the engine coolant temperature is low, the temperature of the air from the heater will be cool/cold until the engine warms up, even if you have selected warm air with the dial. To prevent the windscreen and windows from fogging up, the ventilator mode will be changed to “” and the blower speed will be reduced.

- If the blower speed selection dial, air conditioning switch, mode selection dial, or air selection switch is operated while the system is operating in the AUTO mode, the activated function overrides the corresponding function of automatic control. All other functions remain under automatic control.

**Operating the system in manual air mode**

E00704200167



Blower speed and ventilator mode may be controlled manually by setting the blower speed selection dial and the mode selection dial to the desired positions. To return to automatic operation, set the dials to the “AUTO” position.

*Demisting of the windscreen and door windows*

E00704300852

**CAUTION**

- For safety, make sure you have a clear view through all the windows.

Use the mode selection dial (“” or “”) to remove frost or mist from the windscreen or door windows.

## For pleasant driving

### For ordinary demisting

Perform the following settings to prevent misting of the windscreen and door windows, and to heat the leg area.

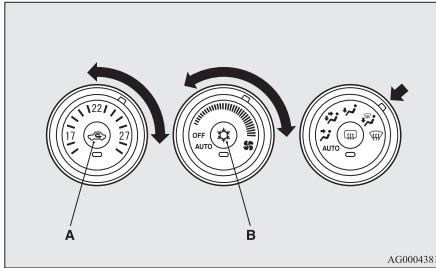

1. Set the air selection switch (A) to the outside position.
2. Set the mode selection dial to the “OFF AUTO” position.
3. Select your desired blower speed by turning the blower speed selection dial.
4. Select your desired temperature by turning the temperature control dial.
5. Push the air conditioning switch (B).

### For quick demisting

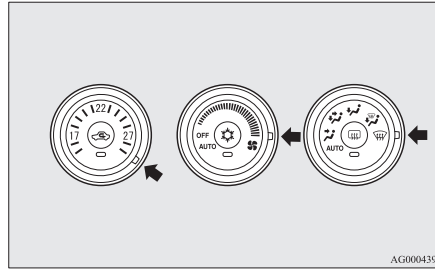

1. Set the mode selection dial to the “OFF AUTO” position.
2. Set the blower to the maximum speed.
3. Set the temperature to the highest position.

### NOTE

- When the mode selection dial is in the “OFF AUTO” position, the air conditioning operates automatically and outside air is set automatically.
- To demist effectively, direct the air flow from the side ventilators towards the door windows.
- Do not set the temperature control dial to the max. cool position. Cool air will blow against the window glasses and prevent demisting.

- For vehicles with the Auto Stop & Go (AS&G) system, if the mode selection dial is set to the demister position shown in the illustration, the Auto Stop & Go (AS&G) system will not operate and the engine will not stop automatically even if the vehicle is stopped. This is to ensure that good visibility is maintained.

## ***Important operation tips for the air conditioning***

E00708300762

- Park the vehicle in the shade. Parking in the hot sun will make the vehicle inside extremely hot, and it will require more time to cool the interior. If it is necessary to park in the sun, open the windows for the first few minutes of air conditioning operation to expel the hot air.
- Close the windows when the air conditioning is in use. The entry of outside air through open windows will reduce the cooling efficiency.
- Too much cooling is not good for the health. Keep the difference between the vehicle interior temperature and outside temperature to 5 to 6 °C.
- When operating the system, make sure the air intake, which is located in front of the windscreen, is free of obstructions such as leaves and snow. Leaves collected in the air-intake plenum may reduce air flow and plug the plenum water drains.

## **Air conditioning system refrigerant and lubricant recommendations**

If the air conditioning seems less effective than usual, the cause might be a refrigerant leak. We recommend you to have the system inspected.

The air conditioning system in your vehicle must be charged with the refrigerant HFC-134a and the lubricant SUN-PAG56.

Use of any other refrigerant or lubricant will cause severe damage which will result in the need to replace your vehicle's entire air conditioning system. The release of refrigerant into the atmosphere is not recommended.

The new refrigerant HFC-134a in your vehicle will not harm the ozone layer.

We recommend you to recover and recycle the refrigerant for reuse.

## **During a long period of disuse**

The air conditioning should be operated for at least five minutes each week, even in cold weather. This is to prevent the compressor from seizing and to maintain the air conditioning in the best operating condition.

## ***Air purifier***

E00708400561

An air filter has been incorporated into the air conditioning so that pollen and dust are cleaned from the air.

Replace the air filter periodically as its ability to clean the air will be reduced as it collects pollen and dirt. For the maintenance interval, refer to the "SERVICE BOOKLET".

## **NOTE**

- Operation in certain conditions such as driving on a dusty road and frequent use of the air conditioning can lead to reduction of service life of the filter. When you feel that the air flow is lower than normal or when the windscreen or windows start to fog up easily, replace the air filter.

We recommend you to have it checked.

## For pleasant driving

### LW/MW/FM digital tuning radio with CD player\*

E00708501859

The audio system can only be used when the ignition switch is in the “ON” or “ACC” position.

#### NOTE

- To listen to the audio system while the engine is stopped, turn the ignition switch to the “ACC” position. If the ignition switch is left in the “ACC” position, the accessory power will automatically turn off after a certain period of time and you will no longer be able to use the audio system. The accessory power comes on again if the ignition switch is turned from the “ACC” position. Refer to “ACC power auto-cutout function” on page 4-13.
- If a cellular phone is used inside the vehicle, it may create noise from the audio equipment. This does not mean that anything is wrong with your audio equipment. In such a case, use the cellular phone at a place as far away as possible from the audio equipment.
- If foreign objects or water get into the audio equipment, or if smoke or a strange odour comes from it, immediately turn off the audio system. We recommend you to have it checked. Never try to repair it by yourself. Avoid continuous usage without inspection by a qualified person.

### Volume and tone control panel

E00708600693

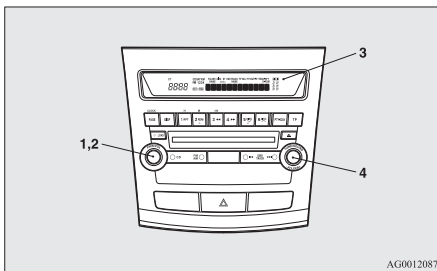

AG0012087

- 1- PWR (On-Off) switch
- 2- VOL (Volume control) knob
- 3- Display
- 4- SOUND (Sound control) switch

### To adjust the volume

E00708700258

#### VOL (Volume control)

Turn the VOL knob (2) clockwise to increase the volume; anticlockwise to decrease the volume.

### To adjust the tone

E00708800738

Press the SOUND switch (4) to select: TYPE → FIELD → BASS → MID → TREBLE → FADER → BALANCE → audio control mode OFF.

#### QUICK ACCESS MODE

To access the sound customization features quickly, push and hold the SOUND switch (4), then turn the switch clockwise or anticlockwise to access your desired sound customization setting. Release the switch to adjust the setting.

#### HOLD MODE

If the SOUND switch (4) is pushed and held for more than 2 seconds during the audio adjust mode, it will change to “Hold” mode. The selected audio mode will be held until the SOUND switch (4) is pushed for more than 2 seconds again.

#### TYPE (Acoustic characteristic selection)

1. Turn the SOUND switch (4) to select the desired music type.
2. Press the SOUND switch (4) to set the audio system to the selected music type.

Acoustic characteristics	Details
CLASSIC	The optimum acoustic characteristics for classical music, which requires an overall sound balance that is flat.
JAZZ	The optimum acoustic characteristics for jazz music, which requires an atmospheric sound that applies different modulations to the bass, mid-range, and treble.
POP	The optimum acoustic characteristics for pop music, which requires a crisp vocal sound with a modulated bass and treble.
ROCK	The optimum acoustic characteristics for rock music, which requires a sound with a sense of speed that emphasises the mid range.
HIP-HOP	The optimum acoustic characteristics for hip hop music, which requires a powerful sound that emphasises the bass.

**FIELD (Sound field selection)**

1. Turn the SOUND switch (4) to select the desired sound field.
2. Press the SOUND switch (4) to set the audio system to the selected sound field.

Sound field type	Details
NORMAL	This sound field produces a sound effect where the vocals are in the front and the instruments surround the listener.
STAGE	This sound field produces a sound effect where the vocals are right in front of the driver, as on a stage.
LIVE	This sound field produces a sound effect similar to a live venue, where the listener is wrapped in sound from all directions.
HALL	This sound field produces a sound effect similar to a concert hall with reverberating acoustics.

**BASS (Bass tone control)**

Turn the SOUND switch (4) to select the desired bass tone.

**MID (Midrange tone control)**

Turn the SOUND switch (4) to select the desired middle tone.

**TREBLE (Treble tone control)**

Turn the SOUND switch (4) to select the desired treble tone.

**FADER (Front/Rear balance control)**

Turn the SOUND switch (4) to balance volume from the front and rear speakers.

**BALANCE (Left/Right balance control)**

Turn the SOUND switch (4) to balance volume from the left and right speakers.

**NOTE**

- When set to 0, it will beep.
- When TYPE or FIELD is changed, the sound will cut out briefly, but this does not indicate a malfunction.
- The audio control mode will shut off if either the radio or CD is operated, or if no adjustment is made within about 10 seconds.

**SCV (Speed Compensated Volume) function**

E00726800088

SCV function is a feature that automatically adjusts the VOLUME, BASS, MID, and TREBLE settings in accordance with the vehicle speed. The SCV function can be turned ON and OFF. Refer to “Function setup mode” on page 5-17.

For pleasant driving

## Radio control panel and display

E00708900771

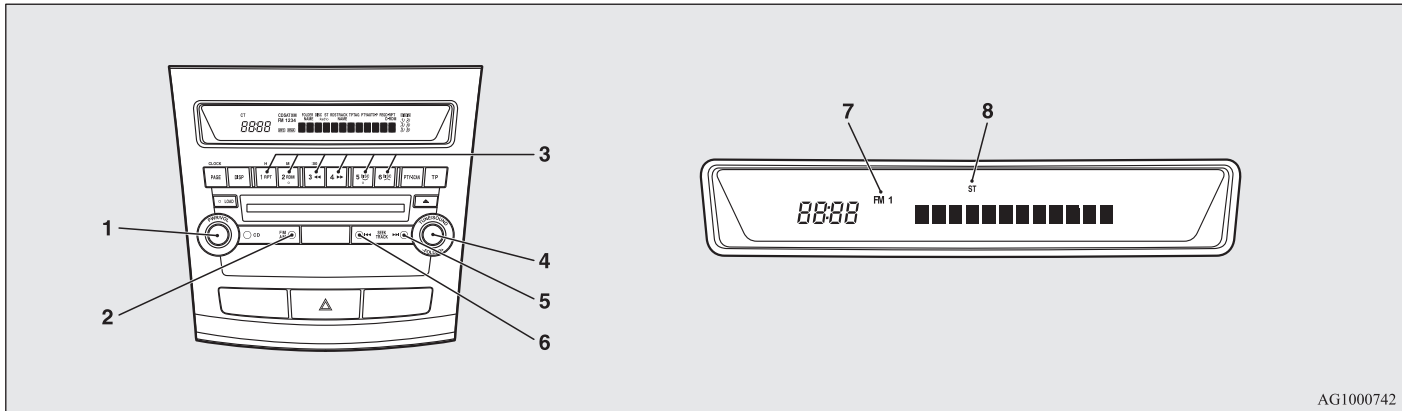

AG1000742

5

- 1- PWR (On-Off) switch
- 2- AM/FM (FM/MW/LW selection) button
- 3- Memory select buttons
- 4- TUNE switch

- 5- SEEK (Up-seek) button
- 6- SEEK (Down-seek) button
- 7- FM (FM1/FM2/FM3) indicator
- 8- ST (Stereo) indicator



## To listen to the radio

E00709000522

1. Press the PWR switch (1) or the AM/FM button (2) to turn ON the radio.  
Press the PWR switch again to turn OFF the radio.
2. Press the AM/FM button (2) to select the desired band.
3. Turn the TUNE switch (4), or press the SEEK button (5 or 6) or memory select buttons (3) to tune into a radio broadcasting station.

## To tune the radio

E00709100419

### Automatic tuning

After pressing the SEEK button (5 or 6), a receivable station will be automatically selected and reception of the station will begin.

### Manual tuning

The frequency changes every time the TUNE switch (4) is turned. Turn the switch to select the desired radio broadcasting station.

## To enter frequencies into the memory

E00716100831

### Manual setting

You can assign to the memory select buttons (3) a maximum of 18 stations in the FM band (6 FM1, 6 FM2 and 6 FM3 stations) and 6 stations each in the MW and LW band. (Stations already assigned to the memory select buttons are replaced by any newly assigned stations.)

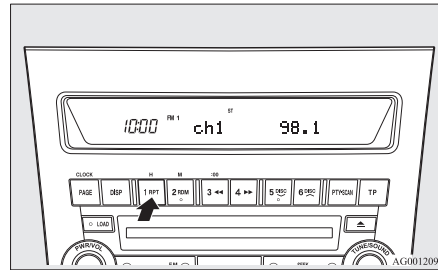

Follow the steps described below.

1. Press the SEEK button (5 or 6), or turn the TUNE switch (4) to tune to the frequency you wish to keep in the memory.
2. Press one of the memory select buttons (3) until it beeps.  
The sound will be momentarily interrupted while the frequency is being entered into the memory. The number of the button matching the entry in the memory as well as the frequency is displayed.
3. The preset memory setting is retrieved by pressing the button and then releasing it within 1 second.

## NOTE

- Disconnecting the battery terminal erases all the radio frequencies stored in the memory.

### Automatic setting

With the method, all manually set stations in the band currently selected for reception are replaced with stations in the same band that are automatically selected in order of signal strength.

The radio automatically selects 6 stations in the FM band (FM3 station only) and 6 stations each in the MW and LW band.

Follow the steps described below.

1. With the radio mode selected, hold down the AM/FM button (2) for 2 seconds or longer. The 6 stations with the best signal strength will automatically be assigned to the memory select buttons (3), with the lowest-frequency station being assigned to the lowest-number button.
2. When you subsequently press a memory select button to select a channel number, the radio will begin receiving the station assigned to that number.

## NOTE

- If you press the AM/FM button (2) for 2 seconds or longer while tuning in the FM1 or FM2 band, the radio will automatically switch to the FM3 band, where the automatic seeking/storing will be activated.

For pleasant driving

## Radio data system (RDS)

E00709200276

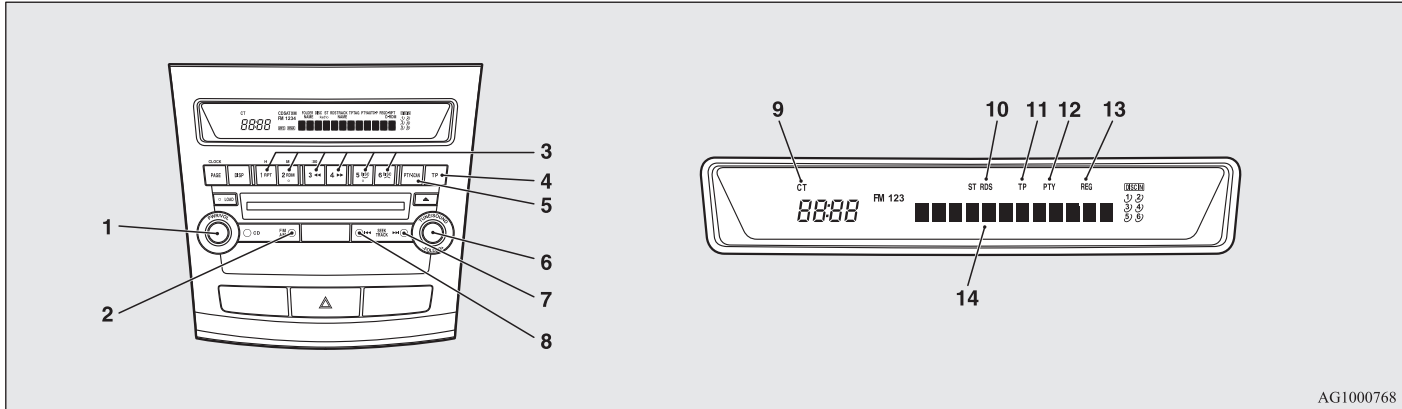

AG1000768

5

- 1- PWR (On-Off) switch
- 2- AM/FM (FM/MW/LW selection) button
- 3- Memory select buttons
- 4- TP (Traffic program) button
- 5- PTY (Program type) button
- 6- TUNE switch
- 7- SEEK (Up-seek) button

- 8- SEEK (Down-seek) button
- 9- CT (Clock time) indicator
- 10- RDS (Radio data system) indicator
- 11- TP (Traffic program identification) indicator
- 12- PTY (Program type) indicator
- 13- REG (Regional program) indicator
- 14- Display

RDS uses PI (program identification) signal and AF (alternative frequency) list transmitted in addition to the normal FM broadcasting programs, and picks up the FM stations that are transmitting the same program from the AF list and automatically tunes to the station with the strongest signal intensity.

Therefore, you can continue listening to one program in, for example, a long distance driving without retuning to the other station transmitting the same program when you are leaving the service area of the currently receiving station.

The RDS radio also features the limited reception of the program types, the break-in reception of the traffic announcement to the EON (enhanced other network) and emergency broadcast, and the limited/unlimited reception of the regional programs.

**AF (Alternative Frequencies) function**

E00720900074

The AF function finds a station broadcasting the same program and selects the station with the strongest signal of AF lists.

The AF function is turned on at all times unless you manually switch it off.

The AF function can be turned ON and OFF. Refer to “Function setup mode” on page 5-17.

**CT (Clock Time) function**

E00721000069

The clock can be set automatically by using the signal from the local RDS stations. Refer to “Digital clock” on page 5-62.

**REG (Regional) function**

E00721100060

REG function limits to receive the stations broadcasting regional programs.

Regional programming and regional networks are organized differently depending on the country or area (they may be changed according to the hour, state, or broadcast area), so if you don’t want to receive the regional programs automatically, you can set up REG ON not to receive regional programs.

The REG function can be turned ON and OFF. Refer to “Function setup mode” on page 5-17.

**PI (Program Identification) search function**

E00721200074

When travelling long distance and the recalled preset station is weak, the radio searches another frequency broadcasting the same programming with the same PI code in AF list.

If there are no frequencies broadcasting the same programming, the radio searches a frequency broadcasting the regional programming. The radio succeeds in searching the regional programming, then the display shows the REG indicator (13). If the radio does not succeed in searching the regional programming, the radio returns to the recalled preset station.

The PI function can be turned ON and OFF on some vehicles. Refer to “Function setup mode” on page 5-17.

**NOTE**

- While searching, the audio system is muted. The display shows “WAIT” or “SEARCH”.

**PTY (Program type)**

E00721300206

RDS broadcasts are classified according to program type (PTY) as follows. Use the TUNE switch (6) to select your desired PTY.

1. NEWS
2. AFFAIRS (Current affairs)
3. INFO (Information)
4. SPORT
5. EDUCATE (Education)
6. DRAMA
7. CULTURE
8. SCIENCE
9. VARIED
10. POP M (Pop music)
11. ROCK M (Rock music)
12. EASY M (Easy music)
13. LIGHT M (Light classics)
14. CLASSICS
15. OTHER M (Other music)

16. WEATHER (Weather information)
17. FINANCE
18. CHILDREN
19. SOCIAL
20. RELIGION
21. PHONE IN
22. TRAVEL
23. LEISURE
24. JAZZ
25. COUNTRY
26. NATION M (National music)
27. OLDIES
28. FOLK M (Folk music)
29. DOCUMENT

To search for a broadcast of desired program type:

1. Press the PTY button (5).
2. Turn the TUNE switch (6) or press a memory select button (3) to select your desired PTY.
3. Two seconds after a desired PTY has been selected, the radio will begin to search for a broadcast of your selected PTY. During search, the selected PTY on the display blinks.
4. When the radio picks up a station with your desired PTY, the display will show the name of the station.

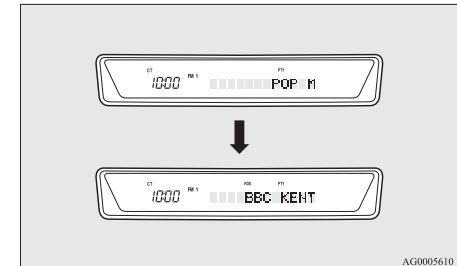

AG0005610

## For pleasant driving

### NOTE

- If the SEEK button (7 to 8) is pressed, the radio will try to find out another broadcast of the same program type as currently selected.
- If no station is found with your desired PTY, the display will show “EMPTY” for about 5 seconds and the radio will return to the previous station.

### How to enter PTYs in the memory

E00721400063

As many as 6 PTYs can be entered in the memory. Follow the steps described below.

1. Press the TUNE switch (6) to tune the PTY to be entered in the memory.
2. Press one of the memory select buttons (3) for 2 seconds or longer. The sound will be momentarily interrupted while the PTY is being entered into the memory. The number of the button corresponding to the entry into the memory and the PTY are displayed.
3. The preset memory setting is retrieved by pressing the button and then releasing it within about 2 seconds.

### To change the language of PTY display

E00721500123

You can select your favourite language among English, French, German, Swedish, Spanish and Italian.

1. Press the TUNE switch (6) for 2 seconds or longer to select the language of PTY display mode. Refer to “Function setup mode” on page 5-17.
2. Turn the TUNE switch (6) to select a language.

### NOTE

- After selecting a mode, you can leave the function setup mode by taking either of the following steps:
  - Press the TUNE switch (6) for at least 2 seconds.
  - Make no entry for 10 seconds.

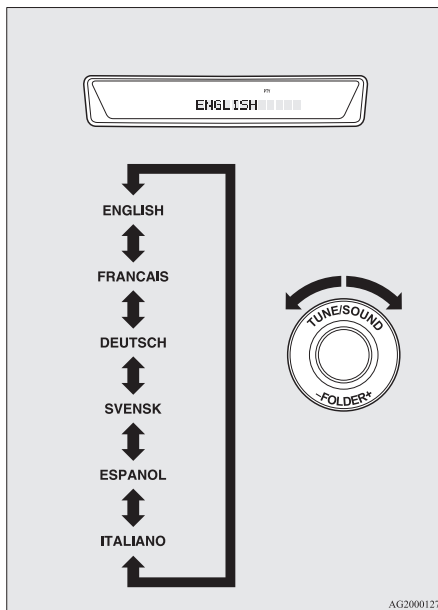

### Traffic information

E00721600182

The radio will automatically tune in to traffic information broadcasts while receiving FM broadcasts or playing compact discs.

To select this function, follow the instructions below.

1. Press the TP button (4). The display will show “TP” (11).

If the RDS data can be read, the display will show “RDS” (10). If not, the display will show “NO RDS” for about 5 seconds.

2. If the radio detects traffic information on either the station currently selected or another station, the display will show “TRAF INF” for 5 seconds followed by a 2-second indication of the frequency. Then, it will show the name of the station broadcasting the traffic information to which you will listen. The volume level is set separately for listening to normal audio programs and for listening to traffic information. The volume level will therefore change automatically to that set when traffic information was last received. When the traffic information broadcast is over, the radio will return to the previously received program and to the corresponding volume level.
3. Press the TP button (4) to return to the previous condition.

### NOTE

- While “TP” is illuminated, the radio stops only at TP stations, even if the TUNE switch (6) is turned.

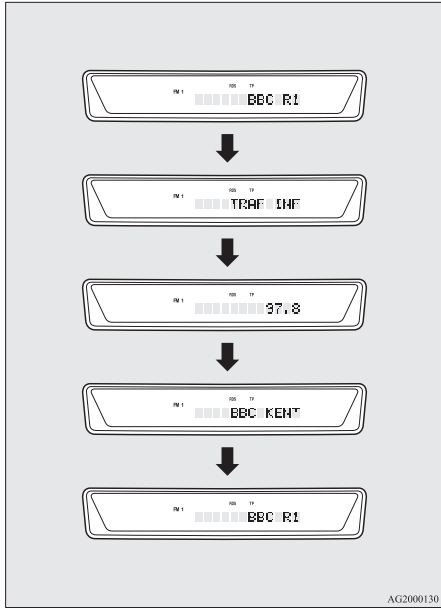

**TP (Traffic information Program) search function**  
E00721800083

The traffic information program standby function is turned on (with the TP indicator (11) shown on the display) and after about 45 seconds since the RDS indicator (10) turns off due to weak signal or the tuning station is changed over from a TP station to a station which does not broadcast traffic information, the sound will beep 5 times and seeks out a TP station in all frequencies automatically.

The TP search function can be turned ON and OFF. Refer to “Function setup mode” on page 5-17.

**Emergency broadcasts**

E00721700112

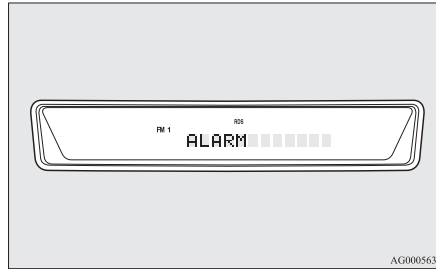

AG0005636

If an emergency broadcast is caught while receiving a FM broadcast or playing back a compact disc with the ignition switch in “ACC” or “ON” position, the display will show “ALARM” and the emergency broadcast will interrupt the current program. The volume level is set separately for listening to normal audio programs and for listening to emergency broadcasts. The volume level will therefore change automatically to that set when an emergency broadcast or traffic information broadcast was last received. When the emergency broadcast is over, the radio will return to the previously received program and to the corresponding volume level.

**Function setup mode**

E00722500250

It is possible to change the following functions:

- AF
- CT
- REG
- TP-S
- PI-S
- Language of PTY display
- SCV

1. Press the TUNE switch (6) for 2 seconds or longer to select the function setup mode.

## For pleasant driving

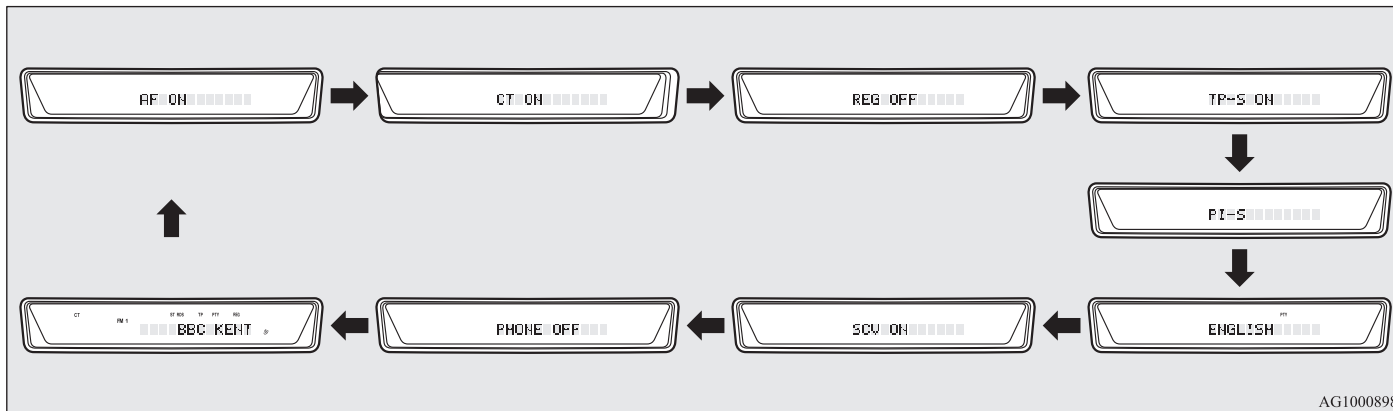

2. Press the TUNE switch (6) repeatedly to select the mode you wish to change.  
The order is: AF → CT → REG → TP-S → PI-S → Language of PTY display → SCV → PHONE → Function setup mode OFF.

### NOTE

- Although “PHONE” appears on the display, the PHONE function is inoperative.
3. Select the desired setting for each mode to be turned ON and OFF as shown below.

The setting will be shown on the display.

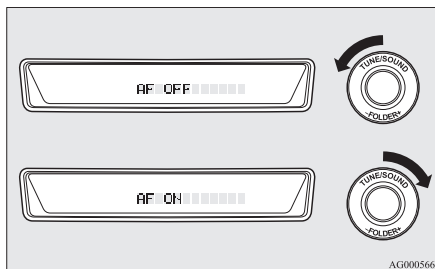

### NOTE

- After selecting a mode, you can leave the function setup mode by taking either of the following steps:

- Press the TUNE switch (6) for at least 2 seconds.
- Make no entry for 10 seconds.
- For instructions on setting the language of PTY display, refer to “To change the language of PTY display” on page 5-16.

## CD control panel and display

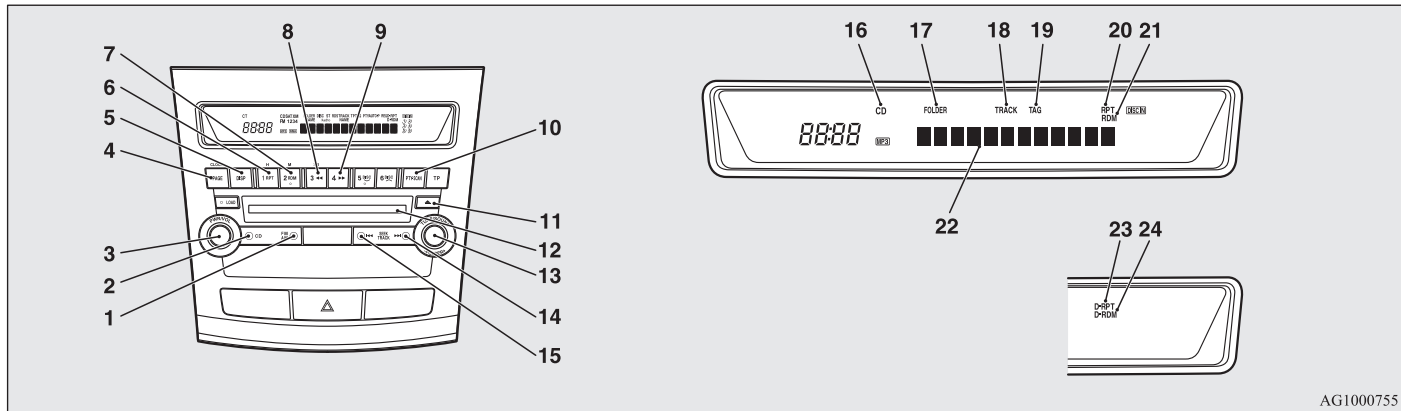

AG1000755

- 1- AM/FM button
- 2- CD (CD mode changeover) button
- 3- PWR (On-Off) switch
- 4- PAGE (Title scroll) button
- 5- DISP (Display) button
- 6- RPT (Repeat) button
- 7- RDM (Random) button
- 8- ◀◀ (Fast-reverse) button
- 9- ▶▶ (Fast-forward) button
- 10- SCAN button
- 11- Eject button
- 12- CD insertion slot
- 13- FOLDER switch
- 14- ▶▶1 (Track up) button
- 15- 1◀◀ (Track down) button
- 16- CD indicator
- 17- FOLDER indicator
- 18- TRACK (Track number) indicator
- 19- TAG (Tag) indicator
- 20- RPT (Repeat) indicator
- 21- RDM (Random) indicator
- 22- Display
- 23- D-RPT indicator
- 24- D-RDM indicator

## For pleasant driving

### To listen to a CD

E00709601886

1. Insert disc with label facing up.  
When a disc is inserted, the CD indicator (16) will come on and the CD player will begin playing even if the radio is being used. The CD player will also start playback when the CD button (2) is pressed with a disc in the player or with a disc set in the CD insertion slot (12), even if the radio is being used.
2. To stop the CD, turn off the power by pressing the PWR switch (3) or change over to radio mode by pressing the AM/FM button (1), or eject the disc by pressing the eject button (11).

#### NOTE

- To adjust the volume and tone, refer to “To adjust the volume” on page 5-10 and “To adjust the tone” on page 5-10.
- When an 8 cm compact disc is used, the adapter is not needed for playback. Insert the disc in the centre of the disc-loading slot.
- For information concerning the handling of compact discs, refer to “Handling of compact discs” on page 5-60.

### To listen to a music CD

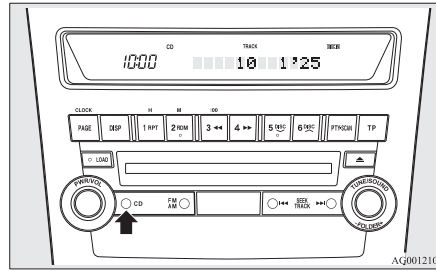

Push the CD button (2) if a disc is already in the CD player. The audio system will enter CD mode and start playback. The track number and the playing-time will appear on the display. The tracks in the disc will be played consecutively and continuously.

### To listen to an MP3 CD

This CD player allows you to play MP3 (MPEG Audio Layer-3) files recorded on CD-ROMs, CD-Rs (recordable CDs), and CD-RWs (rewritable CDs) in ISO9660 Level 1/Level 2, Joliet, and Romeo formats. Each disc can hold up to 255 files in up to 100 folders, up to a maximum of 16 levels. The ID3 tag information can be displayed during MP3 playback. For information concerning ID3 tags, refer to “CD text and MP3 title display” on page 5-22.

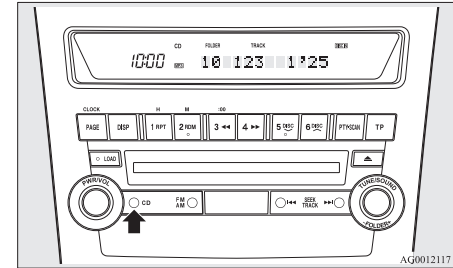

Push the CD button (2) if a disc is already in the CD player.

The display shows “READING”, then playback will begin. The folder number, the track number, the playing-time and “MP3” indicator will appear on the display.



NOTE

- While listening to a disc on which CD-DA (CD-Digital Audio) and MP3 files have both been recorded, you can switch between reading of the CD-DA, reading of the MP3 files, and the external audio input mode by pressing the CD button for 2 seconds or longer (until you hear a beep).  
For information on the external audio input, refer to “To use the external audio input function” on page 5-52.
- With a disc that contains both CD-DA and MP3 files, the CD-DA files are automatically played first.
- The playback sound quality differs depending on the encoder software and the bit rate. For more information, refer to the owner’s manual for the encoder software.
- Depending on the layout of the files and folders on the disc, it may take some time until playback starts.
- MP3 conversion software and writing software are not supplied with this unit.
- You may encounter trouble in playing an MP3 or displaying the information of MP3 files recorded with certain writing software or CD recorders (CD-R/RW drivers).
- If you write many folders or files other than MP3 files, it may take some time before playback starts.
- This unit does not record MP3 files.
- For information on CD-Rs/RWs, refer to “Notes on CD-Rs/RWs” on page 5-61.

**CAUTION**

- Attempting to play a file not in the MP3 format which has a “.mp3” file name may produce noise from the speakers and speaker damage, and can significantly damage your hearing.

**Folder selection order/MP3 file playback order (Example)**

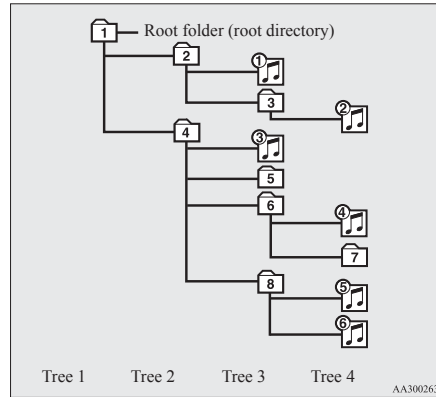

**Folder selection**

In the order

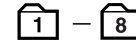

**File selection**

In the order



*To fast-forward/reverse the disc*

**Fast-forward**

The disc is fast-forwarded while the ►► button (9) is held down. Playback will begin once the button is released.

**Fast-reverse**

The disc is fast-reversed while the ◀◀ button (8) is held down. Playback will begin once the button is released.

*To select a desired folder (MP3 CDs only)*

You can select your desired folder by turning the FOLDER switch (13).

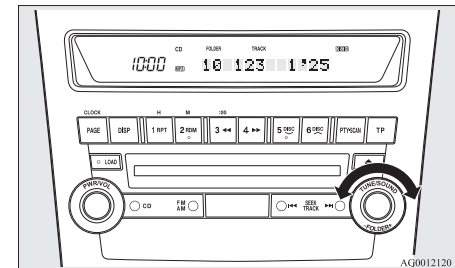

## For pleasant driving

### Folder up

Turn the FOLDER switch (13) clockwise until the desired folder number appears on the display.

### Folder down

Turn the FOLDER switch (13) anticlockwise until the desired folder number appears on the display.

### To select a desired track

You can cue tracks on a disc by using the ◀◀ or ▶▶ button (15 or 14).

### Track up

The disc will skip as many songs as the number of times the button ▶▶ (14) is pushed. The display window will display the track number of the track selected.

### Track down

The disc will skip as many songs as the number of times the button ◀◀ (15) is pushed. The display window will display the track number of the track selected.

### To repeat tracks

#### To repeat a track

Press the RPT button (6) to repeat the same track. If the RPT button is pressed, the RPT indicator (20) will come on. To exit this mode, press the button again.

#### To repeat songs in the same folder (MP3 CDs only)

While a song is playing, press the RPT button (6) for 2 seconds or longer (until you hear a beep). The D-RPT indicator (23) will come on and the disc will repeat all the songs in the folder that contains the song currently playing. To exit this mode, press the button again.

### NOTE

- With a disc that contains both CD-DA and MP3 files, the repeat mode causes only files of the same format (CD-DA only or MP3 files only) to be repeated.

### To change track playback order

#### Random playback for a disc (music CDs only)

If the RDM button (7) is pressed, the RDM indicator (21) will come on and the tracks that are played will be selected at random. To exit this mode, press the button again.

#### Random playback for a folder (MP3 CDs only)

If the RDM button (7) is pressed, the RDM indicator (21) will come on and the tracks that are played will be selected at random from the folder that is currently selected. To exit this mode, press the button again.

#### Random playback for all folders on a disc (MP3 CDs only)

Press the RDM button (7) for 2 seconds or longer (until you hear a beep). The D-RDM indicator (24) will come on and the tracks that are played will be selected at random from all folders on the disc. To exit this mode, press the button again.

### NOTE

- With a disc that contains both CD-DA and MP3 files, the random mode causes only files of the same format (CD-DA only or MP3 files only) to be played in a random sequence.

### To find the start of each track on a disc for playback

Press the SCAN button (10). “SCAN” will appear on the display (22) and the CD player will play back the first 10 seconds of each track on the disc. The track number will blink while the scan mode is selected. To exit this mode, press the button again.

### NOTE

- Once all tracks on the disc have been scanned, playback of the disc will restart from the beginning of the track that was playing when scanning started.
- The scan mode will be cancelled when radio or CD operation is selected.
- With a disc that contains both CD-DA and MP3 files, the scan mode causes only files of the same format (CD-DA only or MP3 files only) to be played.

### To eject discs

When the eject button (11) is pressed, the disc automatically stops and is ejected. The system automatically switches to radio mode.

### NOTE

- If you do not remove an ejected disc before 15 seconds have elapsed, the disc will be reloaded.

### CD text and MP3 title display

This CD player can display CD text and MP3 titles including ID3 tag information.

E00725000328

### CD text

The CD player can display disc and track titles for discs with converted disc and track title information. Press the DISP button (5) repeatedly to make selections in the following sequence: disc name → track name → normal display mode.

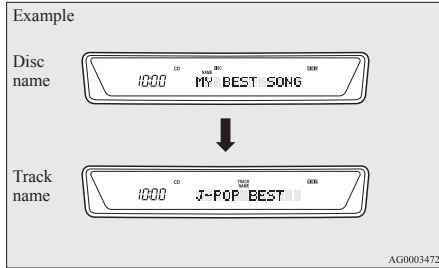

### NOTE

- The display can show up to 12 characters. If a disc name or track name has more than 12 characters, press the PAGE button (4) to view the next 12 characters.
- When there is no title information to be displayed, the display shows “NO TITLE”.
- Characters that the CD player cannot display are shown as “•”.

### MP3 titles

The CD player can display folder and track titles for discs with converted folder and track information. Press the DISP button (5) repeatedly to make selections in the following sequence: folder name → track name → normal display mode.

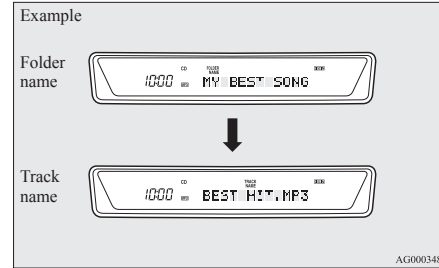

### ID3 tag information

The CD player can display ID3 tag information for files that have been recorded with ID3 tag information.

1. Press the DISP button (5) for 2 seconds or longer to switch to the ID3 tag information. The TAG indicator (19) will appear on the display.
2. Press the DISP button repeatedly to make selections in the following sequence: album name → track name → artist name → normal display mode.

### NOTE

- To return from ID3 tag information to the folder name, press the DISP button again for 2 seconds or longer.
- When there is no title information to be displayed, the display shows “NO TITLE”.

- The display can show up to 12 characters. If a folder name, track name, or item of ID3 tag information has more than 12 characters, press the PAGE button (4) to view the next 12 characters.
- Folder names and track names can each be displayed up to a length of 32 characters. Items of ID3 tag information can each be displayed up to a length of 30 characters.
- Characters that the CD player cannot display are shown as “•”.

## For pleasant driving

### LW/MW/FM digital tuning radio with CD changer\*

E00708501862

The audio system can only be used when the ignition switch is in the "ON" or "ACC" position.

#### NOTE

- To listen to the audio system while the engine is stopped, turn the ignition switch to the "ACC" position.  
If the ignition switch is left in the "ACC" position, the accessory power will automatically turn off after a certain period of time and you will no longer be able to use the audio system. The accessory power comes on again if the ignition switch is turned from the "ACC" position. Refer to "ACC power auto-toutout function" on page 4-13.
- If a cellular phone is used inside the vehicle, it may create noise from the audio equipment. This does not mean that anything is wrong with your audio equipment. In such a case, use the cellular phone at a place as far away as possible from the audio equipment.
- If foreign objects or water get into the audio equipment, or if smoke or a strange odour comes from it, immediately turn off the audio system. We recommend you to have it checked. Never try to repair it by yourself. Avoid continuous usage without inspection by a qualified person.
- The audio amplifier (if so equipped) is located under the front right seat. Do not subject the amplifier to a strong impact. It could damage the amplifier or malfunctioning could result.

### Volume and tone control panel

E00708600707

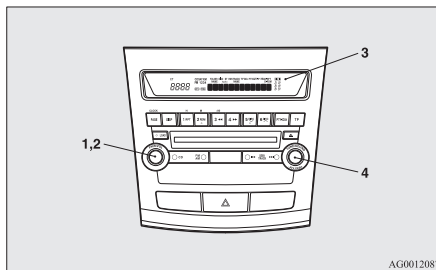

- 1- PWR (On-Off) switch
- 2- VOL (Volume control) knob
- 3- Display
- 4- SOUND (Sound control) switch

### To adjust the volume

E00708700261

#### *VOL (Volume control)*

Turn the VOL knob (2) clockwise to increase the volume; anticlockwise to decrease the volume.

### To adjust the tone

E00708800741

Press the SOUND switch (4) to select: SUB PUNCH → TYPE → FIELD → BASS → MID → TREBLE → FADER → BALANCE → audio control mode OFF.

#### NOTE

- The SUB LEVEL can only be adjusted on vehicles with a premium sound system.  
On vehicles without a premium sound system, when you press the SOUND switch (4), the display starts from TYPE.

#### QUICK ACCESS MODE

To access the sound customization features quickly, push and hold the SOUND switch (4), then turn the switch clockwise or anticlockwise to access your desired sound customization setting. Release the switch to adjust the setting.

#### HOLD MODE

If the SOUND switch (4) is pushed and held for more than 2 seconds during the audio adjust mode, it will change to "Hold" mode. The selected audio mode will be held until the SOUND switch (4) is pushed for more than 2 seconds again.

#### *SUB PUNCH (Subwoofer volume control)*

To select the desired subwoofer volume level.

#### *TYPE (Acoustic characteristic selection)*

1. Turn the SOUND switch (4) to select the desired music type.
2. Press the SOUND switch (4) to set the audio system to the selected music type.

Acoustic characteristics	Details
CLASSIC	The optimum acoustic characteristics for classical music, which requires an overall sound balance that is flat.
JAZZ	The optimum acoustic characteristics for jazz music, which requires an atmospheric sound that applies different modulations to the bass, mid-range, and treble.
POP	The optimum acoustic characteristics for pop music, which requires a crisp vocal sound with a modulated bass and treble.
ROCK	The optimum acoustic characteristics for rock music, which requires a sound with a sense of speed that emphasises the mid range.
HIP-HOP	The optimum acoustic characteristics for hip hop music, which requires a powerful sound that emphasises the bass.

**FIELD (Sound field selection)**

1. Turn the SOUND switch (4) to select the desired sound field.

2. Press the SOUND switch (4) to set the audio system to the selected sound field.

Sound field type	Details
NORMAL	This sound field produces a sound effect where the vocals are in the front and the instruments surround the listener.
STAGE	This sound field produces a sound effect where the vocals are right in front of the driver, as on a stage.
LIVE	This sound field produces a sound effect similar to a live venue, where the listener is wrapped in sound from all directions.
HALL	This sound field produces a sound effect similar to a concert hall with reverberating acoustics.

**BASS (Bass tone control)**

Turn the SOUND switch (4) to select the desired bass tone.

**MID (Midrange tone control)**

Turn the SOUND switch (4) to select the desired middle tone.

**TREBLE (Treble tone control)**

Turn the SOUND switch (4) to select the desired treble tone.

**FADER (Front/Rear balance control)**

Turn the SOUND switch (4) to balance volume from the front and rear speakers.

**BALANCE (Left/Right balance control)**

Turn the SOUND switch (4) to balance volume from the left and right speakers.

**NOTE**

- When set to 0, it will beep.
- When SUB PUNCH, TYPE or FIELD is changed, the sound will cut out briefly, but this does not indicate a malfunction.
- The audio control mode will shut off if either the radio or CD is operated, or if no adjustment is made within about 10 seconds.

**SCV (Speed Compensated Volume) function**

E00726800482

SCV function is a feature that automatically adjusts the VOLUME, BASS, MID, and TREBLE settings in accordance with the vehicle speed.

The SCV function can be turned ON and OFF. Refer to “Function setup mode” on page 5-31.

For pleasant driving

## Radio control panel and display

E00708900784

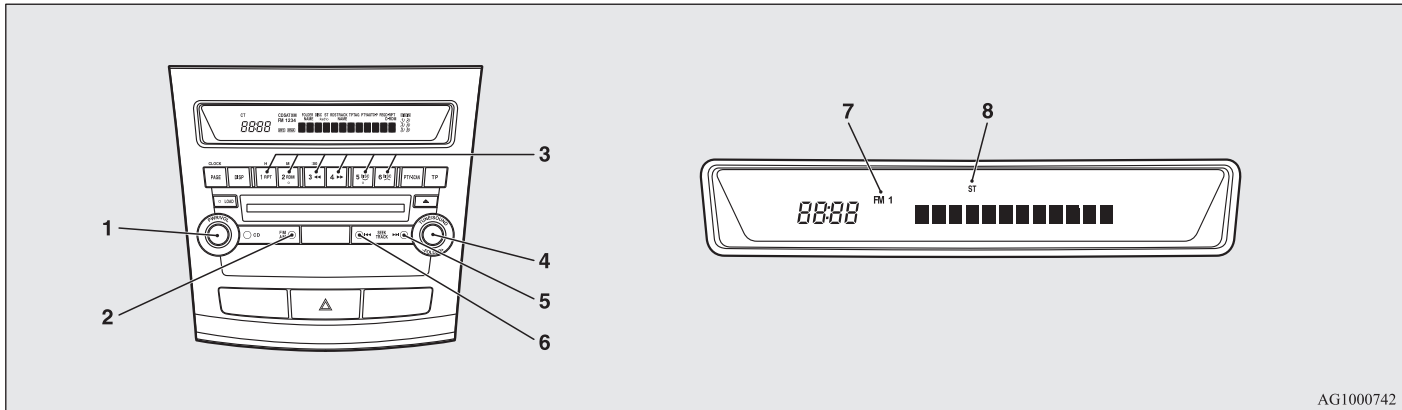

AG1000742

5

- 1- PWR (On-Off) switch
- 2- AM/FM (FM/MW/LW selection) button
- 3- Memory select buttons
- 4- TUNE switch

- 5- SEEK (Up-seek) button
- 6- SEEK (Down-seek) button
- 7- FM (FM1/FM2/FM3) indicator
- 8- ST (Stereo) indicator

## To listen to the radio

E00709000548

1. Press the PWR switch (1) or the AM/FM button (2) to turn ON the radio.  
Press the PWR switch again to turn OFF the radio.
2. Press the AM/FM button (2) to select the desired band.
3. Turn the TUNE switch (4), or press the SEEK button (5 or 6) or memory select buttons (3) to tune into a radio broadcasting station.

## To tune the radio

E00709100422

### Automatic tuning

After pressing the SEEK button (5 or 6), a receivable station will be automatically selected and reception of the station will begin.

### Manual tuning

The frequency changes every time the TUNE switch (4) is turned. Turn the switch to select the desired radio broadcasting station.

## To enter frequencies into the memory

E00716100844

### Manual setting

You can assign to the memory select buttons (3) a maximum of 18 stations in the FM band (6 FM1, 6 FM2 and 6 FM3 stations) and 6 stations each in the MW and LW band. (Stations already assigned to the memory select buttons are replaced by any newly assigned stations.)

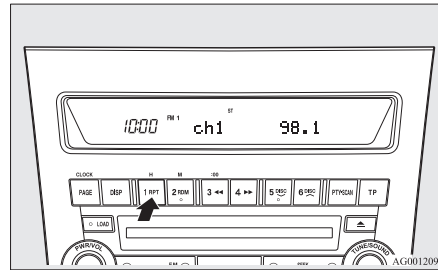

Follow the steps described below.

1. Press the SEEK button (5 or 6), or turn the TUNE switch (4) to tune to the frequency you wish to keep in the memory.
2. Press one of the memory select buttons (3) until it beeps.  
The sound will be momentarily interrupted while the frequency is being entered into the memory. The number of the button matching the entry in the memory as well as the frequency is displayed.
3. The preset memory setting is retrieved by pressing the button and then releasing it within 1 second.

## NOTE

- Disconnecting the battery terminal erases all the radio frequencies stored in the memory.

### Automatic setting

With the method, all manually set stations in the band currently selected for reception are replaced with stations in the same band that are automatically selected in order of signal strength.

The radio automatically selects 6 stations in the FM band (FM3 station only) and 6 stations each in the MW and LW band.

Follow the steps described below.

1. With the radio mode selected, hold down the AM/FM button (2) for 2 seconds or longer. The 6 stations with the best signal strength will automatically be assigned to the memory select buttons (3), with the lowest-frequency station being assigned to the lowest-number button.
2. When you subsequently press a memory select button to select a channel number, the radio will begin receiving the station assigned to that number.

## NOTE

- If you press the AM/FM button (2) for 2 seconds or longer while tuning in the FM1 or FM2 band, the radio will automatically switch to the FM3 band, where the automatic-seeking/storing will be activated.

For pleasant driving

## Radio data system (RDS)

E00709200289

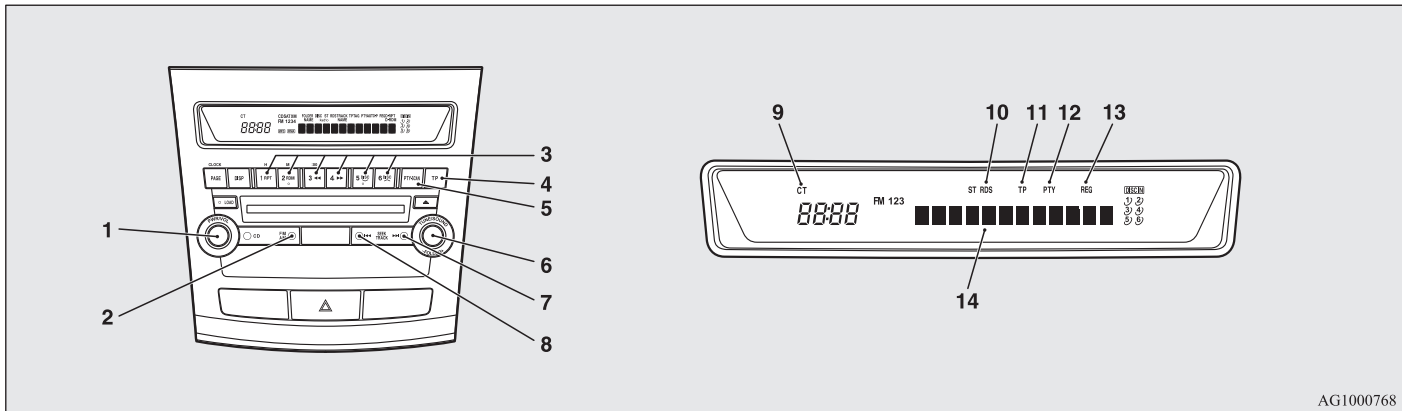

AG1000768

5

- 1- PWR (On-Off) switch
- 2- AM/FM (FM/MW/LW selection) button
- 3- Memory select buttons
- 4- TP (Traffic program) button
- 5- PTY (Program type) button
- 6- TUNE switch
- 7- SEEK (Up-seek) button

- 8- SEEK (Down-seek) button
- 9- CT (Clock time) indicator
- 10- RDS (Radio data system) indicator
- 11- TP (Traffic program identification) indicator
- 12- PTY (Program type) indicator
- 13- REG (Regional program) indicator
- 14- Display

RDS uses PI (program identification) signal and AF (alternative frequency) list transmitted in addition to the normal FM broadcasting programs, and picks up the FM stations that are transmitting the same program from the AF list and automatically tunes to the station with the strongest signal intensity.

Therefore, you can continue listening to one program in, for example, a long distance driving without retuning to the other station transmitting the same program when you are leaving the service area of the currently receiving station.

The RDS radio also features the limited reception of the program types, the break-in reception of the traffic announcement to the EON (enhanced other network) and emergency broadcast, and the limited/unlimited reception of the regional programs.



**AF (Alternative Frequencies) function**

E00720900162

The AF function finds a station broadcasting the same program and selects the station with the strongest signal of AF lists.

The AF function is turned on at all times unless you manually switch it off.

The AF function can be turned ON and OFF. Refer to “Function setup mode” on page 5-31.

**CT (Clock Time) function**

E00721000072

The clock can be set automatically by using the signal from the local RDS stations. Refer to “Digital clock” on page 5-62.

**REG (Regional) function**

E00721100116

REG function limits to receive the stations broadcasting regional programs.

Regional programming and regional networks are organized differently depending on the country or area (they may be changed according to the hour, state, or broadcast area), so if you don’t want to receive the regional programs automatically, you can set up REG ON not to receive regional programs.

The REG function can be turned ON and OFF. Refer to “Function setup mode” on page 5-17.

**PI (Program Identification) search function**

E00721200205

When travelling long distance and the recalled preset station is weak, the radio searches another frequency broadcasting the same programming with the same PI code in AF list.

If there are no frequencies broadcasting the same programming, the radio searches a frequency broadcasting the regional programming. The radio succeeds in searching the regional programming, then the display shows the REG indicator (13). If the radio does not succeed in searching the regional programming, the radio returns to the recalled preset station.

The PI function can be turned ON and OFF on some vehicles.

Refer to “Function setup mode” on page 5-31.

**NOTE**

- While searching, the audio system is muted. The display shows “WAIT” or “SEARCH”.

**PTY (Program type)**

E00721300219

RDS broadcasts are classified according to program type (PTY) as follows. Use the TUNE switch (6) to select your desired PTY.

1. NEWS
2. AFFAIRS (Current affairs)
3. INFO (Information)
4. SPORT
5. EDUCATE (Education)
6. DRAMA
7. CULTURE
8. SCIENCE
9. VARIED
10. POP M (Pop music)
11. ROCK M (Rock music)
12. EASY M (Easy music)
13. LIGHT M (Light classics)
14. CLASSICS
15. OTHER M (Other music)
16. WEATHER (Weather information)

17. FINANCE
18. CHILDREN
19. SOCIAL
20. RELIGION
21. PHONE IN
22. TRAVEL
23. LEISURE
24. JAZZ
25. COUNTRY
26. NATION M (National music)
27. OLDIES
28. FOLK M (Folk music)
29. DOCUMENT

To search for a broadcast of desired program type:

1. Press the PTY button (5).
2. Turn the TUNE switch (6) or press a memory select button (3) to select your desired PTY.
3. Two seconds after a desired PTY has been selected, the radio will begin to search for a broadcast of your selected PTY. During search, the selected PTY on the display blinks.
4. When the radio picks up a station with your desired PTY, the display will show the name of the station.

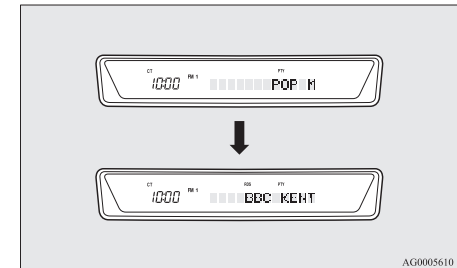

## For pleasant driving

### NOTE

- If the SEEK button (7 to 8) is pressed, the radio will try to find out another broadcast of the same program type as currently selected.
- If no station is found with your desired PTY, the display will show “EMPTY” for about 5 seconds and the radio will return to the previous station.

### How to enter PTYs in the memory

E00721400076

As many as 6 PTYs can be entered in the memory. Follow the steps described below.

1. Press either the TUNE switch (6) to tune the PTY to be entered in the memory.
2. Press one of the memory select buttons (3) for 2 seconds or longer. The sound will be momentarily interrupted while the PTY is being entered into the memory. The number of the button corresponding to the entry into the memory and the PTY are displayed.
3. The preset memory setting is retrieved by pressing the button and then releasing it within about 2 seconds.

### To change the language of PTY display

E00721500208

You can select your favourite language among English, French, German, Swedish, Spanish and Italian.

1. Press the TUNE switch (6) for 2 seconds or longer to select the language of PTY display mode. Refer to “Function setup mode” on page 5-31.
2. Turn the TUNE switch (6) to select a language.

### NOTE

- After selecting a mode, you can leave the function setup mode by taking either of the following steps:
  - Press the TUNE switch (6) for at least 2 seconds.
  - Make no entry for 10 seconds.

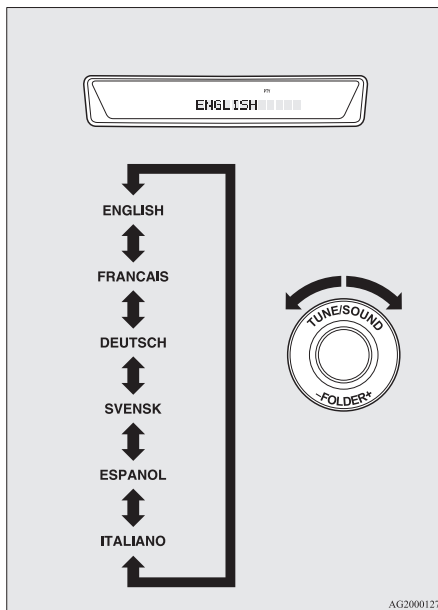

### Traffic information

E00721600124

The radio will automatically tune in to traffic information broadcasts while receiving FM broadcasts or playing compact discs.

To select this function, follow the instructions below.

1. Press the TP button (4). The display will show “TP” (11).

If the RDS data can be read, the display will show “RDS” (10). If not, the display will show “NO RDS” for about 5 seconds.

2. If the radio detects traffic information on either the station currently selected or another station, the display will show “TRAF INF” for 5 seconds followed by a 2-second indication of the frequency. Then, it will show the name of the station broadcasting the traffic information to which you will listen. The volume level is set separately for listening to normal audio programs and for listening to traffic information. The volume level will therefore change automatically to that set when traffic information was last received. When the traffic information broadcast is over, the radio will return to the previously received program and to the corresponding volume level.
3. Press the TP button (4) to return to the previous condition.

### NOTE

- While “TP” is illuminated, the radio stops only at TP stations, even if the TUNE switch (6) is turned.

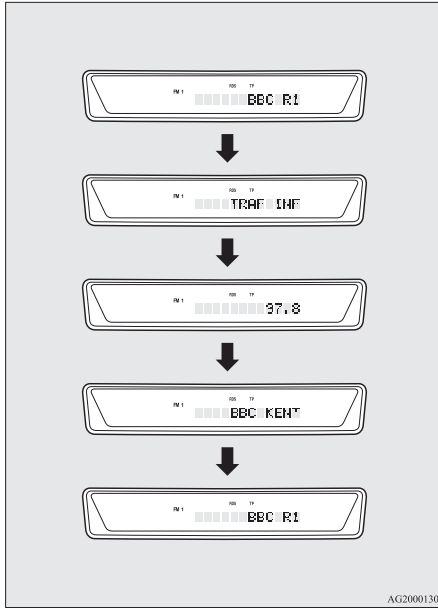

**TP (Traffic information Program) search function**  
E00721800184

The traffic information program standby function is turned on (with the TP indicator (11) shown on the display) and after about 45 seconds since the RDS indicator (10) turns off due to weak signal or the tuning station is changed over from a TP station to a station which does not broadcast traffic information, the sound will beep 5 times and seeks out a TP station in all frequencies automatically.

The TP search function can be turned ON and OFF. Refer to “Function setup mode” on page 5-31.

**Emergency broadcasts**

E00721700125

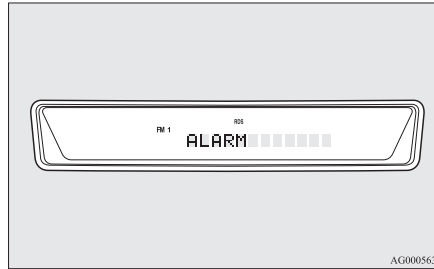

AG0005636

If an emergency broadcast is caught while receiving a FM broadcast or playing back a compact disc with the ignition switch in “ACC” or “ON” position, the display will show “ALARM” and the emergency broadcast will interrupt the current program. The volume level is set separately for listening to normal audio programs and for listening to emergency broadcasts. The volume level will therefore change automatically to that set when an emergency broadcast or traffic information broadcast was last received. When the emergency broadcast is over, the radio will return to the previously received program and to the corresponding volume level.

**Function setup mode**

E00722500263

It is possible to change the following functions:

- AF
- CT
- REG
- TP-S
- PI-S
- Language of PTY display
- SCV

1. Press the TUNE switch (6) for 2 seconds or longer to select the function setup mode.

## For pleasant driving

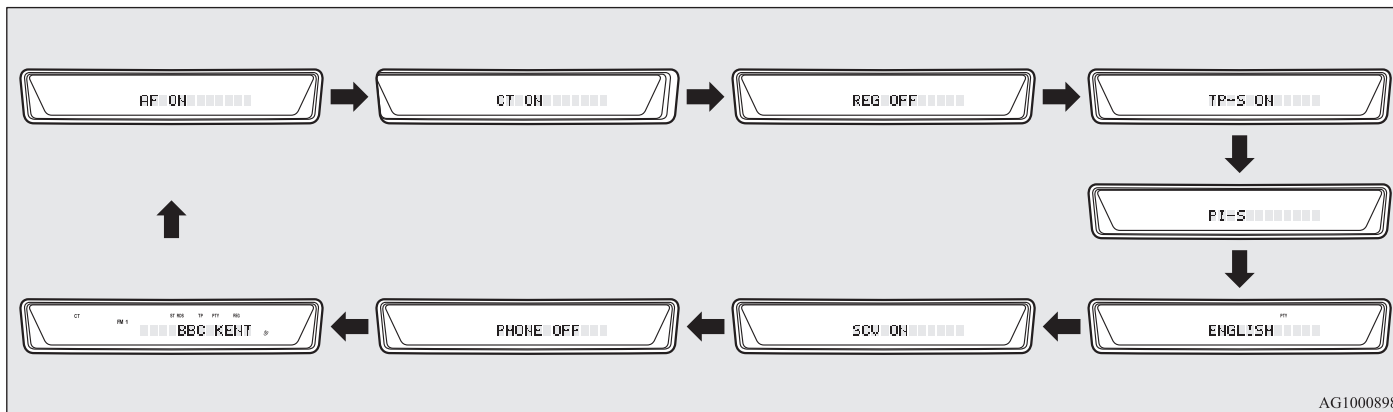

2. Press the TUNE switch (6) repeatedly to select the mode you wish to change.  
The order is: AF → CT → REG → TP-S → PI-S → Language of PTY display → SCV → PHONE → Function setup mode OFF.

3. Select the desired setting for each mode to be turned ON and OFF as shown below.  
The setting will be shown on the display.

### NOTE

- After selecting a mode, you can leave the function setup mode by taking either of the following steps:
  - Press the TUNE switch (6) for at least 2 seconds.
  - Make no entry for 10 seconds.
- For instructions on setting the language of PTY display, refer to “To change the language of PTY display” on page 5-16.

5

### NOTE

- Although “PHONE” appears on the display, the PHONE function is inoperative.

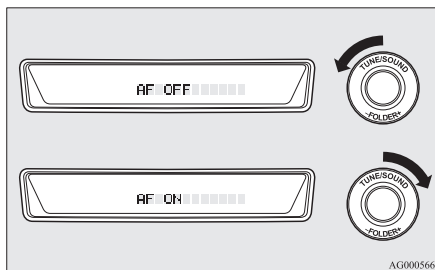

## CD control panel and display

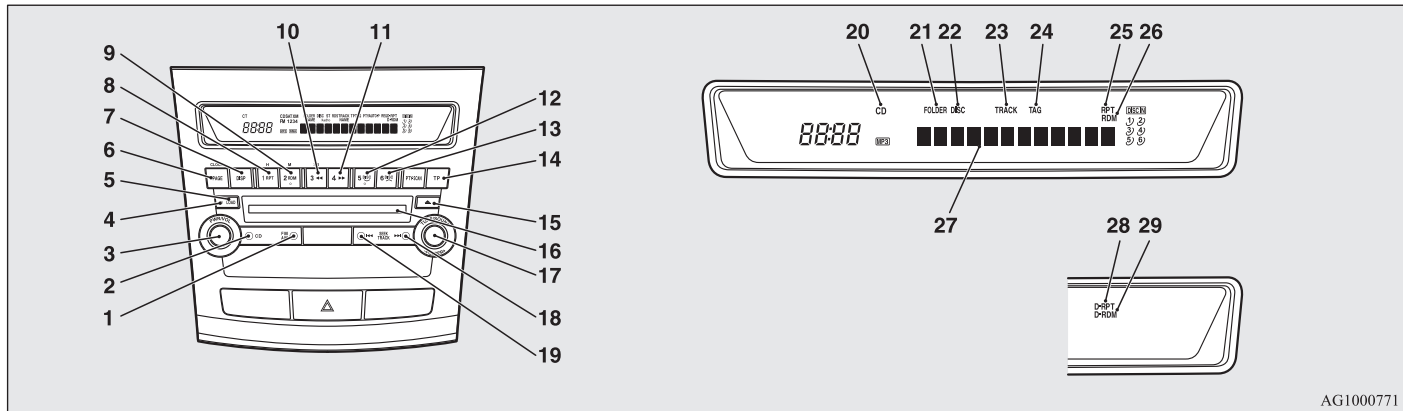

AG1000771

- 1- AM/FM button
- 2- CD (CD mode changeover) button
- 3- PWR (On-Off) switch
- 4- LOAD indicator
- 5- LOAD button
- 6- PAGE (Title scroll) button
- 7- DISP (Display) button
- 8- RPT (Repeat) button
- 9- RDM (Random) button
- 10- ◀◀ (Fast-reverse) button
- 11- ▶▶ (Fast-forward) button
- 12- DISC (Disc down) button
- 13- DISC (Disc up) button
- 14- SCAN button
- 15- Eject button
- 16- CD insertion slot
- 17- FOLDER switch
- 18- ▶▶1 (Track up) button
- 19- 1◀◀ (Track down) button
- 20- CD indicator
- 21- FOLDER indicator
- 22- DISC (Disc) indicator
- 23- TRACK (Track number) indicator
- 24- TAG (Tag) indicator
- 25- RPT (Repeat) indicator
- 26- RDM (Random mode) indicator
- 27- Display
- 28- D-RPT indicator
- 29- D-RDM indicator

## For pleasant driving

### To listen to a CD

E00709602229

The CD can be loaded or ejected by pressing the LOAD button (5) or the eject button (15) even if the audio system power is off.

1. Press the PWR switch (3) to turn the audio system ON and OFF. The audio system turns on in the last mode used.
2. Press the CD button (2) to enter CD mode. The autochanger will start playback if the CD is already in the autochanger.
3. To stop the CD, turn off the power by pressing the PWR switch (3) or change over to radio mode by pressing the AM/FM button (1), or eject the disc by pressing the eject button (15).

#### NOTE

- For information on adjusting the volume and tone, refer to “To adjust the volume” on page 5-24 and “To adjust the volume” on page 5-24.
- As many as 6 CDs can be inserted into the CD autochanger.
- 8 cm CDs cannot be played on this autochanger.
- For information concerning the handling of compact discs, refer to “Handling of compact discs” on page 5-60.

### To set discs

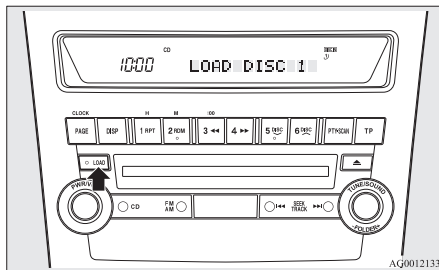

### To set a single disc

1. Press the LOAD button (5) briefly.
2. The autochanger will show “WAIT” on the display and start making itself ready for disc loading.
3. When the autochanger is ready for disc loading, the LOAD indicator (4) will illuminate and the display will show “LOAD DISC No. (1-6)”.
4. When a disc is inserted into the CD slot, the disc will begin to play.

#### NOTE

- If there are multiple empty slots, you can select your desired slot by pressing the DISC buttons (12 or 13).
- If you do not insert a disc for about 15 seconds after the autochanger starts standing by for loading, the loading standby mode will be cancelled.

### To set all the discs

1. Press the LOAD button (5) for 2 seconds or longer (until you hear a beep).

2. The autochanger will select the lowest-numbered empty slot and switch to loading standby mode.
3. When the display shows “LOAD DISC No. (1-6)” insert a disc. The autochanger will then automatically select the next empty slot and enter loading standby mode.
4. Repeat the above-described steps until every slot contains a disc. Playback will then begin with the disc that you inserted last.

#### NOTE

- If you press the LOAD button (5) again while the autochanger is in loading standby mode, the loading standby mode will be cancelled.

### To eject discs

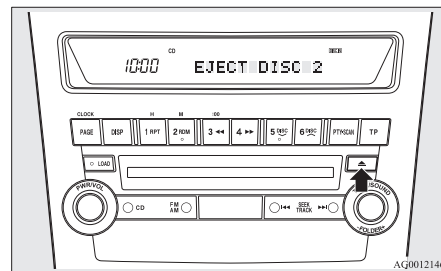

### To eject a single disc

Press the eject button (15) briefly to eject the currently selected disc.

**NOTE**

- If you press the eject button (15) while the display is showing “LOAD DISC No. (1-6)”, the loading standby mode will be cancelled and the next disc will be ejected.
- If you do not remove an ejected disc before 15 seconds have elapsed, the disc will be re-loaded and the eject mode will be cancelled. The reloaded disc will not be played.

**To eject all the discs**

1. Press the eject button (15) for 2 seconds or longer (until you hear a beep).
2. The currently selected disc will be ejected. When you remove the ejected disc, the next disc will automatically be ejected.
3. Repeat the above-described steps until all of the discs have been ejected. The autochanger will then enter loading standby mode.

**NOTE**

- If you do not remove an ejected disc before 15 seconds have elapsed, the disc will be re-loaded and the eject mode will be cancelled. The reloaded disc will not be played.

**To select a desired disc**

You can select your desired disc by using the DISC button (12 or 13). The active disc will be indicated on the display.

**Disc up**

Press the DISC button (13) repeatedly until the desired disc number appears on the display.

**Disc down**

Press the DISC button (12) repeatedly until the desired disc number appears on the display.

**To listen to a music CD**

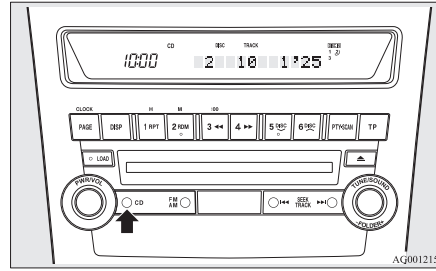

Push the CD button (2) if the discs are already in the autochanger. The autochanger will enter CD mode and start playback. The disc number, the track number and the playing-time will appear on the display. The discs in the unit will be played consecutively and continuously.

**To listen to an MP3 CD**

This autochanger allows you to play MP3 (MPEG Audio Layer-3) files recorded on CD-ROMs, CD-Rs (recordable CDs), and CD-RWs (rewritable CDs) in ISO9660 Level 1/Level 2, Joliet, and Romeo formats. Each disc can hold up to 255 files in up to 100 folders, up to a maximum of 16 levels. The ID3 tag information can be displayed during MP3 playback. For information concerning ID3 tags, refer to “CD text and MP3 title display” on page 5-37.

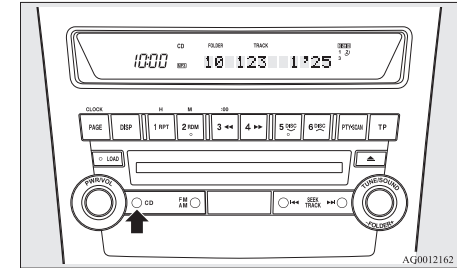

Push the CD button (2) if the discs are already in the CD autochanger. The display shows “READING”, then playback will begin. The folder number, the track number, the playing-time and “MP3” indicator will appear on the display.

## For pleasant driving

### NOTE

- While listening to a disc on which CD-DA (CD-Digital Audio) and MP3 files have both been recorded, you can switch between reading of the CD-DA, reading of the MP3 files, and the external audio input mode by pressing the CD button for 2 seconds or longer (until you hear a beep).

For information on the external audio input mode, refer to “To use the external audio input function\*” on page 5-52.

- With a disc that contains both CD-DA and MP3 files, the CD-DA files are automatically played first.
- The playback sound quality differs depending on the encoder software and the bit rate. For more information, refer to the owner’s manual for the encoder software.
- Depending on the layout of the files and folders on the disc, it may take some time until playback starts.
- MP3 conversion software and writing software are not supplied with this unit.
- You may encounter trouble in playing an MP3 or displaying the information of MP3 files recorded with certain writing software or CD recorders (CD-R/RW drivers).
- If you write many folders or files other than MP3 files, it may take some time before playback starts.
- This unit does not record MP3 files.
- For information on CD-Rs/RWs, refer to “Notes on CD-Rs/RWs” on page 5-61.

### **⚠ CAUTION**

- **Attempting to play a file not in the MP3 format which has a “.mp3” file name may produce noise from the speakers and speaker damage, and can significantly damage your hearing.**

### Folder selection order/MP3 file playback order (Example)

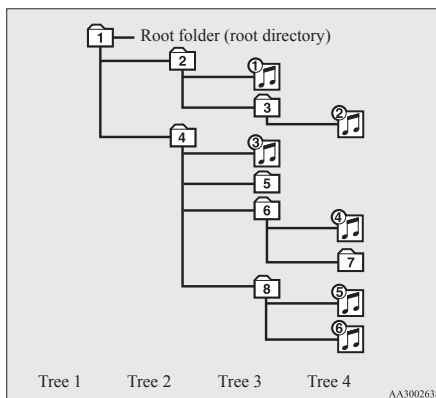

### Folder selection

In the order

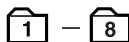

### File selection

In the order



### To fast-forward/reverse the disc

#### Fast-forward

The disc is fast-forwarded while the ►► button (11) is held down.

Playback will begin once the button is released.

#### Fast-reverse

The disc is fast-reversed while the ◀◀ button (10) is held down.

Playback will begin once the button is released.

### To select a desired folder (MP3 CDs only)

You can select your desired folder by turning the FOLDER switch (17).

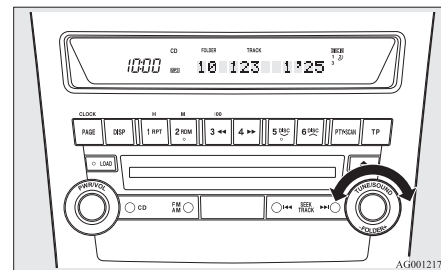

### Folder up

Turn the FOLDER switch (17) clockwise until the desired folder number appears on the display.

### Folder down

Turn the FOLDER switch (17) anticlockwise until the desired folder number appears on the display.

### To select a desired track

You can cue tracks on a disc by using the ◀◀ or ►► button (19 or 18).



**Track up**

The disc will skip as many songs as the number of times the button ►►1 (18) is pushed.

The display window will display the track number of the track selected.

**Track down**

The disc will skip as many songs as the number of times the button 1◄◄ (19) is pushed.

The display window will display the track number of the track selected.

**To repeat tracks****To repeat a track**

Press the RPT button (8) to repeat the same track. If the RPT button is pressed, the RPT indicator (25) will come on.

To exit this mode, press the button again.

**To repeat a disc (music CDs only)**

While a song is playing, press the RPT button (8) for 2 seconds or longer (until you hear a beep). The D-RPT indicator (28) will come on and the disc will repeat all the songs on the disc.

To exit this mode, press the button again.

**To repeat songs in the same folder (MP3 CDs only)**

While a song is playing, press the RPT button (8) for 2 seconds or longer (until you hear a beep). The D-RPT indicator (28) will come on and the disc will repeat all the songs in the folder that contains the song currently playing.

To exit this mode, press the button again.

**NOTE**

- With a disc that contains both CD-DA and MP3 files, the repeat mode causes only files of the same format (CD-DA only or MP3 files only) to be repeated.

**To change track playback order****Random playback for a disc (music CDs only)**

If the RDM button (9) is pressed, the RDM indicator (26) will come on and the tracks that are played will be selected at random.

To exit this mode, press the button again.

**Random playback for a folder (MP3 CDs only)**

If the RDM button (9) is pressed, the RDM indicator (26) will come on and the tracks that are played will be selected at random from the folder that is currently selected.

To exit this mode, press the button again.

**Random playback for all discs in the autochanger (music CDs only)**

Press the RDM button (9) for 2 seconds or longer (until you hear a beep). The D-RDM indicator (29) will come on and the tracks that are played will be selected at random from all discs loaded in the CD autochanger.

To exit this mode, press the button again.

**Random playback for all folders on a disc (MP3 CDs only)**

Press the RDM button (9) for 2 seconds or longer (until you hear a beep). The D-RDM indicator (29) will come on and the tracks that are played will be selected at random from all folders on the disc currently selected. To exit this mode, press the button again.

**NOTE**

- In the all discs random mode, if an MP3 CD has been loaded in the autochanger, the autochanger will skip over it to the next music CD.
- With a disc that contains both CD-DA and MP3 files, the random mode causes only files of the same format (CD-DA only or MP3 files only) to be played in a random sequence.

**To find the start of each track on a disc for playback**

Press the SCAN button (14). “SCAN” will appear on the display and the autochanger will play back the first 10 seconds of each track on the selected disc. The track number will blink while the scan mode is selected.

To exit this mode, press the button again.

**NOTE**

- Once all tracks on the disc have been scanned, playback of the disc will restart from the beginning of the track that was playing when scanning started.
- The scan mode will be cancelled when radio or CD operation is selected.
- With a disc that contains both CD-DA and MP3 files, the scan mode causes only files of the same format (CD-DA only or MP3 files only) to be played.

**CD text and MP3 title display**

E00725000331

This autochanger can display CD text and MP3 titles including ID3 tag information.

## For pleasant driving

### CD text

The autochanger can display disc and track titles for discs with converted disc and track title information. Press the DISP button (7) repeatedly to make selections in the following sequence: disc name → track name → normal display mode.

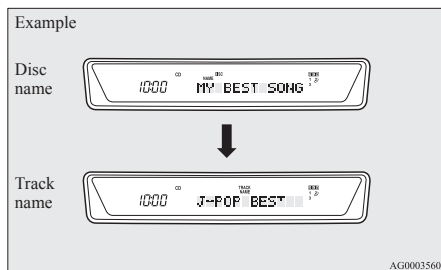

### MP3 titles

The autochanger can display folder and track titles for discs with converted folder and track information. Press the DISP button (7) repeatedly to make selections in the following sequence: folder name → track name → normal display mode.

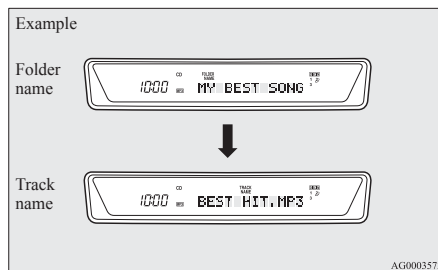

### NOTE

- The display can show up to 12 characters. If a disc name or track name has more than 12 characters, press the PAGE button (6) to view the next 12 characters.
- When there is no title information to be displayed, the display shows “NO TITLE”.
- Characters that the autochanger cannot display are shown as “\*”.

### ID3 tag information

The autochanger can display ID3 tag information for files that have been recorded with ID3 tag information.

1. Press the DISP button (7) for 2 seconds or longer to switch to the ID3 tag information. The “TAG” indicator (24) will appear on the display.
2. Press the DISP button repeatedly to make selections in the following sequence: album name → track name → artist name → normal display mode.

### NOTE

- To return from ID3 tag information to the folder name, press the DISP button (7) again for 2 seconds or longer.

- When there is no title information to be displayed, the display shows “NO TITLE”.
- The display can show up to 12 characters. If a folder name, track name, or item of ID3 tag information has more than 12 characters, press the PAGE button (6) to view the next 12 characters.
- Folder names and track names can each be displayed up to a length of 32 characters. Items of ID3 tag information can each be displayed up to a length of 30 characters.
- Characters that the autochanger cannot display are shown as “\*”.

## ***To play tracks from USB device\****

E00756100048

You can connect your iPod or USB memory device to the USB input terminal and play music files stored in the iPod or USB memory device.

See the following section for the types of connectable devices and supported files.

Refer to “Types of connectable devices and supported file specifications” on page 5-81.

See the following sections for the connecting methods, “How to connect an iPod” on page 5-80 and “How to connect a USB memory device” on page 5-80.

If your vehicle is equipped with a Bluetooth® 2.0 interface, you can play music files in your iPod or USB memory device via voice operation.

Refer to “To play iPod tracks via voice operation” on page 5-42 and “To play USB memory device tracks via voice operation” on page 5-48.

For pleasant driving

## iPod control panel and display

E00756200166

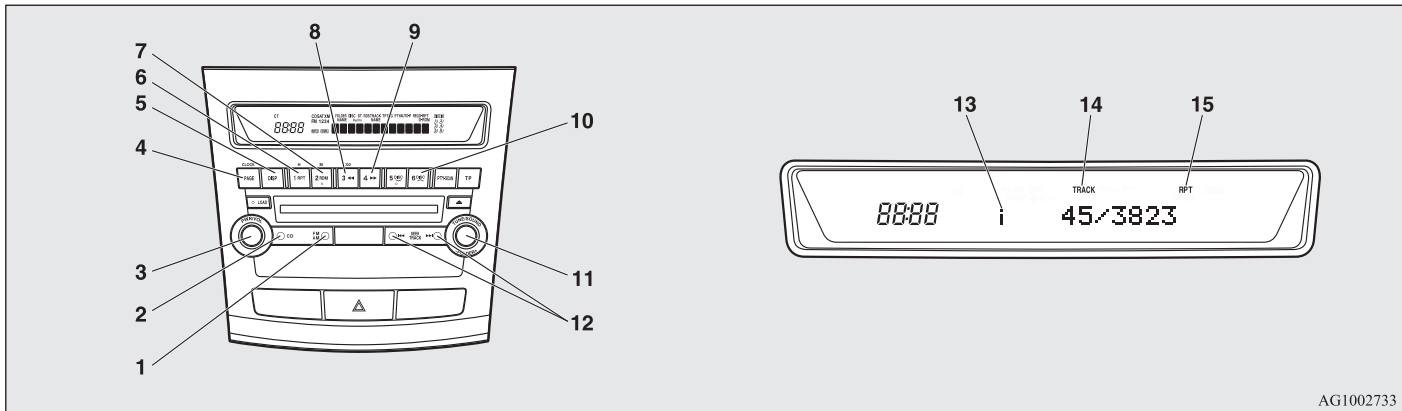

AG1002733

5

- 1- AM/FM button
- 2- CD (Mode change) button
- 3- PWR (On-Off) button
- 4- PAGE (Title scroll) button
- 5- DISP (Title display) button
- 6- RPT (Repeat) button
- 7- RDM (Random) button
- 8- ◀◀ (Fast-reverse) button

- 9- ▶▶ (Fast-forward) button
- 10- DISC UP button
- 11- FOLDER switch
- 12- TRACK (Track up/down) button
- 13- i (iPod) indicator
- 14- TRACK indicator
- 15- RPT/RDM/D-RDM indicator

## To play from an iPod

E00756300037

1. Press the PWR button (3) to turn on the audio system. The system turns on in the last mode used.
2. Connect your iPod to the USB input terminal. Refer to “How to connect an iPod” on page 5-80.
3. Press the CD button (2) several times to switch to the iPod mode. The input mode changes every time the CD button is pressed.

CD mode → iPod mode → Bluetooth® mode\* → Rearseat display mode\*

### NOTE

- If your vehicle is equipped with audio/video input RCA terminals, pressing and holding the CD button for 2 seconds or more switches the system to the AUX mode.
4. Once the device is selected, playback starts and “i” appears on the display.

### NOTE

- Depending on the condition of your iPod, it may take a longer time before the playback starts.
5. To stop the playback, press the AM/FM button (1) or CD button (2) to switch to a different mode.

### NOTE

- Buttons on the iPod are disabled while the iPod is connected to the audio system.

- To adjust the volume and tone, refer to “To adjust the volume” on pages 5-10, 5-24 and “To adjust the tone” on pages 5-10, 5-24.

### To fast-forward/reverse the track

E00756400025

To fast-forward/reverse the current track, press the ►► button (9) or ◀◀ button (8).

#### Fast-forward

To fast-forward the current track, press the ►► button (9). While the button is pressed, the track will be fast-forwarded.

#### Fast-reverse

To fast-reverse the current track, press the ◀◀ button (8). While the button is pressed, the track will be fast-reversed.

### To select a desired track

E00756500026

Press the TRACK button (12) to select the desired track number.

Press ►► : The track number increases by one.

Press ◀◀ : The track number decreases by one.

Press ►► for a long period (approx. 2 seconds or more) : The track number increases continuously while the button is pressed.

Press ◀◀ for a long period (approx. 2 seconds or more) : The track number decreases continuously while the button is pressed.

If the ◀◀ side of the button is pressed once while a track is playing, playback returns to the start of that track.

### NOTE

- Every time the track selection button is pressed, the track number in the display changes.

### To find a track from the iPod menu

E00756600030

You can select desired tracks from the “Playlists”, “Artists”, “Albums”, “Songs” or “Genre” (vehicles with Bluetooth® 2.0 interface) menus on your iPod.

Operate the following switch to select desired tracks. The selected menu or category or track is shown in the display.

Turn the FOLDER switch (11) : To show the menu or category or track.

Press the FOLDER switch (11) : To select the menu or category or track.

### NOTE

- To cancel the selection, press the DISC UP button (10) to return to the previous step.
- If no operation is performed for 10 seconds or more or other button is operated after the FOLDER button has been pressed, searching of the desired tracks is cancelled.
- If no operation is performed for 5 seconds or more after the track is displayed, playback starts.

## For pleasant driving

### To play the same track repeatedly

E00756700028

Press the RPT button (6) during playback to show “RPT” in the display.

To exit this mode, press the button again.

### To play tracks in random order

E00756900020

Press the RDM button (7) to show “RDM” in the display.

The iPod randomly selects tracks from the current category and plays the selected tracks.

To exit this mode, press the button again.

### To play tracks in each album in random order

E00757000028

Press and hold the RDM button (7) until you hear a beep to show “D-RDM” in the display.

The iPod randomly selects tracks in the album from the current category and play the selected tracks.

To exit this mode, press the button again.

### To switch the display

E00757100029

You can display the track titles, artist names and album titles recorded in the iPod.

The display changes as follows every time the DISP button (5) is pressed during playback.

Album title → Track name → Artist name → Normal display

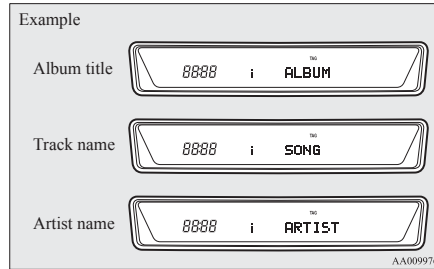

#### NOTE

- Up to 10 characters are shown in the display at once. If the title is cut off in the middle, press the PAGE button (4). The next characters are displayed every time this button is pressed.
- If no title is stored, “NO TITLE” is shown in the display.
- Characters that cannot be displayed are substituted by “•”.

## To play iPod tracks via voice operation (vehicles with Bluetooth® 2.0 interface)

E00757200017

Desired tracks can be selected and played from your iPod by “Artist”, “Album”, “Playlist” and “Genre” using voice commands.

For information concerning the voice recognition function or speaker registration function, refer to “Bluetooth® 2.0 interface” on page 5-64.

The following explains how to prepare for voice operation and play the tracks.

### Preparation for voice operation

E00757300021

To use the voice operation, press the SPEECH button (1) first.

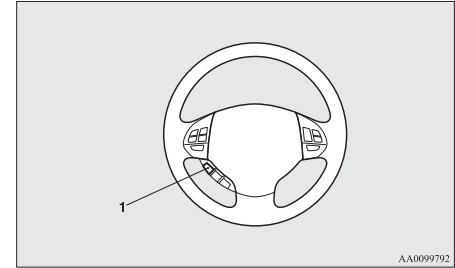

### To search by artist name

E00757400019

1. Say “Play” on the main menu.

#### NOTE

- The Bluetooth® 2.0 interface starts recognizing the connected device. If the connected device cannot be recognized or a connection error occurs, the Bluetooth® 2.0 interface starts an appropriate voice guide. Follow the voice guide.

2. After the voice guide says “Would you like to play by Artist, Album, Playlist or Genre?”, say “Artist”.

## NOTE

- If you say “Artist <name>,” you can skip step 3.
3. After the voice guide says “What Artist would you like to play?,” say the artist name.
  4. If there is only one match, the system proceeds to step 6.
  5. If there are two or more matches, the voice guide will say “More than one match was found, would you like to play <artist name>?” If you say “Yes,” the system proceeds to step 6. If you say “No,” the next matching artist is uttered by the system.

## NOTE

- If you say “No” to three or all artist names uttered by the system, the voice guide will say “Artist not found, please try again” and the system returns to step 2.
  - Search time is dependant on the number of songs on your connected device. Devices containing a large number of songs may take longer to return search results.
6. After the voice guide says “Playing <artist name>,” the system creates a playlist index for the artist.

## NOTE

- If the confirmation function is active, the voice guide confirms if the artist name is correct. If the artist name is correct, say “Yes”. If not, say “No”. After the voice guide says “Artist not found, please try again,” the system returns to step 2.

7. The system exits the voice recognition mode and starts playback.

*To search by album title*

E00757500010

1. Say “Play” on the main menu.

## NOTE

- The Bluetooth® 2.0 interface starts recognizing the connected device. If the connected device cannot be recognized or a connection error occurs, the Bluetooth® 2.0 interface starts an appropriate voice guide. Follow the voice guide.
2. After the voice guide says “Would you like to play by Artist, Album, Playlist or Genre?,” say “Album”.

## NOTE

- If you say “Album <title>,” you can skip step 3.
3. After the voice guide says “What Album would you like to play?” say the album title.
  4. If there is only one match, the system proceeds to step 6.
  5. If there are two or more matches, the voice guide will say “More than one match was found, would you like to play <album title>?” If you say “Yes,” the system proceeds to step 6. If you say “No,” the next matching album is uttered by the system.

## NOTE

- If you say “No” to three or all album titles uttered by the system, the voice guide will say “Album not found, please try again” and the system returns to step 2.

6. After the voice guide says “Playing <album title>,” the system creates a playlist index for the album title.

## NOTE

- If the confirmation function is active, the voice guide confirms if the album title is correct. If the album title is correct, say “Yes”. If not, say “No”. After the voice guide says “Album not found, please try again,” the system returns to step 2.

7. The system exits the voice recognition mode and starts playback.

*To search by playlist*

E00757600011

1. Say “Play” on the main menu.

## NOTE

- The Bluetooth® 2.0 interface starts recognizing the connected device. If the connected device cannot be recognized or a connection error occurs, the Bluetooth® 2.0 interface starts an appropriate voice guide. Follow the voice guide.
2. After the voice guide says “Would you like to play by Artist, Album, Playlist or Genre?,” say “Playlist”.

## For pleasant driving

### NOTE

- If you say “Playlist <playlist>,” you can skip step 3.  
If the device has no playlist, the voice guide will say “There are no playlists stored on device” and the system returns to step 2.
- 3. After the voice guide says “What Playlist would you like to play?,” say the playlist name.
- 4. If there is only one match, the system proceeds to step 6.
- 5. If there are two or more matches, the voice guide will say “More than one match was found, would you like to play <playlist>?” If you say “Yes,” the system proceeds to step 6. If you say “No,” the next matching playlist name is uttered by the system.

### NOTE

- If you say “No” to three or all playlist names uttered by the system, the voice guide will say “Playlist not found, please try again” and the system returns to step 2.
- 6. After the voice guide says “Playing <playlist>,” the system creates an index for the playlist.

### NOTE

- If the confirmation function is active, the voice guide confirms if the playlist name is correct. If the playlist name is correct, say “Yes”. If not, say “No”. After the voice guide says “Playlist not found, please try again,” the system returns to step 2. Refer to “Confirmation function setting” on page 5-66.

7. The system exits the voice recognition mode and starts playback.

### To search by genre

E00757700012

1. Say “Play” on the main menu.

### NOTE

- The Bluetooth® 2.0 interface starts recognizing the connected device.  
If the connected device cannot be recognized or a connection error occurs, the Bluetooth® 2.0 interface starts an appropriate voice guide. Follow the voice guide.
- 2. After the voice guide says “Would you like to play by Artist, Album, Playlist or Genre?,” say “Genre”.

### NOTE

- If you say “Genre <type>,” you can skip step 3.
- 3. After the voice guide says “What Genre would you like to play?,” say the music type.
- 4. If there is only one match, the system proceeds to step 6.
- 5. If there are two or more matches, the voice guide will say “More than one match was found, would you like to play <genre>?” If you say “Yes,” the system proceeds to step 6. If you say “No,” the next matching genre is uttered by the system.

### NOTE

- If you say “No” to three or all genres uttered by the system, the voice guide will say “Genre not found, please try again” and the system returns to step 2.

6. After the voice guide says “Playing <genre>,” the system creates an index for the genre.

### NOTE

- If the confirmation function is active, the voice guide confirms if the genre is correct. If the genre is correct, say “Yes”. If not, say “No”. After the voice guide says “Genre not found, please try again,” the system returns to step 2. Refer to “Confirmation function setting” on page 5-66.

7. The system exits the voice recognition mode and starts playback.



## USB control panel and display

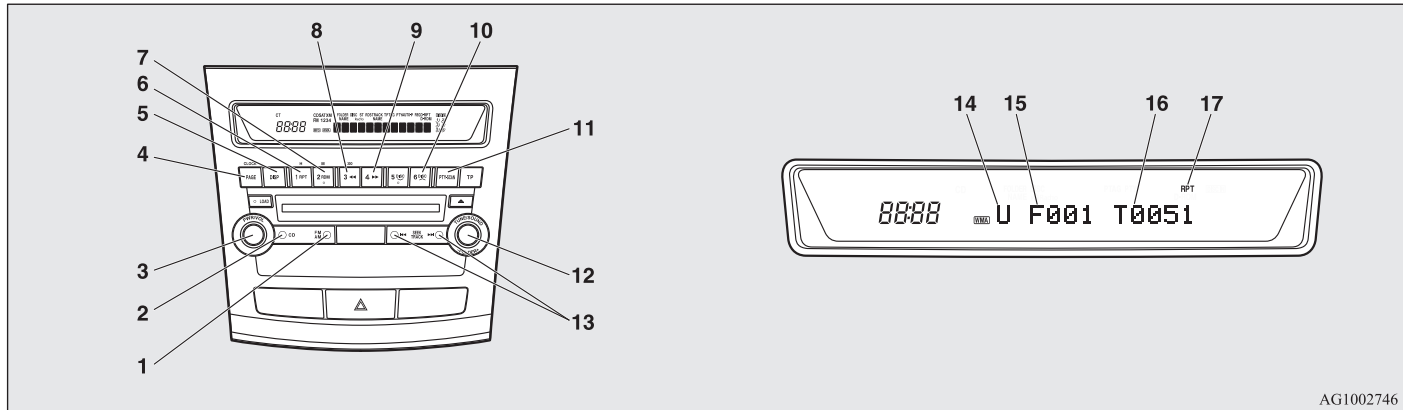

- 1- AM/FM button
- 2- CD (Mode change) button
- 3- PWR (On-Off) button
- 4- PAGE (Title scroll) button
- 5- DISP (Title display) button
- 6- RPT (Repeat) button
- 7- RDM (Random) button
- 8- ◀◀ (Fast-reverse) button
- 9- ▶▶ (Fast-forward) button

- 10- DISC UP button
- 11- SCAN button
- 12- FOLDER switch
- 13- TRACK (Track up/down) button
- 14- U (USB) indicator
- 15- FOLDER indicator
- 16- TRACK indicator
- 17- RPT/D-RPT/RDM/D-RDM/SCAN/F-SCAN indicator

## For pleasant driving

### To play from a USB memory device

E00762500034

1. Press the PWR button (3) to turn on the audio system. The system turns on in the last mode used.
2. Connect your USB memory device to the USB input terminal.  
Refer to “How to connect a USB memory device” on page 5-80.
3. Press the CD button (2) several times to switch to the USB mode. The input mode changes as follows every time the CD button is pressed.  
CD mode → USB mode → Bluetooth® mode\* → Rearseat display mode\*

#### NOTE

- If your vehicle is equipped with audio/video input RCA terminals, pressing and holding the CD button for 2 seconds or more switches the system to the AUX mode.

4. Once the device is selected, playback starts and “U” appears on the display.

#### NOTE

- Depending on the condition of your USB device, it may take a longer time before the playback starts.
5. To stop the playback, press the AM/FM button (1) or CD button (2) to switch to a different mode.

#### NOTE

- To adjust the volume and tone, refer to “To adjust the volume” on pages 5-10, 5-24 and “To adjust the tone” on pages 5-10, 5-24.

#### Supported compressed music files

E00758300233

This audio can play MP3, WMA, AAC and WAV files recorded in a USB memory device. This audio supports up to 65,535 files in 700 folders on 8 levels.

#### Folder selection order/file playback order (example)

The folder and file hierarchy in the USB memory device is shown below.

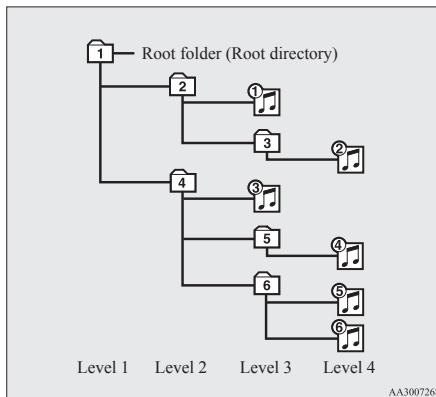

#### Folder selection

In the order



#### File selection

In the order



#### NOTE

- If a file protected by copyrights is played, “USB FILE ERROR” will appear and the file will be skipped.

#### To fast-forward/reverse the track

E00758400016

To fast-forward/reverse the current track, press the ►► button (9) or ◀◀ button (8).

#### Fast-forward

To fast-forward the current track, press the ►► button (9). When the button is pressed, the track will be fast-forwarded.

#### Fast-reverse

To fast-reverse the current track, press the ◀◀ button (8). While the button is pressed, the track will be fast-reversed.

#### To select a file

E00758500017

Press the TRACK button (13) to select the desired file number.

Press ►►1 : The file number increases by one.

Press 1◀◀ : The file number decreases by one.

Press ►►1 for a long period (approx. 2 seconds or more) : The file number increases continuously while the button is pressed.

Press 1◀◀ for a long period (approx. 2 seconds or more) : The file number decreases continuously while the button is pressed.

If the 1◀◀ side of the button is pressed once after a few seconds, playback returns to the start of that track.

#### NOTE

- Every time the TRACK button (13) is pressed, the file number in the display changes.

#### To find a track

E00758600180

You can select a folder to find a desired track.

1. Turn the FOLDER switch (12) to show the desired folder in the display.

#### NOTE

- If no operation is performed for 10 seconds or more or other button is operated after the FOLDER switch has been turned, the selected track becomes unselected and the display returns to the playback display.

2. Press the FOLDER switch (12) to select the folder.

#### NOTE

- When the DISC UP button (10) is pressed, the selected folder is played from the beginning.

3. Turn the FOLDER switch (12) to show the desired track in the display.

#### NOTE

- If no operation is performed for 5 seconds or more after the FOLDER switch (12) is turned, the displayed track is played.

4. Press the FOLDER switch (12) to select the file.

#### To play the same file repeatedly

E00758700019

Press the RPT button (6) to show “RPT” in the display. To cancel this mode, press the button again.

#### To play the files in the same folder repeatedly

E00758800010

Press and hold the RPT button (6) until you hear a beep to show “D-RPT” in the display. All tracks in the current folder are played repeatedly. To exit this mode, press the button again.

#### To play a folder in random order

E00758900011

Press the RDM button (7) to show “RDM” in the display.

The audio randomly selects tracks from the current folder and plays the selected tracks. To exit this mode, press the button again.

#### To play all folders in random order

E00759000019

Press and hold the RDM button (7) until you hear a beep to show “D-RDM” in the display.

The audio randomly selects tracks from all folders and plays the selected tracks. To exit this mode, press the button again.

#### To find the start of each track in a folder for playback

E00759100010

Press the SCAN button (11). “SCAN” is shown in the display and the tracks in the current folder are played for several seconds from the beginning. The file number flashes during this cueing playback. To exit this mode, press the button again.

#### NOTE

- Once all tracks in the folder have been cued playback will restart from the beginning of the track that was playing when cueing started.

#### To find the start of first tracks in all folders for playback

E00759200011

Press and hold the SCAN button (11) until you hear a beep to show “F-SCAN” in the display. The first tracks in all folders are played for several seconds from the beginning. Playback starts from the folder next to the one currently playing. The folder number flashes during this cueing playback. To exit this mode, press the button again.

#### NOTE

- Once the cueing playback ends, playback will start from the track at the beginning of the folder next to the one that was playing when the cueing started.

## For pleasant driving

### To switch the display

E00759300012

You can display titles with tag information.

#### Folder title

The display changes as follows every time the DISP button (5) is pressed during playback.

Folder title → File title → Normal display

#### Tag information

1. Press and hold the DISP button (5) until you hear a beep to show “TAG” in the display.
2. The display changes as follows every time the DISP button (5) is pressed briefly.  
Album title → Track title → Artist name → Genre (vehicles with Bluetooth® 2.0 interface) → Normal display

Example

Folder title



File title



AA0099776

5

- Up to 10 characters are shown in the display at once. If the title is cut off in the middle, press the PAGE button (4). The next characters are displayed every time this button is pressed.
- If no title is stored, “NO TITLE” is shown in the display.
- Characters that cannot be displayed are substituted by “•”.

### To play USB memory device tracks via voice operation (vehicles with Bluetooth® 2.0 interface)

E00759400026

Desired tracks can be selected and played from your USB memory device by “Artist”, “Album”, “Playlist” and “Genre” using voice commands.

For information concerning the voice recognition function or speaker registration function, refer to “Bluetooth® 2.0 interface” on page 5-64.

The playback sequence of tracks is the same as when an iPod is connected. Refer to the “To play iPod tracks via voice operation” on page 5-42.

### Preparation for voice operation

To use the voice operation, press the SPEECH button (1) first.

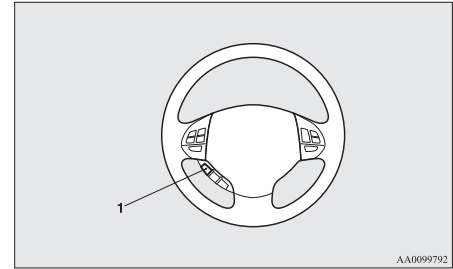

AA0099792

## NOTE

- Press and hold the DISP button (5) again until you hear a beep, and the tag information display returns to the folder title display.

## ***To play tracks from a Bluetooth® device (vehicles with Bluetooth® 2.0 interface)***

E00759700032

You can wirelessly connect a digital audio player or cellular phone supporting Bluetooth® to listen to the tracks on the connected device.

Refer to “Bluetooth® 2.0 interface” for the connecting method, etc. on page 5-64.

The following explains the basic playback method.

### NOTE

- This function may not be available depending on the connected device.
- The voice operation is not available to access music files on the connected Bluetooth® device.

## Bluetooth® device control panel and display

E00762600149

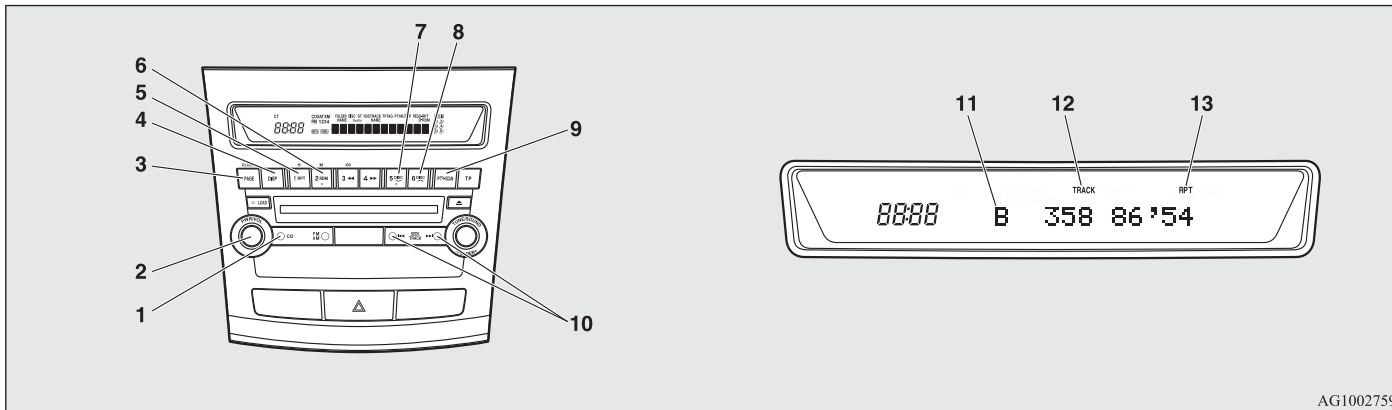

AG1002759

5

- 1- CD (Mode change) button
- 2- PWR (On-Off) button
- 3- PAGE (Title scroll) button
- 4- DISP (Title display) button
- 5- RPT (Repeat) button
- 6- RDM (Random) button
- 7- DISC DOWN (Pause/Stop) button

- 8- DISC UP (Play) button
- 9- SCAN button
- 10- TRACK (Track up/down) button
- 11- B (Bluetooth®) indicator
- 12- TRACK indicator
- 13- RPT/RDM/SCAN indicator

## To listen to tracks from a device connected via Bluetooth®

E00762700166

1. Press the PWR button (2) to turn on the audio system. The system turns on in the last mode used.
2. Press the CD button (1) several times to switch to the B (Bluetooth®) mode. The input mode changes as follows every time the CD button is pressed.  
CD mode → USB (iPod) mode → Bluetooth® mode → Rear-seat display mode\*

### NOTE

- For vehicles equipped with audio/video input RCA terminals, pressing and holding the CD button for 2 seconds or more switches the system to the AUX mode.
3. Connect your Bluetooth® device.  
Refer to “Connecting the Bluetooth® 2.0 interface and Bluetooth® device” on page 5-68.
  4. Playback starts automatically.

### NOTE

- Depending on the connected device, the playback may not start automatically.  
In this case, operate the connected device to start the playback.

## To stop the playback (if supported by the device)

E00762800024

To stop the playback, press the DISC DOWN button (7).

To restart the playback, press the DISC UP button (8).

## To pause the playback (if supported by the device)

E00762900025

To pause the playback, press the DISC DOWN button (7).

To restart the playback, press the DISC UP button (8).

## To select a track (if supported by the device)

E00763000023

Press the TRACK button (10) to select the desired track number.

Press ►►1 : The track number increases by one.

Press 1◄◄ : The track number decreases by one.

Press ►►1 for a long period (approx. 2 seconds or more) : The track number increases continuously while the button is pressed.

Press 1◄◄ for a long period (approx. 2 seconds or more) : The track number decreases continuously while the button is pressed.

If the 1◄◄ side of the button is pressed once while a track is playing, playback returns to the start of that track.

### NOTE

- Every time the track selection button is pressed, the track number in the display changes.

## To play the same track repeatedly (if supported by the device)

E00763100024

Press the RPT button (5) during playback to show “RPT” in the display.

To exit this mode, press the button again.

## To play tracks in random order (if supported by the device)

E00763200025

Press the RDM button (6) to show “RDM” in the display.

The system randomly selects and plays tracks from all tracks in the Bluetooth® device.

To exit this mode, press the button again.

## To find the start of each track for playback (if supported by the device)

E00763300026

Press the SCAN button (9). “SCAN” is shown in the display and all tracks in the Bluetooth® device are played for approximately 10 seconds from the beginning.

To exit this mode, press the button again.

## To switch the display (if supported by the device)

E00763400027

The system can display tag information.

1. Press and hold the DISP button (4) until you hear a beep to show “TAG” in the display.

## For pleasant driving

- The display changes as follows every time the DISP button (4) is pressed briefly:  
Album title → Title name → Artist name → Genre → Normal display

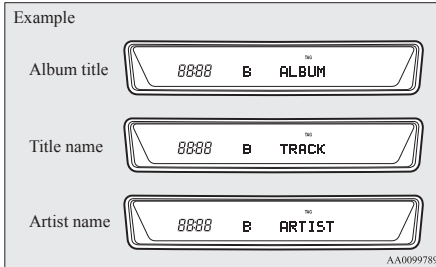

## NOTE

- Press and hold the DISP button (4) again until you hear a beep, and the tag information disappears.
- Up to 10 characters are shown in the display at once. If the title is cut off in the middle, press the PAGE button (3). The next characters are displayed every time this button is pressed.
- If no title is stored, “NO TITLE” is shown in the display.
- Characters that cannot be displayed are substituted by “•”.

## To use the external audio input function\*

E00732200553

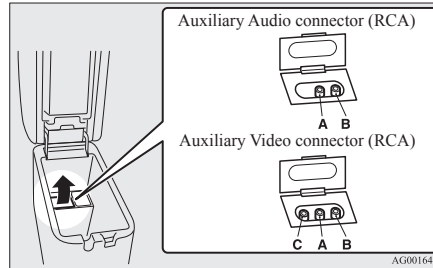

### Auxiliary Audio connector (RCA)

- A- Left audio input connector (white)
- B- Right audio input connector (red)

### Auxiliary Video connector (RCA)

- A- Left audio input connector (white)
- B- Right audio input connector (red)
- C- Video input connector (yellow)

You can listen to commercially available audio equipment, such as a portable audio system, from your vehicle's speakers, by connecting the audio equipment to the audio input connectors, which are external input connectors (pin jacks).

## NOTE

- For information on using the Auxiliary Video connector (RCA), refer to the separate owner's manual for the rear-seat display or the MITSUBISHI Multi-Communication System.

## To activate the external audio input mode

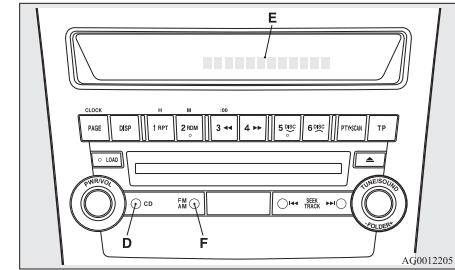

1. Use a commercially available audio cable to connect the audio equipment to the internal audio input connector.

2. [Vehicles with a premium sound system]  
Press the CD button (D) for more than 2 seconds.

The display (E) will show “AUX” and then external audio input mode will be activated.

[Vehicles with a rear-seat display]  
Press the CD button (D) for more than 2 seconds.

The display (E) will show “AUX REAR” and then the external audio input mode will be activated.

When the power of the rear-seat display is on, press the SOURCE button of the rear-seat display to activate VIDEO mode. (For details, refer to the separate rear-seat display owner's manual.)

3. To deactivate the external audio input mode, press the AM/FM button (F) or the CD button (D) to switch to another mode.



## CAUTION

- Do not operate the connected audio equipment while driving. This could distract you and an accident might occur.

### NOTE

- The connected audio equipment cannot be operated with the vehicle's audio system.
- For information on how to connect and operate the audio equipment, refer to the owner's manual for the equipment.

## To listen to a disc in the rear-seat display (vehicles with rear-seat display)

E00755100139

It is possible to listen to the audio from the rear-seat display using the vehicle's speakers.

Press the CD button to select the rear-seat display mode.

Each push of the CD button changes the mode to the next one in the following sequence: CD mode → rear-seat display mode → CD mode.

The following operation of the rear-seat display is possible from the audio system.

Source	Operation
CD	Track selection
MP3/WMA	Folder/Track selection
Video CD	Track/Scene selection
DVD video	Title/Chapter selection
DVD audio	Group/Track selection

To make your desired selection, use the TRACK button or the FOLDER button on the audio system.

### NOTE

- For more details about the rear-seat display, refer to the separate owner's manual.

## Steering wheel audio remote control switches\*

E00710000681

The remote control switch is located on the left side of the steering wheel.

It can be used when the ignition switch is in the "ON" or "ACC" positions.

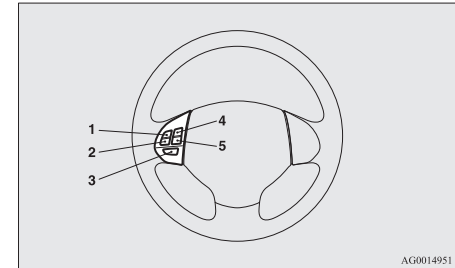

- 1- Volume up button
- 2- Volume down button
- 3- Power switch/Mode selector button
- 4- Seek up/Track up/File up/Fast-forward button
- 5- Seek down/Track down/File down/Fast-reverse button

### NOTE

- When operating the steering wheel audio remote control switches, do not operate more than one at the same time.

## For pleasant driving

### Turning on the power

Press the power switch (3) to turn on the power. When you turn the power on, the mode that was selected when the power was last turned off appears. To turn off the power, press and hold down the power switch (3) for about 2 seconds until you hear a beep.

### Volume adjustment

#### *Volume up button - 1*

While the button is pressed, the volume continues to increase.

#### *Volume down button - 2*

While the button is pressed, the volume continues to decrease.

### Mode selection

Press the mode selector button (3) to select the desired mode.

The mode changes in the following order.

AM → FM → CD → USB or iPod\* → Bluetooth®\* → AM

### To listen to the radio

Press the mode selector button (3) to select AM or FM mode.

#### *Automatic tuning*

#### **Seek up button - 4/Seek down button - 5**

After pressing these buttons, the reception of the selected station will begin.

### To listen to a CD

Press the mode selector button (3) and select CD mode.

#### *To fast-forward/reverse the disc (music CDs only)*

To fast-forward/reverse the disc, press the fast-forward button (4) or the fast-reverse button (5).

#### **Fast-forward**

You can fast-forward the disc by holding down the fast-forward button (4). While the button is kept pressed, the disc will be fast-forwarded.

#### **Fast-reverse**

You can fast-reverse the disc by holding down the fast-reverse button (5). While the button is kept pressed, the disc will be fast-reversed.

#### NOTE

- In the case of an MP3 CD, you can fast-forward and fast-reverse tracks in the same folder.

#### *To select a desired track*

You can select your desired track by using the track up button (4) or the track down button (5).

#### NOTE

- Pressing the track down button (5) once during the song will cause the system to restart playing from the beginning of the song.

### To listen to an iPod

Press the mode selector button (3) and select iPod mode.

#### *To select a desired track*

#### **Track up button - 4**

Press the button repeatedly until the desired track number appears on the display.

#### NOTE

- The track number increases continuously while the button is pressed.

#### **Track down button - 5**

Press the button repeatedly until the desired track number appears on the display.

#### NOTE

- The track number decreases continuously while the button is pressed.

### To listen to a USB memory device

Press the mode selector button (3) and select USB mode.

#### *To select a desired file*

#### **File up button - 4**

Press the button repeatedly until the desired track number appears on the display.

#### NOTE

- The track number increases continuously while the button is pressed.

#### **File down button - 5**

Press the button repeatedly until the desired track number appears on the display.

#### NOTE

- The track number decreases continuously while the button is pressed.

## Error codes

E00710101197

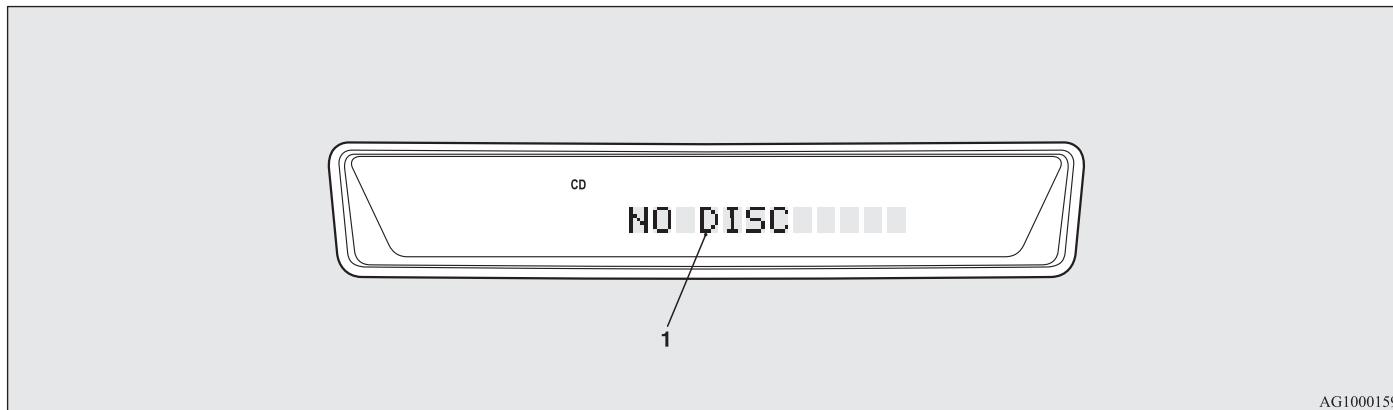

AG1000159

If an error code (1) appears in the display, take action in accordance with the table below.

## For pleasant driving

Error display	Problem	Item	Repair
NO DISC	No disc inserted	Disc is not in CD player.	Insert disc.
ERROR 01	Focus error	Disc is not loaded correctly, or condensation on disc.	Insert disc with label facing up. Remove moisture from disc.
ERROR 02	Disc error	Disc is dirty, scratched, or deformed; or excessive vehicle vibration.	Clean or replace disc. Retry when vibrations stop.
ERROR 03	Mechanism error	Loading or eject error. Pick-up is out of position.	Eject disc and reload. If disc will not eject, have the equipment inspected.
ERROR HOT	Inside of audio system is hot.	Internal protection against high temperatures.	Allow radio to cool by waiting about 30 minutes.
ERROR	Communication or power supply error	Communication error between external device and audio equipment. Power supply error of external device.	Consult a MITSUBISHI MOTORS Authorized Service Point.

**Error codes (iPod)**

E00763500129

Vehicles with Link System

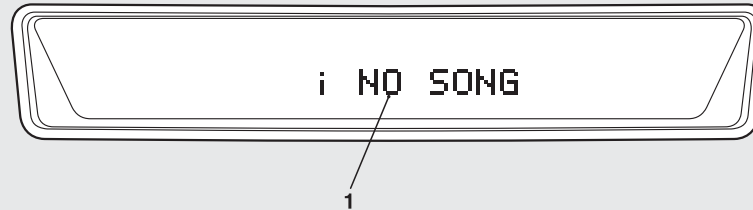

AA1007642

If an error code (1) appears in the display, take action in accordance with the table below.

Error display	Item	Repair
NO SONG	There are no playable music files.	Record music files in the iPod.
VER ERROR (Blink)	The iPod or its software cannot be recognized.	Connect a supported iPod.
USB BUS PWR (Blink)	An overcurrent or other power-supply error has occurred.	Remove the iPod. Have the vehicle inspected at a MITSUBISHI MOTORS Authorized Service Point.
CONNECT RETRY (Blink)	If the iPod indicator illuminates, the iPod cannot be authenticated.	Reconnect the iPod.
	If the iPod indicator goes out, it shows the USB communication error.	Reconnect the iPod correctly. If this error is displayed again, have the vehicle inspected at a MITSUBISHI MOTORS Authorized Service Point.

## *Error codes (USB memory device)*

E00763600117

Vehicles with Link System

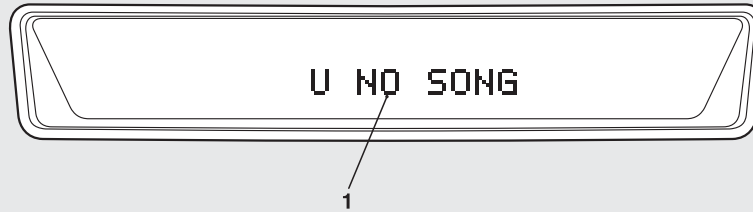

AA1007655

5

If an error code (1) appears in the display, take action in accordance with the table below.

Error display	Item	Repair
U NO SONG	There are no playable music files.	Record music files in the format supported by the USB memory device.
U FILE ERROR (Blink)	The file cannot be played.	The file is protected by copyrights, etc. An error is displayed for several seconds, and then the next playable file is played automatically.
UNSUPPORTED DEVICE (Blink)	The USB memory device cannot be recognized.	Remove the USB memory device.
UNSUPPORTED FORMAT (Blink)	The USB memory device format cannot be recognized.	Remove the USB memory device.
USB BUS PWR (Blink)	An overcurrent or other power-supply error has occurred.	Remove the USB memory device. Have the vehicle inspected at a MITSUBISHI MOTORS Authorized Service Point.
U LSI ERROR (Blink)	Internal device errors	Have the vehicle inspected at a MITSUBISHI MOTORS Authorized Service Point.
U CONNECT RETRY (Blink)	USB communication error	Reconnect the USB memory device correctly. If this error is displayed again, have the vehicle inspected at a MITSUBISHI MOTORS Authorized Service Point.

## For pleasant driving

### Handling of compact discs

E00723000382

- Use only the type of compact discs that have the mark shown in the illustration below. (Playback of CD-R or CD-RW discs may cause problems.)



- The use of special shaped, damaged compact discs (like cracked discs) or low-quality compact discs (like warped discs or burrs on the discs) such as those shown will damage the CD player.

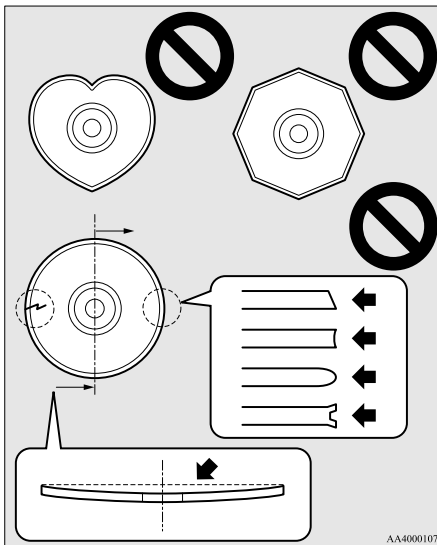

AA4000107

- In the following circumstances, moisture can form on discs and inside the audio system, preventing normal operation.
  - When there is high humidity (for example, when it is raining).
  - When the temperature suddenly rises, such as right after the heater is turned on in cold weather.

In this case, wait until the moisture has had time to dry out.

- When the CD player is subjected to violent vibrations, such as during off-road driving, the tracking may not work.

- When storing compact discs, always store them in their separate cases. Never place compact discs in direct sunlight, or in any place where the temperature or humidity is high.
- Never touch the flat surface of the disc without a label. This will damage the disc surface and could affect the sound quality. When handling a compact disc, always hold it by the outer edge and the centre hole.
- To clean a disc, use a soft, clean, dry cloth. Wipe directly from the centre hole towards the outer edge. Do not wipe in a circle. Never use any chemicals such as benzine, paint thinner, a disc spray cleaner, or an anti-static agent on the disc.

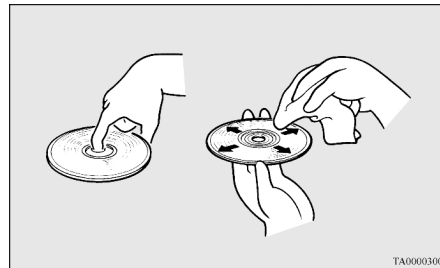

TA0000300

- Do not use a ball point pen, felt pen, pencil, etc. to write on the label surface of the disc.
- Do not put additional labels (A) or stickers (B) on compact discs. Also, do not use any compact disc on which a label or sticker has started to peel off or any compact disc that has stickiness or other contamination left by a peeled-off label or sticker. If you use such a compact disc, the CD player may stop work-



ing properly and you may not be able to eject the compact disc.

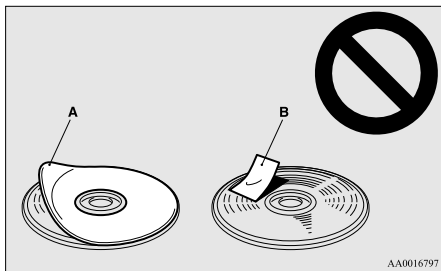

### Notes on CD-Rs/RWs

E00725100055

- You may have trouble playing back some CD-R/RW discs recorded on CD recorders (CD-R/RW drives), either due to their recording characteristics or dirt, fingerprints, scratches, etc. on the disc surface.
- CD-R/RW discs are less resistant to high temperatures and high humidity than ordinary music CDs and can therefore be damaged and rendered unplayable if left inside your vehicle for a long time.
- Depending on the combination of the writing software, the CD recorder (CD-R/RW drive), and the disc used to create a CD-R/RW, the disc might not play successfully.
- This player cannot play the CD-R/RW discs if the session is not closed.
- This player cannot play CD-R/RW discs which contain other than CD-DA or MP3 data (Video CD, etc.).
- Be sure to observe the handling instructions for the CD-R/RW disc.

## **WARNING**

- Operating the CD player in a manner other than specifically instructed herein may result in hazardous radiation exposure. Do not remove the cover and attempt to repair the CD player by yourself. There are no user serviceable parts inside. If the CD player is not working correctly, it is recommended that you have it inspected.

For pleasant driving

## Antenna

E00710500312

### Roof antenna

Before listening to the radio, raise the antenna until you feel a click.

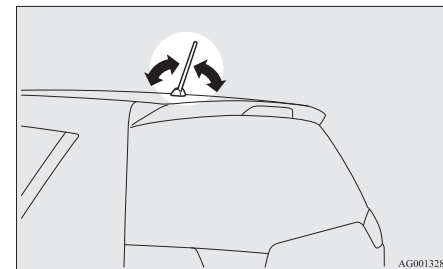

### To remove

Turn the pole (A) anticlockwise.

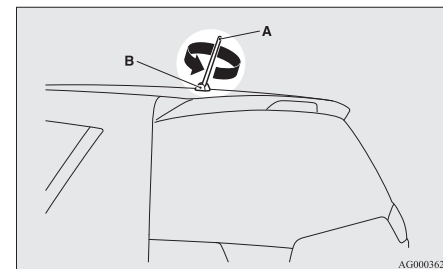

### To install

Screw the pole (A) clockwise into the base (B) until it is securely retained.

## For pleasant driving

### NOTE

- Be sure to remove the roof antenna in the following cases:
  - When using an automatic car wash.
  - When placing a car cover over the vehicle.
- Before driving into a structure that has a low ceiling, fold down the antenna to prevent it from hitting the ceiling.

## Digital clock\*

E00711800501

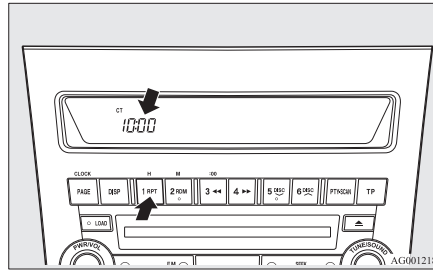

Automatic mode and manual mode is available for digital clock adjustment.

Select the automatic mode or the manual mode by performing the following operations:

1. Press the PWR switch (A) to turn ON the audio system.
2. Enter the function setup mode by pressing the TUNE switch (B) for 2 seconds or longer.

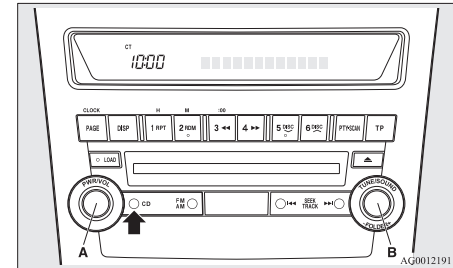

AG0012191

5

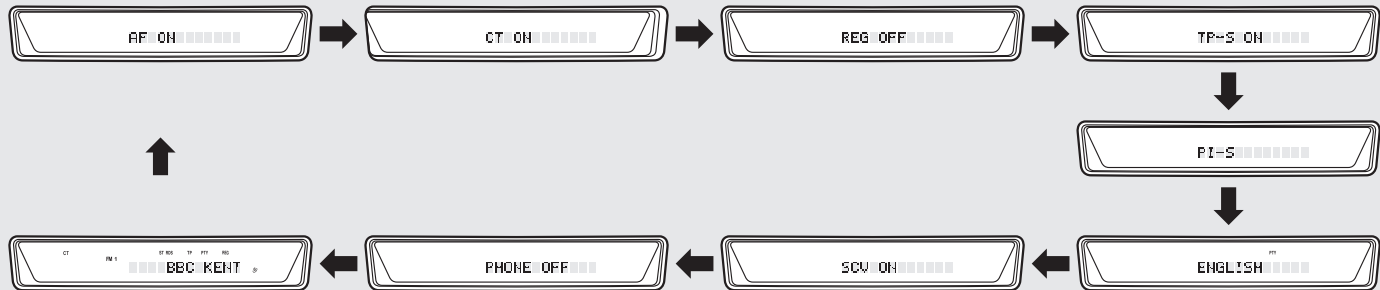

AG1000898

3. Press the TUNE switch (B) repeatedly to select the CT (Clock Time) mode.

The order is: AF → CT → REG → TP-S → PI-S → Language of PTY display → SCV → PHONE → Function setup mode OFF.

(Refer to “Function setup mode” on pages 5-17, 5-31.)

**NOTE**

- Although “PHONE” appears on the display, the PHONE function is inoperative.
- 4. Turn the TUNE switch (B) left and right and select either ON or OFF.

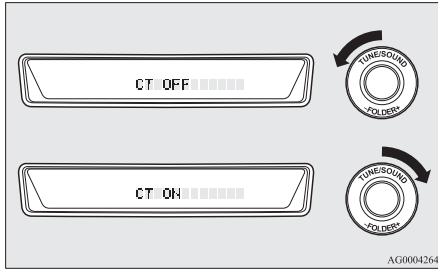

CT ON- Automatic mode  
 CT OFF- Manual mode

**NOTE**

- After selecting a mode, you can leave the function setup mode by taking either of the following steps:
  - Press the TUNE switch (B) for at least 2 seconds.
  - Make no entry for 10 seconds.

**Automatic mode**

The automatic adjustment mode can set the local time automatically by using the signal from local RDS stations. In this mode, CT (A) is shown in the display. Refer to “Radio data system (RDS)” on pages 5-14, 5-28.

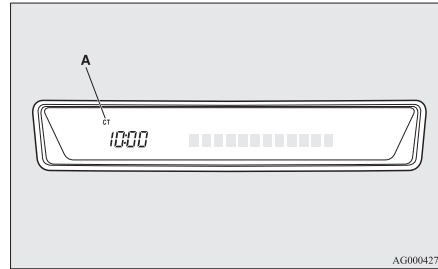

**Manual mode**

The manual mode is also available in case the automatic mode shows the incorrect time when the adjacent local RDS stations are located in a different time zone. Refer to “Radio data system (RDS)” on pages 5-14, 5-28.

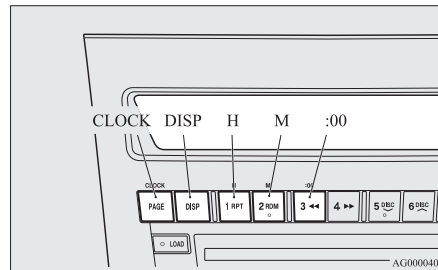

Set the time by pressing the various buttons as described below.

1. Keep the CLOCK button pressed until the time display flashes.
2. Press the appropriate buttons to adjust the time.
  - “H” button - To adjust the hour
  - “M” button - To adjust the minutes
  - “:00” button - To reset the minutes to zero
    - 10:00 - 10:29.....Changes to 10:00
    - 10:30 - 10:59.....Changes to 11:00
3. Once the time is set, press the “DISP” button, and the time display will stop flashing. When a time adjustment has been made, the flashing stops automatically.

**NOTE**

- If the battery cables are disconnected during repairs or for any other reason, reset the clock to the correct time after they are reconnected.
- The digital clock does not have a second display. When the “minute” display is adjusted and reset to zero, the clock begins at zero seconds for the selected minute.

## For pleasant driving

### Link System\*

E00764500113

The Link System takes overall control of the devices connected via the USB input terminal or the Bluetooth® 2.0 interface allowing the connected devices to be operated by using the switches in the vehicle or voice commands. See the following section for details on how to operate.

Refer to “Bluetooth® 2.0 interface” on page 5-64.  
Refer to “USB input terminal” on page 5-80.

Refer to “To play tracks from USB device” on page 5-39.

Refer to “To play tracks from a Bluetooth® device” on page 5-49.

Refer to “To use the external audio input function\*” on page 5-52.

Bluetooth® is a registered trademark of BLUE-TOOTH SIG, INC.

## 5 Link System End User Licence Agreement

E00764600013

You have acquired a device that includes software licensed by MITSUBISHI MOTORS CORPORATION from JOHNSON CONTROLS Inc (the automotive experience business unit), and their subsequent 3<sup>rd</sup> party suppliers. For a complete list of these 3<sup>rd</sup> party products and their end user licence agreements, please go to the following website.  
<http://www.jciblueconnect.com/faq/fulldisclosure.pdf>

### Bluetooth® 2.0 interface\*

E00726000471

The Bluetooth® 2.0 interface allows for making/receiving hands-free calls in the vehicle using a Bluetooth® compatible cellular phone based on the wireless communication technology commonly known as Bluetooth®. It also allows the user to play music, saved in a Bluetooth® music player, from the vehicle’s speakers.

The system is equipped with a voice recognition function, which allows you to make hands-free calls by simple switch operations and voice command operations using a defined voice tree.

The Bluetooth® 2.0 interface can be used when the ignition switch is in the “ON” or “ACC” position.

Before you can use the Bluetooth® 2.0 interface, you must pair the Bluetooth® device and Bluetooth® 2.0 interface. Refer to “Connecting the Bluetooth® 2.0 interface and Bluetooth® device” on page 5-68.

Bluetooth® is a registered trademark of BLUE-TOOTH SIG, INC.

### WARNING

- **Although the Bluetooth® 2.0 interface allows you to make hands-free calls, if you choose to use the cellular phone while driving, you must not allow yourself to be distracted from the safe operation of your vehicle. Anything, including cellular phone usage, that distracts you from the safe operation of your vehicle increases your risk of an accident.**

### WARNING

- **Refer to and comply with all state and local laws in your area regarding cellular phone usage while driving.**

#### NOTE

- If the ignition switch is left in the “ACC” position, the accessory power will automatically turn off after a certain period of time and you will no longer be able to use the Bluetooth® 2.0 interface. The accessory power comes on again if the ignition switch is turned from the “ACC” position. Refer to “ACC power auto-cutout function” on page 4-13.
- The Bluetooth® 2.0 interface cannot be used if the Bluetooth® device has a flat battery or the device power is turned off.
- Hands-free calls will not be possible if your phone does not have service available.
- If you place the Bluetooth® device in the vehicle’s third seat or luggage compartment, you may not be able to use the Bluetooth® 2.0 interface.
- Some Bluetooth® devices are not compatible with the Bluetooth® 2.0 interface.

Steering control switch → p. 5-65

Voice recognition function → p. 5-65

Useful voice commands → p. 5-66

Speaker enrollment function → p. 5-67

Connecting the Bluetooth® 2.0 interface and Bluetooth® device → p. 5-68

Operating a music player connected via Bluetooth® → p. 5-71

How to make or receive hands-free calls → p. 5-71  
 Phone book function → p. 5-73

## Steering control switch

E00727200119

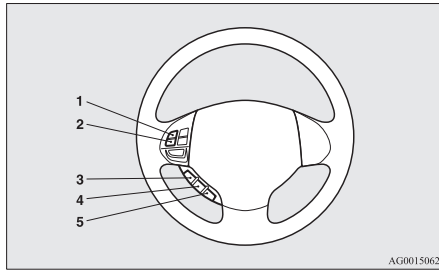

- 1- Volume up button
- 2- Volume down button
- 3- SPEECH button
- 4- PICK-UP button
- 5- HANG-UP button

### Volume up button

Press this button to increase the volume.

### Volume down button

Press this button to decrease the volume.

### SPEECH button

- Press this button to change to voice recognition mode.  
 While the system is in voice recognition mode, “Listening” will appear on the audio display.

- If you press the button briefly while in voice recognition mode, it will interrupt prompting and allow voice command input. Pressing the button longer will deactivate the voice recognition mode.
- Pressing this button briefly during a call will enable voice recognition and allow voice command input.

### PICK-UP button

- Press this button when an incoming call is received to answer the telephone.
- When another call is received during a call, press this button to put the first caller on hold and talk to the new caller.
  - In such circumstances, you can press the button briefly to switch between callers. You will switch to the first caller and the other caller will be put on hold.
  - To establish a three-way call in such situations, press the SPEECH button to enter voice recognition mode and then say “Join calls”.

### HANG-UP button

- Press this button when an incoming call is received to refuse the call.
- Press this button during a call to end the current call.  
 When another call is on hold, you will switch to that call.
- If this button is pressed in the voice recognition mode, the voice recognition mode will be deactivated.

## NOTE

- When you press the SPEECH button to enter voice recognition mode with a cellular phone paired to the system, current information on the cellular phone, such as “remaining battery life,” “signal strength” or “roaming,” will be displayed on the audio display.\*  
 \*: Some cellular phones will not send this information to the Bluetooth® 2.0 interface.
- Call waiting and three-way calls can be used by the Bluetooth® 2.0 interface, only if it is possible to use those services with your cellular phone.

## Voice recognition function

E00727300413

The Bluetooth® 2.0 interface is equipped with a voice recognition function.  
 Simply say voice commands and you can perform various operations and make or receive hands-free calls.

With the Bluetooth® 2.0 interface, voice recognition is possible for English, French, Spanish, Italian, German, Dutch and Portuguese. The factory setting is English.

## NOTE

- If the voice command that you say differs from the predefined command or cannot be recognised due to ambient noise or some other reason, the Bluetooth® 2.0 interface will ask you for the voice command again up to 3 times.

## For pleasant driving

- For best performance and further reduction of ambient noise, the vehicle windows should be closed while engaging the voice recognition function.
- Some voice commands have alternative commands.
- Depending on the selected language, some functions may not be available.

### Selecting the Language

1. Press the SPEECH button.
2. Say “Setup”.
3. Say “Language.”
4. The voice guide will say “Select a language: English, French, Spanish, Italian, German, Dutch or Portuguese” Say the desired language. (Example: Say “English.”)
5. The voice guide will say “English (French, Spanish, Italian, German, Dutch or Portuguese) selected. Is this correct?” Say “Yes.” Answer “No” to return to Step 4.

5

### NOTE

- The voice guide will repeat the same message twice. The first message is in the current language, and the second message is in the selected language.
- If many entries are registered in the vehicle phone book, changing the language will take longer.
- Changing the language deletes the mobile phone book imported to the Bluetooth® 2.0 interface. If you wish to use it, you will have to import it again.

6. When the voice guide says “English (French, Spanish, Italian, German, Dutch or Portuguese) selected,” the language change process will be completed and the system will return to the main menu.

### Useful voice commands

E0076000019

#### Help function

E00760100010

The Bluetooth® 2.0 interface is equipped with a help function.

If you say “Help” when the system is waiting for a voice command input, the system will tell you a list of the commands that can be used under the circumstances.

#### Cancelling

E00760200011

There are two cancel functions.

If you are at the main menu, say “Cancel” to exit from the Bluetooth® 2.0 interface.

If you are anywhere else within the system, say “Cancel” to return to the main menu.

#### Confirmation function setting

E00760400013

The Bluetooth® 2.0 interface is equipped with a confirmation function.

With the confirmation function activated, you are given more opportunities than normal to confirm a command when making various settings to the Bluetooth® 2.0 interface. This allows you to decrease the possibility that a setting is accidentally changed. The confirmation function can be turned on or off by following the steps below.

1. Press the SPEECH button.
2. Say “Setup”.
3. Say “Confirmation prompts”.

4. The voice guide will say “Confirmation prompts are <on/off>. Would you like to turn confirmation prompts <off/on>”. Answer “Yes” to change the setting or answer “No” to keep the current setting.
5. The voice guide will say “Confirmation prompts are <off/on>” and then the system will return to the main menu.

### Security function

E00760500157

It is possible to use a password as a security function by setting a password of your choice for the Bluetooth® 2.0 interface.

When the security function is turned on, it is necessary to make a voice input of a 4-digit password in order to use all functions of the Bluetooth® 2.0 interface, except for reception.

#### Setting the password

Use the following procedure to turn on the security function by setting a password.

1. Press the SPEECH button.
2. Say “Setup”.
3. Say “Password.”
4. The voice guide will say “Password is disabled. Would you like to enable it?” Answer “Yes.” Answer “No” to cancel the setting of the password and return to the main menu.
5. The voice guide will say “Please say a 4-digit password. Remember this password. It will be required to use this system”. Say a 4-digit number which you want to set as a password.

6. For confirmation purposes, the voice guide will say “Password <4-digit password>. Is this correct?” Answer “Yes.” Answer “No” to return to the password input in Step 5.
7. When the registration of the password is completed, the voice guide will say “Password is enabled” and the system will return to the main menu.

**NOTE**

- Password will be required to access the system after the next ignition cycle.
- It is required for a little time after engine stop that the entered password is actually recorded in the system.  
If the ignition switch is made to “ACC” or “ON” or the engine is started immediately after engine stop, there is a case when the entered password is not recorded in the system. At this time, please try to enter the password again.

**Entering the password**

If a password has been set and the security function is enabled, the voice guide will say “Hands-free system is locked. State the password to continue” when the SPEECH button is pressed to enter voice recognition mode. Say the 4-digit password number to enter the password.

If the entered password is wrong, the voice guide will say “<4- digit password>, Incorrect password. Please try again”. Enter the correct password.

**NOTE**

- You can re-enter the password as many times as you want.

- If you have forgotten your password, say “Cancel” to quit the voice input mode and then check with a MITSUBISHI MOTORS Authorized Service Point.

**Disabling the password**

Use the following procedure to turn off the security function by disabling the password.

**NOTE**

- System must be unlocked to disable the password.
  1. Press the SPEECH button.
  2. Say “Setup”.
  3. Say “Password.”
  4. The voice guide will say “Password is enabled. Would you like to disable it?” Answer “Yes.” Answer “No” to cancel the disabling of the password and return to the main menu.
  5. When the disabling of the password is completed, the voice guide will say “Password is disabled” and the system will return to the main menu.

**Speaker enrollment function**

E00727400209

The Bluetooth® 2.0 interface can use the speaker enrollment function to create a voice model for one person per language.

This makes it easier for the Bluetooth® 2.0 interface to recognise voice commands said by you. You can turn a voice model registered with the speaker enrollment function on and off whenever you want.

**Speaker enrollment**

E00727500226

It takes about 2 to 3 minutes to complete the speaker enrollment process.

To ensure the best results, run through the process while in the driver’s seat, in an environment that is as quiet as possible (when there is no rain or strong winds and the vehicle windows are closed). Please turn off your phone while in speaker enrollment to prevent interruption of the process.

Use the following procedure for speaker enrollment.

1. Stop your vehicle in a safe area, put the gearshift lever (M/T) in the “N” (Neutral) position, or the selector lever (A/T or CVT) or gearshift lever (Twin Clutch SST) in the “P” (PARK) position, and pull the parking brake lever.

**NOTE**

- Speaker enrollment is not possible unless the vehicle is parked. Make sure you park the vehicle in a safe area before attempting speaker enrollment.
  2. Press the SPEECH button.
  3. Say “Voice training”.
  4. The voice guide will say “This operation must be performed in a quiet environment while the vehicle is stopped. See the owner’s manual for the list of required training phrases. Press and release the SPEECH button when you are ready to begin. Press the HANG-UP button to cancel at any time”. Press the SPEECH button to start the speaker enrollment process.

## For pleasant driving

### NOTE

- If you do not start the speaker enrollment process within 3 minutes of pressing the SPEECH button, the speaker enrollment function will time out.  
The voice guide will say “Speaker Enrollment has timed out”. The system will then beep and the voice recognition mode will be deactivated.

5. The voice guide will prompt for phrase 1. Repeat the corresponding phrase listed in table “Enrollment commands” on page 5-79.  
The system will register your voice and then move on to the registration of the next command. Continue the process until all phrases have been registered.

### NOTE

- To repeat the most recent voice training command, press and release the SPEECH button.
  - If you press the HANG-UP button anytime during the process, the system will beep and stop the speaker enrollment process.
6. When all enrollment commands have been read out, the voice guide will say “Speaker enrollment is complete”. The system will then end the speaker enrollment process and return to the main menu.

### NOTE

- Completing the speaker enrollment process will turn on the voice model automatically.
- The commands “Help” and “Cancel” will not work in this mode.

### *Enabling and disabling the voice model and re-training*

E00727600096

You can turn a voice model registered with the speaker enrollment function on and off whenever you want.

You can also retrain the system.

Use the following procedure to perform these actions.

1. Press the SPEECH button.
2. Say “Voice training”.
3. If you have completed a speaker enrollment process once already, the voice guide will say either “Enrollment is enabled. Would you like to disable or retrain?” or “Enrollment is disabled. Would you like to enable or retrain?”
4. When enrollment is “enabled”, the voice model is on; when enrollment is “disabled”, the voice model is off. Say the command that fits your needs.  
Say “Retrain” to start the speaker enrollment process and recreate a new voice model. (Refer to “Speaker enrollment” on page 5-67.)

### **Connecting the Bluetooth® 2.0 interface and Bluetooth® device**

E00760600174

Before you can make or receive hands-free calls or play music using the Bluetooth® 2.0 interface function, you must pair the Bluetooth® device and Bluetooth® 2.0 interface.

### NOTE

- Pairing is required only when the device is used for the first time. Once the device has been paired with the Bluetooth® 2.0 interface, you only need to bring the device into the vehicle next time and the device will automatically connect to the Bluetooth® 2.0 interface (if supported by the device). The device must have Bluetooth® turned ON to connect.

Up to 7 Bluetooth® devices can be paired with the Bluetooth® 2.0 interface.

If multiple paired Bluetooth® devices are available in the vehicle, the cellular phone or music player most recently connected is automatically connected to the Bluetooth® 2.0 interface.

You can also change a Bluetooth® device to be connected.

### *To pair*

To pair a Bluetooth® device with the Bluetooth® 2.0 interface, follow the steps below.

1. Stop your vehicle in a safe area, put the gearshift lever (M/T) in the “N” (Neutral) position, or the selector lever (A/T or CVT) or gearshift lever (Twin Clutch SST) in the “P” (PARK) position, and pull the parking brake lever.

### NOTE

- You cannot pair Bluetooth® devices with the Bluetooth® 2.0 interface unless the vehicle is parked. Before pairing a Bluetooth® device with the Bluetooth® 2.0 interface, confirm that the vehicle is parked in a safe location.



2. Press the SPEECH button.
3. Say "Setup".
4. Say "Pairing options."
5. The voice guide will say "Select one of the following: pair, edit, delete, or list." Say "Pair."

**NOTE**

- If 7 devices have already been paired, the voice guide will say "Maximum devices paired" and then the system will end the pairing process. To register a new device, delete one device and then repeat the pairing process. (Refer to "Selecting a device: Deleting a device" on page 5-69.)

6. The voice guide will say "Please say a 4-digit pairing code." Say a 4-digit number. When the confirmation function is on, the system will confirm whether the number said is acceptable. Answer "Yes." Answer "No" to return to pairing code selection.

**NOTE**

- Some Bluetooth® devices require a specific pairing code. Please refer to the device manual for pairing code requirements.

- The pairing code entered here is only used for the Bluetooth® connection certification. It is any 4-digit number the user would like to select.

Remember the pairing code as it needs to be keyed into the Bluetooth® device later in the pairing process.

Depending on the connection settings of the Bluetooth® device, this code may have to be entered each time you connect the Bluetooth® device to the Bluetooth® 2.0 interface. For the default connection settings, refer to the instructions for the device.

7. The voice guide will say "Start pairing procedure on the device. See the device manual for instructions." Enter in the Bluetooth® device the 4-digit number you have registered in Step 6.

**NOTE**

- If the Bluetooth® 2.0 interface cannot recognize the Bluetooth® device, the voice guide will say "Pairing has timed out" and the pairing process will be cancelled.

Confirm that the device you are pairing supports Bluetooth®, and try pairing it again.

- If you enter the wrong number, the voice guide will say "Pairing failed" and the pairing process will be cancelled.

Confirm the number is right, and try pairing it again.

8. The voice guide will say "Please say the name of the device after the beep." You can assign a desired name for the Bluetooth® de-

vice and register it as a device tag. Say the name you want to register after the beep.

**NOTE**

- When the confirmation function is on, after repeating the device tag you have said, the voice guide will ask "Is this correct?" Answer "Yes."

To change the device tag, answer "No" and then say the device tag again.

9. The voice guide will say "Pairing complete," after which a beep will be played and the pairing process will end.

**Selecting a device**

E00760700104

If multiple paired Bluetooth® devices are available in the vehicle, the cellular phone or music player most recently connected is automatically connected to the Bluetooth® 2.0 interface.

You can connect to the other paired cellular phone or music player by following setting change procedures.

**To select a cellular phone**

1. Press the SPEECH button.
2. Say "Setup".
3. Say "Select phone."
4. After the voice guide says "Please say," the numbers of the cellular phones and device tags of corresponding cellular phones will be read out in order, starting with the cellular phone that has been most recently connected. Say the number of the cellular phone that you want to connect to.

When the confirmation function is on, the system will ask you again whether the phone that you want to connect to is correct. An-

## For pleasant driving

swer “Yes” to continue and connect to the cellular phone.

Answer “No,” and the voice guide will say “Please say.”

Say the number of the phone that you want to connect to.

### NOTE

- You can connect to a phone at any time by pressing the SPEECH button and saying the number, even before all of the paired numbers and device tags of corresponding cellular phones are read out by the system.

5. The selected phone will be connected to the Bluetooth® 2.0 interface. The voice guide will say “<device tag> selected” and then the system will return to the main menu.

### To select a music player

1. Press the SPEECH button.
2. Say “Setup”.
3. Say “Select music player.”
4. After the voice guide says “Please say,” the numbers of the music players and device tags of corresponding music players will be read out in order, starting with the music player that has been most recently connected.  
Say the number of the music player that you want to connect to.  
When the confirmation function is on, the system will ask you again whether the music player that you want to connect to is correct.  
Answer “Yes” to continue and connect to the music player.  
Answer “No,” and the voice guide will say “Please say.”  
Say the number of the music player that you want to connect to.

### NOTE

- You can connect to a music player at any time by pressing the SPEECH button and saying the number, even before all of the paired numbers and device tags of corresponding music players are read out by the system.

5. The selected music player will be connected to the Bluetooth® 2.0 interface.  
The voice guide will say “<device tag> selected” and then the system will return to the main menu.

### Deleting a device

Use the following procedure to delete a paired Bluetooth® device from the Bluetooth® 2.0 interface.

1. Press the SPEECH button.
2. Say “Setup”.
3. Say “Pairing options.”
4. The voice guide will say “Select one of the following: pair, edit, delete, or list.” Say “Delete.”
5. After the voice guide says “Please say,” the numbers of the devices and device tags of corresponding devices will be read out in order, starting with the device that has been most recently connected. After it completes reading all pairs, the voice guide will say “or all.”  
Say the number of the device that you want to delete from the system.  
If you want to delete all paired phones from the system, say “All.”
6. For confirmation purposes, the voice guide will say “Deleting <device tag> <number>. Is this correct?” or “Deleting all devices. Is this correct?”  
Answer “Yes” to delete the phone(s).  
Answer “No” to return to Step 4.

7. The voice guide will say “Deleted,” and then the system will end the device deletion process.

### NOTE

- If the device deletion process fails for some reason, the voice guide will say “Delete failed” and then the system will cancel deleting the device.

### To check a paired Bluetooth® device

E00760800017

You can check a paired Bluetooth® device by following the steps below.

1. Press the SPEECH button.
2. Say “Setup”.
3. Say “Pairing options.”
4. The voice guide will say “Select one of the following: pair, edit, delete, or list.” Say “List.”
5. The voice guide will read out device tags of corresponding devices in order, starting with the Bluetooth® device that has been connected most recently.
6. After the device tags of all paired Bluetooth® devices have been read, the system will say “End of list, would you like to start from the beginning?”  
To hear the list again from the beginning, answer “Yes.”  
When you are done, answer “No” to return to the main menu.

## NOTE

- If you press and release the SPEECH button and say “Continue” or “Previous” while the list is being read, the system will advance or rewind the list.  
Say “Continue” to proceed to the device with the next highest number or “Previous” to return to the phone with the previous number.
- You can change the device tag by pressing and releasing the SPEECH button and then saying “Edit” while the list is being read.
- You can change the phone to be connected by pressing and releasing the SPEECH button and then saying “Select phone” while the list is being read.
- You can change the music player to be connected by pressing and releasing the SPEECH button and then saying “Select music player” while the list is being read.

**Changing a device tag**

E00760900018

You can change the device tag of a paired cellular phone or music player.

Follow the steps below to change a device tag.

1. Press the SPEECH button.
2. Say “Setup”.
3. Say “Pairing options.”
4. The voice guide will say “Select one of the following: pair, edit, delete, or list.” Say “Edit.”
5. The voice guide will say “Please say,” and read out the numbers of the Bluetooth® devices and device tags of corresponding devices in order, starting with the Bluetooth® that has been most recently connected.  
After all paired device tags have been read, the voice guide will say “Which device,

please?” Say the number of the device tag you want to change.

## NOTE

- You can press and release the SPEECH button while the list is being read, and immediately say the number of the device tag you want to change.
6. The voice guide will say “New name, please.” Say the name you want to register as a new device tag.  
When the confirmation function is on, the voice guide will say “<New device tag>. Is this correct?” Answer “Yes.”  
Answer “No,” to say the new device tag you want to register again.
  7. The device tag is changed.  
When the change is complete, the voice guide will say “New name saved” and then the system will return to the main menu.

**Operating a music player connected via Bluetooth®**

E00761000016

For the operation of a music player connected via Bluetooth®, refer to “To play tracks from a Bluetooth® device” on page 5-49.

**How to make or receive hands-free calls**

E00761100017

You can make or receive hands-free calls using a Bluetooth® compatible cellular phone connected to the Bluetooth® 2.0 interface.  
You can also use the phone books in the Bluetooth® 2.0 interface to make calls without dialling telephone numbers.

To make a call → p. 5-71

SEND function → p. 5-72

Receiving calls → p. 5-73

MUTE function → p. 5-73

Switching between hands-free mode and private mode → p. 5-73

**To make a call**

E00761200148

You can make a call in the following 3 ways using the Bluetooth® 2.0 interface:

Making a call by saying a telephone number, making a call using the Bluetooth® 2.0 interface’s phone book, and making a call by redialing.

**Making a call by using the telephone number**

You can make a call by saying the telephone number.

1. Press the SPEECH button.
2. Say “Dial.”
3. After the voice guide says “Number please,” say the telephone number.
4. The voice guide will say “Dialing <number recognised>.”

The Bluetooth® 2.0 interface will then make the call.

When the confirmation function is on, the system will confirm again the telephone number. To continue with that number, answer “Yes.”

To change the telephone number, answer “No.” The system will say “Number please” then say the telephone number again.

## NOTE

- In the case of English, the system will recognise both “zero” and “oh” (Letter “o”) for the number “0.”

## For pleasant driving

- The Bluetooth® 2.0 interface supports numbers (0 to 9) and characters (+, # and \*).
- The maximum supported telephone number length is as follows:
  - International telephone number: + and telephone numbers (to 18 digits).
  - Except for international telephone number: telephone numbers (to 19 digits).

### Making a call using a phone book

You can make calls using the vehicle phone book or mobile phone book of the Bluetooth® 2.0 interface.

For details on the phone books, refer to “Phone book function” on page 5-73.

1. Press the SPEECH button.
2. Say “Call.”

#### NOTE

- If you say “Call” when the vehicle phone book and the mobile phone book are empty, the voice guide will say “The vehicle phone book is empty. Would you like to add a new entry now?” Answer “Yes,” and the voice guide will say “Entering the phone book - new entry menu.” You can now create data in the vehicle phone book. Answer “No,” to return to the main menu.
3. After the voice guide says “Name please,” say the name you want to call, from those registered in the phone book.
  4. If there is only one match, the system proceeds to Step 5.

If there are two or more matches, the voice guide will say “More than one match was found, would you like to call <returned

name>.” If that person is the one you want to call, answer “Yes.”

Answer “No,” and the name of the next matching person will be uttered by the voice guide.

#### NOTE

- If you say “No” to all names read by the system, the voice guide will say “Name not found, returning to main menu” and the system will return to the main menu.

5. If only one telephone number is registered under the name you just said, the voice guide proceeds to Step 6.

If two or more telephone numbers are registered that match the name you just said, the voice guide will say “Would you like to call <name> at [home], [work], [mobile], or [other]?” Select the location to call.

#### NOTE

- If the name you selected has matching data in the vehicle phone book but no telephone number is registered under the selected location, the voice guide will say “{home/work/mobile/other} not found for <name>.” Would you like to add location or try again?” Say “Try again,” and the system will return to Step 3. Say “Add location” and you can register an additional telephone number under the selected location.

- If the name you selected has matching data in the mobile phone book but no telephone number is registered under the selected location, the voice guide will say “{home/work/mobile/other} not found for <name>.” Would you like to try again?”

Answer “Yes,” and the system will return to Step 3.

Answer “No,” and the call will be cancelled. Start over again from Step 1.

6. The voice guide will say “Calling <name> <location>” and then the system will dial the telephone number.

#### NOTE

- When the confirmation function is on, the system will ask if the name and location of the receiver are correct. If the name is correct, answer “Yes.” If you want to change the name or location to call, answer “No.” The system will return to Step 3.

### Redialing

You can redial the last number called, based on the history of dialed calls in the paired cellular phone.

Use the following procedure to redial.

1. Press the SPEECH button.
2. Say “Redial.”

### SEND function

E00761300035

During a call, press the SPEECH button to enter voice recognition mode, then say “<numbers> SEND” to generate DTMF tones.

For example, if during a call you need to simulate the press of a phone button as a response to an automated system, press the SPEECH button and speak “1 2 3 4 pound SEND” and the 1234# will be sent on your cellular phone.

### Receiving calls

E00761600012

If an incoming phone call is received while the ignition switch is in the “ACC” or “ON” position, the audio system will be automatically turned on and switched to the incoming call, even when the audio system was originally off.

The voice guide announcement for the incoming call will be output from the front passenger’s seat speaker.

If the CD player or radio was playing when the incoming call was received, the audio system will mute the sound from the CD player or radio and output only the incoming call.

To receive the call, press the PICK-UP button on the steering wheel control switch.

When the call is over, the audio system will return to its previous state.

### MUTE function

E00760300041

At any time during a call, you can mute the vehicle microphone.

Pressing the SPEECH button and then saying “Mute” during a call will turn ON the MUTE function and mute the microphone.

Saying “Mute off” in the same way will turn off the MUTE function and cancel the mute on the microphone.

### Switching between hands-free mode and private mode

E00761400036

The Bluetooth® 2.0 interface can switch between Hands-free mode (Hands-free calls) and private mode (calls using cellular phone).

If you press the SPEECH button and say “Transfer call” during a Hands-free call, you can stop the Hands-free mode and talk in private mode.

To return to Hands-free mode, press the SPEECH button again and say “Transfer call”.

### Phone book function

E00763700017

The Bluetooth® 2.0 interface has 2 types of unique phone books that are different from the phone book stored in the cellular phone. They are the vehicle phone book and the mobile phone book.

These phone books are used to register telephone numbers and to make calls to desired numbers via the voice recognition function.

#### NOTE

- Disconnecting the battery cable will not delete information registered in the phone book.

### Vehicle phone book

E00763800151

This phone book is used when making calls with the voice recognition function.

Up to 32 names can be registered in the vehicle phone book per language.

Also, each entry has 4 locations associated with: home, work, mobile and other. You can register one telephone number for each location.

You can register a desired name as a name for any phone book entry registered in the vehicle phone book.

Names and telephone numbers can be changed later on.

The vehicle phone book can be used with all paired cellular phones.

### To register a telephone number in the vehicle phone book

You can register a telephone number in the vehicle phone book in the following 2 ways: Reading out a telephone number, and selecting and transferring 1 phone book entry from the phone book of the cellular phone.

#### To register by reading out a telephone number

1. Press the SPEECH button.
2. Say “Phone book.”
3. The voice guide will say “Select one of the following: new entry, edit number, edit name, list names, delete, erase all, or import contact.” Say “New entry.”
4. The voice guide will say “Name please.” Say your preferred name to register it.

#### NOTE

- If the maximum number of entries are already registered, the voice guide will say “The phone book is full. Would you like to delete a name?” Say “Yes” if you want to delete a registered name. Say “No,” to return to the main menu.
5. When the name has been registered, the voice guide will say “home, work, mobile, or other?” Say the location for which you want to register a telephone number.

## For pleasant driving

### NOTE

- When the confirmation function is on, the voice guide will say “<Location>. Is this correct?” Answer “Yes.”

If a telephone number has been registered for the selected location, the voice guide will say “The current number is <telephone number>, number please.”

If you do not want to change the telephone number, say “cancel” or the original number to keep it registered.

6. The voice guide will say “Number please.” Say the telephone number to register it.

### NOTE

- In the case of English, the system will recognise both “zero” and “oh” (Letter “o”) for the number “0.”

7. The voice guide will repeat the telephone number you have just read, and then register the number.

When the telephone number has been registered, the voice guide will say “Number saved. Would you like to add another number for this entry?”

To add another telephone number for a new location for the current entry, answer “Yes.” The system will return to location selection in Step 5.

Answer “No” to end the registration process and return to the main menu.

### NOTE

- When the confirmation function is on, after repeating the telephone number you have read, the voice guide will ask “Is this correct?” Answer “Yes.”

Answer “No” to return to telephone number registration in step 6.

### To select and transfer one phone book entry from the phone book of the cellular phone

You can select 1 phone book entry from the phone book of the cellular phone and register it in the vehicle phone book.

### NOTE

- Transfer is not permitted unless the vehicle is parked. Before transferring, make sure that the vehicle is parked in a safe location.
- All or part of data may not be transferred, even when the cellular phone supports Bluetooth®, depending on the compatibility of the device.
- The maximum supported telephone number length is 19 digits. Any telephone number of 20 digits or more will be truncated to the first 19 digits.
- If telephone numbers contain characters other than 0 to 9, \*, # or +, these characters are deleted before the transfer.
- For the connection settings on the cellular phone side, refer to the instructions for the cellular phone.

1. Press the SPEECH button.
2. Say “Phone book.”

3. The voice guide will say “Select one of the following: new entry, edit number, edit name, list names, delete, erase all, or import contact.” Say “Import contact.”

4. The voice guide will say “Would you like to import a single entry or all contacts?” Say “Single entry.”

The Bluetooth® 2.0 interface will become ready to receive transferred phone book data.

### NOTE

- If the maximum number of entries are already registered, the voice guide will say “The phone book is full. Would you like to delete a name?” Say “Yes” if you want to delete a registered name. Say “No,” to return to the main menu.

5. After the voice guide says “Ready to receive a contact from the phone. Only a home, a work, and a mobile number can be imported,” the Bluetooth® 2.0 interface will receive the phone book data from the Bluetooth® compatible cellular phone.

6. Operate the Bluetooth® compatible cellular phone to set it up so that the phone book entry you want to register in the vehicle phone book can be transferred to the Bluetooth® 2.0 interface.

## NOTE

- If the Bluetooth® 2.0 interface cannot recognise the Bluetooth® compatible cellular phone or the connection takes too much time, the voice guide will say “Import contact has timed out” and then the system will cancel the registration. In such case, start over again from Step 1.
  - Pressing the HANG-UP button or pressing and holding the SPEECH button will cancel the registration.
7. When the reception is complete, the voice guide will say “<Number of telephone numbers that had been registered in the import source> numbers have been imported. What name would you like to use for these numbers?”  
Say the name you want to register for this phone book entry.

## NOTE

- If the entered name is already used for other phone book entry or similar to a name used for other phone book entry, that name cannot be registered.
8. The voice guide will say “Adding <name>.”  
When the confirmation function is on, the system will ask if the name is correct. Answer “Yes.”  
Answer “No,” and the voice guide will say “Name please.” Register a different name.
9. The voice guide will say “Numbers saved.”

10. The voice guide will say “Would you like to import another contact?”  
Answer “Yes” if you want to continue with the registration. You can continue to register a new phone book entry from Step 5.  
Answer “No,” to return to the main menu.

**To change the content registered in the vehicle phone book**

You can change or delete a name or telephone number registered in the vehicle phone book. You can also listen to the list of names registered in the vehicle phone book.

## NOTE

- The system must have at least one entry.

[Editing a telephone number]

1. Press the SPEECH button.
2. Say “Phone book.”
3. The voice guide will say “Select one of the following: new entry, edit number, edit name, list names, delete, erase all, or import contact.” Say “Edit number.”
4. The voice guide will say “Please say the name of the entry you would like to edit, or say list names.” Say the name of the phone book entry you want to edit.

## NOTE

- Say “List names,” and the names registered in the phone book will be read out in order. Refer to “Vehicle phone book: Listening to the list of registered names” on page 5-73.

5. The voice guide will say “Home, work, mobile or other?”  
Select and say the location where the telephone number you want to change or add is registered.  
When the confirmation function is on, the system will check the target name and location again. Answer “Yes” if you want to continue with the editing.  
Answer “No” to return to Step 3.
6. The voice guide will say “Number please.”  
Say the telephone number you want to register.

## NOTE

- If the telephone number is already registered in the selected location, the voice guide will say “The current number is <current number>. New number, please.” Say a new telephone number to change the current number.
7. The voice guide will repeat the telephone number.  
When the confirmation function is on, the system will ask if the number is correct. Answer “Yes.”  
Answer “No” to return to Step 3.
8. Once the telephone number is registered, the voice guide will say “Number saved” and then the system will return to the main menu.

## NOTE

- If the location where a telephone number was already registered has been overwritten with a new number, the voice guide will say “Number changed” and then the system will return to the main menu.

[Editing a name]

## For pleasant driving

1. Press the SPEECH button.
2. Say “Phone book.”
3. The voice guide will say “Select one of the following: new entry, edit number, edit name, list names, delete, erase all, or import contact.” Say “Edit name.”
4. The voice guide will say “Please say the name of the entry you would like to edit, or say list names.” Say the name you want to edit.

### NOTE

- Say “List names,” and the names registered in the phone book will be read out in order. Refer to “Vehicle phone book: Listening to the list of registered names” on page 5-73.
5. The voice guide will say “Changing <name>.” When the confirmation function is on, the system will ask if the name is correct. Answer “Yes” if you want to continue with the editing based on this information. Answer “No” to return to Step 4.
  6. The voice guide will say “Name please.” Say the new name you want to register.
  7. The registered name will be changed. When the change is complete, the system will return to the main menu.

### [Listening to the list of registered names]

1. Press the SPEECH button.
2. Say “Phone book.”
3. The voice guide will say “Select one of the following: new entry, edit number, edit name, list names, delete, erase all, or import contact.” Say “List names.”
4. Bluetooth<sup>®</sup> 2.0 interface will read out the entries in the phone book in order.

5. When the voice guide is done reading the list, it will say “End of list, would you like to start from the beginning?” When you want to check the list again from the beginning, answer “Yes.”  
When you are done, answer “No” to return to the previous or main menu.

### NOTE

- You can call, edit or delete a name that is being read out.  
Press the SPEECH button and say “Call” to call the name, “Edit name” to edit it, or “Delete” to delete it.  
The system will beep and then execute your command.
- If you press the SPEECH button and say “Continue” or “Previous” while the list is being read, the system will advance or rewind the list. Say “Continue” to proceed to the next entry or “Previous” to return to the previous entry.

### [Deleting a telephone number]

1. Press the SPEECH button.
2. Say “Phone book.”
3. The voice guide will say “Select one of the following: new entry, edit number, edit name, list names, delete, erase all, or import contact.” Say “Delete.”
4. The voice guide will say “Please say the name of the entry you would like to delete, or say list names.” Say the name of the phone book entry in which the telephone number you want to delete is registered.

### NOTE

- Say “List names,” and the names registered in the phone book will be read out in order. Refer to “Vehicle phone book: Listening to the list of registered names” on page 5-73.
5. If only one telephone number is registered in the selected phone book entry, the voice guide will say “Deleting <name> <location>.” If multiple telephone numbers are registered in the selected phone book entry, the voice guide will say “Would you like to delete [home], [work], [mobile], [other], or all?” Select the location to delete, and the voice guide will say “Deleting <name> <location>.”

### NOTE

- To delete the telephone numbers from all locations, say “All.”
6. The system will ask if you really want to delete the selected telephone number(s) to go ahead with the deletion, answer “Yes.”  
Answer “No,” the system will cancel deleting the telephone number(s) and then return to Step 4.
  7. When the deletion of the telephone number is completed, the voice guide will say “<name> <location> deleted” and then the system will return to the main menu.  
If all locations are deleted, the system will say “<name> and all locations deleted” and the name will be removed from the phone book. If numbers still remain under the entry, the name will retain the other associated numbers.

## Erasing the phone book



You can delete all registered information from the vehicle phone book.

1. Press the SPEECH button.
2. Say “Phone book.”
3. The voice guide will say “Select one of the following: new entry, edit number, edit name, list names, delete, erase all, or import contact.” Say “Erase all.”
4. For confirmation purposes, the voice guide will ask “Are you sure you want to erase everything from your handsfree system phone book?” Answer “Yes.”
5. Answer “No” to cancel the deletion of all registered information in the phone book and return to the main menu.
5. The voice guide will say “You are about to delete everything from your hands-free system phone book. Do you want to continue?” Answer “Yes” to continue.  
Answer “No” to cancel the deletion of all registered information in the phone book and return to the main menu.
6. The voice guide will say “Please wait, erasing the handsfree system phone book” and then the system will delete all data in the phone book.  
When the deletion is complete, the voice guide will say “Hands-free system phone book erased” and then the system will return to the main menu.

### Mobile phone book

E00763900019

All entries in the phone book stored in the cellular phone can be transferred in a batch and registered in the mobile phone book.

Up to 7 mobile phone books, each containing up to 1,000 names, can be registered.

The Bluetooth® 2.0 interface automatically converts from text to voice the names registered in the transferred phone book entries, and creates names.

### NOTE

- Only the mobile phone book transferred from the connected cellular phone can be used with that cellular phone.
- You cannot change the names and telephone numbers in the phone book entries registered in the mobile phone book. You cannot select and delete specific phone book entries, either. To change or delete any of the above, change the applicable information in the source phone book of the cellular phone and then transfer the phone book again.

### To import a devices phone book

Follow the steps below to transfer to the mobile phone book the phone book stored in the cellular phone.

### NOTE

- Transfer should be completed while the vehicle is parked. Before transferring, make sure that the vehicle is parked in a safe location.
- All or part of data may not be transferred, even when the cellular phone supports Bluetooth®, depending on the compatibility of the device.
- The maximum supported telephone number length is 19 digits. Any telephone number of 20 digits or more will be truncated to the first 19 digits.
- If telephone numbers contain characters other than 0 to 9, \*, # or +, these characters are deleted before the transfer.

- For the connection settings on the cellular phone side, refer to the instructions for the cellular phone.

1. Press the SPEECH button.
2. Say “Phone book.”
3. The voice guide will say “Select one of the following: new entry, edit number, edit name, list names, delete, erase all, or import contact.” Say “Import contact.”
4. The voice guide will say “Would you like to import a single entry or all contacts?” Say “All contacts.”
5. The voice guide will say “Importing the contact list from the mobile phone book. This may take several minutes to complete. Would you like to continue?” Answer “Yes,” transferring to the mobile phone book the phone book stored in the cellular phone will start.  
Answer “No,” to return to the main menu.

### NOTE

- The transfer may take some time to complete depending on the number of contacts.
- If the Bluetooth® 2.0 interface could not be connected to the Bluetooth® compatible cellular phone, the voice guide will say “Unable to transfer contact list from phone” and then the system will return to the main menu.
- If you press the HANG-UP button or press and hold the SPEECH button during the data transfer, the transfer will be cancelled and the system will return to the main menu.

## For pleasant driving

- If an error occurs during the data transfer, all transfer will be cancelled and the voice guide will say “Unable to complete the phone book import” and then the system will return to the main menu.
  - If there are no contacts in the phone book, the voice guide will say “There are no contacts on the connected phone.”
6. When the transfer is complete, the voice guide will say “Import complete” and then the system will return to the main menu.

## Enrollment commands

Phrase	English	French	Spanish	Italian	German	Dutch	Portuguese	Russian
1	123456789	123456789	123456789	123456789	123456789	123456789	123456789	123456789
2	888 555 1212	888 555 1212	888 555 1212	888 555 1212	888 555 1212	888 555 1212	888 555 1212	888 555 1212
3	Call	Appeler	Lllamar	Chiama	Anrufen	Bellen	Ligar	Вызов
4	Dial	Composer	Marcar	Componi	Wählen	Nummer keuze	Marcar	Набор
5	Setup	Configurer	Configuración	Configura	Einrichtung	Setup	Configurar	Настройка
6	Cancel	Annuler	Cancelar	Annulla	Abbrechen	Annuleren	Cancelar	Отмена
7	Continue	Continuer	Continuar	Continua	Weiter	Doorgaan	Continuar	Продолжить
8	Help	Aide	Ayuda	Aiuto	Hilfe	Help	Ajuda	Справка

## For pleasant driving

### USB input terminal\*

E00761900015

You can connect your USB memory device or iPod to play music files stored in the USB memory device or iPod.

The following explains how to connect and remove a USB memory device or iPod.

Refer to the following sections for details on how to play music files:

Refer to “To play from a USB memory device” on page 5-46.

\*: “iPod” is a registered trademark of Apple Inc. in the United States and other countries.

### How to connect a USB memory device

E00762000172

1. Park your vehicle in a safe place and turn the ignition switch to the “LOCK” position.
2. Open the USB input terminal cover (A) in the floor console box.

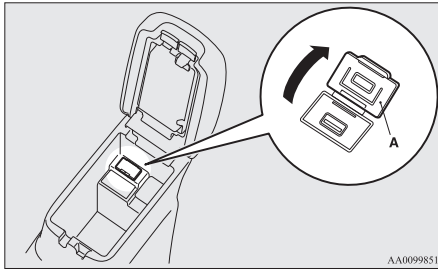

AA0099851

3. Connect the connector cable (C) to the USB memory device (B).

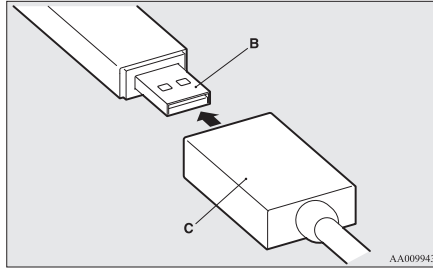

AA0099431

4. Connect the connector cable (C) to the USB input terminal (D).

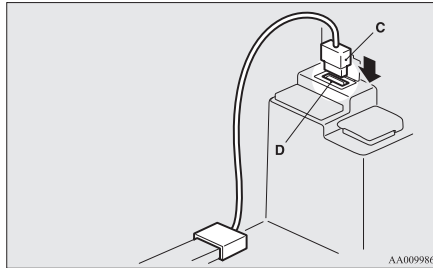

AA0099864

### **⚠ CAUTION**

- Keep the lid of the floor console box closed while driving the vehicle. A lid or the contents of the floor console box could otherwise cause injuries.

### NOTE

- Do not connect the USB memory device to the USB input terminal directly. The USB memory device may be damaged.
  - When closing the floor console box, be careful not to trap the connector cable.
5. To remove the connector cable, turn the ignition switch to the “LOCK” position first and perform the installation steps in reverse.

### How to connect an iPod

E00762100030

1. Park your vehicle in a safe place and turn the ignition switch to the “LOCK” position.
2. Open the USB input terminal cover (A) in the floor console box.

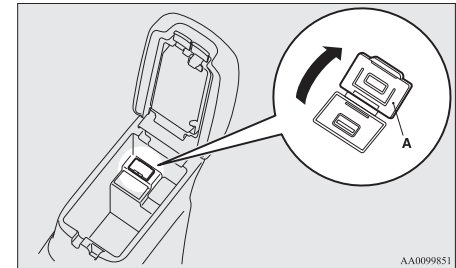

AA0099851

- Connect the Dock connector (C) to the iPod (B).

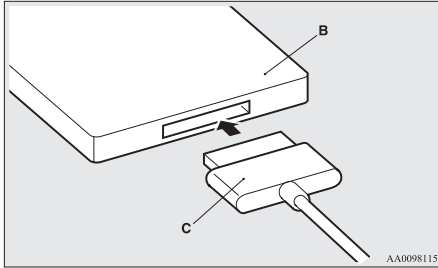

NOTE

- Use a genuine Dock connector from Apple Inc.

- Connect the Dock connector (C) to the USB input terminal (D).

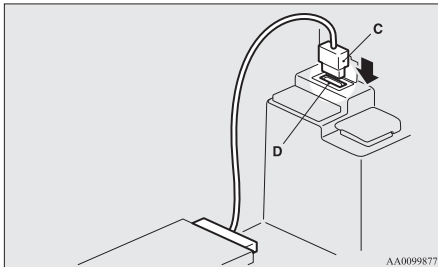

**CAUTION**

- Keep the lid of the floor console box closed while driving the vehicle. A lid or the contents of the floor console box could otherwise cause injuries.

NOTE

- When closing the floor console box, be careful not to trap the connector cable.
- To remove the Dock connector, turn the ignition switch to the “LOCK” position first and perform the installation steps in reverse.

**Types of connectable devices and supported file specifications**

*Device types*

E00762200015

E00762300218

Devices of the following types can be connected.

Model name	Condition
USB memory device	Storage capacity of 256 Mbytes or more
iPod touch*	F/W Ver.1.1.1 or later
iPod classic*	F/W Ver.1.0 or later
iPod (fifth generation)*	F/W Ver.1.2.2 or later
iPod nano (fifth generation)*	F/W Ver.1.2 or later
iPod nano (second generation)*	F/W Ver.1.1.2 or later
Models other than USB memory devices and iPods	Digital audio player supporting mass storage class

\*: “iPod touch,” “iPod classic,” “iPod” and “iPod nano” are registered trademarks of Apple Inc. in the United States and other countries.

NOTE

- Depending on the type of the USB memory device or other device connected, the connected device may not function properly or the available functions may be limited.
- Use the iPod whose firmware has been updated to the latest version.
- You can charge your iPod by connecting it to the USB input terminal when the ignition switch is in the “ACC” or “ON” position.
- Do not keep your USB memory device or iPod in your vehicle.
- It is recommended that you back up files in case of data damage.

## For pleasant driving

- Do not connect to the USB input terminal any device (hard disk, card reader, memory reader, etc.) other than the connectable devices specified in the previous section. The device and/or data may be damaged. If any of these devices was connected by mistake, remove it after turning the ignition switch to the “LOCK” position.

## File specifications

E00762400017

You can play music files of the following specifications that are saved in a USB memory device or other device supporting mass storage class.

Item	Condition
File format	MP3, WMA, AAC, WAV
Maximum number of levels (including the root)	Level 8
Number of folders	700
Number of files	65,535

## Sun visors

E00711201094

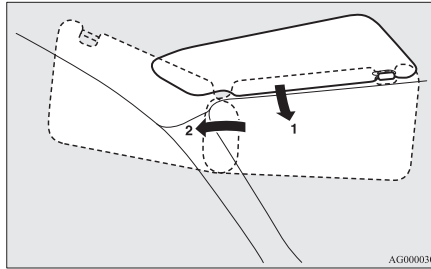

- 1- To eliminate front glare
- 2- To eliminate side glare

AG0000309

## Vanity mirror

A vanity mirror is fitted to the back of the sun visor. Operating the lid of the vanity mirror will automatically turn on the mirror lamp (A).

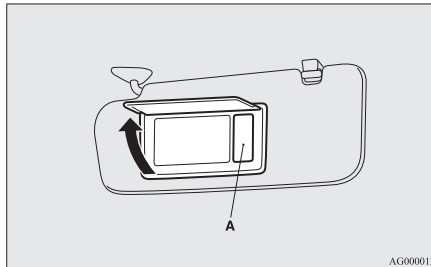

AG0000123

## **⚠ CAUTION**

- If the lid of vanity mirror with lamp is kept open for prolonged periods of time, the vehicle's battery will be discharged.

## Card holder

Cards can be slipped into the holder (B) on the back of the sun visor.

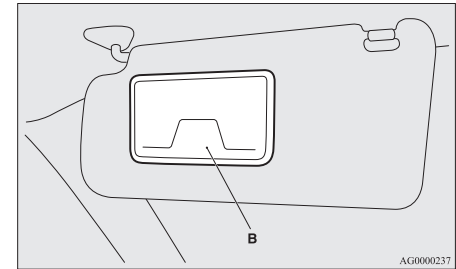

AG0000237

## Ashtray\*

E00711400422

### CAUTION

- Put out matches and cigarettes before they are placed in the ashtray.
- Don't put papers and other things that burn into your ashtrays. If you do, cigarettes or other smoking materials could set them on fire, causing damage.
- Always close the ashtray. If left open, other cigarette butts in the ashtray may be re-kindled.

To use the ashtray, open the lid.

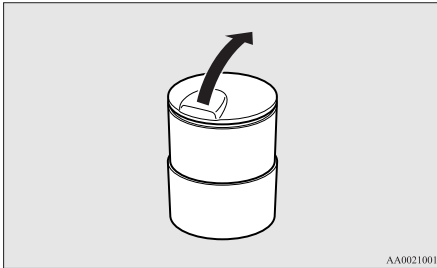

## Moveable ashtray secure holder

The moveable ashtray can be fitted at the indicated position.

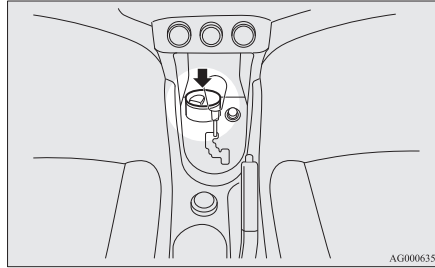

### CAUTION

- The moveable ashtray secure holder should never be used as a cup holder. Drinks could be spilled over the accessory socket by the vibration and jolts while driving, causing an electric shock.

For pleasant driving

## Cigarette lighter\*

E00711501390

The cigarette lighter can be used while the ignition switch is in the "ON" or "ACC" position.

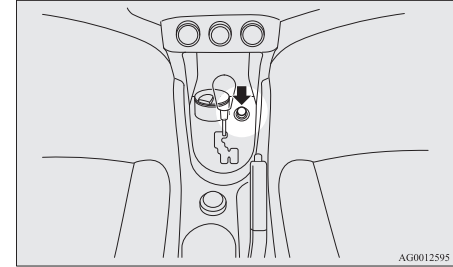

1- Push all the way in.

The cigarette lighter will automatically return to its original position with a "click" when ready. Pull it out for use.

After use, insert the cigarette lighter to its original position in the socket.

### NOTE

- Do not leave the cigarette lighter removed from its socket, because the socket might become clogged by foreign material and be short-circuited.

### CAUTION

- Do not touch the heating element or the cigarette lighter housing, hold the knob only to prevent burns.

## **⚠ CAUTION**

- Do not allow children to operate or play with the cigarette lighter as burns may occur.
- Something is wrong with the cigarette lighter if it does not pop back out within approximately 30 seconds of being pushed in. Pull it out and have the problem corrected at MITSUBISHI MOTORS Authorized Service Point.
- Do not use any electric appliance that is not approved by MITSUBISHI MOTORS. Doing so could damage the socket. If you used the cigarette lighter after damaging the socket, the cigarette lighter might pop out or fail to come out after being pushed in.
- When the cigarette lighter socket is used as a power source for an electric appliance, be sure that the electric appliance operates at 12 V and has an electric capacity of 120 W or less. In addition, long use of the electric appliance without running the engine may run down the battery.

## *Accessory socket*

E00711601216

## **⚠ CAUTION**

- Be sure to use a “plug-in” type accessory operating at 12 V and at 120 W or less. When using more than one socket at the same time, make sure that the electrical accessories are 12 V accessories and that the total power consumption does not exceed 120 W.
- Long use of the electric appliance without running the engine may run down the battery.
- When the accessory socket is not in use, be sure to close the lid or install the cap, because the socket might become clogged by foreign material and be short-circuited.

To use a plug-in type accessory, open the lid or remove the cap, and insert the plug in the accessory socket.

### NOTE

- Accessory sockets in 3 locations can be used at the same time.

The accessory socket can be used while the ignition switch is in either the “ON” or “ACC” position.

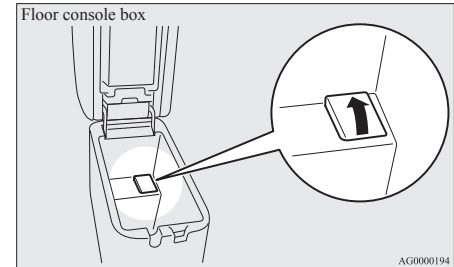
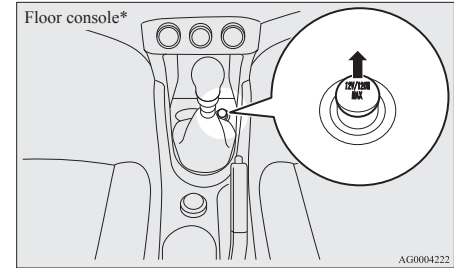



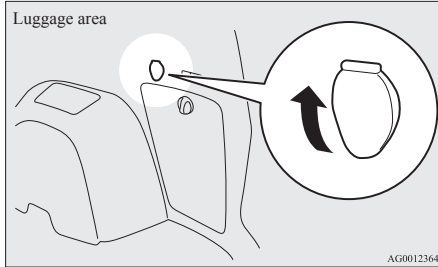

## Interior lamps

E00712000959

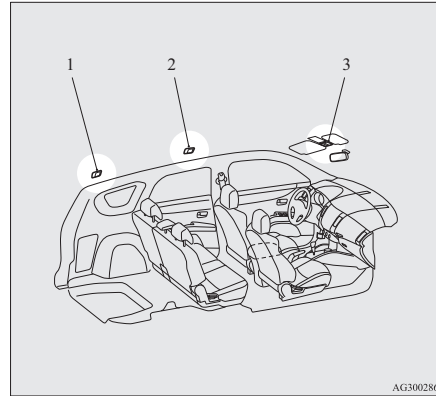

- 1- Luggage room lamp
- 2- Room lamp (rear)
- 3- Map & room lamps (front)

### NOTE

- If you leave the lamps on without running the engine, you will run down the battery. Before you leave the vehicle, make sure that the lamps are turned off.

## Room lamps

E00712101146

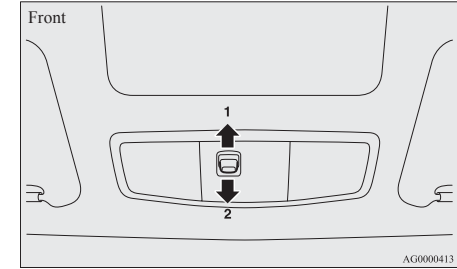

### 1- (DOOR)

The lamp illuminates when a door or the tailgate is opened. It goes off about 15 seconds after the door or tailgate is closed. However, the lamp goes off immediately in the following cases:

- When the doors and the tailgate are closed and the ignition switch is turned to the “ON” position.
- When the doors and the tailgate are closed and the central door lock function is used to lock the vehicle.
- If the vehicle is equipped with the keyless entry system, when the keyless entry system remote control switch is used to lock the vehicle.
- If the vehicle is equipped with the keyless operation system, when the keyless operation function is used to lock the vehicle.

## For pleasant driving

### NOTE

- When the key was used to start the engine, if the key is removed while the doors and tailgate are closed, the lamp is illuminated and after about 15 seconds it goes off.
- When the keyless operation function was used to start the engine, if the ignition switch is turned to the “LOCK” position while the doors and tailgate are closed, the lamp illuminates and after about 15 seconds it goes off.
- The time until the lamp goes off can be adjusted. For details, please consult a MITSUBISHI MOTORS Authorized Service Point. On vehicles equipped with MITSUBISHI Multi-Communication System (MMCS), screen operations can be used to make the adjustment. Refer to the separate owner’s manual for details.

### 2- (OFF)

The lamp stays off regardless of whether the doors and tailgate are open or closed

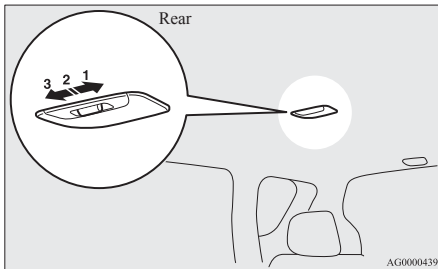

### 1- (ON)

The lamp illuminates regardless of whether the doors and tailgate are open or closed.

### 2- (●)

The lamp illuminates when a door or the tailgate is opened. It goes off about 15 seconds after the door or tailgate is closed. However, the lamp goes off immediately in the following cases:

- When the doors and the tailgate are closed and the ignition switch is turned to the “ON” position.
- When the doors and the tailgate are closed and the central door lock function is used to lock the vehicle.
- If the vehicle is equipped with the keyless entry system, when the keyless entry system remote control switch is used to lock the vehicle.
- If the vehicle is equipped with the keyless operation system, when the keyless operation function is used to lock the vehicle.

### NOTE

- When the key was used to start the engine, if the key is removed while the doors and tailgate are closed, the lamp is illuminated and after about 15 seconds it goes off.
- When the keyless operation function was used to start the engine, if the ignition switch is turned to the “LOCK” position while the doors and tailgate are closed, the lamp illuminates and after about 15 seconds it goes off.

- The time until the lamp goes off can be adjusted. For details, please consult a MITSUBISHI MOTORS Authorized Service Point. On vehicles equipped with MITSUBISHI Multi-Communication System (MMCS), screen operations can be used to make the adjustment. Refer to the separate owner’s manual for details.

### 3- (OFF)

The lamp stays off regardless of whether the doors and tailgate are open or closed.

## Map lamps

E00712400041

Push the lens (A) to turn on the lamp. Push it again to turn it off.

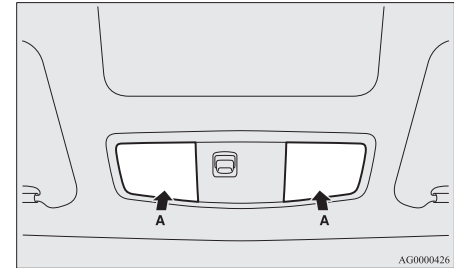

## Luggage room lamp

E00712700549

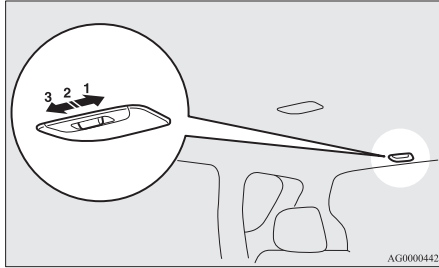

1- (ON)

The lamp illuminates regardless of whether the tailgate is open or closed.

2- (●)

The lamp illuminates when the tailgate is opened, and goes out when the tailgate is closed.

3- (OFF)

The lamp goes out regardless of whether the tailgate is open or closed.

## Lamps (room lamps, etc.) auto-cutout function

E00712901072

If any of the interior lamps are left switched on with the ignition switch in any position other than "ON" or "ACC", it goes off automatically after approximately 30 minutes.

The interior lamps will illuminate again if the ignition switch is set to the "ON" or "ACC" position, if one of the doors or the tailgate is opened and closed, or if the keyless entry system or keyless operation system is operated.

### NOTE

- The interior lamp auto-cut function can be deactivated. The time until the lamps automatically go off can be adjusted. For details and support, consult your nearest MITSUBISHI MOTORS Authorized Service Point. On vehicles equipped with MITSUBISHI Multi-Communication System (MMCS), screen operations can be used to make the adjustment. Refer to the separate owner's manual for details.

## Storage spaces

E00713101390

### CAUTION

- Never leave lighters, cans of carbonated drink, and spectacles in the cabin when parking the vehicle in hot sunshine. The cabin will become extremely hot, so lighters and other flammable items may catch fire and unopened drink cans (including soft drink or beer cans) may rupture. Also, spectacles with plastic lenses or materials could deform or crack.
- Keep the lids of storage spaces closed while driving the vehicle. A lid or the contents of a storage space could otherwise cause injuries.

### NOTE

- When leaving your vehicle, do not leave valuables in the storage spaces.

## For pleasant driving

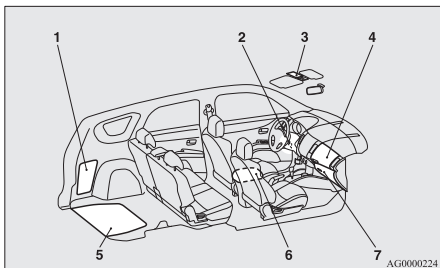

- 1- Quarter trim box\*
- 2- Personal box
- 3- Sunglasses holder\*
- 4- Upper glove box
- 5- Luggage floor box\*
- 6- Floor console box
- 7- Lower glove box

## Upper glove box

E00726100111

Press the button (A) and lift the lid to open.  
To close, pull down the lid.

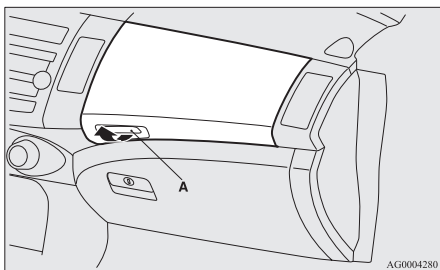

## To use the warming and cooling function\*

The upper glove box can be used to keep its contents (e.g. drink bottles) warm or cool with the warm or cold air from the air conditioning.

1. Turn the dial in the upper glove box to the “” position. Turn the dial to the “” position when not using the warming and cooling function.

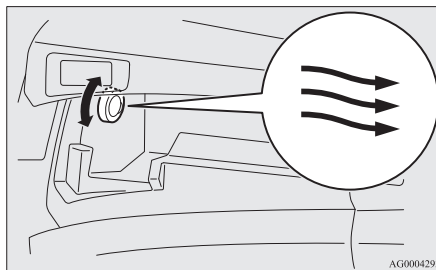

2. Turn the air conditioning temperature control dial (A) to the desired temperature.
3. Turn the air conditioning blower speed selection dial (B) to the desired air flow.

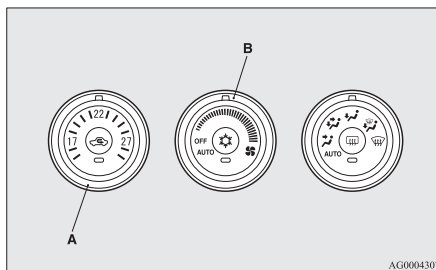

For detailed information on how to use the air conditioning, refer to “Automatic air conditioning” on page 5-04.

## NOTE

- The upper glove box has the same temperature as the air that comes out of the air conditioning ventilators, so it is not possible to greatly heat or cool the contents. For efficient warming or cooling, select the “” mode. Refer to “Changing the mode selection” on page 5-03.
- When placing drinks in the glove box, read the precautions on the container first.
- Do not place in the upper glove box chocolate, sweets, or other items which are susceptible to temperature changes or which may rot.

## Lower glove box

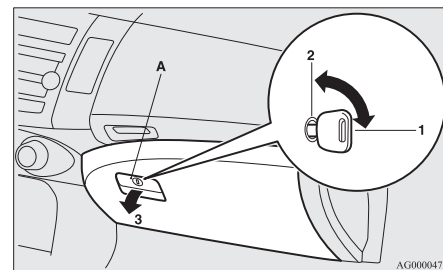

E00726200125

The lower glove box can be locked and unlocked using the key.



1. To lock.
2. To unlock.
3. To open, pull the lever (A).

**NOTE**

- In vehicles equipped with the keyless operation system, the lower glove box can be locked and unlocked with the emergency key. Refer to “Emergency key” on page 1-18.
- When the lamp switch is set in the “AUTO” position and the lamps are illuminated, or in the “” or “” positions, the glove box lamp illuminates.

**Pen holder**

There is a pen holder inside the lower glove box.

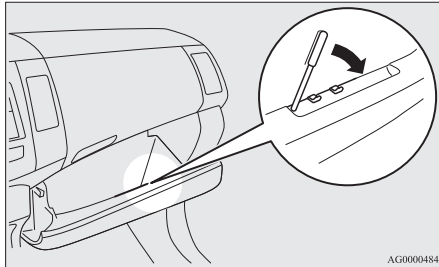

**NOTE**

- There is a limit to the size of pens that can be stored in the holder. Forcibly inserting large pens could damage the holder.

**Card holder**

There is a card holder inside the lower glove box.

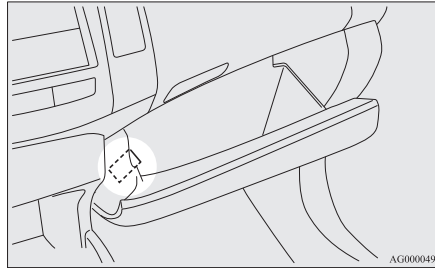

**NOTE**

- Up to two cards can be inserted here.

**Floor console box**

E00723300864

**Type 1**

To open the console box, lift the release lever (A) and raise the lid.

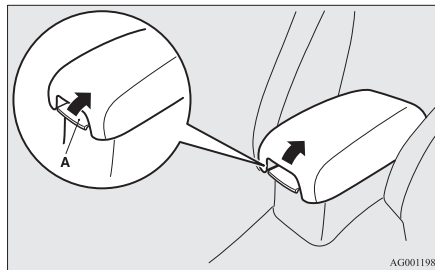

**Type 2**

Upper and lower boxes are located inside the floor console box.

The floor console box can also be used as an armrest.

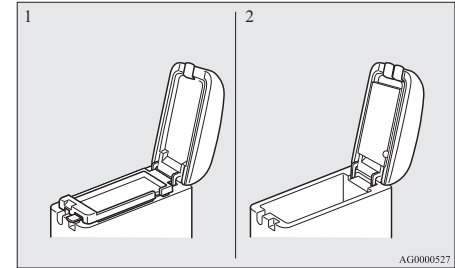

- 1- Upper box
- 2- Lower box

**NOTE**

- The Auxiliary Audio connector (RCA) or the Auxiliary Video connector (RCA) is located in the floor console box (if so equipped). For details, refer to “To use the external audio input function” on page 5-52.
- The USB input terminal is located in the floor console box (if so equipped). For details, refer to “USB input terminal” on page 5-80.

## For pleasant driving

### Upper box

To open the upper box, lift the right release lever (A) and raise the lid.

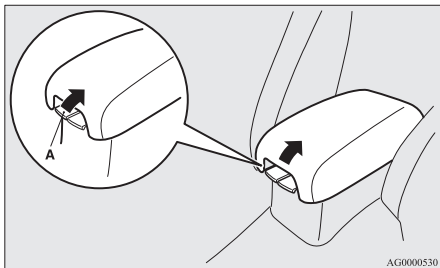

### Lower box

To open the lower box, lift the left release lever (B) and raise the lid.

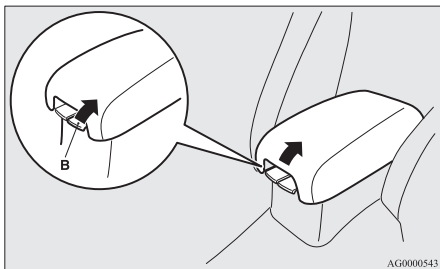

### Tissue holder

The tissue holder (C) is located on the underside of the floor console box lid.

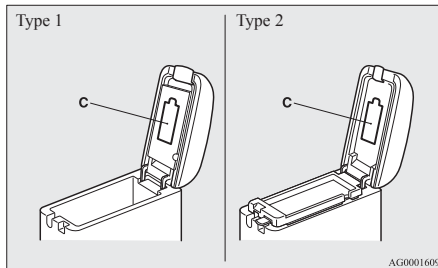

### Personal box

Pull the lid to open.

E00718000313

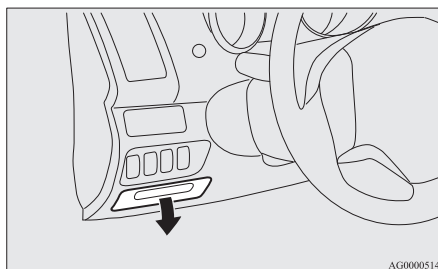

### Sunglasses holder\*

Push the lid to open.

E00718600276

To close, push until it locks.

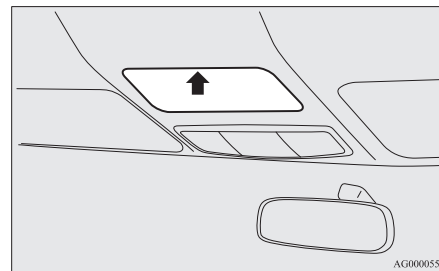

## **⚠ CAUTION**

- The holder should not be used to store anything heavier than sunglasses. These objects could drop out.

### NOTE

- Some sunglasses may not fit in the holder, so check before using it.

### Quarter trim box\*

E00730800018

The box for storing articles is located inside the luggage compartment.

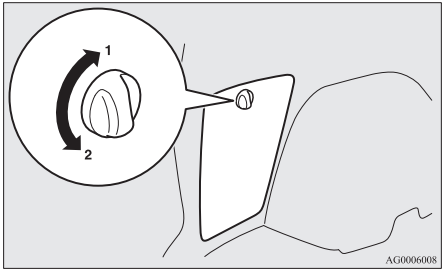

- 1- To close
- 2- To open

AG0006008

### Luggage floor box\*

E00718700293

The box for storing articles is located inside the luggage compartment. To use the box, raise the luggage floor board.

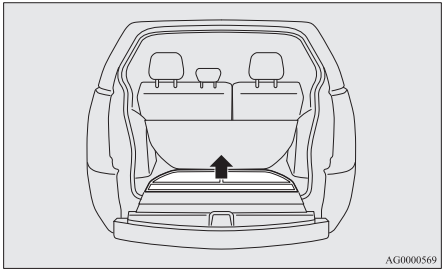

AG0000569

### Cup holder

E00714500381

#### **CAUTION**

- Do not drink beverages while driving. This is distracting and could cause an accident.

#### For the driver's seat

There is a built-in cup holder in the instrument panel on the driver's side. Pressing the centre of the lid causes the tray to pop out a little. Pull it out completely for use.

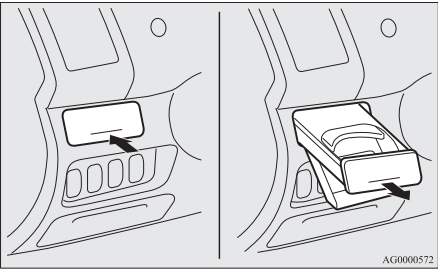

AG0000572

#### NOTE

- When not using the holder, push the holder to stow it away.

### For the front seat

The cup holder is located in front of the floor console box.

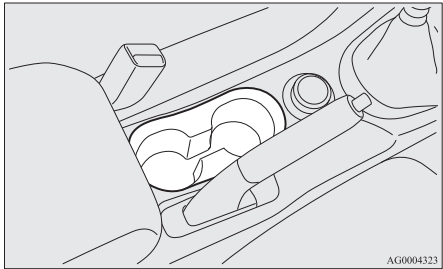

AG0004323

### For the second seat

E00716900305

1. Allow the armrest to drop down.

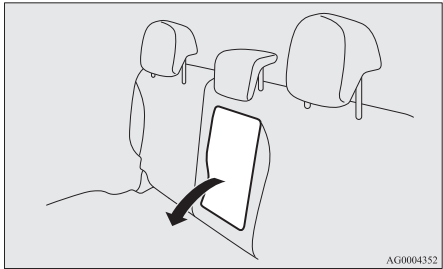

AG0004352

## For pleasant driving

2. Open the lid (A) while holding the side face of the lid with your hand.

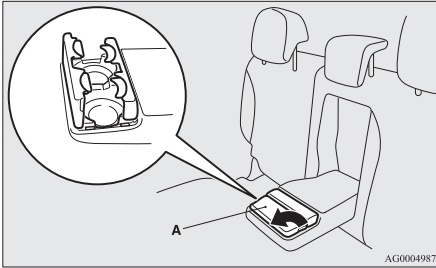

## Bottle holder

E00718200269

### **⚠ CAUTION**

- Do not drink beverages while driving. This is distracting and could cause an accident.
- Drinks could be spilled by the vibration and jolts while driving. If the spilt drink is very hot, you could be burnt.

### NOTE

- Tightly close the cap on drink bottles before storing them.
- Some bottles may be too big or the wrong shape to fit in the holder.

## For the front seat

There are bottle holders located on both sides.

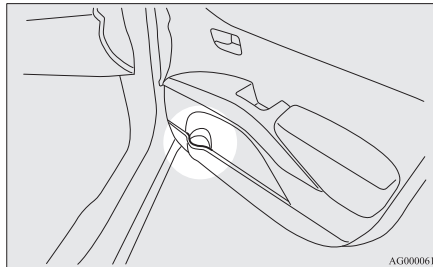

## For the second seat

There are bottle holders located on both sides.

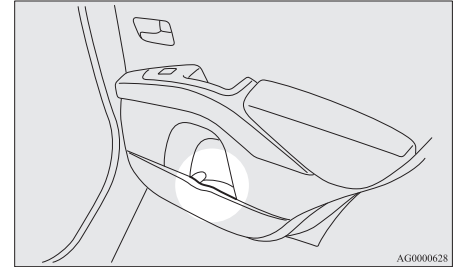



## Cargo area cover\*

E00715500551

### To use

1. Draw out the cover retracted by spring and insert it in the mounting grooves (A).

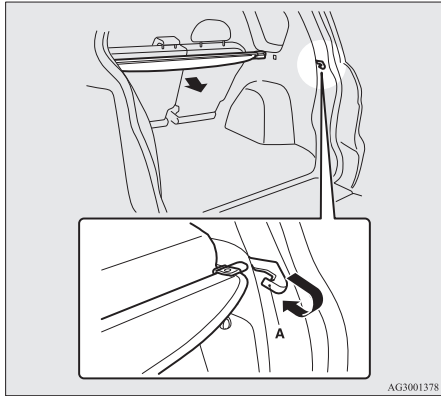

2. Remove the cover from the mounting grooves, and the cover will roll back into the retracted position.

### NOTE

- Do not put luggage on the cargo area cover.

### To change

There are 2 installation holes (B) for the cargo area cover.

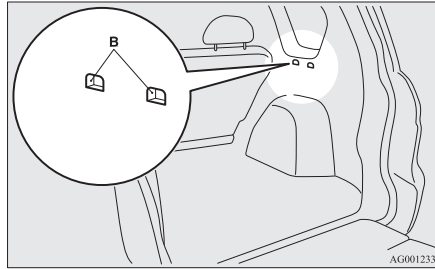

1. Move one of the sliders (C) towards the inside of the vehicle, and fit the tab (D) into the installation hole that is to be used. Move the opposite slider in the same fashion.

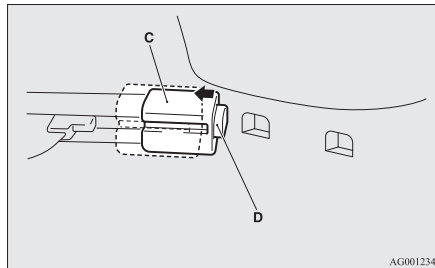

2. After changing the position, gently shake the entire cargo area cover to make sure it is securely retained.

### NOTE

- If the rear seat seatbacks make contact with the cargo area cover, move back the cargo area cover. The cargo area cover could break if it supports the seatback of the rear seat.

### To remove

1. Wind up the cargo area cover.
2. Move one of the sliders (C) towards the inside of the vehicle and lift it to remove the cargo area cover.

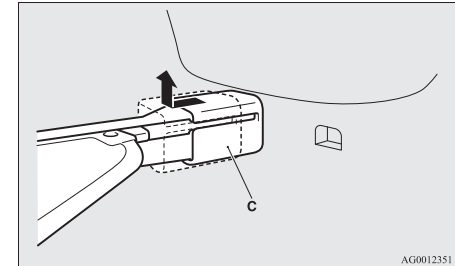

To fit the cargo area cover, follow the removal steps in reverse. Gently shake the entire cargo area cover after fitting it to make sure it is securely retained.

## For pleasant driving

### Assist grips

E00732800184

The assist grips (located above the doors on the headliner) are not designed to support body weight. They are intended for use only while seated in the vehicle.

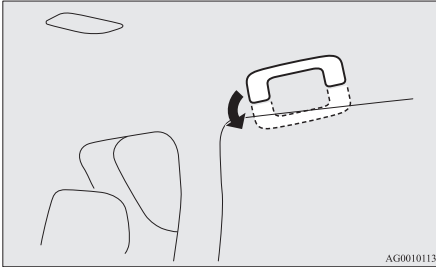

#### **⚠ CAUTION**

- Do not use the assist grips when getting in to or out of the vehicle. The assist grips could detach causing you to fall.

### Coat hook

E00725600513

There is a coat hook on the rear seat assist grip of the driver's side.

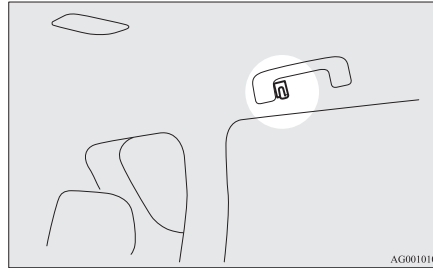

#### **⚠ WARNING**

- Do not put a hanger or any heavy or pointed object on the coat hook. If the curtain airbag was activated, any such item could be propelled away with great force and could prevent the curtain airbag from inflating correctly. Hang clothes directly on the coat hook (without using a hanger). Make sure there are no heavy or sharp objects in the pockets of clothes that you hang on the coat hook.

### Luggage hooks

E00715700292

There are 4 hooks located on the floor and side walls of the luggage area.

Use the hooks on the floor for securing the luggage.

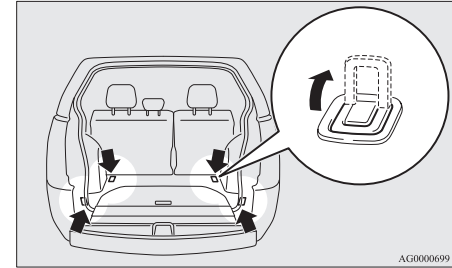

#### **⚠ CAUTION**

- Do not pile up the luggage beyond the seat-back height. Also, firmly secure the luggage. Otherwise, serious accidents could result due to hindered rearward view or flying objects during sudden braking.

## *For emergencies*

If the vehicle breaks down.....	6-02
Emergency starting.....	6-02
Engine overheating.....	6-04
Bleeding the fuel system (For diesel-powered vehicles equipped with Twin Clutch SST).....	6-06
Removal of water from the fuel filter (For diesel-pow- ered vehicles equipped with Twin Clutch SST).....	6-06
Tools and jack.....	6-08
How to change a tyre.....	6-09
Towing.....	6-19
Operation under adverse driving conditions.....	6-22

## For emergencies

### *If the vehicle breaks down*

E00800101212

If the vehicle breaks down on the road, move it to the shoulder and turn on the hazard warning flashers and set up a warning triangle, flashing lamp, etc. Refer to “Hazard warning flasher switch” on page 3-50.

### *If the engine stops/fails*

Vehicle operation and control are affected if the engine stops.

Before moving the vehicle to a safe area, be aware of the following:

- The brake booster becomes inoperative and the pedal effort will increase. Press down the brake pedal harder than usual.
- Since the power steering system is no longer operative, the steering wheel feels heavy when turning it.

### *Emergency starting*

E00800502561

If the engine cannot be started because the battery is weak or dead, the battery from another vehicle can be used with jumper cables to start the engine.

#### **WARNING**

- To start the engine using jumper cables connected to another vehicle, perform the correct procedures according to the instruction below. Incorrect procedures could result in a fire or explosion or damage to the vehicles.

#### **CAUTION**

- Do not attempt to start the engine by pulling or pushing the vehicle. It could damage your vehicle.
- Always wear protective eye goggles when working near the battery.
- Keep the battery out of the reach of children.

1. Get the vehicles close enough so the jumper cables can reach, but be sure the vehicles aren't touching each other.

#### **CAUTION**

- Check the other vehicle. It must have a 12-volt battery. If the other system isn't 12-volt, shorting can damage both vehicles.

2. Set the parking brake firmly on each vehicle. Put an A/T, CVT or Twin Clutch SST in “P” (PARK) or a M/T in “N” (Neutral). Turn off the ignition switch.

#### **WARNING**

- Turn off the ignition on both vehicles beforehand. Make sure that the cables or your clothes cannot be caught by the fan or drive belt. Personal injury could result.

3. Turn off all lamps, heater and other electrical loads.
4. Make sure battery electrolyte is at the proper level. Refer to “Battery” on page 8-09.

#### **WARNING**

- If electrolyte fluid is not visible, or appears to be frozen, Do Not Attempt Jump Starting!  
A battery might rupture or explode if the temperature is below the freezing point or if it is not filled to the proper level.

5. On diesel-powered vehicles equipped with Twin Clutch SST, remove the engine cover.

Lift up the front of the engine cover to release the 4 grommets (A) and remove the cover.

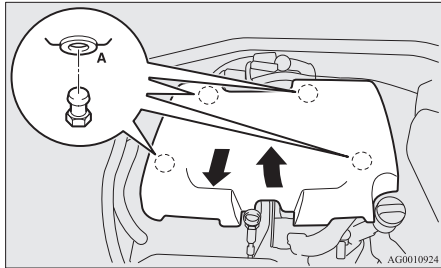

6. Connect one end of one jumper cable to the positive (+) terminal of the discharged battery (C), and the other end to the positive (+) terminal of the booster battery (D).

**Petrol-powered vehicles**

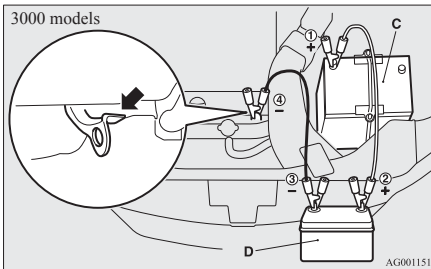
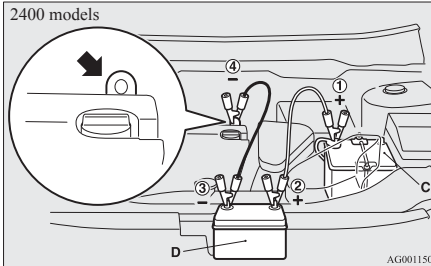
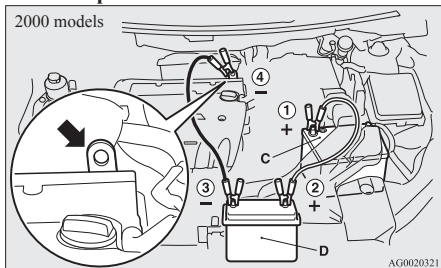

**Diesel-powered vehicles**

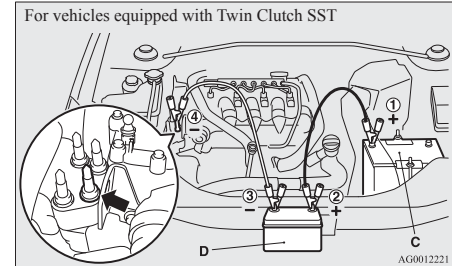
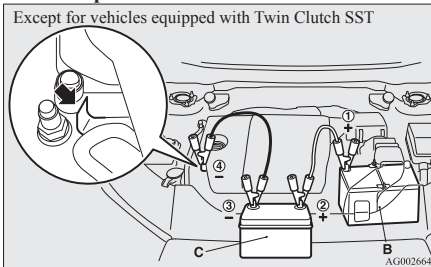

7. Connect one end of the other jumper cable to the negative (-) terminal of the booster battery, and the other end to the engine block of the vehicle with the discharged battery at the point farthest from the battery.

**⚠ WARNING**

- Make sure you observe the following order when connecting the cables: ①→②→③→④.
- Make sure you make connection ④ to the correct designated location (as shown in the illustration). If the connection is made directly to the negative (-) side of the battery, flammable gases generated from the battery might catch fire and explode.
- When connecting the jumper cables, do not allow the positive (+) cable and negative (-) terminal to make contact. Otherwise sparks might cause explosion of the battery.

## For emergencies

### CAUTION

- Take care not to get the jumper cable caught in the cooling fan or other rotating part in the engine compartment.
- Use the proper cables suitable for the battery size to prevent overheating of the cables.
- Check the jumper cables for damage and corrosion before use.

8. Start the engine in the vehicle which has the booster battery, let the engine idle a few minutes, then start the engine in the vehicle with the discharged battery.

### CAUTION

- Keep the engine of the vehicle giving assistance running.

#### NOTE

- For vehicles equipped with the Auto Stop & Go (AS&G) system, press the “Auto Stop & Go (AS&G) OFF” switch to deactivate the Auto Stop & Go (AS&G) system and prevent the engine from automatically stopping before the battery is sufficiently charged. Refer to “To deactivate” on page 4-21.

9. After the engine is started, disconnect the cables in the reverse order and keep the engine running for several minutes.

### WARNING

- If the battery has to be charged while fitted in the vehicle, disconnect the vehicle side negative (-) terminal connected to the battery.
- Keep sparks, cigarettes, and flames away from the battery because the battery could explode.
- Use adequate ventilation when charging or using the battery in an enclosed space.
- Remove all the caps before charging the battery.
- Electrolyte is corrosive diluted sulphuric acid.  
If electrolyte (battery acid) comes into contact with your hands, eyes, clothes and the painted surface of your vehicle, it should be thoroughly flushed with water. If electrolyte gets in your eyes, flush them with water immediately and thoroughly, and get prompt medical attention.

#### NOTE

- If the vehicle is put in motion without fully charging the battery, it might cause the loss of smooth engine operation and the anti-lock brake warning lamp to illuminate. Refer to “Anti-lock brake system (ABS)” on page 4-55.

## Engine overheating

E00800602360

When the engine is overheating, the information screen in the multi-information display will be interrupted and the engine coolant temperature warning display will appear. Also “” will blink.

If this occurs, take the following corrective measures:

1. Stop the vehicle in a safe place.
2. Check whether steam is coming from the engine compartment.

[If steam does not come from the engine compartment]

With the engine still running, raise the bonnet to ventilate the engine compartment.

#### NOTE

- For vehicles equipped with the Auto Stop & Go (AS&G) system, press the “Auto Stop & Go (AS&G) OFF” switch to deactivate the Auto Stop & Go (AS&G) system before stopping the vehicle. Refer to “To deactivate” on page 4-21.

[If steam is coming from the engine compartment]

Stop the engine, and when the steam stops, raise the bonnet to ventilate the engine compartment. Restart the engine.

## **⚠ WARNING**

- Do not open the bonnet while steam is coming from the engine compartment. It could cause steam or hot water to spurt out, causing burns. Hot water could spurt out even when there is no steam coming out, and some parts will be very hot. Be very careful when opening the bonnet.
- Be careful of hot steam, which could cause the cap on the engine reserve tank to blow off.
- Do not attempt to remove the radiator cap (petrol-powered vehicles) or reserve tank cap (diesel-powered vehicles) while the engine is hot.

3. Confirm that the cooling fans are turning. If the fans are not turning, stop the engine immediately and have it checked.

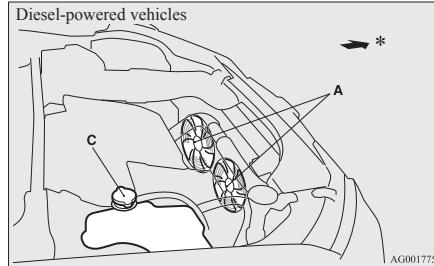
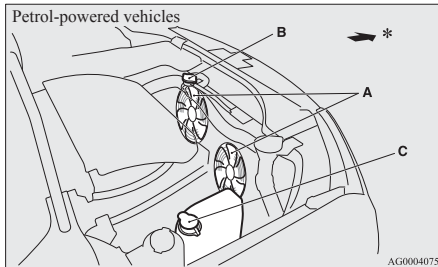

- A- Cooling fan
- B- Radiator cap
- C- Reserve tank cap
- \*: Front of the vehicle

## **⚠ WARNING**

- Be careful not to get your hands or clothes caught in the cooling fan.

4. When the bar graph in the engine coolant temperature warning display in the multi-information display drops, stop the engine.

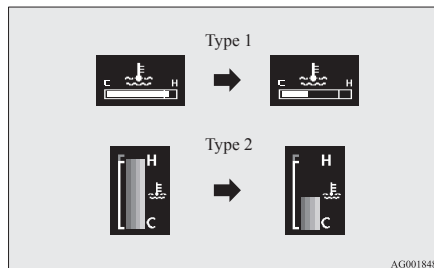

5. Check the coolant level in the reserve tank (A).

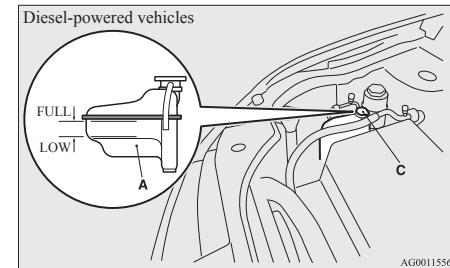
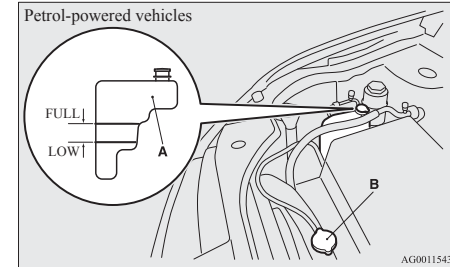

## **⚠ WARNING**

- If there is none, make sure that the engine has cooled down before removing the radiator cap (B) (petrol-powered vehicles) or reserve tank cap (C) (diesel-powered vehicles), because hot steam or boiling water otherwise will gush from the filler port and may scald you.

## For emergencies

6. Fill the reserve tank with coolant as needed. (Refer to the “Maintenance” section.)

### **⚠ CAUTION**

- Do not add coolant while the engine is hot. Suddenly adding cold coolant could damage the engine. Wait for the engine to cool down, then add coolant a little at a time.
7. Examine the radiator hoses for coolant leakage and the drive belt for looseness or damage. If there is anything wrong with the cooling system or drive belt, we recommend you to have it checked and repaired.

### **Bleeding the fuel system (For diesel-powered vehicles equipped with Twin Clutch SST)**

E00800700309

The fuel system should be bled to remove air as described below if the fuel supply is exhausted during travel.

1. Turn the ignition switch to the “ON” position and keep it in the position for 1 minute, then return it to the “LOCK” position. Repeat this operation once or twice.
2. Turn the ignition switch to the “START” position and keep it in the position for 10 to 20 seconds before start the engine.

#### NOTE

- If the engine does not start, repeat from procedure 1.
- After refueling, while it may take more time to start the engine, it will relieve after driving a while.

### **Removal of water from the fuel filter (For diesel-powered vehicles equipped with Twin Clutch SST)**

E00800800339

If the fuel filter indicator display in the instrument panel illuminates during driving, it indicates that water has accumulated in the fuel filter. If this occurs, remove the water as described below.

1. Switch off the engine.
2. Remove the two clips (A) and two clamps (B).

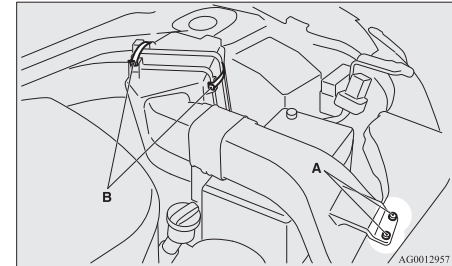

AG0012957



3. Move the duct (C) to the front of the vehicle.

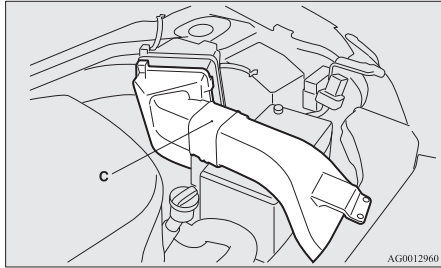

5. Check the position of the fuel filter (E).

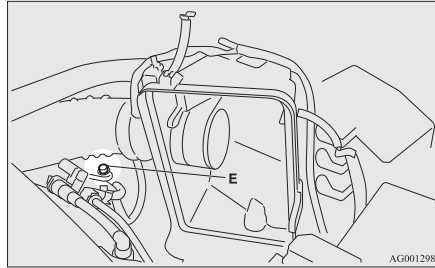

4. Remove the duct (C) after removing the air cleaner filter (D).

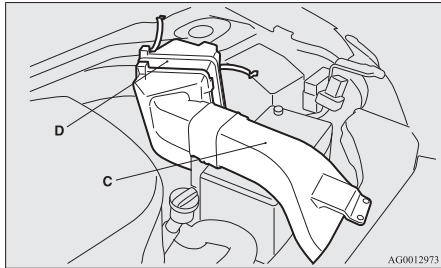

6. Loosen the plug (G) at the fuel filter (E) with the hexagonal wrench (5 mm). Loosening the plug forces the water out through the drain pipe (F). Put a tray under the drain pipe (F) to prevent any water drained out from getting on the vehicle.

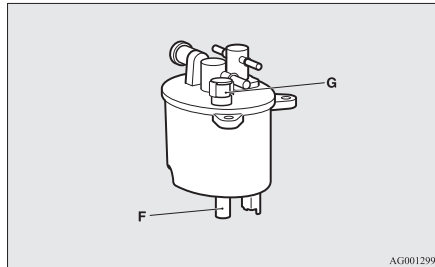

**CAUTION**

- Be sure to carefully clean away any water drained out because any fuel mixed with the water could ignite and cause a fire.

NOTE

- Up to 350 cc drains.
7. Tighten the plug (G) when water no longer comes out.
  8. Install the air cleaner filter and put the cover back on in its original position.

NOTE

- After replacing the air cleaner filter, make sure that the hinges at the bottom of cover are firmly set.

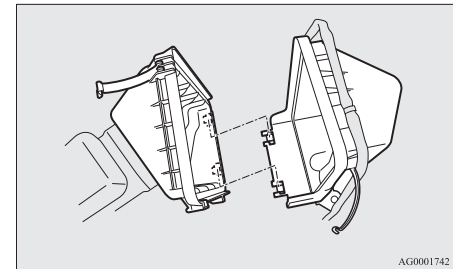

9. Put the duct back on in its original position.
10. Bleed the fuel system to remove air. (Refer to “Bleeding the fuel system” on page 6-06.)

## For emergencies

11. Check to be sure that the fuel filter indicator display illuminates when the ignition switch is turned to "ON", and that it goes off when the engine is started. If in doubt, we recommend you to consult a specialist for necessary information.

Type 1



Type 2



### **CAUTION**

- Do not smoke or have any other open flame near the vehicle while bleeding the fuel system.

## Tools and jack

E00800900633

### Storage

The tools and jack are stowed on the right side of the luggage area.

The storage location of the tools and jack should be remembered in case of an emergency.

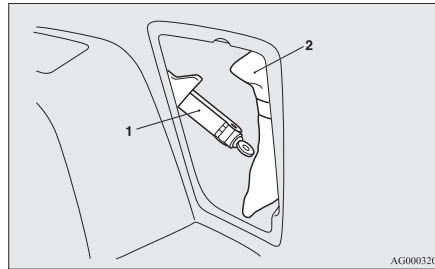

AG0003209

- 1- Jack
- 2- Tools

## Tools

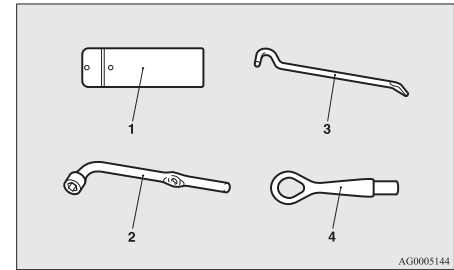

AG0005144

- 1- Tool case
- 2- Wheel nut wrench
- 3- Jack bar
- 4- Towing hook

## Jack

### To remove

1. Turn the knob (A) anticlockwise and remove the lid (B).

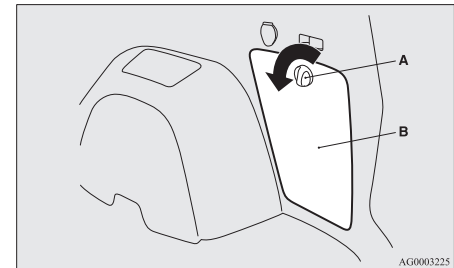

AG0003225

2. Remove the fastening band (C) and remove the tools.

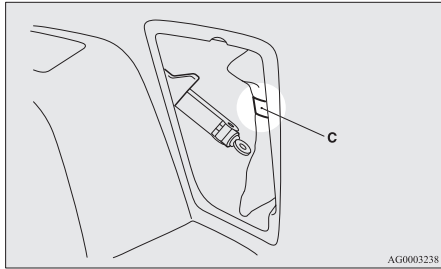

3. Retract the jack and remove it from its installation fitting (D).

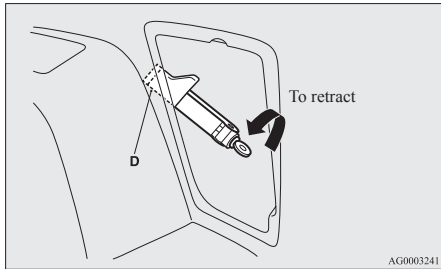

**To store**

1. Retract the jack, then return it to its original position.

2. Extend the jack and firmly secure it.

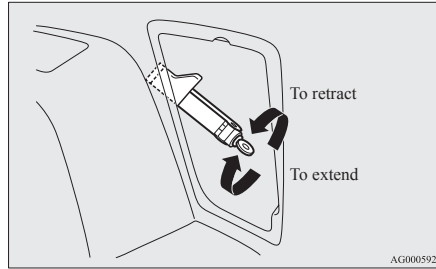

3. Return the tools to the tool bag, return it to its original position, and firmly fasten with the fastening band.
4. Install the lid and turn the knob clockwise.

**How to change a tyre**

E00801202376

Before changing a tyre, first stop your vehicle in a safe, flat location.

1. Park the vehicle on level and stable ground, free of loose pebbles, etc.
2. Set the parking brake firmly.
3. On vehicles with M/T, turn the ignition switch to the "LOCK" position, move the gearshift lever to the "R" (Reverse) position. On vehicles equipped with A/T, CVT or Twin Clutch SST, move the selector lever (A/T or CVT) or gearshift lever (Twin Clutch SST) to the "P" (PARK) position, turn the ignition switch to the "LOCK" position.
4. Turn on the hazard warning flashers and set up a warning triangle, flashing signal lamp, etc., at an adequate distance from the vehicle, and have all your passengers leave the vehicle.

**NOTE**

- The warning triangle and flashing signal lamp do not come with your vehicle. It is recommended that you keep one in the vehicle for use if needed.

5. To prevent the vehicle from rolling when it is raised on the jack, place chocks or blocks (A) in front of and behind the tyre that is diagonally opposite from the tyre (B) you are changing.

## For emergencies

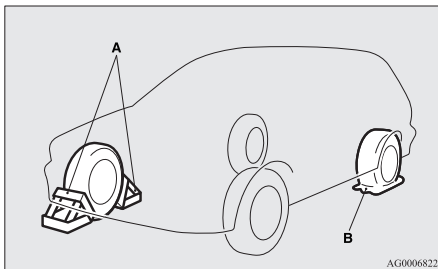

### **⚠ WARNING**

- Be sure to apply chocks or blocks to the correct tyre when jacking up the vehicle. If the vehicle moves while jacked up, the jack could slip out of position, leading to an accident.

#### NOTE

- The chocks shown in the illustration do not come with your vehicle. It is recommended that you keep one in the vehicle for use if needed.
  - If chocks are not available, use stones or any other objects that are large enough to hold the wheel in position.
6. Get the jack bar and wheel nut wrench ready. Refer to “Tools and jack” on page 6-08.

### Spare wheel information

E00803600442

Check the air pressure of the spare tyre frequently and make sure it is ready for emergency use at any time.

Maintaining the spare wheel at the highest specified air pressure will ensure that it can always be used under any conditions (city/high-speed driving, varying load weight, etc.).

The spare wheel is stored under the floor of the luggage area.

### **⚠ CAUTION**

- The pressure should be periodically checked and maintained at the specified pressure while the tyre is stowed. Driving with an insufficient tyre pressure can lead to an accident. If you have no choice but to drive with an insufficient tyre pressure, keep your speed down and inflate the tyre to the correct pressure as soon as possible. (Refer to “Tyre inflation pressures” on page 8-12.)
- When the tread wear indicators appear, the tyre must be replaced. Refer to “Wheel condition” on page 8-13.

#### *Temporary spare wheel (spare wheel with a speed limit label)\**

The T155/90D16 size spare wheel is stored under the floor of the luggage area. It is designed to save space in the luggage area and its light weight makes it easy to handle in the event of a flat tyre.

### **⚠ CAUTION**

- The temporary spare wheel is for temporary use only and should be removed as soon as the original wheel can be repaired or replaced.

### **⚠ CAUTION**

- The vehicle must not be driven at speeds in excess of 80 km/h (50 mph) while using the temporary spare wheel.
- The T155/90D16 size spare wheel is not as good as a standard wheel in controllability and stability. When the temporary spare wheel is used, avoid quick starts, sudden braking and sharp steering. Tyre size of the 215/70R16 size tyre is different from that of the standard tyre. When the temporary spare tyre is used, avoid quick starts, sudden braking and sharp steering.
- The temporary spare wheel is specifically designed for your vehicle and it should not be used on any other vehicle. When you purchase a 215/70R16 size spare wheel, be sure to purchase the type designed specially for your vehicle from your MITSUBISHI MOTORS Authorized Service Point.
- Do not use tyre chains with your temporary spare wheel. Because of the smaller tyre size, a tyre chain will not fit properly. This could cause damage to the wheel and result in loss of the chain. If a front tyre becomes flat when using tyre chains, first replace a rear wheel with the temporary spare wheel and then use the removed rear wheel to replace the flat front wheel so that you can continue to use the chains.

**For emergencies**

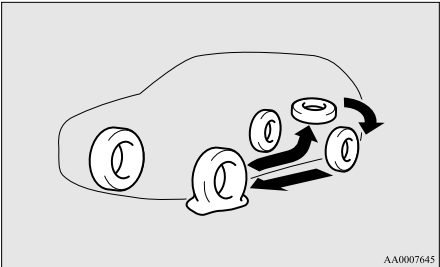

AA0007645

**CAUTION**

- Upon installation of the T155/90D16 size spare wheel, the ground clearance is reduced as the tyre is smaller in diameter than the standard tyre. When passing over the projections on the road, take care not to damage the vehicle's undercarriage.
- Do not install more than one temporary spare wheel at the same time.

**To remove the spare wheel**

E00803500395

*On vehicles with a T155/90D16 size spare wheel*

1. Open the tailgate and remove the tyre hanger installation bolt covers (A) with the jack bar.

Refer to "Split tailgate: To open" on page 1-31.

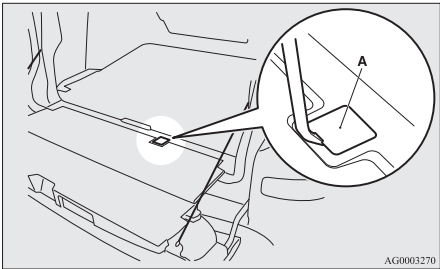

AG0003270

2. Loosen the tyre hanger installation bolt by turning it anticlockwise with the wheel nut wrench.

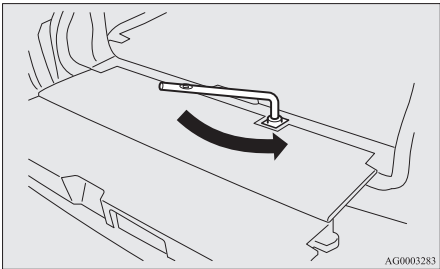

AG0003283

**CAUTION**

- Be careful as you loosen the tyre hanger installation bolt. If you loosen it too far, the hook may come out and let the temporary spare wheel fall.

3. Raise the lower gate until it locks properly in position with a click. Refer to "Split tailgate: To close" on page 1-31.
4. Lift up the tyre hanger (B) at the section indicated by the arrow in the diagram, remove it from the hook (C), lower it, and then take the tyre off the tyre hanger.

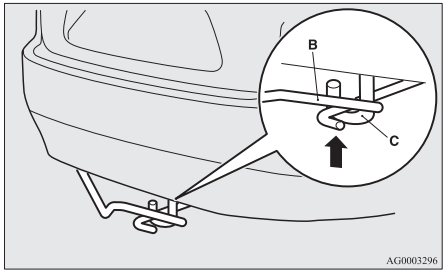

AG0003296

**CAUTION**

- When removing the tyre hanger from the hook or hanging it back on the hook, hold the tyre hanger carefully so that it does not drop on your feet.

**NOTE**

- Put the spare wheel under the vehicle body near the jack. This makes it safer if the jack slips out of position.

## For emergencies

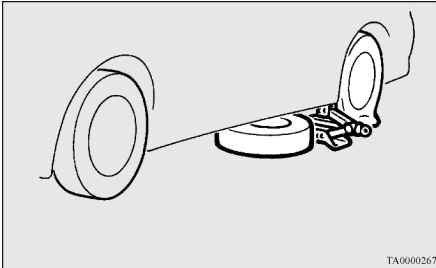

### Except on vehicles with a T155/90D16 size spare wheel

1. Open the tailgate and remove the cover (A) with the jack bar. Refer to “Split tailgate: To open” on page 1-31.

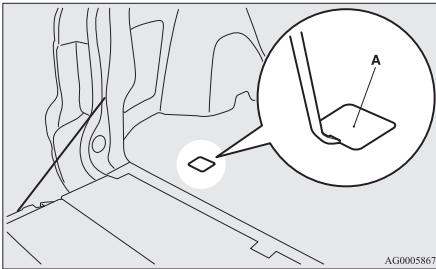

2. Insert the wheel nut wrench in the hole and lower the standard spare wheel by turning it anticlockwise.

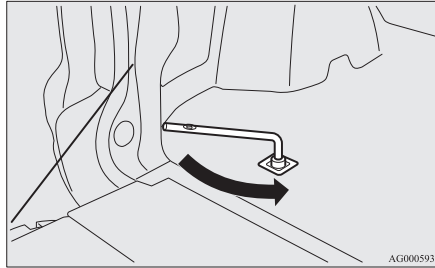

3. Raise the lower gate until it locks properly in position with a click. Refer to “Split tailgate: To close” on page 1-31.
4. Remove the chain from the spare tyre hanger.

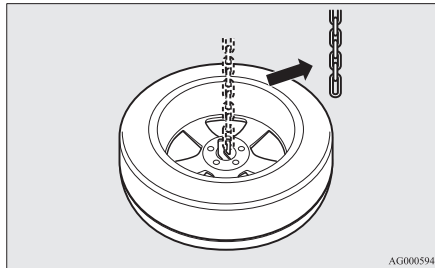

5. Take out the standard spare wheel from the spare tyre hanger.

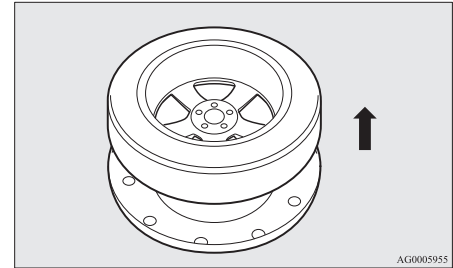

## To change a tyre

E00803200712

1. If a wheel cover is installed, first remove the cover. (Refer to “Wheel covers” on page 6-18.) Then loosen the wheel nuts a quarter turn with the wheel nut wrench. Do not remove the wheel nuts yet.

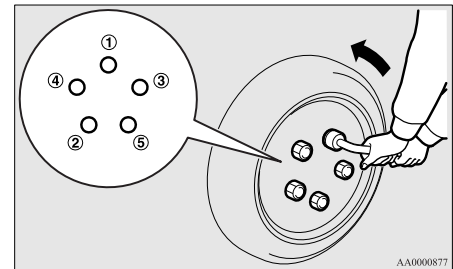

2. Place the jack under one of the jacking points (A) shown in the illustration. Use the

jacking point closest to the tyre you wish to change.

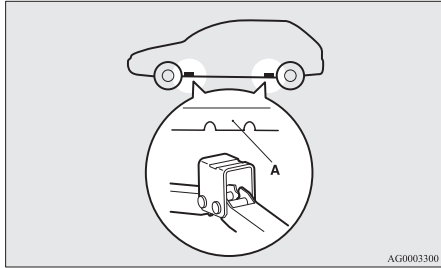

## **⚠ WARNING**

- Set the jack only at the positions shown here. If the jack is set at a wrong position, it could dent your vehicle or the jack might fall over and cause personal injury.
- Do not use the jack on a tilted or soft surface.

Otherwise, the jack might slip and cause personal injury. Always use the jack on a flat, hard surface. Before setting the jack, make sure there are no sand or pebbles under the jack base.

3. Rotate the jack by hand until the flange portion (B) fits in the groove (C) at the top of the tyre.

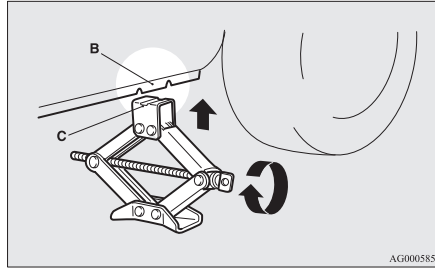

4. Insert the jack bar (D) into the wheel nut wrench (E). Then put the end of the jack bar into the shaft's jack end, as shown in the illustration.

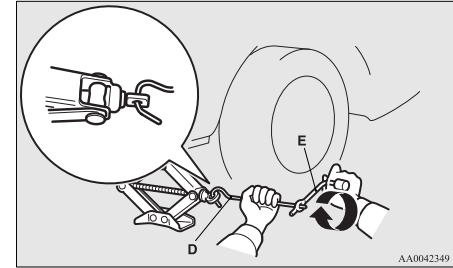

## **⚠ WARNING**

- Stop jacking up the vehicle as soon as the tyre is raised off the ground. It is dangerous to raise the vehicle any higher.
- Do not get under your vehicle while using the jack.
- Do not bump the raised vehicle or leave it sitting on the jack for a long time. Both are very dangerous.
- Do not use a jack except the one that came with your vehicle.
- The jack should not be used for any purpose other than to change a tyre.
- No one should be in your vehicle when using the jack.
- Do not start or run the engine while your vehicle is on the jack.
- Do not turn the raised wheel. The tyres still on the ground could turn and make your vehicle fall off the jack.

## For emergencies

- Remove the wheel nuts with the wheel nut wrench, then take the wheel off.

### **CAUTION**

- Handle the wheel carefully when changing the tyre, to avoid scratching the wheel surface.

- Clean out any mud, etc. on the hub surface (F), hub bolts (G) or in the installation holes (H) in the wheel, and then mount the spare tyre.

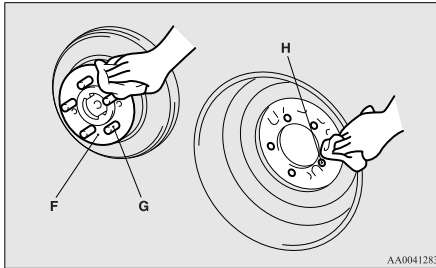

### **WARNING**

- Be sure to position the tyres the correct way when putting them on the vehicle. The valves should be on the outer side of the vehicle. If the valve (I) cannot be seen, the tyre has been mounted the wrong way around.

If tyres are mounted the wrong way around it could have a negative effect on the vehicle and cause an accident.

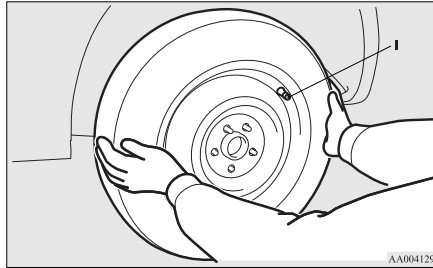

- Turn the wheel nuts clockwise by hand to initially tighten them.

**[On vehicles with steel wheels]**

- Normal wheel and temporary spare wheels  
Initially tighten the wheel nuts until the tapered part (A) of the nuts lightly touches the wheel hole seats (B) enough to keep the tyre from wobbling. Initially tighten the nuts in the same way when mounting the temporary spare wheel.

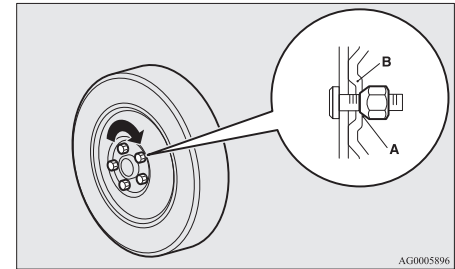

**[On vehicles with aluminium wheels]**

- Normal wheel  
Initially tighten the wheel nuts until the wheel nut flange area (C) touches the



wheel enough to keep the tyre from wobbling.

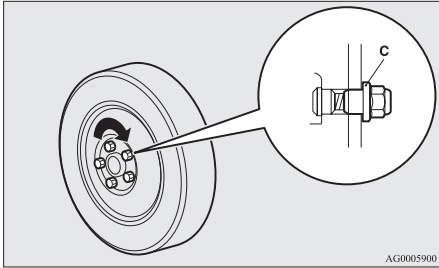

AG0005900

- Steel spare wheel and temporary spare wheel  
Initially tighten the wheel nuts until the tapered area (A) of the nuts lightly touches the wheel hole seat area (B) enough to keep the tyre from wobbling.

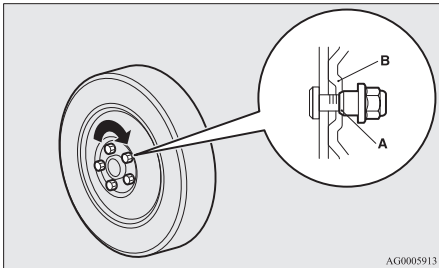

AG0005913

## **CAUTION**

- Never apply oil to either the wheel bolts or the nuts, or they will tighten too much.

### NOTE

- Flange nuts can be temporarily used on the steel wheel, but return to the original wheel and tyre as soon as possible.
- If all 4 aluminium wheels are changed to steel wheels, e.g. when fitting winter tyres, use tapered nuts.

8. Lower the vehicle slowly by rotating the wheel nut wrench anticlockwise until the tyre touches the ground.

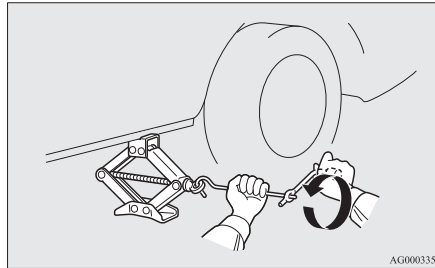

AG0003355

9. Tighten the nuts in the order shown in the illustration until each nut has been tightened to the torque listed here.

Tightening torque 88 to 108 Nm

## For emergencies

(Achieved by applying force of 350 to 420 N at end of wheel nut wrench supplied with vehicle)

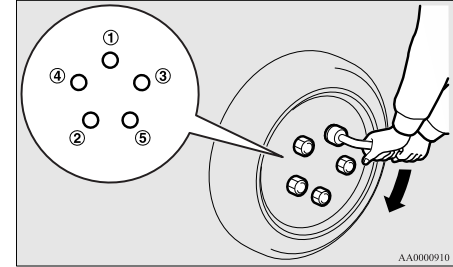

AA0000910

## **CAUTION**

- Never use your foot or a pipe extension for extra force in the wheel nut wrench. If you do so, you will tighten the nut too much.

10. If the vehicle has a wheel cover, install it. Refer to "Wheel covers" on page 6-18.
11. Lower and remove the jack, then store the jack, flat tyre, and chocks. Have your damaged tyre repaired as soon as possible.
12. Check your tyre inflation pressure at the next gasstation. The correct tyre pressures are shown on the driver's door label. See the illustration.

## For emergencies

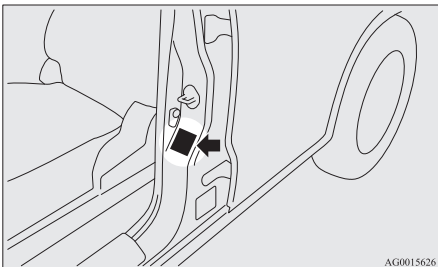

### **⚠ CAUTION**

- The temporary spare wheel is to be used only temporarily when the standard wheel is damaged. Repair the damaged tyre as soon as possible and use it to replace the temporary spare tyre.
- After changing the tyre and driving the vehicle about 1,000 km (620 miles), retighten the wheel nuts to make sure that they have not come loose.
- If the steering wheel vibrates when driving after changing the tyre, we recommend you to have the tyres checked for balance.
- Do not mix one type of tyre with another or use a different size from the one listed. This would cause early wear and poor handling.

## To store the spare wheel

E00803700339

### *On vehicles with a T155/90D16 size spare wheel*

1. Put the tyre on the centre of the tyre hanger, with the wheel surface facing upwards.

### **⚠ CAUTION**

- Storing the tyre with the wheel surface facing down may damage the wheel or tyre hanger. If you find any damage on a spare tyre, do not use the tyre and contact a MITSUBISHI MOTORS Authorized Service Point.

2. Lift up the tyre hanger (A) and hang it on the hook (B).

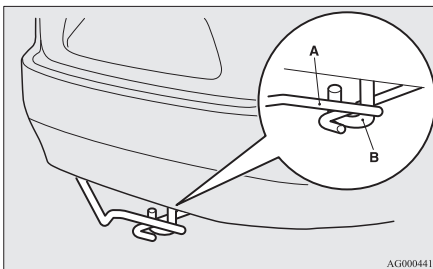

### **⚠ CAUTION**

- Do not attach the hook to any part of the tyre hanger other than the correct position. Otherwise the hook could damage the vehicle body, or the tyre could fall while driving and cause an accident.

3. Open the lower gate. Refer to “Split tailgate: To open” on page 1-31.

4. Tighten the tyre hanger installation bolt securely by turning it clockwise with the wheel nut wrench.

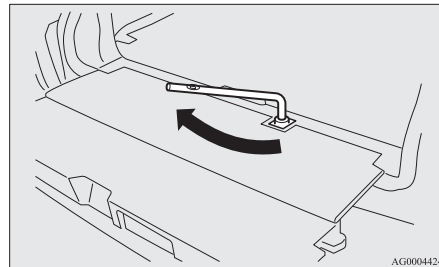

### **⚠ CAUTION**

- After storing the spare wheel, check that the tyre hanger is securely locked in place. If the tyre hanger is not securely locked in place, it could come loose and fall while you are driving and cause an accident.
- When removing the tyre hanger from the hook or hanging it back on the hook, hold the tyre hanger carefully so that it does not drop on your feet.

5. Install the tyre hanger installation bolt cover.

*Except on vehicles with a T155/90D16 size spare wheel*

1. Put the tyre on the spare tyre hanger with the wheel surface facing downwards.

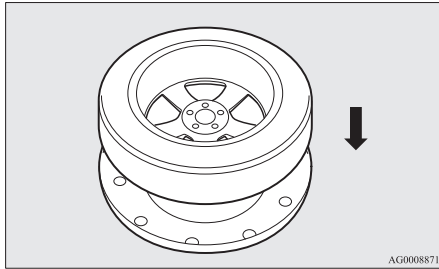

2. Install the chain on the spare tyre hanger.

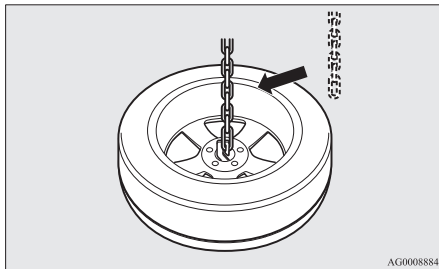

3. Open the lower gate. Refer to "Split tailgate: To open" on page 1-31.
4. Turn the wheel nut wrench until the tyre is secure and the chain is tight. Do not over tighten.

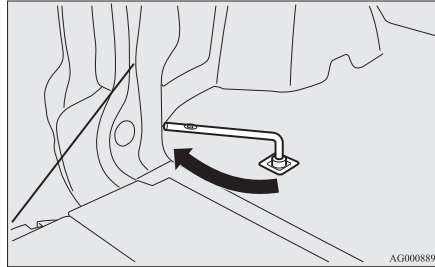

### **CAUTION**

- After storing the spare wheel, check that the spare tyre hanger is securely locked in place. If the spare tyre hanger is not securely locked in place, it could come loose and fall while you are driving and cause an accident.

### NOTE

- Overtightening the nut can damage the gear, resulting in the gear not winding up the chain.

5. Install the cover (A).

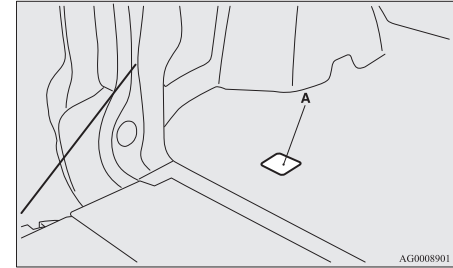

### To store the tools and jack

E00803800037

Reverse the removing procedure when storing the jack, jack bar and wheel nut wrench. Refer to "Tools and jack" on page 6-08.

## For emergencies

### Wheel covers\*

E00801300315

#### To remove

Wrap the tip of the jack bar with a cloth, insert it deeply into the notch provided in the wheel cover, and pry the cover away from the wheel. Using the same procedure at the other wheel cover notches, work the wheel cover away from the wheel to remove it completely.

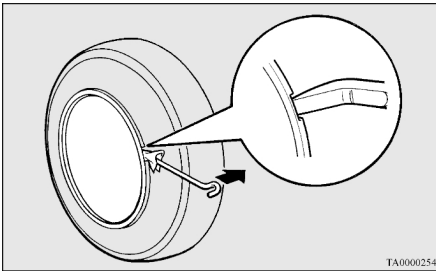

### **⚠ CAUTION**

- Removing the cover with your hands may cause injury to the fingers.

#### NOTE

- The wheel cover is made of plastic. Pry it loose carefully.

#### To install

1. Make sure the tabs (A) of the back of the wheel cover are not broken and correctly fitted on the rings (B). If in doubt, do not install the wheel cover and consult your MITSUBISHI MOTORS Authorized Service Point.

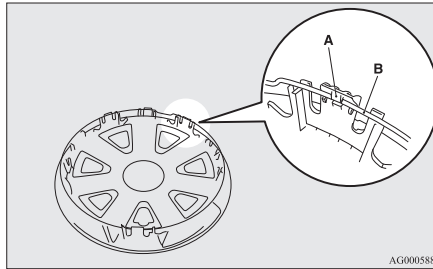

2. Align the tyre valve stem (C) with the cut out area (D) in the wheel cover.

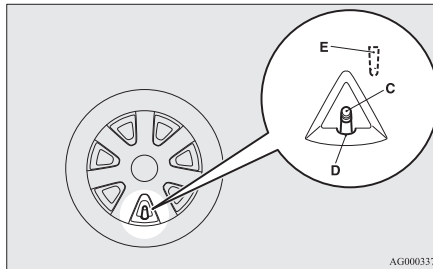

#### NOTE

- There is a symbol (E) on the back of the wheel cover indicating the cut out area.
3. Push the underside (F) of the wheel cover into the wheel.
  4. Gently push both sides (G) of the wheel cover and hold them in place with both knees.
  5. Gently push around the top (H) of the wheel cover.

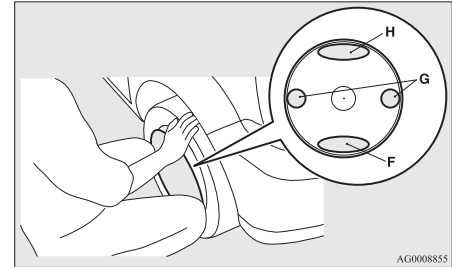

## Towing

E00801503318

### If your vehicle needs to be towed

If you need to tow your vehicle, we recommend that you contact a MITSUBISHI MOTORS Authorized Service Point or tow truck company.

In the following cases, transport the vehicle using a tow truck.

- The engine runs but the vehicle does not move or abnormal noise is produced.
- Inspection of the vehicle's underside reveals that oil or some other fluid is leaking.

If a wheel gets stuck in a ditch, do not try to tow the vehicle.

Please contact your MITSUBISHI MOTORS Authorized Service Point or a commercial tow truck service for assistance.

Only when you cannot receive a towing service from a MITSUBISHI MOTORS Authorized Service Point or commercial tow truck service, tow your vehicle carefully in accordance with the instructions given in "Emergency towing" in this part.

The regulations concerning towing may differ from country to country. It is recommended that you obey the regulations of the area where you are driving your vehicle.

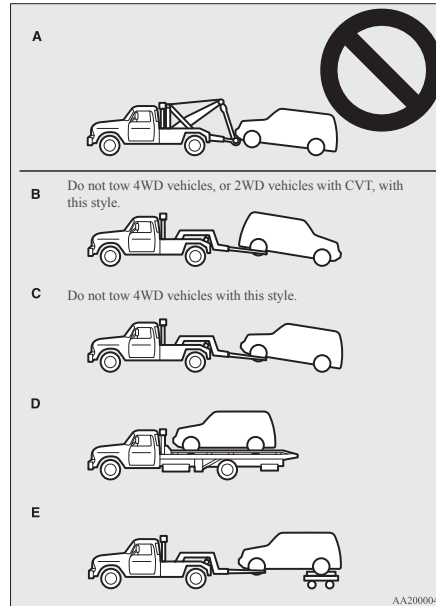

### Towing the vehicle by a tow truck

#### **⚠ CAUTION**

- This vehicle must not be towed by a tow truck using sling lift type equipment (Type A) as illustrated. Using a sling lift will damage the bumper and front end.
- Do not tow 2WD vehicles with CVT with the driving wheels on the ground (Type B) as illustrated. This could result in the driving system damage.
- Do not tow 4WD vehicles with the front or rear wheels on the ground (Type B or Type C) as illustrated. This could result in driving system damage or the vehicle may jump at the carriage. If you tow 4WD vehicles, use Type D or E equipment.
- On 2WD vehicles, if the transmission is malfunctioning or damaged, transport the vehicle with the driving wheels on a carriage (Type C, D or E) as illustrated.
- 4WD vehicles cannot be towed with only the front or rear tyres on the ground even if they are in "2WD" drive mode.

## For emergencies

### **⚠ CAUTION**

- [For 2WD vehicles equipped with the Active Stability Control (ASC)]  
If the vehicle is towed with the ignition switch in the “ON” position and only the front wheels or only the rear wheels raised off the ground (Type B or C), the ASC may operate, resulting in an accident. When towing the vehicle with the front wheels raised, keep the ignition switch in the “LOCK” or “ACC” position. When towing the vehicle with the rear wheels raised, keep the ignition switch in the “ACC” position.

#### **Towing with rear wheels off the ground (Type B)**

Place the gearshift lever in the “N” (Neutral) position.

Turn the ignition switch to the “ACC” position and secure the steering wheel in a straightahead position with a rope or tie-down strap. Never place the ignition switch in the “LOCK” position when towing.

#### **Towing with front wheels off the ground (Type C)**

Release the parking brake.

Place the gearshift lever in the “N” (Neutral) position (M/T) or the selector lever in the “N” (NEUTRAL) position (CVT).

### **Emergency towing**

If towing service is not available in an emergency, your vehicle may be temporarily towed by a rope secured to the towing hook.

If your vehicle is to be towed by another vehicle or if your vehicle tows another vehicle, pay careful attention to the following points:

#### **If your vehicle is to be towed by another vehicle**

1. The front towing hook (A) is located as shown in the illustration. Secure the tow rope to the front towing hook.

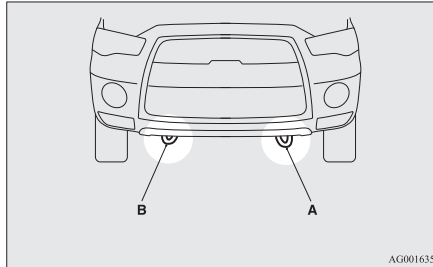

#### **NOTE**

- Do not use the tie-down hook (B) for towing. This hook is provided only for the purpose of transporting the vehicle itself. Using any part other than the designated towing hook (A) could result in damage to the vehicle body.
- Using a wire rope or metal chain can result in damage to the vehicle body. It is best to use a non-metallic rope. If you use a wire rope or metal chain, wrap it with cloth at any point where it touches the vehicle body.
- Take care that the tow rope is kept as horizontal as possible. An angled tow rope can damage the vehicle body.

2. Keep the engine running.

If the engine is not running, turn the ignition switch to the “ACC” or “ON” position (M/T) or “ON” position (A/T or CVT) to unlock the steering wheel.

#### **NOTE**

- For vehicles equipped with the Auto Stop & Go (AS&G) system, press the “Auto Stop & Go (AS&G) OFF” switch to deactivate the Auto Stop & Go (AS&G) system before stopping the vehicle. Refer to “To deactivate” on page 4-21.

### **⚠ WARNING**

- When the engine is not running, the brake booster and power steering pump do not operate. This means higher brake depression force and higher steering effort are required. Therefore, vehicle operation is more difficult than usual.

### **⚠ CAUTION**

- On vehicles with Twin Clutch SST, have the vehicle transported by a tow truck with all wheels raised off the ground if the engine does not start. If the vehicle is towed without starting the engine, the Twin Clutch SST may be damaged because the fluid will not reach all parts of the transmission. Refer to “If your vehicle needs to be towed” on page 6-19.
- Do not leave the ignition switch in the “LOCK” position. The steering wheel will lock, causing loss of control.

3. Place the gearshift lever (M/T) in the “Neutral” position, or the selector lever (A/T or CVT) or gearshift lever (Twin Clutch SST) in the “N” (NEUTRAL) position.

- Turn on the hazard warning lamps if required by law. (Follow the local driving laws and regulations.)
- During towing make sure that close contact is maintained between the drivers of both vehicles, and that the vehicles travel at low speed.

## **⚠ WARNING**

- Avoid sudden braking, acceleration and steering wheel movements; such driving operation could cause damage to the towing hook or tow rope. People in the vicinity could be injured as a result.
- When going down a long slope, the brakes may overheat, reducing effectiveness. Have your vehicle transported by a tow truck.

## **⚠ CAUTION**

- When the vehicle equipped with A/T, CVT or Twin Clutch SST is to be towed by another vehicle with the all wheels on the ground, make sure that the towing speed and distance given below are never exceeded, causing damage to the transmission.

Towing speed: 40 km/h (25 mph)  
Towing distance: 40 km (25 miles)

For the towing speed and the towing distance, follow the local driving laws and regulations.

### *If your vehicle tows another vehicle*

- Take out the towing hook, wheel nut wrench and jack bar.  
Refer to “Tools and jack” on page 6-08.
- Cover the end of the jack bar (C) with cloth and use it to remove the lid from the rear bumper.

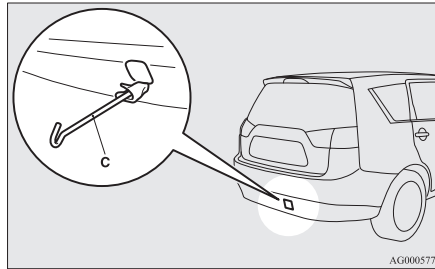

- Use the wheel nut wrench (D) to firmly attach the towing hook.

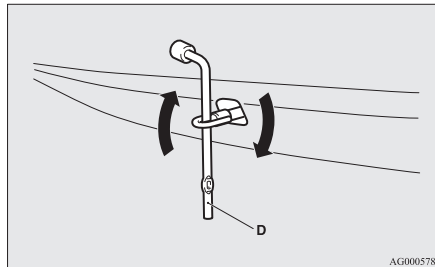

- Always attach the tow rope to the towing hook. Otherwise, the instructions are the same as for “When being towed by another vehicle”.
- When finished towing, remove the towing hook, and stow it in the specified location. Refer to “Tools and jack” on page 6-08. When installing the bumper lid, align the hook with the cut out area on the vehicle, and firmly insert.

### NOTE

- Do not tow a vehicle heavier than your own vehicle.

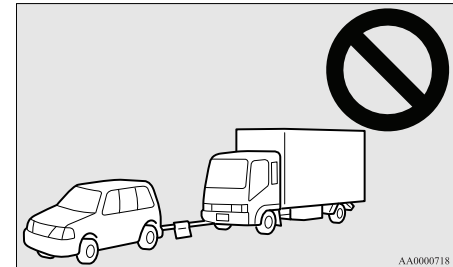

## For emergencies

### *Operation under adverse driving conditions*

E00801702629

#### **On a flooded road**

- Avoid flooded roads. Water could enter the brake discs, resulting in temporarily ineffective brakes. In such cases, lightly depress the brake pedal to see if the brakes operate properly. If they do not, lightly depress the pedal several times while driving in order to dry the brake pads.
- When driving in rain or on a road with many puddles a layer of water may form between the tyres and the road surface. This reduces a tyre's frictional resistance on the road, resulting in loss of steering stability and braking capability.

To cope with this, observe the following items:

- (a) Drive your vehicle at slow speed.
- (b) Do not drive on worn tyres.
- (c) Always maintain the specified tyre inflation pressures.

#### **On a snow-covered or frozen road**

- The use of snow tyres or tyre chains is recommended for driving on snow and ice. Refer to the "Snow tyres" and "Tyre chains" sections.
- Avoid high-speed driving, sudden acceleration, sudden braking, and sharp turns.

- Depressing the brake pedal during travel on snowy or icy roads may cause tyre slippage and skidding. Tyres may slip if the ability of the tyres to grip the road surface lessens. This may make it more difficult to stop the vehicle with normal braking operations. For vehicles with an anti-lock brake system (ABS), firmly depress and hold down the brake pedal.
- Allow extra distance between your vehicle and the vehicle in front of you, and avoid sudden braking.
- Accumulation of ice on the braking system can cause the wheels to lock. Pull away from a standstill slowly after confirming safety around the vehicle.

#### **CAUTION**

- **Do not press the accelerator pedal rapidly. If the wheels break free of the ice, the vehicle could suddenly start moving and possibly cause an accident.**

#### **On a bumpy or rutted road**

- Drive as slow as possible when driving on bumpy or rutted roads.

#### **CAUTION**

- **The impact on tyres and/or wheels when driving on a bumpy or rutted road can damage the tyre and/or wheel.**



## *Vehicle care*

Vehicle care precautions.....	7-02
Cleaning the interior of your vehicle.....	7-02
Cleaning the exterior of your vehicle.....	7-03

## Vehicle care precautions

E00900100548

In order to maintain the value of your vehicle, it is necessary to perform regular maintenance using the proper procedures.

Always maintain your vehicle in compliance with environmental pollution control regulations.

Carefully select the materials used for washing, etc., to be sure that they do not contain corrosives. If in doubt, we recommend you to consult a specialist for selection of these materials.

### CAUTION

- **Cleaning products can be dangerous. Always follow the instructions of the cleaning product supplier.**
- **To avoid damage, never use the following to clean your vehicle:**
  - Petrol
  - Paint Thinner
  - Benzine
  - Kerosene
  - Turpentine
  - Naphtha
  - Lacquer Thinner
  - Carbon Tetrachloride
  - Nail Polish Remover
  - Acetone

## Cleaning the interior of your vehicle

E00900200220

After cleaning the interior of your vehicle with water, cleaner or similar, wipe and dry in a shady, well-ventilated area.

### CAUTION

- **Do not use organic substances (solvents, benzine, kerosene, alcohol, petrol, etc.) or alkaline or acidic solutions. These chemicals can cause discolouring, staining or cracking of the surface. If you use cleaners or polishing agents, make sure their ingredients do not include the substances mentioned above.**

## Plastic, vinyl leather, fabric and flocked parts

E00900300319

1. Gently wipe off with a sponge, gauze or other soft cloth soaked with a 3% aqueous solution of neutral detergent.
2. Dip cloth in fresh water and wring it out well. Using this cloth, wipe off the detergent thoroughly.

## NOTE

- Do not use cleaners, conditioners, and protectants containing silicones or wax. Such products, when applied to the instrument panels or other parts, may cause reflections on the windscreen and obscure vision. Also, if such products get on the switches of the electrical accessories, it may lead to failure of these accessories.

## Upholstery

E00900500076

1. To maintain the value of your new vehicle, handle the upholstery carefully and keep the interior clean. Use a vacuum cleaner and brush to clean the seats. If stained, vinyl and synthetic leather should be cleaned with an appropriate cleaner. Cloth fabrics can be cleaned with either upholstery cleaner or a 3% aqueous solution of neutral detergent in lukewarm water.
2. Clean the carpeting with a vacuum cleaner and remove any stains with carpet cleaner. Oil and grease can be removed by lightly dabbing with a clean colourfast cloth and stain remover.

## Genuine leather\*

E00900600804

1. Gently wipe off with gauze or other soft cloth soaked with a 5 % aqueous solution of neutral detergent.
2. Dip cloth in fresh water and wring it out well. Using this cloth, wipe off the detergent thoroughly.
3. Apply leather protecting agent to the genuine leather surface.

## NOTE

- If genuine leather is wet with water or is washed in water, wipe off water as quickly as possible with a dry, soft cloth. If left damp, mildew may grow.
- The genuine leather surface may be damaged if a nylon brush or synthetic fibre is rubbed hard against it.
- Organic solvents such as benzine, kerosene, alcohol and petrol, acid or alkaline solvents may discolour the genuine leather surface. Be sure to use neutral detergents.
- Remove dirty patches or oil substances quickly as they can stain genuine leather.
- The genuine leather surface may harden and shrink if it is exposed to direct sun for long hours. When your vehicle is parked, place it in the shade as much as possible.
- When the temperature of the vehicle interior rises in summer, vinyl products left on the genuine leather seat may deteriorate and stick to the seat.

## Cleaning the exterior of your vehicle

E00900700108

If the following is left on your vehicle, it may cause corrosion, discolouration and stains, wash the vehicle as soon as possible.

- Seawater, road deicing products.
- Soot and dust, iron powder from factories, chemical substance (acids, alkalis, coal-tar, etc.).
- Droppings from birds, carcasses of insects, tree sap, etc.

## Washing

E00900902003

Chemicals contained in the dirt and dust picked up from the road surface can damage the paint coat and body of your vehicle if left in prolonged contact. Frequent washing and waxing is the best way to protect your vehicle from this damage. This will also be effective in protecting it from environmental elements such as rain, snow, salt air, etc.

Do not wash the vehicle in direct sunlight. Park the vehicle in the shade and spray it with water to remove dust. Next, using an ample amount of clean water and a car washing brush or sponge, wash the vehicle from top to bottom.

Use a mild car washing soap if necessary. Rinse thoroughly and wipe dry with a soft cloth. After washing the vehicle, carefully clean the joints and flanges of the doors, bonnet and other sections where dirt is likely to remain.

## CAUTION

- When washing the under side of your vehicle or wheel, be careful not to injure your hands.
- If your vehicle has rain sensor wipers, place the wiper switch lever in the “OFF” position to deactivate the rain sensor before washing the vehicle. Otherwise, the wipers will operate in the presence of water spray on the windscreen and may get damaged as a result.
- Refrain from excessively using a car wash as its brushes may scratch the paint surface, causing it to lose its gloss. Scratches will be especially visible on darker coloured vehicles.
- Never spray or splash water on the electrical components in the engine compartment. Doing so could have an adverse effect on the engine startability. Exercise caution also when washing the underbody; be careful not to spray water into the engine compartment.

## **⚠ CAUTION**

- Some types of hot water washing equipment apply high pressure and heat to the vehicle. They may cause heat distortion and damage to the vehicle resin parts and may result in flooding of the vehicle interior.

Therefore;

- Maintain a distance of approx. 40 cm or more between the vehicle body and the washing nozzle.
- When washing around the door glass, hold the nozzle at a distance of more than 50 cm and at right angles to the glass surface.
- After washing the vehicle, drive the vehicle slowly while lightly depressing the brake pedal several times in order to dry out the brakes.  
Leaving the brakes wet could result in reduced braking performance. Also, there is a possibility that they could freeze up or become inoperative due to rust, rendering the vehicle unable to move.
- Using an automatic car wash, pay attention to the following items, referring to the operation manual or consulting a car wash operator. If the following procedure is not followed, it could result in damage to your vehicle.

- The outside rear-view mirrors are retracted.
- The antenna is removed.
- The wiper arms are secured in place with tape.

## **⚠ CAUTION**

- If your vehicle is equipped with a rear spoiler or roof rails, consult a car wash operator before using the car wash.
- If your vehicle has rain sensor wipers, place the wiper switch lever in the “OFF” position to deactivate the rain sensor.

### *During cold weather*

Salt and other chemicals spread on the roads in some areas in winter can have a harmful effect on the vehicle body. You should therefore wash the vehicle as often as possible in accordance with our care-instructions. It is recommended to have a preservative applied and the underfloor protection checked before and after the cold weather season. After washing your vehicle, wipe off all water-drops from the rubber parts around the doors to prevent the doors from freezing.

### NOTE

- To prevent freezing of the weatherstripping on the doors, bonnet, etc., they should be treated with silicone spray.

## Waxing

E00901000616

Waxing the vehicle will help prevent the adherence of dust and road chemicals to the paintwork. Apply a wax solution after washing the vehicle, or at least once every three months to assist displacing of water. Do not wax your vehicle in direct sunlight. You should wax after the surfaces have cooled.

## **⚠ CAUTION**

- Waxes containing high abrasive compounds should not be used. Such waxes remove rust and stains effectively from the paintwork but they are harmful to the lustre on the painted surface and the plated surface.

Further, they are harmful to glossy surfaces such as grille, garnish, mouldings, etc.

- Do not use petrol or paint thinners to remove road tar or other contamination to the painted surface.
- Do not apply wax to sections that have a black mat paint coating, as doing so could cause uneven discolouration, spots or stains. If wax gets on such areas, wipe it off using lukewarm water and a soft cloth.
- On vehicles with a sunroof, be careful when waxing the area around the sunroof opening, not to put any wax on the weatherstrip (black rubber). If stained with wax, the weatherstrip cannot maintain a weatherproof seal with the sunroof.

## Polishing

E00901100066

The vehicle should only be polished if the paintwork has become stained or lost its lustre. Do not polish parts with a mat coating and the plastic bumpers. Doing so could cause stains or damage the finish.

## Damaged paint

E00901200054

Small cracks and scratches in the paint coat should be touched up as soon as possible with MITSUBISHI touch-up paint to prevent corrosion.

Check body areas facing the road or the tyres carefully for damage to the paint caused by gravels, etc. The paint code number for your vehicle can be found on the vehicle information code plate in the engine compartment.

### Cleaning plastic parts

E00901300707

Use a sponge or chamois leather.

If a car wax adheres on a grey or black rough surface of the bumper, moulding or lamps, the surface becomes white. In such a case, wipe it off using lukewarm water and soft cloth or chamois leather.

### CAUTION

- Do not use a scrubbing brush or other hard tools as they may damage the plastic part surface.
- Do not use wax containing compound (polishing powder) which may damage the plastic part surface.
- Do not bring the plastic parts into contact with petrol, light oil, brake fluids, engine oils, greases, paint thinners, and sulphuric acid (battery electrolyte) which may crack, stain or discolour the plastic parts. If they touch the plastic parts, wipe them off with soft cloth, chamois or the like and an aqueous solution of neutral detergent then immediately rinse the affected parts with water.

### Chrome parts

E00901400098

In order to prevent spots and corrosion of chrome parts, wash with water, dry thoroughly, and apply a special protective coating. This should be done more frequently in winter.

### Aluminium wheels\*

E00901500347

1. Remove dirt using a sponge while sprinkling water on the vehicle.
2. Use neutral detergent on any dirt that cannot be removed easily with water. Rinse off the neutral detergent after washing the vehicle.
3. Dry the vehicle thoroughly using a chamois leather or a soft cloth.

### CAUTION

- Do not use a brush or other hard implement on the wheels. Doing so could scratch the wheels.
- Do not use any cleaner that contains an abrasive substance or is acidic or alkaline. Doing so could cause the coating on the wheels to peel or become discoloured or stained.
- Do not directly apply hot water using a steam cleaner or by any other means.
- Contact with seawater and road deicer can cause corrosion. Rinse off such substances as soon as possible.

### Window glass

E00901600117

The window glass can normally be cleaned using only a sponge and water.

Glass cleaner can be used to remove oil, grease, dead insects, etc. After washing the glass, wipe dry with a clean, dry, soft cloth. Never use a cloth that is used for cleaning a painted surface to clean a window. Wax from the painted surface could get on the glass and lower glass transparency and visibility.

### NOTE

- To clean the inside of the rear window, always use a soft cloth and wipe the window glass along the demister heater element so as not to cause damage.

### Wiper blades

E00901700062

Use a soft cloth and glass cleaner to remove grease, dead insects, etc., from the wiper blades. Replace the wiper blades when they no longer wipe properly. (Refer to page 8-15.)

### Cleaning the sunroof\*

E00902200051

Use a soft cloth to clean the inner side of the sunroof. Hard deposits should be wiped away with a cloth dipped in warm, neutral detergent solution. Wipe away the solution with a sponge dipped in fresh water.

### NOTE

- The surface treatment on the inside of the glass may be removed if hard cloth or organic solvent (benzine, kerosene, thinner, etc.) is used.

### Engine compartment

E00902100308

Clean the engine compartment at the beginning and end of winter. Pay particular attention to flanges, crevices and peripheral parts where dust containing road chemicals and other corrosive materials might collect.

If salt and other chemicals are used on the roads in your area, clean the engine compartment at least every three months.

## Vehicle care

Never spray or splash water on the electrical components in the engine compartment, as this may cause damage.

Do not bring the nearby parts, the plastic parts and so on into contact with sulphuric acid (battery electrolyte) which may crack, stain or discolour them.

If they are in contact, wipe off with soft cloth, chamois or the like and an aqueous solution of neutral detergent then immediately rinse the affected parts with plenty of water.

# Maintenance

Service precautions.....	8-02
Catalytic converter.....	8-02
Bonnet.....	8-03
Engine oil.....	8-04
Engine coolant.....	8-06
Washer fluid.....	8-08
Brake fluid/Clutch fluid*.....	8-08
Power steering fluid.....	8-09
Battery.....	8-09
Tyres.....	8-11
Parking brake break-in.....	8-15
Wiper blade rubber replacement.....	8-15
General maintenance.....	8-17
For cold and snowy weather.....	8-17
Fusible links.....	8-18
Fuses.....	8-18
Replacement of lamp bulbs.....	8-23

## Service precautions

E01000100474

Adequate care of your vehicle at regular intervals serves to preserve the value and appearance as long as possible.

Maintenance items as described in this owner's manual can be performed by the owner.

We recommend you to have the periodic inspection and maintenance performed by a MITSUBISHI MOTORS Authorized Service Point or another specialist.

In the event a malfunction or a problem is discovered, we recommend you to have it checked and repaired. This section contains information on inspection maintenance procedures that you can do yourself. Follow the instructions and cautions for each of the various procedures.

### **WARNING**

- When checking or servicing the inside of the engine compartment, make sure the engine is switched off and has had a chance to cool down.
- If it is necessary to do work in the engine compartment with the engine running, be especially careful that your clothing, hair, etc., does not become caught by the fan, drive belts, or other moving parts.
- The fan may turn on automatically even if the engine is not running. Turn the ignition switch to the "LOCK" position to be safe while you work in the engine compartment.
- Do not smoke, cause sparks or allow open flames around fuel or battery. The fumes are flammable.

### **WARNING**

- Be extremely cautious when working around the battery. It contains poisonous and corrosive sulphuric acid.
- Do not get under your vehicle with just the body jack supporting it. Always use automotive jack stands.
- Improper handling of components and materials used in the vehicle can endanger your personal safety. We recommend you to consult a specialist for necessary information.

## Catalytic converter

E01000200765

The exhaust gas scavenging devices used with the catalytic converter are extremely efficient for the reduction of noxious gases. The catalytic converter is installed in the exhaust system.

It is important to keep the engine properly tuned to ensure proper catalyst operation and prevent possible catalyst damage.

### **WARNING**

- As with any vehicle, do not park or operate this vehicle in areas where combustible materials such as dry grass or leaves can come in contact with a hot exhaust since a fire could occur.
- Paint should not be applied to the catalytic converter.

#### NOTE

- Use fuel of the type recommended in "Fuel selection" on page 02.



## Bonnet

E01000302454

### To open

1. Pull the release lever towards you to unlock the bonnet.

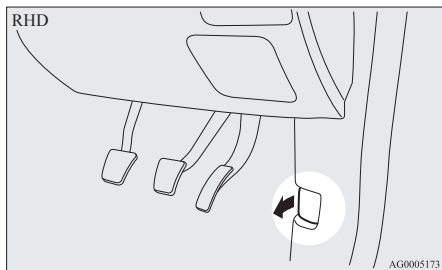
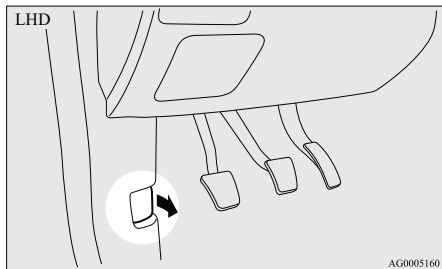

2. Raise the bonnet while pressing the safety lock.

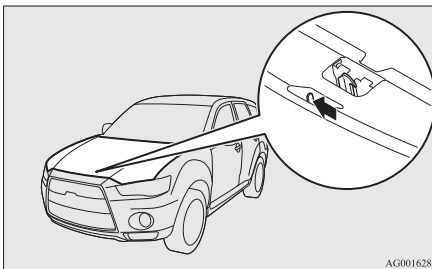

### NOTE

- Only open the bonnet when the wipers are in the parked position. In any other position, the wipers could damage the paint or bonnet.

3. Support the bonnet by inserting the support bar in its slot.

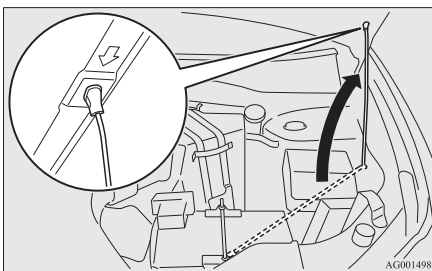

### ⚠ CAUTION

- Note that the support bar may disengage the bonnet if the open bonnet is lifted by a strong wind.

### ⚠ CAUTION

- After inserting the support bar into the slot, make sure the bar supports the bonnet securely from falling down on to your head or body.

### To close

1. Unlatch the support bar and clip it in its holder.
2. Slowly lower the bonnet to a position about 20 cm above the closed position, then let it drop.
3. Make sure the bonnet is securely locked by softly lifting the centre of the bonnet.

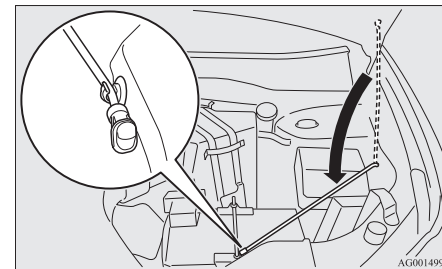

### ⚠ CAUTION

- Be careful that hands or fingers are not trapped when closing the bonnet.
- Before driving, make sure that the bonnet is securely locked. An incompletely locked bonnet can suddenly open while driving. This can be extremely dangerous.

## Maintenance

### NOTE

- If this does not close the bonnet, release it from a slightly higher position.
- Do not press down firmly on the bonnet as doing so could damage it.
- For vehicles equipped with the security alarm system, if you drive with the bonnet left open, warning display is displayed on the information screen in the multi-information display.

Type 1



Type 2



## Engine oil

E01000402569

### To check and refill engine oil

#### Petrol-powered vehicles

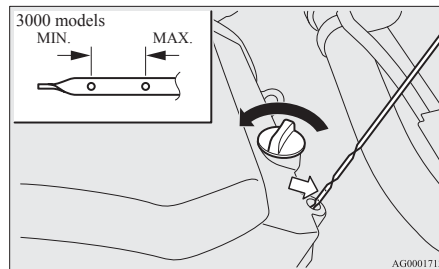
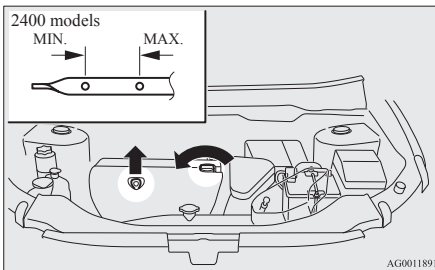
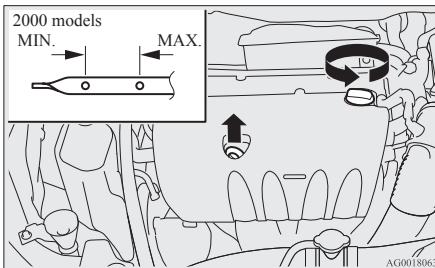

#### Diesel-powered vehicles

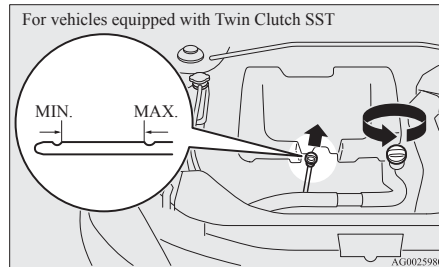
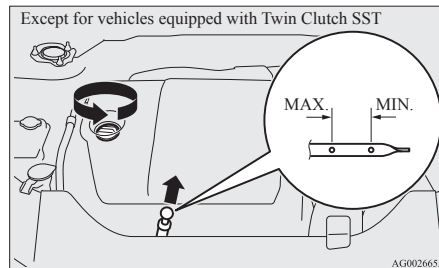

The engine oil used has a significant effect on the engine's performance, service life and startability. Be sure to use oil of the recommended quality and appropriate viscosity.

All engines consume a certain amount of oil during normal operation. Therefore, it is important to check the oil level at regular intervals or before starting a long trip.

1. Park the car on a horizontal surface.
2. Switch off the engine.
3. Wait a few minutes.
4. Remove the dipstick and wipe it with a clean cloth.
5. Reinsert the dipstick as far as it goes.
6. Remove the dipstick and read the oil level, which should always be within the range indicated.
7. If the oil level is below the specified limit, remove the cap located on the cylinder head cover and add enough oil to raise the level to within the specified range. Do not overfill to avoid engine damage. Be sure to use the specified engine oil and do not mix various types of oil.
8. After adding oil, close the cap securely.
9. Confirm the oil level by repeating step 4 to 6.

## CAUTION

- In diesel-powered vehicles equipped with M/T, when burning away and removing soot accumulated in the DPF, fuel can mix with the engine oil and an increase in the engine oil level may occur. This does not indicate an abnormality. However, if the engine oil level is at or over the "X" mark (B) on the engine oil dipstick (A), change the engine oil.

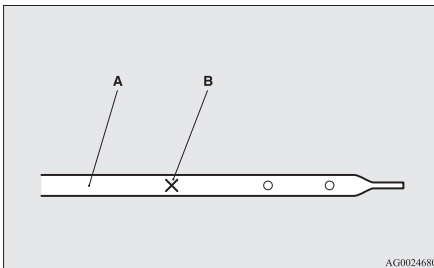

### NOTE

- For 3000 models, to check the oil level, pull the dipstick straight out and check the oil level by checking the upper surface of the dipstick.
- The engine oil will deteriorate rapidly if the vehicle is subjected to severe conditions, requiring earlier oil replacement. Please refer to the maintenance schedule.
- For information on how to dispose of used engine oil, refer to page "Safety and disposal information for used engine oil" on page 06.

## Recommended engine oil viscosity

### *Petrol-powered vehicles*

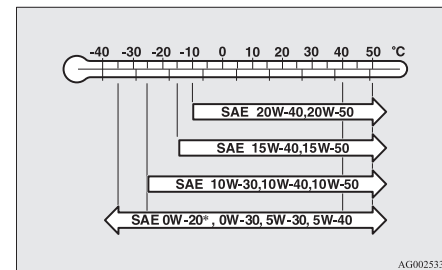

- Select engine oil of the proper SAE viscosity number according to the atmospheric temperature. SAE 0W-20\*, 0W-30, 5W-30, and 5W-40 engine oils can only be used if they meet ACEA A3/B3, A3/B4 or A5/B5 and API SM specifications.  
\*: Except for 3000 models
- Use engine oil conforming to the following classification:
  - API classification: "For service SM"
  - ILSAC certified oil
  - ACEA classification: "For service A1/B1, A3/B3, A3/B4 or A5/B5"

## Maintenance

### NOTE

- Use of additives is not recommended since they may reduce the effectiveness of additives already included in the engine oil. It may result in failure of the mechanical assembly.

### Diesel-powered vehicles

#### Except for vehicles equipped with Twin Clutch SST

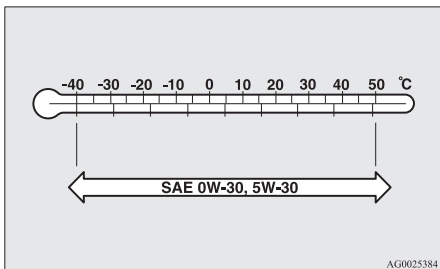

- Select engine oil of the proper SAE viscosity number according to the atmospheric temperature.
- Use engine oil conforming to the following classification:
  - ACEA classification:  
“For service C1, C2, C3 or C4”
  - JASO classification:  
“For service DL-1”

If those classifications are not available, contact a MITSUBISHI MOTORS Authorized Service Point.

### NOTE

- Use of additives is not recommended since they may reduce the effectiveness of additives already included in the engine oil. It may result in failure of the mechanical assembly.

#### For vehicles equipped with Twin Clutch SST

Use engine oil conforming to the following classification:

- “TOTAL ACTIVA INEO ECS 5W-30”
- “TOTAL QUARTZ INEO ECS 5W-30”
- “TOTAL ACTIVA 7000 10W-40”
- “TOTAL QUARTZ 7000 10W-40”
- “TOTAL ACTIVA 9000 5W-40”
- “TOTAL QUARTZ 9000 5W-40”

### NOTE

- Use of additives is not recommended since they may reduce the effectiveness of additives already included in the engine oil. It may result in failure of the mechanical assembly.

## Engine coolant

E01000501664

### To check the coolant level

A transparent coolant reserve tank (A) is located in the engine compartment.

The coolant level in this tank should be kept between the “LOW” and “FULL” marks when measured while the engine is cold.

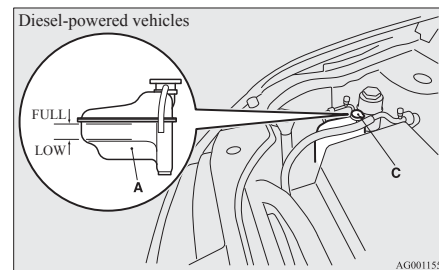
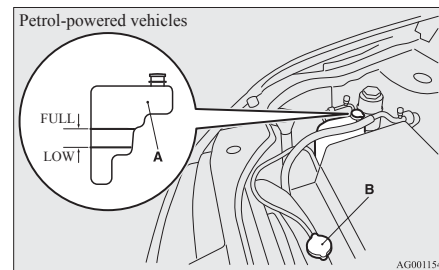

## To add coolant

### *Petrol-powered vehicles*

The cooling system is a closed system and normally the loss of coolant should be very slight. A noticeable drop in the coolant level could indicate leakage. If this occurs, we recommend you to have the system checked as soon as possible.

If the level should drop below the "LOW" level on the reserve tank, open the lid and add coolant.

Also, if the reserve tank is completely empty, remove the radiator cap (B) and add coolant until the level reaches the filler neck.

### **WARNING**

- Do not open the radiator cap (B) while the engine is hot. The coolant system is under pressure and any hot coolant escaping could cause severe burns.

### *Diesel-powered vehicles*

The cooling system is a closed system and normally the loss of coolant should be very slight. A noticeable drop in the coolant level could indicate leakage. If this occurs, we recommend you to have the system checked as soon as possible.

If the level should drop below the "LOW" level on the reserve tank, open the lid and add coolant.

### **WARNING**

- Do not open the reserve tank cap (C) while the engine is hot. The coolant system is under pressure and any hot coolant escaping could cause severe burns.

## Anti-freeze

### *Except for vehicles equipped with Twin Clutch SST*

The engine coolant contains an ethylene glycol anti-corrosion agent. Some parts of the engine are cast aluminium alloy, and periodic changing of the engine coolant is necessary to prevent corrosion of these parts.

Use "DIA QUEEN SUPER LONG LIFE COOLANT PREMIUM" or equivalent\*.

- \*: similar high quality ethylene glycol based non-silicate, nonamine, non-nitrate and non-borate coolant with long life hybrid organic acid technology

mitsubishi Genuine Coolant has excellent protection against corrosion and rust formation of all metals including aluminium and can avoid blockages in the radiator, heater, cylinder head, engine block, etc.

Because of the necessity of this anti-corrosion agent, the coolant must not be replaced with plain water even in summer. The required concentration of anti-freeze differs depending on the expected ambient temperature.

Above -35 °C: 50 % concentration of anti-freeze

Below -35 °C: 60 % concentration of anti-freeze

### **CAUTION**

- Do not use alcohol or methanol anti-freeze or any engine coolants mixed with alcohol or methanol anti-freeze. The use of an improper anti-freeze can cause corrosion of the aluminium components.
- Do not use water to adjust the concentration of coolant.
- Concentrations exceeding 60 % will result in a reduction of both the anti-freeze and cooling performance thus adversely affecting the engine.
- Do not top up with water only. Water by itself reduces the rust-protective and anti-freeze qualities of the coolant and has a lower boiling point. It can also cause damage to the cooling system if it should freeze. Do not use tapwater, as it can cause corrosion and rust formation.

### **During cold weather**

If the temperatures in your area drop below freezing, there is the danger that the coolant in the engine or radiator could freeze and cause severe damage to the engine and/or radiator. Add a sufficient amount of anti-freeze to the coolant to prevent it from freezing.

The concentration should be checked before the start of cold weather and anti-freeze added to the system if necessary.

### *For vehicles equipped with Twin Clutch SST*

The engine coolant contains an ethylene glycol anti-corrosion agent. The cylinder head and water pump housing are cast aluminium alloy, and periodic changing of the engine coolant is necessary to prevent corrosion of these parts.

## Maintenance

Use “BASF Glysantin Alu Protect Premium/G30 or G33” or equivalent.

This coolant has excellent protection against corrosion and rust formation of all metals including aluminium and can avoid clogs in the radiator, heater, cylinder head, engine block, etc.

Because of the necessity of this anti-corrosion agent, the coolant must not be replaced with plain water even in summer.

## Washer fluid

E01000700539

Open the washer fluid reservoir cap and check the level of washer fluid with the dipstick.

If the level is low, replenish the container with washer fluid.

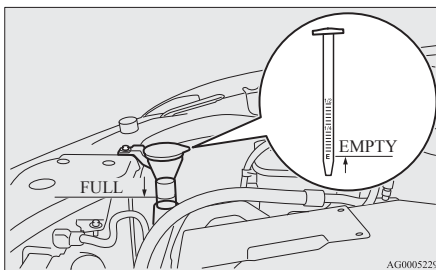

### NOTE

- The washer fluid container serves the windscreen, rear window and headlamps (if so equipped).

### During cold weather

To ensure proper operation of the washers at low temperatures, use a fluid containing an anti-freezing agent.

## Brake fluid/Clutch fluid\*

E01000800631

The brake fluid and the clutch fluid share the reservoir tank.

### To check the fluid level

The fluid level must be between the “MAX” and “MIN” marks on the reservoir.

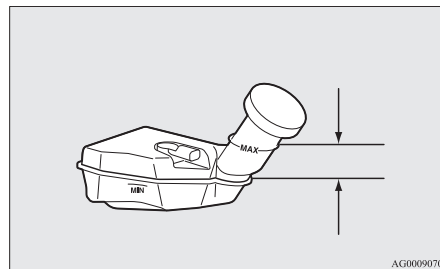

The fluid level is monitored by a float. When the fluid level falls below the “MIN” mark, the brake fluid warning lamp lights up.

The fluid level falls slightly with wear of the brake pads, but this does not indicate any abnormality.

The fluid in the master cylinder should be checked when doing other work under the bonnet. The brake system should also be checked for leakage at the same time.

If the fluid level falls markedly in a short length of time, it indicates leaks from the brake system.

If this occurs, we recommend you to have the vehicle checked.

## Fluid type

Use brake fluid conforming to DOT3 or DOT4 from a sealed container. The brake fluid is hygroscopic. Too much moisture in the brake fluid will adversely affect the brake system, reducing the performance.

## CAUTION

- Take care in handling brake fluid as it is harmful to the eyes, may irritate your skin and also damage painted surfaces.
- Use only the specified brake fluid. Do not mix or add different brands of brake fluid to prevent chemical reactions. Do not let any petroleum-based fluid touch, mix with, or get into the brake fluid. This will damage the seals.
- Keep the reservoir tank cap closed to prevent the brake fluid from deteriorating except maintenance.
- Clean the filler cap before removing and close the cap securely after maintenance.

## Power steering fluid

E01001100631

### To check the fluid level

Check the fluid level in the reservoir while the engine is idling. Check to make certain that the power steering fluid level is always between the “MAX” and “MIN” level markings on the fluid reservoir and top up the fluid, if necessary.

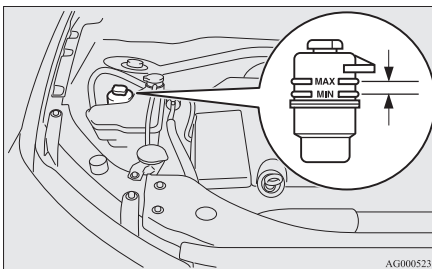

### Fluid type

Use “Genuine MITSUBISHI Power Steering Fluid” or “ATF DEXRON III/DEXRON II”.

## Battery

E01001201886

The condition of the battery is very important for quick starting and to keep the vehicle’s electrical system working properly. Regular inspection and care are especially important in cold weather.

### NOTE

- After replacing the battery, the electronic control system data for the automatic transmission, etc., will be erased. As a result, shift shocks may occur. Shift shocks will become smoother after several changes in speed.

### Checking battery electrolyte level

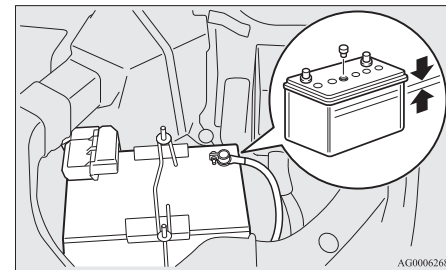

The electrolyte level must be between the specified limit on the outside of the battery. Replenish with distilled water as necessary.

The inside of the battery is divided into several compartments; remove the cap from each compartment and fill to the upper mark. Do not top up beyond the upper mark because spillage during driving could cause damage.

## Maintenance

Check the electrolyte level at least once every 4 weeks, depending on the operating conditions. If the battery is not used, it will discharge by itself with time.

Check it once every 4 weeks and charge with low current as necessary.

## During cold weather

The capacity of the battery is reduced at low temperatures. This is an inevitable result of its chemical and physical properties. This is why a very cold battery, particularly one that is not fully charged, will only deliver a fraction of the starter current which is normally available.

We recommend you to have the battery checked before the start of cold weather and, if necessary, have it charged or replaced.

This does not only ensure reliable starting, but a battery which is kept fully charged also has a longer life.

## Disconnection and connection

To disconnect the battery cable, stop the engine, first disconnect the negative (-) terminal and then the positive (+) terminal. When connecting the battery, first connect the positive (+) terminal and then the negative (-) terminal.

### NOTE

- Open the terminal cover (A) before disconnecting or connecting the positive (+) terminal of the battery.
- Loosen the nut (B), and then disconnect the battery cable from the positive (+) terminal.

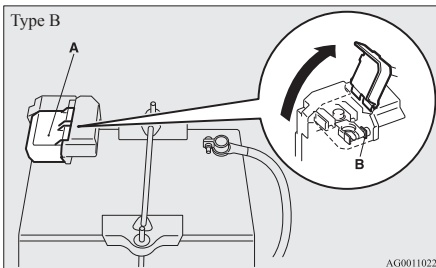
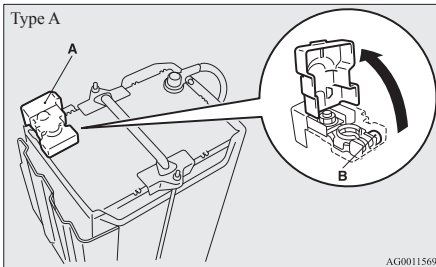

## ⚠ WARNING

- Keep sparks, cigarettes, and flames away from the battery because the battery could explode.

## ⚠ WARNING

- The battery electrolyte is extremely caustic. Do not allow it to come in contact with your eyes, skin, clothing, or the painted surfaces of the vehicle. Spilt electrolyte should be flushed immediately with ample amounts of water. Irritation to eyes or skin from contact with electrolyte requires immediate medical attention.
- Ventilate when charging or using the battery in an enclosed space.

## ⚠ CAUTION

- Keep it out of reach of children.
- Never disconnect the battery when the ignition switch is in the "ON" position. Doing so could damage electric components.
- Never short-circuit the battery. This could cause it to overheat and be damaged.
- If the battery is to be quick-charged, first disconnect the battery cables.
- In order to prevent a short circuit, be sure to disconnect the negative (-) terminal first.
- Always wear protective eye goggles when working near the battery.



 **CAUTION**

- Do not bring the nearby parts, the plastic parts and so on into contact with sulphuric acid (battery electrolyte) which may crack, stain or discolour them. If they are in contact, wipe off with soft cloth, chamois or the like and an aqueous solution of neutral detergent then immediately rinse the affected parts with plenty of water.

## NOTE

- Keep the terminals clean. After the battery is connected, apply terminal protection grease. To clean the terminals, use lukewarm water.
- Check to see if the battery is securely installed and cannot be moved during travel. Also check each terminal for tightness.
- When the vehicle is to be left unused for a long period of time, remove the battery and store it in a place where the battery fluid will not freeze. The battery should be stored only in a fully charged condition.

*Tyres*

E01001300255

 **WARNING**

- Driving with tyres that are worn, damaged or improperly inflated can lead to a loss of control or blow out of the tyres which can result in a collision with serious or fatal injury.

## Tyre inflation pressures

E01001402319

Item	Tyre size	Up to 5 passengers		Up to max. load		At trailer towing	
		Front	Rear	Front	Rear	Front	Rear
Normal tyre	215/70R16 100H	2.2 bar (32 psi) [220 kPa] 2.5 bar (36 psi) [250 kPa]*				2.2 bar (32 psi) [220 kPa]	2.3 bar (33 psi) [230 kPa]
	225/55R18 98V P225/55R18 97H	2.2 bar (32 psi) [220 kPa] 2.5 bar (36 psi) [250 kPa]*				2.2 bar (32 psi) [220 kPa]	2.4 bar (35 psi) [240 kPa]
Temporary spare tyre	T155/90D16 110M	4.2 bar (60 psi) [420 kPa]				—	
	215/70R16 100H	2.2 bar (32 psi) [220 kPa]				—	

\*: Above 160 km/h (99 mph)

Check the tyre inflation pressure of all the tyres while they are cold; if insufficient or excessive, adjust to the specified value. After the tyre inflation pressure has been adjusted, check the tyres for damage and air leaks. Be sure to put caps on the valves.

## Wheel condition

E01001800931

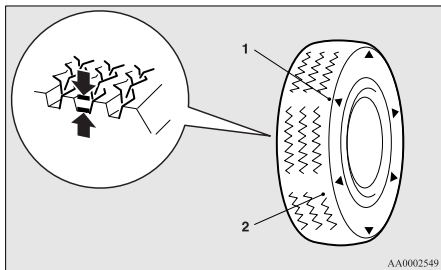

- 1- Location of the tread wear indicator  
2- Tread wear indicator

Check the tyres for cuts, cracks and other damage. Replace the tyres if there are deep cuts or cracks. Also check each tyre for pieces of metal or pebbles. The use of worn tyres can be very dangerous because of the greater chance of skidding or hydroplaning. The tread depth of the tyres must exceed 1.6 mm in order for the tyres to meet the minimum requirement for use.

Tread wear indicators will appear on the surface of the tyre as the tyre wears, thereby indicating that the tyre no longer meets the minimum requirement for use. When these wear indicators appear, the tyres must be replaced with new ones.

On 4-wheel drive vehicles, when replacement of any of the tyres is necessary, replace all of them.

## CAUTION

- Always use tyres of the same size, same type, and same brand, and which have no wear differences. Using tyres of different size, type, brands or degree of wear, will increase the differential oil temperature, resulting in possible damage to the driving system. Further, the drive train will be subjected to excessive loading, possibly leading to oil leakage, component seizure, or other serious faults.

## Replacing tyres and wheels

E01007200243

## CAUTION

- Avoid using different size tyres from the one listed and the combined use of different types of tyres, as this can affect driving safety. Refer to “Tyres and wheels” on page 9-17.
- Even if a wheel has the same rim size and offset as the specified type of wheel, its shape may prevent it from being fitted correctly. We recommend you to consult a specialist before using wheels that you have.

## Tyre rotation

E01001901317

Tyre wear varies with vehicle conditions, road surface conditions and individual driver's driving habits. To equalize the wear and help extend tyre life, it is recommended to rotate the tyres immediately after discovery of abnormal wear, or whenever the wear difference between the front and rear tyres is recognizable.

When rotating tyres, check for uneven wear and damage. Abnormal wear is usually caused by incorrect tyre pressure, improper wheel alignment, out of balance wheel, or severe braking. We recommend you to have it checked to determine the cause of irregular tread wear.

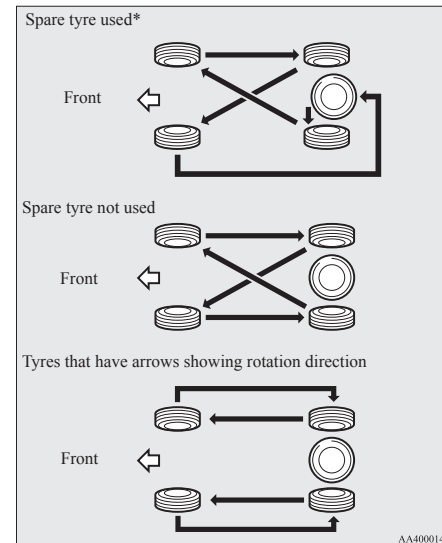

AA4000149

## Maintenance

- \*: If the spare tyre wheel differs from the standard tyre wheel, do not perform tyre rotation using a spare wheel.

### **A CAUTION**

- A temporary spare tyre can be fitted temporarily in place of a tyre that has been removed during the tyre rotation. However, it must not be included in the regular tyre rotation sequence.
- If the tyres have arrows (A) indicating the correct direction of rotation, swap the front and rear tyres on the left-hand side of the vehicle and the front and rear tyres on the right-hand side of the vehicle separately. Keep each tyre on its original side of the vehicle. When fitting the tyres, make sure the arrows point in the direction in which the wheels will turn when the vehicle moves forward. Any tyre whose arrow points in the wrong direction will not perform to its full potential.

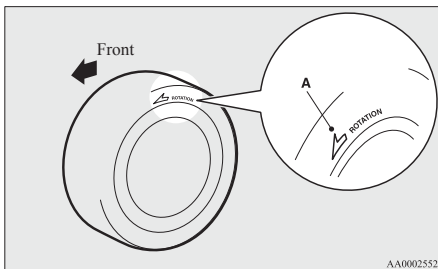

### **A CAUTION**

- Avoid the combined use of different types of tyres. Using different types of tyres can affect vehicle performance and safety.

## Snow tyres

E01002000754

The use of snow tyres is recommended for driving on snow and ice. To preserve driving stability, mount snow tyres of the same size and tread pattern on all 4 wheels.

A snow tyre that is worn down more than 50% is no longer appropriate to use.

Snow tyres which do not meet specifications must not be used.

### **A CAUTION**

- Observe permissible maximum speed for your snow tyres and the legal speed limit.

## NOTE

- The laws and regulations concerning snow tyres (driving speed, required use, type, etc.) vary. Find out and follow the laws and regulations in the area you intend to drive.
- If flange nuts are used on your vehicle, change to tapered nuts when steel wheels are used.

## Tyre chains

E01002101781

If tyre chains have to be used, ensure that they are fitted only on the drive wheels (front) in accordance with the manufacturer's instructions.

On 4WD vehicles in which the driving power is distributed preferentially to the front wheels, ensure that the tyre chains are fitted on the front.

Use only tyre chains which are designed for use with the tyres mounted on the vehicle: use of the incorrect size or type of chain could result in damage to the vehicle body.

Contact a MITSUBISHI MOTORS Authorized Service Point before putting on tyre chains. The max. chain height is as follows.

Tyre size	Wheel size	Max. chain height [mm]
225/55R18 P225/55R18	18x7 J	9 mm
215/70R16	16 x 6 1/2 JJ	

When driving with tyre chains on the tyres, do not drive faster than 50 km/h (30 mph). When you reach roads that are not covered in snow, immediately remove the tyre chains.

### **A CAUTION**

- Practice fitting the chains before you need them. Don't expect help from other people in the cold.
- Choose a clear straight stretch of road where you can pull over and still be seen while you are fitting the chains.
- Do not fit chains before you need them. This will wear out your tyres and the road surface.
- After driving around 100-300 metres, stop and retighten the chains.

## **⚠ CAUTION**

- Drive carefully and do not exceed 50 km/h (30 mph). Remember that preventing accidents is not the purpose of tyre chains.
- When tyre chains are installed, take care that they do not damage the disc wheel or body.
- Do not install a tyre chain on an emergency wheel which is compact in size. If one of the front wheels has punctured, replace it with one of the rear wheels and install the temporary spare wheel in that place before fitting a tyre chain.
- An aluminium wheel can be damaged by a tyre chain while driving. When fitting a tyre chain on an aluminium wheel, take care that any part of the chain and fitting cannot be brought into contact with the wheel.
- Remove the wheel covers before installing a tyre chain, otherwise they may be damaged by the tyre chain. (See page 6-18.)
- When installing or removing the tyre chains, take care that hands and other parts of your body are not injured by the sharp edges of the vehicle body.

### NOTE

- The laws and regulations concerning the use of tyre chains vary. Always follow local laws and regulations.  
In most countries, it is prohibited by law to use tyre chains on roads without snow.

## **Parking brake break-in**

E01008300182

Break-in the parking brake linings whenever the brake performance of the parking brake is insufficient or whenever the parking brake linings and/or discs are replaced, in order to assure the best brake performance.

This procedure is described in the vehicle service manual and can be carried out by a MITSUBISHI MOTORS Authorized Service Point.

## **Wiper blade rubber replacement**

E01002600327

### **Windscreen wiper blades**

1. Lift the wiper arm off the windscreen.
2. Pull the wiper blade until its stopper (A) disengages from the hook (B). Pull the wiper blade further to remove it.

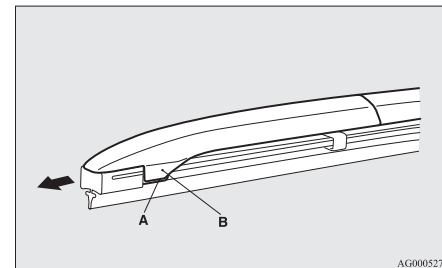

AG0005274

### NOTE

- Do not let the wiper arm drop onto the windscreen. This could damage the glass.
3. Attach the retainers (C) to a new wiper blade. Refer to the illustration to ensure that

## Maintenance

the retainers are correctly aligned as you attach them.

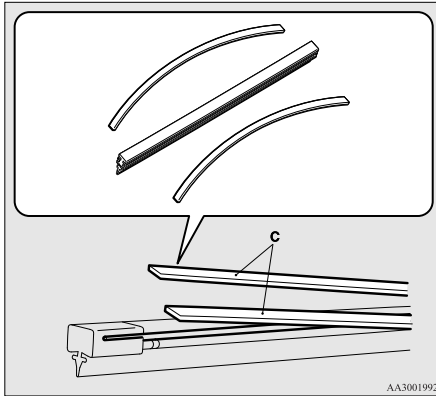

4. Insert the wiper blade into the arm, starting with the opposite end of the blade from the stopper. Make sure the hook (B) is fitted correctly in the grooves in the blade.

### NOTE

- If a retainer is not supplied with the new wiper blade, use the retainer from the old blade.

5. Push the wiper blade until the hook (B) engages securely with the stopper (A).

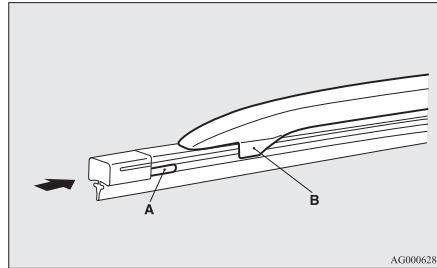

### Rear window wiper blades

1. Lift the wiper arm off the window glass.
2. Pull the wiper blade downward to disengage it from the stopper (A) at the end of the wiper arm. Pull the wiper blade further to remove it.
3. Slide a new wiper blade through the hook (B) on the wiper arm.

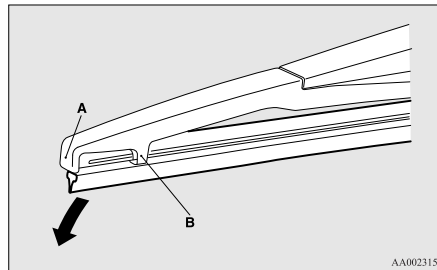

### NOTE

- Do not allow the wiper arm to fall onto the window glass; it could damage the glass.

4. Firmly insert the retainer (C) into the groove (D) in the wiper blade. Refer to the illustration to ensure that the retainers are correctly aligned as you insert them into the groove.

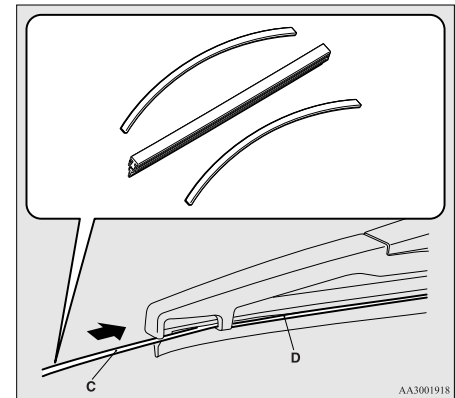

### NOTE

- If a retainer is not supplied with the new wiper blade, use the retainer from the old blade.

## General maintenance

E01002700344

### Fuel, engine coolant, oil and exhaust gas leakage

Look under the body of your vehicle to check for fuel, engine coolant, oil and exhaust gas leaks.

### **WARNING**

- If you see a suspicious fuel leak or if you smell fuel, do not operate the vehicle and call your MITSUBISHI MOTORS Authorized Service Point for assistance.

### Exterior and interior lamp operation

Operate the combination lamp switch to check that all lamps are functioning properly.

If the lamps do not illuminate, the probable cause is a blown fuse or defective lamp bulb. Check the fuses first. If there is no blown fuse, check the lamp bulbs.

For information regarding the inspection and replacement of the fuses and the bulbs, refer to “Fuses” on page 8-18 and “Replacement of lamp bulbs” on page 8-23.

If the fuses and bulbs are all OK, we recommend you to have your vehicle checked and repaired.

### Meter, gauge and indicator/warning lamps operation

Start the engine and check the operation of all instruments, gauges and indication and warning lamps. If there is anything wrong, we recommend you to have your vehicle inspected.

### Hinges and latches lubrication

Check all latches and hinges, and, if necessary, have them lubricated.

### For cold and snowy weather

E01002800361

### Ventilation slots

The ventilation slots in front of the windscreen should be kept clear of leaves or brushed clear after heavy snowfall, so that the operation of the heating and ventilation systems will not be impaired.

### Weatherstripping

To prevent freezing of the weatherstripping on the doors, bonnet, etc., they should be treated with silicone grease.

### Additional equipment

It is a good idea to carry a shovel or a short-handled spade in the vehicle during the winter so that you can clear away snow if you get stranded. A small hand-brush for sweeping snow off the vehicle and a plastic scraper for the windscreen and rear window are also useful.

## Fusible links

E01002900564

The fusible links will melt to prevent a fire if a large current attempts to flow through certain electrical systems.

In case of a melted fusible link, we recommend you to have your vehicle inspected.

For the fusible links, please refer to “Fuse load capacity” on page 8-20.

### **⚠ WARNING**

- **Fusible links must not be replaced by any other device. Failing to fit the correct fusible link may result in fire in the vehicle, property destruction and serious or fatal injuries at any time.**

## Fuses

E01003002090

### Fuse block location

To prevent damage to the electrical system due to shortcircuiting or overloading, each individual circuit is provided with a fuse.

There are fuse blocks in the passenger compartment and in the engine compartment.

#### *Passenger compartment (LHD vehicles)*

The fuse blocks in the passenger compartment are located behind the personal box in front of the driver's seat at the position shown in the illustration.

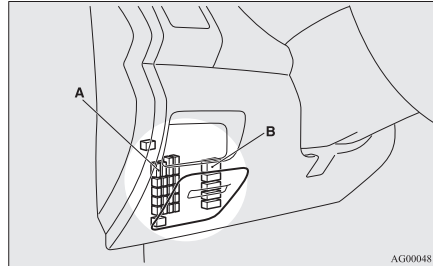

A- Main fuse block  
B- Sub fuse block

1. Open the personal box and pull to remove it.

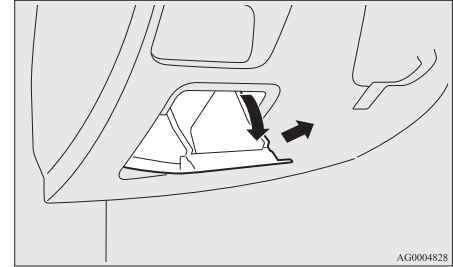

2. To put back the personal box, line up the personal box hook (C) with the clamp (D) on the instrument panel and push the box back in.

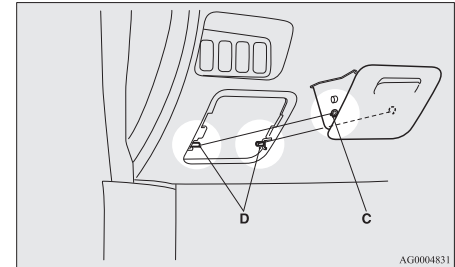



**Passenger compartment (RHD vehicles)**

The fuse blocks in the passenger compartment are located behind the lower glove box at the position shown in the illustration.

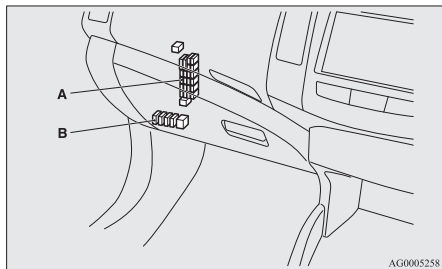

A- Main fuse block  
B- Sub fuse block

**Main fuse block**

1. Open the lower glove box.

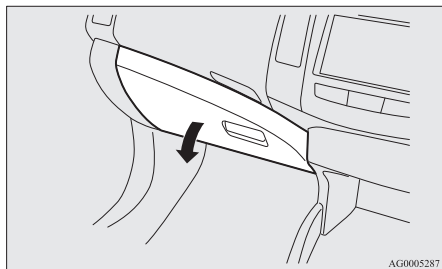

2. Move the rod (A) on the left side of the lower glove box to the left side of the box.

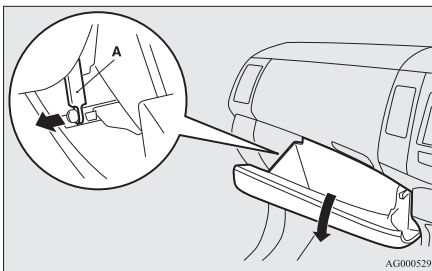

3. While pressing the side of the lower glove box, unhook the left and right hooks (B) and lower the lower glove box.

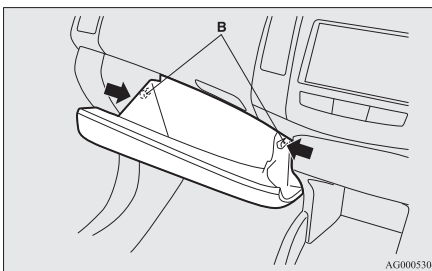

4. Remove the lower glove box fastener, and then remove the lower glove box.

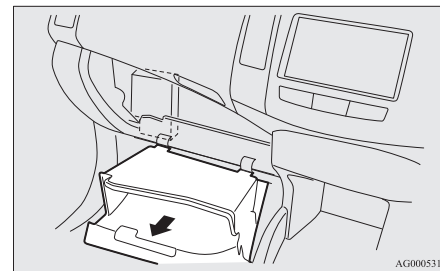

**Sub fuse block**

1. Remove the cover from the bottom of the glove box.

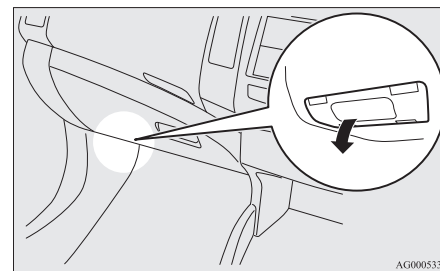

## Maintenance

### Engine compartment

In the engine compartment, the fuse block is located as shown in the illustration.

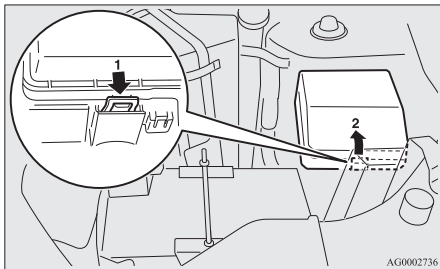

- 1- Push the knob.
- 2- Remove the cover.

### Fuse load capacity

E01007700596

The fuse capacity and the names of electrical systems protected by the fuses are indicated on the inside of the personal box (LHD vehicles), the inside of the lower glove box (RHD vehicles) and inside of the fuse block cover (inside of the engine compartment).

### Passenger compartment fuse location table

#### NOTE

- Spare fuses are provided on the lid of the fuse block in the engine compartment. Always use a fuse of the same capacity for replacement.

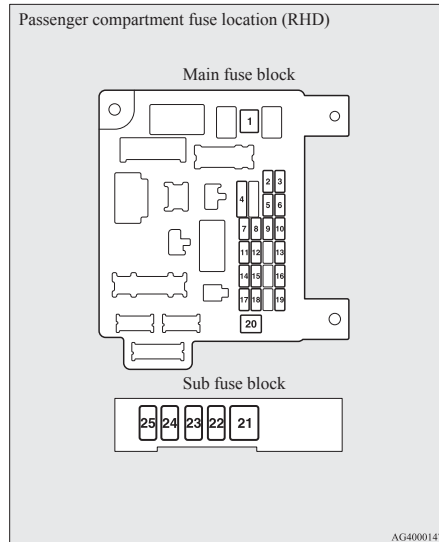
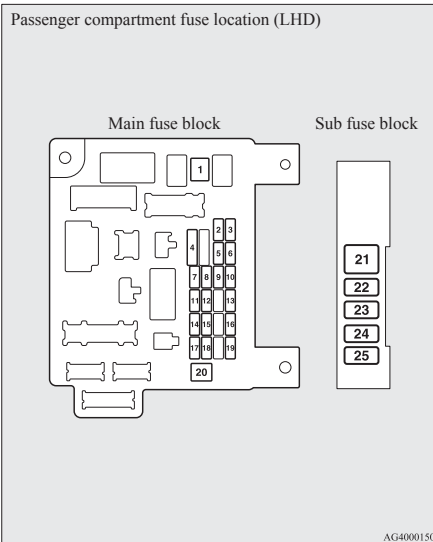

No.	Symbol	Electrical system	Capacities
1		Heater	30 A*
2	STOP	Stop lamps (Brake lamps)	15 A
3		Rear fog lamp	10 A
4		Windscreen wipers	30 A
5		Option	10 A

\*: Fusible link

No.	Symbol	Electrical system	Capacities
6		Door locks	20 A
7		Radio	15 A
8		Control unit relay	7.5 A
9		Interior lamps (Room lamps)	15 A
10		Hazard warning flasher	15 A
11		Rear window wiper	15 A
12		Instruments	7.5 A
13		Cigarette lighter/Accessory socket	15 A
14		Ignition switch	10 A
15		Sunroof	20 A
16		Outside rear-view mirrors	10 A
17		4-wheel drive system	10 A
18		Reversing lamps (Backup lamps)	7.5 A
19		Accessory socket	15 A
20		Electric window control	30 A*
21		Rear window demister	30 A*

\*: Fusible link

No.	Symbol	Electrical system	Capacities
22		Heated door mirror	7.5 A
23		AC power supply	15 A
24		Power seats	25 (20) A
25		Heated seat	30 A

\*: Fusible link

- Some fuses may not be installed on your vehicle, depending on the vehicle model or specifications.
- The table above shows the main equipment corresponding to each fuse.

Engine compartment fuse location table

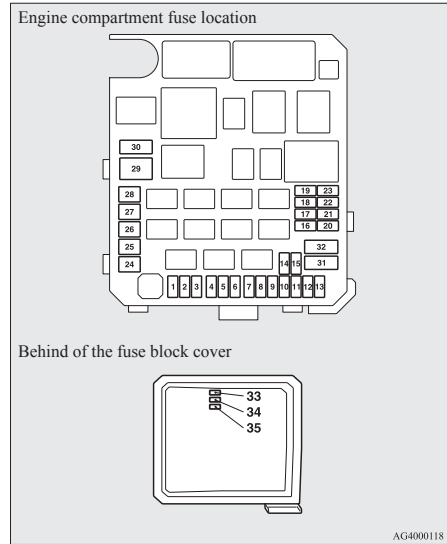

No.	Symbol	Electrical system	Capacities
1		Front fog lamps	15 A
2		Engine	7.5 A
3		Automatic transmission	20 A
4		Horn	10 A

\*: Fusible link

## Maintenance

No.	Symbol	Electrical system	Capacities
5		Alternator	7.5 A
6		Headlamp washer	20 A
7		Air conditioning	10 A
8		ETV/Oil cooler fan (Twin Clutch SST)	15 A
9		Security horn	20 A
10		Wiper de-icer	15 A
11	—	—	—
12		Electric tailgate	30 A
13		Daytime running lamps	10 A
14		Headlamp high-beam (left)	10 A
15		Headlamp high-beam (right)	10 A
16		Headlamp low beam (left)	Discharge 20 A
17		Headlamp low beam (right)	Discharge 20 A
18		Headlamp low beam (left)	Halogen 10 A

\*: Fusible link

No.	Symbol	Electrical system	Capacities
19		Headlamp low beam (right)	Halogen 10 A
20		ENG/POWER	10 A
21		Ignition coil	10 A
22		ENG/POWER	20 A
		Fuel line heater	25 A
23		Fuel pump	15 A
24		Starter	30 A *
25	—	—	—
26		Anti-lock brake system	40 A *
27		Anti-lock brake system	30 A *
28		Air conditioning condenser fan motor	30 A *
29		Radiator fan motor	40 A *
30		IOD	30 A
31		Audio system amp	30 A
32		Diesel	30 A
33	—	Spare fuse	10 A
34	—	Spare fuse	15 A
35	—	Spare fuse	20 A

\*: Fusible link

- Some fuses may not be installed on your vehicle, depending on the vehicle model or specifications.
- The table above shows the main equipment corresponding to each fuse.

The fuse box does not contain spare 7.5 A, 25 A or 30 A fuses. If one of these fuses burns out, substitute with the following fuse.

**7.5 A: 10 A spare fuse**

**25 A: 20 A spare fuse**

**30 A: 30 A audio system amp fuse**

When using a substitute fuse, replace with a fuse of the correct capacity as soon as possible.

### Identification of fuse

Capacity	Colour
7.5 A	Brown
10 A	Red
15 A	Blue
20 A	Yellow
25 A	Natural (White)
30 A	Green (fuse type)/ Pink (fusible link type)
40 A	Green (fusible link type)

### Fuse replacement

E01007800470

1. Before replacing a fuse, always turn off the electrical circuit concerned and place the ignition switch in the "LOCK" position.

- Remove the fuse puller (A) from the inside of the fuse box in the engine compartment.

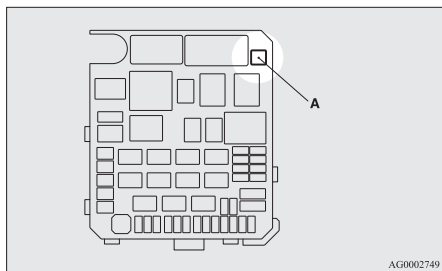

- Referring to the fuse load capacity table, check the fuse pertaining to the problem.

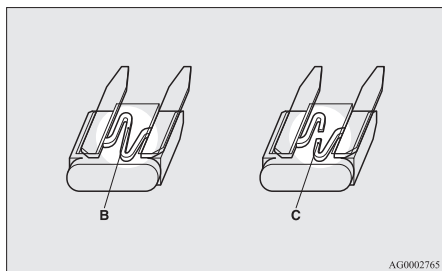

B- Fuse is OK  
C- Blown fuse

## NOTE

- If any system does not function but the fuse corresponding to that system is normal, there may be a fault in the system elsewhere. We recommend you to have your vehicle checked.
- Use the fuse puller to insert a new fuse with the same capacity. Make sure you insert the fuse into the same location in the fuse block.

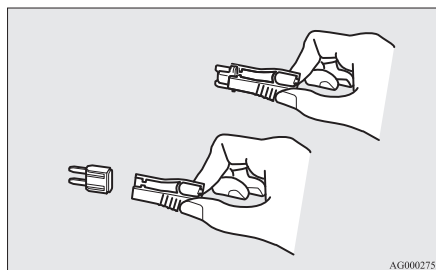

### ⚠ CAUTION

- If the newly inserted fuse blows again after a short time, we recommend you to have the electrical system checked to find the cause and rectify it.
- Never use a fuse with a larger capacity than specified or a substitute (such as a cable or foil). Doing so could cause the circuit wires to overheat and create a fire.

## Replacement of lamp bulbs

E01003100488

Before replacing a bulb, ensure the lamp is off. Do not touch the glass part of the new bulb with your bare fingers; the skin oil left on the glass will evaporate when the bulb gets hot and the vapour will condense on the reflector and dim the surface.

### ⚠ CAUTION

- Bulbs are extremely hot immediately after being turned off. When replacing a bulb, wait for it to cool sufficiently before touching it. You could otherwise be burnt.

## NOTE

- If you are unsure of how to carry out the work as required, we recommend you to consult a specialist.
- Be careful not to scratch the vehicle body when removing a lamp or lens.
- When it rains or when the vehicle has been washed, the inside of the lens sometimes becomes foggy. This is the same phenomenon as when window glass mists up on a humid day, and does not indicate a functional problem. When the lamp is switched on, the heat will remove the fog. However, if water gathers inside the lamp, we recommend you to have the lamp checked.

## Bulb capacity

E01003200258

When replacing a bulb, use a new bulb with the same wattage and colour.

## Maintenance

### Outside

E01003302602

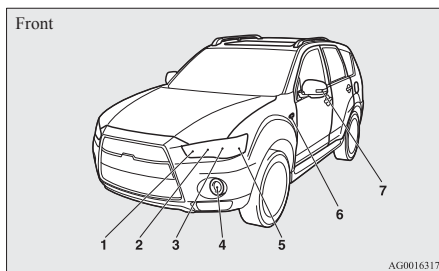

#### Except for vehicles equipped with high intensity discharge headlamps

- 1- Front turn-signal lamps: 21 W (WY21W)
- 2- Headlamps, high-beam: 60 W (HB3)
- 3- Headlamps, low beam: 51 W (HB4)
- 4- Front fog lamps\*1: 55 W (H11)
- 5- Position lamps: 5 W (W5W)
- 6- Side turn-signal lamps (on fender)\*1\*2: 5 W
- 7- Side turn-signal lamps (on outside rear-view mirror)\*1\*2

#### Vehicles equipped with high intensity discharge headlamps

- 1- Front turn-signal lamps: 21 W (WY21W)
- 2- Bending lamps (Adaptive Front lighting System (AFS)): 55 W (H11)
- 3- Headlamps, high/low beam (Discharge bulb)\*2: 35 W
- 4- Front fog lamps\*1: 55 W (H11)
- 5- Position lamps: 5 W (W5W)
- 6- Side turn-signal lamps (on fender)\*1\*2: 5 W
- 7- Side turn-signal lamps (on outside rear-view mirror)\*1\*2

\*1: if so equipped

\*2: Have the lamps bulbs replaced at a MITSUBISHI MOTORS Authorized Service Point.

Codes in parentheses indicate bulb types.

### **⚠ WARNING**

- Always consult a specialist when repairing or replacing the bulbs of high intensity discharge headlamps. This is because the power circuit, bulbs and electrodes generate a high voltage that could cause an electric shock.

#### NOTE

- An LED, not a bulb, is used in the side turn-signal lamp (on outside rear-view mirror). Contact a MITSUBISHI MOTORS Authorized Service Point when there is a need for repair or replacement.
- For the side turn-signal lamp (on fender), it is not possible to repair or replace just the bulb. Contact a MITSUBISHI MOTORS Authorized Service Point when there is a need for repair or replacement.

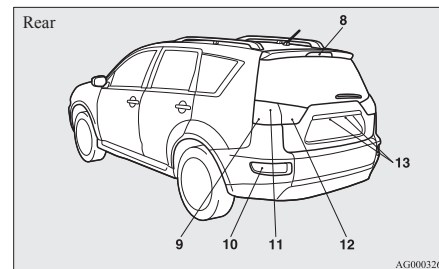

- 8- High-mounted stop lamp
  - 9- Rear turn-signal lamps: 21 W (WY21W)
  - 10- Rear fog lamp (driver's side): 21 W (W21W)
  - 11- Stop lamps/Tail lamps
  - 12- Reversing lamps: 21 W (W21W)
  - 13- Licence plate lamps: 5 W (W5W)
- Codes in parentheses indicate bulb types.

#### NOTE

- An LED, not a bulb, is used in the stop lamp/tail lamp and high-mounted stop lamp. Contact a MITSUBISHI MOTORS Authorized Service Point when there is a need for repair or replacement.

Inside

E01003401811

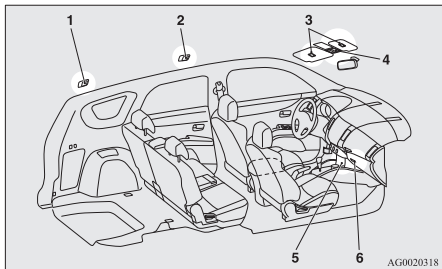

- 1- Luggage room lamp: 8 W
- 2- Room lamp (rear): 8 W
- 3- Vanity mirror lamps: 3 W
- 4- Map & room lamps (front): 8 W
- 5- Centre console down lamp
- 6- Glove box lamp: 1.4 W

NOTE

- An LED, not a bulb, is used in the centre console down lamp. Contact a MITSUBISHI MOTORS Authorized Service Point when there is a need for repair or replacement.

Headlamps (low beam, except for vehicles with high intensity discharge headlamps)

E01009300192

1. When replacing the bulb on the left side of the vehicle in the case of 2200 models and 3000 models, remove the bolt (A) holding down the relay box and move the relay box towards the rear of the vehicle.

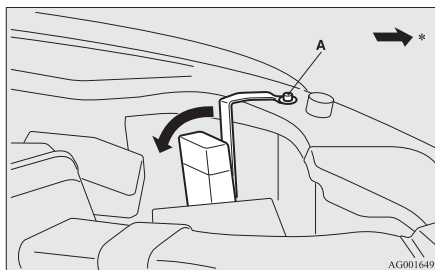

\*: Front of the vehicle

2. When replacing the bulb on the right side of the vehicle in the case of diesel-powered vehicles equipped with M/T, remove the bolts (B) holding down the reservoir tank and move the reservoir tank.

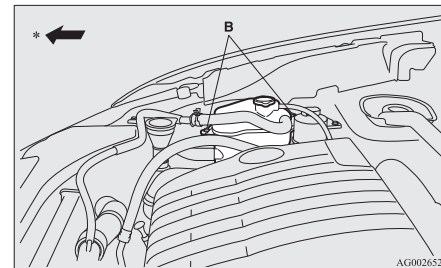

\*: Front of the vehicle

3. Turn the bulb (C) anticlockwise and remove it.

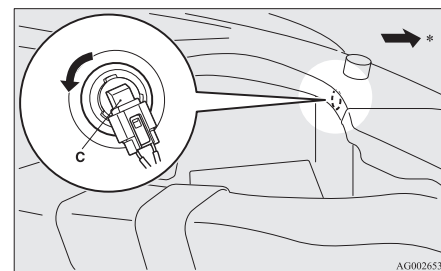

\*: Front of the vehicle

## Maintenance

4. While holding down the tab (D), pull out the socket (E).

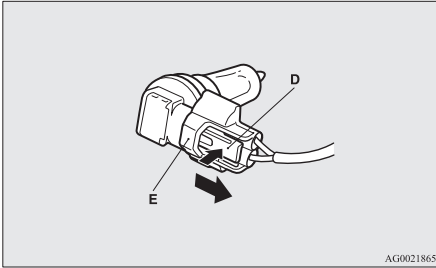

5. To install the bulb, perform the removal steps in reverse.

### **⚠ CAUTION**

- Handle halogen lamp bulbs with care. The gas inside halogen lamp bulbs is highly pressurized, so dropping, knocking, or scratching a halogen lamp bulb can cause it to shatter.
- Never hold the halogen lamp bulb with a bare hand, dirty glove, etc. The oil from your hand could cause the bulb to break the next time the headlamps are operated. If the glass surface is dirty, it must be cleaned with alcohol, paint thinner, etc., and refit it after drying thoroughly.

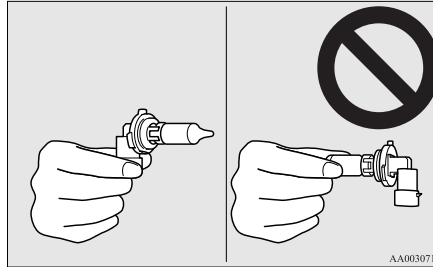

### Headlamps (high-beam, except for vehicles with high intensity discharge headlamps)

E01009400148

1. When replacing the bulb on the right side of the vehicle in the case of diesel-powered vehicles equipped with M/T, remove the bolt (A) holding down the washer tank spout and move the spout towards the rear of the vehicle.

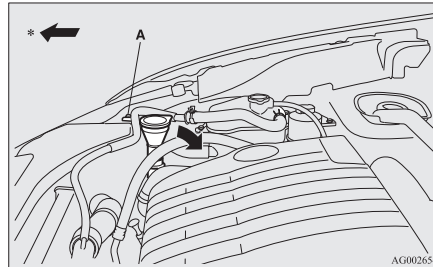

\*: Front of the vehicle

2. Turn the cap (B) anticlockwise to remove it.

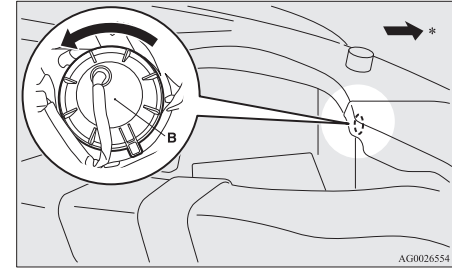

\*: Front of the vehicle

3. Turn the bulb (C) anticlockwise to remove it.

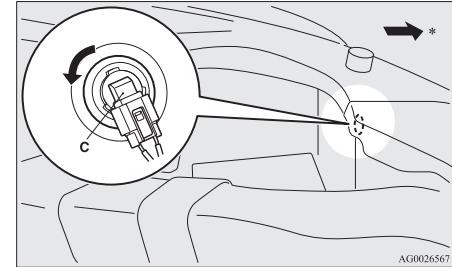

\*: Front of the vehicle



4. While holding down the tab (D), pull out the socket (E).

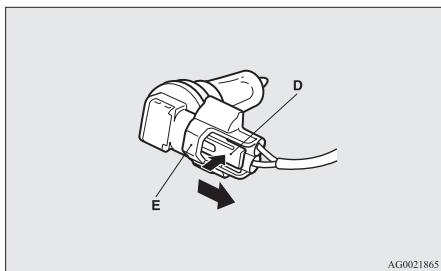

5. To install the bulb, perform the removal steps in reverse.

### **⚠ CAUTION**

- Handle halogen lamp bulbs with care. The gas inside halogen lamp bulbs is highly pressurized, so dropping, knocking, or scratching a halogen lamp bulb can cause it to shatter.
- Never hold the halogen lamp bulb with a bare hand, dirty glove, etc. The oil from your hand could cause the bulb to break the next time the headlamps are operated. If the glass surface is dirty, it must be cleaned with alcohol, paint thinner, etc., and refit it after drying thoroughly.

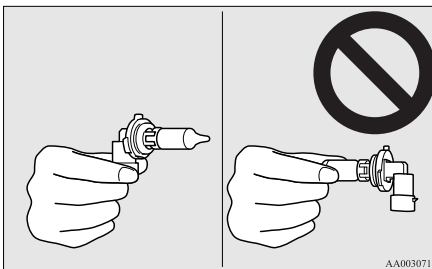

### Headlamps (high/low beam, for vehicles with high intensity discharge headlamps)

E01010100073

### **⚠ WARNING**

- Always consult a specialist when replacing the bulbs of high intensity discharge headlamps. This is because the power circuit, bulbs and electrodes generate a high voltage that could cause an electric shock.

### Bending lamps (Adaptive Front lighting System (AFS)) (for vehicles equipped with high intensity discharge headlamps)

E01008800190

1. When replacing the bulb on the right side of the vehicle in the case of diesel-powered vehicles equipped with M/T, remove the bolt (A) holding down the washer tank spout and move the spout towards the rear of the vehicle.

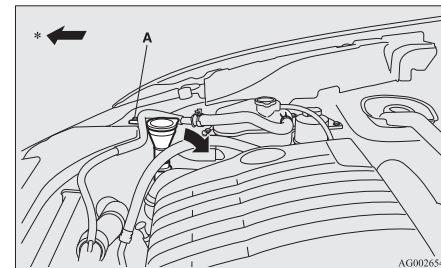

\*: Front of the vehicle

## Maintenance

2. Turn the cap (B) anticlockwise to remove it.

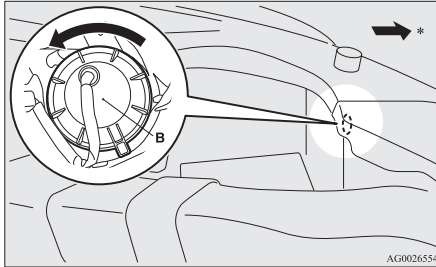

\*: Front of the vehicle

3. Turn the bulb (C) anticlockwise to remove it.

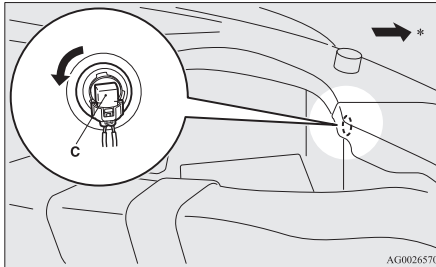

\*: Front of the vehicle

4. While holding down the tab (D), pull out the bulb (E).

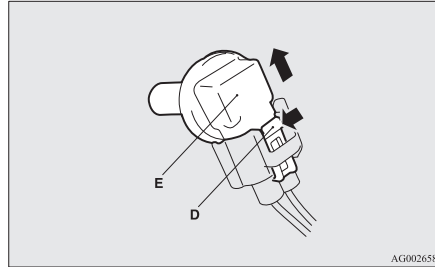

5. To install the bulb, perform the removal steps in reverse.

### **⚠ CAUTION**

- Handle halogen lamp bulbs with care. The gas inside halogen lamp bulbs is highly pressurized, so dropping, knocking, or scratching a halogen lamp bulb can cause it to shatter.
- Never hold the halogen lamp bulb with a bare hand, dirty glove, etc. The oil from your hand could cause the bulb to break the next time the bending lamps (Adaptive Front lighting System (AFS)) are operated. If the glass surface is dirty, it must be cleaned with alcohol, paint thinner, etc., and refit it after drying it thoroughly.

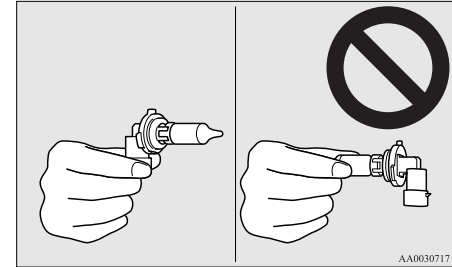

## Position lamps

E01003700976

1. When replacing the bulb on the left side of the vehicle in the case of 2200 models and 3000 models, remove the bolt (A) holding down the relay box and move the relay box towards the rear of the vehicle.

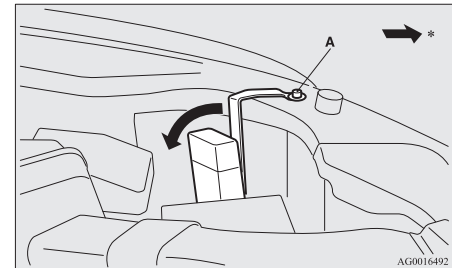

\*: Front of the vehicle

- When replacing the bulb on the right side of the vehicle in the case of diesel-powered vehicles equipped with M/T, remove the bolts (B) holding down the reservoir tank and move the reservoir tank.

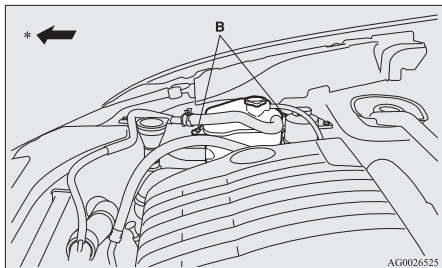

\*: Front of the vehicle

- Turn the socket (C) anticlockwise to remove it.

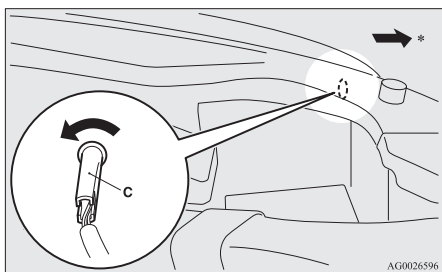

\*: Front of the vehicle

- Remove the bulb from the socket.

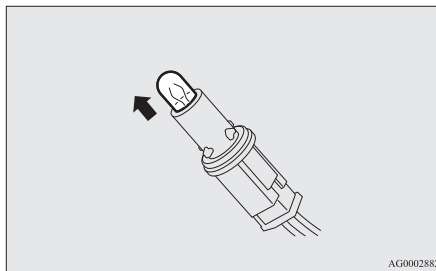

- To install the bulb, perform the removal steps in reverse.

### Front turn-signal lamps

E01003800977

- When replacing the bulb on the right side of the vehicle, remove the bolt (A) holding down the washer tank spout and move the spout towards the rear of the vehicle.

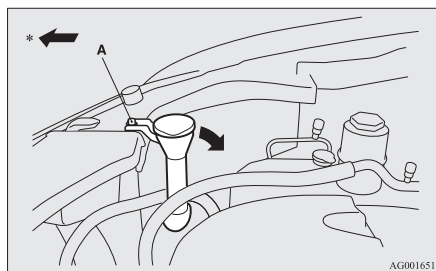

\*: Front of the vehicle

- Turn the socket (A) anticlockwise and remove it.

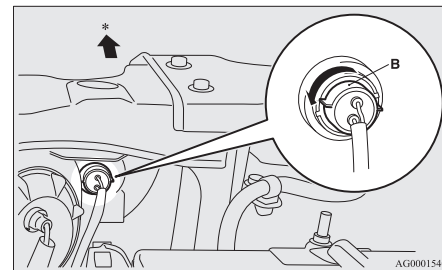

\*: Front of the vehicle

- Remove the bulb from the socket.

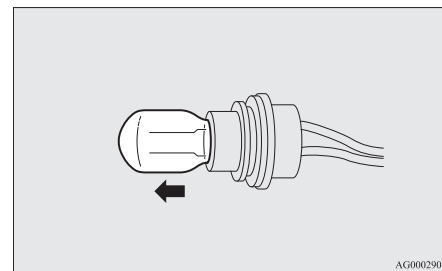

- To install the bulb, perform the removal steps in reverse.

### Side turn-signal lamps (on fender)\*

E01003900428

For the side turn-signal lamps (on fender), it is not possible to repair or replace just the bulb.

## Maintenance

Contact a MITSUBISHI MOTORS Authorized Service Point when there is a need for repair or replacement.

### Side turn-signal lamps (on outside rear-view mirror)\*

E01003900431

#### NOTE

- An LED, not a bulb, is used in the side turn-signal lamps (on outside rear-view mirror). Contact a MITSUBISHI MOTORS Authorized Service Point when there is a need for repair or replacement.

### Front fog lamps\*

E01004001393

1. Turn the bezel (A) anticlockwise to remove it.

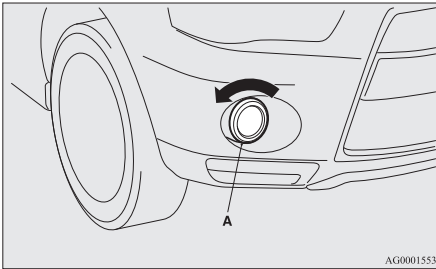

2. Remove the 3 screws (B) and remove the lamp unit.

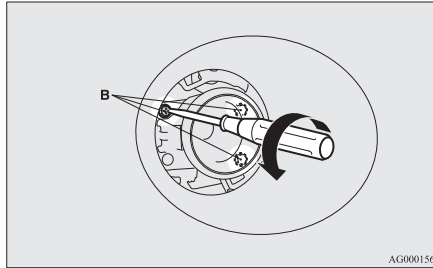

#### NOTE

- When unfastening the screws, be careful not to mistakenly move the beam position adjustment screw (C).

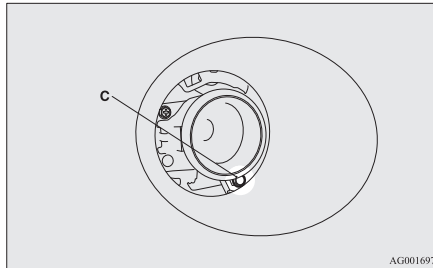

3. While holding down the tab (D), pull out the socket (E).

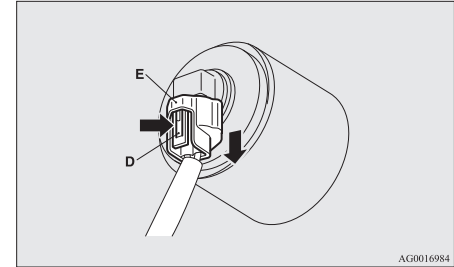

4. Turn the bulb (F) anticlockwise to remove it.

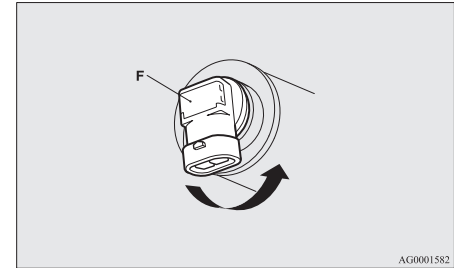

5. To install the bulb, perform the removal steps in reverse.

## **⚠ CAUTION**

- Handle halogen lamp bulbs with care. The gas inside halogen lamp bulbs is highly pressurized, so dropping, knocking, or scratching a halogen lamp bulb can cause it to shatter.
- Never hold the halogen lamp bulb with a bare hand, dirty glove, etc. The oil from your hand could cause the bulb to break the next time the fog lamps are operated. If the glass surface is dirty, it must be cleaned with alcohol, paint thinner, etc., and refit it after drying thoroughly.

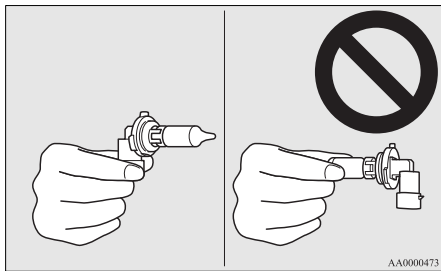

### Rear fog lamp (driver's side)

E01004100472

1. Open the lower gate and pull back the cover between the passenger compartment and the lower gate.

2. Remove the cover after you remove each of the 4 clips (A) by inserting a screw driver into the clip groove and levering it towards the vehicle body.

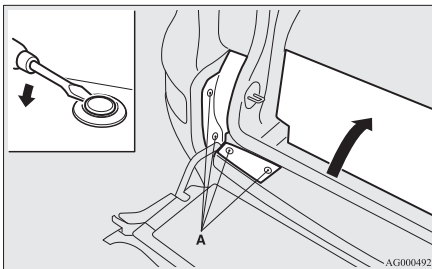

3. Remove the lamp mounting screws (B) and remove the lamp unit.

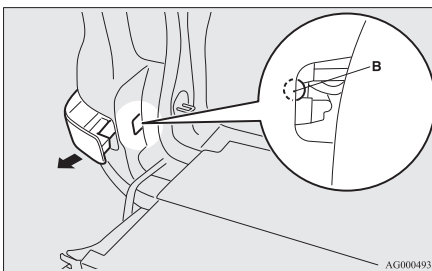

4. Remove the socket and bulb assembly (C) together by turning it anticlockwise and then remove the bulb by pulling it out.

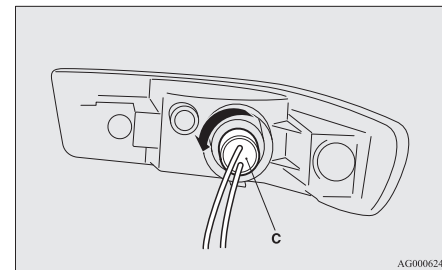

5. To install the bulb, perform the removal steps in reverse.

#### NOTE

- When mounting the lamp unit, align the pins (D) on the lamp unit with the hole in the body.

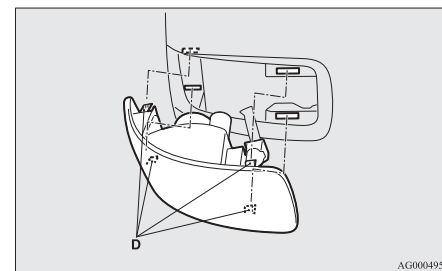

## Maintenance

### Rear combination lamps

E01004201223

1. Remove the screws (A), and then remove the lamp unit.

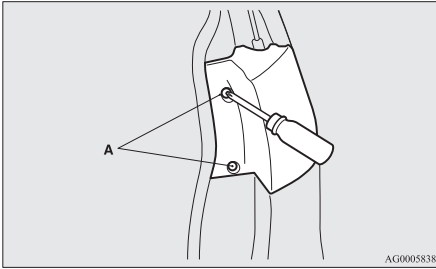

2. Turn the socket anticlockwise and remove it.

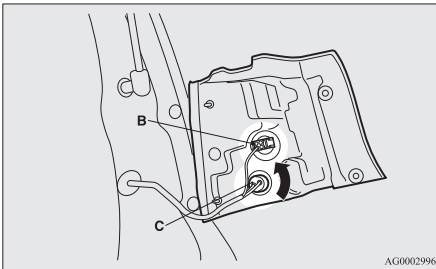

- B- Stop lamps/tail lamps (LED) - Cannot be replaced.
- C- Rear turn-signal lamps

### NOTE

- An LED, not a bulb, is used in the stop lamp/tail lamp. Contact a MITSUBISHI MOTORS Authorized Service Point when there is a need for repair or replacement.

3. Remove the bulb from the socket.

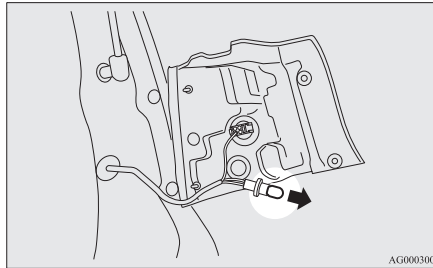

4. To install the bulb, perform the removal steps in reverse.

### NOTE

- When installing the lamp unit, align the lamp unit pins (D) with the holes on the vehicle body and install.

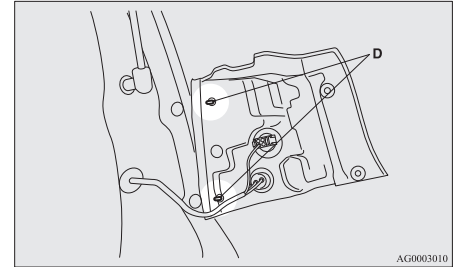

### Reversing lamps

E01004400286

1. Open the tailgate.
2. Insert a minus screwdriver with the end covered with a cloth or other object into the cut out area of the cover to wedge out the cover.

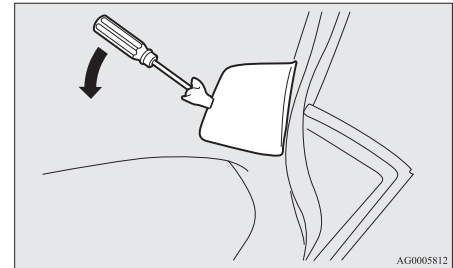

3. Turn the socket (A) anticlockwise and remove it.

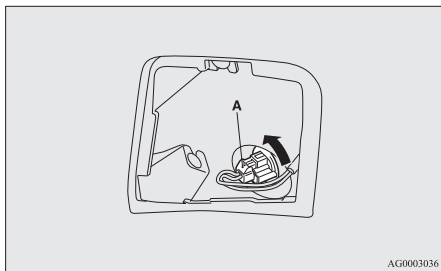

4. Remove the bulb from the socket.

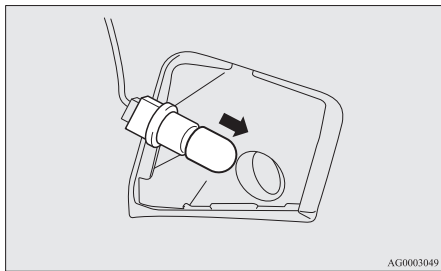

5. To install the bulb, perform the removal steps in reverse.

## High-mounted stop lamp

E01004500261

### NOTE

- An LED, not a bulb, is used in the high-mounted stop lamp. Contact a MITSUBISHI MOTORS Authorized Service Point when there is a need for repair or replacement.

## Licence plate lamps

E01004600679

1. Remove while pressing the lamp unit (A) to the left side of the vehicle.

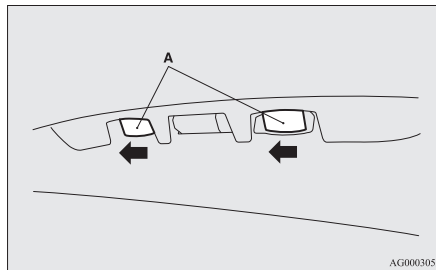

2. Insert a minus screwdriver with the end covered with a cloth or other object to press the hook (B) aside and remove the lens.

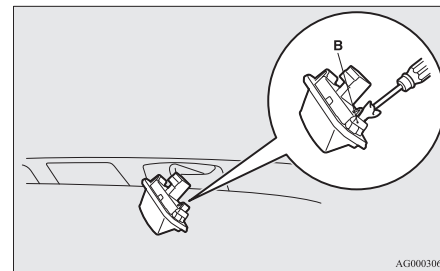

3. Remove the bulb from the socket.

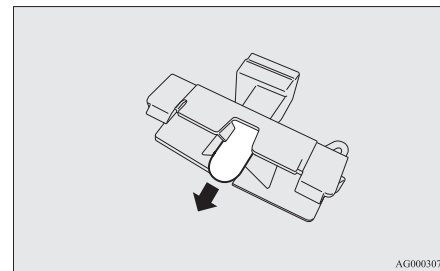

4. To install the bulb, perform the removal steps in reverse.

### NOTE

- When installing the lamp unit, first insert the end of tab (C) and then align tab (D).

## Maintenance

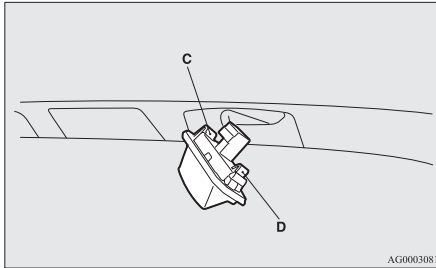

### Map & room lamps (front)

E0100500087

1. Insert a minus screwdriver with the end covered with a cloth or other object to prise out the lens.

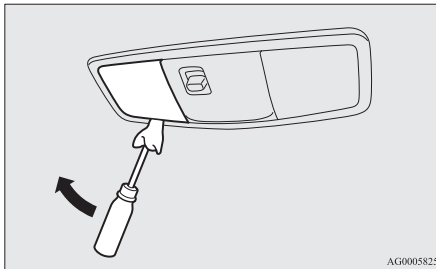

#### NOTE

- When replacing the bulb, put the map & room lamp (front) switch in the OFF position.

2. While holding down the tab (A), pull out the bulb.

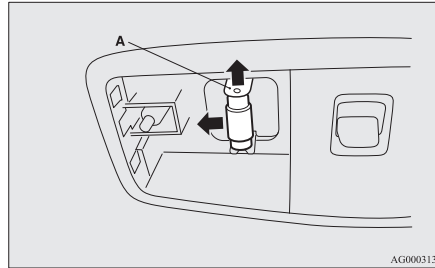

3. To install the bulb, perform the removal steps in reverse.

#### NOTE

- When installing the lens, align the hooks (B) to the holes in the vehicle body.

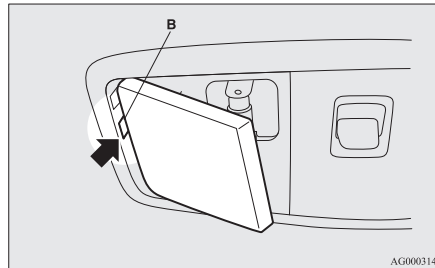

### Room lamp (rear)/luggage room lamp

E01005300442

1. Insert a minus screwdriver with the end covered with a cloth or other object into the cut out area of the lens to wedge out the lens.

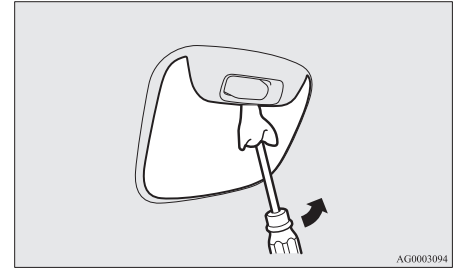

#### NOTE

- When replacing the bulb, put the room lamp (rear)/luggage area lamp switch in the "OFF" position.

2. While holding down the tab (A), pull out the bulb.

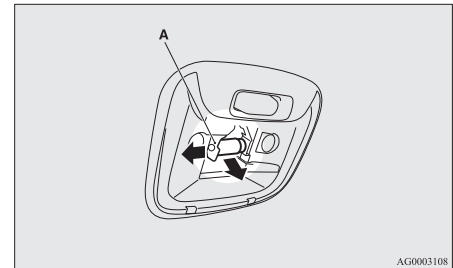



3. To install the bulb, perform the removal steps in reverse.

**NOTE**

- When installing the lens, align the hooks (B) to the holes in the vehicle body.

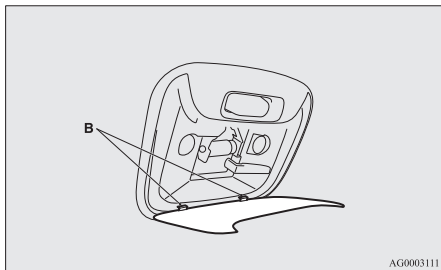

**Glove box lamp**

E01006100434

1. Turn the socket (A) anticlockwise and remove it.

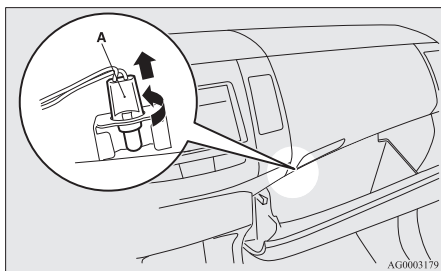

2. Remove the bulb.

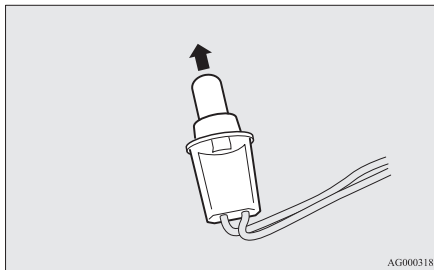

3. To install the bulb, perform the removal steps in reverse.

**Vanity mirror lamps**

E01006200233

1. Insert a straight blade (or minus) screwdriver into the notch of the lens and pry gently to remove it. Remove the bulb from the lamp holder.

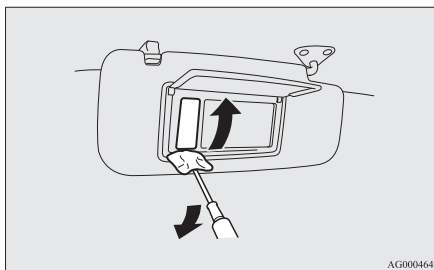

**NOTE**

- Wrap a piece of cloth around the tip of the screwdriver in order to avoid scratching the lens.

2. To install the bulb, perform the removal steps in reverse.

**Centre console down lamp**

E01008700072

**NOTE**

- An LED, not a bulb, is used in the centre console down lamp. Contact a MITSUBISHI MOTORS Authorized Service Point when there is a need for repair or replacement.

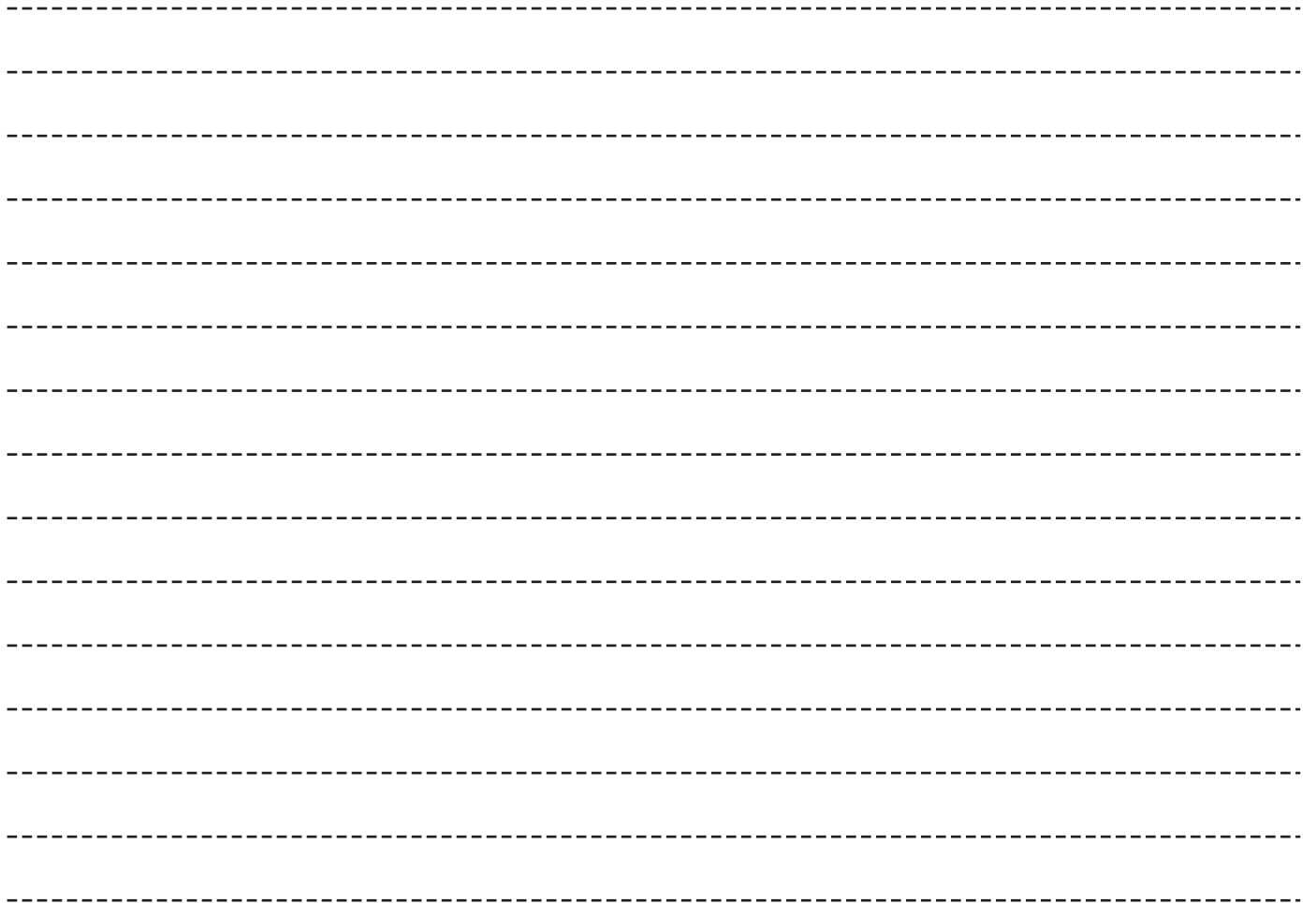

# *Specifications*

Vehicle labeling.....	9-02
Vehicle dimensions.....	9-05
Vehicle performance.....	9-07
Vehicle weight.....	9-08
Engine specifications.....	9-15
Electrical system.....	9-16
Tyres and wheels.....	9-17
Fuel consumption.....	9-18
Refill capacities.....	9-20

## Specifications

### Vehicle labeling

E01100102844

#### Vehicle identification number

The vehicle identification number is stamped on the bulkhead as shown in the illustration.

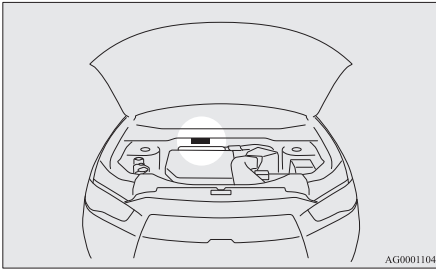

#### Vehicle information code label\*

The vehicle information code label is affixed as shown in the illustration.

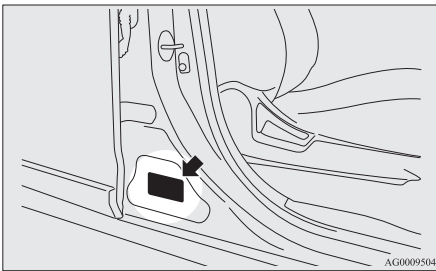

The label shows model code, engine model, transmission model and body colour code, etc.

Please use this number when ordering replacement parts.

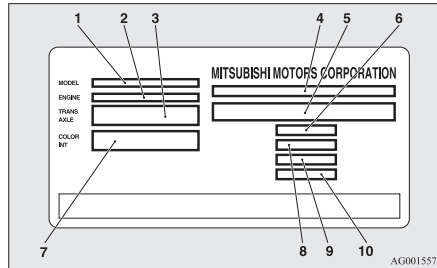

- 1- Model code
- 2- Engine model code,  
Exterior code
- 3- Transmission model code
- 4- Approval number
- 5- Chassis number
- 6- Maximum gross vehicle weight
- 7- Body colour code,  
Interior code,  
Option code
- 8- Gross combination weight
- 9- Maximum axle weight (Front)
- 10- Maximum axle weight (Rear)

#### Vehicle information code plate\*

The vehicle information code plate is riveted as shown in the illustration.

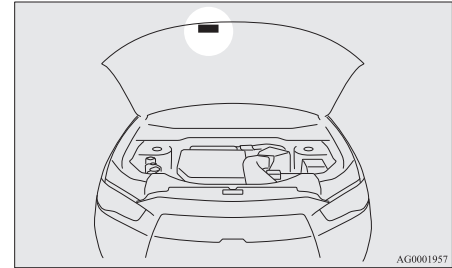

The plate shows model code, engine model, transmission model and body colour code, etc.

Please use this number when ordering replacement parts.

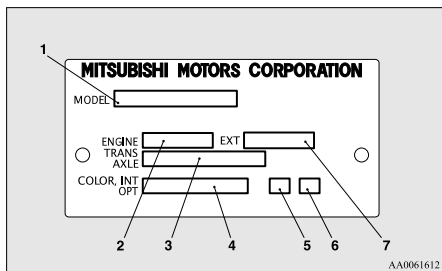

- 1- Model code
- 2- Engine model code
- 3- Transmission model code
- 4- Body colour code
- 5- Interior code
- 6- Option code
- 7- Exterior code

### Vehicle identification number plate (RHD vehicles only)

The vehicle identification number is stamped on the plate riveted to the left front corner of the instrument panel pad. It is visible from outside of the vehicle through the windscreen.

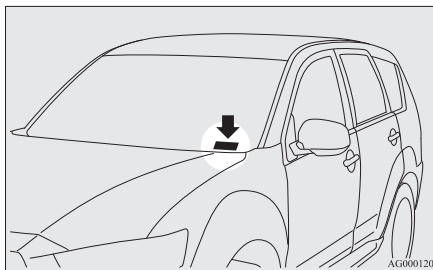

### Engine number

The engine number is stamped on the engine cylinder block as shown in the illustration.

#### Petrol-powered vehicles

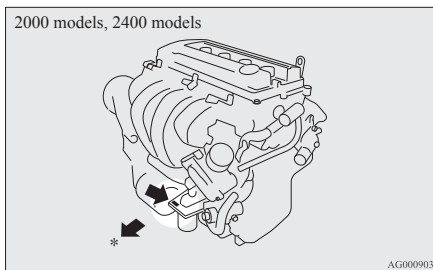

\*: Front of the vehicle

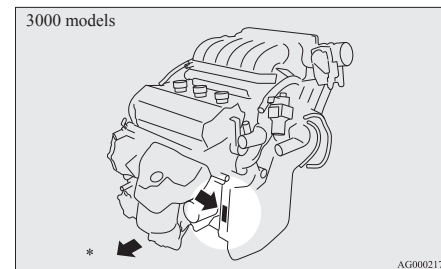

\*: Front of the vehicle

#### Diesel-powered vehicles

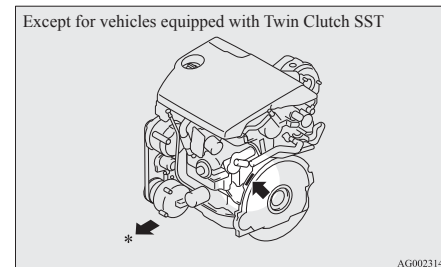

\*: Front of the vehicle

## Specifications

For vehicles equipped with Twin Clutch SST

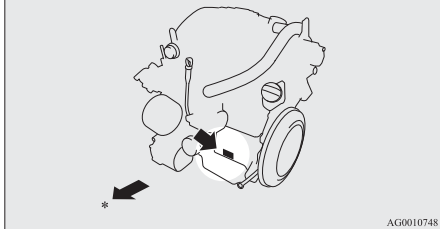

AG0010748

\*: Front of the vehicle

## Vehicle dimensions

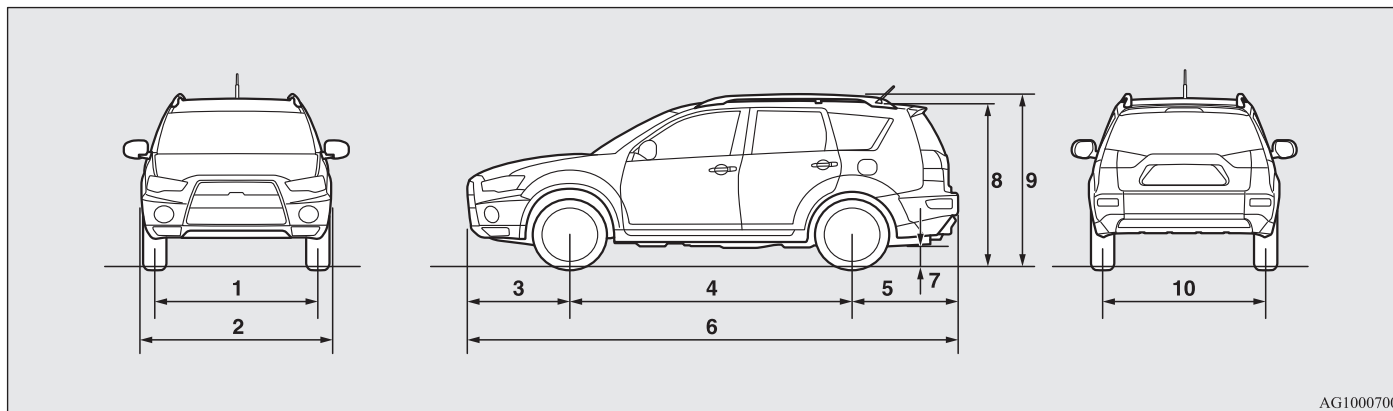

AG1000700

1	Front track		1.540 mm	
2	Overall width		1.800 mm	
3	Front overhang		990 mm	
4	Wheel base		2.670 mm	
5	Rear overhang		1.005 mm	
6	Overall length		4.665 mm	
7	Ground clearance (unladen)	Petrol-powered vehicles	215 mm	
		Diesel-powered vehicles	M/T	185 mm
			Twin Clutch SST	176 mm, 180 mm*

\*: Vehicles equipped with the high ground clearance suspension

## Specifications

8	Overall height (unladen)	Without roof rails	1.680 mm, 1.695 mm*
9		With roof rails	1.720 mm, 1.735 mm*
10	Rear track		1.540 mm
Minimum turning radius		Body	5.75 m
		Wheel	5.3 m

\*: Vehicles equipped with the high ground clearance suspension



*Vehicle performance*

E01100302035

**Petrol-powered vehicles**

Maximum speed	2000 models	2WD	184 km/h (114 mph)
		4WD	180 km/h (112 mph)
	2400 models		190 km/h (118 mph)
	3000 models		200 km/h (124 mph)

**Diesel-powered vehicles**

Maximum speed	2200 models	M/T	200 km/h (124 mph), 183 km/h (113 mph)*
		Twin Clutch SST	198 km/h (123 mph)

\*: Low power engine

*Vehicle weight*

E01100404447

**Petrol-powered vehicles***2000 models (M/T)*

Item		Without heavy duty suspension		With heavy duty suspension	
		M-line	H-line	M-line	H-line
Kerb weight	Without optional parts	1.425 kg, 1.460 kg* <sup>1</sup>	1.455 kg	1.445 kg	1.475 kg
	With full optional parts	1.514 kg, 1.531 kg* <sup>1</sup>	1.517 kg	1.534 kg	1.537 kg
Maximum gross vehicle weight		2.070 kg		2.290 kg	
Maximum axle weight	Front	1.150 kg			
	Rear	1.050 kg, 1.190 kg* <sup>2</sup>		1.300 kg, 1.440 kg* <sup>2</sup>	
Maximum towable weight	With brake	1.600 kg			
	Without brake	750 kg			
Maximum trailer-nose weight		80 kg			
Maximum roof load		80 kg			
Seating capacity		5 persons			

\*<sup>1</sup>: Vehicles for Russia, Kazakhstan and Ukraine\*<sup>2</sup>: In case of trailer towing

## NOTE

- Trailer specifications indicate the manufacturer's recommendation.

2000 models (CVT)

Item		2WD				4WD*1	
		Without heavy duty suspension		With heavy duty suspension			
		M-line	H-line	M-line	H-line	M-line	H-line
Kerb weight	Without optional parts	1.480 kg, 1.490 kg*1	1.485 kg	1.500 kg	1.505 kg	1.560 kg	1.565 kg
	With full optional parts	1.547 kg, 1.561 kg*1	1.547 kg	1.567 kg		1.631 kg	1.632 kg
Maximum gross vehicle weight		2.070 kg		2.290 kg		2.070 kg	
Maximum axle weight	Front	1.150 kg					
	Rear	1.050 kg, 1.190 kg*2		1.300 kg, 1.440 kg*2		1.050 kg, 1.190 kg*2	
Maximum towable weight	With brake	1.600 kg					
	Without brake	750 kg					
Maximum trailer-nose weight		80 kg					
Maximum roof load		80 kg					
Seating capacity		5 persons					

\*1: Vehicles for Russia, Kazakhstan and Ukraine

\*2: In case of trailer towing

NOTE

- Trailer specifications indicate the manufacturer's recommendation.

## Specifications

### 2400 models (M/T)

Item		5 persons			7 persons
		Without heavy duty suspension	With heavy duty suspension		
			M-line	H-line	
Kerb weight	Without optional parts	1.530 kg	1.555 kg * <sup>1</sup>	1.550 kg, 1.560 kg* <sup>1</sup>	1.585 kg, 1.595 kg* <sup>2</sup>
	With full optional parts	1.592 kg	1.626 kg * <sup>1</sup>	1.612 kg, 1.627 kg* <sup>1</sup>	1.647 kg, 1.662 kg* <sup>2</sup>
Maximum gross vehicle weight		2.070 kg	2.290 kg		
Maximum axle weight	Front	1.150 kg			
	Rear	1.050 kg, 1.190 kg* <sup>3</sup>	1.300 kg, 1.440 kg* <sup>3</sup>		
Maximum towable weight	With brake	1.600 kg			
	Without brake	750 kg			
Maximum trailer-nose weight		80 kg			
Maximum roof load		80 kg			

\*<sup>1</sup>: Vehicles for Russia, Kazakhstan and Ukraine

\*<sup>2</sup>: Clear Tec FFV models

\*<sup>3</sup>: In case of trailer towing

## NOTE

- Trailer specifications indicate the manufacturer's recommendation.

**2400 models (CVT)**

Item		5 persons		7 persons
		Without heavy duty suspension	With heavy duty suspension	
Kerb weight	Without optional parts	1.540 kg, 1.570 kg* <sup>1</sup>	1.560 kg, 1.590 kg* <sup>1</sup> , 1.590 kg* <sup>2</sup>	1.615 kg, 1.625 kg* <sup>1</sup>
	With full optional parts	1.616 kg, 1.637 kg* <sup>1</sup>	1.636 kg, 1.667 kg* <sup>1</sup> , 1.657 kg* <sup>2</sup>	1.677 kg, 1.692 kg* <sup>1</sup>
Maximum gross vehicle weight		2.070 kg	2.290 kg	
Maximum axle weight	Front	1.150 kg		
	Rear	1.050 kg, 1.190 kg* <sup>3</sup>	1.300 kg, 1.440 kg* <sup>3</sup>	
Maximum towable weight	With brake	1.600 kg		
	Without brake	750 kg		
Maximum trailer-nose weight		80 kg		
Maximum roof load		80 kg		

\*<sup>1</sup>: Clear Tec FFV models\*<sup>2</sup>: Vehicles for Russia, Kazakhstan and Ukraine\*<sup>3</sup>: In case of trailer towing

## NOTE

- Trailer specifications indicate the manufacturer's recommendation.

**3000 models**

Kerb weight	Without optional parts	1.645 kg
	With full optional parts	1.712 kg
Maximum gross vehicle weight		2.350 kg

\*: In case of trailer towing

## Specifications

Maximum axle weight	Front	1.150 kg
	Rear	1.300 kg, 1.440 kg*
Maximum towable weight	With brake	1.600 kg
	Without brake	750 kg
Maximum trailer-nose weight		80 kg
Maximum roof load		80 kg
Seating capacity		5 persons

\*: In case of trailer towing

## NOTE

- Trailer specifications indicate the manufacturer's recommendation.

## Diesel-powered vehicles

### 2200 models (M/T)

Item		5 persons				7 persons	
		Without heavy duty suspension		With heavy duty suspension			
		2WD	4WD	2WD	4WD	2WD	4WD
Kerb weight	Without optional parts	1.540 kg, 1.585 kg* <sup>1</sup>	1.645 kg, 1.650 kg* <sup>1</sup>	1.560 kg, 1.605 kg* <sup>1</sup>	1.665 kg, 1.670 kg* <sup>1</sup>	1.640 kg	1.705 kg
	With full optional parts	1,629 kg*, 1,647 kg* <sup>1</sup>	1.712 kg	1.649 kg, 1.667 kg* <sup>1</sup>	1.732 kg	1.702 kg	1.767 kg
Maximum gross vehicle weight		2.170 kg		2.410 kg			
Maximum axle weight	Front	1.150 kg					
	Rear	1.050 kg, 1.190 kg* <sup>2</sup>		1.300 kg, 1.440 kg* <sup>2</sup>			

\*<sup>1</sup>: H-line

\*<sup>2</sup>: In case of trailer towing

Item		5 persons				7 persons	
		Without heavy duty suspension		With heavy duty suspension			
		2WD	4WD	2WD	4WD	2WD	4WD
Maximum towable weight	With brake	2.000 kg					
	Without brake	750 kg					
Maximum trailer-nose weight		100 kg					
Maximum roof load		80 kg					

\*1: H-line

\*2: In case of trailer towing

NOTE

- Trailer specifications indicate the manufacturer's recommendation.

**2200 models (Twin Clutch SST)**

Item		5 persons	7 persons
Kerb weight	Without optional parts	1.710 kg	1.745 kg
	With full optional parts	1.772 kg	1.807 kg
Maximum gross vehicle weight		2.410 kg	
Maximum axle weight	Front	1.150 kg	
	Rear	1.300 kg, 1.440 kg*	
Maximum towable weight	With brake	2.000 kg	
	Without brake	750 kg	
Maximum trailer-nose weight		100 kg	
Maximum roof load		80 kg	

\*: In case of trailer towing

## Specifications

### NOTE

- Trailer specifications indicate the manufacturer's recommendation.



*Engine specifications*

E01100602403

**Petrol-powered vehicles**

Item	2000 models	2400 models	3000 models
Engine model	4B11	4B12	6B31
No. of cylinders	4 in line	4 in line	6-V (60°)
Total displacement	1.998 cc	2.360 cc	2.998 cc
Bore	86.0 mm	88.0 mm	87.6 mm
Stroke	86.0 mm	97.0 mm	82.9 mm
Camshaft	Double overhead	Double overhead	Single overhead
Mixture preparation	Electronic injection	Electronic injection	Electronic injection
Maximum output (EEC net)	108 kW/6,000 rpm	125 kW/6,000 rpm	164 kW/6.250 rpm
Maximum torque (EEC net)	199 Nm/4,200 rpm	232 Nm/4.100 rpm	284 Nm/3.750 rpm

**Diesel-powered vehicles**

Item	2000 models	
Engine model	4N14	4HK
No. of cylinders	4 in line	4 in line
Total displacement	2.268 cc	2.179 cc
Bore	86.0 mm	85.0 mm
Stroke	97.6 mm	96.0 mm
Camshaft	Double overhead	Double overhead
Mixture preparation	Electronic injection	Electronic injection
Maximum output (EEC net)	130 kW/3,500 rpm, 103 kW/3,500 rpm *	115 kW/4.000 rpm
Maximum torque (EEC net)	380 Nm/2,000 to 3,000 rpm, 380 Nm/2,000 rpm *	380 Nm/2.000 rpm

\*: Low power engine

## Electrical system

E01100802173

Item		Petrol-powered vehicles				Diesel-powered vehicles
		2000 models	2400 models		3000 models	
			Except for Clear Tec FFV models	Clear Tec FFV models		
Voltage		12 V				
Battery	Type (JIS)	75D23L		80D26L	95D31L, T-105*1	
	Capacity (5HR)	52 Ah		55 Ah	64 Ah, 73 Ah*1	
Alternator capacity		130 A, 120 A*2		120 A	130 A, 140 A*3	
Spark plug type	NGK	DIFR6C11	DIFR5C11	FR5EI	ILKR7B8	—
	DENSO	—	—	K16PSR-B8	SXU22HDR8	

\*1: Vehicles equipped with Auto Stop & Go (AS&G) system

\*2: Vehicles for Russia, Kazakhstan and Ukraine

\*3: Vehicles with Twin Clutch SST

*Tyres and wheels*

E01100902712

Tyre		215/70R16 100H	225/55R18 97H, 225/55R18 98V, P225/55R18 97H
Wheel	Size	16x6 1/2 JJ	18x7 J
	Offset	38 mm	

## NOTE

- Contact your MITSUBISHI MOTORS Authorized Service Point for details on the combination used on your vehicle.

## Fuel consumption

E01101100603

### Petrol-powered vehicles

Item		Combined		Urban conditions	Extra-urban conditions	
		CO <sup>2</sup> (g/km)	Fuel consumption (L/100 km)	Fuel consumption (L/100 km)	Fuel consumption (L/100 km)	
2000 models	M/T	178, 192*	7.7, 8.1*	10.0, 10.5*	6.4, 6.8*	
	CVT	2WD	179, 188*	7.7, 8.1*	9.9, 10.3*	6.4, 6.8*
		4WD	197*	8.3*	10.6*	7.0*
2400 models	M/T	5 persons	202, 218*	8.7, 9.4*	11.8, 12.6*	6.9, 7.6*
		7 persons	204	8.8	11.9	7.0
	CVT	5 persons	193, 208*	8.3, 9.0*	10.8, 11.8*	6.9, 9.0*
		7 persons	195	8.4	11.0	6.9
2400 models (Clear Tec FFV models)	M/T	224	9.5	12.7	7.6	
	CVT	213	9.0	12.0	7.3	
3000 models		252*	10.6*	15.1*	8.0*	

\*: Vehicles for Russia, Kazakhstan and Ukraine

#### NOTE

- The results given do not express or imply any guarantee of the fuel consumption of the particular vehicle. The vehicle itself has not been tested and there are inevitably differences between individual vehicles of the same model. In addition, this vehicle may incorporate particular modifications. Furthermore, the driver's style and road and traffic conditions, as well as the extent to which the vehicle has been driven and the standard of maintenance, will all affect its fuel consumption.
- For Clear Tec FFV models, the values shown for the fuel consumption and CO<sup>2</sup> emissions are when unleaded petrol 95 RON or higher is used for the fuel.

## Diesel-powered vehicles

Item				Combined		Urban conditions	Extra-urban conditions
				CO <sup>2</sup> (g/km)	Fuel consumption (L/100 km)	Fuel consumption (L/100 km)	Fuel consumption (L/100 km)
2200 models	M/T	2WD	5 persons	159, 155*	6.0, 5.8*	7.5, 7.1*	5.1
			7 persons	162, 159*	6.1, 6.0*	7.6, 7.3*	5.3
		4WD	5 persons	165	6.3	7.9	5.4
			7 persons	169	6.5	8.1	5.6
	Twin Clutch SST			189	7.2	9.3	6.0

\*: Vehicles equipped with Auto Stop & Go (AS&G) system

## NOTE

- The results given do not express or imply any guarantee of the fuel consumption of the particular vehicle. The vehicle itself has not been tested and there are inevitably differences between individual vehicles of the same model. In addition, this vehicle may incorporate particular modifications. Furthermore, the driver's style and road and traffic conditions, as well as the extent to which the vehicle has been driven and the standard of maintenance, will all affect its fuel consumption.

### Refill capacities

E01101303505

Petrol-powered vehicles  
2000 models, 2400 models

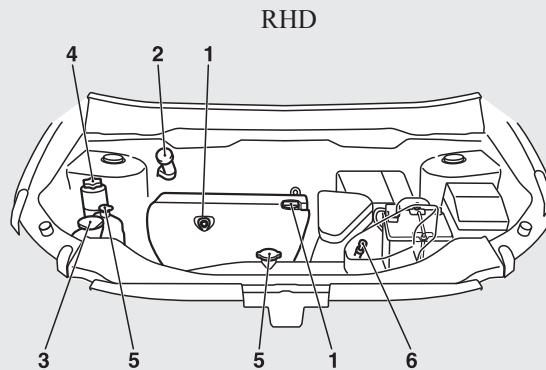
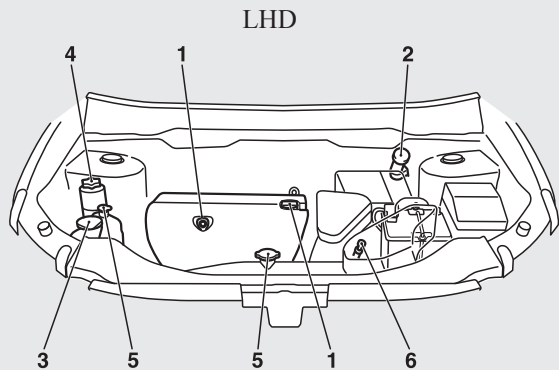

3000 models

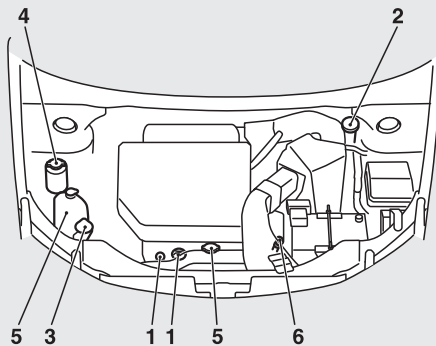

AG5003190

Diesel-powered vehicles

Except for vehicles equipped with Twin Clutch SST

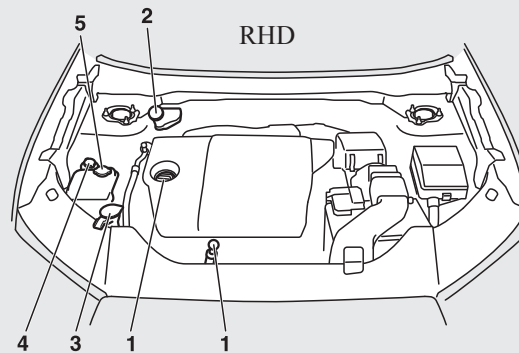
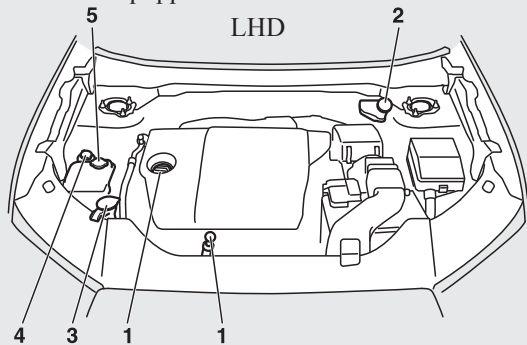

Vehicles equipped with Twin Clutch SST

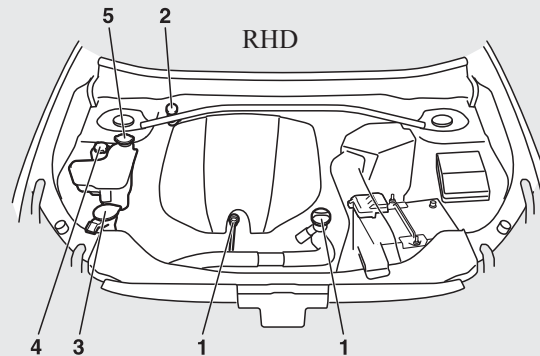
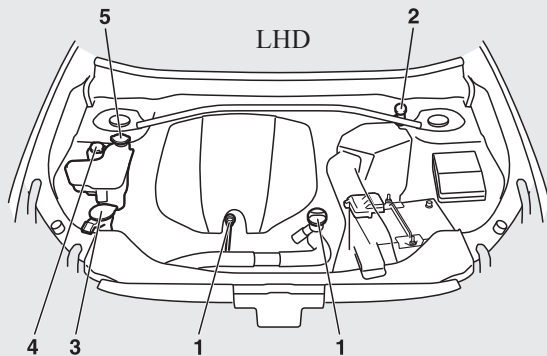

AG5003174

## Specifications

No.	Item			Quantity	Lubricants	
1	Engine oil	Petrol-powered vehicles	2000 models	Oil pan	4.0 litres	Refer to page 8-04.
				Oil filter	0.3 litre	
				Oil cooler*	0.1 litre	
			2400 models	Oil pan	4.3 litres	
				Oil filter	0.3 litre	
				Oil cooler*	0.1 litre	
		Diesel-powered vehicles	3000 models	Oil pan	4.0 litres	
				Oil filter	0.3 litre	
			M/T	Oil pan	5.5 litres	
				Oil filter	0.3 litre	
				Oil cooler	0.1 litre	
Twin Clutch SST	Oil pan	5.0 litres				
	Oil filter	0.3 litre				
2	Brake fluid			As required	Brake fluid DOT 3 or DOT 4	
	Clutch fluid					
3	Washer fluid			4.5 litres	—	
4	Power steering fluid			As required	Genuine MITSUBISHI Power Steering Fluid or ATF DEXRON III/DEXRON II	

\*: if so equipped

\*: similar high quality ethylene glycol based non-silicate, non-amine, non-nitrate and non-borate coolant with long life hybrid organic acid technology



No.	Item			Quantity	Lubricants
5	Engine coolant	Petrol-powered vehicles [includes 0.65 litre in the reserve tank]	2000 models	7.5 litres	DIA QUEEN SUPER LONG LIFE COOL-ANT PREMIUM or equivalent*
			2400 models		
			3000 models		
		Diesel-powered vehicles [includes 0.62 litre in the reserve tank]	2200 models	M/T	
Twin Clutch SST	7.6 litres			BASF Glysantin Alu Protect Premium/G30 or G33	
6	Automatic transmission fluid			8.2 litres	DIA QUEEN ATF-J3
	CVT fluid			7.1 litres	DIA QUEEN CVTF-J1
7	Manual transmission oil		5 M/T	2.5 litres	DIA QUEEN NEW MULTI GEAR OIL API classification GL-3 SAE 75W-80
			6 M/T	2.2 litres	
8	Twin Clutch SST fluid [includes 0.5 litre in the oil cooler]			7.6 litres	Dia Queen SSTF-I
9	Transfer oil		Except for Twin Clutch SST	0.49 litre	Hypoid gear oil API classification GL-5 SAE 80
			Twin Clutch SST	0.6 litre	
10	Rear differential oil			0.5 litre	Hypoid gear oil API classification GL-5 SAE 80
11	Refrigerant (air conditioning)			480 - 520 g	HFC-134a

\*: if so equipped

\*: similar high quality ethylene glycol based non-silicate, non-amine, non-nitrate and non-borate coolant with long life hybrid organic acid technology

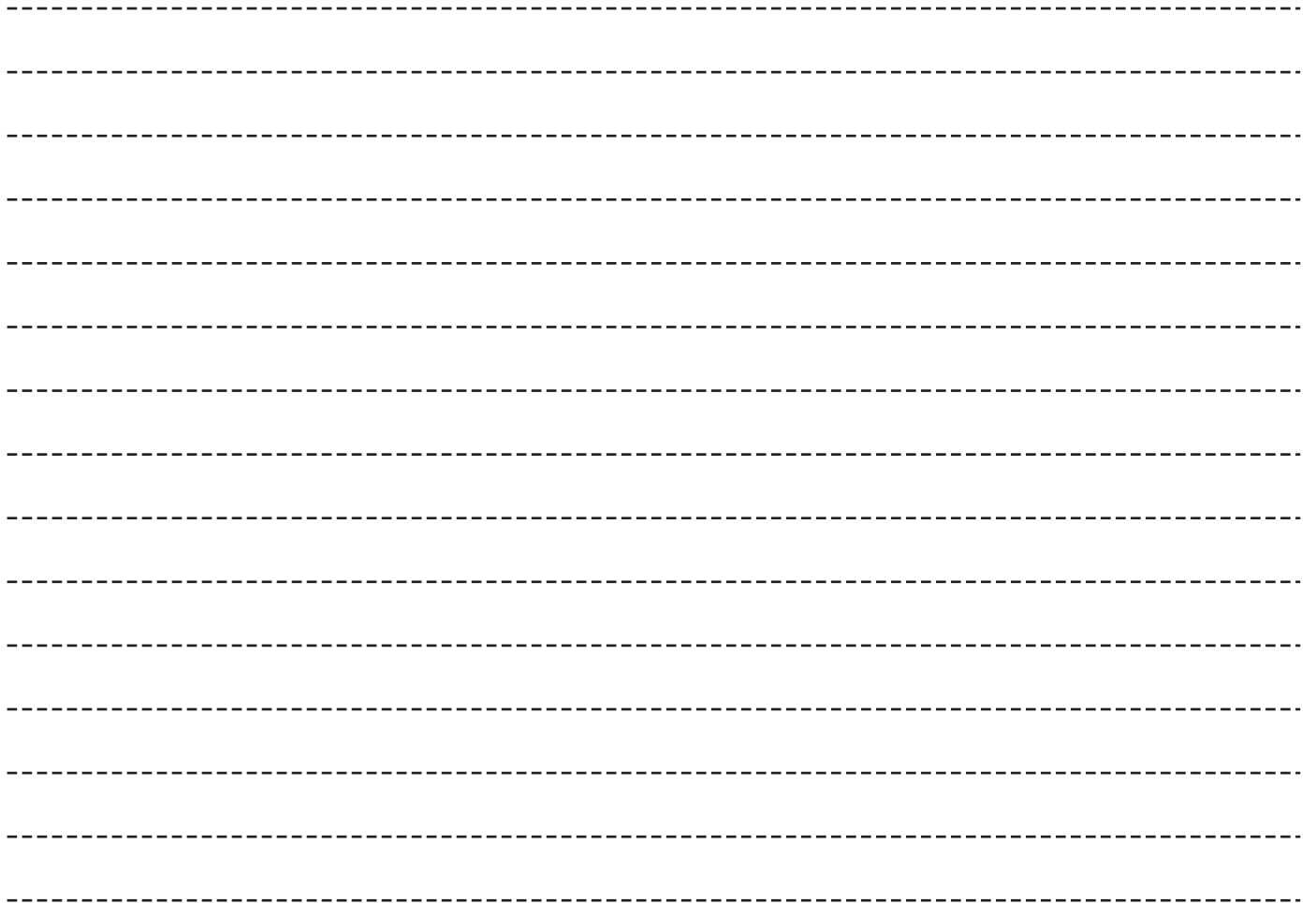

---

**4**

---

4-wheel drive operation 4-48

---

**A**

---

Accessory (Installation) 04  
 Accessory socket 5-84  
 Active stability control (ASC) 4-58  
 Adaptive Front lighting System (AFS) 3-48  
   Adaptive Front lighting System (AFS) indications 3-49  
   Adaptive Front lighting System (AFS) OFF switch 3-49  
 Adaptive Front lighting System (AFS) OFF indication lamp 3-37  
 Additional equipment 8-17  
 AFS 3-48  
 Air conditioning  
   Automatic air conditioning 5-04  
   Important operation tips for the air conditioning 5-09  
 Air purifier 5-09  
 Airbag 2-31  
 Antenna 5-61  
 Anti-lock brake system (ABS) 4-55  
 Ashtray 5-83  
 Assist grips 5-94  
 Audio  
   Error codes 5-55  
   External audio input function 5-52  
   Handling of compact discs 5-60  
   LW/MW/FM digital tuning radio with CD changer 5-24  
   LW/MW/FM digital tuning radio with CD player 5-10  
   Steering wheel audio remote control switches 5-53

To listen to a disc in the rear-seat display 5-53  
 Auto Stop & Go (AS&G) system 4-19  
 Automatic transmission  
   Fluid 9-20  
   Selector lever operation 4-25,4-30  
   Selector lever position 4-26  
   Selector lever positions 4-32  
   Sports mode 4-27,4-33

---

**B**

---

Battery 8-09  
   Charge warning lamp 3-39  
   Discharged battery (Emergency starting) 6-02  
   Disposal information for used batteries 06  
   Specification 9-16  
 Bending lamps  
   Bulb capacity 8-24  
   Replacement 8-27  
 Bleeding the fuel system 6-06  
 Bluetooth® 2.0 interface 5-64  
 Bonnet 8-03  
 Bottle holder 5-92  
 Brake assist system 4-54  
 Brake  
   Anti-lock brake 4-55  
   Braking 4-51  
   Fluid 8-08,9-20  
   Parking brake 4-07  
 Bulb capacity 8-23

---

**C**

---

Capacities 9-20  
 Card holder 5-89  
 Cargo loads 4-70  
 Catalytic converter 8-02  
 Cautions on handling of 4-wheel drive vehicles 4-50

Central door locks 1-28  
 Charge warning lamp 3-39  
 Check engine warning lamp 3-38  
 Child restraint 2-23  
 Child-protection rear doors 1-31  
 Cigarette lighter 5-83  
 Cleaning  
   Exterior of your vehicle 7-03  
   Interior of your vehicle 7-02  
 Clock 5-62  
 Clutch  
   Fluid 8-08  
   Fluid 9-20  
 Coat hook 5-94  
 Combination headlamps and dipper switch 3-42  
 Coolant (engine) 8-06,9-20  
 Corner sensor 4-65  
 Cruise control 4-60  
 Cup holder 5-91

---

**D**

---

Daytime running lamp 3-43  
 Demister (rear window) 3-57  
 Diesel particulate filter (DPF) 4-17  
 Digital clock 5-62  
 Dimensions 9-05  
 Dipper (High/Low beam change) 3-44  
 Doors  
   Central door locks 1-28  
   Child-protection 1-31  
   Dead Lock System 1-29  
   Lock and unlock 1-26  
 Driving, alcohol and drugs 4-02

---

**E**

---

Economical driving 4-02  
 Electric window control 1-41

## Alphabetical index

Electrical system 9-16  
Electronic immobilizer (Anti-theft starting system) 1-03  
Electronically controlled 4WD system 4-46  
Emergency starting 6-02  
Emergency stop signal system 4-54  
Engine specifications 9-15  
Engine  
    Coolant 8-06,9-20  
    MIVEC 4-15,4-16  
    Number 9-03  
    Oil 8-04  
    Oil and oil filter 9-20  
    Overheating 6-04  
    Specifications 9-15  
    Used engine oils safety instructions and disposal information 06  
Exterior and interior lamp operation 8-17

---

### F

---

Fluid capacities and lubricants 9-20  
Fluid  
    Automatic transmission fluid 9-20  
    Brake fluid 8-08,9-20  
    Clutch fluid 8-08,9-20  
    CVT fluid 9-20  
    Engine coolant 8-06,9-20  
    Power steering fluid 8-09,9-20  
    Twin Clutch SST fluid 9-20  
    Washer fluid 8-08,9-20  
For cold and snowy weather 8-17  
Force limiter 2-22  
Front fog lamps  
    Bulb capacity 8-24  
    Replacement 8-30  
    Switch 3-50  
Front room & map lamp  
    Bulb capacity 8-25

Front room lamp 5-85  
    Bulb capacity 8-25  
    Replacement 8-34  
Front seat 2-05  
Front turn-signal lamps  
    Bulb capacity 8-24  
    Replacement 8-29  
Fuel consumption 9-18  
Fuel  
    Filling the fuel tank 03  
    Fuel selection 02  
    Modification/alterations to the electrical or fuel systems 05  
    Tank capacity 03  
Fuses 8-18  
Fusible links 8-18

---

### G

---

General maintenance 8-17  
General vehicle data 9-05  
Genuine parts 05  
Glove box lamp  
    Bulb capacity 8-25  
    Replacement 8-35

---

### H

---

Hazard warning flasher switch 3-50  
Hazard warning indication lamps 3-37  
Head restraints 2-14  
Headlamp levelling switch 3-46  
Headlamp washer switch 3-56  
Headlamps  
    Bulb capacity 8-24  
    Headlamp flasher 3-44  
    Replacement 8-25,8-26,8-27  
    Switch 3-42  
Heated mirror 4-12

Heated seats 2-08  
High-mounted stop lamp  
    Replacement 8-33  
Hill start assist 4-52  
Hinges and latches lubrication 8-17  
Horn switch 3-57

---

### I

---

If the vehicle breaks down 6-02  
Indication lamps 3-37  
Information screen display 3-39  
Inside rear-view mirror 4-09  
Inside tailgate release 1-34  
Inspection and maintenance following rough road operation 4-50  
Instruments 3-02  
Interior lamps 5-85

---

### J

---

Jack  
    Storage 6-08  
Jump starting (Emergency starting) 6-02

---

### K

---

Keyless entry system 1-04  
Keyless operation system 1-07  
Keys 1-02

---

### L

---

Labeling 9-02  
Lamp monitor buzzer 3-44  
Leakage (Fuel, engine coolant, oil and exhaust gas) 8-17  
Licence plate lamps  
    Bulb capacity 8-24

Replacement 8-33  
 Link System 5-64  
 Lubricants 9-20  
 Luggage hooks 5-94  
 Luggage room lamp 5-87  
     Bulb capacity 8-25  
     Replacement 8-34  
 LW/MW/FM digital tuning radio with CD changer 5-24  
 LW/MW/FM digital tuning radio with CD player 5-10

---

**M**

---

Making a flat seat 2-17  
 Making a luggage room 2-15  
 Manual transmission 4-22  
 Map lamps 5-86  
     Bulb capacity 8-25  
     Replacement 8-34  
 Mirror  
     Inside rear-view mirror 4-09  
     Outside rear-view mirror 4-10  
 MIVEC engine 4-15,4-16  
 Modification/alterations to the electrical or fuel systems 05  
 Multi-information display 3-03

---

**O**

---

Oil  
     Engine oil 8-04  
     Manual transmission oil 9-20  
     Rear differential oil 9-20  
     Transfer oil 9-20  
 Operation under adverse driving conditions 6-22  
 Outside rear-view mirrors 4-10  
 Overheating 6-04

---

**P**

---

Parking 4-08  
     Parking brake 4-07  
     Parking brake break-in 8-15  
 Position lamps  
     Bulb capacity 8-24  
     Replacement 8-28  
 Power steering  
     Fluid 8-09,9-20  
     System 4-57  
 Precautions to observe when using wipers and washers 3-56  
 Pregnant women restraint 2-22  
 Puncture  
     Tyre changing 6-09

---

**R**

---

Rear combination lamps  
     Bulb capacity 8-24  
     Replacement 8-32  
 Rear differential oil 9-20  
 Rear fog lamp  
     Bulb capacity 8-24  
     Replacement 8-31  
     Switch 3-51  
 Rear room lamp 5-85  
     Bulb capacity 8-25  
     Replacement 8-34  
 Rear turn-signal lamps  
     Bulb capacity 8-24  
     Replacement 8-29,8-32  
 Rear window demister switch 3-57  
 Rear-view camera 4-68  
 Rear-view mirror  
     Inside 4-09  
     Outside 4-10

Refill capacities 9-20  
 Removal of water from the fuel filter 6-06  
 Replacement of lamp bulbs 8-23  
 Reversing lamps  
     Bulb capacity 8-24  
     Replacement 8-32  
 Reversing sensor system 4-65  
 Roof carrier precaution 4-71  
 Room lamp 5-85  
 Running-in recommendations 4-04

---

**S**

---

Safe driving techniques 4-03  
 Seat belt 2-19  
     Adjustable seat belt anchor 2-21  
     Child restraint 2-23  
     Inspection 2-31  
     Pregnant women restraint 2-22  
     Pretensioner system 2-22  
     Rear seat belt storage 2-21  
 Seat  
     Adjustment 2-05  
     Front seat 2-05  
     Head restraints 2-14  
     Heated seat 2-08  
     Making a flat seat 2-17  
     Making a luggage room 2-15  
     Second seat 2-08  
     Third seat 2-10  
 Security alarm system 1-35  
 Service precaution 8-02  
 Side turn-signal lamp  
     Bulb capacity 8-24  
 Side turn-signal lamps  
     Replacement 8-29  
 Snow tyres 8-14  
 Spark plug 9-16  
 Specifications 9-02

## Alphabetical index

Starting 1-16,1-20

Steering

Power steering fluid 8-09,9-20

Power steering system 4-57

Steering wheel height adjustment 4-09

Steering wheel lock 1-16,1-20,4-14

Stop lamps

Bulb capacity 8-24

Replacement 8-32

Storage spaces 5-87

Sun visors 5-82

Sunroof 1-43

Supplemental restraint system 2-31

Servicing 2-41

---

## T

---

Tachometer 3-02

Tail lamps

Bulb capacity 8-24

Replacement 8-32

Tailgate 1-31

Tank capacity 03

Tissue holder 5-90

Tools

Storage 6-08

Towing 6-19

Trailer towing 4-72

Transfer oil 9-20

Transmission

Automatic transmission 4-25,4-30

Manual transmission 4-22

Twin Clutch SST (Sport Shift Transmission) 4-36

Turbocharger operation 4-18

Turn-signal indication lamps 3-37

Turn/Lane-change signals 3-48

Twin Clutch SST (Sport Shift Transmission) 4-36

Fluid 9-20

Gearshift lever 4-36

Gearshift lever position display 4-38

Gearshift lever positions 4-38

Manual shift 4-40

Tyres 8-11

How to change a tyre 6-09

Inflation pressures 8-12

Rotation 8-13

Size (tyre and wheel) 9-17

Snow tyres 8-14

Tyre chains 8-14

---

## U

---

USB input terminal 5-80

How to connect an iPod 5-80

USB input terminal device

How to connect a USB memory device 5-80

Used engine oils safety instructions and disposal information 06

---

## V

---

Vanity mirror lamp

Bulb capacity 8-25

Replacement 8-35

Vehicle care precautions 7-02

Vehicle dimensions 9-05

Vehicle identification number plate 9-03

Vehicle information code plate 9-02

Vehicle labeling 9-02

Vehicle performance 9-07

Vehicle weight 9-08

Ventilators 5-02

---

## W

---

Warning lamps 3-38

Washer

Fluid 8-08,9-20

Switch 3-51,3-55

Washing 7-03

Waxing 7-04

Weatherstripping 8-17

Weight 9-08

Wheel

Covers 6-18

Specification 9-17

Wiper de-icer switch 3-56

Wiper

Rear window 3-55

Windscreen 3-51

Wiper blades 8-15

# OMRON

OMRON Corporation  
6568 NENJO-ZAKA, OKUSA, KOMAKI-CITY,  
AICHI 485-0802 JAPAN  
PHONE:+81-568-78-6159  
FAX :+81-568-78-7659

## DECLARATION OF CONFORMITY

We, **OMRON Corporation**, **AUTOMOTIVE ELECTRONIC COMPONENTS COMPANY** hereby declare, at our sole responsibility, that the following product conforms to the Essential Requirements of the Radio and Telecommunications Terminal Equipment Directive 1999/5/EC in accordance with the tests conducted to the appropriate requirements of the relevant standards, as listed herewith.

**Product** : KOS / FOB / WCM / Transmitter  
**Model/ Type Number** : ECU : G8D-841M-ECU-E  
: FOB : G8D-644M-KEY-E  
: WCM : G8D-841M-WCM-E  
: Transmitter : G8D-576M-A / G8D-635M-A

Directive and Standards used as appropriate : **Radio** : EN 300 220-1 V2.1.1  
EN 300 220-2 V2.1.2 ( note 1 )  
EN 300 220-2 V2.1.1 ( note 2 )  
EN 300 330-1 V1.3.2 ( note 3 )  
EN 300 330-2 V1.3.1 ( note 3 )  
**EMC** : EN 301 489-1 V1.8.1 ( note 1 )  
EN 301 489-3 V1.6.1 ( note 2 )  
EN 301 489-3 V1.4.1  
**Safety** : EN 60065:2002+Amd.11 ( note 3 )  
EN 60065:2002+Amd.1 ( note 4 )

note 1 : except GRD-576M-A note 2 : GRD-576M-A only note 3 : ECU and WCM only note 4 : FOB and Transmitter only  
Year of affixing CE marking : 2009

### ●CAUTION

Danger of explosion if battery is incorrectly replaced.  
Replace only with the same or equivalent type.  
Battery shall not be exposed to excessive heat such as sunshine, fire or the like.

Signature : *Fumio Hayashi*  
Name : Fumio Hayashi

Title and position : Manager  
DEVELOPMENT STRATEGY DEPT.  
DEVELOPMENT & DESIGN DIV.

Date : December 24, 2009

# CE 1731

[Czech]	OMRON Corporation tímto prohlašuje, že tento [G8D-640M-ECU* G8D-640M-KEY-E* G8D-576M-A* G8D-640M-RAM-E* G8D-649M* G8D-644M-KEY* G8D-646M* G8D-635M-A* G8D-841M-ECU-E* G8D-841M-WCM-E*] je ve shodě se základními požadavky a dalšími příslušnými ustanoveními směrnice 1999/5/EEC.
[Danish]	Undertegnede OMRON Corporation erklærer herved, at følgende udskrift [G8D-640M-ECU* G8D-640M-KEY-E* G8D-576M-A* G8D-640M-RAM-E* G8D-649M* G8D-644M-KEY* G8D-646M* G8D-635M-A* G8D-841M-ECU-E* G8D-841M-WCM-E*] overholder de væsentlige krav og øvrige relevante krav i direktiv 1999/5/EEC.
[German]	Hiermit erkläre OMRON Corporation, dass sich das Gerät [G8D-640M-ECU* G8D-640M-KEY-E* G8D-576M-A* G8D-640M-RAM-E* G8D-649M* G8D-644M-KEY* G8D-646M* G8D-635M-A* G8D-841M-ECU-E* G8D-841M-WCM-E*] in Übereinstimmung mit den grundlegenden Anforderungen und den übrigen einschlägigen Bestimmungen der Richtlinie 1999/5/EG befindet.
[Estonian]	Käesolevaga kinnitab OMRON Corporation seadme [G8D-640M-ECU* G8D-640M-KEY-E* G8D-576M-A* G8D-640M-RAM-E* G8D-649M* G8D-644M-KEY* G8D-646M* G8D-635M-A* G8D-841M-ECU-E* G8D-841M-WCM-E*] vastavalt direktiivi 1999/5/EÜ põhinõuetele ja nimetatud direktiivist tulenevatele teistele asjakohastele sätetele.
[English]	Herewith, OMRON Corporation, declares that this [G8D-640M-ECU* G8D-640M-KEY-E* G8D-576M-A* G8D-640M-RAM-E* G8D-649M* G8D-644M-KEY* G8D-646M* G8D-635M-A* G8D-841M-ECU-E* G8D-841M-WCM-E*] is in compliance with the essential requirements and other relevant provisions of Directive 1999/5/EC.
[Spanish]	Por medio de la presente OMRON Corporation declara que el [G8D-640M-ECU* G8D-640M-KEY-E* G8D-576M-A* G8D-640M-RAM-E* G8D-649M* G8D-644M-KEY* G8D-646M* G8D-635M-A* G8D-841M-ECU-E* G8D-841M-WCM-E*] cumple con los requisitos esenciales y cualesquiera otras disposiciones aplicables o exigibles de la Directiva 1999/5/CE.
[Greek]	ΜΕ ΤΗΝ ΠΑΡΟΥΣΑ ΟΜΡΟΝ Corporation ΔΗΛΩΝΕΙ ΟΤΙ [G8D-640M-ECU* G8D-640M-KEY-E* G8D-576M-A* G8D-640M-RAM-E* G8D-649M* G8D-644M-KEY* G8D-646M* G8D-635M-A* G8D-841M-ECU-E* G8D-841M-WCM-E*] ΣΥΝΜΟΡΦΩΝΕΤΑΙ ΠΡΟΣ ΤΙΣ ΟΥΣΙΩΔΕΙΣ ΑΠΑΙΤΗΣΕΙΣ ΚΑΙ ΤΙΣ ΛΟΙΠΕΣ ΣΥΝΕΤΙΚΕΣ ΑΠΑΙΤΗΣΕΙΣ ΤΗΣ ΟΑΗΤΑΕ 1999/5/ΕΚ.
[French]	Par la présente OMRON Corporation déclare que l'appareil [G8D-640M-ECU* G8D-640M-KEY-E* G8D-576M-A* G8D-640M-RAM-E* G8D-649M* G8D-644M-KEY* G8D-646M* G8D-635M-A* G8D-841M-ECU-E* G8D-841M-WCM-E*] est conforme aux exigences essentielles et aux autres dispositions pertinentes de la directive 1999/5/CE.
[Italian]	Con la presente OMRON Corporation dichiara che questo [G8D-640M-ECU* G8D-640M-KEY-E* G8D-576M-A* G8D-640M-RAM-E* G8D-649M* G8D-644M-KEY* G8D-646M* G8D-635M-A* G8D-841M-ECU-E* G8D-841M-WCM-E*] è conforme ai requisiti essenziali ed alle altre disposizioni pertinenti stabilite dalla direttiva 1999/5/CE.
[Latvian]	Ar šo OMRON Corporation deklarē, ka [G8D-640M-ECU* G8D-640M-KEY-E* G8D-576M-A* G8D-640M-RAM-E* G8D-649M* G8D-644M-KEY* G8D-646M* G8D-635M-A* G8D-841M-ECU-E* G8D-841M-WCM-E*] atbilst Direktīvas 1999/5/EK būtiskajām prasībām un citiem ar to saistītajiem noteikumiem.
[Lithuanian]	Šiuo OMRON Corporation deklaruojama, kad šis [G8D-640M-ECU* G8D-640M-KEY-E* G8D-576M-A* G8D-640M-RAM-E* G8D-649M* G8D-644M-KEY* G8D-646M* G8D-635M-A* G8D-841M-ECU-E* G8D-841M-WCM-E*] atitinka esminius reikalavimus ir kitas 1999/5/EB Direktyvos nuostatas.
[Dutch]	Hierbij verklaart OMRON Corporation dat het toestel [G8D-640M-ECU* G8D-640M-KEY-E* G8D-576M-A* G8D-640M-RAM-E* G8D-649M* G8D-644M-KEY* G8D-646M* G8D-635M-A* G8D-841M-ECU-E* G8D-841M-WCM-E*] in overeenstemming is met de essentiële eisen en de andere relevante bepalingen van richtlijn 1999/5/EG.
[Maltese]	Hawnhekk, OMRON Corporation, jiddekljara li dan [G8D-640M-ECU* G8D-640M-KEY-E* G8D-576M-A* G8D-640M-RAM-E* G8D-649M* G8D-644M-KEY* G8D-646M* G8D-635M-A* G8D-841M-ECU-E* G8D-841M-WCM-E*] jikkonforma mal-buġiet essenzjali u ma provvedimenti oħrajn relevanti li hemm fid-Direttiva 1999/5/EC.
[Hungarianian]	Alulírott, OMRON Corporation nyilatkozom, hogy a [G8D-640M-ECU* G8D-640M-KEY-E* G8D-576M-A* G8D-640M-RAM-E* G8D-649M* G8D-644M-KEY* G8D-646M* G8D-635M-A* G8D-841M-ECU-E* G8D-841M-WCM-E*] megfelel a vonatkozó alapvető követelményeknek és az 1999/5/EC irányelv egyéb előírásainak.



[Polish]	OMRON Corporation ] niniejszym oświadcza, że [G8D-640M-ECU]*, G8D-640M-KEY-E*, G8D-576M-A*, G8D-640M-RAAM-E*, G8D-649M/*, G8D-649M/*, G8D-644M-KEY*, G8D-646M/*, G8D-635M-A*, G8D-841M-ECU-E*, G8D-841M-ECU-E*, G8D-841M-WCM-E*] spełnia zasadnicze wymogi oraz inne istotne postanowienia dyrektywy 1999/5/EC.
[Portuguese]	OMRON Corporation declara que este [G8D-640M-ECU]*, G8D-640M-KEY-E*, G8D-576M-A*, G8D-640M-RAAM-E*, G8D-649M/*, G8D-644M-KEY*, G8D-646M/*, G8D-635M-A*, G8D-841M-ECU-E*, G8D-841M-WCM-E*] está conforme com os requisitos essenciais e outras disposições da Directiva 1999/5/CE.
[Slovenian]	OMRON Corporation izjavlja, da je ta [G8D-640M-ECU]*, G8D-640M-KEY-E*, G8D-576M-A*, G8D-640M-RAAM-E*, G8D-649M/*, G8D-644M-KEY*, G8D-646M/*, G8D-635M-A*, G8D-841M-ECU-E*, G8D-841M-WCM-E*] v skladu z bistvenimi zahtevami in ostalimi relevantnimi določili direktive 1999/5/ES.
[Slovak]	OMRON Corporation týmto vyhlasuje, že [G8D-640M-ECU]*, G8D-640M-KEY-E*, G8D-576M-A*, G8D-640M-RAAM-E*, G8D-649M/*, G8D-644M-KEY*, G8D-646M/*, G8D-635M-A*, G8D-841M-ECU-E*, G8D-841M-WCM-E*] spĺňa základné požiadavky a všetky príslušné ustanovenia Smernice 1999/5/ES.
[Finnish]	OMRON Corporation vakuuttaa läten että [G8D-640M-ECU]*, G8D-640M-KEY-E*, G8D-576M-A*, G8D-640M-RAAM-E*, G8D-649M/*, G8D-644M-KEY*, G8D-646M/*, G8D-635M-A*, G8D-841M-ECU-E*, G8D-841M-WCM-E*] täyttävät kaikki edellytykset ja muut olennaiset vaatimukset ja sitä koskevien direktiivin muiden ehtojen mukaisesti.
[Swedish]	Härmed intygar OMRON Corporation att denna [G8D-640M-ECU]*, G8D-640M-KEY-E*, G8D-576M-A*, G8D-640M-RAAM-E*, G8D-649M/*, G8D-644M-KEY*, G8D-646M/*, G8D-635M-A*, G8D-841M-ECU-E*, G8D-841M-WCM-E*] står i överensstämmelse med de väsentliga egenskapskrav och övriga relevanta bestämmelser som framgår av direktiv 1999/5/EG.
[Icelandic]	Hér með lýsir OMRON Corporation yfir því að [G8D-640M-ECU]*, G8D-640M-KEY-E*, G8D-576M-A*, G8D-640M-RAAM-E*, G8D-649M/*, G8D-644M-KEY*, G8D-646M/*, G8D-635M-A*, G8D-841M-ECU-E*, G8D-841M-WCM-E*] er í samræmi við grunnkröfur og aðrar kröfur, sem gerðar eru í tilskipun 1999/5/EC.
[Norwegian]	OMRON Corporation erklærer herved at utstyret [G8D-640M-ECU]*, G8D-640M-KEY-E*, G8D-576M-A*, G8D-640M-RAAM-E*, G8D-649M/*, G8D-644M-KEY*, G8D-646M/*, G8D-635M-A*, G8D-841M-ECU-E*, G8D-841M-WCM-E*] er i samsvar med de grunnleggende krav og øvrige relevante krav i direktiv 1999/5/EC.
[Turkish]	İşbu belge ile OMRON Corporation, bu [G8D-640M-ECU]*, G8D-640M-KEY-E*, G8D-576M-A*, G8D-640M-RAAM-E*, G8D-649M/*, G8D-644M-KEY*, G8D-646M/*, G8D-635M-A*, G8D-841M-ECU-E*, G8D-841M-WCM-E*] in 1999/5/EC Yönetmeliği esas gereksinimlerini ve diğer şartlarına uygun olduğunu beyan eder.
[Romanian]	Noti OMRON Corporation declarăm că aparatul [G8D-640M-ECU]*, G8D-640M-KEY-E*, G8D-576M-A*, G8D-640M-RAAM-E*, G8D-649M/*, G8D-644M-KEY*, G8D-646M/*, G8D-635M-A*, G8D-841M-ECU-E*, G8D-841M-WCM-E*] este în conformitate cu cerințele esențiale și cu alte prevederi relevante ale Hotărârii Guvernului nr 88/2003 și Directivei 1999/5/EC.
[Bulgarian]	С настоящия документ OMRON Corporation декларира, че [G8D-640M-ECU]*, G8D-640M-KEY-E*, G8D-576M-A*, G8D-640M-RAAM-E*, G8D-649M/*, G8D-644M-KEY*, G8D-646M/*, G8D-635M-A*, G8D-841M-ECU-E*, G8D-841M-WCM-E*] е в съгласие с основните изисквания и съответните постановления на Директива 1999/5/EC.

## EC-Declaration of Conformity

Manufacturer / responsible person Johnson Controls Interior Experience  
 Address: 915 E. 32nd Street  
Holland Michigan USA 49423

Declares that the product  
 type: BlueTooth Hands Free for Automotive  
 model: 1872669-1872721  
 Intended use: Hands Free cellphone interface to vehicle audio system

complies with the essential requirements of Article 3 of the R&TTE 1999/5/EC Directive, if used as intended and that the following standards has been applied:

- 1 Safety (Article 3.1.a of the R&TTE Directive)  
 applied standard(s) EN 60 950-1 issue 2001  
+ A.11 issue 2004  
EN 50371 issue 2008
- 2 Electromagnetic compatibility (Article 3.1.b of the R&TTE Directive)  
 applied standard(s) ETSI EN 301 489-1 V1.6.1 issue 2005-09  
ETSI EN 301 489-17 V1.2.1 issue 2002-08
- 3 Efficient use of the radio frequency spectrum (Article 3.2 of the R&TTE Directive)  
 applied standard(s) ETSI EN 300 328 V1.7.1 issue 2006-10

Holland, MI USA 9/30/2009  
 (Place and date of the declaration of conformity)

John D. Spencer  
 (Name and signature)

Česky [Czech]:	Toto zařízení je v souladu se základními požadavky a ostatními povinnými ustanoveními Směrnice 1999/5/EC.
Dansk [Danish]:	Dette udstyr er i overensstemmelse med de væsentlige krav og andre relevante bestemmelser i Direktiv 1999/5/EF.
Deutsch [German]:	Dieses Gerät entspricht den grundlegenden Anforderungen und den weiteren entsprechenden Vorgaben der Richtlinie 1999/5/EU.
Eesti [Estonian]:	See seade vastab direktiivi 1999/5/EÜ olulistele nõuetele ja teistele asjakohastele sätetele.
English:	This equipment is in compliance with the essential requirements and other relevant provisions of Directive 1999/5/EC.
Español [Spanish]:	Este equipo cumple con los requisitos esenciales así como con otras disposiciones de la Directiva 1999/5/CE.
Ελληνική [Greek]:	Αυτό το εξοπλισμός είναι σε συμμόρφωση με τις ουσιαστικές απαιτήσεις και άλλες σχετικές διατάξεις της Οδηγίας 1999/5/ΕΚ.
Français [French]:	Cet appareil est conforme aux exigences essentielles et aux autres dispositions pertinentes de la Directive 1999/5/CE.
Íslenska [Icelandic]:	Þetta tæki er samkvæmt grunnkröfum og öðrum viðeigandi ákvæðum Tilköpunar 1999/5/EC.
Italiano [Italian]:	Questo apparato è conforme ai requisiti essenziali ed agli altri principi sanciti dalla Direttiva 1999/5/CE.
Latviski [Latvian]:	Šī iekārta atbilst Direktīvas 1999/5/EK būtiskajām prasībām un citiem ar to saistītiem noteikumiem.
Lietuvių [Lithuanian]:	Šis įrenginys tenkina 1999/5/EB Direktivos esminius reikalavimus ir kitas šios direktyvos nuostatas.
Nederlands [Dutch]:	Dit apparaat voldoet aan de essentiële eisen en andere van toepassing zijnde bepalingen van de Richtlijn 1999/5/EC.
Malți [Maltese]:	Dan l-apparat huwa konformi mal-hiġġiet essenzjali u l-provvedimenti l-oħra rilevanti taq-Direttiva 1999/5/EC.
Magyar [Hungarian]:	Ez a készülék teljesíti az alapvető követelményeket és más 1999/5/EK irányelvben meghatározott vonatkozó rendelkezéseket.
Norsk [Norwegian]:	Dette utstyret er i samsvar med de grunnleggende krav og andre relevante bestemmelser i EU-direktiv 1999/5/EF.
Polski [Polish]:	Urządzenie jest zgodne z ogólnymi wymaganiami oraz szczegółowymi warunkami określonymi Dyrektywą UE: 1999/5/EC.
Português [Portuguese]:	Este equipamento está em conformidade com os requisitos essenciais e outras provisões relevantes da Directiva 1999/5/EC.
Slovensko [Slovenian]:	Ta naprava je skladna z bistvenimi zahtevami in ostalimi relevantnimi pogoji Direktive 1999/5/EC.
Slovensky [Slovak]:	Toto zariadenie je v zhode so základnými požiadavkami a inými príslušnými nariadeniami direktivy: 1999/5/EC.
Suomi [Finnish]:	Tämä laite täyttää direktiivin 1999/5/EY olennaiset vaatimukset ja on sitinä asetettujen muiden laitetta koskevien määräysten mukainen.
Svenska [Swedish]:	Denna utrustning är i överensstämmelse med de väsentliga kraven och andra relevanta bestämmelser i Direktiv 1999/5/EC.

