



ABOVE & BEYOND

CONTENTS

SPECIFICATION

LOCATE A RETAILER

BUILD YOUR OWN

# RANGE ROVER EVOQUE

## 2018



ABOVE & BEYOND



**DEP**  
DEALER ePROCESS







ABOVE & BEYOND

CONTENTS

SPECIFICATION

LOCATE A RETAILER

BUILD YOUR OWN



BY APPOINTMENT TO  
HM THE QUEEN  
MANUFACTURERS OF  
MOTOR VEHICLES  
JAGUAR LAND ROVER LIMITED  
COVENTRY



BY APPOINTMENT TO  
HRH THE DUKE OF EDINBURGH  
MANUFACTURERS OF  
MOTOR VEHICLES  
JAGUAR LAND ROVER LIMITED  
COVENTRY



BY APPOINTMENT TO  
HRH THE PRINCE OF WALES  
MANUFACTURERS OF  
MOTOR VEHICLES  
JAGUAR LAND ROVER LIMITED  
COVENTRY



ABOVE & BEYOND

Ever since the first Land Rover vehicle was conceived in 1947, we have built vehicles that challenge what is possible. These in turn have challenged their owners to explore new territories and conquer difficult terrains. Our vehicles epitomize the values of the designers and engineers who have created them. Each one instilled with iconic British design cues, delivering capability with composure. Which is how we continue to break new ground, defy conventions and encourage each other to go further. Land Rover truly enables you to make more of your world, to go above and beyond.







ABOVE & BEYOND

CONTENTS

SPECIFICATION

LOCATE A RETAILER

BUILD YOUR OWN

THE RANGE ROVER EVOQUE MARKS A BOLD EVOLUTION OF RANGE ROVER DESIGN. WITH ITS DRAMATIC RISING BELTLINE, A MUSCULAR SHOULDER RUNNING THE LENGTH OF THE CAR, AND A DISTINCTIVE TAPER TO THE FLOATING ROOFLINE, THE RANGE ROVER EVOQUE ADOPTS A VERY DYNAMIC PROFILE WITH A POWERFUL AND ATHLETIC STANCE.

Gerry McGovern.  
Land Rover Design Director and Chief Creative Officer.



## CONTENTS

### DESIGN

- Exterior 6
- Convertible Exterior 9
- Five-door and Convertible Interior 10
- Cargo Space Capacity 13
- Convertible Roof 16

### DRIVING TECHNOLOGY

- Testing 18
- Terrain Response® 21
- All Terrain Progress Control 21
- Hill Descent Control (HDC®) 23
- Adaptive Dynamics 25
- Torque Vectoring 25
- Active Driveline 25
- Towing Aids 27

### TECHNOLOGY

- Infotainment 28
- Audio 30
- Connectivity 32
- Driver Assistance 34

### COMFORT FOR ALL

### ENGINES

- 9-speed Automatic Transmission 39
- Ingenium Gas Engines 40

### BODY AND CHASSIS

- Strength and Stability 42

### SAFETY

- 44

### ENVIRONMENTAL

- Sustainability 46

### SPECIFICATIONS

- Choose Your Engine 51
- Choose Your Model and Options 52
- Choose Your Color 76
- Choose Your Wheels 78
- Choose Your Interior 80
- Choose Your Accessories 90

### TECHNICAL DETAILS

- 96

### A WORLD OF LAND ROVER

- 100



Scan to view the Range Rover Evoque in action.

Vehicles shown are from the Land Rover global range. Specifications, options and availability will vary between markets and should be verified with your nearest Land Rover Retailer. Vehicle shown: 2018 Range Rover Evoque Landmark Edition in Moraine Blue.



DESIGN

DRIVING TECHNOLOGY

TECHNOLOGY

COMFORT FOR ALL

BODY AND CHASSIS

SAFETY

ENVIRONMENTAL





ABOVE & BEYOND

CONTENTS

SPECIFICATION

LOCATE A RETAILER

BUILD YOUR OWN

## DESIGN

### EXTERIOR

With its striking lines, muscular shoulder and tapered roof, Range Rover Evoque sets itself apart from its contemporaries.

Whether discovering hidden parts of town or being seen in all the right places, it's always ready for action. Striking the perfect balance between distinctive exterior design, a contoured cabin, capability and performance, it defines contemporary city life.

Optional adaptive full LED headlights complement the vehicle's design cues by combining a distinctive look with enhanced light output. The headlights' adaptive function enables light beams to be automatically aligned with steering inputs and follow curves in the road\*.

The Daytime Running Lights (DRLs) have a distinctive signature which also serves as the directional indicator where it flashes amber.



\*These systems are not a substitute for driving safely with due care and attention and will not function under all circumstances, speeds, weather and road conditions, etc. Driver should not assume that these systems will correct errors of judgment in driving. Please consult the owner's manual or your local authorized Land Rover Retailer for more details.  
Vehicle shown: Range Rover Evoque HSE Dynamic Five-door in Yulong White with optional 20" alloy wheels.



DESIGN

DRIVING TECHNOLOGY

TECHNOLOGY

COMFORT FOR ALL DEALER ePROCESS ENGINES

BODY AND CHASSIS

SAFETY

ENVIRONMENTAL





ABOVE & BEYOND

CONTENTS

SPECIFICATION

LOCATE A RETAILER

BUILD YOUR OWN



## CONVERTIBLE EXTERIOR

Range Rover Evoque has defined the compact SUV with its design cues that have become synonymous with design and contemporary living. The vehicle goes even further with Range Rover Evoque Convertible. A premium compact Convertible SUV, setting new standards in design, capability and sheer driving pleasure.



Vehicle shown: 2018 Range Rover Evoque HSE Dynamic Convertible with Black Design Package in Phoenix Orange.







ABOVE & BEYOND

CONTENTS

SPECIFICATION

LOCATE A RETAILER

BUILD YOUR OWN

## FIVE-DOOR AND CONVERTIBLE

The Range Rover Evoque is available in Five-door and Convertible body styles. The Five-door features a six model line-up including SE, SE Premium, Landmark Edition, HSE, HSE Dynamic and Autobiography. The Convertible is available in SE Dynamic and HSE Dynamic models with a Z-folding Convertible Roof System in Ebony fabric.

The Five-door model ensures practicality while retaining the instantly recognizable design cues of the Range Rover Evoque. The floating roof, rising beltline and athletic form truly reflect life in the city today. The interior space is both thoughtfully planned and superbly finished. Whether taking family or friends around town or heading off to some quiet spot in the countryside for lunch, the vehicle's comfortable seating ensures that all arrive feeling relaxed and ready to go.

Range Rover Evoque Convertible takes the vehicle's inherent capability and superb looks to another level. Its distinctive lines exude confidence, individuality and poise while the spacious interior enables four passengers to travel in comfort.



DESIGN

DRIVING TECHNOLOGY

TECHNOLOGY

COMFORT FOR ALL

BODY AND CHASSIS

SAFETY

ENVIRONMENTAL





ABOVE & BEYOND

CONTENTS

SPECIFICATION

LOCATE A RETAILER

BUILD YOUR OWN



## INTERIOR

The desirability of the exterior design continues inside. The Range Rover DNA is communicated throughout the interior by the superb detailing, strong lines and clean surfaces combined seamlessly with contemporary trim.

A range of individual features provide added appeal to the clean, architectural shapes of the vehicle's interior. The seats incorporate the latest technologies such as climate control options in the front seats to ensure a truly relaxed and comfortable ride. Details include the use of premium materials such as perforated Windsor leather, twin-needle stitching and deeply padded door inserts. Perforated Windsor leather seats are standard on HSE, HSE Dynamic and Autobiography models.

The 10" Touchscreen\* is a superb addition to the interior, becoming the centerpiece of the dash. With a 21:9 wide format and 80 percent more pixels than the standard 8" Touchscreen, the feature is available on SE, SE Premium and Landmark Edition and comes as standard on the HSE, HSE Dynamic, Autobiography and both Convertible models.

### SPORT COMMAND DRIVING POSITION

The Sport Command Driving Position in Range Rover Evoque ensures a greater view of the road ahead so terrains can be tackled with confidence.

\*Driving while distracted can result in loss of vehicle control. Do not operate, adjust or view the navigation or multimedia systems under conditions that will affect your safety or the safety of others. Only use mobile phones and other devices, even with voice commands, when it is safe to do so. Interior shown: 2018 Range Rover Evoque HSE Dynamic Five-door in Ebony with Lunar stitch. Vehicle shown right: 2018 Range Rover Evoque HSE Dynamic Five-door in Yulong White, with optional 20" wheels.





ABOVE & BEYOND

CONTENTS

SPECIFICATION

LOCATE A RETAILER

BUILD YOUR OWN

## CARGO SPACE CAPACITY

The cargo space in the Range Rover Evoque is as functional as well as a stylishly appointed space. All models contain ample luggage room for the perfect weekend getaway or that last minute shopping trip. The five-door body style offers flexible seating which can be easily configured with the rear 60:40 split seating arrangement, or for maximum cargo space, the rear seats can be folded down. When the rear seats are upright, there is a healthy cargo space of 20.3 cu.ft. on the Five-door.

The Convertible tailgate has been designed to allow easy access to the cargo space and even has an optional ski hatch which also doubles as an armrest. The cargo space capacity, 8.9 cu.ft., remains unchanged regardless of the roof position and is able to accommodate a standard golf bag, or a baby stroller.



14 Vehicle and interior shown above: 2018 Range Rover Evoque HSE Dynamic Convertible with Black Design Package in Phoenix Orange. Vehicle shown right: 2018 Range Rover Evoque SE Five-door with optional 20" alloy wheels in Corris Grey.







ABOVE & BEYOND

CONTENTS

SPECIFICATION

LOCATE A RETAILER

BUILD YOUR OWN



## CONVERTIBLE ROOF

The vehicle utilizes a fabric Z-folding Convertible Roof System. It is electrically operated, with opening and closing easily controlled by a switch in the center console; an action that can be completed while the vehicle is traveling up to 30 mph\*. The Ebony roof complements the complete color palette. The roof has an acoustic inner lining to reduce road noise and to provide insulation to the cabin.

The wind deflector improves front seat comfort with the Convertible roof down by reducing drafts from the rear of the cabin.



\*Always follow local speed limits.  
Vehicle shown: 2018 Range Rover Evoque HSE Dynamic  
Convertible with Black Design Package in Phoenix Orange.







ABOVE & BEYOND

CONTENTS

SPECIFICATION

LOCATE A RETAILER

BUILD YOUR OWN

### DRIVING TECHNOLOGY

## TESTING

Before any vehicle can carry the Land Rover badge, it must complete a series of rigorous tests to establish the very highest levels of luxury, performance and capability.



#### SUSPENSION

You're unlikely to push any Land Rover vehicle harder than we have. For an unrivalled breadth of dynamic capability, both on and off-road, the vehicles have been exposed to years of the most extreme driving pressures in a fraction of the time using our state-of-the-art test rig.



#### WIND SPEED

Range Rover Evoque was developed in state-of-the-art wind tunnels and a suite of climatic chambers to recreate some of the most challenging aerodynamic conditions it will face. Only by pushing all systems to their limits do we develop true reliability.



#### HOT AND COLD CLIMATE

In real world environments and our climate chambers, we freeze vehicles to -40°F and bake them to 120°F. Key functions and systems are then scrutinized to our exacting standards. So even in the most remote locations, comfort and peace of mind are never far away.



#### OFF-ROAD

From the icy proving grounds of Arjeplog, Sweden, to Dubai's unforgiving desert sands, we ensure our legendary all-terrain performance is innate in every vehicle. Prototypes are developed across approximately 5,282 miles of the most demanding off-road routes.



#### SEMI-ANECHOIC CHAMBER

In the 'neutral sound' of our semi-anechoic chamber we precisely expose the cabin to a range of frequencies and vibrations, making certain that Range Rover Evoque sounds refined at every speed and across every surface.



#### MONSOON

Our water testing facilities ensure each vehicle can enter and exit a body of water without a single droplet entering the cabin. In the monsoon simulator each one is drenched with some 18,697 gallons of specially dyed water, while tilting it by as much as 45°, checking for even the slightest leak with UV lights.







ABOVE & BEYOND

CONTENTS

SPECIFICATION

LOCATE A RETAILER

BUILD YOUR OWN



## TERRAIN RESPONSE®

Land Rover has always been synonymous with capability and Range Rover Evoque lives up to even the most demanding expectations. Confident and responsive, the drive is further enhanced by a generous wheel articulation and innovative off-road technologies such as Terrain Response®\*.

This feature adapts to the responses of the vehicle's engine, transmission, differentials and chassis systems to enhance driveability, comfort and traction\*.

There are four standard Terrain Response settings: General Driving, Grass/Gravel/Snow, Mud & Ruts and Sand. So, the vehicle feels sure-footed in various terrain or weather conditions\*.

A fifth setting, **Adaptive Dynamics** is standard on the HSE Dynamic Five-door model. This mode tunes the suspension to deliver even tighter body control with flatter handling and sharper responses\*.

 Adaptive Dynamics

 Grass, Gravel, Snow

 Sand

 General Driving

 Mud & Ruts

## ALL TERRAIN PROGRESS CONTROL

All Terrain Progress Control (ATPC) is a state-of-the-art system that enables drivers to set and maintain a steady speed in challenging conditions\*.

Operating like a cruise control system, it functions at very low speeds between 1 mph and 18 mph, helping the driver to maintain concentration on steering and finding a path through obstacles.

In addition, the system enables the vehicle to pull away smoothly and easily, even on tricky low-friction surfaces like snow or wet grass\*.

Developed by Land Rover's all-terrain specialists, it works seamlessly alongside the standard **Terrain Response®**, 4 Wheel Drive (4WD) traction and braking systems\*.

Once ATPC is activated, the standard steering wheel +/- cruise control buttons are used to set the speed. Brake and accelerator pedals can still override the chosen settings.

\*These systems are not a substitute for driving safely with due care and attention and will not function under all circumstances, speeds, weather and road conditions, etc. Driver should not assume that these systems will correct errors of judgment in driving. Please consult the owner's manual or your local authorized Land Rover Retailer for more details. Vehicle shown: 2018 Range Rover Evoque HSE Dynamic Convertible with Black Design Package in Phoenix Orange.





ABOVE & BEYOND

CONTENTS

SPECIFICATION

LOCATE A RETAILER

BUILD YOUR OWN



## HILL DESCENT CONTROL (HDC®)

Land Rover's patented Hill Descent Control (HDC®) is designed to assist the driver with controlled descents of difficult slopes by maintaining a constant speed and applying braking separately to each wheel\*.

**Hill Start Assist** is designed to help prevent the vehicle from rolling backwards as it pulls away on an incline\*.

The vehicle also utilizes **Gradient Release Control (GRC)** which is designed to prevent the vehicle accelerating too quickly on a steep incline when the driver releases the brake\*.

\*These systems are not a substitute for driving safely with due care and attention and will not function under all circumstances, speeds, weather and road conditions, etc. Driver should not assume that these systems will correct errors of judgment in driving. Please consult the owner's manual or your local authorized Land Rover Retailer for more details.  
Vehicle shown left is HSE Five-door in Fuji White.





ABOVE & BEYOND

CONTENTS

SPECIFICATION

LOCATE A RETAILER

BUILD YOUR OWN

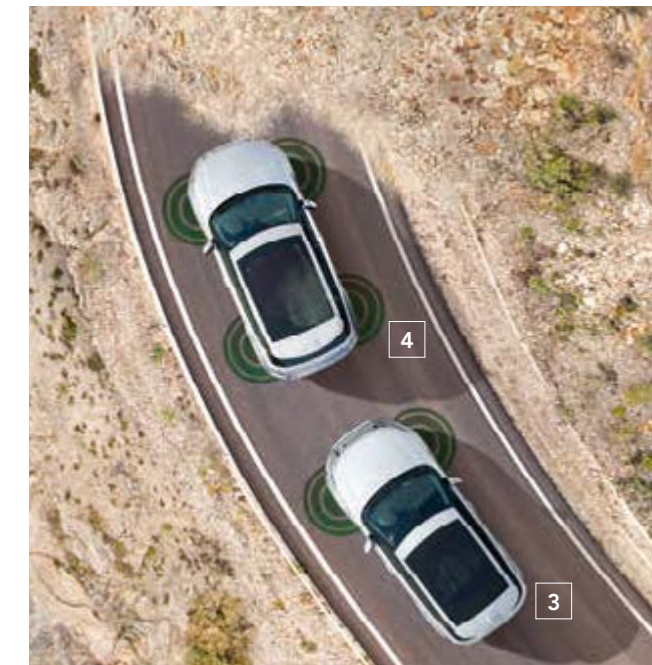

### ADAPTIVE DYNAMICS

Adaptive Dynamics\* with advanced MagneRide™ monitors vehicle movements at least 1,000 times per second, reacting to driver or road inputs instantaneously to give greater control and minimize body lean, providing a balanced, flat ride. Standard on Five-door HSE Dynamic model, the system will even sense off-road conditions and optimize the advanced MagneRide™ damper settings accordingly, delivering the perfect balance of agile handling and a supple, controlled ride\*.

- 1 UNADJUSTED LATERAL BODY LEAN
- 2 CORRECTED LATERAL BODY LEAN

### TORQUE VECTORING

When cornering, the vehicle's agility and stability are enhanced by the Torque Vectoring by Braking system. This feature is standard on all vehicles. Monitoring the vehicle, the system constantly balances the distribution of torque between all the wheels to improve grip and steering whether on or off-road\*.

- A UNDERSTEER DETECTED
- B FULL TORQUE TO OUTER WHEELS
- C BRAKING FORCE TO INNER WHEELS
- D LINE CORRECTED

### ACTIVE DRIVELINE

Active Driveline delivers benefits in both on and off-road situations. In many on-road driving conditions, the system is able to disconnect drive to the rear of the vehicle, providing maximum 2 Wheel Drive (2WD) fuel economy. A sophisticated control strategy continuously monitors key vehicle and environmental parameters.

If the requirements for 4WD are met, the system seamlessly and imperceptibly reconnects drive to the rear of the vehicle within 300 milliseconds. When off-road driving, torque to each rear wheel can be varied according to the available grip. A dedicated display on the Touchscreen relays detailed information, so you always feel in control\*.

- 3 2 WHEEL DRIVE (2WD)
- 4 4 WHEEL DRIVE (4WD) ACTIVATED

\*These systems are not a substitute for driving safely with due care and attention and will not function under all circumstances, speeds, weather and road conditions, etc. Driver should not assume that these systems will correct errors of judgment in driving. Please consult the owner's manual or your local authorized Land Rover Retailer for more details. MagneRide™ is a registered trademark of BWI Company Limited S.A. Vehicle shown is a HSE Dynamic Five-door in Yulong White with optional 20" alloy wheels.





ABOVE & BEYOND

CONTENTS

SPECIFICATION

LOCATE A RETAILER

BUILD YOUR OWN



## TOWING AIDS

With a towing capacity of up to 3,968 lbs on the Five-door and 3,306 lbs on the Convertible, by incorporating tailored technologies, the Range Rover Evoque can handle the most demanding of tasks.

### REAR VIEW CAMERA\*

Providing improved visibility when reversing, the Rear View Camera is a valuable parking aid and offers help when hitching a trailer.

**Tow Hitch Assist** makes coupling a trailer to the vehicle much easier by helping you visualize the hitching process; it displays the predicted path of the vehicle towards the tow bar on the Touchscreen. Standard with Rear View Camera\*.

### SURROUND CAMERA SYSTEM

As part of the Surround Camera System, the Tow Assist feature helps with reversing by predicting the trailer's direction\*. You can even input your trailer's width for precise guidelines displayed on the Touchscreen.

### TRAILER STABILITY ASSIST

Trailer Stability Assist monitors the vehicle to detect movements in the trailer and then uses selective braking to help correct potentially hazardous situations\*.

\*These systems are not a substitute for driving safely with due care and attention and will not function under all circumstances, speeds, weather and road conditions, etc. Driver should not assume that these systems will correct errors of judgment in driving. Please consult the owner's manual or your local authorized Land Rover Retailer for more details.

Please refer to the standard and optional feature listing on page 68. Touchscreen shown is 10" Touch Pro.

Vehicle shown left and above HSE Dynamic Five-door in Yulong White with optional 20" wheels.



DESIGN

DRIVING TECHNOLOGY

TECHNOLOGY

COMFORT FOR ALL DEALER ePROCESS ENGINES

BODY AND CHASSIS

SAFETY

ENVIRONMENTAL





ABOVE & BEYOND

CONTENTS

SPECIFICATION

LOCATE A RETAILER

BUILD YOUR OWN



### TECHNOLOGY

## INFOTAINMENT

Land Rover InControl® is our suite of advanced technologies that links both you and your Range Rover Evoque to the wider world. Choose from two InControl infotainment systems: Touch or Touch Pro\*\*.



### TOUCH

#### STANDARD ON SE, SE PREMIUM AND LANDMARK EDITION MODELS

- 8" Touchscreen
- Land Rover Sound System with 8 speakers
- Protect consists of SOS Emergency Call, Land Rover Optimized Assistance and Remote smartphone app
- Navigation including Voice Recognition\*\*
- InControl Apps features a range of Land Rover approved apps that can be connected to Range Rover Evoque from your smartphone, to enhance aspects of your in-car experience\*\*
- Remote is a multi-function app that allows you to monitor and interact with your vehicle remotely, making life easier and more connected.

#### OPTIONAL

- Sirius XM® Satellite Radio<sup>†</sup> & HD Radio
- Wi-Fi Hotspot<sup>†</sup>.



### TOUCH PRO

#### STANDARD ON HSE, HSE DYNAMIC, AUTOBIOGRAPHY AND CONVERTIBLE MODELS; OPTIONAL ON SE AND SE PREMIUM

- 10" Touchscreen\*\*
- Meridian™ Surround Sound System 380W with 10 speakers plus subwoofer
- Voice Recognition<sup>‡</sup>
- CD/DVD Player
- Protect
- Navigation Pro\*\*
- InControl Apps
- Remote
- Pro Services includes Wi-Fi Hotspot<sup>†</sup>, Route Planner App, Share ETA, Live Services, Commute Mode, Arrival Mode and Arrival Mode Parking.

#### OPTIONAL

- Meridian™ Surround Sound System 660W with 12 speakers plus subwoofer<sup>Δ</sup>
- Meridian™ Surround Sound System 825W with 16 speakers plus subwoofer<sup>‡</sup>
- Sirius XM® Satellite Radio<sup>▲</sup> & HD Radio.



### HEAD-UP DISPLAY

Head-up Display is a technology option, available as part of the Driver Assist Plus Package, that presents key vehicle data such as vehicle speed, gear position and navigation directions on the windshield, without the need for the driver to take their eyes off the road\*.

This innovative laser system is more robust against issues such as 'washout' – the effect that the glare from sunlight has on inferior LED-based systems. The feature can be turned on and off dependent upon driver preference. Available on the HSE model and above.

\*These systems are not a substitute for driving safely with due care and attention and will not function under all circumstances, speeds, weather and road conditions, etc. Driver should not assume that these systems will correct errors of judgment in driving. Please consult the owner's manual or your local authorized Land Rover Retailer for more details. \*\*Do not use Land Rover InControl® features under conditions that will affect your safety or the safety of others. Driving while distracted can result in loss of vehicle control.

Find out more at [landroverusa.com/incontrol](http://landroverusa.com/incontrol)

As Land Rover roll out InControl, specific features described may be optional, and powertrain dependent. Please consult your country-specific Land Rover website or local Land Rover Retailer for availability and full terms in your country. Certain features require an appropriate SIM with a suitable data contract which will require further subscription after the initial term advised by your Land Rover Retailer. Mobile connectivity cannot be guaranteed in all locations.

\*\*Do not use Land Rover InControl® features under conditions that will affect your safety or the safety of others. Driving while distracted can result in loss of vehicle control. Certain features require a Micro SIM with a suitable data contract which will require further subscription after the initial term advised by your Land Rover Retailer. Apple Watch is a registered trademark of Apple Inc., registered in the US and other countries. InControl Apps will need to be downloaded from the Apple/Android Store, please contact your nearest Land Rover Retailer for further information. †The Wi-Fi Hotspot is intended for passenger use only. InControl features may require an additional subscription with separate terms and conditions. ‡Not available on Convertible. ΔOnly available on Convertible. Feature availability will vary by model and body style. Please refer to the standard and optional feature listing on pages 64-81. ▲3-month trial subscription to the Sirius All Access package is included with the vehicle, which gives you access to 150+ channels of premium programming. Plus you can stream SiriusXM on your computer, smartphone or tablet – it's included in your trial. If you decide to continue service after your trial, the subscription plan you choose will automatically renew thereafter and you will be charged according to your chosen payment method at then-current rates. Fees and taxes apply. To cancel you must call SiriusXM at 1-866-635-2349. See the SiriusXM Customer Agreement for complete terms at [siriusxm.com](http://siriusxm.com). All fees and programming are subject to change. SiriusXM Satellite Radio is not available in Alaska or Hawaii.

Vehicle shown left is Autobiography Five-door in Firenze Red.







ABOVE & BEYOND



## AUDIO

Delivering exceptionally clear audio, the Range Rover Evoque offers you the choice of three sound systems. With 8 speakers, the Land Rover Audio System in Range Rover Evoque SE, SE Premium and Landmark Edition delivers a crisp, well-balanced sound.

Added to which, Land Rover has partnered with Meridian™, a world leader in high-performance audio technologies and digital sound processing, to develop advanced audio systems for Range Rover Evoque.

Dynamic Volume Control technology has been integrated on all Meridian Sound Systems, to ensure that any unwanted noise detected in the cabin will be smoothly and automatically balanced out.

The Meridian Sound System (380W) features 10 speakers and a dual channel subwoofer, delivering exceptional definition, crystal clear highs and full, deep bass through the careful arrangement of speakers.

This 10 speaker system and a dual channel subwoofer, optional on SE, SE Premium and Landmark Edition and standard on HSE, HSE Dynamic and both Convertible models adds further depth and clarity.

Range Rover Evoque also offers an optional upgrade, the Meridian Surround Sound System, which produces 660W through 12 speakers and a dual channel subwoofer on the HSE Dynamic Convertible, and 825W through 16 speakers and a dual channel subwoofer standard on the Five-door Autobiography and optional on HSE, HSE Dynamic models only.

These systems also include Meridian Trifield™ technology. This technology delivers the very best in world-class audio reproduction, bringing you closer to the original performance regardless of your position in the vehicle; everyone will feel and hear pure musical enjoyment.

Meridian is a trademark of Meridian Audio Limited.  
Trifield™ and the "three fields" device is a trademark of Trifield Productions Ltd.  
Vehicles shown right are an HSE Dynamic Five-door in Fuji White and HSE Dynamic Convertible in Phoenix Orange.

CONTENTS

SPECIFICATION

LOCATE A RETAILER

BUILD YOUR OWN

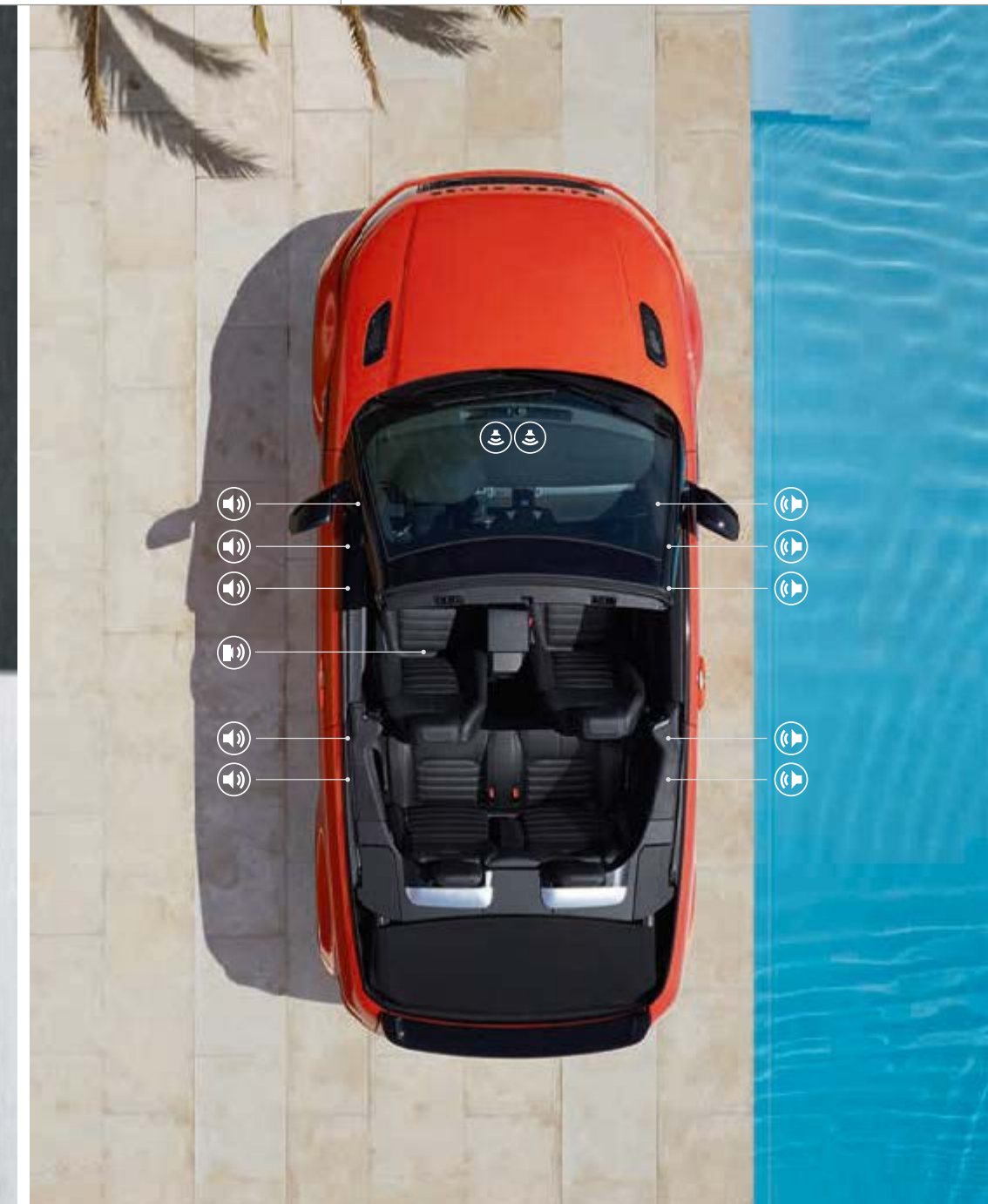

MERIDIAN SURROUND SOUND SYSTEM

825 WATTS

16 SPEAKERS

SUBWOOFER

660 WATTS

12 SPEAKERS

SUBWOOFER







ABOVE & BEYOND

## CONNECTIVITY

Touch and Touch Pro provide a wealth of information and entertainment. This intuitive Land Rover InControl® technology can suggest nearby parking, stream your favorite music and even help you with the recovery of a stolen vehicle. Making life more rewarding, hassle-free and enjoyable\*\*.



### PLANNING ROUTES

Before setting off, use the **Route Planner** app or online portal to search, save locations or set your destination. The app uses the Cloud to send your destination automatically to your vehicle's navigation screen. Only available with Touch Pro\*\*.



### STAYING CONNECTED

Before you get into your vehicle, set your ideal cabin temperature with the **Remote** app on smartphones and now the Apple Watch. Standard with Touch and Touch Pro. On the road, the in-car **Wi-Fi Hotspot** provides a stable Internet connection and lets you connect up to eight devices. Optional with Touch†.

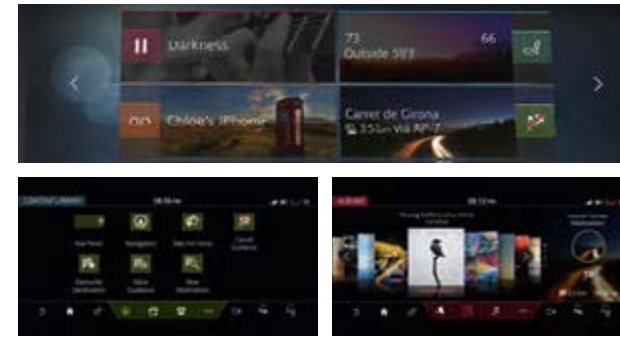

### MOVING FASTER

**Touch Pro** brings you more processing power, thanks to a quad core processor plus an integrated Ethernet network\*\*. Customizable home screens let you arrange the screen, as you like, with up to four personalized home screens and over 60 shortcuts.



### INTELLIGENT ROUTING

**Commute Mode** allows the system to learn your commutes and automatically advises you of the expected travel time based on live and historical traffic movements without having to input a destination. The system learns the routes you take for a given destination and then advises which of those is the quickest. Only available with Touch Pro.

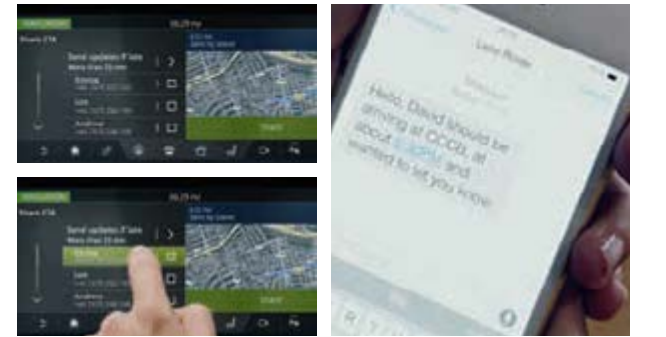

### SHARING PROGRESS

Share your estimated time of arrival so your selected contact(s) will know exactly when you will arrive, as calculated by the navigation guidance system. If you're running late, **Share ETA** can then send automatic updates via text or email, without any further action from you\*\*. Only available with Touch Pro.



### STAYING FOCUSED

Our Touch Pro **Voice Recognition\*** system understands normal spoken instructions. So you can concentrate on the road ahead without any distractions. Only available with Touch Pro\*\*.



### FINDING PARKING

When you near your destination, **Navigation Pro** will suggest nearby parking from a database including space availability. With just one click, the parking is added and your route is updated. **Arrival Mode Parking** shows a 360° street level image to help you identify your destination. Only available with Touch Pro\*\*.

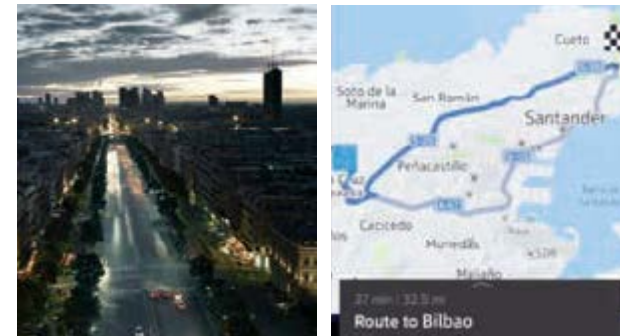

### DOOR-TO-DOOR

Once you've parked, the **Route Planner** app will guide you to your destination – a true door-to-door experience which includes public transportation options. Only available with Touch Pro. The **Remote** app also lets you check your vehicle to make sure you've locked and secured all doors and windows. Standard with Touch and Touch Pro.



### HELP IS ALWAYS AT HAND

With **Protect**, emergency services will be automatically notified if the airbags are deployed in an accident or you can call them manually via an in-car button. You can also summon a Land Rover Optimized Assistance operator should you need technical assistance. Standard with Touch or Touch Pro.

InControl® features, options and their availability remain powertrain dependent – check with your Land Rover Retailer for availability and full terms. Certain features require the fitment of Connect Pro and a Micro SIM with a suitable data contract which will require further subscription after the initial term advised by your Land Rover Retailer. Apple Watch® is a registered trademark of Apple Inc., registered in the US and other countries. Mobile network connectivity cannot be guaranteed in all locations. InControl Apps will need to be downloaded from the Apple/Android Store, please contact your nearest Land Rover Retailer for further information.

\*Not available on Convertible \*\*Do not use Land Rover InControl® features under conditions that will affect your safety or the safety of others. Driving while distracted can result in loss of vehicle control †The Wi-Fi Hotspot is intended for passenger use only. InControl features may require an additional subscription with separate terms and conditions.



ENGINES

DESIGN

DRIVING TECHNOLOGY

TECHNOLOGY

COMFORT FOR ALL

BODY AND CHASSIS

SAFETY

ENVIRONMENTAL





ABOVE & BEYOND

CONTENTS

SPECIFICATION

LOCATE A RETAILER

BUILD YOUR OWN



**LANE KEEP ASSIST WITH AUTONOMOUS EMERGENCY BRAKING AND DRIVER CONDITION MONITOR\***

Lane Keep Assist is designed to detect when your vehicle is unintentionally drifting out of your lane, and to gently steer you back. Driver Condition Monitor is designed to detect if you're starting to feel drowsy and to give you an early warning when you need to take a break. If a potential collision is detected, the Autonomous Emergency Braking system displays a forward collision warning, giving you time to take action. If a collision is still anticipated and you have taken no action, this system will apply the brakes to help reduce the severity of the possible impact.



**ADAPTIVE CRUISE CONTROL WITH QUEUE ASSIST AND INTELLIGENT EMERGENCY BRAKING\***

When you're cruising on the highway or traveling in slow-moving traffic, this system will keep your vehicle a set distance from the one in front should it slow or stop. Should the vehicle in front stop completely, your vehicle is designed to come to a smooth halt. Once the traffic moves, simply touch the accelerator and Adaptive Cruise Control will resume following the car in front. The system can be set from 20 mph up to highway speeds. Once set it can operate at lower speeds up to when the vehicle is stationary with Queue Assist.



**ADAPTIVE LED HEADLIGHTS WITH LED SIGNATURE\***

Full LED headlights deliver an enhanced light output for improved visibility at night. Light beams automatically align with steering inputs and follow curves in the road.



**BLIND SPOT MONITOR WITH REVERSE TRAFFIC DETECTION\***

Blind Spot Monitor is designed to alert you to vehicles in, or quickly approaching, your blind spot through a small warning light in the corresponding door mirror. Reverse Traffic Detection is designed to warn you of hazards approaching from either side of your vehicle, through both audible and visual warnings so you know what's behind you even when the view is obstructed.

PARKING AIDS

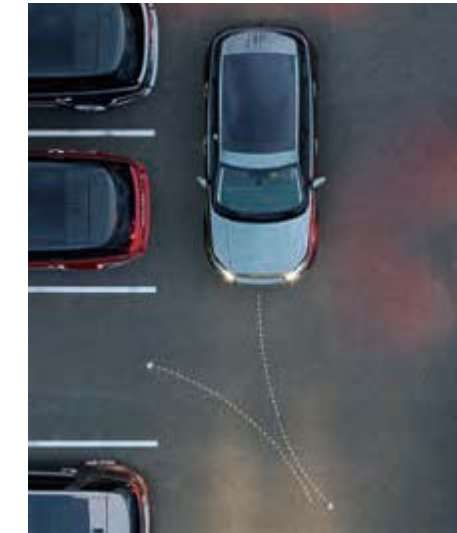

**PARK ASSIST\***

Our Park Assist system makes parallel and perpendicular parking easier than ever by automatically steering your vehicle into a suitable space. You just have to select the appropriate gear and control the vehicle's speed with the brake and accelerator pedals. Graphics and notifications guide you through the maneuvers. Park Assist will also steer you out of a parallel space, helping reduce the stress of parking.

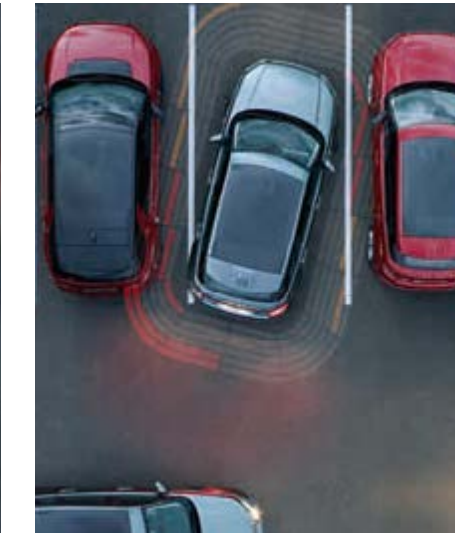

**360° PARKING AID\***

Our 360° Parking Aid gives you complete confidence when maneuvering in tight spaces. Sensors located around the car are automatically triggered when reverse is selected, or can be manually activated with a graphic appearing on the Touchscreen showing an overhead view of the car. As you park, the Touchscreen display and audio feedback indicates how close you are to obstacles.



**SURROUND CAMERA SYSTEM\***

Using four digital cameras discreetly placed around the vehicle, the system provides an almost complete 360° view including a birds-eye overhead view via the Touchscreen. This helps with various maneuvers from parking by a curb, to getting in and out of tight spaces and intersections.



**GARAGE DOOR OPENER (HOMELINK®)**

The HomeLink® System is a universal transmitter fitted to the underside of the interior rear view mirror. This transmitter can be programmed to operate up to three home or office wireless controlled systems, such as garage doors, gates, or security lighting. By replacing the individual remote control units normally required for each system, the driver no longer needs to search the car interior for the correct handset when needed.

\*These systems are not a substitute for driving safely with due care and attention and will not function under all circumstances, speeds, weather and road conditions, etc. Driver should not assume that these systems will correct errors of judgment in driving. Please consult the owner's manual or your local authorized Land Rover Retailer for more details.

HomeLink® is the registered trademark of Gentex Corporation. Features and their availability may differ by vehicle specification and market. Please see pages 64-81, or contact your nearest Land Rover Retailer, for more information.







ABOVE & BEYOND

CONTENTS

SPECIFICATION

LOCATE A RETAILER

BUILD YOUR OWN



## COMFORT FOR ALL

### SEATING

Heated front seats are standard on HSE and HSE Dynamic and, for rear passengers, Five-door body styles can also be specified with optional heated rear seats.

No matter what the temperature, optional heated and cooled front seats are also available on both body styles. This enables both the driver and passenger to set their preferred temperature independently and is controlled via the Touchscreen.

For the ultimate in comfort, massaging front seats are standard on the Autobiography model allowing both the driver and front passenger to select individual programs via the Touchscreen. Varying in intensity, there are five settings to choose from; each one delivers a soothing massage to improve both the driver and passenger's comfort.

### CONFIGURABLE AMBIENT INTERIOR LIGHTING

New levels of ambient refinement and personalization have been reached with Configurable Ambient Interior Lighting – standard on HSE, HSE Dynamic and Autobiography models.

This feature allows you to vary the color and shade, changing the ambience of the cabin to suit your mood. There are ten colors in total, ranging from Ice White through to Moonlight and Racing Red.

### POWERED GESTURE TAILGATE

The optional powered gesture tailgate allows you to operate the tailgate (both to open and close) from outside the vehicle without needing to physically touch the vehicle or the smart key.

Provided that the smart key is detected, the tailgate may be operated by a kicking gesture underneath the rear of the vehicle. Two sensors are mounted on either side of the tailgate to allow curbside operation, rather than needing to be immediately behind the vehicle. And as the system is compatible with towing solutions, you can still open and close the tailgate with the least amount of fuss. Powered gesture tailgate is not available on Convertible models.

Additionally, if required, the tailgate can also be closed by pressing a button located on the inside of the tailgate. Or, by pressing a button on the smart key.

### PANORAMIC ROOF

On Five-door body style, the full glass fixed panoramic roof, standard on SE Premium and up, enhances the sense of space in the vehicle's interior and floods it with natural light as well as providing uninterrupted views of the surrounding environment.

Importantly, the toughened glass has a dark tint to maintain a comfortable temperature inside the cabin and protect occupants and the interior from the sun's rays. A full-sized, powered interior blind is also provided for those who may prefer a more private experience.







ABOVE & BEYOND

CONTENTS

SPECIFICATION

LOCATE A RETAILER

BUILD YOUR OWN



### ENGINES

## 9-SPEED AUTOMATIC TRANSMISSION

The lightweight, compact 9-speed Automatic Transmission provides optimum fuel economy and CO<sub>2</sub> emissions as well as greater control in low-grip conditions or when towing through the specially designed, ultra-low first gear.

The transmission is specifically designed for transverse applications, and is one of the most efficient and technically advanced ever used in a production vehicle. Two patented dog clutches replace the bulkier conventional set-up, allowing small ratio steps to give better response during acceleration, plus improved shift quality, drive and refinement.

The higher top gear not only reduces fuel consumption but the lower engine revs improve comfort and reduce noise when cruising at a sustained speed. The 9-speed Automatic Transmission is extremely robust and perfectly complements Land Rover's rugged all-terrain ability while delivering exceptionally high levels of refinement.

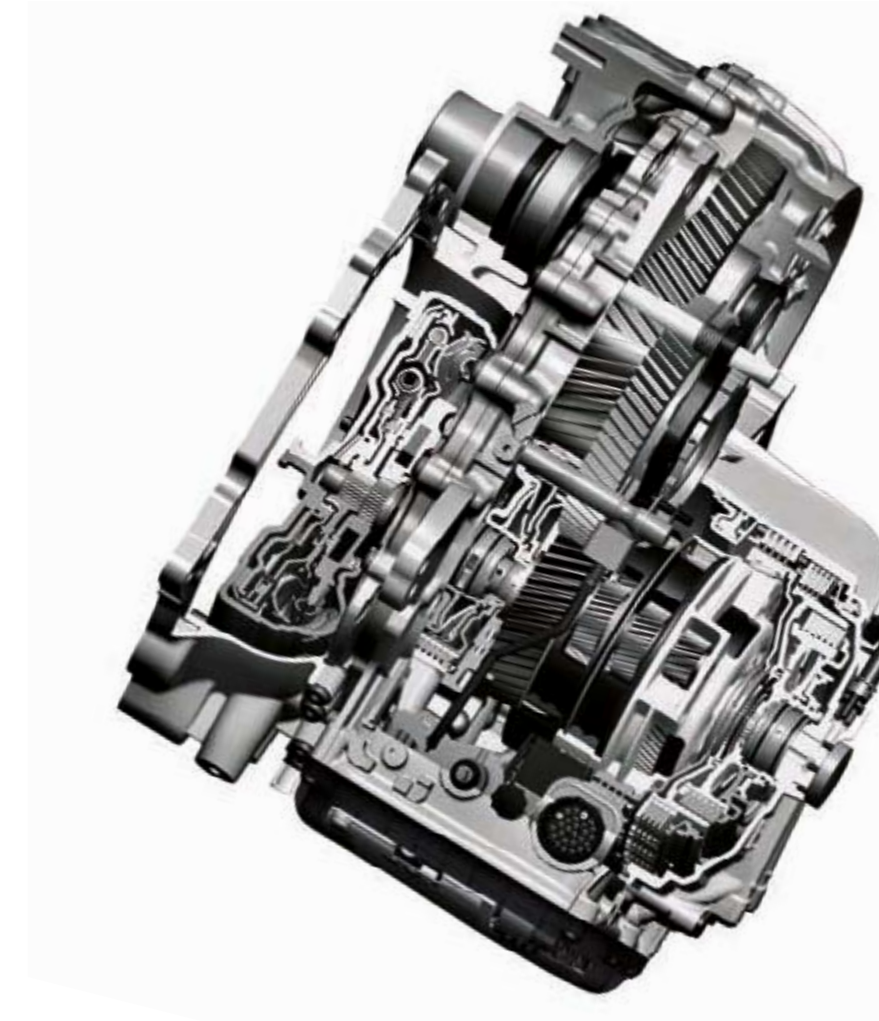

Vehicle shown left is HSE Dynamic Five-door in Yulong White with optional 20" wheels.



DESIGN

DRIVING TECHNOLOGY

TECHNOLOGY

COMFORT FOR ALL

BODY AND CHASSIS

SAFETY

ENVIRONMENTAL





ABOVE & BEYOND

CONTENTS

SPECIFICATION

LOCATE A RETAILER

BUILD YOUR OWN



## INGENIUM GAS ENGINES

### Si4 237HP

The Ingenium 2.0 liter 4-cylinder 237HP Turbocharged Gas engine produces 251 lb-ft of torque and delivers outstanding driveability.

- The intelligent Continuously Variable Valve Lift (CVVL) system varies the extent to which inlet valves are opened, reducing engine-pumping losses. This lets the engine 'breathe' with maximum efficiency, optimizing power and torque.
- CVVL works in combination with dual independent variable cam timing for ultimate operating flexibility, resulting in better power across the rev range.
- For excellent acceleration and effortless overtaking, maximum torque is available at 1,250 rpm.
- The twin scroll turbocharger is fed by an integrated exhaust manifold which increases the transfer of energy to the turbine - significantly reducing turbo lag and improving engine response.

### Si4 286HP†

The high performance Ingenium 286HP 2.0 liter 4-cylinder Turbocharged Gas engine features upgrades to the boosting system.

- Delivering a peak torque of 295 lb-ft at 1,500 rpm.
- The uprated turbocharger features a high flow compressor wheel delivering 26% more air, enabling a peak power output of 286HP.
- The twin-scroll turbocharger features ceramic ball-bearings which reduces friction and improves transient response.



	ACCELERATION 0-60 MPH (SECONDS)*	TOP SPEED (MPH)*
<b>Si4 - 237HP</b>		
Five-door	6.9	135
Convertible	7.6	135
<b>Si4 - 286HP</b>		
Five-door	6.0	144**

\*Always follow local speed limits \*\*If vehicle fitted with 18" wheels the top speed will be 137 mph †The high powered Si4 286HP engine performs at a higher level. A unique bumper has been engineered to allow increased airflow in the air curtains to satisfy the necessary levels demanded by the upgraded turbo making fog lights unavailable.







ABOVE & BEYOND

CONTENTS

SPECIFICATION

LOCATE A RETAILER

BUILD YOUR OWN

## BODY AND CHASSIS

# STRENGTH AND STABILITY

### BODY

Range Rover Evoque features a strong body structure which has been developed using advanced, weight-saving materials to deliver outstanding stiffness and refinement.

The structure is based on a steel monocoque platform. Delivering the exciting design and sporting dynamics of Range Rover Evoque dictated that a new structure was developed.

Lightweight technologies are used extensively in the body design, including:

- Front fenders and tailgate assembly
- Magnesium cross car beam
- Optimized steel structure using high strength boron steels.

### CHASSIS AND VEHICLE DYNAMICS

Range Rover Evoque has a chassis which has been specially developed by Land Rover's engineers to deliver on-road dynamics which combine sporting and agile responses with impressive refinement, while not compromising all-terrain capability.

Range Rover Evoque has a fully independent suspension, with coil sprung struts front and rear, and isolated front and rear subframes, mounted to an exceptionally stiff steel monocoque bodyshell. The performance of the base suspension system is supplemented by advanced technologies such as an intelligent 4 Wheel Drive (4WD) system\*.

The chassis features a number of innovations, such as Electric Power Assisted Steering (EPAS)\*, which help the vehicle achieve its unique dynamic character.

### OPTIMIZED STRUCTURE

The use of special ultra-high-strength steels in strategic load-bearing areas was a key design objective. The finished steel structure uses 18 percent (by weight) of high strength boron steels. These specialized steels deliver increased strength in critical areas, without the need to increase the thickness and weight of the pressings.

The ultra-high-strength boron steel has been used in key parts of the crash safety cell, including the A-pillars and sills. The Five-door body style also features B-pillars constructed of ultra-high-strength boron steel. The resulting structure is designed to protect occupants using a strong and stable cell, and provides a stiff platform for superior refinement and vehicle dynamics.

The use of ultra-high-strength boron steel in the A-pillar was critical in retaining the slim, raked pillar of the vehicle, without compromising the strength of the structure.

The crash structure was optimized using state-of-the-art computer simulation tools, which allowed engineers to conduct 'virtual' collision tests long before physical prototypes were available.

The Convertible steel body structure is further optimized using high tech materials to ensure the high strength structure.

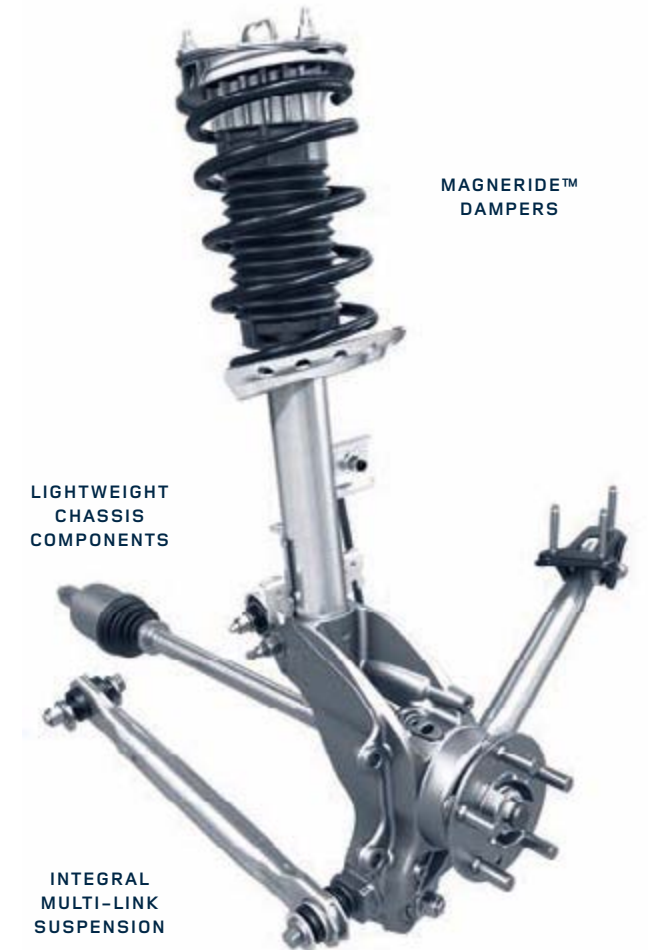

MAGNERIDE™ DAMPERS

LIGHTWEIGHT CHASSIS COMPONENTS

INTEGRAL MULTI-LINK SUSPENSION

\*These systems are not a substitute for driving safely with due care and attention and will not function under all circumstances, speeds, weather and road conditions, etc. Driver should not assume that these systems will correct errors of judgment in driving. Please consult the owner's manual or your local authorized Land Rover Retailer for more details.







ABOVE & BEYOND

### SAFETY

As with every Land Rover, safety is a key priority in Range Rover Evoque. State-of-the-art Dynamic Stability Control and Roll Stability Control systems are designed to detect losses of traction and to react to keep the vehicle on course and reduce the possibility of roll-over. In the unlikely event of a roll-over situation, the roll-over<sup>†</sup> protection system of the Range Rover Evoque Convertible deploys two aluminum bars vertically from the rear bodywork within 90 milliseconds to create a space for occupants.

Each model of the range features a comprehensive occupant safety features, including seat belt pretensioners, driver and passenger airbags and a driver knee airbag. In addition, the Five-door comes with thorax and side curtain airbags<sup>\*†</sup>, and the Convertible offers combined head thorax side airbags<sup>\*\*†</sup>.

#### PASSENGER SEAT BELT CHECK SYSTEM



#### CURTAIN AIRBAGS<sup>\*†</sup> WITH ROLLOVER SENSING

In the event of a side impact or rollover, these are deployed to provide greater protection against head injuries.

#### FRONTAL AIRBAGS<sup>†</sup>

In a severe impact the driver and passenger airbags inflate to offer supplementary occupant protection.

#### DRIVER KNEE AIRBAG<sup>†</sup>

The driver knee airbag inflates in the event of a frontal impact, providing additional protection to the occupants' lower legs.

CONTENTS

SPECIFICATION

LOCATE A RETAILER

BUILD YOUR OWN

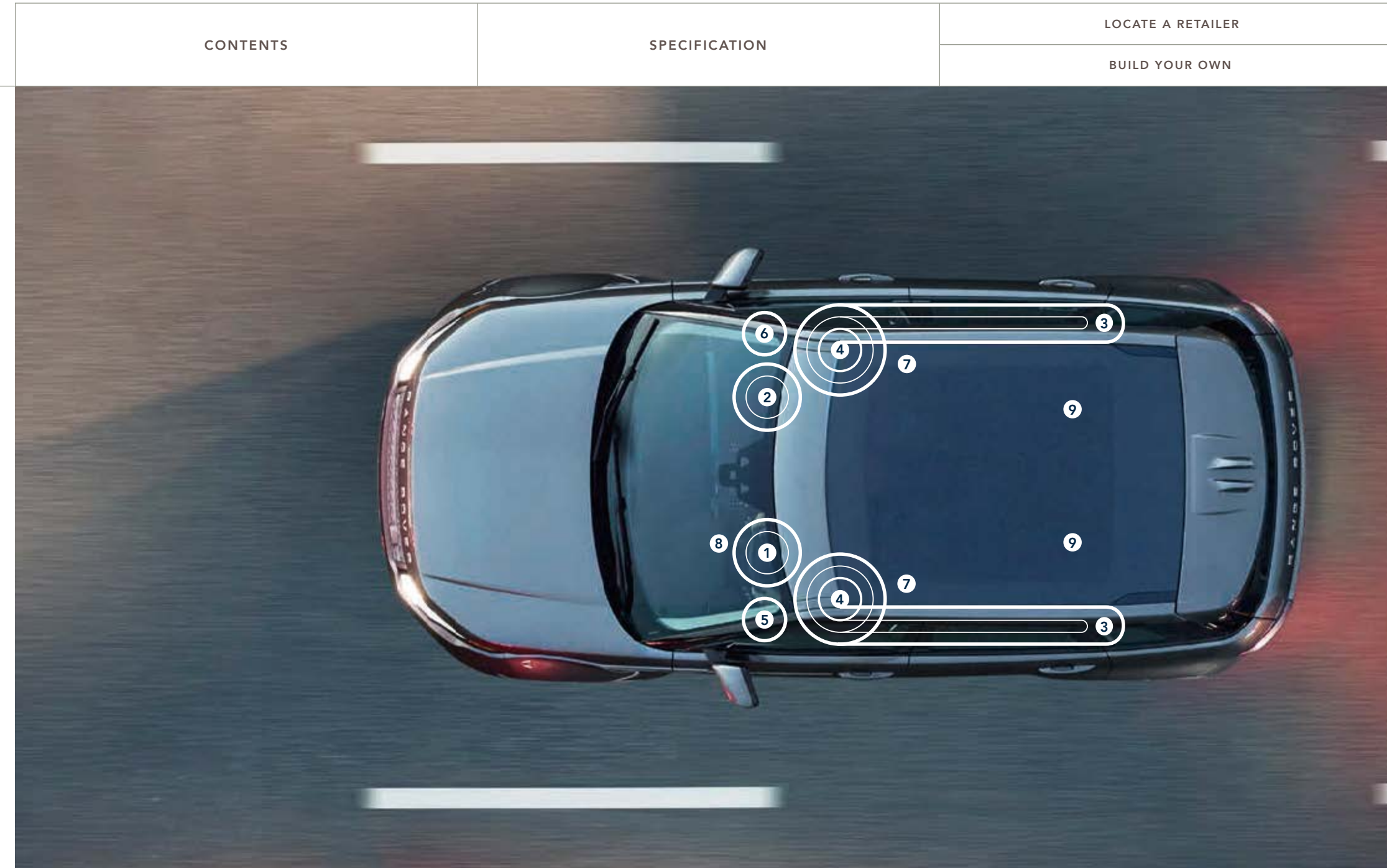

#### SAFETY SYSTEMS

- 1 DRIVER AIRBAG
- 2 PASSENGER AIRBAG
- 3 SIDE CURTAIN AIRBAGS\*
- 4 SIDE THORAX AIRBAGS\*\*
- 5 DRIVER KNEE AIRBAG
- 6 AIRBAG DEACTIVATION SWITCH FOR FRONT PASSENGER
- 7 SEAT BELT PRETENSIONERS
- 8 SEAT BELT REMINDER
- 9 LATCH POINTS

\*Not available on Convertible. \*\*Convertible incorporates a combined head thorax airbag, providing head protection as well as thorax protection. †Please remember that the safety belts in a vehicle constitute the primary protection system for driver and passengers in collisions. Airbags are not designed to deploy in all collisions. The airbag Supplemental Restraint System (SRS) is a supplement to the safety belts and is designed to work as a system with the safety belts. Although airbags provide additional protection, airbags without safety belts do not provide optimal protection in a crash. Always wear your safety belts. Children younger than 13 years old should always be properly restrained in a back seat, away from airbags. Never place an infant seat in the front seat. ‡These systems are not a substitute for driving safely with due care and attention and will not function under all circumstances, speeds, weather and road conditions, etc. Driver should not assume that these systems will correct errors of judgment in driving. Please consult the owner's manual or your local authorized Land Rover Retailer for more details.







ABOVE & BEYOND

CONTENTS

SPECIFICATION

LOCATE A RETAILER

BUILD YOUR OWN

ENVIRONMENTAL

# SUSTAINABILITY

Range Rover Evoque is the most compact Range Rover yet. Its credentials stem from a comprehensive approach to reducing environmental impact throughout the life-cycle of the vehicle. Its size has helped Range Rover Evoque minimize weight, improve aerodynamic performance, and deliver more sporting, agile handling with a lower center of gravity.

Such radical thinking and production processes bear testimony to Land Rover's unwavering commitment to deliver a more sustainable future.



### LIGHTWEIGHT MATERIALS

Starting at just 3,865 lbs and using a range of advanced lightweight materials, Range Rover Evoque is the lightest Range Rover ever. There are key weight-saving materials throughout the vehicle, including a magnesium cross car beam, aluminum hood and, on the Five-door body style, also the roof. The front fenders and tailgate assembly are constructed from composite materials.

Even the laminated windshield is reduced in weight to help improve fuel efficiency, performance and handling.

### STOP/START

All engines feature intelligent Stop/Start technology that automatically shuts down the engine at rest and starts it again as soon as the brake pedal is released. This feature helps to reduce CO<sub>2</sub> emissions.

### LIFE CYCLE ASSESSMENT

In order to minimize the vehicle's overall ecological impact, Range Rover Evoque is designed with a life cycle approach, aiming to minimize the environmental impact by considering the entire life cycle of the vehicle: from development and manufacturing, through customer use, to end-of-life recycling and re-use. Each element of the life cycle was analyzed with a view to consuming fewer natural resources, using more sustainable materials and minimizing the generation of waste.



Vehicle shown left is HSE Dynamic Five-door in Yulong White with optional 20" wheels.







ABOVE & BEYOND

CONTENTS

SPECIFICATION

LOCATE A RETAILER

BUILD YOUR OWN

RANGE ROVER EVOQUE OFFERS YOU GREAT OPTIONS AND FLEXIBILITY TO PERSONALIZE YOUR VEHICLE.

The following pages take you through a logical series of steps to make your vehicle a true expression of your individuality. You have a number of choices: from selecting your engine and model to exterior and interior colors, wheels, finishes and those detailed touches that define your character.

If you'd like to bring your options to life, go to our online configurator at [landroverusa.com](http://landroverusa.com)

50-51

1

**STEP 1  
CHOOSE YOUR ENGINE**

52-75

2

**STEP 2  
CHOOSE YOUR MODEL  
AND OPTIONS**

Compare the standard and optional features on each model.

76-77

3

**STEP 3  
CHOOSE YOUR COLOR**

There's a wide range to enable you to express yourself.

78-79

4

**STEP 4  
CHOOSE YOUR WHEELS**

There's a range of styles, each one designed to complement the bold exterior.

80-89

5

**STEP 5  
CHOOSE YOUR INTERIOR**

When you choose your interior, you can personalize it by selecting your ideal color combination of seats, materials and your preferred finishes. These three considerations help celebrate and enhance a sense of your own style.

90-95

6

**STEP 6  
CHOOSE YOUR  
ACCESSORIES**

Additional accessories can enhance your personal requirements.

96-99

**TECHNICAL DETAILS**

Technical information and data for dimensions, performance and specifications.







ABOVE & BEYOND

CONTENTS

SPECIFICATION

LOCATE A RETAILER

BUILD YOUR OWN

STEP 1  
CHOOSE YOUR ENGINE

1



### DRIVELINE AND ENGINE PERFORMANCE

The powerful Ingenium Gas Si4 286HP engine goes from 0-60 mph in just 6.0 seconds\*\*. All engines feature intelligent Stop/Start technology, automatically shutting down the engine at rest when possible, and re-starting it again as soon as you lift your foot off the brake.

POWER (HP)	GAS	
	2.0L Si4	
	AUTOMATIC 237	AUTOMATIC 286*
Driveline	4 Wheel Drive (4WD)	4 Wheel Drive (4WD)
Maximum power hp / rpm	237 / 5,500	286 / 5,500
Maximum torque lb-ft / rpm	340 / 1,250	400 / 1,500
Capacity (cc)	1,998	1,998
No. of cylinders	4	4
Valves per cylinder	4	4
Cylinder layout	In-line	In-line

### MODELS BY ENGINE

	SE	SE PREMIUM	LANDMARK EDITION	HSE	HSE DYNAMIC	AUTOBIOGRAPHY	SE DYNAMIC (CONVERTIBLE)	HSE DYNAMIC (CONVERTIBLE)
2.0L Si4 Gas (237HP)	■	■	■	■	■	■	■	■
2.0L Si4 Gas (286HP)					■	■		



\*Not available on Convertible \*\*Always follow local speed limits. Vehicle shown left is HSE Five-door in Fuji White.





ABOVE & BEYOND

CONTENTS

SPECIFICATION

LOCATE A RETAILER

BUILD YOUR OWN

STEP 2  
CHOOSE YOUR MODEL AND OPTIONS

# 2

## EACH MODEL HAS A CHOICE OF ENGINES AND UNIQUE FEATURES

This guide will help you to select your ideal Range Rover Evoque. On the following pages you'll see the key standard features for each model.

### RANGE ROVER EVOQUE SE



- Atlas grille surround
- Rain sensing windshield wipers
- Auto-dimming interior rear view mirror
- Front & Rear Parking Aid\*
- Ambient Interior Lighting
- Rear center armrest
- Carpet mats
- Body-colored door handles and mirror caps
- Brunel fender vents
- 18" 5 split-spoke 'Style 506' alloy wheels
- Power fold, heated door mirrors with approach and puddle lights
- 12-way electric front seats
- Grained leather seats
- White Silver inner tow eye finisher
- Halogen headlights
- 8" Touchscreen\*\*.

### RANGE ROVER EVOQUE SE PREMIUM



- Contents of SE, plus:
- Fixed panoramic roof
- Memory front seats and door mirrors
- Powered gesture tailgate
- Keyless Entry
- Front fog lights.

- Replaces SE content:
- Narvik Black grille, fender vents and mirror caps
- Anthracite inner and Dark Techno Silver outer front and rear tow eye finishers<sup>†</sup>
- Xenon headlights with LED signature and power wash
- Narvik Black tailgate finisher
- 18" 7 spoke 'Style 706' alloy wheels
- Perforated grained leather seats.

### RANGE ROVER EVOQUE HSE



- Contents of SE Premium, plus:
- Chrome treadplates
- Blind Spot Monitor with Reverse Traffic Detection<sup>††</sup>
- Automatic High Beam Assist (AHBA)<sup>††</sup>.

- Replaces SE Premium content:
- Dark Atlas grille
- Atlas fender vents and tailgate finisher
- White Silver inner front and rear tow eye finishers
- 19" 10 spoke 'Style 103' alloy wheels

- Configurable Ambient Interior Lighting
- Perforated Windsor leather seats with heated front driver/passenger
- Meridian™ Sound System 380W with 10 speakers plus subwoofer (Touch Pro)
- 10" Touchscreen<sup>††</sup>
- Navigation Pro.







ABOVE & BEYOND

CONTENTS

SPECIFICATION

LOCATE A RETAILER

BUILD YOUR OWN

STEP 2  
CHOOSE YOUR MODEL AND OPTIONS

RANGE ROVER EVOQUE HSE DYNAMIC



- Contents of HSE, plus:
- Dynamic body style
  - Narvik Black hood vents
  - Bright square exhaust finisher
  - Perforated Windsor leather steering wheel
  - Bright pedals.

- Replaces HSE content:
- Narvik Black grille
  - Corris Grey grille surround\*
  - Narvik Black fender vents and mirror caps
  - Narvik Black inner and Corris Grey outer front and rear tow eye finishers\*
  - Body-colored door handles
  - Narvik Black tailgate finisher
  - 19" 7 split-spoke 'Style 707' alloy wheels
  - Illuminated aluminum front treadplates with Range Rover script.

RANGE ROVER EVOQUE AUTOBIOGRAPHY



- Contents of HSE Dynamic, plus:
- Heated windshield
  - Park Assist
  - Lane Keep Assist with Lane Departure Warning, Autonomous Emergency Braking and Driver Condition Monitor\*\*
  - Adaptive LED headlights\*\* with LED signature
  - Heated steering wheel
  - Surround Camera System\*\*.
- Replaces HSE Dynamic content:
- Autobiography badging
  - Atlas grille, fender vents, hood vents and tailgate finisher
  - Indus Silver inner and outer front tow eye finisher\*

- Narvik Black inner and Indus Silver outer rear tow eye finishers\*
- Unique 20" 5 split-spoke 'Style 527' alloy wheels
- Full Windsor leather interior
- Premium carpet mats
- Illuminated aluminum front treadplates with Autobiography script
- 14-way electric memory heated and cooled front seats with massage and heated rear seats
- Meridian™ Surround Sound 825W with 16 speaker plus subwoofer (Touch Pro).

LANDMARK EDITION



Delivering true standout style, the Landmark Edition comes in three colors – Yulong White, Corris Grey and Moraine Blue is all new and limited to Landmark Edition – all featuring the Carpathian Grey contrast roof as standard. Its dynamic body style offers unique 19" 7 split-spoke 'Style 707' alloy wheels with Gloss Dark Grey finish and Graphite Atlas trim throughout. Its distinctive interior features grained leather in Ebony with Lunar stitch and a striking Dark Satin Brushed Aluminum finisher.

- Landmark Edition standard features include:
- Dynamic body style
  - 19" 7 split-spoke 'Style 707' with Gloss Dark Grey finish
  - Carpathian Grey contrast roof
  - Dark Satin Brushed Aluminum trim finisher
  - Keyless Entry\*\*
  - Powered gesture tailgate
  - Panoramic roof

- Land Rover Sound System with 8 speakers including Touch
- 8" Touchscreen<sup>1</sup>
- Graphite Atlas fender vents, hood vents, grille, grille surround and hood and tailgate script
- Graphite Atlas hood vents
- Graphite Atlas hood and tailgate script
- Narvik Black inner and Carpathian Grey outer front and rear tow eye finishers
- Perforated grained leather interior in Ebony with Lunar stitch.

\*Tow eye finishers and grille surround vary depending on exterior color, please contact your nearest Land Rover Retailer for further information \*\*These systems are not a substitute for driving safely with due care and attention and will not function under all circumstances, speeds, weather and road conditions, etc. Driver should not assume that these systems will correct errors of judgment in driving. Please consult the owner's manual or your local authorized Land Rover Retailer for more details The high powered Si4 286HP engine features a unique bumper as standard. Fog lights not available.



<sup>1</sup>Driving while distracted can result in loss of vehicle control. Do not operate, adjust or view the navigation or multimedia systems under conditions that will affect your safety or the safety of others. Only use mobile phones and other devices, even with voice commands, when it is safe to do so.





ABOVE & BEYOND

CONTENTS

SPECIFICATION

LOCATE A RETAILER

BUILD YOUR OWN

STEP 2  
CHOOSE YOUR MODEL AND OPTIONS

## CONVERTIBLE MODELS

### RANGE ROVER EVOQUE CONVERTIBLE SE DYNAMIC



- Dynamic body style
- Brunel grille with Narvik Black surround
- Halogen headlights
- Brunel fender vents
- Body-colored door handles
- Narvik Black mirror caps
- Atlas hood and tailgate script
- Narvik Black inner and Corris Grey outer front and rear tow eye finishers\*
- Bright square exhaust finisher
- 12-way seating with perforated grained leather

- Brunel tailgate finisher
- Rain sensing windshield wipers
- Carpet mats
- Front and Rear Parking Aid†
- Ambient Interior Lighting
- 18" 7 spoke 'Style 706' alloy wheels
- 10" Touchscreen\*\*
- Meridian™ Sound System 380W with 10 speakers plus subwoofer including InControl Touch Pro
- Navigation Pro.

### RANGE ROVER EVOQUE CONVERTIBLE HSE DYNAMIC



- Contents of SE Dynamic, plus:
- Configurable Ambient Interior Lighting
  - Illuminated aluminum front treadplates with Range Rover script
  - Front fog lights
  - Keyless Entry
  - HomeLink®
  - Blind Spot Monitor with Closing Vehicle Detection and Reverse Traffic Detection\*\*.

- Replaces SE Dynamic content:
- Narvik Black Dynamic grille with Corris Grey surround\*
  - Narvik Black fender vents, hood vents and tailgate finisher
  - 19" 7 spoke 'Style 707' alloy wheels
  - Perforated Windsor leather with heated front seats
  - Xenon headlights with LED signature lighting and power wash
  - Auto High Beam Assist.

## PERSONALIZING THE EXTERIOR

The Range Rover Evoque offers a unique design package option to further personalize the exterior. The Black Design Package emphasizes the confident stance of the vehicle, making it really stand out from the crowd.

### BLACK DESIGN PACKAGE



The optional Black Design Package is available on HSE Dynamic models across both body styles. The package gives the overall design of the vehicle a more assertive appearance, with Narvik Black exterior elements and unique distinctive Satin Black alloy wheels.

- 20" 5 split-spoke 'Style 508' with Satin Black finish
- Narvik Black front and rear tow eye finishers
- Darkened headlights, rear tail lights and front fog lights (fog lights are not available on S4 286HP engine)
- Narvik Black Range Rover script (hood and tailgate)
- Dynamic square Black exhaust finishers
- Narvik Black grille surround.

\*Tow eye finishers and grille surround vary depending on exterior color, please contact your nearest Land Rover Retailer for further information \*\*Driving while distracted can result in loss of vehicle control. Do not operate, adjust or view the navigation or multimedia systems under conditions that will affect your safety or the safety of others. Only use mobile phones and other devices, even with voice commands, when it is safe to do so †These systems are not a substitute for driving safely with due care and attention and will not function under all circumstances, speeds, weather and road conditions, etc. Driver should not assume that these systems will correct errors of judgment in driving. Please consult the owner's manual or your local authorized Land Rover Retailer for more details.



Vehicle shown: HSE Dynamic with optional Black contrast roof and optional equipment.





ABOVE & BEYOND

CONTENTS

SPECIFICATION

LOCATE A RETAILER

BUILD YOUR OWN

STEP 2  
CHOOSE YOUR MODEL AND OPTIONS

## STANDARD AND OPTIONAL FEATURES

### Engine Transmission, Suspension and Driving Dynamics

OPTION CODE	2.0L Si4 (237)	2.0L Si4 (286)	DESCRIPTION
	■	■	Please refer to page 39.
	■	■	
	■	■	Please refer to page 25.
Adaptive Dynamics (1) (2)	027CY	■	Please refer to page 25.
All Terrain Progress Control (ATPC) (2)	095CB	■	Please refer to page 21.
Torque Vectoring by Braking (2)	■	■	
Hill Descent Control (HDC)® (2)	■	■	
Hill Start Assist (2)	■	■	
18" brakes	-	■	

### Engine Transmission, Suspension and Driving Dynamics (continued)

OPTION CODE	2.0L Si4 (237)	2.0L Si4 (286)	DESCRIPTION
	■	■	
Stop/Start technology	■	■	
Anti-lock Braking System (ABS) (2)	■	■	
Cruise control (2)	■	■	
Electronic Power Assisted Steering (EPAS) (2)	■	■	
Traction Control System (TCS) (2)	■	■	
Dynamic Stability Control (DSC) (2)	■	■	
Roll Stability Control (RSC) (2)	■	■	
Engine Drag Torque Control (EDC) (2)	■	■	
Electric Parking Brake (EPB) (2)	■	■	
Emergency Brake Assist (EBA) (2)	■	■	
Electronic Brake-force Distribution (EBD) (2)	■	■	
Trailer Stability Assist (2)	■	■	
Push Button Start	■	■	

■ Standard – Not Available.

(1) Only available on Five-door HSE Dynamic model (2) These systems are not a substitute for driving safely with due care and attention and will not function under all circumstances, speeds, weather and road conditions, etc. Driver should not assume that these systems will correct errors of judgment in driving. Please consult the owner's manual or your local authorized Land Rover Retailer for more details.

■ Standard.







ABOVE & BEYOND

CONTENTS

SPECIFICATION

LOCATE A RETAILER

BUILD YOUR OWN

STEP 2  
CHOOSE YOUR MODEL AND OPTIONS

STANDARD AND OPTIONAL FEATURES

Exterior Features and Finishers

	OPTION CODE	SE	SE PREMIUM	LANDMARK EDITION	HSE	HSE DYNAMIC	AUTOBIOGRAPHY	SE DYNAMIC (CONVERTIBLE)	HSE DYNAMIC (CONVERTIBLE)	DESCRIPTION
<b>ROOF AND EXTERIOR DESIGN</b>										
Body-colored door handles (includes Noble surrounds on HSE and Autobiography)		■	■	■	■	■	■	■	■	
Body-colored roof with matching spoiler		■	■	-	■	■	■	-	-	
Fixed panoramic roof		-	■	■	■	■	■	-	-	Please refer to page 36.
Black contrast roof (1)	080AN	□	□	-	□	□	□	-	-	
Grey contrast roof (1)	080EE	□	□	-	□	□	□	-	-	
Carpathian Grey contrast roof		-	-	■	-	-	-	-	-	
Anthracite side sills		■	■	■	■	■	■	■	■	
Brunel fender blade		■	-	-	-	-	-	■	-	
Narvik Black fender blade		-	■	-	-	■	-	-	■	
Graphite Atlas fender blade		-	-	■	-	-	-	-	-	
Atlas fender blade		-	-	-	■	-	■	-	-	
Brunel tailgate finisher		■	-	-	-	-	-	■	-	
Narvik Black tailgate finisher		-	■	■	-	■	-	-	■	
Atlas tailgate finisher		-	-	-	■	-	■	-	-	
Brunel grille		■	-	-	-	-	-	■	-	
Narvik Black grille		-	■	-	-	■	-	-	■	
Graphite Atlas grille		-	-	■	-	-	-	-	-	
Dark Atlas grille		-	-	-	■	-	-	-	-	
Atlas grille		-	-	-	-	-	■	-	-	
Body-colored door claddings		-	-	■	-	■	■	■	■	
Anthracite door claddings		■	■	-	■	-	-	-	-	
Brunel lower door cladding insert		■	-	-	-	-	-	-	-	
Atlas lower door cladding insert		-	-	-	■	-	-	-	-	
Narvik Black lower door cladding insert		-	■	-	-	-	-	-	-	

■ Standard □ Optional - Not Available.

(1) When contrast roof color is selected, door mirrors are always in Narvik Black.

Exterior Features and Finishers (continued)

	OPTION CODE	SE	SE PREMIUM	LANDMARK EDITION	HSE	HSE DYNAMIC	AUTOBIOGRAPHY	SE DYNAMIC (CONVERTIBLE)	HSE DYNAMIC (CONVERTIBLE)	DESCRIPTION
<b>EXTERIOR DESIGN</b>										
Dynamic front and rear bumper		-	-	■	-	■	■	■	■	
Narvik Black hood vents		-	-	-	-	■	-	-	■	
Graphite Atlas hood vents		-	-	■	-	-	-	-	-	
Atlas hood vents		-	-	-	-	-	■	-	-	
Body-colored mirror caps		■	-	-	■	-	■	-	-	
Narvik Black mirror caps (2)		-	■	■	-	■	-	■	■	
<b>GLASS AND EXTERIOR MIRRORS</b>										
Heated rear window		■	■	■	■	■	■	-	-	
Heated windshield	040AK	P1	P1	P1	P1/P6	P1/P6	■	P1	P1/P6	
Heated washer jets	040AQ	P1	P1	P1	P1/P6	P1/P6	■	P1	P1/P6	
Infrared reflective windshield		■	■	■	■	■	■	■	■	This is a fine metallic coating made up of several layers of titanium and silver to create an infrared reflective coating, keeping the vehicle cooler in hot conditions.
Privacy glass		■	■	■	■	■	■	-	-	Provides increased privacy for rear passengers by restricting vision into the rear cabin.

■ Standard □ Optional - Not Available.

P1 - Cold Climate Convenience Package P6 - Luxury Seating Package. Please see pages 73-75 for full package descriptions.

(2) When contrast roof is selected, door mirrors are always in Narvik Black.







ABOVE & BEYOND

CONTENTS

SPECIFICATION

LOCATE A RETAILER

BUILD YOUR OWN

STEP 2  
CHOOSE YOUR MODEL AND OPTIONS

## STANDARD AND OPTIONAL FEATURES

### Exterior Features and Finishers (continued)

	OPTION CODE	SE	SE PREMIUM	LANDMARK EDITION	HSE	HSE DYNAMIC	AUTOBIOGRAPHY	SE DYNAMIC (CONVERTIBLE)	HSE DYNAMIC (CONVERTIBLE)	DESCRIPTION
<b>GLASS AND EXTERIOR MIRRORS</b>										
Power fold, heated door mirrors with approach and puddle lights		■	-	-	-	-	-	-	-	
Auto-dimming power fold, heated door mirrors with memory functionality, approach and puddle lights		-	■	■	■	■	■	■	■	Working in conjunction with the auto-dimming interior rear view mirror, electrochromic mirror glass is triggered through a sensor activated by low or poor lighting conditions. The exterior mirror glass darkens proportionally to the light detected by the sensors.
<b>HEADLIGHTS AND LIGHTING</b>										
Halogen headlights		■	-	-	-	-	-	■	-	
Xenon headlights with LED signature and power wash	064CW	P2	■	■	■	■	-	P2	■	
Adaptive LED headlights with LED signature	064GJ	-	-	-	P4	P4	■	-	P4	
Automatic headlights and rain sensing wipers		■	■	■	■	■	■	■	■	
Automatic High Beam Assist (AHBA) (1)	030NT	P2	P3	P3	■	■	■	P3	■	Automatic High Beam Assist headlights automatically lower when traffic is detected, reverting when vehicles have passed.
Front fog lights (2)	064AP	P2	■	■	■	■	■	P2	■	
<b>WHEEL FEATURES</b>										
Tire Pressure Monitoring System (TPMS)		■	■	■	■	■	■	■	■	
18" temporary spare wheel and toolkit		■	■	■	■	■	■	■	■	

■ Standard □ Optional - Not Available.  
P2 – SE Tech Package P3 – Advanced Driver Assistance Package P4 – Driver Assistance Plus Package.  
Please see pages 73-75 for full package descriptions.  
(1) Not available with halogen headlights (2) Not available with Si4 286HP engine.

### Seating, Interior Features and Finishers

	OPTION CODE	SE	SE PREMIUM	LANDMARK EDITION	HSE	HSE DYNAMIC	AUTOBIOGRAPHY	SE DYNAMIC (CONVERTIBLE)	HSE DYNAMIC (CONVERTIBLE)	DESCRIPTION
<b>SEATING</b>										
Grained leather seats	033AS	■	□	-	-	-	-	-	-	Please refer to page 82-84.
Perforated grained leather seats		-	■	■	-	-	-	■	-	Please refer to page 82-84.
Perforated Windsor leather seats	033JK	-	-	-	■	□	■	-	-	Please refer to page 82-84.
Perforated Windsor leather seats (Dynamic design)	033YA	-	-	-	-	■	-	□	■	Seat center panel features horizontal ribbed design. Please refer to page 82-84.
Full Windsor leather interior	032CG	-	-	-	-	□	■	-	□	Adds Windsor leather to the door top roll, fascia mid-section and fascia topper.
Rear seat 60:40 split		■	■	■	■	■	■	-	-	
Heated front seats	033BV	-	-	-	■	■	-	P1	■	Please refer to page 36.
Heated front and rear seats (3)	033EQ	P1	P1	P1	-	-	-	-	-	Please refer to page 36.
Heated and cooled front seats (4)	033GP	-	-	-	-	-	-	-	P6	Please refer to page 36.
Heated and cooled front seats with heated rear seats (3) (4)	033GQ	-	-	-	P6	P6	■	-	-	14-way seats increases seat functionality with seat bolsters. Please refer to page 36.
12-way electric front seats		■	-	-	-	-	-	-	-	
12-way electric front seats with memory		-	■	■	■	■	-	■	■	
14-way electric front seats with memory	033UG	-	-	-	P6	P6	-	-	P6	
14-way electric front seats with memory and massage		-	-	-	-	-	■	-	-	14-way seats increases seat functionality with seat bolsters.

■ Standard □ Optional - Not Available.  
P1 – Cold Climate Convenience Package P6 – Luxury Seating Package.  
Please see pages 73-75 for full package descriptions.  
(3) Heating available to outboard rear seats only (4) Only available with 14-way seats.







ABOVE & BEYOND

CONTENTS

SPECIFICATION

LOCATE A RETAILER

BUILD YOUR OWN

STEP 2  
CHOOSE YOUR MODEL AND OPTIONS

### STANDARD AND OPTIONAL FEATURES

#### Seating, Interior Features and Finishers (continued)

	OPTION CODE	SE	SE PREMIUM	LANDMARK EDITION	HSE	HSE DYNAMIC	AUTOBIOGRAPHY	SE DYNAMIC (CONVERTIBLE)	HSE DYNAMIC (CONVERTIBLE)	DESCRIPTION
<b>SEATING</b>										
Rear center head restraint		■	■	■	■	■	■	-	-	
Rear seat center armrest	033FJ	■	■	■	■	■	■	□	P7	On Convertible also includes ski hatch.
<b>STEERING WHEEL</b>										
Manually adjustable steering column		■	■	■	■	■	■	■	■	
Leather steering wheel		■	■	■	■	■	■	-	-	
Perforated leather steering wheel		-	-	-	-	■	-	■	■	
Heated steering wheel	032DV	P1	P1	P1	P1/P6	P1/P6	■	P1	P1	

■ Standard □ Optional - Not Available.  
P1 – Cold Climate Convenience Package P6 – Luxury Seating Package P7 – Lux Package.  
Please see pages 73-75 for full package descriptions.

#### Seating, Interior Features and Finishers (continued)

	OPTION CODE	SE	SE PREMIUM	LANDMARK EDITION	HSE	HSE DYNAMIC	AUTOBIOGRAPHY	SE DYNAMIC (CONVERTIBLE)	HSE DYNAMIC (CONVERTIBLE)	DESCRIPTION
<b>INTERIOR FINISHERS</b>										
Satin Brushed Aluminum trim finisher		-	-	-	-	-	■	-	-	Please refer to page 89.
Dark Satin Brushed Aluminum trim finisher		-	-	■	-	-	-	-	-	Please refer to page 89.
Textured Aluminum trim finisher	088GR	□	□	-	□	□	-	□	□	Please refer to page 89.
Dark Sport Textured Aluminum trim finisher		■	■	-	■	■	-	■	■	Please refer to page 89.
Gloss Black Strata veneer	088GQ	-	-	-	-	□	□	-	□	Please refer to page 89.
Dark Grey Oak Wood veneer (1)	088GM	-	-	-	□	-	□	-	-	Please refer to page 89.
Figured Macassar Wood veneer (2)	088GN	-	-	-	□	-	□	-	-	Please refer to page 89.
<b>INTERIOR FEATURES</b>										
Automatic climate control – with air filtration		■	■	■	■	■	■	■	■	
Proximity sensing and touch detection for overhead map lights		■	■	■	■	■	■	■	■	
Global opening/closing for all windows from smart key		■	■	■	■	■	■	■	■	
Center console with sliding armrest		■	■	■	■	■	■	■	■	
Illuminated footwell, glovebox, door release, overhead console downlighter, load compartment light and map lights		■	■	■	■	■	■	■	■	
Illuminated vanity mirror		■	■	■	■	■	■	■	■	
Luggage compartment anchor points		■	■	■	■	■	■	■	■	
Luggage cover		■	■	■	■	■	■	-	-	

■ Standard □ Optional - Not Available.  
(1) Not available on HSE with Ebony/Ivory interior color combination (2) On HSE, only available with Ebony/Ivory interior color combination.







ABOVE & BEYOND

CONTENTS

SPECIFICATION

LOCATE A RETAILER

BUILD YOUR OWN

STEP 2  
CHOOSE YOUR MODEL AND OPTIONS

STANDARD AND OPTIONAL FEATURES

Seating, Interior Features and Finishers  
(continued)

	OPTION CODE	SE	SE PREMIUM	LANDMARK EDITION	HSE	HSE DYNAMIC	AUTOBIOGRAPHY	SE DYNAMIC (CONVERTIBLE)	HSE DYNAMIC (CONVERTIBLE)	DESCRIPTION
<b>INTERIOR FEATURES</b>										
Chrome front and tailgate treadplates with Range Rover script		-	-	-	■	-	-	-	-	
Illuminated aluminum front treadplates with Range Rover script and Chrome tailgate (1)		-	-	-	-	■	-	-	■	
Illuminated aluminum front treadplates with Autobiography script and Chrome tailgate		-	-	-	-	-	■	-	-	
Carpet mats		■	■	■	■	■	-	■	■	
Premium carpet mats		-	-	-	-	-	■	-	-	
Auto-dimming interior rear view mirror		■	■	■	■	■	■	■	■	
Cabin Air Quality Sensor		■	■	■	■	■	■	■	■	Advanced air filtration and air quality sensing system to facilitate automatic recirculation when outside air quality is poor or pollen counts are high.
Climate control rear vents		■	■	■	■	■	■	■	■	
Smoker's Package	094AA	□	□	□	□	□	□	□	□	Includes single ashtray and single cigarette lighter.
Ambient Interior Lighting		■	■	■	-	-	-	■	-	
Configurable Ambient Interior Lighting		-	-	-	■	■	■	-	■	Please refer to page 36.

Safety and Security

	OPTION CODE	SE	SE PREMIUM	LANDMARK EDITION	HSE	HSE DYNAMIC	AUTOBIOGRAPHY	SE DYNAMIC (CONVERTIBLE)	HSE DYNAMIC (CONVERTIBLE)	DESCRIPTION
Airbags (driver airbags and knee bolster airbag; front passenger airbag, curtain airbags and side airbags) (2)		■	■	■	■	■	■	-	-	
Airbags (driver airbags and knee bolster airbag; front passenger airbag and side airbags – seat mounted with head protection) (2)		-	-	-	-	-	-	■	■	
Front height adjustable seat belts		■	■	■	■	■	■	-	-	
LATCH mounting points in outboard rear seats		■	■	■	■	■	■	■	■	

■ Standard □ Optional – Not Available.  
(1) Tailgate treadplate not fitted on Convertible.

■ Standard □ Optional – Not Available.  
(2) Please remember that the safety belts in a vehicle constitute the primary protection system for driver and passengers in collisions. Airbags are not designed to deploy in all collisions. The airbag Supplemental Restraint System (SRS) is a supplement to the safety belts and is designed to work as a system with the safety belts. Although airbags provide additional protection, airbags without safety belts do not provide optimal protection in a crash. Always wear your safety belts. Children younger than 13 years old should always be properly restrained in a back seat, away from airbags. Never place an infant seat in the front seat.







ABOVE & BEYOND

CONTENTS

SPECIFICATION

LOCATE A RETAILER

BUILD YOUR OWN

STEP 2  
CHOOSE YOUR MODEL AND OPTIONS

## STANDARD AND OPTIONAL FEATURES

### Driver Assistance, Convenience and Cargo Space Features

	OPTION CODE	SE	SE PREMIUM	LANDMARK EDITION	HSE	HSE DYNAMIC	AUTOBIOGRAPHY	SE DYNAMIC (CONVERTIBLE)	HSE DYNAMIC (CONVERTIBLE)	DESCRIPTION
<b>DRIVER ASSISTANCE</b>										
Rear Parking Aid (1)		■	■	■	■	■	■	■	■	
Front Parking Aid (1)		■	■	■	■	■	■	■	■	
Rear View Camera		■	■	■	■	■	-	■	■	As one of the driver assistance technologies, the Rear View Camera is a valuable parking aid and offers help when hitching a trailer. Static lines representing the vehicles outer perimeter and predicted path are superimposed on the rearward image, to make parking in tight spots easier.
Surround Camera System	086GC	-	-	-	P3	P3	■	□	P3/P7	Using four digital cameras mounted around the vehicle, this system provides an all-round view of your surroundings on the full-color Touchscreen, assisting in tight maneuvers. When towing, it provides additional information to aid with reversing.
Park Assist – Parallel Park/Parking Exit/Perpendicular Park	086HA	-	-	-	P3	P3	■	-	P3/P7	Please refer to page 35.

■ Standard □ Optional – Not Available.  
P3 – Advanced Driver Assistance Package P7 – Lux Package.  
Please see pages 73-75 for full package descriptions.

(1) These systems are not a substitute for driving safely with due care and attention and will not function under all circumstances, speeds, weather and road conditions, etc. Driver should not assume that these systems will correct errors of judgment in driving. Please consult the owner's manual or your local authorized Land Rover Retailer for more details.

### Driver Assistance, Convenience and Cargo Space Features (continued)

	OPTION CODE	SE	SE PREMIUM	LANDMARK EDITION	HSE	HSE DYNAMIC	AUTOBIOGRAPHY	SE DYNAMIC (CONVERTIBLE)	HSE DYNAMIC (CONVERTIBLE)	DESCRIPTION
<b>DRIVER ASSISTANCE (1)</b>										
360° Parking Aid (1)	036MB	-	-	-	P3	P3	■	-	P3/P7	Please refer to page 35.
Blind Spot Monitor with Reverse Traffic Detection (1)	086GF	-	P3	P3	■	■	■	P3	■	Please refer to page 34.
Adaptive Cruise Control with Queue Assist and Intelligent Emergency Braking (1)	086AG	-	-	-	-	P4	P4	-	P4	Please refer to page 34.
Lane Keep Assist with Lane Departure Warning, Autonomous Emergency Braking and Driver Condition Monitor (1)	086BD	-	-	-	P3	P3	■	-	P3/P7	Please refer to page 34.
Traffic Sign Recognition (1)	086DB	-	-	-	P3	P3	■	-	P3/P7	

■ Standard □ Optional – Not Available.  
P3 – Advanced Driver Assistance Package P4 – Driver Assistance Plus Package P7 – Lux Package.  
Please see pages 73-75 for full package descriptions.







ABOVE & BEYOND

CONTENTS

SPECIFICATION

LOCATE A RETAILER

BUILD YOUR OWN

STEP 2  
CHOOSE YOUR MODEL AND OPTIONS

## STANDARD AND OPTIONAL FEATURES

### Driver Assistance, Convenience and Cargo Space Features (continued)

	OPTION CODE	SE	SE PREMIUM	LANDMARK EDITION	HSE	HSE DYNAMIC	AUTOBIOGRAPHY	SE DYNAMIC (CONVERTIBLE)	HSE DYNAMIC (CONVERTIBLE)	DESCRIPTION
<b>CONVENIENCE FEATURES</b>										
Garage Door Opener (HomeLink®)	025CT	–	P3	P3	■	■	■	P3	■	This universal transmitter can be programmed to operate up to three home or office wireless controlled systems, such as garage doors, gates, or security lighting.
Keyless Entry	066AC	P2/P5	■	■	■	■	■	P2	■	The driver is able to access and lock/alarm the vehicle without the need to take the remote smart key out of a bag or pocket.
<b>CARGO SPACE FEATURES</b>										
Powered gesture tailgate	070BA	P2	■	■	■	■	■	–	–	Please refer to page 35.
Wind deflector (1)	–	–	–	–	–	–	–	■	■	Please refer to page 16.

■ Standard □ Optional – Not Available.

P2 – SE Tech Package P3 – Advanced Driver Tech Package P5 – Tech Package. Please see pages 73-75 for full package descriptions.

(1) In common with other Convertible vehicles, the wind deflector covers the rear seats, and thus cannot be used when rear seat passengers are being carried. HomeLink® is the registered trademark of Gentex Corporation.

### Information, Communication and Entertainment

	OPTION CODE	SE	SE PREMIUM	LANDMARK EDITION	HSE	HSE DYNAMIC	AUTOBIOGRAPHY	SE DYNAMIC (CONVERTIBLE)	HSE DYNAMIC (CONVERTIBLE)	DESCRIPTION
12V auxiliary power sockets (front and luggage compartment)		■	■	■	■	■	■	■	■	
Bluetooth® audio streaming and phone connection		■	■	■	■	■	■	■	■	
Protect		■	■	■	■	■	■	■	■	
8" Touchscreen (2) (4)		■	■	■	–	–	–	–	–	
10" Touchscreen (3) (4)	087AP	P5	P5	P5	■	■	■	■	■	Please refer to page 29.
Land Rover Sound System with 8 speakers (Touch)		■	■	■	–	–	–	–	–	Includes single USB socket. Please refer to page 29.
Meridian™ Sound System 380W with 10 speakers plus subwoofer (Touch Pro)	025LM	P5	P5	P5	■	■	–	■	■	Includes two USB sockets. Please refer to pages 29 and 30-31.
Meridian™ Surround Sound System 825W with 16 speakers plus subwoofer (Touch Pro)	025LN	–	–	–	□	□	■	–	P7	Includes two USB sockets. On Convertible models, the Surround Sound System offers 660W with 12 speakers plus subwoofer. Please refer to pages 29 and 30-31.

■ Standard □ Optional – Not Available.

P5 – Tech Package P7 – Lux Package.

Please see pages 73-75 for full package descriptions.

(2) Not available with Meridian™ Sound System (3) Only available with Meridian™ Sound System (4) Driving while distracted can result in loss of vehicle control.

Do not operate, adjust or view the navigation or multimedia systems under conditions that will affect your safety or the safety of others.

Only use mobile phones and other devices, even with voice commands, when it is safe to do so.

The Bluetooth® word mark and logos are owned by the Bluetooth SIG, Inc. and any use of such marks by Land Rover is under license.

Meridian is a trademark of Meridian Audio Limited.







ABOVE & BEYOND

CONTENTS

SPECIFICATION

LOCATE A RETAILER

BUILD YOUR OWN

STEP 2  
CHOOSE YOUR MODEL AND OPTIONS

STANDARD AND OPTIONAL FEATURES

Information, Communication and Entertainment (continued)

	OPTION CODE	SE	SE PREMIUM	LANDMARK EDITION	HSE	HSE DYNAMIC	AUTOBIOGRAPHY	SE DYNAMIC (CONVERTIBLE)	HSE DYNAMIC (CONVERTIBLE)	DESCRIPTION
SiriusXM® Satellite Radio (1) & HD Radio	025LA	<input type="checkbox"/>	<input type="checkbox"/>	<input type="checkbox"/>	<input type="checkbox"/>	<input type="checkbox"/>	<input checked="" type="checkbox"/>	<input type="checkbox"/>	<input type="checkbox"/>	
CD/DVD player	025AM	P5	P5	P5	<input checked="" type="checkbox"/>	<input checked="" type="checkbox"/>	<input checked="" type="checkbox"/>	<input checked="" type="checkbox"/>	<input checked="" type="checkbox"/>	
Navigation (2)		<input checked="" type="checkbox"/>	<input checked="" type="checkbox"/>	<input checked="" type="checkbox"/>	-	-	-	-	-	Please refer to pages 29 and 32-33.
Navigation Pro (2) (6)	087AU	P5	P5	P5	<input checked="" type="checkbox"/>	<input checked="" type="checkbox"/>	<input checked="" type="checkbox"/>	<input checked="" type="checkbox"/>	<input checked="" type="checkbox"/>	Please refer to pages 29 and 32-33.
Head-up Display (3)	039IB	-	-	-	P4	P4	P4	-	P4	Please refer to page 28.
Remote		<input checked="" type="checkbox"/>	<input checked="" type="checkbox"/>	<input checked="" type="checkbox"/>	<input checked="" type="checkbox"/>	<input checked="" type="checkbox"/>	<input checked="" type="checkbox"/>	<input checked="" type="checkbox"/>	<input checked="" type="checkbox"/>	Please refer to pages 29 and 32-33.
Wi-Fi Hotspot (4)	025RB	<input type="checkbox"/>	<input type="checkbox"/>	<input type="checkbox"/>	-	-	-	-	-	Please refer to pages 29 and 32-33.
Pro Services and Wi-Fi Hotspot (4) (5)	025RC	<input type="checkbox"/>	<input type="checkbox"/>	<input type="checkbox"/>	<input checked="" type="checkbox"/>	<input checked="" type="checkbox"/>	<input checked="" type="checkbox"/>	<input checked="" type="checkbox"/>	<input checked="" type="checkbox"/>	Please refer to pages 29 and 32-33.
InControl Apps (5)		<input checked="" type="checkbox"/>	<input checked="" type="checkbox"/>	<input checked="" type="checkbox"/>	<input checked="" type="checkbox"/>	<input checked="" type="checkbox"/>	<input checked="" type="checkbox"/>	<input checked="" type="checkbox"/>	<input checked="" type="checkbox"/>	Please refer to pages 29 and 32-33.

■ Standard □ Optional - Not Available.

P4 – Driver Assistance Plus Package P5 – Tech Package.

Please see pages 73-75 for full package descriptions.

(1) A 3-month trial subscription to the Sirius All Access Package is included with the vehicle, which gives you access to 150+ channels of premium programming. Plus you can stream SiriusXM on your computer, smartphone or tablet – it's included in your trial. If you decide to continue service after your trial, the subscription plan you choose will automatically renew thereafter and you will be charged according to your chosen payment method at then-current rates. Fees and taxes apply. To cancel you must call SiriusXM at 1-866-635-2349. See the SiriusXM Customer Agreement for complete terms at siriusxm.com. All fees and programming are subject to change. SiriusXM Satellite Radio is not available in Alaska or Hawaii

(2) Driving while distracted can result in loss of vehicle control. Do not operate, adjust or view the navigation or multimedia systems under conditions that will affect your safety or the safety of others. Only use mobile phones and other devices, even with voice commands, when it is safe to do so (3) These systems are not a substitute for driving safely with due care and attention and will not function under all circumstances, speeds, weather and road conditions, etc. Driver should not assume that these systems will correct errors of judgment in driving. Please consult the owner's manual or your local authorized Land Rover Retailer for more details (4) The Wi-Fi Hotspot is intended for passenger use only. InControl features may require an additional subscription with separate terms and conditions (5) Do not use Land Rover InControl® features under conditions that will affect your safety or the safety of others. Driving while distracted can result in loss of vehicle control

(6) Requires Pro Services and Wi-Fi Hotspot.

OPTIONAL FEATURES

Option Packages

	OPTION CODE	SE	SE PREMIUM	LANDMARK EDITION	HSE	HSE DYNAMIC	AUTOBIOGRAPHY	SE DYNAMIC (CONVERTIBLE)	HSE DYNAMIC (CONVERTIBLE)	DESCRIPTION
Cold Climate Convenience Package (P1) (7)	072BI	<input type="checkbox"/>	<input type="checkbox"/>	<input type="checkbox"/>	<input type="checkbox"/>	<input type="checkbox"/>	-	<input type="checkbox"/>	<input type="checkbox"/>	Consists of heated windshield, heated windshield washer jets, heated steering wheel, heated front seats (on SE Dynamic Convertible only, already standard on HSE and HSE Dynamic) and heated front and rear seats (on SE, SE Premium and Landmark Edition only).
Advanced Driver Assistance Package (P3) (3) (8)	086JA	-	<input type="checkbox"/>	<input type="checkbox"/>	<input type="checkbox"/>	<input type="checkbox"/>	-	<input type="checkbox"/>	<input type="checkbox"/>	Consists of Park Assist – Parallel Park/Parking Exit/Perpendicular Park, 360° Parking Aid, Lane Keep Assist with Lane Departure Warning, Autonomous Emergency Braking and Driver Condition Monitor and Traffic Sign Recognition*. Surround Camera System (all of which are on HSE and HSE Dynamic only). Package also includes Blind Spot Monitor with Reverse Traffic Detection, Automatic High Beam Assist (AHBA) and HomeLink® (all of which are already standard on HSE and HSE Dynamic).
Black Design Package	032EI	-	-	-	-	<input type="checkbox"/>	-	-	<input type="checkbox"/>	Consists of front fog lights (not available on Si4 286HP engine), headlights and tail lights with Darkened finish, Narvik Black front and rear tow eye trim finisher, Narvik Black front grille surround, Black exhaust finishers, Narvik Black Range Rover script (hood and tailgate) and 20" Satin Black wheels.

□ Optional - Not Available.

(7) Not available with the Luxury Seating Package (8) Not available with the Lux Package or SE Tech Package (does not apply to SE Dynamic Convertible).

\*Traffic Sign Recognition requires Navigation or Navigation Pro.

HomeLink® is the registered trademark of Gentex Corporation.







ABOVE & BEYOND

CONTENTS

SPECIFICATION

LOCATE A RETAILER

BUILD YOUR OWN

STEP 2  
CHOOSE YOUR MODEL AND OPTIONS

OPTIONAL FEATURES

Option Packages (continued)

	OPTION CODE	SE	SE PREMIUM	LANDMARK EDITION	HSE	HSE DYNAMIC	AUTOBIOGRAPHY	SE DYNAMIC (CONVERTIBLE)	HSE DYNAMIC (CONVERTIBLE)	DESCRIPTION
Tech Package (P5) (1)	074PK	<input type="checkbox"/>	<input type="checkbox"/>	<input type="checkbox"/>	-	-	-	-	-	Consists of Keyless Entry and powered gesture tailgate (both of which are already standard on SE Premium and Landmark Edition). Package also includes Navigation Pro, Meridian™ Sound System 380W with 10 speakers plus subwoofer, Touch Pro with 10" Touchscreen and CD/DVD player.
SE Tech Package (P2) (2)	074PT	<input type="checkbox"/>	-	-	-	-	-	<input type="checkbox"/>	-	Consists of Keyless Entry, Xenon headlights with LED signature and power wash, front fog lights, Automatic High Beam Assist (AHBA) (on SE only) and powered gesture tailgate (on SE only).
Driver Assistance Plus Package (3)	017AS	-	-	-	<input type="checkbox"/>	<input type="checkbox"/>	<input type="checkbox"/>	-	<input type="checkbox"/>	Consists of Head-up Display, Adaptive LED headlights with LED signature (already standard on Autobiography) and Adaptive Cruise Control with Queue Assist and Intelligent Emergency Braking.

Optional - Not Available.

(1) Not available with the SE Tech Package (2) Not available with the Tech Package or Advanced Driver Assistance Package (3) These features are not a substitute for driving safely with due care and attention and will not function under all circumstances, speeds, weather and road conditions, etc. Driver should not assume that these features will correct errors of judgment in driving. Please consult the owner's manual or your local authorized Land Rover Retailer for more details. Meridian™ is a trademark of Meridian Audio Ltd.

Option Packages (continued)

	OPTION CODE	SE	SE PREMIUM	LANDMARK EDITION	HSE	HSE DYNAMIC	AUTOBIOGRAPHY	SE DYNAMIC (CONVERTIBLE)	HSE DYNAMIC (CONVERTIBLE)	DESCRIPTION
Luxury Seating Package (P6) (4)	074RX	-	-	-	<input type="checkbox"/>	<input type="checkbox"/>	-	-	<input type="checkbox"/>	Consists of heated windshield, heated windshield washer jets, heated steering wheel, heated and cooled front and heated rear seats (heated rear seats not available on Convertible) and 14-way electric front seats with memory.
Lux Package (P7) (3)	074OU	-	-	-	-	-	-	-	<input type="checkbox"/>	Consists of Park Assist – Parallel Park/Parking Exit/Perpendicular Park with 360° Parking Aid, Surround Camera System, Meridian™ Surround Sound System 660W with 12 speakers plus subwoofer (Touch Pro), ski hatch with rear center armrest, Lane Keep Assist with Lane Departure Warning, Autonomous Emergency Braking and Driver Condition Monitor.

Optional - Not Available.

(4) Not available with the Cold Climate Convenience Package.







ABOVE & BEYOND

CONTENTS

SPECIFICATION

LOCATE A RETAILER

BUILD YOUR OWN

STEP 3  
CHOOSE YOUR COLOR

# 3

Now you have chosen your Range Rover Evoque model, you can select your exterior paint color. From rich, deep lusters to incandescent metallic patinas, our paints incorporate the latest in pigment technologies. Our solid paints produce a deep flat color. Our metallics deliver a sparkle finish that is sure to catch the eye. And our premium metallic paints enhance both the color and the intensity of the sparkle or sleek metallic finish to give your vehicle even more presence.

Fuji White (solid)

Optional Contrast Roof Color  
Black Grey



Narvik Black (solid)

Optional Contrast Roof Color  
Grey



Yulong White (metallic)

Optional Contrast Roof Color  
Black Grey



Indus Silver (metallic)

Optional Contrast Roof Color  
Black Grey



Corris Grey (metallic)

Optional Contrast Roof Color  
Black



Kaikoura Stone (metallic)

Optional Contrast Roof Color  
Black Grey



Loire Blue (metallic)

Optional Contrast Roof Color  
Black Grey



Moraine Blue\* (premium metallic)



Santorini Black (metallic)

Optional Contrast Roof Color  
Grey



Firenze Red (metallic)

Optional Contrast Roof Color  
Black Grey



Silicon Silver (premium metallic)

Optional Contrast Roof Color  
Black



Phoenix Orange\*\* (premium metallic)



Carpathian Grey (premium metallic)

Optional Contrast Roof Color  
Black Grey



\*Moraine Blue only available on Landmark Edition. Please refer to page 55  
\*\*Phoenix Orange only available on Convertible body styles. Vehicle shown is HSE Dynamic Convertible with Black Design Package.



ENGINE

MODEL AND OPTIONS

COLOR

INTERIOR

ACCESSORIES

TECHNICAL DETAILS





ABOVE & BEYOND

CONTENTS

SPECIFICATION

LOCATE A RETAILER

BUILD YOUR OWN

STEP 4  
CHOOSE YOUR WHEELS

4



18" 5 SPLIT-SPOKE  
'STYLE 506'



18" 7 SPOKE  
'STYLE 706'



19" 10 SPOKE  
'STYLE 103'



20" 5 SPLIT-SPOKE  
'STYLE 508'



20" 5 SPLIT-SPOKE  
'STYLE 508'  
WITH SATIN BLACK FINISH (2)



20" FORGED 6 SPOKE  
'STYLE 601'  
WITH VIBRATION POLISHED FINISH



20" 5 SPLIT-SPOKE  
'STYLE 504'



20" 5 SPLIT-SPOKE  
'STYLE 504'  
WITH SHADOW CHROME FINISH



19" 10 SPOKE  
'STYLE 103'  
WITH TECHNICAL GOLD FINISH (1)



19" 7 SPLIT-SPOKE  
'STYLE 707'



19" 7 SPLIT-SPOKE  
'STYLE 707'  
WITH GLOSS DARK GREY FINISH



20" 5 SPLIT-SPOKE  
'STYLE 504'  
WITH TECHNICAL GOLD FINISH (1)



20" FORGED 9 SPOKE  
'STYLE 901'  
WITH FUJI WHITE FINISH (1)



20" 9 SPOKE  
'STYLE 901'  
WITH POLISHED SPARKLE FINISH



20" 5 SPLIT-SPOKE  
'STYLE 527'  
WITH DIAMOND TURNED AND  
LIGHT SPARKLE CONTRAST PAINTED FINISH

	OPTION CODE	SE	SE PREMIUM	LANDMARK EDITION	HSE	HSE DYNAMIC	AUTOBIOGRAPHY	SE DYNAMIC (CONVERTIBLE)	HSE DYNAMIC (CONVERTIBLE)
<b>WHEELS</b>									
18" 5 split-spoke 'Style 506'		■	-	-	-	-	-	-	-
18" 7 spoke 'Style 706'		-	■	-	-	-	-	■	-
19" 10 spoke 'Style 103'	029TE	□	-	-	■	-	-	-	-
19" 10 spoke 'Style 103' with Technical Gold finish (1)	VPLVW0113	□	□	□	□	□	□	□	□
19" 7 split-spoke 'Style 707'	029XU	-	□	-	-	■	-	□	■
19" 7 split-spoke 'Style 707' with Gloss Dark Grey finish		-	-	■	-	-	-	-	-

	OPTION CODE	SE	SE PREMIUM	LANDMARK EDITION	HSE	HSE DYNAMIC	AUTOBIOGRAPHY	SE DYNAMIC (CONVERTIBLE)	HSE DYNAMIC (CONVERTIBLE)
<b>WHEELS</b>									
20" 5 split-spoke 'Style 508'	029VY	-	-	-	□	□	-	□	□
20" 5 split-spoke 'Style 508' with Satin Black finish (2)	029VX	-	-	-	-	□	-	-	□
20" forged 6 spoke 'Style 601' with Vibration Polished finish	029TG	-	-	-	-	□	-	-	-
20" 5 split-spoke 'Style 504'	029PP	□	□	-	-	-	-	-	-
20" 5 split-spoke 'Style 504' with Shadow Chrome finish	029QF	-	□	-	-	-	-	□	-
20" 5 split-spoke 'Style 504' with Technical Gold finish (1)	VPLVW0114	□	□	□	□	□	□	□	□
20" forged 9 spoke 'Style 901' with Fuji White finish (1)	VPLVW0074	□	□	□	□	□	□	□	□
20" 9 spoke 'Style 901' with Polished Sparkle finish	029MY	-	-	-	□	-	-	□	□
20" 5 split-spoke 'Style 527' with Diamond Turned and Light Sparkle Contrast Painted finish		-	-	-	-	-	■	-	-

■ Standard □ Optional - Not Available.

(1) Accessory wheels must be selected with either a standard or optional wheel and incur an additional cost. (2) Only available as part of the Black Design Package.

■ Standard □ Optional - Not Available.

Visit [landroverusa.com](http://landroverusa.com) to configure your vehicle online.



ENGINE

MODEL AND OPTIONS

COLOR

WHEELS

INTERIOR

ACCESSORIES

TECHNICAL DETAILS





ABOVE & BEYOND

CONTENTS

SPECIFICATION

LOCATE A RETAILER

BUILD YOUR OWN

STEP 5  
CHOOSE YOUR INTERIOR

# 5

## CHOOSE YOUR INTERIOR – SEAT CONFIGURATION

Your choice of seat can play a vital role in how you drive your Range Rover Evoque and your enjoyment of the cabin space itself. That's why they're available in a range of styles, colors and a choice of three materials: grained leather, perforated grained leather or perforated Windsor leather. With the exception of the convertible, heated front and rear seats can also be specified across the range with electric memory featured as standard on SE Premium, Landmark Edition, HSE, HSE Dynamic, Autobiography and both Convertible models.



SE SEAT STYLE  
(GRAINED LEATHER)



SE PREMIUM SEAT STYLE  
(PERFORATED GRAINED LEATHER)



HSE SEAT STYLE  
(PERFORATED WINDSOR LEATHER)



HSE DYNAMIC SEAT STYLE  
(PERFORATED WINDSOR LEATHER)



AUTOBIOGRAPHY SEAT STYLE  
(PERFORATED WINDSOR LEATHER)

MODEL	SE SEAT STYLE (GRAINED LEATHER)	SE PREMIUM SEAT STYLE (PERFORATED GRAINED LEATHER)
SE	■	-
SE Premium	□	■
Landmark Edition	-	■
HSE	-	-
HSE Dynamic	-	-
Autobiography	-	-
SE Dynamic Convertible	-	■
HSE Dynamic Convertible	-	-

MODEL	HSE SEAT STYLE (PERFORATED WINDSOR LEATHER)	HSE DYNAMIC SEAT STYLE (PERFORATED WINDSOR LEATHER)	AUTOBIOGRAPHY SEAT STYLE (PERFORATED WINDSOR LEATHER)
SE	-	-	-
SE Premium	-	-	-
Landmark Edition	-	-	-
HSE	■	-	-
HSE Dynamic	□	■	-
Autobiography	-	-	■
SE Dynamic Convertible	-	□	-
HSE Dynamic Convertible	-	■	-







ABOVE & BEYOND

CONTENTS

SPECIFICATION

LOCATE A RETAILER

BUILD YOUR OWN

STEP 5  
CHOOSE YOUR INTERIOR

CHOOSE YOUR  
INTERIOR – COLOR  
COMBINATIONS

Now you have chosen your model, you can use this table to select the perfect combination of interior and exterior color.

	(A)	(B)	(C)		
<b>COLOR COMBINATIONS</b>	<b>EBONY / EBONY</b> (page 86)	<b>ALMOND / ESPRESSO</b> (page 86)	<b>CIRRUS / LUNAR</b> (page 86)		
<b>INTERIOR COLOR</b>					
Seat color	Ebony	Ebony with Lunar stitch	Ebony with Ivory stitch	Almond	Cirrus
Carpet	Ebony	Ebony	Ebony	Espresso	Lunar
<b>MODEL</b>					
SE (grained leather)	○	–	–	○	○
SE Premium (grained leather)	–	–	–	○	○
SE Premium (perforated grained leather)	–	○	–	–	–
Landmark Edition (perforated grained leather)	–	○	–	–	–
HSE (perforated Windsor leather)	–	–	○	–	○
HSE Dynamic (perforated Windsor leather)	–	–	–	–	○
HSE Dynamic (perforated Windsor Dynamic design leather)	–	○	–	–	–
HSE Dynamic (perforated Windsor Dynamic design leather seats, full Windsor leather interior)	–	○	–	–	–
Autobiography (perforated Windsor leather seats, full Windsor leather interior)	–	–	○	–	○
<b>HEADLINING</b>					
Ivory headlining	–	–	■	■	–
Ebony headlining (1)	○	○	○	–	○
Cirrus headlining	■	■	–	–	■
<b>EXTERIOR COLOR</b>					
Fuji White	○	○	○	▲	○
Narvik Black	○	▲	○	○	○
Yulong White	▲	▲	▲	○	▲
Indus Silver	○	○	○	○	▲
Corris Grey	▲	▲	▲	○	▲
Kaikoura Stone	○	○	▲	○	○
Loire Blue	○	○	○	○	▲
Moraine Blue (2)	–	■	–	–	–
Santorini Black	○	▲	▲	○	○
Firenze Red	○	▲	○	○	○
Silicon Silver	○	▲	▲	○	○
Carpathian Grey	○	○	○	○	▲

	(D)	(E)	(F)	(G)	(H)	(I)	(J)	(K)
<b>COLOR COMBINATIONS</b>	<b>LUNAR / IVORY</b> (page 87)	<b>IVORY / EBONY</b> (page 87)	<b>PIMENTO / EBONY</b> (page 87)	<b>VINTAGE TAN / EBONY</b> (page 87)	<b>LUNAR / ICE</b> (page 88)	<b>IVORY / ESPRESSO</b> (page 88)	<b>ESPRESSO / IVORY</b> (page 88)	<b>IVORY / DARK CHERRY</b> (page 88)
<b>INTERIOR COLOR</b>								
Seat color	Ivory / Lunar	Ivory	Pimento / Ebony	Vintage Tan / Ebony	Ice / Ebony	Ivory with Espresso stitch	Ivory / Espresso	Ivory / Dark Cherry
Carpet	Lunar	Ebony	Ebony	Ebony	Lunar	Espresso	Espresso	Dark Cherry
<b>MODEL</b>								
SE (grained leather)	–	–	–	–	–	–	–	–
SE Premium (grained leather)	–	–	–	–	–	–	–	–
SE Premium (perforated grained leather)	○	–	–	–	–	–	–	–
Landmark Edition (perforated grained leather)	–	–	–	–	–	–	–	–
HSE (perforated Windsor leather)	–	○	–	–	–	–	–	–
HSE Dynamic (perforated Windsor leather)	–	○	–	–	–	–	–	–
HSE Dynamic (perforated Windsor Dynamic design leather)	○	–	○	○	○	–	–	–
HSE Dynamic (perforated Windsor Dynamic design leather seats, full Windsor leather interior)	○	–	○	○	○	–	–	–
Autobiography (perforated Windsor leather seats, full Windsor leather interior)	–	–	–	–	–	○	○	○
<b>HEADLINING</b>								
Ivory headlining	■	■	–	○	–	■	■	■
Ebony headlining (1)	○	○	■	■	○	–	–	–
Cirrus headlining	–	–	○	–	■	–	–	–
<b>EXTERIOR COLOR</b>								
Fuji White	▲	○	○	○	○	○	○	○
Narvik Black	○	▲	▲	▲	○	○	○	○
Yulong White	○	○	▲	○	▲	○	○	○
Indus Silver	○	○	○	○	○	○	○	○
Corris Grey	▲	○	○	○	▲	○	○	○
Kaikoura Stone	○	▲	○	○	○	▲	▲	▲
Loire Blue	○	○	○	○	○	○	○	○
Moraine Blue (2)	–	–	–	–	–	–	–	–
Santorini Black	○	▲	▲	▲	○	○	○	○
Firenze Red	○	○	▲	–	○	○	○	○
Silicon Silver	○	▲	○	○	○	○	○	○
Carpathian Grey	▲	○	○	○	▲	○	○	○

■ Standard ▲ Combination is Designer's Choice ○ Combination is Available – Not Available.

The above table is designed as a guide. Please contact your nearest Land Rover Retailer for more information.

(1) Landmark Edition is only available with Ebony headlining. HSE Dynamic has Ebony headlining as standard and Cirrus headlining as optional.

(2) Only available on Landmark Edition.

Visit [landroverusa.com](http://landroverusa.com) to configure your vehicle online.



ENGINE

MODEL AND OPTIONS

COLOR

INTERIOR

ACCESSORIES

TECHNICAL DETAILS



ABOVE & BEYOND

CONTENTS

SPECIFICATION

LOCATE A RETAILER

BUILD YOUR OWN

**STEP 5**  
**CHOOSE YOUR INTERIOR**

EXCLUSIVE TO CONVERTIBLE

	(A)	(D)	(F)	(G)	(H)
<b>COLOR COMBINATIONS</b>	<b>EBONY / EBONY</b> (page 86)	<b>LUNAR / IVORY</b> (page 87)	<b>PIMENTO / EBONY</b> (page 87)	<b>VINTAGE TAN / EBONY</b> (page 87)	<b>LUNAR / ICE</b> (page 88)
<b>INTERIOR COLOR</b>					
Seat color	Ebony with Lunar stitch	Ivory / Lunar	Pimento / Ebony	Vintage Tan / Ebony	Lunar / Ice
Carpet	Ebony	Lunar	Ebony	Ebony	Lunar
<b>MODEL</b>					
SE Dynamic (perforated grained leather)	○	–	–	–	–
SE Dynamic (perforated Windsor Dynamic design leather)	–	○	–	–	–
HSE Dynamic (perforated Windsor Dynamic design leather)	○	○	–	–	–
HSE Dynamic (perforated full Windsor Dynamic design leather seats, full leather interior)	○	○	○	○	○
<b>HEADLINING</b>					
■ Ebony headlining	■	■	■	■	■
<b>EXTERIOR COLOR</b>					
○ Fuji White	○	▲	○	○	○
▲ Narvik Black	▲	○	▲	▲	○
▲ Yulong White	▲	○	▲	○	▲
○ Indus Silver	○	○	○	○	○
▲ Corris Grey	▲	▲	○	○	▲
○ Kaikoura Stone	○	○	○	○	○
○ Loire Blue	○	○	○	○	○
▲ Santorini Black	▲	○	▲	▲	○
▲ Firenze Red	▲	○	▲	–	○
▲ Silicon Silver	▲	○	○	○	○
▲ Phoenix Orange	▲	○	○	○	–
○ Carpathian Grey	○	▲	○	○	▲

COLOR CHOICES

Each interior comes in up to two color combinations. The image and table shown right detail where each color of your chosen combination is located within the cabin.



	1	2	3	4	5
<b>COLOR COMBINATIONS</b>	<b>DOOR CASING INSERTS</b>	<b>DOOR ARMREST</b>	<b>FACIA TOPPER</b>	<b>DOOR LOWER</b>	<b>FACIA MID-SECTION</b>
(A) Ebony / Ebony	Ebony	Ebony	Ebony	Ebony	Ebony
(B) Almond / Espresso	Espresso	Almond	Espresso	Almond	Almond
(C) Cirrus / Lunar	Cirrus*	Cirrus	Lunar	Lunar**	Lunar**
(D) Lunar / Ivory	Ivory	Lunar	Lunar	Lunar	Lunar
(E) Ivory / Ebony	Ivory	Ivory	Ebony	Ebony	Ebony
(F) Pimento / Ebony	Pimento	Ebony	Ebony	Ebony	Ebony
(G) Vintage Tan / Ebony	Vintage Tan	Ebony	Ebony	Ebony	Ebony
(H) Lunar / Ice	Ice	Lunar	Lunar	Lunar	Lunar
(I) Ivory / Espresso	Espresso	Ivory	Espresso	Ivory	Ivory
(J) Espresso / Ivory	Espresso	Ivory	Espresso	Ivory	Ivory
(K) Ivory / Dark Cherry	Dark Cherry	Ivory	Dark Cherry	Ivory	Ivory

84 ■ Standard ▲ Combination is Designer's Choice ○ Combination is Available – Not Available.  
The above table is designed as a guide. Please contact your nearest Land Rover Retailer for more information.



\*Changes to Lunar for Autobiography models only  
\*\*Changes to Cirrus for Autobiography models only.

ENGINE

MODEL AND OPTIONS

COLOR

INTERIOR

ACCESSORIES

TECHNICAL DETAILS





ABOVE & BEYOND

CONTENTS

SPECIFICATION

LOCATE A RETAILER

BUILD YOUR OWN

STEP 5  
CHOOSE YOUR INTERIOR

AVAILABLE INTERIOR COLOR COMBINATIONS

The cabin of the Range Rover Evoque embodies the finest of contemporary living. The warmth of wood veneers, superb metal finishes and soft leathers combine to create a sense of home. The attention to detail is everywhere you look and in everything you touch. A wide range of color combinations and seat materials are available to suit all tastes.

**A Ebony / Ebony** (available on SE, SE Premium, Landmark Edition, HSE, HSE Dynamic, Autobiography and both Convertible models)



Interior shown: SE grained leather.

**D Lunar / Ivory** (available on SE Premium, HSE Dynamic and both Convertibles)



Interior shown: SE Premium perforated grained leather.

**E Ivory / Ebony** (available on HSE and HSE Dynamic)



Interior shown: HSE perforated Windsor leather.

**B Almond / Espresso** (available on SE and SE Premium)



Interior shown: SE grained leather.

**C Cirrus / Lunar** (available on SE, SE Premium, HSE, HSE Dynamic and Autobiography)



Interior shown: SE grained leather.

**F Pimento / Ebony** (available on HSE Dynamic only)



Interior shown: HSE Dynamic perforated Windsor leather.

**G Vintage Tan / Ebony** (available on HSE Dynamic only)



Interior shown: HSE Dynamic perforated Windsor leather.







ABOVE & BEYOND

CONTENTS

SPECIFICATION

LOCATE A RETAILER

BUILD YOUR OWN

STEP 5  
CHOOSE YOUR INTERIOR

**H** Lunar / Ice (available on HSE Dynamic only)



Interior shown: HSE Dynamic perforated Windsor leather.

**I** Ivory / Espresso (available on Autobiography only)



Interior shown: Autobiography perforated Windsor leather.

**J** Espresso / Ivory (available on Autobiography only)



Interior shown: Autobiography perforated Windsor leather.

**K** Ivory / Dark Cherry (available on Autobiography only)



Interior shown: Autobiography perforated Windsor leather.

INTERIOR FINISHERS

Now you have chosen your interior color combination, choose one of seven interior finishers. For full availability and designer's choices, please see the color and trim matrix on pages 82-85.



Satin Brushed Aluminum



Dark Satin Brushed Aluminum\*\*



Textured Aluminum



Dark Sport Textured Aluminum



Gloss Black Strata\*



Figured Macassar Wood\*



Dark Grey Oak Wood\*



\*When these horizontal trim finishers are selected the center console finisher will become Satin Brushed Aluminum  
\*\*Only available on Landmark Edition.





ABOVE & BEYOND

CONTENTS

SPECIFICATION

LOCATE A RETAILER

BUILD YOUR OWN

STEP 6  
CHOOSE YOUR ACCESSORIES

# 6

## LAND ROVER GEAR – ACCESSORIES



Range Rover Evoque is so capable and adaptable it can get straight to work across a huge variety of vastly differing conditions and roles. Even so, some owners want to add their own stamp of individuality by tailoring their Range Rover Evoque to their specific needs with a range of stylish, practical accessories that are tough, versatile and bring an opportunity for personalization.

Importantly, these accessories can be added by your Land Rover Retailer at any stage during the vehicle's life – not just when it's new. Naturally, Land Rover Approved Accessories are designed, tested and manufactured to the same exacting standards as the original equipment fitted to your vehicle.

### DESIGN



Side Tubes – Bright Finish\*  
VPLVP0184 – SE, SE Premium and HSE  
VPLVP0202 – Landmark Edition, HSE Dynamic and Autobiography  
Side Tube – Brushed Finish\* (not shown)  
VPLVP0229 – Convertible

Stainless steel side tubes provide an off-road inspired appearance, designed to complement the vehicle's exterior style.



Fixed Side Steps\*<sup>1</sup>  
VPLVP0225 – SE, SE Premium and HSE  
VPLVP0208 – Landmark Edition, HSE Dynamic and Autobiography

Complete with a rubber tread mat and brushed stainless steel trim, the fixed side steps provide easy access/exit to the vehicle's cabin and aids access to the roof. With embossed Range Rover branding, exterior bright work and Bright anodized aluminum edge trim finish, they complement vehicle exterior styling cues.



Alloy Wheel  
VPLVW0113 – 19" 10 spoke 'Style 103' with Technical Gold Finish\*\*  
Personalize your vehicle with a selection of alloy wheels featuring a wide range of contemporary and dynamic designs.



Illuminated Sill Treadplates  
VPLV50314AAM – Espresso<sup>†</sup> (Five-door)  
VPLV50078PVJ – Ebony (Convertible)  
VPLV50314PVJ – Ebony (Five-door)  
VPLV50078LAA – Lunar (Convertible)  
VPLV50314LAA – Lunar (Five-door)  
VPLV50314CJB – Cherry (Five-door)

Driver and passenger's front door sill treadplates add style to the vehicle and protect the sill trim from scuffs and scrapes. Co-ordinates with your vehicle's interior and subtly illuminates Range Rover script when the front doors are open.



Personalized Sill Treadplates<sup>‡</sup>  
Personalized illuminated treadplates allow you to choose your own message using an approved set of fonts/typefaces which will be highlighted in White illumination when the front doors are open.

Union Jack Sill Treadplates (not shown)  
Driver and passenger's front door sill treadplates add style to the vehicle and protect the sill trim from scuffs and scrapes. Co-ordinates with your vehicle's interior and the Union Jack adds a distinctly British style.



Sport Pedal Covers  
VPLHS0044 – Automatic (shown above)  
VPLV50178 – Sport Footrest – Automatic  
Stainless steel Bright finish sports pedal covers are easy to fit and feature hidden fixings for a clean finish. Complementing the sports pedals, the footrest is manufactured from stainless steel and features a Satin finish.



\*Fitting of side steps or side tubes may effect the off-road capability of the vehicle \*\*Rim only. Center caps available separately  
<sup>†</sup>Not available on Convertible <sup>‡</sup>Please contact your nearest Land Rover Retailer for feature availability.  
Please note all images in the accessory section are representative of the features advertised not vehicle specification.





ABOVE & BEYOND

CONTENTS

SPECIFICATION

LOCATE A RETAILER

BUILD YOUR OWN

STEP 6  
CHOOSE YOUR ACCESSORIES

TOURING



Luggage Roof Box\*<sup>Δ</sup>  
VPLVR0062

Roof mounted luggage box with Gloss Black finish. Opens from both sides and is lockable for security. Includes power-grip mounting for easy and quick fixing to the roof bars. External dimensions: 5.74ft long, 2.7ft wide, 1.48ft high. Volume 410 liters. Maximum payload 150lbs.\*\*

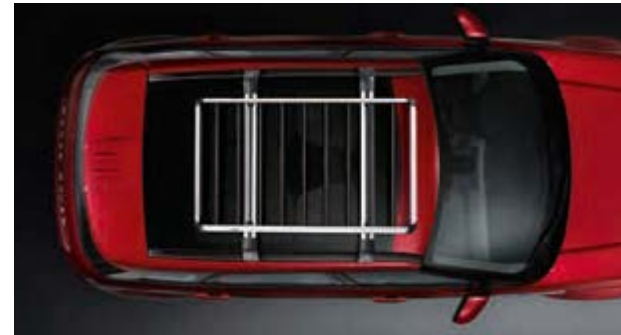

Luggage Carrier\*<sup>Δ</sup>  
LR006848

Flexible rack system to facilitate roof carrying. Offers up to a 150lbs load carrying capacity. Maximum payload 138lbs.



Cargo Space Rails<sup>Δ</sup>  
VPLVS0102  
Cargo Space Retention Kit\*<sup>Δ</sup>  
VPLCS0324

The cargo space retention kit consists of a package of attachments that fix into the cargo space rails via a quick lock/quick release system to help provide a comprehensive and flexible solution for retaining luggage and other items within the cargo space. The attachment package includes a retractable strap with inertia reel and telescopic rod.



Towing Receiver  
VPLVT0168



Draw Bar  
VPLVY0061



Towing Electrics – 13 Pin<sup>†</sup>  
VPLHT0062

Provides power and light for the trailer through the Range Rover Evoque.

SPORTING



Roof Rails\*<sup>Δ</sup>  
VPLVR0085 – Silver Finish  
VPLVR0086 – Black Finish

Roof rails facilitate easy fitment of cross bars for roof carrying. Pre-set positioning points ensure cross bars are fixed in optimum position for weight distribution and dynamics. Vehicle height when fitted: 5.38ft. Maximum permissible load capacity 158lbs.

Silver Roof Trim Finisher  
VPLVR0089 – Panoramic Roof

Black Roof Trim Finisher  
VPLVR0090 – Panoramic Roof



Crossbars\*<sup>Δ</sup>  
VPLVR0073

Silver finish, adjustable position cross bars for vehicles fitted with roof rails. Aerodynamic profile designed to minimize drag and noise. Lockable for security and incorporating a T-slot to carry the Land Rover roof mounted accessory range. Vehicle height when fitted: 5.64ft. Maximum permissible load capacity 158lbs\*\*.



Aqua Sports Carrier\*<sup>Δ</sup>  
VPLGR0107 – Single  
VPLWR0099 – Twin (shown above)

Aqua Sports Carrier can be used to transport a variety of aqua sport gear, feature includes lockable multi-purpose holder to carry a mast, oars or paddles. Tilts to facilitate easy loading/unloading. Features lockable straps and rubber supports to maintain optimum weight distribution while protecting the equipment and vehicle from scratches/scuffs.



Ski / Snowboard Carrier\*<sup>Δ</sup>  
LR006849

Carries four pairs of skis or two snowboards and incorporates slider rails for easy loading, is also lockable for security. Maximum payload 79lbs\*\*.

Ski Bag  
VPLGS0166

The Land Rover padded ski/snowboard bag carries up to two pairs of skis and poles up to 70.8 inches long. It is manufactured from durable 600D polyester and features removable shoulder straps.



Roof Mounted Bike Carrier – Fork Mounted with Wheel Carrier\*<sup>Δ</sup>  
VPLWR0101

Roof mounted cycle carrier provides a simple and secure fitting with the bicycle front wheel removed, ideally suited to lightweight bikes and 'racing' wheels. A separate carrier is included for the front wheel. Easy to fit, lockable cycle carrier which carrier one bicycle per holder. A maximum of two holders can be fitted.



Flexible Cargo Space Protector<sup>Δ</sup>  
VPLVS0090

Heavy duty flexible fabric helps protect cargo space up to window height and covers cargo space floor with second row seat backs covered. Includes general purpose gloves. Not applicable with full height or half height luggage partition.







ABOVE & BEYOND

CONTENTS

SPECIFICATION

LOCATE A RETAILER

BUILD YOUR OWN

STEP 6  
CHOOSE YOUR ACCESSORIES

OUTDOOR



Luggage Partition Full Height\*  
VPLVS0220 – Five-door

Designed to prevent luggage from entering the passenger compartment. Easily removed. Not applicable with cargo space liner tray, cargo space organizer, flexible cargo space protector or cargo space seatback storage bag.



Cargo Space Rubber Mat  
VPLVS0091 – Five-door  
VPLVS0304 – Convertible

Black, waterproof cargo space rubber mat with retaining lip. Offers protection of the cargo space floor.



Social Seating\*  
VPLVS0101

Fold out seating for outdoor use. Stores neatly away in the cargo space. Maximum deployed weight capacity 200 lbs. Requires cargo space rails for fitment.

OTHER



Carbon Fiber Mirror Covers  
VPLVB0145

Stunning high grade Carbon Fiber mirror covers, with a High Gloss finish, provide a performance-inspired premium design update.

Union Jack Mirror Covers  
(not shown)  
VPLVB0249 – Color  
VPLVB0248 – Monochrome

Union Jack mirror covers accentuate the dynamic design of the exterior mirrors, adding a unique British style.



Carbon Fiber Side Vents  
VPLVB0112

High grade Carbon Fiber side power vents with a High Gloss finish provide a performance-inspired design upgrade.



Carbon Fiber Hood Vents\*  
VPLVB0113

Stunning high grade Carbon Fiber hood vents provide a performance-inspired design enhancement to accentuate the distinctive Range Rover Evoque profile.



Mudflaps

Front\*  
VPLVP0065 – SE, SE Premium and HSE

VPLVP0066 – Landmark Edition, HSE Dynamic and Autobiography

Mudflaps help to reduce spray and ensure paintwork is protected from debris and dirt. Designed to complement vehicle exterior design.



Rear\*\*

VPLVP0069 – SE, SE Premium and HSE

VPLVP0070 – Landmark Edition, HSE Dynamic and Autobiography



Rubber Mat Set

LR045097 – Five-door  
VPLVS0311 – Convertible

Rubber footwell mats help provide protection from general dirt.

Union Jack Style Rubber Mat Set  
(not shown)

VPLVS0306 – Five-door  
VPLVS0308 – Convertible

The Range Rover Evoque Union Jack rubber mats add a unique character to your vehicle and help protect the driver and passenger footwell carpet.



Rear Waterproof Seat Covers without Armrest\*

VPLVS0077PVJ – Ebony (Five-door)

Protect the seats from wet, dirty clothes as well as general wear and tear. Simple to fit and fully machine washable. Seat covers have been treated to meet automotive flammability standards.



Protective Rear Seat Cover

VPLVS0312

Protects both the rear seat bench and door linings from wet and dirt.



Sunshade\*

Side Windows  
VPLVS0322

Rear Tailgate (shown above)  
VPLVS0320

Easy to install or remove these sun blinds provide increased comfort helping to protect the interior from heat and glare of the sun.



Gearshift Paddles

VPLVS0187MMU – Aluminum  
VPLVS0187CAY – Red

Complete the look and feel of your steering wheel with premium aluminum paddles. Gearshift paddles are machine polished, anodized and hand brushed to provide exceptional wear resistance with a premium finish.







ABOVE & BEYOND

CONTENTS

SPECIFICATION

LOCATE A RETAILER

BUILD YOUR OWN

TECHNICAL DETAILS

DIMENSIONS AND CAPABILITIES

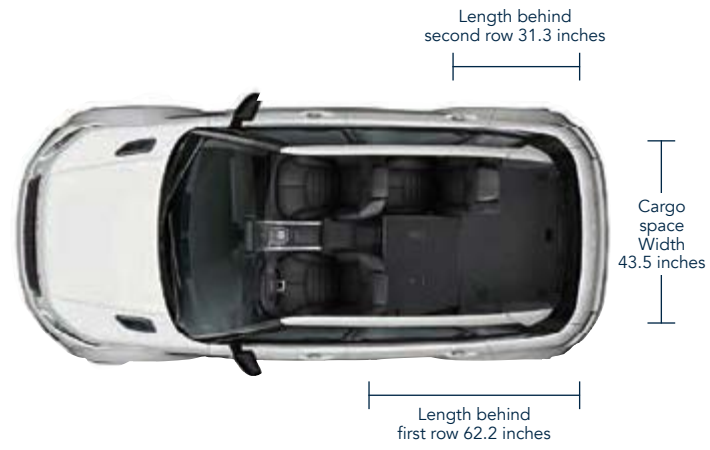

Standard Ride Height

With roof antenna 65.4 inches

Headroom

Maximum front headroom (without panoramic roof) 38.9 inches\*\*  
Maximum front headroom (with panoramic roof) 40.3 inches\*\*  
Rear headroom (without panoramic roof) 38.0 inches\*\*  
Rear headroom (with panoramic roof) 39.7 inches\*\*

Cargo Space Capacity

Rear seats upright  
Height 34.3 inches\*\* Width 43.5 inches  
Cargo space volume 20.3 cu.ft\*\*  
Cargo space width between arches 4 1.8 inches  
Rear seats down  
Cargo space volume 51 cu.ft\*\*  
Maximum box size (width x height) 35.5 inches x 24.6 inches\*\*

Obstacle Clearance

Standard ride height 8.3 inches

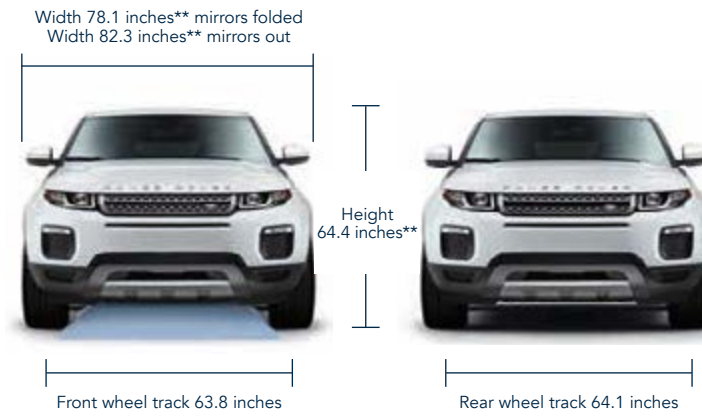

Front wheel track 63.8 inches

Rear wheel track 64.1 inches



	A	B	C
Ride Height	Standard/Dynamic		
Approach Angle	23.2°/17.8°*		
Ramp Angle		22°	
Departure Angle			33°/30°*



Wheelbase 104.7 inches



Overall length 172 inches



Standard Ride Height

With roof up 63.3 inches

Headroom

Maximum front headroom 38.4 inches  
Rear headroom 38 inches

Legroom

Maximum front legroom 43.1 inches  
Rear legroom 34.1 inches

Cargo Space Capacity

Rear seats upright  
Height 15.9 inches Width 43.5 inches  
Cargo space volume 8.9 cu.ft  
Maximum box size (width x height) 39.5 inches x 17.6 inches

Obstacle Clearance

Standard ride height 8.3 inches

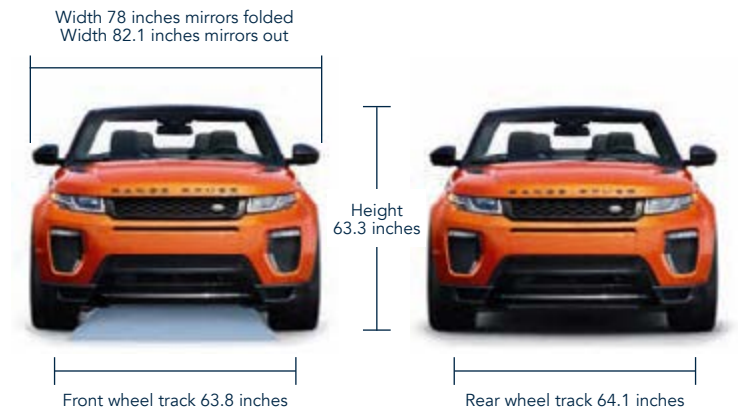

Front wheel track 63.8 inches

Rear wheel track 64.1 inches



	A	B	C
Ride Height	Standard		
Approach Angle	17.8°		
Ramp Angle		18.5°	
Departure Angle			31°



Wheelbase 104.7 inches

Turning Circle

Curb-to-curb 37.3ft  
Turns lock-to-lock 2.31

Wading Depth\*\*

Maximum wading depth 19.6 inches

\*With Dynamic body style \*\*These systems are not a substitute for driving safely with due care and attention and will not function under all circumstances, speeds, weather and road conditions, etc. Driver should not assume that these systems will correct errors of judgment in driving. Please consult the owner's manual or your local authorized Land Rover Retailer for more details.



ENGINE

MODEL AND OPTIONS

COLOR

INTERIOR

ACCESSORIES

TECHNICAL DETAILS





ABOVE & BEYOND

CONTENTS

SPECIFICATION

LOCATE A RETAILER

BUILD YOUR OWN

TECHNICAL DETAILS



### TECHNICAL SPECIFICATION, PERFORMANCE AND KEY DATA

	GAS	
	AUTOMATIC	AUTOMATIC
	2.0L Si4	2.0L Si4
<b>POWER (HP)</b>	<b>237</b>	<b>286*</b>
<b>ENGINE DATA</b>		
Bore (inches)	3.4	3.26
Stroke (inches)	3.63	3.63
Compression ratio (:1)	10.5	10.5
<b>BRAKES</b>		
Front type	Ventilated disc	Ventilated disc
Front diameter (inches)	12.79	13.74
Rear type	Solid disc	Solid disc
Rear diameter (inches)	12.48	12.48
Park brake	Electric Park Brake (EPB) integrated into brake caliper	
<b>WEIGHTS (lbs) (Five-door/Convertible)</b>		
Weight from	3,865 / 4,440	4,045
Maximum laden weight	5,180 / 5,310	5,180
Maximum mass on each axle (front)	51 / 51	51
Maximum mass on each axle (rear)	45 / 45.6	45.6
<b>TOWING (lbs) (Five-door/Convertible)</b>		
Unbraked trailer	1,653 / 1,653	1,653
Maximum towing	3,968 / 3,306	3,968
Maximum coupling point / nose weight	150 / 100	330
Maximum vehicle and trailer combination / Gross train weight	9,419 / 8,620	9,419
<b>ROOF CARRYING (lbs)*</b>		
Maximum roof load (including roof rails)	165	165
<b>PERFORMANCE (Five-door/Convertible)</b>		
Maximum speed (mph)**	135	144††
Acceleration (secs) 0-60 mph**	6.9 / 7.6	6.0
Fuel tank capacity – usable (gallons)	18.095 / 18.095	18.095



■ Standard – Not Available.  
 \*Not available on Convertible \*\*Always follow local speed limits †Not applicable to Convertible ††If vehicle fitted with 18" wheels the top speed will be 137 mph.  
 Vehicle shown left is Landmark Edition in Moraine Blue.

ENGINE

MODEL AND OPTIONS

COLOR

WHEELS

INTERIOR

ACCESSORIES

TECHNICAL DETAILS



ABOVE & BEYOND

CONTENTS

SPECIFICATION

LOCATE A RETAILER

BUILD YOUR OWN

## A WORLD OF LAND ROVER



### LAND ROVER EXPERIENCE

Ever since its inception, Land Rover has been ready for anything. Its legendary capability has seen it tackle the most demanding of terrains, in the most difficult conditions. Its versatile interior has become synonymous with comfort and greater cargo space. And its 'can do' attitude has made it the most welcome of vehicles across the globe.

You can be part of the Land Rover story at one of our Land Rover Experience Centers. You can see how each and every one of these iconic vehicles is built. You can take one out onto off-road tracks where your driving skills will be put to the test. Or you can go even further on one of our Adventure Travel holidays to such countries as Tanzania, Iceland or Morocco.

Adventure awaits.

For more information, visit [landroverusa.com](http://landroverusa.com)



### LAND ROVER ONELIFE

Onelife, the official Land Rover magazine, is published twice a year and reaches customers in 40 countries. Each issue is filled with the latest Land Rover news and vehicles, insights into the technology and design that shape each vehicle, inspirational journeys and opinions from international experts.



### LAND ROVER FINANCIAL SERVICES

Getting the keys to your own Land Rover has never been so simple. And it's more affordable than you might think. New or used, for personal or business use, we have an option that puts you in complete control. Please speak to your nearest Land Rover Retailer to find out more.

### FLEET & BUSINESS

Land Rover is dedicated to being the premium manufacturer of choice for fleets and businesses, by providing a highly attractive range of vehicles and exemplary customer service.

Distinctive, capable and versatile, all Land Rover vehicles deliver low total cost of ownership through strong residual values, competitive service, maintenance and repair costs.

We are also committed to providing a totally customer-focused aftersales service, which will ensure every Land Rover vehicle is kept on the road and in top condition, in the easiest and most cost-efficient way for businesses.

For more information, visit [landroverusa.com](http://landroverusa.com)



### LAND ROVER COLLECTION

The vehicle is just the beginning. The latest Land Rover Collection is now available for you to discover.

A meticulous attention to detail doesn't stop with our vehicles. You'll find the same level of craftsmanship in all of our clothing, travel items and premium gift ideas. So whether you're shopping for yourself or a loved one, you know the quality is assured.

The Land Rover Collection includes ladies and mens clothing, an extensive range of small leather goods such as wallets, portfolios, iPad and iPhone cases along with briefcases and weekender bags. A range of cufflinks and ladies silk scarves add a luxury feel to the collection. There's a kids collection too, with colorful fun clothing, caps and replica model vehicles for them to enjoy.

Visit [shop.landroverusa.com](http://shop.landroverusa.com) to browse the latest Land Rover Collection.



### ROADSIDE ASSISTANCE

Land Rover Roadside Assistance provides assistance in motoring emergencies, from immobilization due to breakdown or accident to minor problems such as punctures. You can rely on our roadside assistance, whatever the situation, anywhere in North America during the vehicle warranty period.

For further details please consult your Warranty Benefits handbook, contact your nearest Land Rover Approved Service Center or visit [landroverusa.com](http://landroverusa.com)

**IMPORTANT NOTICE:** Jaguar Land Rover Limited is constantly seeking ways to improve the specification, design and production of its vehicles and alterations take place continually. While every effort is made to produce up to date literature, this brochure should not be regarded as an infallible guide to current specifications, nor does it constitute an offer for the sale of any particular vehicle. Distributors and Retailers are not agents of Jaguar Land Rover Limited by any express or implied undertaking or representation.

All Land Rover Approved Accessories fitted by a Land Rover Retailer within one month or 1,000 miles (whichever occurs first) of the handover of a new registered vehicle will benefit from the same warranty terms and period of cover as the vehicle warranty. Accessories purchased outside of these parameters will be subject to a 12 month unlimited mileage warranty. All Land Rover Approved Accessories are rigorously tested to the same exacting standards as those applied to our vehicles. Performance in extreme hot and cold temperatures, corrosion resistance, impact and airbag deployment highlight some of the exhaustive product testing carried out to ensure accessories are both durable and importantly, continue to comply with current legislation. Some of the accessories featured are not available on all models. Please consult your nearest Land Rover Retailer for more information.

All our accessories are designed to be an integral part of Land Rover vehicles. While many items such as roof carriers are simple to fit, some products require specialist tools and diagnostic equipment to ensure correct integration with the vehicle structure and electrical systems. These products vary from market to market, please consult your Land Rover Retailer who will be pleased to advise you on current specifications and any questions you may have.

The colors reproduced here are subject to the limitations of the printing process and may therefore vary slightly from the actual vehicle. The company reserves the right to alter or withdraw any color finish without notice. Some of these colors may not be obtainable in your country. Please check availability of colors and current specifications with your Land Rover Retailer. Distributors and retailers are not agents of Jaguar Land Rover Limited and have absolutely no authority to bind Jaguar Land Rover Limited to any express or implied undertaking or representation.

Castrol EDGE Professional recommended by Land Rover.

Vehicle shown on front and back covers: 2018 Range Rover Evoque Landmark Edition Five-door in.

**Jaguar Land Rover North America, LLC**  
555 MacArthur Boulevard  
Mahwah, NJ 07430-2327

1-800-FIND-4WD

[landroverusa.com](http://landroverusa.com)

© 2017 Jaguar Land Rover North America, LLC  
1L5381810CC0BUSEN01P







ABOVE & BEYOND

